



LEICA M11-P

Instruction manual



FOREWORD

Dear Customer,

We wish you a great deal of fun and success taking photographs with your new Leica M11-P. Please read this manual thoroughly to familiarize yourself with the full scope of functions your camera has to offer. You can find all information about the Leica M11-P whenever you need it at <https://leica-camera.com>.

Your Leica Camera AG

SCOPE OF DELIVERY

Before using your camera for the first time, please check that the accessories supplied are complete*.

- Leica M11-P
- Camera bayonet cover
- Lithium-ion rechargeable battery Leica BP-SCL7
- Charger Leica BC-SCL7, incl. power adapter and USB cable
- Carry strap
- CE flyer
- Drawstring pouch for battery, charger and cables
- Quick Start Guide
- Test certificate
- Registration card
- Rechargeable battery flyer

* Subject to change with regard to construction and appearance.

REPLACEMENT PARTS / ACCESSORIES

Please contact Leica Customer Care or visit the Leica Camera AG website for information on the extensive range of Leica replacement parts/accessories:

<https://leica-camera.com/en-US/photography/accessories>

Only the accessories specified and described in this manual or by Leica Camera AG must be used with the camera (battery, charger, mains plug, mains cable, etc.). These accessories must only be used with this product. Third-party accessories may result in malfunctions or damage to the product.

Important

All mentions of “EVF” or “Electronic Viewfinder” in this manual refer to the optional accessory Leica Visoflex **2**.

Using the older “Leica Visoflex” model with the Leica M11-P can – as a worst case scenario – result in irreparable damage to the camera and/or the Visoflex. Please contact Leica Customer Care if in doubt.

Please read the chapters “Legal information”, “Safety remarks”, and “General information” before using your camera for the first time. Knowledge of the content will prevent inadvertent damage to the product, possible injuries and other risks.



LEGAL INFORMATION

COPYRIGHT NOTICE

- Compliance with copyright laws is mandatory. The recording and publication of pre-recorded media like tapes, CDs, or other published or broadcast material may breach copyright laws. The same applies for all software supplied as part of the scope of delivery.
- The designations SD, SDHC, SDXC, microSDHC and their associated logos are registered trademarks of SD-3C, LLC.

DISCLAIMER

“Content credentials” allow the tracing of image content and changes thereto. Leica Camera AG assumes no liability with regard to tamper safety or misuse, and offers no warranty for the use of the “Content credentials” for a specific purpose.

LEGAL INFORMATION ABOUT THIS MANUAL

COPYRIGHT

All rights reserved.

All text, images and graphics are subject to copyright and other laws to protect intellectual property. They must not be copied, modified or used for any purpose including trade purposes.

TECHNICAL DATA

Product changes with regards to the product or services may have occurred after the editorial deadline. The manufacturer reserves the right to effect structural or shape changes, color deviations and changes to the scope of delivery or service, where these changes or deviations are reasonably acceptable for the customer, while taking into consideration the interests of Leica Camera AG. To that extent, Leica Camera AG reserves the right to changes and errors. The images in this manual may depict accessory, special features or other items that are not part of the standard scope of delivery or service. Some pages may contain model types and services, which are not offered in specific countries.

BRANDS AND LOGOS

The brand names and logos used in this document are protected trademarks. These brands or logos must not be used without prior approval by Leica Camera AG.

LICENSE RIGHTS

Leica Camera AG intends to provide you with innovative and informative documentation. Due to the amount of creativity that has gone into its design, we ask for your understanding that Leica Camera AG must protect its intellectual property, including patents, trademarks and copyrights, and that possession of the documentation does not infer any licensing rights of the intellectual property of Leica Camera AG.

REGULATORY INFORMATION

You will find the manufacturing date of your camera on the stickers in the Warranty Card and/or on the packaging.

The date format is year/month/day.

COUNTRY-SPECIFIC LICENSES

Specific regional approvals for this device can be found in the camera menu.

- ▶ Select **Camera Information** in the main menu
- ▶ Select **Regulatory Information**

LICENSE INFORMATION

The device-specific license information can be found in the camera menu.

- ▶ Select **Camera Information** in the main menu
- ▶ Select **License Information**



CE MARK

The CE mark on our products documents compliance with the fundamental requirements of applicable EU guidelines.

English

Declaration of Conformity (DoC)

"Leica Camera AG" hereby declares that this product is in compliance with the basic requirements and other relevant provisions of Directive 2014/53/EU.

Customers can download a copy of the original DoC for our Radio Equipment products from our DoC server:

www.cert.leica-camera.com

Please contact Leica Camera AG, Am Leitz-Park 5, 35578 Wetzlar, Germany in case of any further questions

Depending on product (see technical data)

Type	Frequency band (center frequency)	Maximum output (dBm E.I.R.P.)
WLAN	2412-2462/5180-5240 MHz/ 5260-5320/5500-5700 MHz 5735-5825 MHz	20
Bluetooth® Wireless Technology	2402-2480 MHz	20

DISPOSAL OF ELECTRICAL AND ELECTRONIC EQUIPMENT

(Applies within the EU and for other European countries with active waste separation policies.)



This device contains electrical and/or electronic components which must not be disposed of in general household waste. Instead, it should be disposed of at a recycling collection point provided by your local authority.

This service is free of charge. Any standard or rechargeable batteries used in this device must be removed and disposed of separately in accordance with local regulations.

Please contact your local authorities, waste disposal collection point or the retailer, from whom you purchased the device for more information on correct waste disposal.

IMPORTANT NOTES REGARDING THE USE OF WLAN/BLUETOOTH®

- Appropriate measures must be taken to ensure security and protect against disruptions to the systems in place where devices or computer systems are in use that require more stringent security than WLAN devices.
- Leica Camera AG shall not accept liability for damages arising from the use of the camera for purposes other than as a WLAN device.
- It is assumed that the WLAN function will be used in countries where this camera is sold. There may be a risk of breaching statutory wireless communication regulations when using the camera in other countries. Leica Camera AG shall not accept liability for such breaches.
- Please note that there is a risk of unauthorized third party interception of wirelessly communicated data. We highly recommend that you activate encryption in the wireless access point settings to ensure data safety.
- Avoid using the camera in areas where it can be exposed to magnetic fields, static electricity or other interferences, e.g. near a microwave oven. RF transmissions may otherwise not reach the camera.
- Using the camera near devices like microwave ovens or wireless phones that use the 2.4 GHz RF band may negatively affect the performance of both devices.
- Do not attempt to connect to wireless networks you are not authorized to use.
- The device will automatically search for wireless networks, once the WLAN function is enabled. A list, including networks you are not authorized to access, will be displayed (SSID: Network identifier for a WLAN network). Do not attempt to connect to third party network, as this could be construed as unauthorized access.

- We recommend disabling the WLAN function while on an aircraft.
- The use of the WLAN-RF band between 5150 MHz and 5350 MHz is permitted only in enclosed spaces.
- Please read the important notes on specific functions of Leica FOTOS on p. 150.

IMPORTANT NOTES REGARDING THE USE OF “LEICA FOTOS CABLE”

- The use of the “Made for Apple” icon signifies that an accessory part was developed specifically for a connection to the Apple product(s) named in the icon, and was certified by the developer to comply with Apple performance standards. Apple bears no responsibility for the operation of that device or its compliance with safety and regulatory standards.
- Please note that the use of this accessory with an Apple product may impede RF performance.



SAFETY REMARKS

GENERAL INFORMATION

- Do not use your camera in the immediate vicinity of devices that generate powerful magnetic, electrostatic or electromagnetic fields (e.g. induction ovens, microwave ovens, television sets or computer screens, video game consoles, cell phones, broadcasting equipment). Their electromagnetic fields can interfere with image capturing.
- Strong magnetic fields, e.g. from speakers or large electric motors can damage the stored data or disrupt shooting.
- Switch off the camera, remove the battery briefly, replace it and switch the camera back on in case of a camera malfunction due to the effects of electromagnetic fields.
- Do not use the camera in the immediate vicinity of radio transmitters or high-voltage power lines. Their electromagnetic fields may also interfere with image capturing.
- Always store small parts e.g. the accessory shoe cover as follows:
 - out of the reach of children
 - in a safe location, where they will not get lost or stolen
- State-of-the-art electronic components are sensitive to static discharge. You can easily pick up charges of several 10,000 volts by simply walking on synthetic floor coverings. A static discharge can occur when you touch the camera and especially if it is placed on a conductive surface. A static discharge on the camera housing poses no risk for the electronics. Despite built-in safety circuits, you should avoid direct contact with external camera contacts like those in the flash shoe.
- Take care not to soil or scratch the sensor for lens detection in the bayonet. You must similarly prevent direct contact of the bayonet with grains of sand or similar particles, as these could cause irre-

parable damage. This component must only be cleaned with a dry cloth (in system cameras).

- Use a cotton or linen cloth instead of a microfiber cloth from an optician's (synthetic) when cleaning the contacts. Make sure to discharge any electrostatic charge by deliberately touching a heating or water pipe (conductive, grounded material). Dirt deposits and oxidation on the contacts can be avoided by storing your camera in a dry location with the lens cap and the flash shoe/viewfinder cap (in system cameras) attached.
- Only use accessories specified for this model to prevent faults, short circuits or electric shock.
- Do not attempt to remove parts of the housing (covers) yourself. Repairs must be done at authorized service centers only.
- Protect the camera against contact with insect sprays and other aggressive chemicals. Petroleum spirit, thinner and alcohol must not be used for cleaning. Some chemicals and liquids can damage the camera housing or the surface finish.
- Rubber and plastics are known to expel aggressive chemicals and should therefore not be kept in contact with the camera for extended periods of time.
- Prevent any sand or dust or water penetration into the camera, e.g. during snowfall or rain or on the beach. Be extra careful when changing the lens (in system cameras) and when inserting or removing the memory card and rechargeable battery. Sand and dust can damage the camera, the lens, the memory card and the battery. Moisture can cause malfunctions and irreparable damage to the camera and memory card.

LENS

- A camera lens can have the effect of a magnifying glass when exposed to direct frontal sunlight. The camera must therefore be protected against extended exposure to direct sunlight.

- Attaching the lens cap and keeping the camera in the shade or ideally in its camera case, will help prevent damage to the interior of the camera.

RECHARGEABLE BATTERY

- Improper use of the batteries or the use of unapproved battery types may result in an explosion!
- Do not expose the rechargeable battery to sunlight, heat, humidity or moisture for prolonged periods of time. Likewise, the batteries must not be placed in a microwave oven or a high-pressure container as this would pose a fire or explosion hazard!
- Do not under any circumstances charge or insert a damp or wet battery into the camera!
- A safety valve in the battery ensures that any excess pressure caused by improper handling is discharged safely. It is nevertheless important to dispose of a bloated battery immediately. It may pose an explosion hazard!
- Keep the battery contacts clean and easily accessible. Although lithium-ion batteries are secured against short circuits, they should still be protected against contact with metal objects like paper clips or jewelry. A short-circuited battery can get very hot and cause severe burns.
- When a battery is accidentally dropped, make sure to check the housing and the contacts immediately for any damage. A damaged battery can damage the camera.
- The battery must be removed from the camera or charger and must be replaced immediately in case of a strange smell, discoloration, deformation, overheating or leakage. Continued use of the battery may result in overheating, which can cause fire and/or explosion!
- Never throw batteries into a fire as they may explode.

- Keep the battery away from sources of heat in case of leakage or if you smell burning. Leaked fluid can catch fire!
- The use of other chargers not approved by Leica Camera AG can cause damage to the batteries – and in extreme cases – cause serious or life-threatening injuries.
- Make sure that the power socket is freely accessible at all times.
- Do not attempt to open the battery or the charger. Repairs must only be carried out by authorized workshops.
- Keep batteries out of the reach of children. Batteries can cause suffocation when swallowed.

FIRST AID

- Battery fluid may cause blindness if it comes into contact with the eyes. Rinse the eyes thoroughly with clean water immediately. Avoid rubbing. Seek medical attention immediately.
- Leaked battery fluid poses an injury hazard when it comes in contact with clothing or skin. Rinse the affected areas thoroughly with clean water.

CHARGER

- Using the charger in the vicinity of broadcasting receivers may interfere with reception. Ensure a distance of at least 1 m between the charger and the receiver.
- When the charger is in use, it may emit a buzzing sound – that is normal and not a malfunction.
- Disconnect the charger from the mains when it is not in use, as it consumes electricity (a very small amount), even if no battery is inserted.
- Always keep the charger contacts clean, and never short-circuit them.

MEMORY CARD

- Never remove the memory card during a data save or card reading process. The camera must not be switched off or be subjected to impact or vibrations while working.
- Do not open the cover/remove the memory card or the battery from the camera while the status LED is lit, which indicates memory access. Data on the card may otherwise be destroyed and camera malfunctions may occur.
- Do not drop or bend memory cards as this will cause damage and result in the loss of stored data.
- Do not touch the connections on the reverse of the memory card and keep them clean and dry.
- Keep memory cards out of the reach of children. Swallowing a memory card may cause suffocation.

SENSOR

- Cosmic radiation (e.g. during flights) may cause pixel defects.

CARRY STRAP

- Carry straps are usually made of very robust material. You should therefore keep it out of the reach of children. A carry strap is not a toy and poses a strangulation risk.
- Use the carry strap only for its intended purpose on a camera or on binoculars. Any other use poses the risk of injury and may possibly result in damage to the carry strap and is therefore not permitted.
- Carry straps should also not be used for cameras/binoculars during sports activities that pose a risk of entanglement (e.g. when mountain climbing and similar outdoor activities).

TRIPOD

- When using a tripod, make sure it is standing securely and turn the camera only by turning the tripod, not the actual camera. Ensure that the tripod screw is hand-tightened only. Avoid transporting the camera while the tripod is attached. You might injure yourself or others and the camera could get damaged.

FLASH

- The use of incompatible flash units with your Leica M11-P may result in irreparable damage to the camera and/or the flash unit.

GENERAL INFORMATION

Please read the section about “Care/Storage” for more information about what to do in case of problems.

CAMERA/LENS

- Make a note of the serial numbers of your camera and lenses, as this information will be extremely important in case of loss.
- Depending on model, you will find the serial number of your camera on the flash shoe or engraved in the underside of the camera.
- Make sure to always have a lens or the camera bayonet cover attached to prevent dust or other foreign bodies penetrating the camera.
- That is why you should always replace lenses quickly and in a dust-free environment.
- Never store the camera bayonet cover or the lens back cover in a pants pocket, as they will attract lint and dust, which could then be accidentally introduced into the camera.

LCD PANEL

- Condensation may form on the LCD panel if the camera is exposed to great temperature fluctuations. Wipe the screen carefully with a soft, dry cloth.
- The screen image will initially be slightly darker than normal if the camera is very cold when it is switched on. The normal level of brightness will be reached as soon as the LCD panel warms up.

RECHARGEABLE BATTERY

- The rechargeable battery must only be charged within a specific temperature range. See chapter “Technical Data” (p. 180) for details about operating conditions.

- Lithium-ion batteries can be charged at any time, regardless of their current charge level. A partially charged battery will charge to full capacity faster than a fully discharged one.
- The rechargeable batteries come only partly charged ex works and should therefore be charged fully before their first use.
- A new battery only reaches its full capacity after it has been fully charged and – by using it in the camera – depleted 2 to 3 times. This depletion process should be repeated roughly every 25 cycles.
- Battery and charger heat up during the charging process. That is normal and not a malfunction.
- Rapid flashing of the two LEDs (> 2 Hz) when charging commences indicates a charging error (e.g. maximum charging time exceeded, voltages or temperatures outside permitted ranges or a short circuit). Disconnect the charger from the mains and remove the battery. Ensure that the above temperature conditions are met and then restart the charging process. Please contact your dealer, the Leica representative in your region or Leica Camera AG if the problem persists.
- Rechargeable lithium-ion batteries generate power by way of internal chemical reactions. These reactions are influenced by ambient temperature and humidity. Do not expose the battery to extreme temperatures (high or low) for extended periods of time (e.g. in a parked car in the summer or winter) to ensure a maximum service life.
- The replaceable battery supplies power to a backup battery, which is permanently installed in the camera. This backup battery retains the date and time for some weeks. Once the backup battery is depleted, it must be replenished by inserting a charged main battery. The time and date will have to be set again after a full depletion of both batteries.

- As the battery capacity deteriorates or if using an older battery, warning messages may appear and some functions may be restricted or blocked entirely.
- Always remove the battery if the camera will not be used for an extended period of time. Make sure to switch the camera off via the main switch before removing the battery. Leaving the battery in the camera will result in a deep discharge after a few weeks. Voltage levels will decrease significantly, as the camera uses a low idle current to maintain settings.
- Dispose of damaged batteries in accordance with the relevant regulations at an approved collection point for proper recycling.
- The date of manufacture can be found on the battery. The date format is week/year.

MEMORY CARD

- The range of available SD/SDHC/SDXC cards on the market is too extensive for Leica Camera AG to test for compatibility and quality. Generally, any type of memory card may be used without any damage to the camera or memory card. As some “no name” cards may not fully comply with the SD/SDHC/SDXC standards, Leica Camera AG cannot provide any guarantee of function.
- We recommend formatting the memory card from time to time, as fragmented residual data from deleted files may block some of the storage capacity.
- Generally, it is not necessary to format (initialize) memory cards that have been previously used. Formatting will, however, be necessary if you insert an unformatted memory card or a card that was formatted in another device (e.g. a computer) for the first time.
- We recommend backing up your data on a PC, because electromagnetic fields, static electricity and any damage to the memory card or camera defects may result in irretrievable damage or loss of your data.

- SD, SDHC, and SDXC memory cards come with a write protection slider to prevent accidental overwriting. This slider is located on the non-beveled side of the card. All data on the card is protected when the slider is set to its lower position, marked LOCK.
- All data stored on the memory card will be lost during formatting. Formatting will not be prevented by a deletion protection set for individual shots.

SENSOR

- Any dust or dirt particles stuck to the glass cover of the sensor may result in noticeable dark stains or specks on the images (in system cameras). Alternatively, send your camera to the Leica Customer Care department for sensor cleaning (see p. 186). This service is not part of the warranty offering and will therefore incur charges.

DATA

- All data, including personal information, may be changed or deleted due to incorrect or accidental operation, static discharge, accidents, malfunctions, repairs and other measures.
- Please note that Leica Camera AG does NOT accept liability for direct or consequential damage due to the manipulation or destruction of data and personal information.



FIRMWARE UPDATE

Leica is continuously working on the further improvement and optimization of Leica M11-P. As digital cameras have many functions that are controlled electronically, improvements and enhancements to the functions can be installed on the camera at a later date. Leica releases so-called firmware updates at irregular intervals. Cameras are always supplied ex works with the latest firmware installed or you can download the latest version from our website yourself and transfer it to your camera.

You will receive a newsletter informing you of the availability of a new firmware update if you register your camera on the Leica Camera homepage.

Visit the download section or the “Customer Area” for information about how to register or how to get firmware updates for your Leica M11-P. Additionally, you can find information about changes or additions to the manual at: <https://club.leica-camera.com>

TERMS OF GUARANTEE OF LEICA CAMERA AG

Dear Leica Customer,
congratulations on the purchase of your new Leica product – you are now the proud owner of a world-class brand product.
In addition to your statutory warranty claims against your seller, we, Leica Camera AG ("LEICA"), grant you voluntary warranty services for your Leica product in accordance with the following stipulations ("Leica Warranty"). The Leica warranty therefore does not limit your statutory rights as a consumer under applicable law or your rights as a consumer against the dealer with whom you have concluded the purchase contract.

THE LEICA-GUARANTEE

You have purchased a Leica product that has been manufactured according to special quality guidelines and tested by experienced specialists during the various stages of production. We provide the following Leica Warranty, valid as of April 1, 2023, for this Leica product and including the accessory parts in the original packaging. Please note that we do not offer any warranty for commercial use. We offer an extended warranty for some Leica products, provided you register for a Leica account. Please visit www.leica-camera.com for more details.

SCOPE OF THE LEICA-GUARANTEE

During the warranty period, complaints based on manufacturing and material defects will be remedied free of charge, at LEICA's discretion, by way of repair, replacement of defective parts, or exchange for a similar Leica product in perfect condition. Replaced parts or products become the property of LEICA. Further claims of any kind and on any legal grounds whatsoever in connection with this Leica Warranty are excluded.

EXCLUDED FROM THE LEICA WARRANTY

Parts subject to wear and tear (e.g. eyecups, leather coverings, carry straps, armoring, batteries), and parts under mechanical stress are excluded from the Leica Warranty, unless the defect was caused by manufacturing or material defects. That also applies to any exterior damage.

LAPSE OF CLAIMS UNDER THE LEICA-GUARANTEE

Claims under the warranty are void if the defect in question is due to improper handling; they may also be void if e.g. third-party accessories have been used, the Leica product has not been opened professionally or has not been repaired professionally. Claims for warranty services shall similarly be void if the serial number is unrecognizable.

ASSERTION OF THE LEICA-GUARANTEE

We require a copy of the proof of purchase of your Leica product from a LEICA-authorized dealer ("Authorized Leica Dealer") before we can accept any claim under the warranty. The purchase receipt must show the date of purchase, the Leica product with its article number and serial number, and details about the Authorized Leica Dealer. We reserve the right to request the original receipt. Alternatively, you may send us a copy of the warranty card; please note that the Warranty Card must be filled out correctly, and the product must have been purchased from an Authorized Leica Dealer. Please send your Leica product with a copy of your purchase receipt or the Warranty Card alongside a description of the issue.

Leica Camera AG, Customer Care, Am Leitz-Park 5, 35578 Wetzlar, Germany
Email: customer.care@leica-camera.com, phone: +49(0)6441 2080-189
or to an Authorized Leica Dealer.

Leica Product Image	Warranty Term
all products	2 years

TABLE OF CONTENTS

FOREWORD.....	2
SCOPE OF DELIVERY	2
REPLACEMENT PARTS / ACCESSORIES	3
LEGAL INFORMATION.....	4
SAFETY REMARKS	8
GENERAL INFORMATION	12
TERMS OF GUARANTEE OF LEICA CAMERA AG.....	15
TABLE OF CONTENTS	16
PART DESIGNATIONS	20
DISPLAYS	24
VIEWFINDER	24
LCD PANEL	25
CHARGE STATUS INDICATOR ON THE LCD PANEL	27
PREPARATION	28
ATTACHING THE CARRY STRAP.....	28
PREPARING THE CHARGER.....	28
CHARGING THE BATTERY.....	29
CHARGING VIA USB	30
INSERTING/REMOVING THE BATTERY.....	30
INSERTING/REMOVING THE MEMORY CARD	31
LENS.....	33
COMPATIBLE LENSES.....	33
LENSES WITH LIMITED COMPATIBILITY.....	34
INCOMPATIBLE LENSES.....	34
CHANGING THE LENS	35

LENS DETECTION	38
USING A LEICA M LENS <u>WITH</u> 6-BIT ENCODING	38
USING A LEICA M LENS <u>WITHOUT</u> 6-BIT ENCODING	38
USING A LEICA R LENS	39
DISABLING LENS DETECTION.....	39
DIOPTRER COMPENSATION	40
CAMERA OPERATION	42
CONTROL ELEMENTS	42
MAIN SWITCH	42
SHUTTER BUTTON.....	43
SHUTTER-SPEED DIAL	44
ISO DIAL	44
THUMBWHEEL	45
DIRECTIONAL PAD/CENTER BUTTON.....	45
PLAY BUTTON/MENU BUTTON.....	46
LCD PANEL	46
FUNCTION BUTTONS	47
LCD PANEL (TOUCH SCREEN)	48
MENU CONTROL.....	49
CONTROL ELEMENTS.....	49
MENU SECTIONS	49
STATUS SCREEN	51
MAIN MENU	53
MENU NAVIGATION	54
SUBMENU	56
KEYBOARD/NUMBER PAD.....	56
MENU BAR.....	57
SCALE MENU	57
DATE/TIME MENU.....	58
COMBI MENU	58
USER-DEFINED OPERATION	59
FAVORITES MENU.....	59
MANAGING THE FAVORITES MENU	59

DIRECT ACCESS TO MENU FUNCTIONS.....	60	FILM STYLE	75
CHANGING AN ASSIGNMENT.....	60	IMAGE PROPERTIES.....	75
ACCESSING THE ASSIGNED MENU FUNCTION.....	60	EXTENDED DYNAMIC RANGE.....	75
THUMBWHEEL ASSIGNMENT.....	61	COLOR PROFILE.....	76
USER PROFILES	61	MONOCHROME PROFILE.....	76
CAMERA BASIC SETTINGS.....	64	CUSTOMIZING PHOTO PROFILES.....	76
MENU LANGUAGE	64	AUTOMATIC OPTIMIZATION	77
DATE/TIME	64	NOISE REDUCTION.....	77
RECEIVING THE SETTINGS FROM A MOBILE DEVICE.....	64	NOISE REDUCTION FUNCTION FOR LONG-TERM EXPOSURE.....	77
MANUAL SETTINGS.....	64	NOISE REDUCTION IN JPG IMAGES.....	78
POWER SAVE MODE (STANDBY MODE).....	65	DATA MANAGEMENT.....	78
CAMERA STANDBY	65	STORAGE OPTIONS	78
DISPLAY STANDBY	65	FILE BACKUP.....	79
STATUS LED.....	66	FORMATTING STORAGE LOCATIONS.....	80
BOTTOM LED.....	66	DATA STRUCTURE.....	81
LCD PANEL/VIEWFINDER SETTINGS	67	EDIT FILE NAMES.....	81
BRIGHTNESS.....	67	CREATING A NEW FOLDER.....	82
RANGEFINDER.....	67	CONTENT CREDENTIALS	82
LCD PANEL.....	67	RECORDING THE SHOOTING LOCATION WITH GPS.....	83
LEICA VISOFLEX 2 (EVF).....	68	DATA TRANSFER.....	83
LCD PANEL/EVF USE.....	68	PRACTICAL DEFAULT SETTINGS.....	84
EYE SENSOR SENSITIVITY	69	AUXILIARY DISPLAYS.....	84
BRIGHTNESS.....	69	INFO PROFILES	84
STILL IMAGE SETTINGS.....	70	CHANGING THE INFO PROFILES.....	85
FILE FORMAT.....	70	CUSTOMIZING THE INFO PROFILES	86
RESOLUTION.....	71	SHOW AVAILABLE	86
DNG RESOLUTION.....	71	INFO BARS	86
JPG RESOLUTION.....	71	GRID.....	86
EFFECT OF OTHER SETTINGS ON THE JPG RESOLUTION.....	72	CLIPPING.....	87
DIGITAL ZOOM	73	FOCUS PEAKING.....	87
		LEVEL GAUGE.....	88
		HISTOGRAM.....	89



PHOTOGRAPHY	90	EXPOSURE COMPENSATION	115
DRIVE MODE	90	SHOOTING MODES	116
SHOOTING TYPES	91	CONTINUOUS SHOOTING	116
USING THE RANGEFINDER	91	INTERVAL SHOOTING	117
IMAGE FIELD (BRIGHT-LINE FRAME)	91	EXPOSURE BRACKETING	119
LIVE VIEW MODE	93	SELF-TIMER	120
AUXILIARY DISPLAYS IN LIVE VIEW MODE	93	SPECIAL SHOOTING MODES	121
FOCUSING	95	PERSPECTIVE CONTROL	121
VIA RANGEFINDER	95	ACTIVE PERSPECTIVE CONTROL	122
DOUBLE-IMAGE METHOD	95	DETECTED PERSPECTIVE IN LIVE VIEW MODE	122
SPLIT-IMAGE METHOD	95	CORRECTED PERSPECTIVE IN REVIEW MODE	122
IN LIVE VIEW MODE	96	JPG FORMAT IMAGES	123
FOCUS PEAKING	96	DNG FORMAT IMAGES	123
ENLARGEMENT	97	PERSPECTIVE CONTROL IN ADOBE LIGHTROOM® AND ADOBE PHOTOSHOP® ...	123
ISO SENSITIVITY	99	FLASH PHOTOGRAPHY	124
FIXED ISO VALUES	99	COMPATIBLE FLASH UNITS	124
AUTOMATIC SETTING	100	FLASH EXPOSURE METERING (TTL METERING)	125
LIMITING SETTING RANGES	100	SETTINGS ON THE FLASH UNIT	126
WHITE BALANCE	101	HSS (HIGH SPEED SYNC.)	126
AUTOMATIC CONTROL/FIXED SETTINGS	102	FLASH CONTROL	127
MANUAL SETTING VIA METERING	102	SYNC POINT	127
DIRECT SETTING OF THE COLOR TEMPERATURE	103	FLASH RANGE	128
EXPOSURE	104	FLASH EXPOSURE COMPENSATION	128
SHUTTER TYPE	104	REVIEW MODE	132
EXPOSURE MODES	107	CONTROL ELEMENTS IN REVIEW MODE	132
APERTURE-PRIORITY MODE- A	107	STARTING/EXITING REVIEW MODE	134
MANUAL EXPOSURE SETTING - M	108	SELECTING/SCROLLING THROUGH IMAGES	134
AUXILIARY EXPOSURE DISPLAYS	109	STORAGE LOCATIONS	135
LONG-TERM EXPOSURE (B)	110	INFO DISPLAYS IN REVIEW MODE	135
SELECTABLE SHUTTER SPEEDS	112	CROPPED SECTION ZOOM	136
NOISE REDUCTION	113	DISPLAYING MULTIPLE IMAGES AT ONCE	138
EXPOSURE CONTROL	114	TAGGING/RATING OF IMAGES	139
EXPOSURE PREVIEW	114		
EXPOSURE LOCK	115		

DELETING IMAGES	141
DELETING MULTIPLE IMAGES	142
PREVIEW OF LATEST IMAGE	144
OTHER FUNCTIONS	146
RESETTING THE CAMERA TO FACTORY SETTINGS.....	146
FIRMWARE UPDATES	146
LEICA FOTOS	150
SELECTING A WI-FI BAND	150
CONNECTIVITY (iPhone users)	151
FIRST-TIME CONNECTION TO A MOBILE DEVICE.....	151
CONNECTING WITH PAIRED DEVICES.....	153
CONNECTIVITY (Android users)	154
FIRST-TIME CONNECTION TO A MOBILE DEVICE.....	154
CONNECTING WITH PAIRED DEVICES.....	155
CONNECTIVITY MODES.....	156
PERFORMANCE MODE.....	157
ECO MODE.....	157
AIRPLANE MODE	157
EXECUTING A FIRMWARE UPDATE	157
REMOTE CAMERA CONTROL	158
CARE/STORAGE	159
SENSOR	161
SENSOR CLEANING.....	161
FAQ	163
MENU OVERVIEW	169
INDEX	173
TECHNICAL DATA	179
LEICA CUSTOMER CARE.....	185
LEICA AKADEMIE	186

Definition of the various categories of information found in this manual

Note

Additional information

Important

Failure to comply with instructions may result in damage to the camera, the accessories or the data files

Attention

Non-compliance may result in personal injury

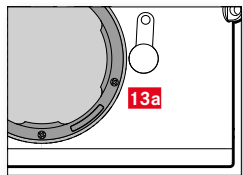
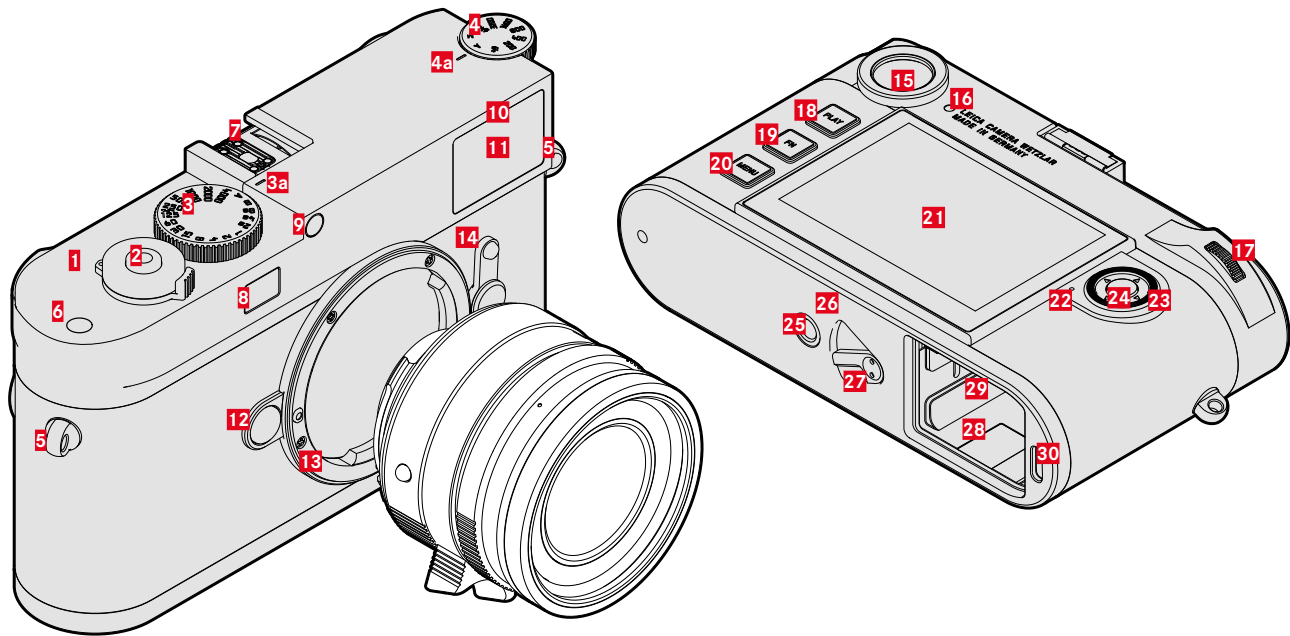

LEICA M11-P

- 1** Main switch
- 2** Shutter button
- 3** Shutter-speed dial with stop positions
- a** Alignment point for shutter-speed dial
- 4** ISO dial
- a** Index for ISO dial
- 5** Strap lugs
- 6** Function button
- 7** Accessory shoe
- 8** Rangefinder window
- 9** Brightness sensor*
- 10** Self-timer LED
- 11** Viewfinder window
- 12** Lens release button
- 13** Leica M bayonet
- a** 6-bit encoding
(sensor for lens detection)
- 14** Frame selector lever
- 15** Viewfinder eyepiece
- 16** Brightness sensor for LCD panel
- 17** Thumbwheel
- 18** **PLAY** button
- 19** **FN** button
- 20** **MENU** button
- 21** LCD panel
- 22** Status LED

* Leica M lenses with viewfinder attachment cover the brightness sensor. Please read the sections “Displays (viewfinder)” and “Leica M lenses” for more information about how to work with these and other lenses.

- 23** Directional pad
- 24** Center button
- 25** Tripod thread A ¼, DIN 4503 (¼”)
- 26** LED
- 27** Battery release lever
- 28** Battery compartment
- 29** Memory card slot
- 30** USB-C socket



LENS*

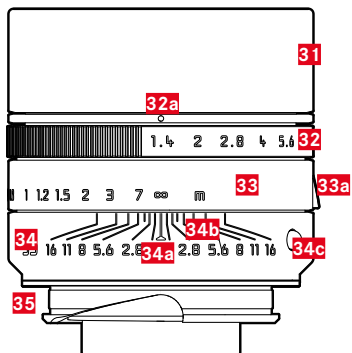

- 31** Lens hood
- 32** Aperture ring with scale
 - a** Index for aperture values
- 33** Focus ring
 - a** Focus tab
- 34** Fixed ring
 - a** Alignment point for focusing
 - b** Depth of field scale
 - c** Alignment button for lens replacement
- 35** 6-bit encoding

* Not included in the scope of delivery. Representative image. Technical designs may vary depending on included features.



DISPLAYS

VIEWFINDER

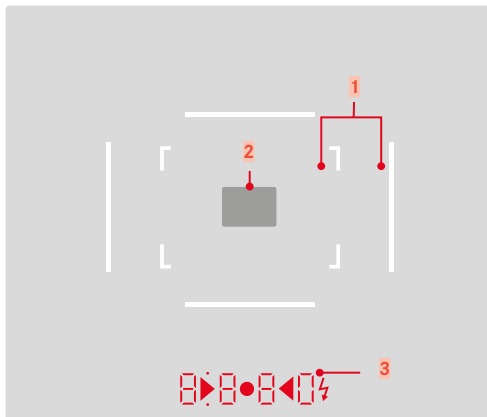

1 Bright-line frame (e.g. 50 mm + 75 mm)

2 Focus frame

3 Digital display

a. **8 8 8 0:**

- Displays the automatically calculated shutter speed in aperture-priority mode **A** or the countdown of longer shutter speeds in 1 s increments
- Warning the outside of measuring or setting range in aperture-priority mode **A**
- Exposure compensation value (appears for a short time during setting, and for approx. 0.5 s when activating exposure metering by tapping the shutter button)
- Notification for (temporarily) full cache

b. **• (top):**

- Indicates (when lit) that exposure lock is active

c. **• (bottom):**

- Indicates (flashing) that exposure compensation is in use

d. **▶ • ◀:**

- for manual exposure setting:

Concurrently as light balance for exposure compensation. The triangular LEDs give the direction of rotation of the aperture ring and shutter-speed dial to adjust the exposure.

- Warning underexposure

e. **⚡ Flash symbol:**

- Flash ready to use
- Details of flash exposure before and after exposure

LCD PANEL

STATUS SCREEN

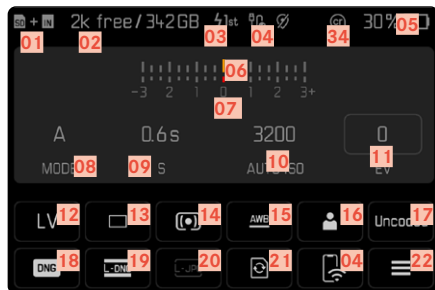

IN SHOOTING MODE (Live View)

All displays/values refer to the actual settings.

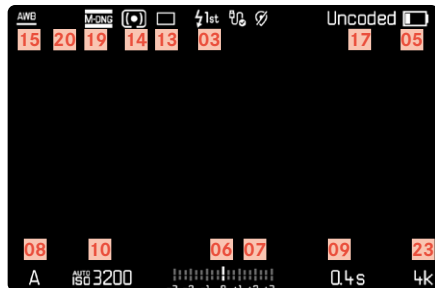

IN REVIEW MODE

All displays/values refer to the displayed image.

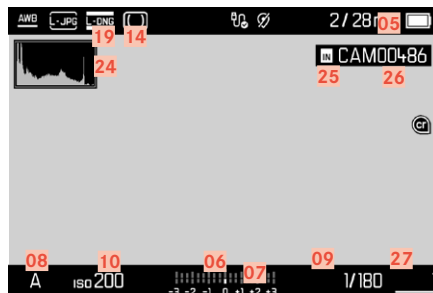

ACTIVATED Capture Assistants

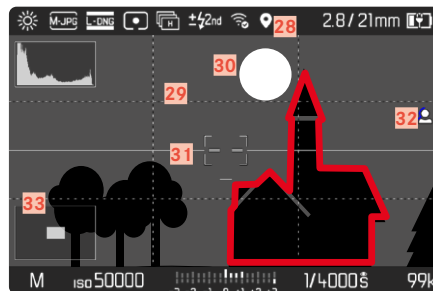







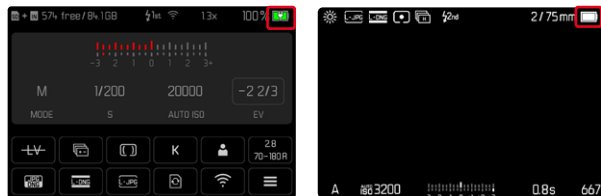

- 01 Storage location used
- 02 Remaining storage capacity
- 03 Flash sync point
- 04 Wi-Fi status
- 05 Battery capacity
- 06 Light balance
- 07 Exposure compensation scale
- 08 Exposure mode
- 09 Shutter speed
- 10 ISO Sensitivity
- 11 Exposure compensation value
- 12 Live View
- 13 Shooting mode (Drive Mode)
- 14 Exposure metering method
- 15 White balance mode
- 16 User profile
- 17 Lens information
- 18 File format
- 19 DNG Resolution
- 20 JPG resolution
- 21 Format storage
- 22 Main menu
- 23 Remaining number of shots
- 24 Histogram
- 25 Storage location
- 26 File name
- 27 File number of the image shown
- 28 Geotagging
- 29 Grid lines
- 30 Clipping
- 31 Level gauge
- 32 Focus peaking
(identification of in sharp edges in the object)
- 33 Display of cropped section size and position
(only visible for enlarged sections)
- 34 Content credentials

CHARGE STATUS INDICATOR ON THE LCD PANEL

The battery charge status is displayed in the status screen and in the header line at the top right.



Display	Charge status
	Approx. 75 - 100%
	Approx. 50 - 75%
	Approx. 25 - 50%
	Approx. 0 - 25%
	Approx. 0% The battery needs charging or replacing



PREPARATION

ATTACHING THE CARRY STRAP

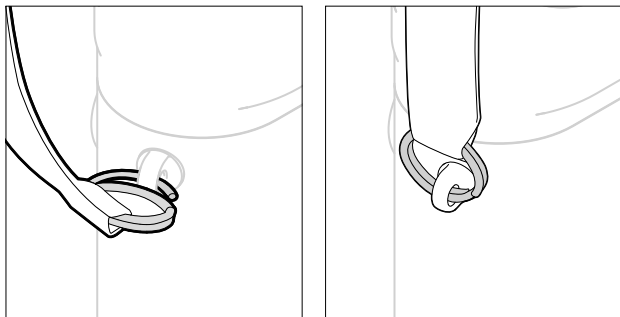

Attention

- Once you have attached the carry strap, please make sure that the clips are mounted correctly to prevent the camera from falling.

PREPARING THE CHARGER

- ▶ Connect the power adapter (C) to the mains via the plug (D) matching regional standards
- ▶ Connect the power adapter and charger (A) via USB cable (B)
 - Only the appropriate cable supplied must be used.

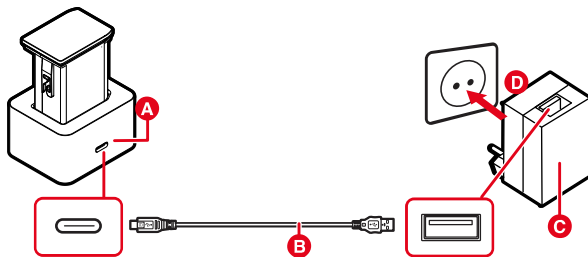

Notes

- The charger will automatically adapt to local mains voltage.
- Ensure to use only power adapters with sufficient output. Otherwise the charging process will not commence.

CHARGING THE BATTERY

The camera is powered by a lithium-ion battery.

INSERTING THE BATTERY IN THE CHARGER

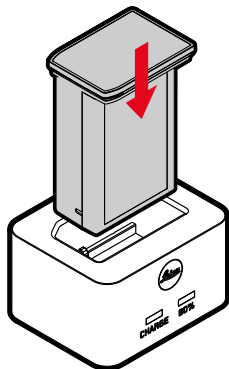

- ▶ Slide the battery into the charger with the grooves facing down until the contacts meet
- ▶ Press down on the battery until you can hear and feel it clicking into place
- ▶ Ensure that the battery is fully inserted into the charger

REMOVING THE BATTERY FROM THE CHARGER

- ▶ Pull the rechargeable battery up and out

CHARGE STATUS INDICATORS ON THE CHARGER

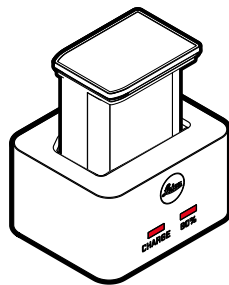

The status LED indicates a correct charging process.

Display	Charge status	Charge time*
CHARGE flashes green	Battery is charging	
80% lights up orange	80%	Approx. 2 h
CHARGE continuous green light	100%	Approx. 3.5 h

Disconnect the charger from mains electricity when the charging process is complete. There is no risk of overcharging.

* starting from a discharged state

CHARGING VIA USB

The rechargeable battery in the camera can be automatically charged when the camera is connected to a computer or another suitable power source via USB cable.

Factory setting: **On**

- ▶ Select **Camera Settings** in the main menu
- ▶ Select **USB Charging**
- ▶ Select **On/Off**

Notes

- Charging will only occur if the camera is in Standby mode or switched off. The charging process will be interrupted as soon as the camera is switched on. The charging will start automatically.
- The camera will not switch to Standby mode when charging via USB.
- The charging process will be interrupted in shooting mode.
- The bottom LED will flash during charging.

INSERTING/REMOVING THE BATTERY

- ▶ Ensure that the camera is switched OFF (see p.42)

INSERTION

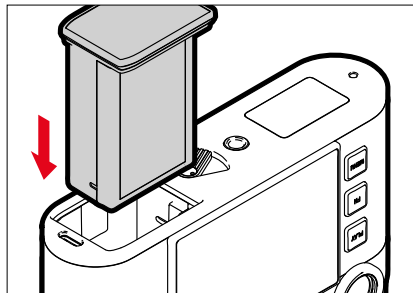

- ▶ Insert the battery into the slot with the groove pointing towards the LCD panel and gently push until you hear and feel it clicking into place

REMOVAL

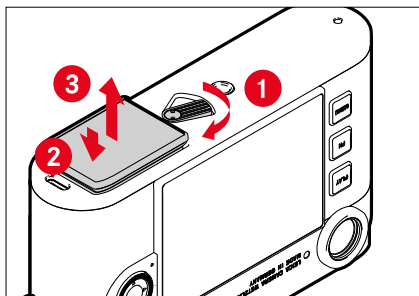

- ▶ Turn the battery release lever
 - Battery is pushing out slightly.
- ▶ Press down on the battery lightly
 - The battery unlocks and pushes out fully.
- ▶ Remove the battery

Important

- Data is still being written to the memory card as long as the bottom LED remains lit.
- Removing the battery while the camera is switched on may result in the loss of custom settings or damage to the memory card.

INSERTING/REMOVING THE MEMORY CARD

The camera will save exposures to an SD (Secure Digital), SDHC (High Capacity) or SDXC (eXtended Capacity) memory card.

Notes

- SD/SDHC/SDXC memory cards are available from various suppliers in a range of sizes and with differing read/write speeds. Memory cards with high storage capacities and high read/write speeds offer quick storage and rendering.
- The memory card may not be supported (capacity) or will have to be formatted in the camera before first use (see p. 80). The camera will in that case display a relevant message. Please see the section “Technical Data” for information about supported cards.
- Check the memory card for correct alignment if you are having difficulties inserting it into the camera.
- See p. 10 and p. 13 for additional information.



The memory card slot is located inside the battery compartment and is covered by the battery.

- ▶ Ensure that the camera is switched OFF (see p. 42)
- ▶ Remove the battery and replace it later (see p. 30)

INSERTION

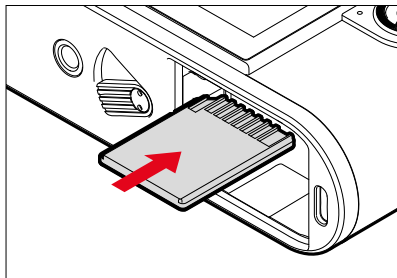

- ▶ Push the memory card into the slot until you hear and feel it clicking into place
 - The beveled corner of the card must be at the top left.

REMOVAL

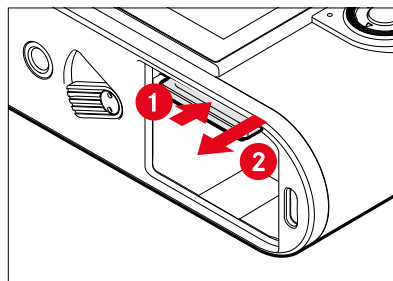

- ▶ Push down on the card until you hear a click
 - The card pushes out slightly.
- ▶ Remove the memory card

LENS

COMPATIBLE LENSES

LEICA M LENSES

Most Leica M lenses can be used with any lens equipment (with or without 6-bit encoding in the bayonet). Your camera will also deliver great photographs when using Leica M lenses without encoding. We recommend entering the lens model type manually to ensure the best possible image quality (see p. 38).

Please read the following sections for details on the very few exceptions and limitations.

Notes

- Our Leica Customer Care department can retrofit many Leica M lenses with 6-bit encoding.
- Leica M lenses come with a control curve that mechanically transfers the set distance to the camera to allow manual focusing via the rangefinder of the Leica M camera. Please note the following when using the rangefinder with wide-aperture lenses (≤ 1.4):
 - The focusing mechanism of every camera and every lens is adjusted individually at the Leica Camera AG factory in Wetzlar with the greatest possible precision. Extremely narrow tolerances are adhered to in this process, which allow precise focusing of every camera/lens combination in photography.
 - If wide-aperture lenses (≤ 1.4) are used with an open aperture, the then sometimes resulting very low depth of field, and inaccuracies in focusing with the rangefinder may lead to setting errors resulting from the (added) overall tolerance of the camera and lens. It can therefore not be ruled out that a specific camera/lens combination may result in systematic deviations.

- We recommend having the lens and camera checked by Leica Customer Care if you notice a general deviation of the focal position in a specific direction over time. Our technicians will ensure that both products are calibrated within the permissible overall tolerance. However, a 100% match of the focal position cannot be achieved for all pairings of cameras and lenses.

LEICA R LENSES (WITH ADAPTER)

The optional accessory Leica R-Adapter M allows the use of Leica R lenses as well as Leica M lenses. Please visit the Leica Camera AG website for more information on this accessory.





LENSES WITH LIMITED COMPATIBILITY

COMPATIBLE, BUT MAY POSE RISK OF DAMAGE TO THE CAMERA AND/OR LENS

- Lenses with retractable tube must only be used with the tube extended, i.e. never attempt to retract the tube while the lens is attached to the camera. This does not apply for the current Makro-Elmar-M 90 f/4 model, as its tube will not retract into the camera itself and can therefore be used without restriction.
- When using heavy lenses attached to a tripod-mounted camera, e.g. Noctilux 50 f/0.95 or Leica R lenses with an adapter: Make sure that the tilt of the tripod head cannot move inadvertently when the camera is not held. A sudden tilt and impact could result in damage to the lower edge of the camera bayonet. That is why you should always use the tripod mount on relevantly equipped lenses.

COMPATIBLE, BUT EXACT FOCUSING MAY BE LIMITED

Despite the high precision of the rangefinder on the camera, exact focusing with 135 mm lenses with an open aperture cannot be guaranteed due to the very low depth of field. We therefore recommend stopping down by at least 2 steps. Live View mode, on the other hand, plus the various setting aids provided, allow unrestricted use of this lens.

INCOMPATIBLE LENSES

- Hologon 15 f/8
- Summicron 50 f/2 with close-up function
- Elmar 90 f/4 with retractable tube (manufactured 1954–1968)
- Some examples of the Summilux-M 35 f/1.4 (non-aspherical, manufactured 1961–1995, Made in Canada) cannot be attached to the camera or cannot focus to infinity. Leica Customer Care can modify these lenses for use with the camera.

CHANGING THE LENS

LEICA M LENSES

ATTACHING

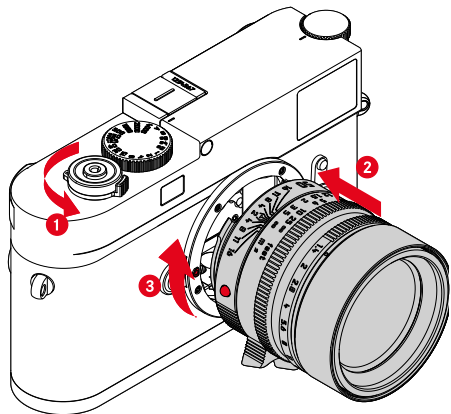

- ▶ Ensure that the camera is switched OFF (see p. 42)
- ▶ Hold the lens by the fixed ring
- ▶ Position the alignment button on the lens opposite the release button on the camera housing
- ▶ Attach the lens in this position
- ▶ Turn the lens clockwise until you hear and feel it click into place

DETACHING

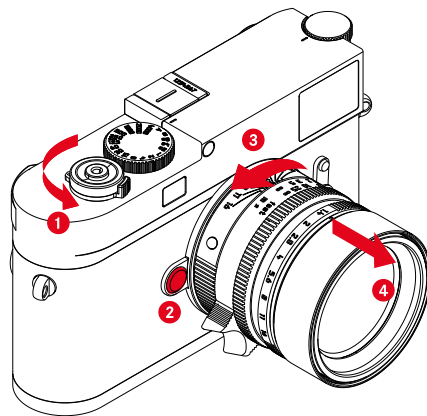

- ▶ Ensure that the camera is switched OFF
- ▶ Hold the lens by the fixed ring
- ▶ Press and hold the release button on the camera housing
- ▶ Turn the lens counter-clockwise until the alignment button is opposite the release button
- ▶ Detach the lens

Important

- Make sure to always have a lens or the camera bayonet cover attached to prevent dust or other foreign bodies penetrating the camera.
- That is why you should always replace lenses quickly and in a dust-free environment.



OTHER LENSES

(e.g. Leica R lenses)

Other lenses can be attached via an adapter for M bayonets (e.g. Leica R-Adapter M).

ATTACHING THE ADAPTER

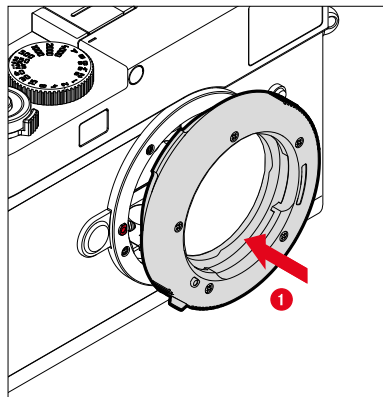

- ▶ Ensure that the camera is switched OFF (see p. 42)
- ▶ Position the alignment point on the adapter opposite the alignment point on the camera housing
- ▶ Attach the lens in this position
- ▶ Turn the adapter clockwise until you hear and feel it click into place
- ▶ Attach the lens immediately

DETACHING THE ADAPTER

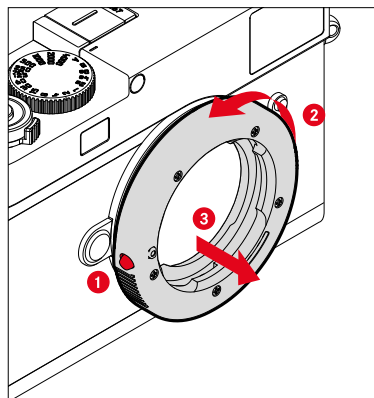

- ▶ Ensure that the camera is switched OFF
- ▶ Detach the lens
- ▶ Press and hold the release button on the camera housing
- ▶ Turn the adapter counter-clockwise until the alignment point is opposite the release button
- ▶ Detach the adapter

ATTACHING THE LENS TO THE ADAPTER

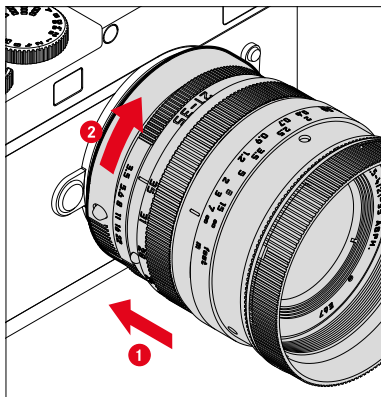

- ▶ Ensure that the camera is switched OFF
- ▶ Hold the lens by the fixed ring
- ▶ Position the alignment point on the lens opposite the alignment point on the adapter
- ▶ Attach the lens in this position
- ▶ Turn the lens clockwise until you hear and feel it click into place

DETACHING THE LENS FROM THE ADAPTER

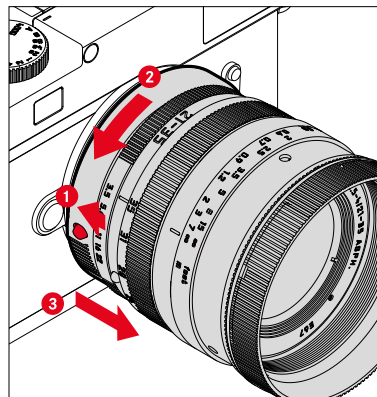

- ▶ Ensure that the camera is switched OFF
- ▶ Hold the lens by the fixed ring
- ▶ Press and hold the release button on the adapter
- ▶ Turn the lens counter-clockwise until its alignment point is opposite the release button
- ▶ Detach the lens





LENS DETECTION

The 6-bit encoding in the bayonet of current model Leica M lenses allows the camera to detect the lens type.

- This information is used for e.g. image data optimization. Edge darkening, for example, which can become noticeable when wide-angle lenses and large apertures are used, is compensated in the relevant image data.
- The information provided by the 6-bit encoding is also written to the Exif data. The focal length of the lens is additionally displayed when rendering the extended image data.
- The camera will write an approximate aperture value to the Exif image data, which is calculated individually using the exposure metering system. This is done whether or not an encoded or unencoded lens or a non-M lens is attached via adapter, and regardless of whether the lens type was entered in the menu.

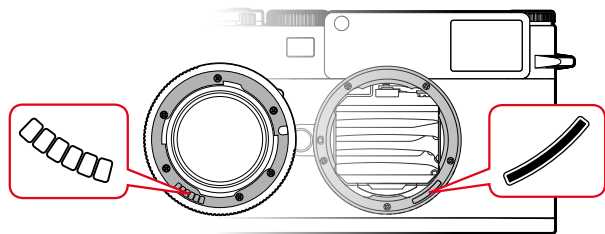

USING A LEICA M LENS WITH 6-BIT ENCODING

The camera will automatically set the correct lens type when a Leica M lens with 6-bit encoding is used. No manual setting will be required. The camera will switch to **Auto** automatically when an encoded Leica M lens is attached, regardless of the original lens setting.

USING A LEICA M LENS WITHOUT 6-BIT ENCODING

The lens type must be entered manually when using a Leica M lens without 6-bit encoding.

- ▶ Select **Lens Detection** in the main menu
- ▶ Select **Manual M**
- ▶ Select the attached lens from the list
 - The lenses are listed with their focal length, apertures and item number.



Notes

- Many lenses have their item number engraved on the opposite side of the depth of field scale.
- The list also includes lenses that were available without encoding in the past (pre-June 2006). Newer lenses are all provided with encoding and can therefore be automatically detected.
- When using the Leica Tri-Elmar-M 16-18-21 f/4 ASPH., the set focal length is not transferred to the camera housing will therefore also not be included in the Exif image dataset. You can, however, enter the focal length manually.
- Tri-Elmar-M 28-35-50 f/4 ASPH., on the other hand, comes equipped with a means for mechanical transmission of the set focal length to the camera for mirroring the correct bright-line frame in the viewfinder. The focal length is scanned by the camera electronics and the information is used for focal length-specific corrections. Due to space limitations, the menu only contains an item number (11 625). The two other variants – 11 890 and 11 894 – can be used as well and the menu settings will apply.

USING A LEICA R LENS

The lens type must also be entered manually when attaching a Leica R lens via the Leica R-AdapterM. The camera will automatically switch to **Manual R** when a Leica R lens is attached, no matter what setting existed originally. You will have to select the lens type from the list.

- ▶ Select **Lens Detection** in the main menu
- ▶ Select **Manual R**
- ▶ Select the attached lens from the list

DISABLING LENS DETECTION

Lens detection can optionally be disabled completely. That makes sense if the shot will not be automatically corrected (DNG and JPG) to maintain the characteristic features of a lens.

- ▶ Select **Lens Detection** in the main menu
- ▶ Select **Off**

Note

- No lens information will be written to the Exif (Exchangeable Image File Format) data of the image when lens detection is disabled.



DIOPTER COMPENSATION

DIOPTER COMPENSATION ON THE RANGEFINDER

A diopter compensation function for up to ± 3 diopter is available for users of eye glasses.

The rangefinder can be fitted with an optional Leica correction lens for that purpose.

<https://store.leica-camera.com>

- ▶ Attach the correction lens flat against the viewfinder eyepiece
- ▶ Tighten in clockwise direction

Notes

- Please note the information provided on the Leica homepage for the selection on an appropriate correction lens.
- Please note that the default viewfinder setting of the Leica M11-P is -0.5 diopter. If you wear eye glasses with 1 diopter, you will need a correction lens with $+1.5$ diopter.

DIOPTER COMPENSATION WITH VISOFLEX 2

Visoflex 2 (optional accessory) comes with an adjustable diopter compensation function in the range of -3 to $+4$ diopters. Settings are selected via the lateral diopter setting wheel.

- ▶ Turn the wheel in direction of the lens
 - The diopter setting is corrected towards plus (+).
- or
- ▶ Turn the wheel in direction of the LCD panel
 - The diopter setting is corrected towards minus (-).





CAMERA OPERATION

CONTROL ELEMENTS

MAIN SWITCH

The main switch switches the camera on and off.

SWITCHING THE CAMERA ON

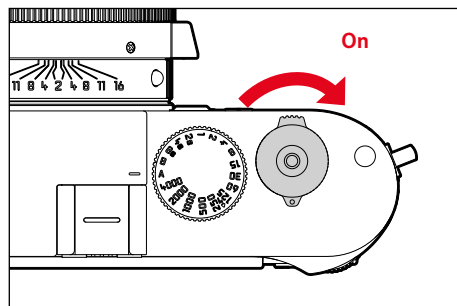

Notes

- Once switched on, the camera will be ready to use after approx. 1 s.
- The LED lights up briefly and the displays in the viewfinder appear.

SWITCHING THE CAMERA OFF

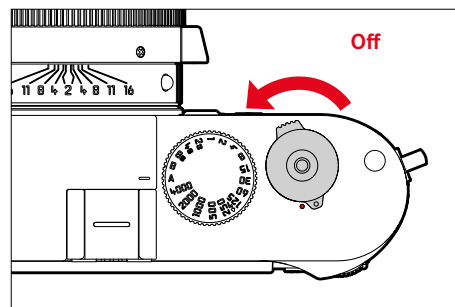

Note

- The function **Camera Standby** (see p. 65) deactivates the camera automatically if no operation occurs within a preset time. Use the main switch to deactivate the camera if this function is **Off** to prevent inadvertent exposures and battery discharge when the camera is not in use.

SHUTTER BUTTON

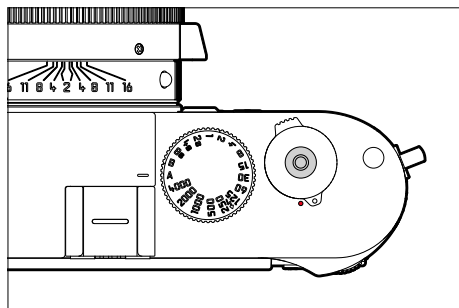

The shutter button works in two stages.

1. **Tapping** (= Pressing the shutter button to the 1st pressure point)

- Activating the camera electronics and displays
- Exposure lock (metering & saving):
 - saves the metered exposure value in aperture-priority mode, i.e. the shutter speed calculated by the camera
- Restarting a running self-timer delay time
- Return to shooting mode
 - from review mode
 - from menu control
 - from standby mode

2. **Press down fully**

- Shutter release
- Starting a preselected self-timer delay time
- Starting a continuous shooting or interval shooting

Notes

- Press down the shutter button in a smooth motion until you hear the click of the shutter to prevent camera shake.
- The shutter button remains locked:
 - if the memory card inserted and/or the internal buffer memory are (temporarily) full
 - if the battery has exceeded its performance limits (capacity, temperature, age)
 - if the memory card is write-protected or damaged
 - if the sensor is too hot



SHUTTER-SPEED DIAL

The shutter-speed dial has no stop, which means it can be turned in either direction from any position. It will click at each engraved position and for intermediate values. Intermediate positions outside the click positions must not be used. Please read the section “Exposure” (see p. 104) for details about exposure settings.

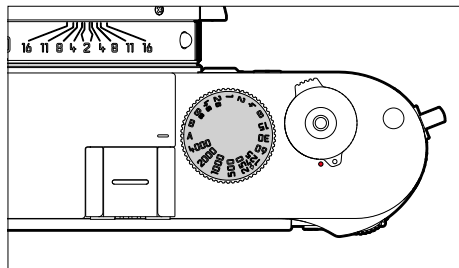

- **A**: aperture-priority mode (automatic shutter speed control)
- **1/4000 - 8s**: Fixed shutter speeds of 1/4000 s to 8 s (with intermediate values, clicking in 1/2 increments)
- **B**: Long-term exposure (bulb)
- **⚡**: The shortest possible sync speed (1/180 s) for flash mode

ISO DIAL

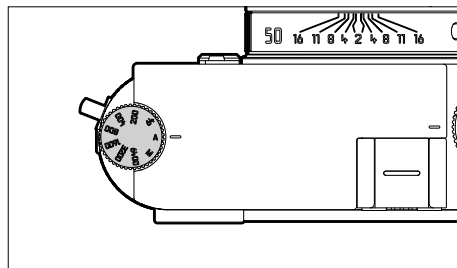

- **A**: Automatic ISO sensitivity control
- **64 - 6400**: fixed ISO values
- **M**: Manual ISO sensitivity control

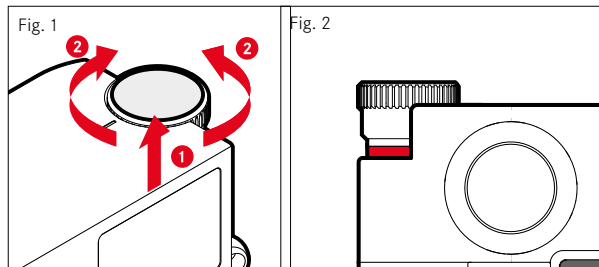

- ▶ Push the ISO dial up until you feel it clicking into place and the red line (fig. 2) is visible
- ▶ Turn the dial to set the desired value
- ▶ Push down the ISO dial

THUMBWHEEL

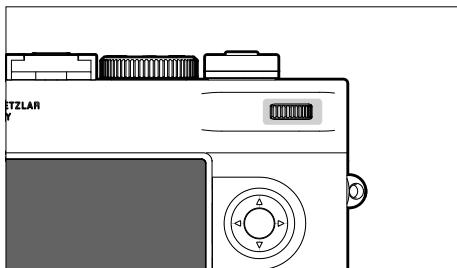

- Menu navigation
- Exposure compensation value selection
- Enlarging/reducing viewed images
- Setting selected menu items/functions
- Scrolling through the gallery (while pressing and holding the **PLAY** button)

DIRECTIONAL PAD/CENTER BUTTON

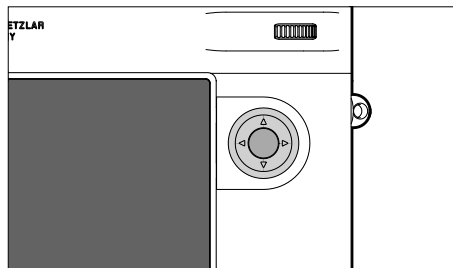

DIRECTIONAL PAD

- Menu navigation
- Setting selected menu items/functions
- Scrolling through the gallery
- Accessing the submenu

CENTER BUTTON

- Accessing the information display
- Applying menu settings
- Displaying settings/data in shooting mode
- Displaying image data in review mode
- Accessing the submenu





PLAY BUTTON/MENU BUTTON

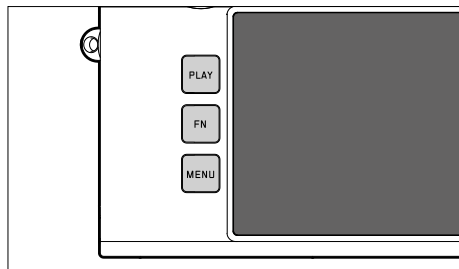

PLAY BUTTON

- Activation and deactivation of the (continuous) review mode
- Return to full-screen display

MENU BUTTON

- Accessing the menu (incl. status screen)
- Accessing the play menu
- Exiting the currently displayed (sub) menu

LCD PANEL



- Displaying most important current settings
- Quick access to some menus
- Touch control

FUNCTION BUTTONS

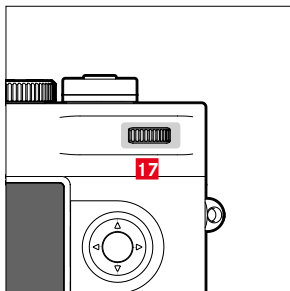
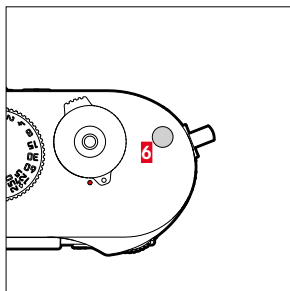
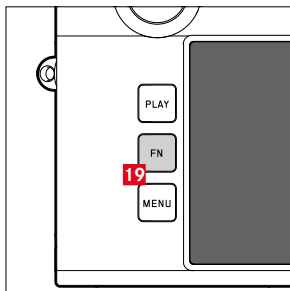

Direct access to various menus and functions. All function buttons can be custom configured (see p. 60).

FACTORY SETTINGS

In shooting mode

In review mode

FN button 19

Live View

Function button 6

Focus assist

Marking/rating a image





Function button 17 (press thumbwheel)

Exposure Compensation

Changing the magnification



LCD PANEL (TOUCH SCREEN)

TOUCH CONTROL*		In shooting mode	In review mode
	“tap”	Shifting the focus frame	Selecting images Hide/show info displays
	“double tap”	Activating Focus Assist	Enlarging/reducing viewed images
	“swipe”	Shifts the enlarged image section (with Focus Assist activated)	Scrolling through the gallery Shifts the enlarged image section
	“horizontal swipe” (full length)		Scrolling through the gallery
	“vertical swipe” (full length)	Switching to review mode	Switching to shooting mode
	“two-finger pinch” “two-finger spread”		Enlarging/reducing viewed images
	“swipe and hold” “hold and swipe”		Continuous scrolling

* A light touch is enough, don't apply pressure. Touch control* can be switched on/off as of firmware version FW 2.0.0.

MENU CONTROL

CONTROL ELEMENTS

The following elements are used for menu control.

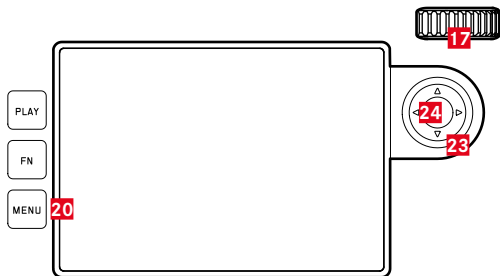

23 Directional pad

24 Center button

20 **MENU** button

17 Thumbwheel

MENU SECTIONS

The following menu sections are available: Status Screen, **Main Menu** and **Favorites**.

Status screen:

- quick access to the most important settings

Favorites:

- your custom list (see p. 59 for details on how to manage this list)
 - The favorites menu can only be displayed if it has at least one menu item assigned.

Main Menu:

- offers access to all menu items
- contains various submenus



STATUS SCREEN



FAVORITES

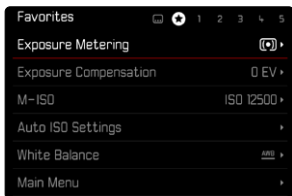
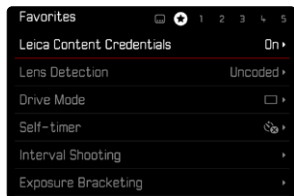

MAIN MENU

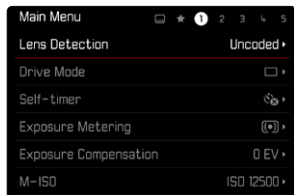

SWITCHING MENU SECTIONS

The status screen will always be displayed as the first menu section. The top level of the menu is organized into “pages”, which are displayed in the header line: Status screen, poss. Favorites menu (up to 2 pages), and several sections of the Main menu. You can switch between menu sections by scrolling through the pages. Alternatively, the status screen and the favorites menu offer access to the main menu as their respectively last menu item.

Scrolling forward

- ▶ Press the **MENU** button
 - The status screen will appear again after the last page of the main menu.

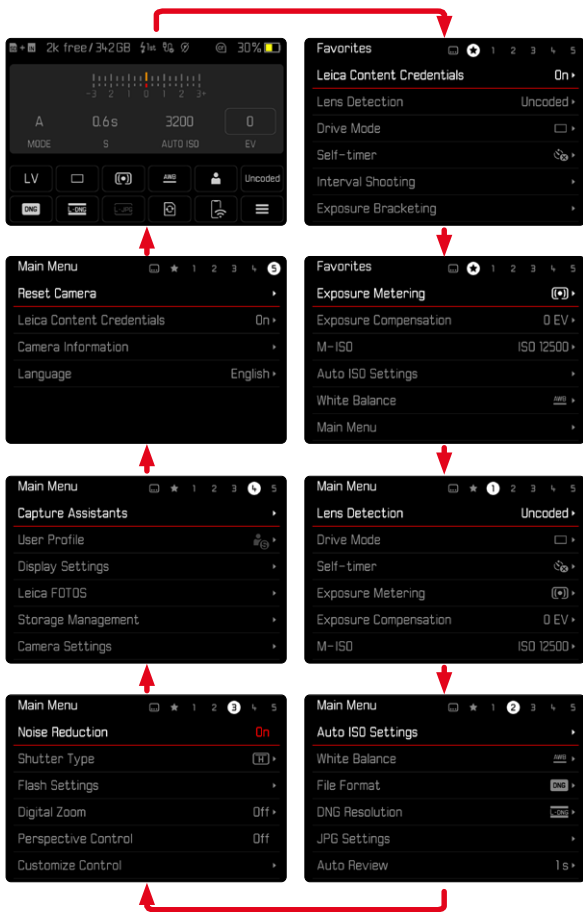

STATUS SCREEN

The status screen offers an overview of the most important information regarding the current camera status and active settings.

It furthermore allows direct access to important settings. The status screen is optimized for touch control.

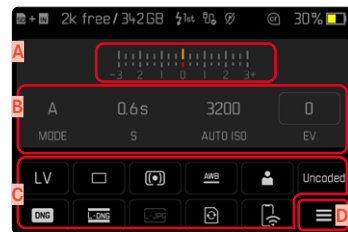

- A Light balance with exposure compensation scale
- B Exposure settings (see p. 104)
- C Menu items
- D Access to the main menu

Notes

- If touch operation is not possible or desired (e.g. in EVF mode), the status screen can also be operated using the directional pad and center button, or the thumbwheel.
- The settings become effective immediately.
- The framed control panels can be selected. The values not outlined are either automatically set values (in Aperture-Priority or Auto ISO), or fixed values set using the controls (on the shutter-speed dial or ISO dial).

SELECTING SETTINGS

Settings can be selected in various ways from within the status screen. The setting types vary from menu to menu.

- ▶ Tap the desired control panel
 - The relevant menu appears.

DIRECT SETTINGS

A version of the menu bar appears in the lower area of the status screen (see p. 57).

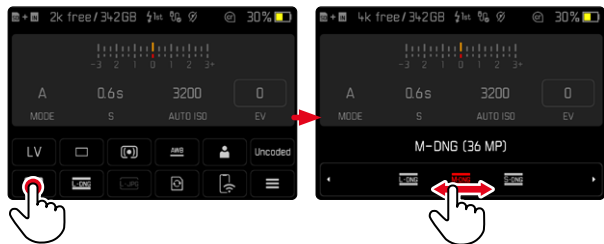

- ▶ Select the desired function directly or swipe

Note

- Do not remove the rechargeable battery! Settings are not saved permanently until the camera is switched off. Unsaved changes will be lost if the battery is removed while the camera is running.

ACCESSING A STANDARD SUBMENU

These menus behave as if they were accessed from within the main menu (see p. 54). Touch control is therefore unavailable. From there, you return to the status screen and not to the next higher menu item.

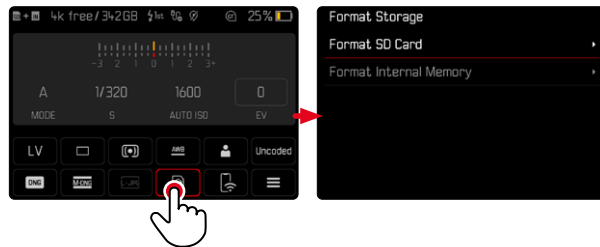

- ▶ Select the desired setting

FAVORITES MENU

The favorites menu offers quick access to the most frequently used menu items. It can contain up to 11 menu items. These can be assigned individually (see p. 59).

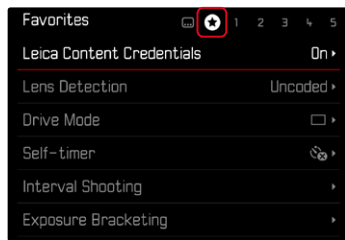

MAIN MENU

The main menu offers access to all settings. Most of these are organized in submenus.

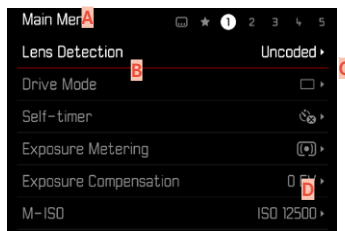

- A** Menu sections: **Main Menu** and **Favorites**
- B** Menu item name
- C** Menu item setting
- D** Submenu reference

SUBMENU

There are various types of submenus available. The following pages describe their operation.

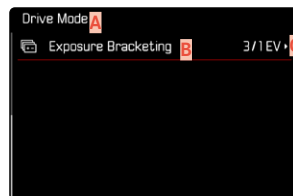
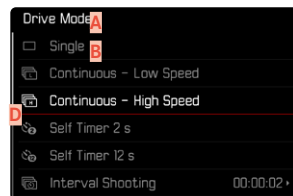

- A** Current menu item
- B** Submenu item
- C** References to other submenus
- D** Scrollbar



MENU NAVIGATION

SCREEN BY SCREEN NAVIGATION

Scrolling forward

- ▶ Press the **MENU** button (repeatedly if needed)
 - The status screen will appear again after the last page of the main menu.

Scrolling backward

- ▶ Press and hold the **MENU** button while pressing the directional pad right
 - The last page of the main menu will appear again after the status screen.

LINE BY LINE NAVIGATION

(Function/function option selection)

- ▶ Press the directional pad up/down
- or

- ▶ Turn the thumbwheel
(to the right = down, to the left = up)
 - Once the last menu item has been reached scrolling up or down, the display will automatically jump to the previous or next screen. The currently active menu section (Favorites, Main Menu) is not exited.

Note

- Some menu items can only be accessed under specific circumstances. The text in the relevant line is displayed in gray to signify the existence of a submenu.

SHOW SUBMENU

- ▶ Press the center button/thumbwheel
- or
- ▶ Press the directional pad to the right

CONFIRM SELECTION

- ▶ Press the center button/thumbwheel
 - The screen image changes back to the active menu item. The set function variant is shown on the right in the relevant menu line.

Note

- No confirmation is needed for the selection of **On** or **Off**. An automatic save is done.

GO BACK ONE STEP

(Return to the superordinate menu item)

- ▶ Press the directional pad left
 - This option is only available for list-type submenus.

GO BACK TO TOP MENU LEVEL

- ▶ Press the **MENU** button **1x**
 - The top level of the currently selected menu section is displayed.

EXITING THE MENU

You can exit the menus and submenus at any time – with/without applying the settings selected there.

Go to shooting mode

- ▶ Tap the shutter button

Go to review mode

- ▶ Press the **PLAY** button





SUBMENU

KEYBOARD/NUMBER PAD

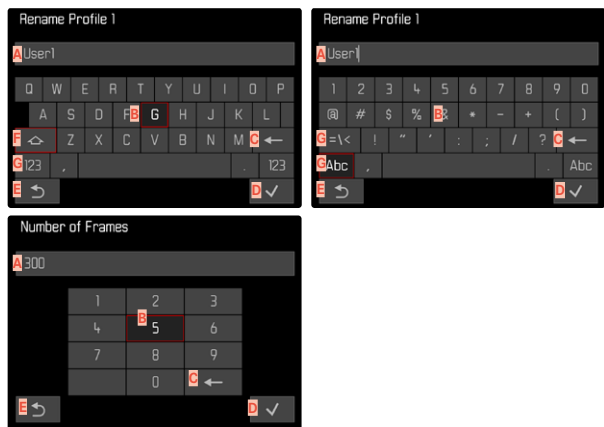

- A** Entry line
- B** Keyboard/Number pad
- C** “Delete” button (deletes the last character entered)
- D** “Confirm” button
(to apply individual values and existing settings)
- E** Return to previous menu level
- F** Shift key (toggles between upper and lower case letters)
- G** Changing the character type

SELECTING A BUTTON (ICON/FUNCTION BUTTON)

Using button control

- ▶ Press the directional pad in the relevant direction
 - The currently active button will be highlighted.
 - ▶ Press the center button/thumbwheel
- or
- ▶ Turn the thumbwheel
 - The currently active button will be highlighted.
 - There will be an automatic jump to the next/previous line when the end/beginning of the line is reached.
 - ▶ Press the center button/thumbwheel

Using touch control

- ▶ Press the button of your choice

SAVE

- ▶ Select button **D**

CANCEL

- ▶ Press the **MENU** button
- or
- ▶ Select button **E**

MENU BAR

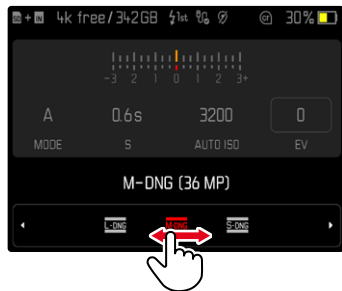

Using button control

- ▶ Press the directional pad left/right
- or
- ▶ Turn the thumbwheel

Using touch control

- ▶ Select the desired function directly or swipe

Notes

- The currently active setting displayed in the center is highlighted in red.
- The set value is displayed above the scale/below the menu bar.
- The following applies for direct access: The selected function requires no additional confirmation and will be active immediately.

SCALE MENU

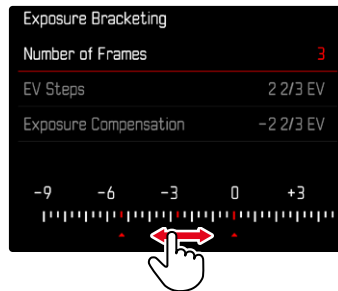

Using button control

- ▶ Press the directional pad left/right
- or
- ▶ Turn the thumbwheel

Using touch control

- ▶ Select the desired setting directly or swipe

Notes

- The currently active setting displayed in the center is highlighted in red.
- The set value is displayed above the scale/below the menu bar.



DATE/TIME MENU

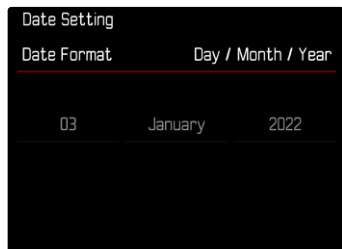

Moving to the next settings field

- ▶ Press the directional pad left/right
- or
- ▶ Press the center button
- or
- ▶ Turn the thumbwheel

Setting values

- ▶ Press the directional pad up/down

Saving and returning to superordinate menu item

- ▶ Press the center button on the last setting field
- or
- ▶ Press the thumbwheel

COMBI MENU

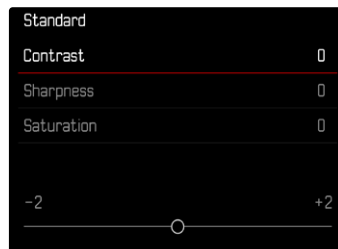

The setting of the individual menu items is done via a setting bar in the lower display area.

Accessing individual menu items

- ▶ Press the directional pad up/down

Setting individual items

- ▶ Press the directional pad left/right
- or
- ▶ Turn the thumbwheel

Applying the setting

- ▶ Press the center button/thumbwheel

Returning to the superordinate menu item

- ▶ Press the **MENU** button

USER-DEFINED OPERATION

FAVORITES MENU

Assign your most frequently used menu items to a favorites menu (up to 11 items) for quick and easy access. The available functions are shown in the list on p. 170.

The favorites menu will be represented by an asterisk in the header line, provided it contains at least one menu item.

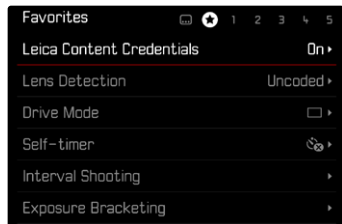

MANAGING THE FAVORITES MENU

- ▶ Select **Customize Control** in the main menu
- ▶ Select **Edit Favorites**
- ▶ Select the desired menu item

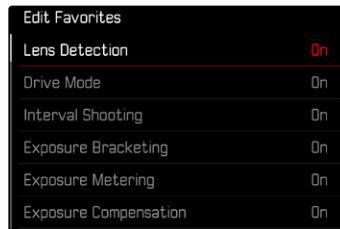

- ▶ Select **On/Off**
 - A warning message appears when the favorites menu has reached the maximum of 11 menu items and no further items can be added.

Note

- The favorites menu will be deleted completely if all menu items are set to **Off**.

Resetting the Favorites menu

- ▶ Select **Customize Control** in the main menu
- ▶ Select **Reset Favorites**
 - All menu items are set to Off and the Favorites menu is deleted





DIRECT ACCESS TO MENU FUNCTIONS

You can assign specific menu functions to the function buttons for extra quick direct access to menu items in shooting mode. The available functions are shown in the list on p. 170. For factory settings see p. 47.

CHANGING AN ASSIGNMENT

All function buttons permit a quick and easy reassignment of functions in addition to access to their currently assigned menu function.

- ▶ Press and hold the desired function button
 - The direct access appears on the LCD panel.

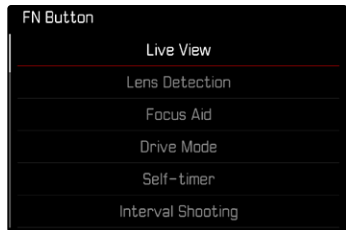

- ▶ Select the desired menu item

ACCESSING THE ASSIGNED MENU FUNCTION

- ▶ Briefly press and release the desired function button
 - The assigned function is accessed, or a submenu appears on screen.

Notes

- The submenus accessed via direct access may look differently than when they are accessed via the main menu. Specifically, they often appear as menu bars to allow quick settings.
- The settings can be done via key control or using touch control on the LCD panel. The operating mode depends on the type of submenu.

THUMBWHEEL ASSIGNMENT

Assign a menu function to the thumbwheel for extra quick direct access: **Exposure Compensation** or **Focus Aid**. The setting has no impact on the function if focus assist tools are in use.

Factory setting: **No Function**

- ▶ Select **Customize Control** in the main menu
- ▶ Select **Customize Wheel**
- ▶ Select **Exposure Compensation**/**Focus Aid** or **No Function**

USER PROFILES

This camera allows the permanent storage of any menu settings, to e.g. access them quickly and easily for recurring conditions/image objects. Six memory slots are provided to store custom settings, plus the factory setting, which is always available and cannot be modified (**Default Profile**). You can assign names for the saved profiles yourself.

Any profiles configured for the camera can be saved to a memory card for use on another camera. Similarly, profiles saved on a memory card can be transferred to the camera.

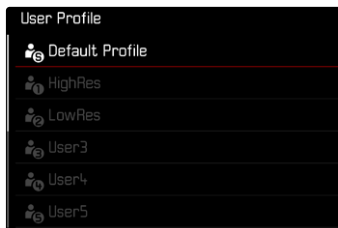



CREATING PROFILES

Saving settings/creating a profile.

- ▶ Create custom settings for the desired functions via menu control
- ▶ Select **User Profile** in the main menu
- ▶ Select **Manage Profiles**
- ▶ Select **Save as Profile**
- ▶ Select a memory slot

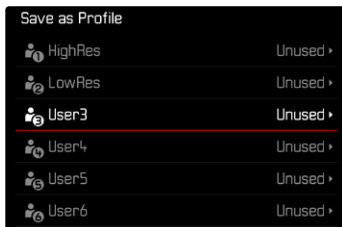

- ▶ Confirm the selection

Notes

- Existing profiles are overwritten with the latest settings.
- A memory slot can only be deleted via the function **Reset Camera** described in the section “Resetting the camera to factory settings” (see p. 146).

RENAMING PROFILES

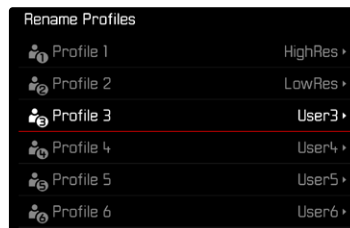

- ▶ Select **User Profile** in the main menu
- ▶ Select **Manage Profiles**
- ▶ Select **Rename Profiles**
- ▶ Select a profile
- ▶ Enter a name for the profile via the associated submenu keyboard and confirm your input (see p. 56)
 - Profile names must be between 3 and 10 characters in length.

APPLYING/ACTIVATING PROFILES

Factory setting: **Default Profile**

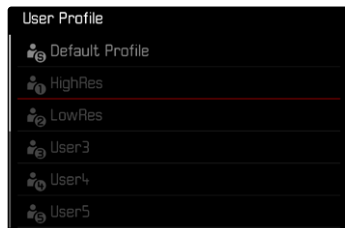

- ▶ Select **User Profile** in the main menu
 - A list of profile names is displayed.
- ▶ Select a profile
 - The selected profile is marked as **Active**.
 - Free memory slots appear in gray.

Note

-  will appear in the original menu list instead of the name of the profile used if you change one of the settings for the profile currently in use.

EXPORTING/IMPORTING PROFILES TO/FROM THE MEMORY CARD

- ▶ Select **User Profile** in the main menu
- ▶ Select **Manage Profiles**
- ▶ Select **Export Profiles** or **Import Profiles**
- ▶ Confirm the selection

Notes

- When importing and exporting, **all** profile slots are transferred to the card, i.e. including any empty slots. Any existing profiles stored in the camera will be overwritten, during the profile import. Individual profiles cannot be imported or exported.
- Any existing set of profiles will be replaced on the memory card during an export without an acknowledgment prompt.





CAMERA BASIC SETTINGS

For details on how to navigate in the menus and for inputs see chapter “Menu control” (see p.48).

The two menu items **Language** and **Date & Time** appear automatically when switching the camera on for the first time, after a reset to factory settings (see p.146), or after a firmware update.

MENU LANGUAGE

Factory setting: English

Available menu languages: English, German, French, Italian, Spanish, Russian, Portuguese, Japanese, Traditional Chinese, Simplified Chinese, Korean

- ▶ Select **Language** in the main menu
- ▶ Select your language
 - Aside from a few exceptions, the language will be changed for all information.

DATE/TIME

RECEIVING THE SETTINGS FROM A MOBILE DEVICE

The date and time settings can be automatically received from the mobile device.

Factory setting: **On**

- ▶ Select **Camera Settings** in the main menu
- ▶ Select **Date & Time**
- ▶ Select **Via Smartphone**
 - The settings will be re-synched each time the device is paired again. The pairing process is described in the chapter “Leica FOTOS” (see p.150).

MANUAL SETTINGS

DATE

You can choose one of 3 options for the display sequence.

- ▶ Select **Camera Settings** in the main menu
- ▶ Select **Date & Time**
- ▶ Select **Date Setting**
- ▶ Select the desired date format
(**Day/Month/Year**, **Month/Day/Year**, **Year/Month/Day**)
- ▶ Set the date

TIME

- ▶ Select **Camera Settings** in the main menu
- ▶ Select **Date & Time**
- ▶ Select **Time Setting**
- ▶ Select the desired brightness
(**12 Hours**, **24 Hours**)
- ▶ Set the time
(Select **am** or **pm** for the 12-hour format)

TIME ZONE

- ▶ Select **Camera Settings** in the main menu
- ▶ Select **Date & Time**
- ▶ Select **Time Zone**
- ▶ Select your time zone/current location
 - The Greenwich Mean Time offset is shown on the left of the line
 - Major cities in the relevant time zones are shown on the right

DAYLIGHT SAVING TIME

- ▶ Select **Camera Settings** in the main menu
- ▶ Select **Date & Time**
- ▶ Select **Daylight Saving Time**
- ▶ Select **On/Off**

POWER SAVE MODE (STANDBY MODE)

You can choose one of two power saving functions.

- Activates device standby mode in 3 s/5 s/10 s/2 min/5 min/10 min
- Automatic LCD panel shutdown

CAMERA STANDBY

The camera will switch to the power-saving standby mode after a preset time to extend battery life if this function is activated.

Factory setting: **2 min**

- ▶ Select **Camera Settings** in the main menu
- ▶ Select **Power Saving Mode**
- ▶ Select **Camera Standby**
- ▶ Select the desired setting
(**Aus**, **30 s**, **1 min**, **2 min**, **5 min**, **10 min**, **30 min**, **60 min**)

DISPLAY STANDBY

Factory setting: **30 s**

- ▶ Select **Camera Settings** in the main menu
- ▶ Select **Power Saving Mode**
- ▶ Select **Display Standby**
- ▶ Select the desired setting
(**30 s**, **1 min**, **5 min**)

Notes

- The camera can be woken from standby mode at any time by pressing the shutter button or by switching the main switch off and on again.
- This setting will also affect the EVF of an attached Leica Visoflex 2 (see p. 68) accessory.



STATUS LED

The status LED indicates a variety of camera processes when the device is in its factory settings (incl. saving, zooming in/out and deleting images). This function can be deactivated for most processes (except for camera ON/OFF).

- ▶ Select **Customize Control** in the main menu
- ▶ Select **Backside LED**
- ▶ Select the desired setting
(**Enabled**, **Disabled**)

BOTTOM LED

The bottom LED will flash during the charging process via the USB-C port and during memory access. It indicates e.g. that data remains to be transferred from the buffer memory. The rechargeable battery must not be removed during that time.

This function can be deactivated.

- ▶ Select **Customize Control** in the main menu
- ▶ Select **Bottom LED**
- ▶ Select the desired setting
(**Enabled**, **Disabled**)

LCD PANEL/VIEWFINDER SETTINGS

The camera comes equipped with a 2.95" liquid crystal color panel, which is protected by a glass cover made of extremely hard and scratch-resistant Sapphire glass.

In shooting mode and with active Live View function, the screen displays the image captured by the sensor via the attached lens. In review mode, the images saved on the memory card are displayed on the screen. In both cases, the screen shows the entire image field, as well as the selected data and information.

BRIGHTNESS

RANGEFINDER

The brightness sensor automatically adjusts rangefinder brightness.

Note

- This automatic control is not available for Leica M lenses with viewfinder attachments, as they cover the brightness sensor that supplies the required information. The frames and displays will therefore be displayed at a constant brightness when Leica M lenses are used.

LCD PANEL

You can adjust brightness for best visibility in various lighting conditions. Selection occurs via key control or touch control.

- ▶ Select **Display Settings** in the main menu
- ▶ Select **LCD Brightness**
- ▶ Select the desired brightness or **Auto**
- ▶ Confirm selection



LEICA VISOFLEX 2 (EVF)*

An electronic viewfinder (EVF) can be attached to the Leica M11-P via its accessory shoe. Leica Visoflex 2* is an optional extra and offers the following functions:

- Swivel function for easy photography with various angles
- Applying screen settings
- Diopter compensation

Important

All mentions of “EVF” or “Electronic Viewfinder” in this manual refer to the optional accessory Leica Visoflex 2.

Using the older “Leica Visoflex” model with the Leica M11-P can – as a worst case scenario – result in irreparable damage to the camera and/or the Visoflex. Please contact Leica Customer Care if in doubt.

The settings described below will only take effect if Leica Visoflex is attached.

* Visoflex was developed specifically for the M10 series, and is not compatible with Leica M11-P. The newly developed Visoflex 2, on the other hand, can also be used with older Leica M series models.

LCD PANEL/EVF USE

The electric viewfinder can take on a variety screen of functions. The displays appearing on screen and in the electronic viewfinder are identical.

You can preset the types of situations in which the EVF or the LCD panel should show the displays.

Factory setting: **Auto**

	EVF	LCD panel
Auto	The eye sensor in the Visoflex automatically toggles the camera between LCD panel and EVF. <ul style="list-style-type: none">• Shooting• Review• Menu control	
LCD		<ul style="list-style-type: none">• Shooting• Review• Menu control
EVF	<ul style="list-style-type: none">• Shooting• Review• Menu control	
EVF extended	Only EVF is used for shooting mode. The eye sensor in the Visoflex automatically toggles the camera between LCD panel and EVF for review and menu control. <ul style="list-style-type: none">• Shooting<ul style="list-style-type: none">• Review• Menu control	

- ▶ Select **Display Settings** in the main menu
- ▶ Select **EVF <> LCD**
- ▶ Select the desired setting

Note

- Select **EVF** if you want to keep the LCD panel switched off (e.g. on dark environments).

EYE SENSOR SENSITIVITY

You can adjust the eye sensor sensitivity to ensure that the change-over functions reliably if you wear eyeglasses.

Factory setting: **High**

- ▶ Select **Display Settings** in the main menu
- ▶ Select **Eye Sensor Sensitivity**
- ▶ Select the desired setting

BRIGHTNESS

The brightness in the EVF is set independently of the brightness selected for the LCD panel.



- ▶ Select **Display Settings** in the main menu
- ▶ Select **EVF Brightness**
- ▶ Look through the viewfinder
- ▶ Select the desired brightness
- ▶ Confirm selection

Note

- The setting **Auto** is not available here.





STILL IMAGE SETTINGS

FILE FORMAT

Choose the JPG format **JPG** or the standardized raw data format **DNG** (= digital negative). Both can be used individually or simultaneously.

When creating JPGs, an initial processing occurs in the camera. Various parameters, including contrast, saturation, black level, or edge sharpness are set automatically. The result is then compressed and stored. The immediate result is an image that is optimized for various uses and a quick preview. For post-processing, on the other hand, DNG images are recommended.

DNG files contain all raw data as recorded by the camera sensor at the time the photo is taken. Special software (e.g. Adobe® Photoshop® Lightroom® or Capture One Pro®) will be needed to display DNG format files or to work with this format. Post-processing will allow exact adjustments of many parameters to your own expectations.

Factory setting: **DNG**

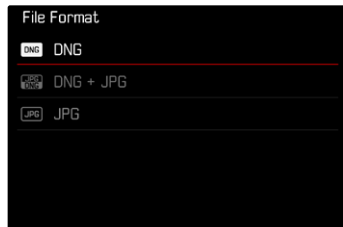

- ▶ Select **File Format** in the main menu
- ▶ Select a format
(**DNG**, **DNG + JPG**, **JPG**)

Notes

- The standardized DNG format is used for the storage of raw image data.
- When saving the image data as **DNG** and **JPG** at the same time, the resolution used for the JPG file may depend on the **DNG Resolution** setting.
- The DNG format always works with the resolution selected under **DNG Resolution**, regardless of the JPG setting.
- The remaining number of shots shown in the LCD panel will not necessarily change after every shooting. That very much depends on the object; very fine image structures result in higher data quantities, while homogeneous surfaces mean less data.

RESOLUTION

DNG RESOLUTION

Three different resolutions (number of pixels) are available for shooting in raw data format (DNG).

All the benefits of DNG capture (like extensive color depth and high dynamic range) can therefore be used even if the image size is reduced.

- ▶ Select **DNG Resolution** in the main menu
- ▶ Select the desired resolution
(**L-DNG (60 MP)**, **M-DNG (36 MP)**, **S-DNG (18 MP)**)

JPG RESOLUTION

The **JPG** format setting offers 3 image resolution (number of pixels) options: **L-JPG**, **M-JPG** and **S-JPG**. This choice allows an alignment with the intended use and available memory card capacity.

Factory setting: **L-JPG (60 MP)**

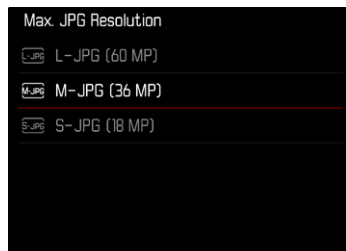

- ▶ Select **JPG Settings** in the main menu
- ▶ Select **Max. JPG Resolution**
- ▶ Select the desired resolution
(**L-JPG (60 MP)**, **M-JPG (36 MP)**, **S-JPG (18 MP)**)



EFFECT OF OTHER SETTINGS ON THE JPG RESOLUTION

DNG RESOLUTION

If shooting in DNG format or in JPG format only, the relevantly selected resolution applies. If, however, the file format is set to **DNG + JPG**, the resolution used for JPG files will depend on the resolution for DNG files. The resolution selected for JPG files can be less than the one used for DNG files, but it cannot be higher.

DNG Resolution	Max. JPG Resolution		
	L-JPG	M-JPG	S-JPG
L-DNG	60 MP	36 MP	18 MP
M-DNG	36 MP	36 MP	18 MP
S-DNG	18 MP	18 MP	18 MP

DIGITAL ZOOM

Digital Zoom is always based on L-DNG or L-JPG. When using the Digital Zoom function (see p. 73) JPG files are therefore saved with the following actual resolutions (regardless of the setting for **Max. JPG Resolution**).

The display of the selected resolution will accordingly change to L-JPG as long as Digital Zoom is active.

Digital Zoom	Max. JPG Resolution		
	L-JPG	M-JPG	S-JPG
Off	60 MP	36 MP	18 MP
1.3x	39 MP	39 MP	39 MP
1.8x	18 MP	18 MP	18 MP

DIGITAL ZOOM

There are two sizes for cropped sections available in addition to the full image section of the attached lens. A frame appears around the image section on screen, indicating the final image size.

PERMANENT SETTING



- ▶ Select **Digital Zoom** in the main menu
- ▶ Select the desired setting
(Off, 1.3x, 1.8x)

DIRECT ZOOM CHANGE

The zoom level can be switched quickly if the **Digital Zoom** function is assigned to a function button (see p. 60).

- ▶ Press the function button with the **Digital Zoom** assignment
 - The display cycles through the magnification factors 1x (no frame), 1.3x, and 1.8x.
 - The set level will remain until the next change.

JPG and DNG files appear cropped, i.e. magnified when rendered on the camera.

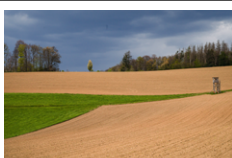
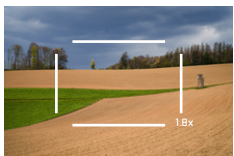
Digital Zoom	In shooting mode	In review mode
Off		
Digital zoom 1.3x		
Digital zoom 1.8x		



EFFECT ON THE RESULTING IMAGES

The Digital Zoom will have differing effects on the resulting files, depending on the selected file format.

DNG IMAGES

DNG files are always saved unchanged (at full size). The relevant information is written to the meta data. The images appear cropped when they are opened in an image editing software, but can be reset to their full size.

Since Digital Zoom is always based on L-DNG/L-JPG, the images will be stored with the following actual resolutions. The display of the selected resolution will accordingly change to L-JPG as long as Digital Zoom is active.

Digital Zoom	DNG Resolution		
	L-DNG	M-DNG	S-DNG
Off	60 MP	36 MP	18 MP
1.3x	39 MP	39 MP	39 MP
1.8x	18 MP	18 MP	18 MP

JPG IMAGES

Only an enlarged cropped section will be displayed and stored for JPG files. The image areas outside the frame are “cropped”. This operation cannot be reversed.

Since Digital Zoom is always based on L-DNG/L-JPG, the images will be stored with the following actual resolutions. The display of the selected resolution will accordingly change to L-JPG as long as Digital Zoom is active.

Digital Zoom	Max. JPG Resolution		
	L-JPG	M-JPG	S-JPG
Off	60 MP	36 MP	18 MP
1.3x	39 MP	39 MP	39 MP
1.8x	18 MP	18 MP	18 MP

FILM STYLE

IMAGE PROPERTIES

One of the many advantages of digital photography is that it is very easy to change essential image properties. The image properties of individual frames can be changed easily using various parameters. These are summarized in pre-configured **Film Style** profiles.

CONTRAST

The contrast setting, i.e. the difference between light and dark image sections, determines whether an image comes across as “flat” or “brilliant”. Increasing or decreasing this difference impacts on contrast, meaning that some image sections are rendered brighter or darker.

SHARPNESS

The impression of sharpness in a image is largely determined by edge sharpness, i.e. by how slight the transition area between light and dark is at edges in the image. Expanding or reducing these areas will therefore change the impression of sharpness.

COLOR SATURATION

The saturation factor in color shots determines, whether colors in the picture appear “pale” and pastel-like or “vivid” and bright. While lighting conditions and weather (e.g. foggy/clear) are a given in terms of shooting conditions, their rendering can be influenced.

EXTENDED DYNAMIC RANGE

This function allows an optimization of darker image areas. Object details become much clearer. This function will only affect images in JPG format.

You can specify beforehand if and to what extent you want to optimize darker areas (**Off**, **Medium**, **High**). In addition to that setting, the effect also depends on the exposure settings. The function will have the strongest effect in combination with low ISO values and fast shutter speeds. The effect is less pronounced with higher ISO values and/or slower shutter speeds.

Factory setting: **Off**

- ▶ Select **JPG Settings** in the main menu
- ▶ Select **Extended Dynamic Range**
- ▶ Select the desired setting (**Off**, **Medium**, **High**)

Note

- The optimization of darker areas will slightly reduce differentiation in very bright areas.





COLOR PROFILE

3 pre-configured color profiles are available:

Factory setting: **Standard**

– STD **Standard**

– VIV **Vivid**

– NAT **Natural**

▶ Select **Film Style** in the main menu

▶ Select a profile

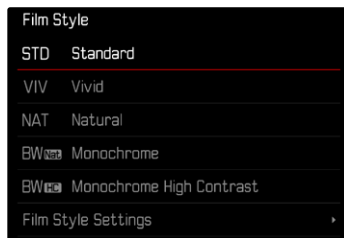

MONOCHROME PROFILE

Two pre-configured monochrome profiles are available:

– **BW** **Monochrome**

– **BW** **Monochrome High Contrast**

▶ Select **JPG Settings** in the main menu

▶ Select **Film Style**

▶ Select a profile

CUSTOMIZING PHOTO PROFILES

These parameters can be adjusted for all available profiles (**Saturation** only for color profiles). See p. 58 for details on menu operation.

▶ Select **JPG Settings** in the main menu

▶ Select **Film Style**

▶ Select **Film Style Settings**

▶ Select a profile

▶ Select **Contrast**/**Sharpness**/**Saturation**

▶ Select the desired level
(-2, -1, 0, +1, +2)

▶ Confirm

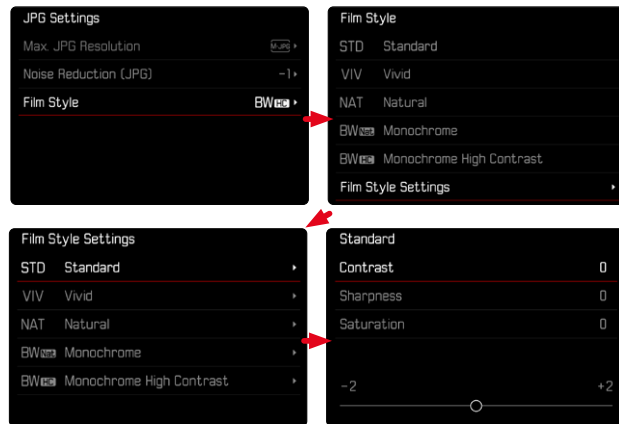

AUTOMATIC OPTIMIZATION

NOISE REDUCTION

NOISE REDUCTION FUNCTION FOR LONG-TERM EXPOSURE

In digital photography, the appearance of flawed pixels that can be white, red, blue or green is referred to as "noise". Image noise becomes more apparent when using higher sensitivities, particularly on uniform dark areas. Long exposure times may cause severe image noise. In order to reduce this annoying phenomenon, the camera will take a second "dark frame" (taken with the shutter closed) automatically after a shooting with slow shutter speed and high ISO value. The noise metered in this parallel image is then digitally "subtracted" from the data for the actual image. In such cases the message **Noise reduction in progress...** will appear with a relevant time value. The doubling of the "exposure" time must be taken into account for long-term exposure times. The camera must not be switched off during that time.

Factory setting: **On**

- ▶ Select **Noise Reduction** in the main menu
- ▶ Select **On/Off**

Noise Reduction is used if the following conditions apply:

ISO range	Shutter speed longer than
ISO 64 - ISO 125	160 s
ISO 160 - ISO 250	80 s
ISO 320 - ISO 500	40 s
ISO 640 - ISO 1000	20 s
ISO 1250 - ISO 2000	10 s
ISO 2500 - ISO 4000	6 s
ISO 5000 - ISO 8000	3 s
ISO 10000 - ISO 16000	1.5 s
ISO 20000 - ISO 32000	0.8 s

NOISE REDUCTION IN JPG IMAGES

Except when high sensitivities are used, noise is luckily negligible. Nevertheless, noise reduction is a component of data processing when JPG files are generated. On the other hand, since it also has an effect on the focus review, you can optionally weaken or strengthen this noise reduction in comparison to the standard setting.

Factory setting: **Low**

- ▶ Select **JPG Settings** in the main menu
- ▶ Select **Noise Reduction**
- ▶ Select the desired setting
(-1, 0, +1)

Note

- This setting will only affect images in JPG format.

DATA MANAGEMENT

STORAGE OPTIONS

Leica M11-P comes with a 256 GB internal memory. In combination with an inserted memory card, there will be various options for storing data.

Factory setting: **DNG+JPG first on SD**

- ▶ Select **Storage Options** in the main menu
- ▶ Select the desired setting

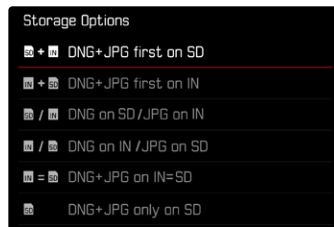

An icon in the status screen denotes the selected setting.





Display	Storage options
	DNG+JPG first on SD Files will initially be saved to the inserted memory card until it runs out of space. After that, files will be saved to the internal memory.
	DNG+JPG first on IN Files will initially be saved to the internal memory until it runs out of space. Inserted After that, files will be saved to the memory card.
	DNG on SD /JPG on IN The files are stored by format. JPG files are stored in the internal memory, and DNG files on the memory card.
	DNG on IN /JPG on SD The files are stored by format. DNG files are stored in the internal memory, and JPG files on the memory card.
	DNG+JPG on IN=SD All files are saved to both storage locations. That will ensure that there will always be a complete backup of all files.
	DNG+JPG only on SD All files are saved to the inserted memory card. The internal memory remains unused.
	No storage option. This is displayed if no SD card is inserted. Files will be saved to the internal memory (irrespective of the selected setting).

FILE BACKUP

You can choose to transfer all files in the internal memory to the inserted memory card, or only those images rated as ★. This may be useful if e.g. the internal memory will be formatted, or if previously you were saving images to the internal memory, because there was no memory card available at the time of the shooting. Always use an empty, formatted card.

- ▶ Select **Storage Management** in the main menu
- ▶ Select **Backup Memory (IN ⇒ SD)**
- ▶ Select **Copy All / Copy All with ★**
- ▶ Confirm the selection
 - The lower status LED will flash during that process.



FORMATTING STORAGE LOCATIONS

It is recommended to format storage locations from time to time, as some residual data (data accompanying shootings) may use up storage capacity. An inserted memory card and the internal memory can be formatted independently. Please note the following:

- Never switch off the camera while data transfer is in progress.
- When formatting a storage location, all data in that storage location will be irretrievably lost. Formatting will not be prevented by a deletion protection set for individual shots.
- All images should therefore be regularly transferred to a safe mass storage medium, e.g. the hard disk of a computer.

INTERNAL MEMORY

The internal memory can be formatted to remove residual data accumulated over time, or to free up the storage capacity quickly.

- ▶ Select **Storage Management** in the main menu
- ▶ Select **Format Storage**
- ▶ Select **Format Internal Memory**
- ▶ Confirm the selection
 - The lower status LED will flash during that process.

MEMORY CARD

Memory cards that have already been in use with this camera will usually not require formatting. An unformatted memory card that is inserted into the camera for the first time must be formatted. We recommend formatting memory cards from time to time, because residual data traces (data pertaining to individual shots) may reduce the card's memory capacity.

- ▶ Select **Storage Management** in the main menu
- ▶ Select **Format Storage**
- ▶ Select **Format SD Card**
- ▶ Confirm the selection
 - The lower status LED will flash during that process.

Notes

- A simple formatting process will initially not irretrievably destroy existing data on the card. Only the directory will be deleted, which means the data will no longer be directly accessible. Data access can be restored with appropriate software. Only data that is overwritten when new data is saved will actually be irretrievable.
- A memory card should be formatted again in the camera if it was formatted in another device, e.g. a computer.
- Contact your retailer or Leica Customer Care for assistance if the memory card cannot be formatted/overwritten (see p. 186).

DATA STRUCTURE

FOLDER STRUCTURE

The files (= photos) on the memory cards are saved in automatically generated folders. The first three characters signify the folder number (numerals), the last five the folder name (letters). The first folder is assigned the name “100LEICA”, the second “101LEICA”. A folder will always be created with the next available number; you can have max. 999 folders.

FILE STRUCTURE

The file names in these folders consist of eleven characters. In the factory settings, the first file is named “L1000001.XXX”, the second “L1000002.XXX”, etc. The first letter can be selected, the “L” from the factory settings denotes the camera brand. The first three characters signify the folder number (numerals). The next four digits denote the sequential file number. Once file number 9999 is reached, then a new folder will be automatically created, in which the file numbering begins at 0001 again. The last three places after the dot denote the file format (DNG or JPG).

Notes

- When using memory cards that were not formatted with this camera, the file numbering will begin with 0001 again. Should the memory card already contain a file with a higher number, then numbering will be continued from that number.
- A relevant message will be displayed on the LCD panel once folder number 999 and file number 9999 are reached, and all numbering must be reset.
- Format the memory card and reset the frame number right after to reset the folder number to 100.

EDIT FILE NAMES

- ▶ Select **Camera Settings** in the main menu
- ▶ Select **Edit File Name**
 - A keyboard submenu is displayed.
 - The input line contains the factory setting “L10” at the start of the file name. The first three characters of the file name are editable.
- ▶ Enter a letter of your choice (see p.56)
- ▶ Confirm

Notes

- The change to a file name applies to all subsequent files or until a new change is made. The sequential number will not be affected; but it will be reset when a new folder is created.
- After a reset to factory settings, the start of the file name will automatically revert to “L10”.
- Lower case letters are unavailable.



CREATING A NEW FOLDER

- ▶ Select **Camera Settings** in the main menu
- ▶ Select **Reset Image Numbering**
 - A relevant prompt is displayed.
- ▶ Confirm the creation of a new folder (**Yes**) or cancel the new folder (**No**)

Note

- The name part (first letter) of a new folder created this way remains unchanged. The file numbers in that folder will start again at 0001.

CONTENT CREDENTIALS

Signing the images with this function allows you to add allocation details to each frame.

They contain information about the identity of the creator, as well as data in compliance with the C2PA standard regarding the specific camera used for taking the images. These may offer useful allocation information for target groups, once the image is shared or published. Relevant images are marked with an icon

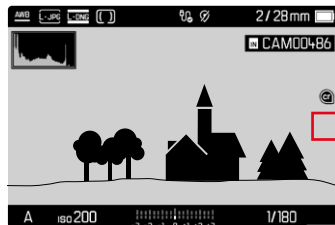

- ▶ Select **Camera Information** in the main menu
- ▶ Select **Leica Content Credentials**
- ▶ Activate the function (**On**) under the menu item **Sign Content**
- ▶ Select **Copyright/Produced by** from the submenu
 - A keyboard submenu is displayed.
- ▶ Enter the desired information (see p. 56)
- ▶ Confirm

Disclaimer

“Content credentials” allow the tracing of image content and changes thereto. Leica Camera AG assumes no liability with regard to tamper safety or misuse, and offers no warranty for the use of the “Content credentials” for a specific purpose.



RECORDING THE SHOOTING LOCATION WITH GPS (ONLY IN CONNECTION WITH THE LEICA FOTOS APP)

The GPS (global positioning system) allows the pinpointing of a receiver anywhere in the world. The GPS function is activated automatically when a connection to the Leica FOTOS app is active and if the GPS function is active on the mobile device. The camera will then continuously receive the current GPS data (latitude and longitude, elevation above sea level) and writes this information into the Exif data of the images.

- ▶ Activate the GPS function on the mobile device
- ▶ Activate Leica FOTOS and connect to the camera

Notes

- This function is available only as long as the camera is on line with the Leica FOTOS app.
- The use of GPS and associated technologies may be restricted in some countries or regions. Violations will be prosecuted by local authorities.
- You should therefore contact your travel agent or the embassy of your destination country for relevant information beforehand.

DATA TRANSFER

Data can be conveniently transferred to mobile devices via Leica FOTOS. Alternatively, the transfer can be done via a card reader or a cable connection.

ABOUT LEICA FOTOS

- ▶ See chapter “Leica FOTOS” (p. 150)

VIA USB CABLE OR “LEICA FOTOS CABLE+”

The camera supports multiple transfer options (PTP or Apple MFi). This requires an appropriate camera setting.

Factory setting: Apple MFi

- ▶ Select **Camera Settings** in the main menu
- ▶ Select **USB Mode**
- ▶ Select the desired setting
- ▶ Switch the camera off and on again
- **Apple MFi** is used for the communication with iOS devices (iPhone and iPad)
- **PTP** allows a data transfer to computers using MacOS or Windows with PTP-capable programs
- The **Tethering** function allows a tethering to CaptureOne and Adobe Lightroom

Notes

- We recommend using a card reader for the transfer of large files.
- The USB connection must not be interrupted while data is being transferred, as the computer or the camera could otherwise “crash” and irreparable damage could occur on the memory card.
- The camera must not be turned off or automatically shut itself down due to a lack of battery power while data is being transferred, as this can cause the computer to crash. For the same reason, the battery must never be removed from the camera while the connection is active.

* Optional accessory



PRACTICAL DEFAULT SETTINGS

AUXILIARY DISPLAYS

The Leica M11-P has 4 independent info profiles, which contain differing combinations of the available auxiliary displays. The following functions are available:

- Info Bars (see p. 86)
- Grid (only shooting mode, see p. 86)
- Focus Peaking (see p. 87)
- Clipping (see p. 87)
- Level Gauge (only shooting mode, see p. 88)
- Histogram (see p. 89)

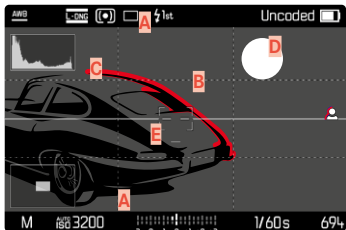

- A** Info Bars (= header and footer line)
- B** Grid
- C** Focus peaking
- D** Clipping
- E** Level gauge
- F** Histogram

INFO PROFILES

Up to 4 independent profiles can be used. The desired function can be selected and adjusted individually for each profile. Access and changeover from one info profile to another is done via the center button during running operation. It allows quick switches between various views.

Empty profiles appear below the menu item **Info Profiles** as **Off**. The profile will appear in the parent menu as **On** and is available for display if at least one function is activated.

EXAMPLE

Profile	Configuration
1	Only info bars (header and footer lines)
2	Clipping, Histogram
3	Focus Peaking
4	Info Bars, Clipping, Focus Peaking, Histogram

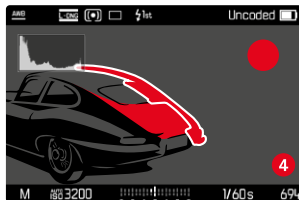
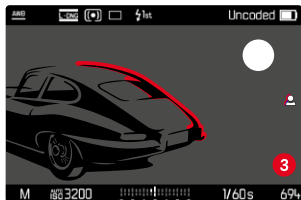
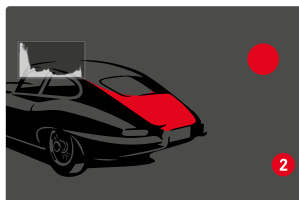
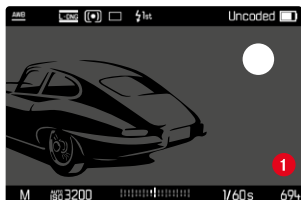

CHANGING THE INFO PROFILES

All active info profiles, i.e. those marked as **On**, can be accessed in Live View mode.

- ▶ Press the center button
 - The view switches from full screen without auxiliary displays to the first active profile.
- ▶ Press the center button
 - The view switches to the next active profile.
 - The view will revert to full screen without auxiliary displays if no other active profile is available.

CUSTOMIZING THE INFO PROFILES

- ▶ Select **Capture Assistants** in the main menu
- ▶ Select a profile
- ▶ Select the desired function
- ▶ Select **On/Off**
 - The function is activated or deactivated.

or

- ▶ Access to submenu
- ▶ Select the desired settings

Function	Available settings
Info Bars	On, Off
Grids	On, Off 3 x 3, 6 x 4
Clipping	On, Off Upper Limit (value between 200 and 255)
Focus Peaking	On, Off Color (Red, Green, Blue, White) Sensitivity
Level Gauge	On, Off
Histogram	On, Off

The profile will appear in the parent menu as **On** and is available for display if at least one function is activated.

SHOW AVAILABLE

INFO BARS

The header and footer lines show the currently active settings and exposure values. See chapter “Displays” for a full list of the various displays (see p. 24).



GRID

The grids divide the image frame into multiple fields. They facilitate pictorial composition and an exact camera orientation. The grid line distribution can be adjusted to fit the object.

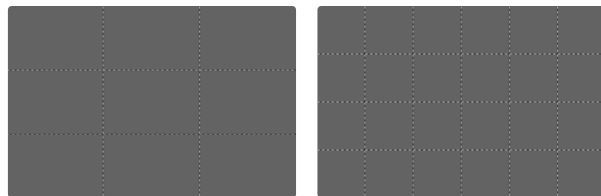

You can choose one of two grid displays. They divide the image field into 3x3 or 6x4 fields.

CLIPPING

The Clipping display marks very bright image areas. This function is a very easy and exact tool for checking the correct exposure setting. Overexposed areas flash black.

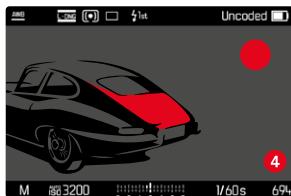

SETTING THE LIMIT VALUE

You can set a threshold value for these displays, i.e. define a value at what degree of overexposure they will appear, so that you can adjust these displays to specific conditions or in line with your own composition ideas.

- ▶ Select **Capture Assistants** in the main menu
- ▶ Select a profile
- ▶ Select **Clipping**
- ▶ Select **Upper Limit**
- ▶ Select the desired value
(**200** to **255**)

FOCUS PEAKING

This assist function highlights the edges of in focus subject elements in color.

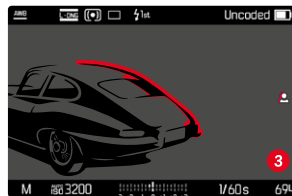

When Focus Peaking is activated,  will appear to the right of the frame with a display of the color used.

HIGHLIGHT COLOR

The color can be user-specified.

Factory setting: **Red**

- ▶ Select **Capture Assistants** in the main menu
- ▶ Select a profile
- ▶ Select **Focus Peaking**
- ▶ Select **Color**
- ▶ Select the desired setting
(**Red**, **Green**, **Blue**, **White**)

SENSITIVITY

The sensitivity can be additionally adjusted. This setting will apply for all info profiles.

Factory setting: **High**

- ▶ Select **Capture Assistants** in the main menu
- ▶ Select a profile
- ▶ Select **Focus Peaking**
- ▶ Select **Sensitivity**
- ▶ Select the desired setting
(**Low**, **High**)

Note

- Focus peaking is based on subject contrast, i.e. differences between light and dark. As a result, high contrast subject elements could be marked, even if they are not completely in focus.

LEVEL GAUGE

The integrated sensors of the camera show its orientation. These indicators ensure exact camera orientation along the longitudinal and transverse axes of critical objects, e.g. architecture.

Deviations in relation to the longitudinal axis (i.e. when the camera is tilted up or down in the direction of view) are indicated by a short line in the center of the image (1). Deviations in relation to the transverse axis (when the camera is tilted to the left or right) are indicated by two long lines to the left and right of the image center (2).

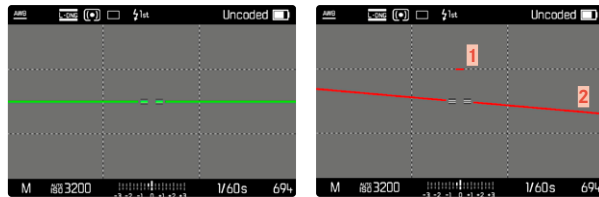

Note

- The camera will switch the aspect of the level gauge automatically for shoots in vertical format.

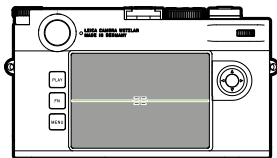

Correct alignment

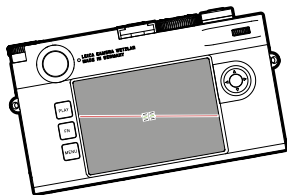

Tilted laterally to the left

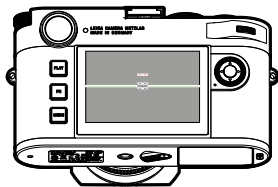

Tilted downward in the direction of view

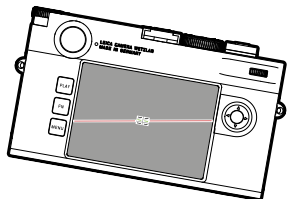

Tilted laterally to the right

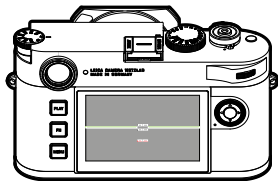

Tilted upward in the direction of view

HISTOGRAM

Histogram represents the brightness distribution in the image. The horizontal axis shows the graduated values from black (left) through gray to white (right). The vertical axis corresponds to the number of pixels at each brightness level.

This type of rendering allows an additional quick and easy assessment of the exposure setting.

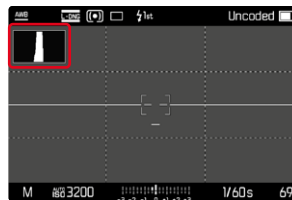

Notes

- The histogram is always based on the brightness displayed; depending on the settings used, it may not represent the final exposure.
- In shooting mode, the histogram should be regarded as a “trend indicator”.
- The histogram during rendering may differ slightly from the one during exposure.
- The Histogram always refers to the currently displayed cropped section of the image.



PHOTOGRAPHY

DRIVE MODE

The functions and settings described in the following generally refer to the exposure of individual shots. In addition to single frame shooting, the Leica M11-P offers a number of other exposure modes. Please read the relevant sections for information about functionalities and setting options.

- ▶ Select **Drive Mode** in the main menu
- ▶ Select the desired function options

Mode	Setting options / Variants
Single frame shooting	Single
Continuous shooting (see p. 116)	Speed: - Continuous - Low Speed - Continuous - High Speed
Interval shooting (see p. 117)	Number of Frames Interval between the shootings (Interval) Delay time (Countdown)
Exposure bracketing (see p. 119)	Number of Frames (3 or 5) EV Steps Exposure Compensation
Self-timer (see p. 120)	Delay time: - Self-timer 2 s - Self-timer 12 s

SHOOTING TYPES

USING THE RANGEFINDER

IMAGE FIELD (BRIGHT-LINE FRAME)

The bright-line rangefinder of this camera is not just a very high-quality, large, brilliant and bright viewfinder – it also doubles as a highly precise, lens-coupled metering device. All Leica M lenses with focal lengths between 16 and 135 mm are coupled automatically when they are attached to a camera. The viewfinder has a magnification factor of 0.73x.

The bright-line frame is coupled with the focusing function in such a way that the parallax – the offset between the lens axis and the viewfinder axis – is compensated automatically. At ranges under 2 m, the sensor captures slightly less than indicated by the inner edges of the bright-line frame, and slightly more at longer ranges (see adjacent diagram). These slight – in practical terms never important – deviations are unavoidable. The bright-line frames of a camera with viewfinder must be adjusted to the view angle of the focal length of the lens. The nominal view angle changes slightly when focusing due to the changing draw-out, i.e. the distance of the lens system to the sensor level. When the set distance is below infinity (and the draw-out accordingly greater), the actual view angle also decreases – the lens captures less of the image object. The view angle differences at greater focal lengths tend to be larger due to the greater draw-out.

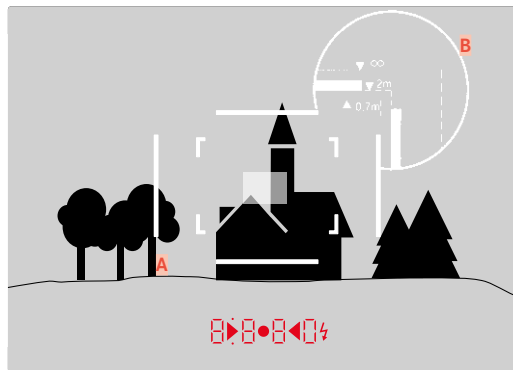

All shots and bright-line frame positions at 50mm focal length

A	Bright-line frame
B	Actual image field
Set to 0.7 m	The sensor captures around one frame width less
Set to 2 m	The sensor captures the exact image field shown within the inner edges of the bright-line frame
Set to infinity	The sensor detects around 1 or 4 more (vertical or horizontal) frame width(s)

Notes

- The bright-light frames illuminated by white light LEDs appear alongside the exposure meter LEDs at the lower edge of the viewfinder image, once the camera electronics are activated.
- The rectangular focus frame, which is brighter than the surrounding title frame, is in the center of the viewfinder frame. Please read the relevant sections for more information about focusing and exposure metering.



The relevant bright-line frame will light up in the combinations 35 mm + 135 mm, 50 mm + 75 mm or 28 mm + 90 mm when lenses with a focal length of 28 (Elmarit as of serial number 2 411 001), 35, 50, 75, 90 and 135 mm are used.

35 mm + 135 mm

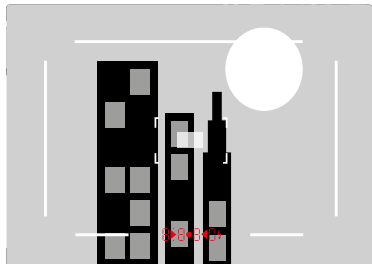

50 mm + 75 mm

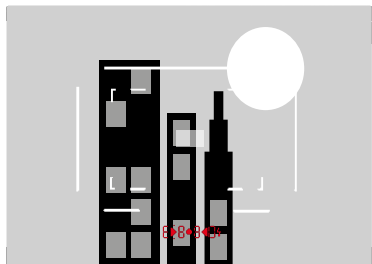

28 mm + 90 mm

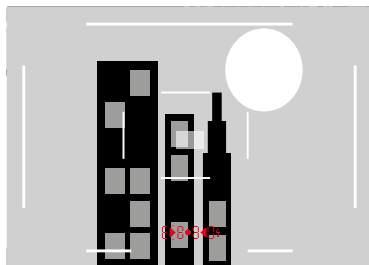

SHOW ALTERNATIVE IMAGE RANGES/FOCAL LENGTHS

Additional bright-line frames may be displayed depending on the attached lens. These allow a simulation of the relevant focal lengths. This process helps in the selection of the right lens for the desired image range.

- ▶ Push the frame selector lever towards the lens
 - The frame selector lever will snap back automatically when released.

LIVE VIEW MODE

The Live View mode allows viewing the image object on the LCD panel during shooting. The image is shown exactly as it is rendered by the attached lens.

LIVE VIEW MODE ON/OFF

- ▶ Press the function button with the **Live View** assignment
 - In factory settings, that will be the **FN** button.

or

- ▶ Press the **MENU** button
 - The status screen appears.
- ▶ Tap the **LV** control panel

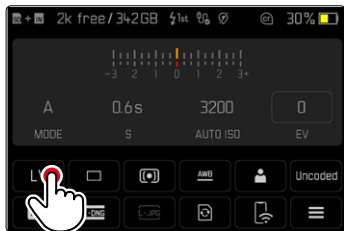

AUXILIARY DISPLAYS IN LIVE VIEW MODE

In Live View mode, the LCD panel can be used for displaying a range of settings. You can select a number of other displays in addition to the standard information contained in the header and footer to adapt the screen image to your needs.

The following assist functions are available:

- Info Bars (header and footer line)
- Grid
- Clipping
- Focus peaking
- Level gauge
- Histogram

The assist functions are organized in user-definable info profiles. See p. 84 for settings and for a description of the individual assist functions.

Additionally, an exposure preview can be displayed in Live View (see p. 114).

Showing or hiding the auxiliary displays

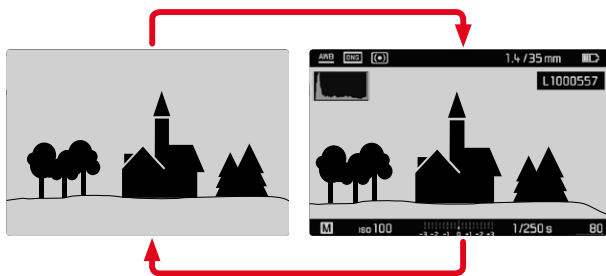

- ▶ Press the center button
 - The display toggles between a visualization with or without information displays.

or

- ▶ Tap anywhere on the LCD panel

Displaying the exposure information (only)

The exposure information is displayed in the middle part of the footer: ISO value, light balance and shutter speed. Depending on the initial situation, the display toggles to the other setting when the shutter button is held at the first pressure point. That applies to the info bars only.

- ▶ Tap and hold the shutter button
 - Exposure information is displayed at the bottom of the screen.
 - All other visible displays of the info bars will be hidden.

Notes

- Live View mode is based on the image captured by the sensor. The camera must control the shutter. Shutter control is audible and may result in a slight delay in shutter release.
- The camera will warm up when Live View mode is used for an extended period of time. Power consumption will simultaneously increase.
- Alternating current causes brightness fluctuations invisible to the human eye in many light sources. This may result in a flickering of the Live View screen image due to the sensitivity and scan rate of the image sensors. Image quality will not be impacted. The effect can be avoided by selecting a slower shutter speed.

FOCUSING

Various assist functions are provided for focusing, depending on whether you use the camera's rangefinder or Live View mode.

VIA RANGEFINDER

The rangefinder of this camera is very precise due to its wide and effective measurement base. Image sharpness can be set via the double-image or the split-image method.

DOUBLE-IMAGE METHOD

For a portrait, you might focus on the eyes using the focus frame of the rangefinder, turning the focus ring on the lens until the contours are aligned exactly inside the focus frame.

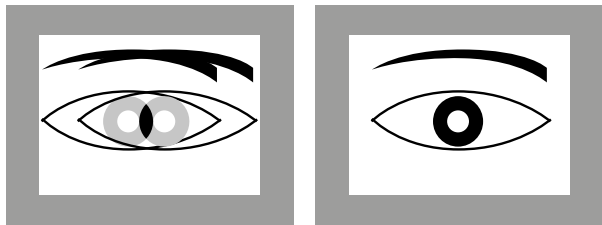

out of focus

in focus

SPLIT-IMAGE METHOD

For an architectural photograph, you might aim the focus frame of the rangefinder at e.g. the vertical edge or any other clearly defined vertical line and keep turning the focus ring on the lens until the edge contour or the line is visible at the outer edges of the focus frame without any offset.

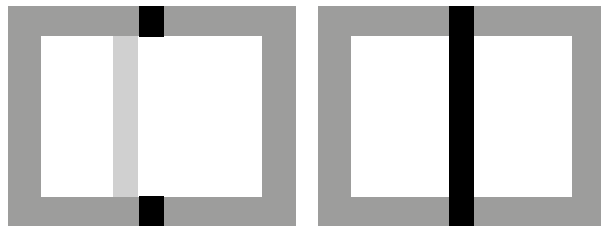

out of focus

in focus

Notes

- Very precise focusing are particularly beneficial when using wide-angle lenses with a relatively large depth of field.
- The focus frame of the rangefinder is displayed as a bright, sharp-edged rectangle in both methods. The position of the focus frame cannot be changed. It will always be at the center of the viewfinder.



IN LIVE VIEW MODE (WITH ASSIST FUNCTIONS)

You can set the image sharpness in Live View mode via the screen image – it will show the image object at the exact sharpness as it is rendered by the lens based on the focusing and aperture setting.

Your camera offers two useful assist functions to facilitate and improve setting accuracy:

- The magnification of an (initially) central cropped section of the screen image (Zooming).
 - The enlargement function (**Focus Aid**) can be activated automatically during focusing or independently.
- Marking of screen image sections where subject elements are in clear focus (Focus Peaking)

FOCUS PEAKING

This assist function highlights the edges of in focus subject elements in color. The color can be user-specified.

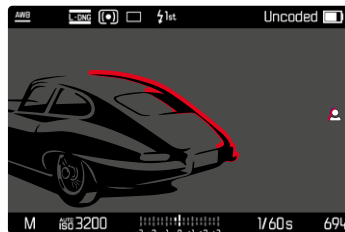

The Focus Peaking function is configured and activated/deactivated alongside the other auxiliary displays via the info profiles (see p. 84).

- ▶ Configure and display info displays
- ▶ Select an image section
- ▶ Turn the focus ring to mark the desired subject elements
 - All subject elements that are rendered in focus with the selected distance setting are marked with a silhouette in the selected color.

Notes

- Focus peaking is based on subject contrast, i.e. differences between light and dark. As a result, high contrast subject elements could be marked, even if they are not completely in focus.
- Display accuracy decreases when a wide-angle lens is used with a small aperture (= high depth of field).

ENLARGEMENT

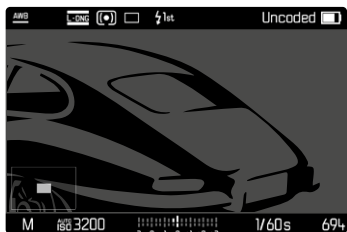

The larger the details of the object are shown, the better you can assess their sharpness and the more accurately you can focus.

In the image at the bottom left, the position and zoom level of the displayed cropped section is shown. The cropped section displayed can also be unenlarged.

The most recently used function and zoom factor will still be set the next time the function is accessed.

Adjusting the enlargement function

Use the thumbwheel to choose one of two magnification factors.

- ▶ Turn the thumbwheel

Changing the position of the enlarged section

- ▶ Move the position of an enlarged cropped section by swiping or
- ▶ Press the directional pad in the relevant direction

The magnification function can be accessed or hidden at any time regardless of the focus setting.

Accessing the enlargement function

There are various options for accessing the magnification function.

- Via the focus ring (automatic)
- Via a function button
- Via touch control
- Via the thumbwheel

Via the focus ring

The magnification function can be accessed automatically during focusing.

- ▶ Select **Capture Assistants** in the main menu
- ▶ Select **Focus Aid**
- ▶ Select **Automatic**

- ▶ Turn the focus ring
 - Magnification is activated.

Automatic magnification is active in the factory settings. The function can be disabled if desired.

- ▶ Select **Capture Assistants** in the main menu
- ▶ Select **Focus Aid**
- ▶ Select **Manual**

Note

- The magnification will end approx. 5 s after the last movement of the focus ring. That does not apply if the magnification level was changed.





Via a function button

- ▶ Press the function button with the **Focus Aid** assignment
 - In factory settings, that will be function button **6**.
 - Magnification is activated.

Using touch control

- ▶ Double-tap the LCD panel in the desired position
 - Magnification is activated.

Via the thumbwheel

The magnification function is additionally accessible via the thumbwheel.

- ▶ Select **Customize Control** in the main menu
- ▶ Select **Customize Wheel**
- ▶ Select **Focus Aid**
- ▶ Turn the thumbwheel to the right
 - Magnification is activated.

Exiting the assist functions

The manually activated magnification remains active until it is explicitly exited. That applies regardless of which operating element was used for its activation.

- ▶ Press the function button again

or

- ▶ Double-tap anywhere on the LCD panel

or

- ▶ Tap the shutter button

ISO SENSITIVITY

The ISO setting covers a range between ISO 64 and ISO 50000, allowing you to adapt to the relevant situation as required.

There is more leeway for the use of preferred shutter-speed/aperture combinations when setting the exposure manually. You can set priorities within the scope of the automatic setting, e.g. for reasons of pictorial composition.

Choose a click value engraved on the ISO dial or the positions:

- **M**: for intermediate values, as well as for higher values
- **A**: for automatic setting; values between ISO 64 and 50000 will be used

FIXED ISO VALUES

VALUES ENGRAVED ON THE ISO DIAL

- ▶ Turn the ISO dial to the desired value
(64, 200, 400, 800, 1600, 3200, 6400)

ALL AVAILABLE SETTINGS

Values between ISO 64 and ISO 50000 can be selected in 30 increments.

Factory setting: ISO 12500

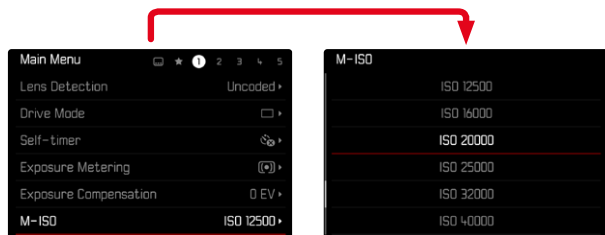

- ▶ Set the ISO dial to **M**
- ▶ Select **M-ISO** in the main menu
- ▶ Select the desired value

Note

- When high ISO values are used or the image is edited later, image noise, as well as vertical and horizontal stripes may become visible, particularly in larger, evenly lit areas of the object.



AUTOMATIC SETTING

The camera automatically adjusts the sensitivity to ambient brightness and/or to the configured shutter-speed/aperture combination. In conjunction with aperture-priority mode, this function extends the range for automatic exposure control.

- ▶ Set the ISO dial to **A**

or

- ▶ Set the ISO dial to **M**
- ▶ Select **M-ISO** in the main menu
- ▶ Select **Auto ISO**

LIMITING SETTING RANGES

A max. ISO value can be set, which will then limit the automatic setting (**Maximum ISO**). A max. exposure time can also optionally be configured. Focal length-related settings ($1/f$ s, $1/(2f)$ s, $1/(4f)$ s)* and fixed max. shutter speeds between $1/2$ s and $1/2000$ s are provided.

In the focal length-specific settings, the camera will only switch to a higher sensitivity if the shutter speed would fall below the set threshold due to low light; for example with a 50 mm lens at speeds slower than $1/60$ s at $1/f$ s, $1/125$ s at $1/(2f)$ s or $1/250$ s at $1/(4f)$ s.

Separate settings are available for flash photography.

* This function requires the use of encoded lenses or a manual setting of the lens type used in the menu.



LIMITING ISO VALUES

All values from ISO 64 are available.

Factory setting: 3200

- ▶ Select **Auto ISO Settings** in the main menu
- ▶ Select **Maximum ISO**
- ▶ Select the desired value

LIMITING SHUTTER SPEED RANGES

Factory setting: 1/(4f) s

- ▶ Select **Auto ISO Settings** in the main menu
- ▶ Select **Shutter Speed Limit**
- ▶ Select the desired value
(1/(4f) s, 1/(2f) s, 1/f s, 1/2000 s, 1/1000 s, 1/500 s, 1/250 s, 1/125 s, 1/60 s, 1/30 s, 1/15 s, 1/8 s, 1/4 s, 1/2 s)

LIMITING ISO VALUES (FLASH)

All values from ISO 64 are available.

Factory setting: 3200

- ▶ Select **Auto ISO Settings** in the main menu
- ▶ Select **Maximum ISO (Flash)**
- ▶ Select the desired value

LIMITING SHUTTER SPEED RANGES (FLASH)

Factory setting: 1/f s

- ▶ Select **Auto ISO Settings** in the main menu
- ▶ Select **Shutter Speed Limit (Flash)**
- ▶ Select the desired value
(1/(4f) s, 1/(2f) s, 1/f s, 1/250 s, 1/125 s, 1/60 s, 1/30 s, 1/15 s, 1/8 s, 1/4 s, 1/2 s)

WHITE BALANCE

In digital photography, White Balance ensures neutral color rendering in any light. White Balance relies on the setting made in the camera, which light color is to be rendered as 'white'.

Four methods are available:





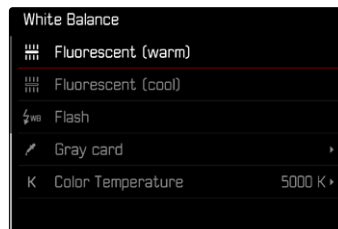



- automatic control
- fixed presets
- manual setting via metering
- direct setting of the color temperature

Factory setting: **Auto**



AUTOMATIC CONTROL/FIXED SETTINGS

- **Auto**: for automatic control, which delivers neutral results in most situations
- Various fixed presets for most frequently encountered light sources:

 Daylight	For outdoor shootings in sunlight
 Cloudy	For outdoor shootings in cloudy conditions
 Shadow	For outdoor shootings with the main subject in shadow
 Tungsten	For indoor shootings with (predominantly) incandescent lamp light
 HMI	For indoor shootings with (predominantly) light from metal halide lamps
 Fluorescent (warm)	For indoor shootings with (prevailing) light from fluorescent tubes with warm light color
 Fluorescent (cool)	For indoor shootings with (prevailing) light from fluorescent tubes with cool light color
 Flash	For flash photography

- ▶ Select **White Balance** in the main menu
- ▶ Select the desired setting

MANUAL SETTING VIA METERING

( **Gray card**)

This metering variant captures only the color hue metered within the metering field and calculates the mean gray value from it. The variant  **Gray card** is suited best for subjects in which you can clearly identify a neutral gray or pure white area.

- ▶ Select **White Balance** in the main menu
- ▶ Select  **Gray Card**
 - The following appears on the LCD panel:
 - the image based on automatic white balance
 - a cross in the middle of the image

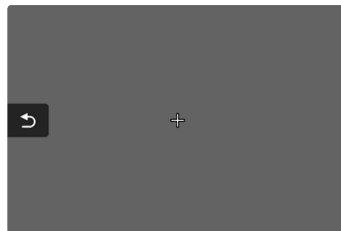

- ▶ Aim the metering field at a white or neutral gray area
 - The screen image changes dynamically in line with the reference area in the frame.

Repositioning the focus frame

- ▶ Press the directional pad in the relevant direction

Performing measurement

- ▶ Aim the metering field at a white or neutral gray area
- ▶ Shutter release

or

- ▶ Press the center button/thumbwheel
 - The measurement is taken.
 - The setting will now be saved.

Cancelling measurements

- ▶ Press the **FN** button

Note

- A value configured using this method will remain unchanged (i.e. it will be used for all subsequent photographs) until new measurements are taken or one of the other white balance settings is selected.

DIRECT SETTING OF THE COLOR TEMPERATURE

Values between 2000 and 11500 K (Kelvin) can be set directly. That gives you a very wide range, which covers virtually all color temperatures occurring in real life and within which you can adapt color rendering to any light color and your personal preferences with incredible detail.

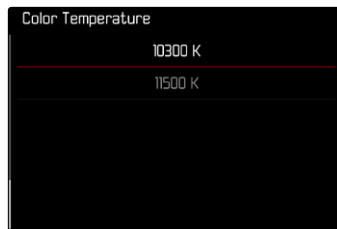

- ▶ Select **White Balance** in the main menu
- ▶ Select **Color Temperature**
- ▶ Select the desired value





EXPOSURE

The readiness of the exposure meter is signaled by continuously lit displays in the viewfinder or on the LCD panel:

- the shutter speed is displayed in aperture-priority mode
- one of the two triangular LEDs lights up in the viewfinder, possibly in conjunction with the round LED in the middle, and the light balance is shown on the LCD panel for a manual setting

The exposure meter is disabled when the shutter-speed dial is set to

B.

SHUTTER TYPE

The Leica M11-P comes equipped with a mechanical shutter and a purely electronic shutter function. The electronic shutter expands the available shutter area and functions completely noiseless, which may be important in some work environments.

Factory setting: **Hybrid**

- ▶ Select **Shutter Type** in the main menu
- ▶ Select the desired setting
(**Mechanical**, **Electronic**, **Hybrid**)

Mechanical	Only the mechanical shutter is used. Working range: 60 min - 1/4000 s.
Electronic	Only the electronic shutter function is used. Working range: 60 s to 1/16000 s.
Hybrid	You can add the electronic shutter function if you need faster shutter speeds than can be achieved with the mechanical shutter. Working range: 60 min - 1/4000 s + 1/4000 s - 1/16000 s.



USE

The classic shutter sound of the mechanical shutter conveys an auditory feedback. It is well suited for long-term exposures, as well as for shots of moving objects.

The electronic shutter function allows photography with an open aperture in very bright due to very fast shutter speeds. The distinctive “rolling shutter” effect makes it less suitable for moving objects.





Notes

- The electronic shutter function does not allow flash photography.
- The electronic shutter function in combination with fast shutter speeds can result in stripe effects on the images when used with LED or fluorescent tube lighting.

EXPOSURE METERING METHODS

The following exposure metering methods are selectable.

Factory setting: **Multi-Field**

-  Spot
-  Center-weighted
-  Highlight-Weighted
-  Multi-field

- ▶ Select **Exposure Metering** in the main menu
- ▶ Select the desired metering method
(**Spot**, **Center-Weighted**, **Highlight-Weighted**, **Multi-Field**)
 - The selected metering method is displayed in the header of the screen image in Live View mode; it appears on the status screen if the viewfinder is used.

Spot metering allows a shifting of the focus point:

- ▶ Tap the LCD panel in the desired position
- or
- ▶ Press the directional pad in the relevant direction

All exposure metering methods are available for use, irrespective of whether Live View is currently active. Exposure metering will in any case occur via the shooting sensor. The displays used for assessing the correct exposure differ in rangefinder and Live View mode (see p. 109).



SPOT

Spot metering only captures and analyzes a small area in the middle of the screen image, which is shown in a circle. The focus point may shift.

CENTER-WEIGHTED



This method considers the entire image field. The subject elements captured in the center will, however, impact on the calculation of the exposure value more so than areas around the edges.

MULTI-FIELD

This metering method is based on the detection of multiple values. These values are used in an algorithm to calculate an exposure value appropriate for a good rendering of the assumed main subject.

HIGHLIGHT-WEIGHTED

This method considers the entire image field. The exposure value will, however, be adjusted to very bright subject elements. That prevents the overexposure of bright subject elements without having to measure them individually. This metering method is particularly useful for objects that are significantly more brightly lit than the rest of the image (e.g. people in a spotlight), or that reflect the light significantly (e.g. white clothing).

Multi-field	Highlight-weighted
	
	
	



EXPOSURE MODES

The camera offers two exposure modes: aperture-priority mode or manual setting. Choose one of the two options depending on image object, situation or individual preference.

SELECTING A MODE

- ▶ Set the shutter-speed dial **A** (Aperture-priority) or select the desired shutter speed (Manual setting = **M**)

APERTURE-PRIORITY MODE- **A**

Aperture-priority mode sets the exposure automatically according to the manually selected aperture. This mode is suitable for shots in which the depth of field is a critical compositional element.

By selecting an appropriately low aperture value, you can reduce the depth of field range, for example to make a face “stand out” in sharp focus against an unimportant or distracting background for a portrait. Conversely, you can use a higher aperture value to increase the depth of field range, so that everything from the foreground to the background will be in full focus in a landscape shot.

- ▶ Select the operating mode **A** (see p. 107)
- ▶ Set the desired aperture value
 - The automatically selected shutter speed is displayed.
- ▶ Shutter release



Notes

- The resulting shutter speed is displayed in half increments for more transparency.
- The remaining exposure time after shutter release is counted down in seconds in the viewfinder for shutter speeds greater than 2 s. The actual calculated and steplessly controlled exposure time may vary from the exposure time displayed in half step increments: if e.g. the display shows **16** (the closest value) before shutter release, but the calculated exposure time is longer, then the countdown after shutter release can start from **19**.
- Under extreme lighting conditions and based on all the parameters, the exposure metering may generate a shutter speed that is outside the metering range, i.e. brightness values that would require shorter exposures than 1/4000 s or longer than 4 min. The camera will use the stated min. or max. shutter speeds and these values will flash as a warning in the viewfinder if that is the case.

MANUAL EXPOSURE SETTING – M

The following manual settings for shutter speed and aperture are a good choice:

- to create a special image mood that can only be achieved with a very specific type of exposure
- to ensure a perfectly identical exposure for multiple images with different cropped sections
- ▶ Set the desired shutter speed and aperture value
 - The shutter-speed dial must be clicked to one of the engraved exposure shutter speeds or to one of the intermediate values, or must be set in **B** to a user-defined time.
- ▶ Shutter release

AUXILIARY EXPOSURE DISPLAYS



DISPLAY IN THE VIEWFINDER

When the measuring range of the exposure meter is undercut in a manual setting and very low light density, then the triangular LED (▶) in the viewfinder on the left will flash as a warning; the LED on the right (◀) will flash when the measuring range of the exposure meter is surpassed. The shutter-speed icon will flash as a warning if a correct exposure cannot be achieved using the available shutter speeds in aperture-priority mode. The relevant icon will flash if the required shutter speed would undercut the fastest possible shutter speed or overshoot the longest possible shutter speed. As exposure metering is done with the working aperture, the same can be achieved by stopping down the lens.

▶	Underexposure by at least one aperture stop
▶●	Underexposure by a 1/2 aperture stop
●	Correct exposure
●◀	Overexposure by 1/2 aperture stop
◀	Overexposure by at least one aperture stop

DISPLAY ON THE LCD PANEL

Die exposure information (ISO value, shutter speed and light balance with exposure compensation scale) assists in determining the settings required for correct exposure.

 -3 -2 -1 0 +1 +2 +3	Correct exposure
 -3 -2 -1 0 +1 +2 +3	Underexposure or overexposure by the displayed value
 -3 -2 -1 0 +1 +2 +3	Underexposure or overexposure by more than +3 EV

Live View mode additionally offers the following assist functions for the exposure setting:

- Clipping (see p. 87)
- Histogram (see p. 89)
- Exposure Preview (see p. 114)





LONG-TERM EXPOSURE (B)

Leica M11-P offers shutter speeds up to 60 min. These can be used in several variations.

FIXED SHUTTER SPEEDS

This function can also be used to permanently set shutter speeds longer than 8 s.

- ▶ Set the shutter-speed dial to **B**
- ▶ Accessing the status screen
- ▶ Tap the control panel for the shutter speed setting

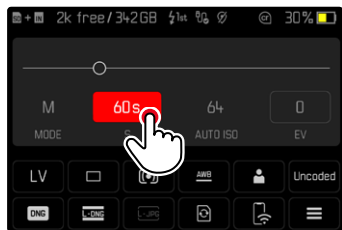

- The active control panel is highlighted in red.
- A setting band appears instead of the light balance. A dot marks the current setting. The current setting value is displayed above the dot.

- ▶ Tap the setting band briefly in the desired position, or drag the dot to the desired position

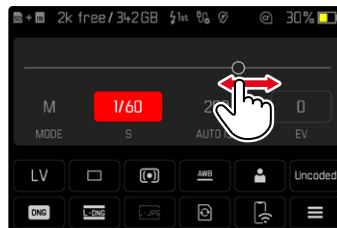

- ▶ Shutter release

B FUNCTION

In setting **B**, the shutter remains open as long as the shutter button is held down (up to max. 60 min depending on ISO setting).



- ▶ Set the shutter-speed dial to **B**
- ▶ Accessing the status screen
- ▶ Tap the control panel for the shutter speed setting
- ▶ Set exposure as **B**
- ▶ Shutter release

T FUNCTION

In this setting, the shutter remains open after shutter release until the shutter button is pressed again (up to max. 60 min depending on ISO setting).

This function can also be used in conjunction with the self-timer (see p. 120). The shutter remains open until the shutter button is tapped again. This prevents blurring in long-term exposures when the shutter button is pressed.

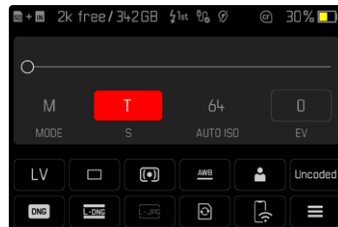

- ▶ Set the shutter-speed dial to **T**
- ▶ Accessing the status screen
- ▶ Tap the control panel for the shutter speed setting
- ▶ Set exposure as **T**





Taking a photo

- ▶ Shutter release
 - The shutter opens.
- ▶ Press the shutter button down fully
 - The shutter closes.

or

- ▶ Select **Self-timer 2 s**/**Self-timer 12 s**
- ▶ Shutter release
 - The shutter opens once the selected delay time has elapsed.
- ▶ Tap the shutter button
 - The shutter closes.

SELECTABLE SHUTTER SPEEDS

Max. selectable shutter speeds depend on the current ISO setting.

ISO range	Max. Shutter Speed
ISO 64 - ISO 125	60 min
ISO 160 - ISO 250	30 min
ISO 320 - ISO 500	15 min
ISO 640 - ISO 100	8 min
ISO 1250 - ISO 2000	4 min
ISO 2500 - ISO 4000	2 min
ISO 5000 - ISO 8000	60 s
ISO 10000 - ISO 16000	15 s
ISO 20000 - ISO 32000	8 s
ISO 40000 - ISO 50000	4 s

NOISE REDUCTION

Image noise becomes more apparent when using higher sensitivities, particularly on uniform dark areas. Long exposure times may cause severe image noise. In order to reduce this annoying phenomenon, the camera will take a second “dark frame” (taken with the shutter closed) automatically after a shooting with slow shutter speed and high ISO value. The noise metered in this parallel image is then digitally “subtracted” from the data for the actual image. In such cases the message **Noise reduction in progress...** will appear with a relevant time value. The doubling of the “exposure” time must be taken into account for long-term exposure times. The camera must not be switched off during that time.

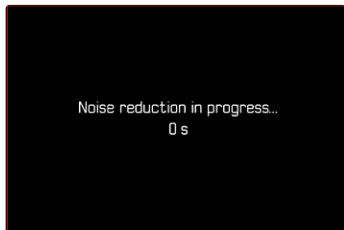

Noise Reduction is used if the following conditions apply:

ISO range	Shutter speed longer than
ISO 64 – ISO 125	160 s
ISO 160 – ISO 250	80 s
ISO 320 – ISO 500	40 s
ISO 640 – ISO 1000	20 s
ISO 1250 – ISO 2000	10 s
ISO 2500 – ISO 4000	6 s
ISO 5000 – ISO 8000	3 s
ISO 10000 – ISO 16000	1.5 s
ISO 20000 – ISO 32000	0.8 s

Noise Reduction can be optionally deactivated (see p. 77).





Notes

- In each of these cases, the exposure meter remains deactivated; after shutter release, however, the digital number display in the viewfinder counts the elapsed exposure time in seconds.
- Leica M cameras are very compact cameras that combine optical and electronic functions in a tiny installation space. It is therefore impossible to shield the sensor 100% against extraneous light. In dark environments, this will not have any negative effect – not even on long-term exposures of several minutes. Should, however, the camera be exposed to additional direct light during a long-term exposure, then light incidence may result in light spots on the sensor that will distort the image. This will occur typically in long-term exposures in daylight via an ND filter. In such cases we recommend protecting the camera from extraneous light. Ideally, that would be done with a dark cloth covering the entire camera and the lens mount.

EXPOSURE CONTROL

EXPOSURE PREVIEW

You can now assess the effect of the relevant exposure setting on the image before taking the photo. This will apply as long as the subject brightness and the set exposure don't result in excessively low or high brightness values.

There are two assessment methods available.

– **Shutter Button Half Pressed**

The brightness of the screen image mirrors the effects of the selected exposure settings when pressing and holding the shutter button on the first pressure point. This is displayed as . At all other times, the display in Live View shows an optimal exposure setting.

– **Permanent**

The brightness of the screen image always reflects the effects of the currently selected exposure settings. This is displayed as .

- ▶ Select **Capture Assistants** in the main menu
- ▶ Select **Exposure Preview**
- ▶ Select the desired setting
(**Off**, **Shutter Button Half Pressed**, **Permanent**)

Note

- Depending on ambient lighting conditions, the brightness of the screen image may differ from that of the actual images, despite the settings described above.

EXPOSURE LOCK

We often want to arrange important subject elements outside the center of the image for reasons of pictorial composition and these elements may sometimes be very bright or very dark. Center-weighted metering and spot metering, however, mainly capture an area in the center of the image and are calibrated to an average gray scale value.

In that case, the exposure lock initially allows a metering of the main subject, as well as storing of the relevant settings until the final image section is set.

- ▶ Aim at the key subject element (using the focus point) or alternatively at another detail with average brightness.
- ▶ Tap the shutter button
 - The measurement is taken and saved.
 - As long as the shutter button is held at the first pressure point, a small red dot will appear in the viewfinder at the top in the number line for confirmation, and the exposure time won't change, even if lighting conditions change.
- ▶ Pan the camera to capture the final image section while keeping the shutter button pressed
- ▶ Shutter release

Notes

- An exposure lock doesn't make much sense in conjunction with multi-field metering, because a targeted capture of an individual object element will not be possible.
- A change in the aperture setting after the exposure lock is set will not result in an adjustment of the shutter speed, i.e. the end result would be an incorrect exposure.

EXPOSURE COMPENSATION

Exposure meters are calibrated for a medium gray scale value, which matches a standard, i.e. average image object. Should the measured image detail not fulfill that requirement, then the a relevant exposure compensation can be effected.

Specifically where several shots are taken in sequence, for example if for a series a slightly lesser or greater exposure is desired for a particular reason, then exposure compensation can be a very useful function: Unlike with exposure lock, the setting remains active until it is reset.

Exposure compensation values can be set in the range ± 3 EV in $1/3$ EV increments (EV: Exposure Value).

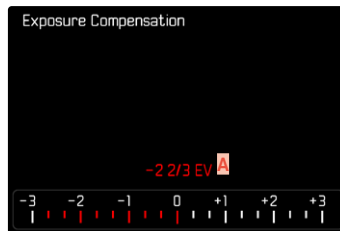

A Set compensation value (marks at 0 = Off)



Using thumbwheel control

- ▶ Select **Customize Control** in the main menu
 - ▶ Select **Customize Wheel**
 - ▶ Select **Exposure Compensation**
-
- ▶ Set the desired value using the thumbwheel

Using menu control

- ▶ Select **Exposure Compensation** in the main menu
 - A scale appears as a submenu item on the LCD panel.
- ▶ Set the value on the scale

Notes

- The following applies for set compensation values, no matter how they were initially set: They remain effective until they are manually reset to **0**, even if the camera is switched off and on again in the meantime. They can be reset using either menu control or the thumbwheel.
- In case of **A**, the compensation value is displayed in the viewfinder, for example **1.0-** (temporary display instead of the shutter speed). It will then be displayed as changed shutter speeds and a flashing dot at the bottom or as a value for about 0.5s, when the display is activated.
- The set exposure compensation is indicated by a mark on the exposure compensation scale in the footer line.

SHOOTING MODES

CONTINUOUS SHOOTING

The camera is set to single shots by default (**Single**). Series of shots can also be created to e.g. capture motion sequences at various stages.

- ▶ Select **Drive Mode** in the main menu
- ▶ Select the desired setting
(**Continuous - Low Speed**, **Continuous - High Speed**)

Once you have finalized your settings, the camera will do continuous shootings as long as you keep the shutter button pressed down fully (and you have sufficient space on your memory card).



Notes

- The specified framing speed stated in the technical information refers to a default setting (ISO 200, JPG format L-JPG). The picture sequence may differ in conjunction with other settings or depending on the picture content, **White Balance** setting and the memory card used.
- Regardless of how many frames were taken in a series, the last image in the series or the last image saved on the memory card while the saving process is ongoing will be displayed first in both review modes.
- Continuous shooting with **Continuous - High Speed** set are taken at a frequency of max. 4.5 fps, provided shutter speeds of 1/180s or faster are used.
- Continuous shooting is not possible if a flash is used. Only a single shot will be taken if the flash function is activated.
- Continuous shooting mode is not available in combination with the self-timer function.
- The buffer memory of the camera only allows a limited number of frames in series and in the selected exposure frequency. The exposure frequency is reduced, once the capacity limit of the camera's buffer memory is reached.

INTERVAL SHOOTING

This camera allows you to automatically capture motion sequences over extended periods of time using the interval shooting function. You specify the number of frames, the intervals between shots, and the start time of the series.

The exposure and focus settings are no different from those for normal images, but you should remember that the lighting conditions may change during the shooting.

SPECIFYING THE NUMBER OF FRAMES

- ▶ Select **Drive Mode** in the main menu
- ▶ Select **Interval Shooting**
- ▶ Select **Number of Frames**
- ▶ Enter the desired value

SPECIFYING THE INTERVALS BETWEEN SHOTS

- ▶ Select **Drive Mode** in the main menu
- ▶ Select **Interval Shooting**
- ▶ Select **Interval**
- ▶ Enter the desired value

SETTING THE DELAY TIME

- ▶ Select **Drive Mode** in the main menu
- ▶ Select **Interval Shooting**
- ▶ Select **Countdown**
- ▶ Enter the desired value

Getting started

- ▶ Press the shutter button
 - The remaining time until the next shoot and its number is displayed at the top right.

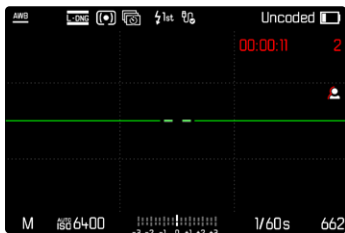

Cancelling a running series of shots

- ▶ Press the **PLAY** button
 - A small menu appears.

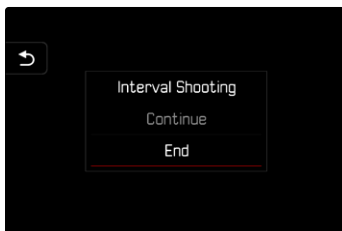

- ▶ Select **End**

Notes

- Interval shooting over an extended period of time in a cold location or in a place with high temperature and humidity may result in malfunctions.
- Interval shooting will be interrupted or canceled in the following situations:
 - if the battery is depleted
 - if the camera is switched offMake sure to check the battery for sufficient charge.
- The interval function remains active after the shoot, and also after the camera is switched off and on again, until another shooting mode (Drive Mode) is set.
- Availability of the interval function does not mean that the camera is suitable for use as a monitoring device.
- Regardless of how many frames were taken in a series, the last image in the series or the last image saved on the memory card while the saving process is ongoing will be displayed first in both review modes.
- We recommend deactivating Live View mode for longer interval or continuous shooting.
- The shots of an interval shooting are marked with  in review mode.

EXPOSURE BRACKETING

Many attractive objects are rich in contrast, which means they have very bright and very dark areas. The image effect can be dramatically different, depending on which of these areas you choose to align your exposure with. The automatic bracketing function in aperture-priority mode allows you to produce several alternatives with graduated exposure values and varying shutter speeds. You can then select the image you like best or use relevant photo editing software to calculate an image with a particularly broad contrast spectrum (HDR).

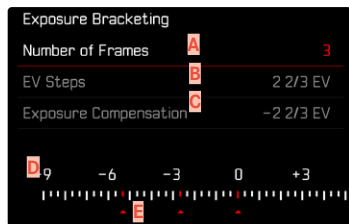

- A** Number of frames
- B** Exposure difference between shots
- C** Exposure compensation
- D** Light value scale
- E** Exposure values of the images marked in red
(The scale will be offset by the relevant value if exposure compensation is set concurrently.)

You can select the desired number of frames (3 or 5). The exposure difference, which can be set via **EV Steps**, can be up to 3EV.

- ▶ Select **Drive Mode** in the main menu
- ▶ Select **Exposure Bracketing**
- ▶ Select the desired number of frames under **Number of Frames** in the submenu
- ▶ Select the desired exposure offset under **EV Steps** in the submenu
- ▶ Select the desired **Exposure Compensation** value in the submenu
 - The marked exposure values change positions according to the settings selected. In the case of exposure compensation, the scale also shifts.
 - The selected exposure compensation value will be applied to the entire series of shots.
- ▶ Shutter release

Notes

-  appears on the LCD panel if the bracketing function is activated. You can watch the effect of the function on screen during shooting (brighter or darker).
- The sequence of shots: underexposure/correct exposure/overexposure.
- The working range for automatic bracketing may be limited depending on the available shutter speed/aperture combination.
- With automatic ISO sensitivity control enabled, the sensitivity calculated by the camera automatically for the raw files will also be applied to all other shots in the series, i.e. the ISO value will not change during bracketing. This may mean that the slowest shutter speed specified under **Shutter Speed Limit** is exceeded.
- The working range for automatic bracketing may be limited (depending on the originally set shutter speed). The specified numbers of frames will be taken regardless. Several shots in a series may consequently have the same exposure values.
- The function remains active until another function is selected from the **Drive Mode** submenu. If no other function is selected, another bracketing is taken each time the shutter button is pressed.

SELF-TIMER

The self-timer function allows shoot with a preset time delay. We recommend that the camera is placed on a tripod.



- ▶ Select **Self-timer** in the main menu
- ▶ Select **Self-timer 2 s**/**Self-timer 12 s**
- ▶ Shutter release
 - The remaining time until exposure is counted down on the LCD panel. The self-timer LED at the front of the camera counts down the delay time. It flashes slowly during the first 10 s, then fast for the last 2 s.
 - A running self-timer delay time can be canceled at any time by pressing the **MENU** button and restarted by pressing the shutter button.

Notes

- In self-timer mode, the exposure value is set just before shoot.
- The self-timer function is available only for single frame shooting and for bracketing.
- The function remains active until another function is selected from the **Drive Mode** submenu.

SPECIAL SHOOTING MODES

PERSPECTIVE CONTROL

This assist function displays a frame showing the expected cropped section of the image after a correction of the perspective of vertical falling lines. Perspective Control helps to achieve a generally straighter vertical line and straight horizon, which ensures a natural image effect, specifically in architectural images.

The function “Perspective Control” calculates the image section and the required distortion correction based on the actual panning angles of the camera and the lens used. In effect, the camera orientation during shooting (determined by internal camera sensors) is the decisive factor and not the lines visible in the image object. The function is therefore unlike automatic perspective control features used for post-editing, which are generally based on the image content.

The functionality depends on the image file format used (JPG or DNG). For JPG format images, the correction occurs directly in the camera and the corrected image is stored. For DNG format images, the relevant information is written to the meta data of the original image. Image correction is done later on using a program like Adobe Photoshop Lightroom® or Adobe Photoshop®*.

Factory setting: **Off**

Notes

- In case of large panning angles, the distortion correction needed for a complete perspective control would be too extreme. That is why this function is automatically skipped or only partially used where angles are too large. In that case, we recommend creating DNG format images and effecting the desired corrections in a post-editing step.
- The focal length of the camera lens must be known to use this function. It is automatically detected when M lenses with 6-bit encoding are used. The lens type must be entered manually when other lenses are used (**Lens Detection**).
- A histogram will not be available for technical reasons, while the function **Perspective Control** is active.
- The functions **Digital Zoom** and **Perspective Control** cannot be activated at the same time. Selecting one of these functions will automatically disable the other.



* See p. 123 for more information.



This function can only be used in Live View mode.

- ▶ You may have to activate Live View
- ▶ Select **Perspective Control** in the main menu
- ▶ Select **On**

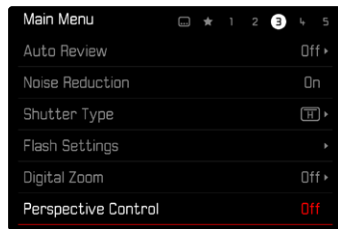

ACTIVE PERSPECTIVE CONTROL

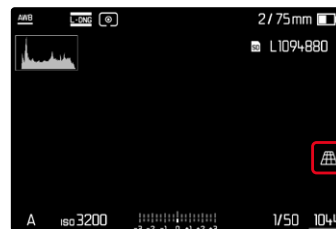

DETECTED PERSPECTIVE IN LIVE VIEW MODE



CORRECTED PERSPECTIVE IN REVIEW MODE





JPG FORMAT IMAGES

For JPG format images, the correction occurs directly in the camera and only the corrected image is stored. Any image content outside the frame will be lost.

DNG FORMAT IMAGES

In DNG format, the entire sensor image is stored unchanged. The data calculated by Perspective Control is written to the meta data of the image. Image correction is done later, using appropriate software like Adobe Photoshop Lightroom® or Adobe Photoshop®*. A corrected preview version of the image (thumbnail) is displayed in review mode. The same applies for automatic review directly after the image is taken.

However, when opening the file in Adobe Photoshop Lightroom® or Adobe Photoshop®, the original image will be displayed. Depending on the default settings of the software, the image can also be directly displayed with the corrections from the auxiliary frame.

PERSPECTIVE CONTROL IN ADOBE LIGHTROOM® AND ADOBE PHOTOSHOP®

Perspective Control can be done as part of the post-editing process for DNG format images using e.g. Adobe Photoshop Lightroom® or Adobe Photoshop®. Read the Adobe Online Help for more detailed information about the topic.

ADOBE LIGHTROOM®:

<https://helpx.adobe.com/en/lightroom-classic/help/guided-up-right-perspective-correction.html>

ADOBE PHOTOSHOP®:

<https://helpx.adobe.com/en/photoshop/using/perspective-warp.html>

CORRECTION AND DISPLAY OF AUXILIARY LINES

Select the function “With auxiliary lines” under “Geometry” > “Upright” to apply the correction defaults of the camera and display the auxiliary lines.

Correction will automatically be applied if the RAW default setting “Camera Settings” is selected.

Correction can be disabled under “Upright” at any time.

<https://helpx.adobe.com/en/photoshop/kb/acr-raw-defaults.html>

- ▶ Select “Camera Settings” as the RAW default setting



FLASH PHOTOGRAPHY

The camera determines the necessary flash intensity by firing one or more pre-flashes before taking the actual photo. The main flash fires immediately after, i.e. during exposure. All factors influencing exposure (e.g. filters, aperture settings, distance to the main subject, reflective ceilings, etc.) are automatically considered.

COMPATIBLE FLASH UNITS

The entire scope of functions described in this instruction manual, incl. TTL flash metering, is available only for Leica system flash units like the SF40. Other flash units, which only have a positive center contact, can be safely fired via the Leica M11-P, but cannot be controlled via the camera. Correct function cannot be guaranteed when using any other flash unit.

Note

- When using flash units that are not specifically designed for the camera and can therefore not automatically switch over the white balance of the camera should be used in the **zwb** flash setting.

Important

- The use of incompatible flash units with your Leica M11-P may result in irreparable damage to the camera and/or the flash unit.

Notes

- A flash unit that is not ready to flash may cause incorrect exposures or error messages.
- Studio flash systems may have a very long flash firing duration. It may therefore be advantageous to select a slower shutter speed than 1/180s when using such a system. The same applies for RF-controlled flash firing for so-called “off-camera” flashes, as the transmission time may cause a delay.
- Serial exposures and automatic bracketing with flash are not available.
- Use a tripod to prevent blurring at slow shutter speeds. Alternatively, you can select a higher sensitivity.



ATTACHING THE FLASH UNIT

- ▶ Switch off the camera and flash unit
- ▶ Slide the foot of the flash unit all the way into the accessory shoe and use the clamping nut (where available) to secure it against accidental movement
 - Movement inside the accessory shoe can interrupt required contacts and therefore cause malfunctions.

DETACHING THE FLASH UNIT

- ▶ Switch off the camera and flash unit
- ▶ Release the lock as needed
- ▶ Detach the flash unit

Note

- Make sure that the accessory shoe cover is always in place when no accessory is attached (e.g. a flash unit).

FLASH EXPOSURE METERING (TTL METERING)

In conjunction with system-compatible flash units (see p. 124), the camera offers a fully automated flash mode, which is also available in the exposure modes Aperture-Priority and Manual.

In aperture-priority mode and with manual setting, the camera furthermore allows the use of other interesting flash techniques like flash synchronization and firing with slower shutter speeds than the max. sync time.

The camera additionally communicates the sensitivity setting to the flash unit. The flash unit can use this information to automatically adjust its range data, provided the device comes with these displays and the aperture setting selected on the lens is also entered manually on the flash unit. The ISO sensitivity setting cannot be altered via the flash unit on system-compatible units, because the information is received from the camera.



SETTINGS ON THE FLASH UNIT

Operating mode	
TTL	Automatic control by the camera
A	SF40, SF 60: Automatic camera control, no flash exposure compensation SF 58, SF 64: Control via the flash unit using a built-in exposure sensor
M	The flash exposure must be set to an output level to match the aperture and shutter speed settings determined by the camera.

Notes

- Set the flash unit to **TTL** mode to allow automatic control of the unit by the camera.
- When set to **A**, objects with above or below average brightness may not be exposed correctly.
- Please read the relevant manual provided with third party flash units regarding their various operating modes.

HSS (HIGH SPEED SYNC.)

Automatic flash activation at **fast** shutter speeds

A fully automated, camera-controlled HSS flash mode for all shutter speeds and all exposure modes is available in the Leica M11-P for use with system-compatible flash units (see p. 124). It is activated by the camera automatically if the selected or calculated shutter speed is faster than the sync speed (1/180 s).



FLASH CONTROL

The settings and functions described in the following sections only apply to settings and functions available in this camera and in system-compatible flash units.

SYNC POINT

Flash exposures are lit by two light sources:

- existing light from the environment
- the additional flash

Any subject elements lit primarily by the flash will almost always be rendered in perfect focus by the short burst of light, provided the focus is set correctly. All other subject elements in the same frame lit by ambient light or lit from within will be rendered with varying degrees of sharpness. Whether or not these object elements will be rendered in sharp focus or blurred, as well as the degree of “blurriness” depends on two interdependent factors:

- the shutter speeds
- the speed of movement of the subject elements or camera during shooting

The longer the shutter speed and the faster the motion, the greater the difference between the two superimposed partial images.

A flash is usually fired at the start of exposure (**Start of Exposure**). This may result in apparent contradictions, e.g. the image of a vehicle being overtaken by its own light trail. This camera alternatively allows syncing with the end of exposure (**End of Exposure**). The sharp image will in this case be a rendering of the end of the captured motion. This flash technique creates a more natural impression of movement and dynamics in the image.

This function is available with all camera and flash unit settings.

Factory setting: **Start of Exposure**

- ▶ Select **Flash Settings** in the main menu
- ▶ Select **Flash Sync**
- ▶ Select the desired setting (**Start of Exposure**, **End of Exposure**)
 - The set sync point is shown in the header line.

Notes

- Do not use sync cables that are longer than 3 m.
- When using the flash with faster shutter speeds, a difference between the two flash firing points will be barely discernible or only noticeable for very fast movements.



FLASH RANGE

The usable flash range depends on the aperture and sensitivity values set manually or calculated by the camera. It is important to ensure that the subject is within the relevant flash range for sufficient illumination. A permanent setting to the shortest available shutter speed for flash mode (sync time) may often result in unnecessary underexposure of those subject elements that are not lit sufficiently by the flash.

This camera allows the fine tuning of the shutter speed used in flash mode in combination with aperture-priority mode depending on the conditions of the object or your own pictorial composition ideas.

Factory setting: **1/f s**

- ▶ Select **Flash Settings** in the main menu
- ▶ Select **Shutter Speed Limit (Flash)**
- ▶ Select the desired value
(**1/(4f) s**, **1/(2f) s**, **1/f s**, **1/250 s**, **1/125 s**, **1/60 s**, **1/30 s**, **1/15 s**, **1/8 s**, **1/4 s**, **1/2 s**)

Note

- The menu item **Shutter Speed Limit (Flash)** in submenu **Flash Settings** is identical to the menu item of the same name in submenu **Auto ISO Settings**. A setting in one menu will affect the other.

FLASH EXPOSURE COMPENSATION

This function can be used to selectively reduce or enhance flash exposure regardless of ambient light, e.g. to brighten the face of a person in the foreground when taking a photo outdoors in the evening while retaining the same general lighting mood.

Factory setting: **0 EV**

- ▶ Select **Flash Settings** in the main menu
- ▶ Select **Flash Exp. Compensation**
 - The submenu displays a scale with a red setting mark. The function is deactivated if the value is set to **0**.
- ▶ Set the value on the scale
 - The set value is displayed above the scale.



Notes

- The following applies for set compensation values, no matter how they were initially set: They remain effective until they are manually reset to 0, even if the camera is switched off and on again in the meantime.
- The menu item **Flash Exp. Compensation** can only be used in conjunction with flash units on which the compensation value cannot be set manually (e.g. Leica SF 26).
- **Flash Exp. Compensation** is unavailable, if flash units with an own compensation function are used (e.g. Leica SF 58 or Leica SF 60). A compensation value set on the camera would in that case have no effect.
- A brighter flash illumination with Plus compensation will require a greater flash intensity. Flash exposure compensation will therefore impact on the flash range: A Plus correction will decrease it, a Minus correction will increase it.
- An exposure compensation set on the camera will only affect the measurement of ambient light. If a simultaneous TTL flash exposure metering compensation is desired in flash mode, then it must be additionally set on the flash unit.

FLASH PHOTOGRAPHY

- ▶ Switch on the flash unit
- ▶ Set the desired guide number control mode (e.g. TTL or GNC = Guide Number Control) on the flash unit
- ▶ Switch the camera on
- ▶ Set the desired exposure mode, shutter speed and/or aperture setting
 - It is imperative to take note of the shortest flash sync speed, as it determines whether a “normal” flash or an HSS flash is fired.
- ▶ Tap the shutter button before each flash exposure to activate exposure metering
 - The flash unit may not fire if this step is missed by pressing the shutter button down completely and skipping these settings.

Note

- It is recommended to use a different exposure metering method than **Spot** in flash photography.





FLASH EXPOSURE DISPLAYS IN THE VIEWFINDER (with system-compatible flash units)

The flash icon in the viewfinder display of the Leica M11-P gives feedback on and indicates various operating states.

⚡ does not appear (despite the flash unit being switched on and ready)	<ul style="list-style-type: none">• The flash unit cannot fire• A correct operating mode must be set on the flash unit or an HSS-compatible flash unit must be connected
⚡ <u>flashes</u> slowly before shutter release (2 Hz)	<ul style="list-style-type: none">• The flash unit is not yet ready for use
⚡ <u>lights up permanently</u> before shutter release	<ul style="list-style-type: none">• The flash unit is ready for use
⚡ <u>remains continuously lit</u> after shutter release*	<ul style="list-style-type: none">• The flash is still ready
⚡ <u>flashes</u> rapidly after shutter release (4 Hz)*	<ul style="list-style-type: none">• Successful flash photography• The flash unit is not yet ready for further use
⚡ switches off after shutter release*	<ul style="list-style-type: none">• Flash intensity was insufficient

* only in TTL flash mode





REVIEW MODE

There are two completely independent review functions available:

- short-term rendering directly after shooting (**Auto Review**)
- normal review mode, in which the stored images can be viewed and managed for any length of time

Notes

- Recorded images are not automatically rotated in review mode to utilize the full screen area.
- It may not be possible to render files with this camera that were not recorded with this device.
- In some cases, the screen image may not have the expected quality, or the LCD panel will remain blank and only display the file name.
- You can toggle back from review mode to shooting mode at any time by tapping the shutter button.

CONTROL ELEMENTS IN REVIEW MODE

CONTROL ELEMENTS ON THE CAMERA

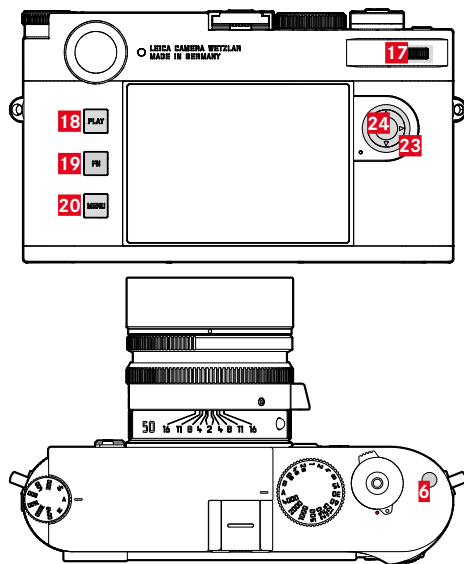

6 Function button

17 Thumbwheel
(turn or press)

18 **PLAY** button

19 **FN** button

20 **MENU** button

23 Directional pad

24 Center button

DIRECT ACCESS IN REVIEW MODE

The **FN** button can have various menu functions assigned in review mode.

Factory setting: **Delete Single**

- ▶ **Press and hold** the **FN** button
 - A list of functions of the play menu will appear.



- ▶ Select the desired function
 - The function is assigned to the **FN** button.

The descriptions in the next few sections presume factory settings.

Note

- The assigned function is unavailable if the **FN** button controls a control element on the screen (e.g. in the “Delete” screen).

CONTROL ELEMENTS ON THE LCD PANEL

On-screen control elements generally function by intuitively by touch. Many can also be selected by pressing one of the three buttons to the left of the LCD panel. A control element in the header is accompanied by an icon denoting the relevant button. A control element on the edge of the screen will be positioned directly next to the relevant button.

Example: The “Go back” icon  can be selected in one of two ways:

- tap on the “Go back” icon directly
- Press the relevant button (top button = **PLAY** button)



- A** Control element “Go back”
- B** Control element “Delete”
- C** Display of the relevant button

STARTING/EXITING REVIEW MODE

- ▶ Press the **PLAY** button
 - The last captured image appears on the screen.
 - The following message appears if the inserted memory card does not contain any image data: **No valid picture to play**.
 - The **PLAY** button function differs, depending on the current camera setting:

Initial situation	After pressing the PLAY button
Full screen display of an image	Shooting mode
Display of an enlarged cropped section/or several thumbnails	Full screen display of the image

SELECTING/SCROLLING THROUGH IMAGES

The images are visually arranged in a horizontal reel. When the end of an image series is reached, the display automatically jumps back to the first image in the series. All images can therefore be reached by scrolling either right or left.

Using touch control

- ▶ Swipe to the left or right

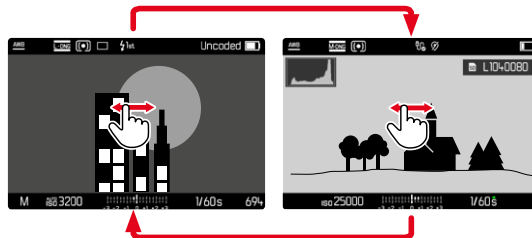

Using button control

- ▶ Press the directional pad left/right

Notes

- Only files from one storage location are considered during scrolling.
- The files on the SD card and those stored in the internal memory will never appear in the same view.
- Menu items like **Delete All** or **Remove all ★** generally only apply to files located in the currently selected storage location.

STORAGE LOCATIONS

Leica M11-P offers with two separate storage locations.

When review mode is accessed, the last captured image will always be displayed first. That also applies on the storage location displayed first.

When scrolling through images and also in the overview, the images saved to the same storage location are available first.

Switching the displayed storage location

- ▶ Reduce the view as much as possible (see p. 138)
 - The storage location selection view appears.
 - The currently selected storage location is displayed with a color fill.



- ▶ Press the directional pad left/right
 - The newly selected storage location appears with a color frame.
- ▶ Press the center button
- ▶ Re-enlarge the view

INFO DISPLAYS IN REVIEW MODE

For undisturbed viewing, images appears without the information in header and footer in the factory default setting.



The configured displays can be accessed at any time. The displays for **Histogram** and **Clipping** will appear if these functions are activated. The assist functions **Focus Peaking**, **Grids**, and **Level Gauge** are not displayed in review mode.

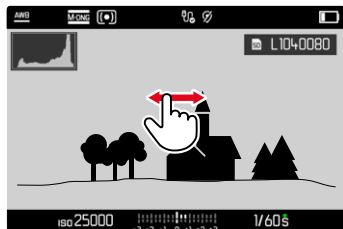



Using touch control

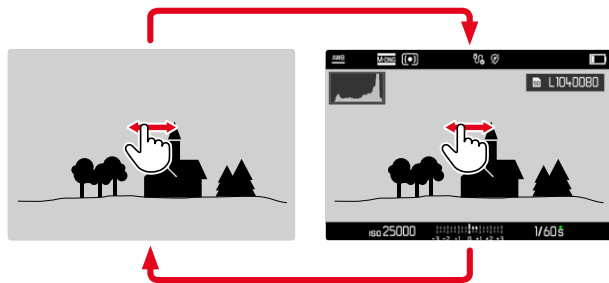

- ▶ Tap anywhere on the LCD panel

Using button control

- ▶ Press the center button

Note

- The histogram and clipping displays always refer to the currently shown image section.

CROPPED SECTION ZOOM

You can zoom in to any section of an image for closer inspection. You have a four-level zoom factor available via the thumbwheel, while magnification is stepless if you use touch control.

Using touch control

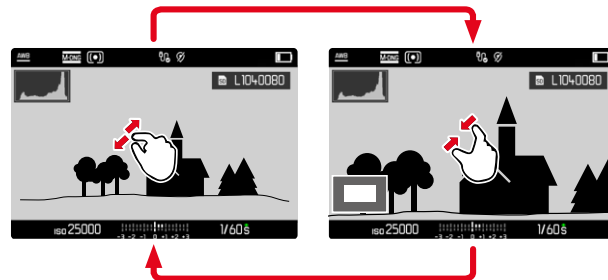

- ▶ Two-finger pinch/spread
 - The image will be zoomed in/zoomed out at the desired point.

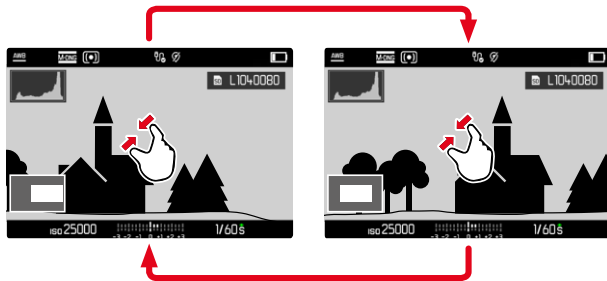

- ▶ Move the position of an enlarged cropped section by swiping
 - The rectangle in the frame in the bottom left corner shows the current level of magnification, as well as the position of the displayed section within the image.

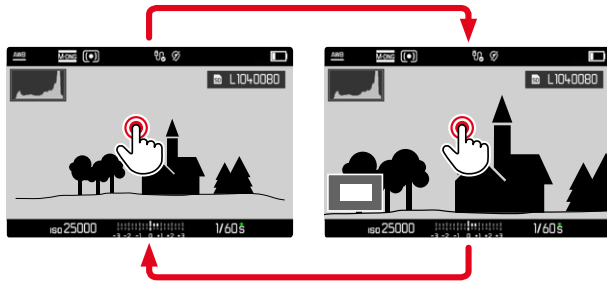

- ▶ Double tap
 - Toggles between max. zoom at the tap position and full screen view.

Using button control

- ▶ Turn the thumbwheel
(to the right: increase magnification, to the left: decrease magnification)
- or
- ▶ Press the thumbwheel
 - Toggles between max. zoom at the tap position and full screen view.
- ▶ Press the directional pad to move the enlarged section anywhere in the image
 - The rectangle in the frame in the bottom left corner shows the current level of magnification, as well as the position of the displayed section within the image.

You can move directly from one image to the next in magnification mode, which will then also be displayed with the same magnification.

- ▶ Press and hold the **PLAY** button while pressing the directional pad left/right
- or
- ▶ Press and hold the **PLAY** button while turning the thumbwheel

Note

- It may not be possible to enlarge images taken with other camera types.





DISPLAYING MULTIPLE IMAGES AT ONCE

The camera offers an overview function in which several thumbnail images can be viewed on one screen, which makes it easier to find a specific image. You can choose 12 or 30 images per overview.

OVERVIEW

Using touch control

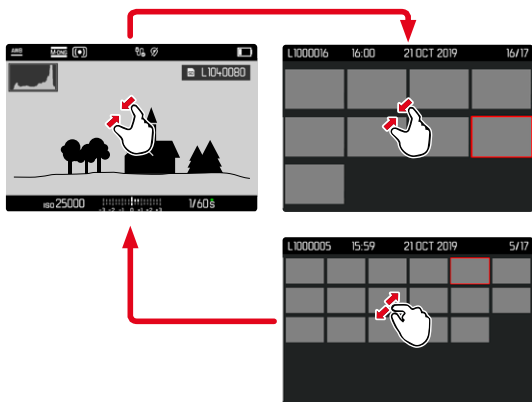

- ▶ Two-finger pinch
 - The display toggles from 12 to 30 thumbnails.

Viewing other images

- ▶ Swipe up or down

Using button control

- ▶ Turn the thumbwheel to the left
 - 12 thumbnails are shown at the same time. Another turn on the thumbwheel increases the number of displayed thumbnails to 30.

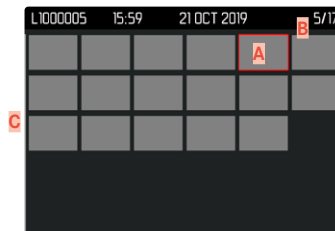
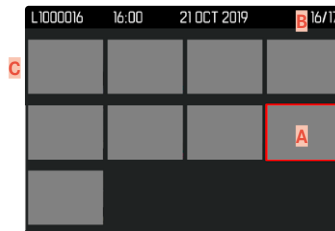

- A** Currently selected image
- B** Number of the currently selected images
- C** Scrollbar

The currently viewed image is framed in red and can be selected for a closer look.

Navigating between images

- ▶ Press the directional pad in the relevant direction

Returning to full screen

Using touch control

- ▶ Two-finger spread
- or
- ▶ Tap the desired image

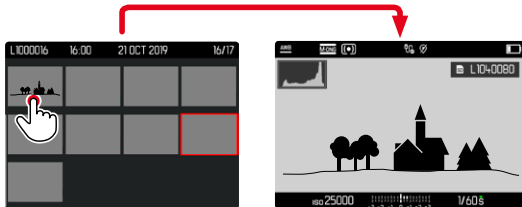

Using button control

- ▶ Turn the thumbwheel to the right
- or
- ▶ Press the **PLAY** button or center button

TAGGING/RATING OF IMAGES

Images can be marked as favorites to find them quicker or to simplify the later deletion of multiple images.

Notes

- Other images can be selected while the Play menu is active.
- You can exit the Play menu at any time by pressing the **MENU** button.

TAGGING INDIVIDUAL IMAGE AS FAVORITE

- ▶ Press the function button **6**
 - The image is marked with ★.

or

- ▶ Press the **MENU** button
- ▶ Select **Add ★**
 - The image is marked with ★.

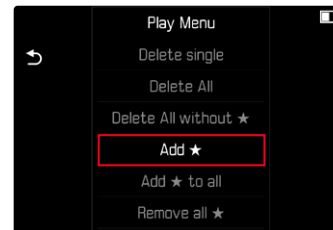

The icon appears in the right of the image when viewing an image in normal size, and in the top left corner of thumbnails in the overview.



REMOVING INDIVIDUAL TAGS

- ▶ Press the function button **6**
 - The ★ marking disappears.

or

- ▶ Press the **MENU** button
- ▶ Select **Remove ★**

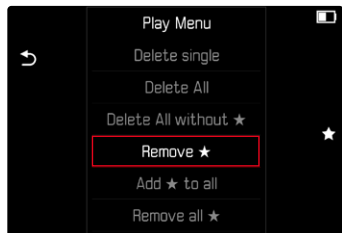

TAGGING ALL IMAGES AS FAVORITE

- ▶ Press the **MENU** button
- ▶ Select **Add ★ to all**

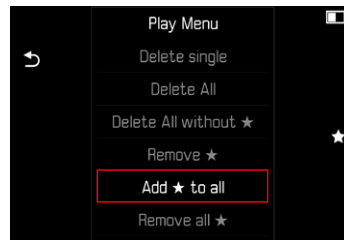

- The prompt appears.
- ▶ Select **Yes**
 - The LED will flash during this operation.

REMOVING ALL TAGS

- ▶ Press the **MENU** button
- ▶ Select **Remove all ★**

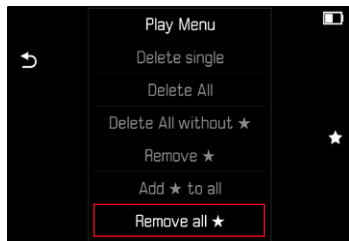

- The prompt appears.
- ▶ Select **Yes**
- The LED will flash during this operation.

DELETING IMAGES

There are several methods available to delete images:

- deleting individual images
- deleting multiple images
- deleting all images without a icon/ranking
- deleting all images

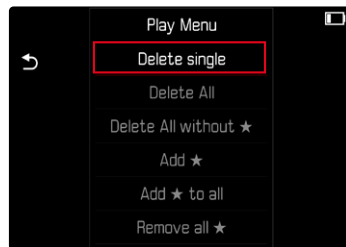

Important

- Once deleted, images are no longer retrievable.

Notes

- Other images can be selected while the Play menu is active.
- You can exit the Play menu at any time by pressing the **MENU** button.







DELETING INDIVIDUAL IMAGES

- ▶ Press the **MENU** button
- ▶ Select **Delete Single** in the play menu
 - The Delete screen appears.



- ▶ Select the Delete icon 
(tap the icon directly or press the **FN** button)
 - The LED will flash during the delete process. The process may take a few seconds.
 - The next image will be displayed once deletion is complete. The following message appears if no other images are saved on the card: **No valid picture to play.**

Cancelling a deletion and returning to normal review mode

- ▶ Select the “Go back” icon 
(tap the icon directly or press the **PLAY** button)

Note

- The “Scroll” and “Magnify” functions continue to be available when the “Delete” screen is active.

DELETING MULTIPLE IMAGES

Several images can be marked in a Delete overview with twelve thumbnails and can then be deleted all at once. This overview can be reached in two ways.

- ▶ Turn the thumbwheel to the left
 - The overview screen appears.
- ▶ Press the **MENU** button
- ▶ Select **Delete Multi** in the play menu
 - The Delete overview appears.

or

- ▶ Press the **MENU** button
- ▶ Select **Delete Single** in the play menu
 - The Delete screen appears.
- ▶ Turn the thumbwheel to the left
 - The Delete overview appears.



Any number of images can be selected in this view.

Selecting images for deletion

- ▶ Select an image
- ▶ Press the center button

or

- ▶ Tap the desired image
 - The images selected for deletion are marked with a red Delete icon .

Deleting the selected images

- ▶ Select the Delete icon 
(tap the icon directly or press the **FN** button)
 - The prompt `Do you really want to delete ALL selected files?` appears.
- ▶ Select **Yes**

Cancelling a deletion and returning to normal review mode

- ▶ Select the “Go back” icon 
(tap the icon directly or press the **PLAY** button)

DELETING ALL IMAGES

- ▶ Press the **MENU** button
- ▶ Select **Delete All** in the play menu



- The prompt appears.
- ▶ Select **Yes**

Note

- The message `No valid picture to play.` appears after successful deletion. The same image is displayed again if deletion was unsuccessful. When deleting several or all images, a notification screen may appear for the time needed to process the data.





DELETING UNRATED IMAGES

- ▶ Press the **MENU** button
- ▶ Select **Delete All without ★** in the play menu

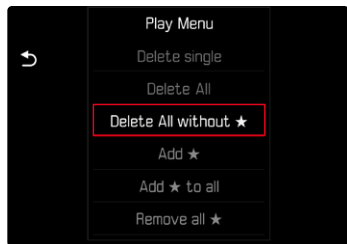

- The prompt appears.
- ▶ Select **Yes**
 - The LED will flash during the deletion process. The process may take a few seconds. The next marked image appears once deletion is complete. The message **No valid picture to play** appears if no other images are saved on the card.

PREVIEW OF LATEST IMAGE

Photos can be displayed automatically directly after they are taken to e.g. check the success of the shots quickly and easily. A duration for the automatic display can be configured.

- ▶ Select **Auto Review** in the main menu
- ▶ Select the desired function or duration in the submenu (**Off**, **1 s**, **3 s**, **5 s**, **Permanent**, **Shutter Button Pressed**)

Permanent: The most recent frame is displayed until automatic review is ended by pressing the **PLAY** button or by tapping the shutter button.

Shutter Button Pressed: The most recent frame is displayed for as long as the shutter button is pressed down.

Notes

- Various control elements change back to regular review mode to execute their normal functions while automatic review is selected. The camera will remain in review mode until it is exited.
- Marking and deleting can only be done in regular review mode and not during automatic review.
- When shooting with the Continuous Shooting or Interval Shooting functions, then the last image in the series will be displayed or – if the save process is still incomplete – the last image in the series saved to the memory card.
- Where display times were configured (**1 s**, **3 s**, **5 s**) automatic review can be ended immediately by pressing the **PLAY** button or tapping the shutter button.





OTHER FUNCTIONS

RESETTING THE CAMERA TO FACTORY SETTINGS

This function allows you to reset all your custom menu settings back to the factory settings. You can optionally exclude the user profiles and image numbering from the reset individually.

- ▶ Select **Reset Camera** in the main menu
 - The prompt **Do you want to reset the camera settings?** appears.
- ▶ Confirm or reject the reset to factory settings **(Yes)** / **(No)**
 - Selecting **No** will cancel the reset and the display will return to the main menu. Selecting **Yes** will trigger additional prompts regarding the settings you can opt to keep.
- ▶ Confirm or reject the reset of the user profiles **(Yes)** / **(No)**
- ▶ Confirm or reject the reset of the image numbering **(Yes)**/**(No)**
 - The message **Please Restart the Camera** appears.
- ▶ Switch the camera off and on again

Notes

- Date & time, as well as the preferred language will have to be set up again after a reset. Relevant prompts will appear on screen.
- You reset the image numbering separately via the menu item **Reset Image Numbering** (see p. 146).

FIRMWARE UPDATES

Leica is continuously working on the further improvement and optimization of your camera. Since many camera functions are entirely controlled by software, some of these improvements and additions to the functional scope can be installed in retrospect. Leica offers firmware updates at irregular intervals, which you can download from our website.

Leica will notify you of any new updates, once you have registered your camera. Users of Leica FOTOS will also be automatically notified about firmware updates for their Leica cameras.

There are two options for installing firmware updates.

- conveniently via the Leica FOTOS app (see p. 150)
- directly via the camera menu

Finding the currently installed firmware version

- ▶ Select **Camera Information** in the main menu
 - The current firmware version is displayed next to the menu item **Camera Firmware Version**.

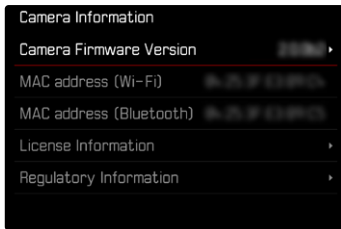

More information about registering, firmware updates and how to download them to your camera, as well as any amendments and additions to this manual can be found in the customer area of our website at: <https://club.leica-camera.com>

EXECUTING A FIRMWARE UPDATE

Any interruption of a running firmware update may cause serious and irreparable damage to your equipment!

You will therefore have to take particular note of the following, when carrying out a firmware update:

- Do not switch off the camera!
- Do not remove the memory card!
- Do not remove the rechargeable battery!
- Do not detach the lens!

Notes

- A warning message will appear if the battery is insufficiently charged. Recharge the battery and then repeat the process described above.
- You will find additional device and country-specific registration marks and numbers in the **Camera Information** submenu.





PREPARATION

- ▶ Fully charge and insert the rechargeable battery
- ▶ Any stored firmware files on the memory card must be removed
 - We recommend saving any images on the memory card and reformatting it before the update.
(Caution: Loss of data! **All** data stored on the memory card will be lost during formatting.)
 - Make sure to back up any files saved to the internal memory as a precaution.
- ▶ Download the latest firmware version
- ▶ Save the download to the memory card
 - The firmware file must be stored in the main directory of the memory card (not in a sub-directory).
- ▶ Insert the memory card into the camera
- ▶ Switch the camera on

UPDATING THE CAMERA FIRMWARE

- ▶ Preparation
- ▶ Select **Camera Information** in the main menu
- ▶ Select **Camera Firmware Version**
- ▶ Select **Firmware Update**
 - A prompt with information about the camera is displayed.
- ▶ Check the version information
- ▶ Select **Yes**
 - The prompt **Do you want to save profiles on SD card?** appears.
- ▶ Select **Yes/No**
 - The update will start automatically.
 - The lower status LED will flash during this process.
 - Once the process has completed successfully, a relevant message will appear and the camera will restart.





LEICA FOTOS

The camera can be controlled remotely using a smartphone/tablet PC. This will require an installation of the Leica FOTOS app on the mobile device. Leica FOTOS offers additional useful functions like the quick transfer of recordings and uploads of firmware updates. Please read the legal notes on page 7.

- ▶ Scan the following QR code with the mobile device



or

- ▶ The app is available from Apple App Store™/Google Play Store™

SELECTING A WI-FI BAND

Leica M11-P supports the use of various Wi-Fi frequencies in a number of regions.

- ▶ Select **Camera Settings** in the main menu
- ▶ Select **Wi-Fi band**
- ▶ Select the desired setting

Note

- The menu item will appear grayed out, where this option is unavailable.

CONNECTIVITY (iPhone users)

FIRST-TIME CONNECTION TO A MOBILE DEVICE

A pairing of the camera and the mobile device is required for a first-time connection to a mobile device. A connection is established via the connection wizard at initial setup of the camera or later via the menu.

CONNECTION WIZARD

The connection wizard appears at initial startup of the camera or after a camera reset. These settings are also available via the menu item **Leica FOTOS**.

The following screen appears after you have selected the language.

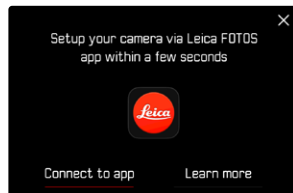

Starting the connection wizard

- ▶ Select **Connect to app**

Exiting the connection wizard

- ▶ Tap the icon in the top right corner of the screen

Going back one step

- ▶ Tap the icon in the top left corner of the screen

VIA LEICA FOTOS CABLE (for iPhone only)

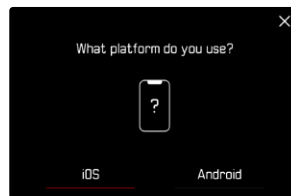

- ▶ Select **iOS**
 - The following screen appears.

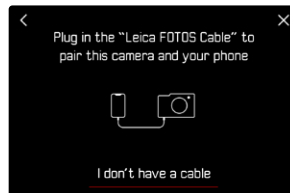

- ▶ Connect the camera and mobile device via the Leica FOTOS cable
- ▶ Follow the instructions provided by the Leica FOTOS app

VIA WI-FI

IN THE CAMERA

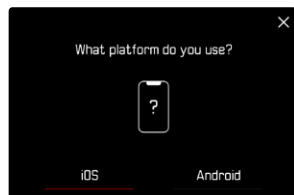

- ▶ Select **iOS**
 - The following screen appears.



- ▶ Select **I don't have a cable**
- ▶ Select **Next**
- ▶ Wait until the QR code appears on the LCD panel

ON THE MOBILE DEVICE

- ▶ Launch the Leica FOTOS app
- ▶ Select “Add Camera”
- ▶ Select the camera model
- ▶ Select “Scan the QR code”
- ▶ Scan the QR code
 - Connection is being established. The process may take a few seconds.
 - Once successfully connected, the Status LED will light briefly, and the camera displays a relevant message.



USING THE MENU TO

Where the connection wizard was not used or other mobile devices should be connected, the same settings are always accessible via the menu item **Leica FOTOS**.

IN THE CAMERA

- ▶ Select **Leica FOTOS** in the main menu
- ▶ Select **Pairing**
- ▶ Wait until the QR code appears on the LCD panel

ON THE MOBILE DEVICE

- ▶ Launch the Leica FOTOS app
- ▶ Select “Add Camera”
- ▶ Select the camera model
- ▶ Select “Scan the QR code”
- ▶ Scan the QR code
 - Connection is being established. The process may take a few seconds.
 - Once successfully connected, the Status LED will light briefly, and the camera displays a relevant message.

Notes

- The pairing process may take a few minutes to complete.
- Each mobile device only needs to be paired with the camera once. The process adds the device to the list of known devices.
- The Bluetooth function is disabled if the connectivity mode **Off** is selected (see p. 156). **Pairing** will not be available, and the relevant menu item will be grayed out.

CONNECTING WITH PAIRED DEVICES

VIA LEICA FOTOS CABLE (for iPhone only)

The Leica FOTOS Cable makes connectivity particularly easy and quick.

- ▶ Connect the camera and mobile device via the Leica FOTOS cable
 - The connection is established automatically.

VIA WI-FI

IN THE CAMERA

- ▶ Select **Leica FOTOS** in the main menu
- ▶ Select **Connectivity**
- ▶ Select **Performance Mode** or **Eco Mode**

ON THE MOBILE DEVICE

- ▶ Launch the Leica FOTOS app
- ▶ Select the camera model
- ▶ Confirm the prompt
 - The camera connects to the mobile device automatically.



CONNECTIVITY (Android users)

FIRST-TIME CONNECTION TO A MOBILE DEVICE

The connection is established via WLAN. A pairing of the camera and the mobile device is required for a first-time connection to a mobile device. A connection is established via the connection wizard at initial setup of the camera or later via the menu.

CONNECTION WIZARD

The connection wizard appears at initial startup of the camera or after a camera reset. These settings are also available via the menu item **Leica FOTOS**.

The following screen appears after you have selected the language.

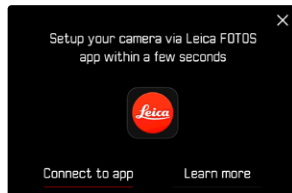

Starting the connection wizard

- ▶ Select **Connect to app**

Exiting the connection wizard

- ▶ Tap the icon in the top right corner of the screen

Going back one step

- ▶ Tap the icon in the top left corner of the screen

IN THE CAMERA

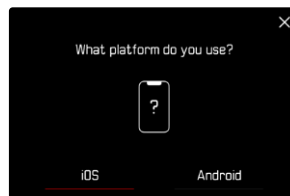

- ▶ Select **Android**
- ▶ Select **Next**
- ▶ Wait until the QR code appears on the LCD panel

ON THE MOBILE DEVICE

- ▶ Launch the Leica FOTOS app
- ▶ Select “Add Camera”
- ▶ Select the camera model
- ▶ Select “Scan the QR code”
- ▶ Scan the QR code
 - Connection is being established. The process may take a few seconds.
 - Once successfully connected, the Status LED will light briefly, and the camera displays a relevant message.

USING THE MENU TO

Where the connection wizard was not used or other mobile devices should be connected, the same settings are always accessible via the menu item **Leica FOTOS**.

IN THE CAMERA

- ▶ Select **Leica FOTOS** in the main menu
- ▶ Select **Pairing**
- ▶ Wait until the QR code appears on the LCD panel

ON THE MOBILE DEVICE

- ▶ Launch the Leica FOTOS app
- ▶ Select “Add Camera”
- ▶ Select the camera model
- ▶ Select “Scan the QR code”
- ▶ Scan the QR code
 - Connection is being established. The process may take a few seconds.
 - Once successfully connected, the Status LED will light briefly, and the camera displays a relevant message.

Notes

- The pairing process may take a few minutes to complete.
- Each mobile device only needs to be paired with the camera once. The process adds the device to the list of known devices.
- The Bluetooth function is disabled if the connectivity mode **Off** is selected (see p. 156). **Pairing** will not be available, and the relevant menu item will be grayed out.

CONNECTING WITH PAIRED DEVICES

IN THE CAMERA

- ▶ Select **Leica FOTOS** in the main menu
- ▶ Select **Connectivity**
- ▶ Select **Performance Mode** or **Eco Mode**

ON THE MOBILE DEVICE

- ▶ Launch the Leica FOTOS app
- ▶ Select the camera model
- ▶ Confirm the prompt
 - The camera connects to the mobile device automatically.





CONNECTIVITY MODES

Three connection options are available.

Factory setting: Performance Mode

- ▶ Select Leica FOTOS in the main menu
- ▶ Select Connectivity
- ▶ Select Performance Mode/Eco Mode/Off

	Faster connection (Factory setting)	Extended battery life	All RF connections deactivated
	Performance Mode	Eco Mode	Off
Bluetooth (Geotagging)	On	On	-
Wi-Fi (Data transfer) (Remote control)	Always On The connection to the Leica FOTOS app is permanently active	Automatic On/Off The connection to the Leica FOTOS app is established automatically as needed, and disconnected after ≥ 5 min. of inactivity	-
Wi-Fi Sleep Timer	Never	After 5 min	-
Remote Camera Activation	Always available	This function is available up to 7 days after the camera was switched off	-



PERFORMANCE MODE

Bluetooth is permanently activated, allowing anytime Geotagging (where enabled). Wi-Fi is similarly permanently activated. This option offers the fastest access to Leica FOTOS and therefore an excellent user experience.

- ▶ Select **Leica FOTOS** in the main menu
- ▶ Select **Connectivity**
- ▶ Select **Performance Mode**

ECO MODE

Bluetooth is permanently activated, allowing anytime Geotagging (where enabled). Camera Wi-Fi will be enabled only during the transfer of settings or files, and will otherwise remain off. This is a power saving option.

- ▶ Select **Leica FOTOS** in the main menu
- ▶ Select **Connectivity**
- ▶ Select **Eco Mode**

AIRPLANE MODE (Off)

All RF connections will be deactivated if this option is selected

- ▶ Select **Leica FOTOS** in the main menu
- ▶ Select **Connectivity**
- ▶ Select **Off**

EXECUTING A FIRMWARE UPDATE

Any interruption of a running firmware update may cause serious and irreparable damage to your equipment!

You will therefore have to take particular note of the following, when carrying out a firmware update:

- Do not switch off the camera!
- Do not remove the memory card!
- Do not remove the rechargeable battery!
- Do not detach the lens!

Leica FOTOS will notify you when firmware updates are available for your Leica cameras.

- ▶ Follow the instructions provided by the Leica FOTOS app

Notes

- A warning message will appear if the battery is insufficiently charged. Recharge the battery and then repeat the process described above.
- Alternatively, firmware updates can also be installed via the camera menu.



REMOTE CAMERA CONTROL

You can take pictures and record video remotely via the mobile device, and can also change image settings or transfer data to the mobile device. A list of available functions and instructions for their use can be found in the Leica FOTOS app.

REMOTE CAMERA ACTIVATION

The camera can be activated remotely from off or standby if this function is activated in the camera. The Bluetooth function must be active.

- ▶ Select **Leica FOTOS** in the main menu
- ▶ Select **Connectivity**
- ▶ Select **Performance Mode/Eco Mode**
 - The camera will scan for known devices and automatically establishes a connection.

Important information

- Remote activation will activate the camera even if it was switched off via the main switch.
- Accidental remote camera activation may result in unwanted pictures taken and excessive power consumption.
- A third-party device can – provided it has been paired with the camera – access the camera remotely if your own mobile device is not currently connected or its Bluetooth function is deactivated. This poses a danger of unauthorized access to your data or camera functions.

Solution

- Only activate this function just before you want to use it.
- Disable the function as soon as it is no longer needed.



CARE/STORAGE

We recommend the following if the camera will not be used for an extended period of time:

- Switch off the camera
- Remove the memory card
- Remove the battery (after approx. 2 months the set date and time will be lost)

CAMERA HOUSING

- Keep your equipment meticulously clean, as any kind of dirt residue presents a breeding ground for micro organisms.
- Only clean the camera with a soft, dry cloth. Stubborn dirt should first be moistened with a watered-down detergent and can then be wiped away with a dry cloth.
- Wet a soft cloth with tap water, wring it out thoroughly and use it to wipe down the camera. Then wipe it down thoroughly with a dry cloth.
- Wipe the camera with a clean, lint-free cloth to remove stains and fingerprints. Tougher dirt is hard to reach corners of the camera housing can be removed with a small brush. Take care not to touch the shutter blades.
- Store the camera in a closed and padded container to prevent friction damage and protect it against dust accumulation.
- Keep the camera in a dry, sufficiently ventilated place, where it will not be subjected to high temperatures and humidity. Make sure to remove all moisture from the camera if it was used in humid conditions.
- Do not store the camera in a leather case for extended periods of time to prevent fungal contamination.

- Empty your camera bag completely if it ever gets wet during use. Your equipment might otherwise be subjected to moisture and tanning residue released by the moist leather.
- All mechanical bearings and sliding surfaces on your camera are lubricated. Remember to press the shutter button several times every three months to prevent the lubrication points hardening if the camera will not be used for an extended period of time. We also recommend repeated adjustment and use of all the other operating elements.
- When using your camera in tropical climates, make sure to expose the equipment to daylight and fresh air as much as possible to prevent fungal growth. Storage in airtight containers or cases is recommended only in conjunction with a desiccant like silica gel.

LENS

- A soft-bristle brush will usually suffice to remove dust from the outer lenses. Remove more severe soiling with a clean, soft cloth that is completely free of foreign matter. Wipe the lens in a circular motion from the center outward. We recommend using micro-fiber cloths that come in a protective container and are available from photography shops and other optical retailers. These cloths are machine-washable at 40°C. Do not use fabric softener and do not iron them. Never use spectacle lens cleaning cloths, as these are soaked in chemicals, which could damage the glass of the camera lenses.
- Attach a transparent UVA filter for optimal front lens protection in unfavorable conditions (e.g. sand, salt water spray). Please remember that the filter may create unwanted light reflections in some backlight situations and in case of high contrasts.
- Lens caps also protect the lens against accidental fingerprint smudges and rain.

- All mechanical bearings and sliding surfaces on your lens are lubricated. Make sure to periodically move the focus ring and the aperture ring to prevent seizing if the lens will not be used for an extended period of time.
- Make sure not to apply too much lubricant to the bayonet and take particular care not to apply grease to the 6-bit encoding. Too much lubricant will result in grease residue lodging in the gap, where dirt will then accumulate. The legibility of the code will be impacted, which may cause malfunctions in digital M models.
- We recommend formatting memory cards from time to time, as fragmented residual data from deleted files may block some of the storage capacity.

VIEWFINDER/LCD PANEL

- Switch off your camera and leave it to stand at room temperature for around 1 hour if condensation has formed on or in the camera. The condensation will disappear, once the camera temperature has reached room temperature.

RECHARGEABLE BATTERY

- Lithium-ion rechargeable batteries should only be stored partially charged, i.e. not fully depleted or fully charged. The camera LCD panel will show the current charge level of the battery. Charge the battery twice a year for around 15 minutes to avoid deep discharge in case of very long storage periods.

MEMORY CARDS

- Make sure to store memory cards in their anti-static container when not in use.
- Do not store memory cards where they will be exposed to high temperatures, direct sunlight, magnetic fields or static electricity. Always remove the memory card if the camera will not be used for an extended period of time.



SENSOR

SENSOR CLEANING

Alternatively, send your camera to the Leica Customer Care department for sensor cleaning (see p. 186). This service is not part of the warranty offering and will therefore incur charges.

Note

- Leica Camera AG will not accept any responsibility for damage caused by the user when cleaning the sensor.

- ▶ Select **Camera Settings** in the main menu
- ▶ Select **Sensor Cleaning**
 - The prompt **Do you want to start the sensor cleaning?** appears.
- ▶ Select **Yes/No**
 - The battery capacity must be at least 60% for the shutter to open.
 - A warning message **Battery low for sensor cleaning** will appear if the battery capacity is lower to indicate that the function is currently not available and **Yes** cannot be selected.
- ▶ Clean the sensor
 - Make sure you follow the instructions below.
- ▶ Switch off the camera after you finish cleaning
 - The following message appears:
Please stop sensor cleaning immediately. Shutdown in %d s.
 - The shutter will remain open for another 10s.

Important

- Any inspection or cleaning of the sensor should be done in an environment that is as much as possible dust-free to prevent further contamination.
- A message will appear on the LCD panel, once the capacity of the rechargeable battery falls below 40% with the shutter fully open: `Please stop sensor cleaning immediately. Shutdown in %d s.` The shutter will automatically close when the camera is switched off.
- Make sure that the aperture is unobstructed and that nothing can prevent the shutter from closing correctly, as this would result in damage to the equipment!
- Do not attempt to physically blow dust particles off the cover glass of the sensor. The smallest droplets of saliva could cause stains that will be difficult to remove.
- Do not use high pressure compressed air cleaners as they may also cause damage.
- Avoid touching the sensor surface with any hard object during inspection and cleaning.

Important

All mentions of “EVF” or “Electronic Viewfinder” in this manual refer to the optional accessory Leica Visoflex **2**.

Using the older “Leica Visoflex” model with the Leica M11-P can – as a worst case scenario – result in irreparable damage to the camera and/or the Visoflex. Please contact Leica Customer Care if in doubt.

Problem	Possible causes to check	Troubleshooting suggestions
Battery issues		
Battery is depleted too quickly	Battery too cold	Warm the battery (e.g. in pants pocket) and only insert directly before use
	Battery too hot	Allow battery to cool down
	LCD panel or EVF set too bright	Reduce brightness
	Power save mode deactivated	Enable Camera Standby and/or Display Standby
	Permanent WLAN connection	Deactivate WLAN when not in use
	Continuous use of LCD panel (e.g. in Live View mode)	Deactivate the function
	Battery has been recharged too many times	The battery has reached the end of its operating time Replace battery
	Preview of the recorded images (Auto Review) activated	Deactivate the function
Charging process not starting	Incorrect battery polarization or faulty charger connection	Check polarization and connection
The charging process via the USB of my PC will not commence	USB ports of different output currents are distinguished according to USB charging specifications: <ul style="list-style-type: none"> - Standard Downstream Port (SDP) - Charging Downstream Port (CDP) - Dedicated Charging Port (DCP) 	Any device connected to a USB port will automatically recognize the port type. The charging process will not commence if the available output current of that port is too low: <ul style="list-style-type: none"> - USB 2.0 (SDP): max. 500 mA, battery will not charge - USB 3.0 (CDP): max. 900 mA, battery will be charged at low current - USB charger M11 (DCP): max. 1.5 A, battery will charge normally
Charging takes too long	Battery too hot or too cold	Charge the battery at room temperature
Charging pilot light is on, but battery isn't charging	The battery contacts are dirty	Clean the contacts with a soft, dry cloth
	Battery has been recharged too many times	The battery has reached the end of its operating time Replace battery

Camera problems		
The camera suddenly switches itself off	Battery is depleted	Charge or replace the battery
The camera won't switch on	Battery is depleted	Charge or replace the battery
	Battery too cold	Warming the battery (e.g. in pants pocket)
	Battery was inserted incorrectly	Check its polarization
	Bottom cover was inserted incorrectly	Check the directionality and lock
The camera switches off again immediately after it is switched on	Battery is depleted	Charge or replace the battery
Camera does not recognize the memory card	The memory card is not compatible or defective	Replace the memory card
	Memory card is incorrectly formatted	Format the memory card in the camera
Menus and displays		
Electronic viewfinder is dark	EVF brightness is set too low	Set the EVF brightness
Display language is not English	-	Select English in the Language menu
The LCD panel is too dark or too bright/not clear	The brightness setting is incorrect	Adjust the display brightness
	Viewing angle is too small	View the LCD panel at a perpendicular angle
	Brightness sensor is blocked	Make sure that the brightness sensor is not blocked
Favorites menu does not appear	The favorites menu is empty	Add at least one function
The brightness in Live View mode is not the same as in the images	The brightness settings for the LCD panel have no influence over the exposures	Adjust the brightness settings as needed
	Exposure Simulation is deactivated	Activate the function
The number of remaining shots does not count down after shooting	The image requires only very little memory space	This is not a fault; the number of remaining shots is calculated as approximations
Desired shutter speed cannot be set	The working range of the set shutter type is undercut/surpassed	Select a different setting via Shutter Type
	The set ISO value prevents very slow shutter speeds	Select a different ISO value
Focus peaking does not appear automatically during focusing	The function Focus Peaking is now independent of the Focus Aid function	Display Focus Peaking alongside the other auxiliary displays
Shutter speeds cannot be set in the status screen	The shutter-speed dial is set to a fixed shutter speed or to A (aperture-priority mode)	Set the shutter-speed dial to B
ISO value cannot be set in the status screen	The ISO dial is set to a fixed ISO value or to A (Auto ISO)	Set the ISO dial to M

Shooting

The camera won't release/shutter button is deactivated/shooting not possible	Memory card is full	Replace the memory card
	The memory card is not formatted	Reformat the memory card (Caution: Loss of data!)
	The memory card is write protected	Deactivate the write protection on the memory card (small lever on the side of the memory card)
	Dirt on the memory card contacts	Clean the contacts with a soft cotton or linen cloth
	The memory card is damaged	Replace the memory card
	The sensor is overheating	Allow camera to cool down
	Camera has switched off automatic (Camera Standby)	Switch the camera on again deactivate auto shutdown as needed
	Image data is being written to the memory card and the cache is full	Wait
	Noise reduction function is working (e.g. after night photography with long exposure times)	Wait or deactivate noise reduction
	Battery is depleted	Charge or replace the battery
Camera is processing a image	Wait	
Image numbering has reached its limit	See section "Data Management"	
Image noise appears on the LCD panel/in the viewfinder when the shutter button is pressed to the first pressure point	The gain is increased to aid image composition if the object is insufficiently lit with reduced lens aperture	Not a fault - image quality will not be impacted
LCD panel/viewfinder deactivates after a very short time	Power Save settings are activated	Change the settings as needed
Flash won't fire	Battery is depleted	Charge or replace the battery
	Pressing the shutter button while flash is still loading	Wait until the flash is loaded
	Automatic bracketing or continuous shooting is activated	Change the setting
	The electronic shutter function does not allow flash photography	Select a different setting via Shutter Type
The flash does not fully illuminate the object	Object is outside the flash range	Move object into flash range
	Flash is covered	Make sure the flash unit is not covered by your finger or some object
No continuous shooting available	The camera is overheated and the function was temporarily disabled to protect the camera	Allow camera to cool down

The image on the LCD panel displays lots of noise	Light enhancement function of the LCD panel in dark surroundings	Not a fault - image quality will not be impacted
Image storage takes a long time	Noise reduction is activated for long-term exposures	Deactivate the function
	The memory card inserted is slow	Use a suitable memory card
Electronic viewfinder is dark	Switchover between EVF and LCD incorrectly set	Select a suitable setting
Review and photo management		
Selected images cannot be deleted	Some of the selected images are write protected	Remove write protection (using the device with which the file was originally set to write protected)
File numbering does not start at 1	The memory card contains previously stored images	See section "Data Management"
The time and date settings are incorrect or are not displayed	The camera has not been in use for an extended period of time (the battery was removed)	Insert a charged battery and configure the correct settings
Lens information is not displayed	Lens Detection disabled	Change the setting
	The attached lens is not encoded	Contact Leica Customer Care
Images are damaged or missing	The memory card was removed while the readiness indicator was flashing	Never remove the memory card while the readiness indicator is flashing. Charge the battery.
	The memory card formatting is faulty or the card is damaged	Reformat the memory card (Caution: Loss of data!)
Some images are not displayed in review mode	The files are in another storage location (internal memory/memory card)	Reduce the view as much as possible to get to the storage location selection
The most recent image is not displayed on the LCD panel	Preview is deactivated	Activate Auto Review
No shots/only shots taken in DNG format are saved to the memory card	All No shots/only shots taken in DNG format are saved to the internal memory	Select a different setting via Storage Options
No images are displayed	No memory card inserted	Insert a memory card
	The photos were taken with another camera	Transfer the files to another device to view them
	This is a video file	Use another device for review
Images cannot be displayed	File name was changed on a PC	Use suitable software for file transfers from a PC to the camera
Image quality		
The image is too bright	Light sensor was covered during shooting	Make sure that the light sensor is not obstructed
Image noise	Long exposure times (> 1 s)	Activate the noise reduction function for long-term exposure
	ISO sensitivity set too high	Decrease ISO sensitivity

Round white stains, similar to soap bubbles	Flash photography in a very dark environment: reflections of dust particles	Deactivate the flash
Images are out of focus	Lens is dirty	Clean the lens
	Camera moved during shooting	Use flash
		Mount the camera on a tripod
	Use faster shutter speeds	
Images are overexposed	The desired subject elements were not congruent in the viewfinder	Ensure perfect congruence of the object in the rangefinder
	Flash is activated in bright surroundings	Change the flash mode
	Strong light source in the image	Avoid strong light sources in the image
	(Half) backlight falling into the lens (also from light sources outside the image range)	Use the lens hood or change to another object
	Selected exposure time is too long	Select a shorter exposure time or turn the shutter-speed dial to A
The image is grainy or there is image noise	ISO sensitivity set too high	Decrease ISO sensitivity
Unnatural colors and brightness	Shooting in artificial light or extreme brightness	Try shorter shutter speeds
Shots in JPG format have a lesser resolution than was set via Max. JPG Resolution	DNG + JPG is selected for File Format, and a lesser resolution is set via DNG Resolution	Select a higher DNG resolution or only save in JPG format
Smartphones/WLAN		
WLAN connection gets interrupted	Camera deactivates when it overheats (safety feature)	Allow camera to cool down
Mobile device connection/image transfer not working	The mobile device is too far away	Bring the devices closer to each other
	Interference from other devices in the vicinity, e.g. other smartphones or a microwave oven	Increase distance to interfering devices
	Interference from multiple mobile devices in the vicinity	Re-establish the connection/disconnect other mobile devices
	Mobile device is currently connected to another device	Check connection
Camera does not appear on the WLAN configuration screen of the mobile device	Mobile device does not recognize camera	Switch the WLAN function of the mobile device off and on again





MENU OVERVIEW

DIRECT ACCESS

Function	Status screen	Favorites	Function buttons	Page
Live View	◆		●	93
Focus Aid		★	●	61, 96–98
Lens Detection	◆	★	●	38–39
Drive Mode	◆	★	●	90, 116–120
Interval Shooting		★	●	117
Exposure Bracketing		★	●	119
Self-timer			●	120
Exposure Metering	◆	★	●	105
Exposure Compensation		★	●	47, 61, 115, 119
M-ISO		★	●	99
Auto ISO Settings		★	●	100
Maximum ISO			●	100
Shutter Speed Limit			●	100
White Balance	◆	★	●	101–103
Gray card		★	●	102
File Format	◆	★	●	70

◆ = Accessible via the status screen

★ = Available for the favorites menu

● = Available for function buttons

● = Factory setting on the function buttons



Function	Status screen	Favorites	Function buttons	Page
DNG Resolution	◆	★	●	71
JPG Settings		★		71, 75-77
Max. JPG Resolution	◆		●	71
Extended Dynamic Range		★	●	75
Film Style		★	●	75-76
Auto Review		★		144
Noise Reduction		★		77, 113
Shutter Type		★	●	104
Flash Settings		★	●	127-129
Flash Exp. Compensation		★	●	128
Digital Zoom		★	●	73
Perspective Control			●	121-123
Customize Control		★		59-61, 66, 98, 116
Capture Assistants		★	●	84-89
User Profile	◆	★	●	61
Display Settings		★		67-69
Leica FOTOS		★	●	150-157
EVF <> LCD		★	●	68



Function	Status screen	Favorites	Function buttons	Page
Storage Management				79-80
Storage Options	◆	★	●	78
Format Storage	◆	★	●	80
Camera Settings		★		30, 64-65, 81-82
Power Saving Mode		★		65
Date & Time		★		64-65
Edit File Name		★		82
Camera Information		★		5, 82, 146-148, 154
Reset Camera		★		146
Language		★		64

A

A (aperture-priority mode)	107
Academy, Leica	186
Accessories.....	3
Adapter	36
AE-L	115
Airplane mode.....	157
Aperture.....	107
Aperture-priority mode	107
App	150
Assist function	84, 96
Auto ISO.....	44, 100
Automatic review	144
Auxiliary displays.....	84

B

Basic image settings	70, 84
Basic settings, camera	64
Basic settings, image	70, 84
B function.....	111
Bluetooth	156
Brightness, EVF.....	69
Brightness, LCD panel.....	67
Brightness, rangefinder	67
Button assignment.....	60

C

Camera information	146
Camera, reset	146
Care	159
Carry strap.....	10, 28
Center button.....	45
Center-weighted metering.....	106
Charger.....	9, 28
Charge status, charger.....	29
Charge status, LCD panel.....	27
Charging the battery	29
Clipping.....	87, 135
Color profile	76
Color saturation	75
Color temperature.....	103
Connection, mobile devices	150
Connectivity.....	156
Contact, Leica.....	185
Content credentials.....	82
Continuous shooting	116
Contrast, image properties	75
Copyright	82
Customer Service	185

D

Data management.....	78
Data structure	81
Data transfer.....	83
Date	58, 64
Deletion, photos.....	141

Deletion, user profiles	62
Digital zoom	73
Direct access	60, 61, 169
Directional pad.....	45
Displays	84
Display, settings.....	67
Disposal	6
DNG	70
DNG Resolution.....	71
Double-image methods.....	95
Drive Mode	90, 116, 117

E

Electronic shutter.....	104
EVF	68
Exposure	104
Exposure bracketing.....	119
Exposure compensation.....	115
Exposure compensation, flash	128
Exposure lock	115
Exposure, long-term.....	77, 110
Exposure, manual.....	108
Exposure metering, flash.....	125
Exposure, metering methods	105
Exposure, modes	107
Exposure preview.....	114
Exposure simulation.....	114
Exposure time, max.....	110
Eye sensor.....	69

F

Factory settings	146
FAQ.....	163
Favorites, images	139
Favorites, menu.....	53, 59, 169
File format.....	70
File name	81
Files, RAW.....	70
Film Style	76
Firing point, flash.....	127
Firmware	14, 146
Fixed ISO value	44, 99
Flash	124
Flash, control	127
Flash, exposure compensation.....	128
Flash, exposure metering.....	125
Flash, firing point.....	127
Flash, range.....	128
Flash, setting.....	126
Flash, synchronization.....	127
Flash units, compatible	124
FN button.....	47, 169
Focusing	95
Focusing methods, via rangefinder.....	95
Focus peaking.....	87, 96
Folder, creating new.....	82
Folders.....	81
Folder structure	81
Format	70
Formatting, memory card	80



G

General information	12
Geotagging.....	83
GPS.....	83
Gray card	102
Grid.....	86

H

HDR	119
Highlight, image properties (photo)	75
Highlight-Weighted, exposure.....	106
Histogram	89
Horizon	88
HSS.....	126

I

Image field	91
Image numbering	81
Image properties.....	75
Image, rating	139
Image, series.....	116, 117, 119
Individual button assignment	60
Info Bars.....	86
Info profiles	84
Information display.....	93
Information displays.....	84
Information, legal	4
Information, regulatory.....	5
Inserting/removing the battery.....	30
Internal memory.....	78

Interval shooting	117
ISO Sensitivity.....	44, 99
ISO value, greatest	100

J

JPG.....	70
----------	----

K

Keyboard.....	56
---------------	----

L

Language	64
LCD panel	25, 46, 67, 68
LED	66
Legal information	4
Leica Akademie.....	186
Leica Customer Care.....	185
Leica FOTOS.....	7, 83, 150
Leica FOTOS Cable.....	7
Lens	8, 33, 159
Level gauge	88
Light balance.....	108
Live View.....	93, 96
Long-term exposure.....	77, 110

M

Magnification, assist function	97
Magnification, review mode	136
Magnifying glass	97
Main menu	53

Main switch.....	42
Manual exposure setting.....	108
Maximum Exposure Time.....	110
Memory card.....	10, 13, 31, 78, 80, 160
Menu bar.....	57
MENU button.....	46
Menu control.....	49
Menu language.....	64
Menu navigation.....	50, 54
Menu screen.....	49
Metering method, exposure.....	105
M (Manual exposure setting).....	108
Monochrome.....	76
Monochrome Photography.....	76
Multi-field metering, exposure.....	106

N

Name, file.....	81
Name, folder.....	81
Navigation, menu.....	50, 54
Noise reduction.....	77, 78, 110
Number pad.....	56

O

Offline mode.....	157
Operating mode, exposure.....	107
Operation, customized.....	59
Overview, parts.....	20

P

Part Designations.....	20
Perspective Control.....	121
Photo, delete.....	141
photos, marking.....	139
PLAY button.....	46
Power off, automatic.....	65
Power save.....	65
Power save mode.....	65
Preview.....	144
Problems.....	163
Profile, user.....	61

Q

Quick access.....	59, 60
-------------------	--------

R

Rangefinder.....	91
Rating, photos.....	139
Raw data.....	70
Rechargeable battery, capacity.....	27
Rechargeable battery, notes.....	9, 12, 160
Regulatory information.....	5
Remote control.....	158
Repair.....	185
Replacement parts.....	3
Reset, camera.....	146
Reset, image numbering.....	82
Resolution.....	71
Review, automatic.....	144

Review mode.....132

S

Safety remarks..... 8
 Saturation, Image Properties..... 75
 Saving, energy 65
 Scale..... 57
 Scope of delivery 2
 SD card 10, 13, 31, 78, 80, 160
 Self-timer..... 120
 Sensitivity, eye sensor..... 69
 Sensitivity, ISO..... 44, 99
 Sensor..... 10, 13, 161
 Sensor cleaning 161
 Service..... 185
 Setting, LCD panel 67
 Settings, store.....61
 Shadow, image properties (photo)..... 75
 Sharpness, image properties 75
 Shooting, continuous 116
 Shooting, interval..... 117
 Shooting mode..... 90
 Short cut.....59, 60
 Shutter button..... 43
 Shutter, electronic 104
 Shutter release..... 43
 Shutter-speed/aperture combination 107
 Shutter-speed dial.....44
 Smartphone 150
 Split-image method..... 95

Spot metering, exposure..... 106
 Standby mode..... 65
 Status LED 66
 Status screen25, 51
 Storage 159
 Storage options..... 78
 Submenu..... 53
 Switching, mode..... 134
 Switching on/off, camera 42
 Sync point.....127

T

Tagging, image 139
 Technical Data 179
 T function..... 111
 Thumbwheel..... 45
 Time 58, 65
 Time lapse..... 117
 Time zone..... 65
 Touch control 48
 Transfer, data 83
 Troubleshooting.....163
 TTL metering..... 124, 125

U

Update, firmware..... 14, 146
 USB..... 30
 User-defined operation 59
 User profiles.....61



V

Viewfinder..... 24

W

White balance101

Wi-Fi/WLAN.....7, 156

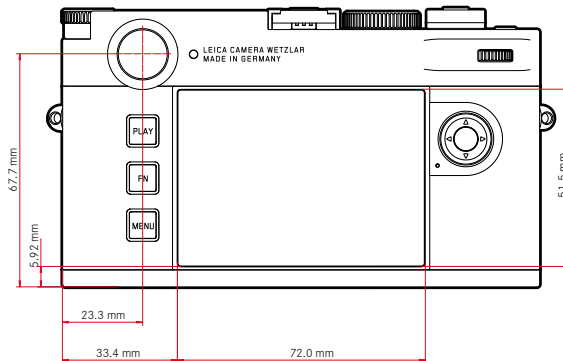
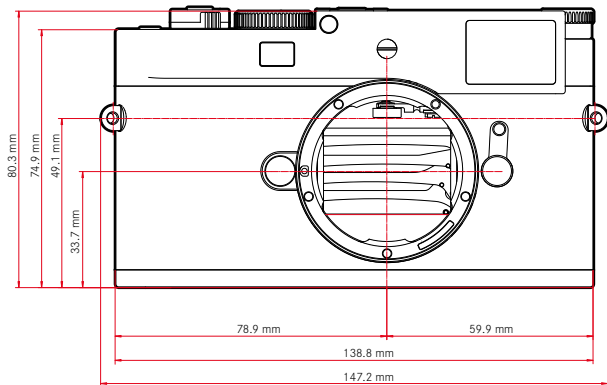
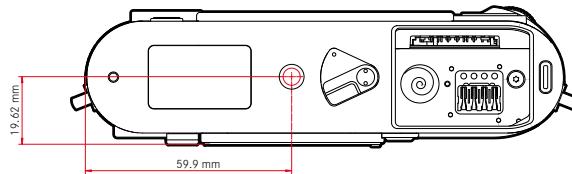
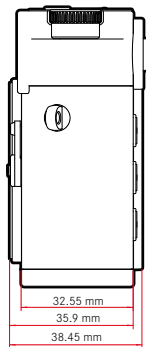

CAMERA

Designation

Leica M11-P

Camera type

Digital system camera with rangefinder

Type No.

2416

Order No.

	Regional variant		
	EU/US/CN	JP	ROW
Order No. (Color)	20211 (black)	20212 (black)	20213 (black)
Order No. (Color)	20214 (silver)	20215 (silver)	20216 (silver)
Wi-Fi 5GHz	11a/n/ac; Channel 149-165 (5745-5825MHz)	11a/n/ac; Channel 36-48 (5180-5240MHz)	-
Wi-Fi 2.4GHz	11b/g/n: channel 1-11 (2412-2462MHz)		
Bluetooth	4.2 BR/EDR/LE: BR/DR channel 1-79, LE channel 0-39 (2402-2480MHz)		

Buffer memory

3 GB

DNG™: 15 shots

JPG: > 100 shots

Storage medium

UHS-II (recommended), UHS-I, SD/SDHC/SDXC memory card

SDXC cards up to 2 TB

Internal memory: 256 GB

Material

Black

Top panel/base: aluminum, black coating

Silver

Top panel/base: brass, silver anodized

Front and rear housing panels: magnesium

Lens mount

Leica M bayonet with additional sensor for 6-bit encoding

Operating conditions

0°C to +40°C

Interfaces

ISO accessory shoe with additional control contacts for Leica flash units and Leica Visoflex2 viewfinder (optional accessory)

USB 3.1 Gen1 Type-C

Tripod thread

A 1/4 DIN 4503 (1/4") with stainless steel in the base

Weight

approx. 532 g (with battery)

SENSOR

Sensor size

CMOS sensor, pixel pitch: 3.76 µm

35 mm: 9528 x 6328 pixels (60.3 MP)

Processor

Leica Maestro series (Maestro III)

Filter

RGB color filter, UV/IR filter, no low-pass filter

File formats

DNG™ (raw data, loss-free compression), DNG + JPG, JPG (DCF, Exif 2.30)

Image resolution

DNG™	L-DNG	60.3 MP	9528 x 6328 pixels
	M-DNG	36.5 MP	7416 x 4928 pixels
	S-DNG	18.4 MP	5272 x 3498 pixels
JPG	L-JPG	60.1 MP	9504 x 6320 pixels
	M-JPG	36.2 MP	7392 x 4896 pixels
	S-JPG	18.2 MP	5248 x 3472 pixels

The entire sensor surface will always be used irrespective of format and resolution. Digital Zoom 1.3x and 1.8x available (always based on L-DNG or L-JPG)



File size

DNG™	L-DNG	approx. 70–120 MB
	M-DNG	approx. 40–70 MB
	S-DNG	approx. 20–40 MB
JPG	L-JPG	approx. 15–30 MB
	M-JPG	approx. 9–18 MB
	S-JPG	approx. 5–9 MB

JPG: depending on resolution and image content

Color depth

DNG™: 14 bit

JPG: 8 bit

Color space

sRGB

VIEWFINDER/LCD PANEL

Viewfinder

Large, bright-line rangefinder with automatic parallax compensation
Suitable for -0.5 dpt; optional corrective lenses available: -3 to +3 dpt

Display

Four-digit digital display with items show on the top and bottom
Image field limiter: two lit frames: 35 mm + 135 mm, 28 mm + 90 mm,
50 mm + 75 mm (automatic switchover when lens is attached)

Parallax compensation

The horizontal and vertical difference between viewfinder and lens is compensated automatically in line with the relevant focus setting. Congruence of viewfinder and actual image.

The size of the bright-line frame matches the distance:

- at 2 m: the exact sensor size of approx. 23.9 x 35.8 mm
- at infinity: (depending on focal length) approx. 7.3% (28 mm) to 18% (135 mm)
- less than 2 m: less than sensor size

Viewfinder magnification

0.73x (all lenses)

Large-base rangefinder

Split or superimposed image rangefinder shown as a bright field at the center of the viewfinder image

LCD panel

2.95" (Active Matrix TFT), sapphire glass, 2 332 800 dots, format 3:2,
Touch control available

SHUTTER

Shutter type

Electronically controlled focal plane shutter and electronic shutter function

Shutter speeds

Mech. shutter: 60 min to 1/4000 s

Electro. shutter function: 60 s to 1/16000 s

Flash Synch: up to 1/180 s

Optional noise reduction via additional "black picture" (can be disabled)

Shutter button

Two-stage

(Step 1: activation of the camera electronics including exposure metering and exposure lock, Step 2: release)

Self-timer

Delay time: 2 s or 12 s

Drive mode

Single	
Continuous - Low Speed	3fps
Continuous - High Speed	4.5fps
Interval Shooting	
Exposure Bracketing	

FOCUSING

Focusing range

70 cm to ∞

Focus mode

Manual (focus assist functions Magnification and Focus Peaking available)

EXPOSURE

Exposure metering

TTL (exposure metering through the lens), with working aperture

Metering principle

Exposure metering is done by the image sensor for all exposure metering methods (in Live View mode and in rangefinder mode)

Exposure metering methods

Spot, Center-Weighted, Multi-Field, Highlight-Weighted

Exposure modes

Aperture-priority mode (A): automatic shutter speed control with manual aperture preselection

Manual (M): manual setting for shutter speed and aperture

Exposure compensation

±3 EV in 1/3 EV increments

Automatic bracketing

3 or 5 frames, graduations between shoots up to 3 EV, in 1/3 EV increments
additional optional exposure compensation: up to ±3 EV

ISO sensitivity range

Auto ISO: ISO 64 (native) to ISO 50 000, also available in flash mode

Manual: ISO 64 to ISO 50 000

White balance

Automatic (Auto), Default (Daylight-5200K, Cloudy-6100K, Shadow-6600K, Tungsten-2950K, HMI-5700K, Fluorescent (warm)-3650K, Fluorescent (cool)-5800K, Flash-6600K), manual metering (Gray card), manual color temperature setting (Color Temperature, 2000K to 11,500K)

FLASH EXPOSURE CONTROL

Flash unit connector

Via the accessory shoe

Metering principle

Flash exposure metering is done by the image sensor for all exposure metering methods (in Live View mode and in rangefinder mode)

Flash sync time

↔ : 1/180s, slower shutter speeds available, automatic switchover to TTL linear flash mode with HSS-compatible Leica system flash units if sync time is undercut

Flash exposure metering

Using center-weighted TTL pre-flash metering with Leica flash units (SF 26, SF 40, SF 58, SF 60, SF 64) or with system-compatible flash units, remote controlled flash SF C1

Flash exposure compensation

SF 40: ±2 EV in 1/2 EV increments

SF 60: ±2 EV in 1/3 EV increments

Other: ±3 EV in 1/3 EV increments

Displays in flash mode (in the viewfinder only)

Flash icon: connection of an external flash unit



EQUIPMENT

WLAN

The Leica FOTOS app is required to use the WLAN function. The Leica app is available from the Apple App Store™ or the Google Play Store™. 2.4 GHz/5 GHz dual band IEEE802.11 a/b/g/n/ac Wave2 WLAN (standard WLAN protocol), encryption method: WLAN-kompatible WPA™/WPA2™, access method: infrastructure mode

	Regional variant		
	EU/US/CN	JP	ROW
Wi-Fi 5 GHz	11a/n/ac: Channel 149-165 (5745-5825 MHz)	11a/n/ac: Channel 36-48 (5180-5240 MHz)	-
Wi-Fi 2.4 GHz	11b/g/n: Channel 1-11 (2412-2462 MHz)		

Bluetooth

Bluetooth v4.2 BR/EDR/LE, BR/DR-channel 1-79, LE-channel 0-39 (2402-2480 MHz)

GPS

Geotagging via Leica FOTOS app using Bluetooth

Menu languages

English, German, French, Italian, Spanish, Russian, Portuguese, Japanese, Traditional Chinese, Simplified Chinese, Korean

Content credentials

The certificate stored in the camera has a validity of 10 years. Once the then years have elapsed, the certificate can be renewed via Leica Camera AG.

POWER SUPPLY

Rechargeable battery (Leica BP-SCL7)

Li-Ion (Lithium-Polymer) rechargeable battery, rated voltage: 7.4 V / capacity: 1800 mAh, Charging voltage/current: DC 1000 mAh, 7.4 V, operating conditions: +10°C to +35°C (charging) / +0°C to +40°C (discharged), manufacturer: Fuji Electronics (Shenzhen) Co., Ltd. made in China

Approx. 700 shots (in accordance with CIPA Standard in rangefinder mode), up to approx. 1700 shots (Leica adapted shooting cycle)

Charger (Leica BC-SCL7)

Input: USB-C DC 5V, 2A, output: DC 8.4V, 1A, operating conditions: +10°C to +35°C, manufacturer: Dee Van Enterprises Co., Ltd., made in China

Switching adapter (Leica ACA-SCL7)

Input: AC 110V - 240V ~ 50/60Hz, 0.3A, output: DC 5V, 2A, operating conditions: +10°C to +35°C, manufacturer: Dee Van Enterprises Co., Ltd., made in China

USB power supply

When in standby mode or Off: USB charging function
When On: USB power supply and intermittent charging



LEICA CUSTOMER CARE

Please contact the Customer Care department of Leica Camera AG for the maintenance of your Leica equipment and for help and advice regarding Leica products and how to order them. You can also contact the Customer Care department or the repair service provided by your regional Leica subsidiary for repairs or warranty claims.

LEICA GERMANY

Leica Camera AG

Leica Customer Care
Am Leitz-Park 5
35578 Wetzlar
Germany

Phone: +49(0)6441 2080-189

Fax: +49(0)6441 2080-339

Email: customer.care@leica-camera.com

<https://leica-camera.com>

YOUR NATIONAL REPRESENTATIVE

You will find the Customer Care department responsible for your locality on our homepage:

<https://leica-camera.com/en-US/contact>

LEICA AKADEMIE

Have a look at our full seminar program with many interesting workshops on the topic of photography at:

<https://leica-camera.com/en-US/leica-akademie>

