

Nikon

DIGITAL CAMERA

Z fc

User's Manual

En

- Read this document thoroughly before using the camera.
- To ensure proper use of the camera, be sure to read “For your safety” (page 11).
- After reading this document, keep it readily accessible for future reference.



Scan for detailed operating instructions.

nikon download center Z fc



The Z fc *User's Manual* and *Reference Guide*

In addition to this *User's Manual*, a *Reference Guide* is available for your camera.

The *User's Manual* (this document)

The *User's Manual* describes basic camera operations.



The *Reference Guide*

Camera features and operations are detailed in a *Reference Guide*, a supplement to the *User's Manual*. The *Reference Guide* can be viewed on computers, smartphones, and tablets.



nikon download center Z fc



Z fc Model Name: N2016

✔ **Lens kit lenses**

For information on lenses supplied as part of a lens kit, see the lens documentation available for download from the Nikon Download Center.

✔ **The Nikon Download Center**

Visit the Nikon download center to download firmware updates, NX Studio and other Nikon software, and documentation for Nikon products including cameras, NIKKOR lenses, and flash units.

<https://downloadcenter.nikonimglib.com/>



✔ **Genuine Nikon software**

Nikon computer software such as NX Studio is available from the Nikon Download Center. For more information, see the *"Reference Guide"*.

When your first photo can't wait

Getting ready

1 Insert the battery and memory card (☐24).

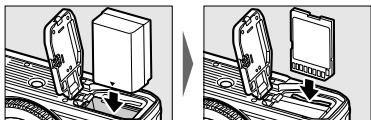

For information on charging the battery, see “Charging the battery” (☐23).

2 Attach a lens (☐27).

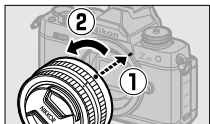

- Align the indicator on the camera body with the indicator on the lens (①) and rotate the lens in the direction shown (②).
- A strap can be attached to the camera. For more information, see “Attaching the strap” (☐22).

3 Turn the camera on and then choose a language and set the clock (☐30).

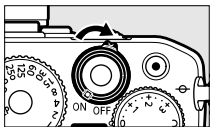

Take (33) and view (41) pictures

- 1 Rotate the mode selector to AUTO (AUTO).

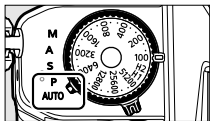

- 2 To focus, press the shutter-release button halfway (i.e, lightly press the shutter-release button, stopping when it is pressed halfway).

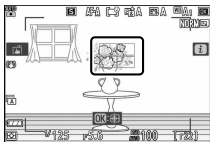

- 3 Without lifting your finger from the shutter-release button, press the button the rest of the way down to take the picture.



- 4 View the picture.

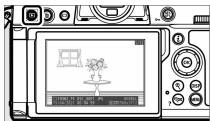

Package contents

Be sure all items listed here were included with your camera.

Camera



BF-N1 body cap



DK-32 rubber eyecup (comes attached to camera)



- Memory cards are sold separately.
- Purchasers of the lens kit option should confirm that the package also includes a lens.

EN-EL25 rechargeable Li-ion battery

MH-32 battery charger (plug adapter supplied in countries or regions where required; shape depends on country of sale)

AN-DC23 strap (□□22)



Warranty (printed on the back cover of this document)

User's Manual

About this document

■ Symbols

This document employs the following symbols and conventions. Use them to help locate the information you need.

	This icon marks notes, information that should be read before using this product.
	This icon marks tips, additional information you may find helpful when using this product.
	This icon marks references to other sections in this document.

■ Conventions

- This camera uses SD, SDHC, and SDXC memory cards, referred to throughout this document as “memory cards”. SD, SDHC, and SDXC may also on occasion be referred to as “SD memory cards”.
- Throughout this document, battery chargers are referred to as “battery chargers” or “chargers”.
- Throughout this document, the display in camera monitor and viewfinder during shooting is referred to as the “shooting display”; in most cases, the illustrations show the monitor.
- Throughout this document, smartphones and tablets are referred to as “smart devices”.
- Throughout this document, the term “default settings” is used to refer to the settings in effect at shipment. The explanations in this document assume that default settings are used.

■ ■ Nikon User Support

Should you need technical support, we offer a number of options.

- **For users in the U.S.A.:** <https://www.nikonusa.com/>
- **For customers in Canada:** <https://www.nikon.ca/>
- **For customers in Mexico:** <https://www.nikon.com.mx/>
- **For customers in Latin America:**
<https://www.nikonamericatina.com/>
- **For users in Europe:** <https://www.europe-nikon.com/support>
- **For users in Asia, Oceania, and the Middle East:**
<https://www.nikon-asia.com/>

Table of contents

The Z fc <i>User's Manual</i> and <i>Reference Guide</i>	2
When your first photo can't wait	4
Package contents	6
About this document	7
For your safety	11
Notices	16

Parts of the camera **19**

Camera body	19
-------------------	----

First steps **22**

Attaching the strap	22
Charging the battery	23
Inserting the battery and a memory card	24
Attaching a lens	27
Opening the monitor	29
Turning on the camera	30

Basic photography and playback **33**

Taking photographs (AUTO  auto)	33
Recording videos (AUTO  auto)	38
Viewing photos	41

Troubleshooting **42**

Before contacting customer support	42
--	----

Technical notes **43**

Caring for the camera	43
Caring for the camera and battery: Cautions	44
Trademarks and licenses	51
Notices	53
Bluetooth and Wi-Fi (wireless LAN)	56

Warranty terms - Nikon Europe service warranty	62
--	----

For your safety

To prevent damage to property or injury to yourself or to others, read “For your safety” in its entirety before using this product.

After reading these safety instructions, keep them readily accessible for future reference.

⚠ **DANGER:** Failure to observe the precautions marked with this icon carries a high risk of death or severe injury.

⚠ **WARNING:** Failure to observe the precautions marked with this icon could result in death or severe injury.

⚠ **CAUTION:** Failure to observe the precautions marked with this icon could result in injury or property damage.



WARNING

Do not use while walking or operating a vehicle.

Failure to observe this precaution could result in accidents or other injury.

Do not disassemble or modify this product. Do not touch internal parts that become exposed as the result of a fall or other accident.

Failure to observe these precautions could result in electric shock or other injury.

Should you notice any abnormalities such as the product producing smoke, heat, or unusual odors, immediately disconnect the battery or power source.

Continued operation could result in fire, burns or other injury.

Keep dry. Do not handle with wet hands. Do not handle the plug with wet hands.

Failure to observe these precautions could result in fire or electric shock.

Do not let your skin remain in prolonged contact with this product while it is on or plugged in.

Failure to observe this precaution could result in low-temperature burns.

Do not use this product in the presence of flammable dust or gas such as propane, gasoline or aerosols.

Failure to observe this precaution could result in explosion or fire.

Do not directly view the sun or other bright light source through the lens.

Failure to observe this precaution could result in visual impairment.

Do not aim the flash or AF-assist illuminator at the operator of a motor vehicle.

Failure to observe this precaution could result in accidents.

Keep this product out of reach of children.

Failure to observe this precaution could result in injury or product malfunction. In addition, note that small parts constitute a choking hazard. Should a child swallow any part of this product, seek immediate medical attention.

Do not entangle, wrap or twist the straps around your neck.

Failure to observe this precaution could result in accidents.

Do not use batteries, chargers, AC adapters, or USB cables not specifically designated for use with this product. When using batteries, chargers, AC adapters, and USB cables designated for use with this product, do not:

- **Damage, modify, forcibly tug or bend the cords or cables, place them under heavy objects, or expose them to heat or flame.**
- **Use travel converters or adapters designed to convert from one voltage to another or with DC-to-AC inverters.**

Failure to observe these precautions could result in fire or electric shock.

Do not handle the plug when charging the product or using the AC adapter during thunderstorms.

Failure to observe this precaution could result in electric shock.

Do not handle with bare hands in locations exposed to extremely high or low temperatures.

Failure to observe this precaution could result in burns, or frostbite.

 **CAUTION**

Do not leave the lens pointed at the sun or other strong light sources.

Light focused by the lens could cause fire or damage to product's internal parts. When shooting backlit subjects, keep the sun well out of the frame. Sunlight focused into the camera when the sun is close to the frame could cause fire.

Turn this product off when its use is prohibited. Disable wireless features when the use of wireless equipment is prohibited.

The radio-frequency emissions produced by this product could interfere with equipment onboard aircraft or in hospitals or other medical facilities.

Remove the battery and disconnect the AC adapter if this product will not be used for an extended period.

Failure to observe this precaution could result in fire or product malfunction.

Do not fire the flash in contact with or in close proximity to the skin or objects.

Failure to observe this precaution could result in burns or fire.

Do not leave the product where it will be exposed to extremely high temperatures, for an extended period such as in an enclosed automobile or in direct sunlight.

Failure to observe this precaution could result in fire or product malfunction.

Do not look directly at the AF-assist illuminator.

Failure to observe this precaution could have adverse effects on vision.

Do not transport cameras or lenses with tripods or similar accessories attached.

Failure to observe this precaution could result in injury or product malfunction.



DANGER (Batteries)

Do not mishandle batteries.

Failure to observe the following precautions could result in the batteries leaking, overheating, rupturing, or catching fire:

- Use only rechargeable batteries approved for use in this product.
 - Do not expose batteries to flame or excessive heat.
 - Do not disassemble.
 - Do not short-circuit the terminals by touching them to necklaces, hairpins, or other metal objects.
 - Do not expose batteries or the products in which they are inserted to powerful physical shocks.
 - Do not step on batteries, pierce them with nails, or strike them with hammers.
-

Charge only as indicated.

Failure to observe this precaution could result in the batteries leaking, overheating, rupturing, or catching fire.

If battery liquid comes into contact with the eyes, rinse with plenty of clean water and seek immediate medical attention.

Delaying action could result in eye injuries.

Follow the instructions of airline personnel.

Batteries left unattended at high altitudes in an unpressurized environment may leak, overheat, rupture, or catch fire.



WARNING (Batteries)

Keep batteries out of reach of children.

Should a child swallow a battery, seek immediate medical attention.

Keep batteries out of reach of household pets and other animals.

The batteries could leak, overheat, rupture, or catch fire if bitten, chewed, or otherwise damaged by animals.

Do not immerse batteries in water or expose to rain.

Failure to observe this precaution could result in fire or product malfunction. Immediately dry the product with a towel or similar object should it become wet.

Discontinue use immediately should you notice any changes in the batteries, such as discoloration or deformation. Cease charging EN-EL25 rechargeable batteries if they do not charge in the specified period of time.

Failure to observe these precautions could result in the batteries leaking, overheating, rupturing, or catching fire.

When batteries are no longer needed, insulate the terminals with tape.

Overheating, rupture, or fire may result should metal objects come into contact with the terminals.

If battery liquid comes into contact with a person's skin or clothing, immediately rinse the affected area with plenty of clean water.

Failure to observe this precaution could result in skin irritation.

Notices

- No part of the documentation included with this product may be reproduced, transmitted, transcribed, stored in a retrieval system, or translated into any language in any form, by any means, without Nikon's prior written permission.
- Nikon reserves the right to change the appearance and specifications of the hardware and software described in this documentation at any time and without prior notice.
- Nikon will not be held liable for any damages resulting from the use of this product.
- While every effort has been made to ensure that the information in this documentation is accurate and complete, we would appreciate it were you to bring any errors or omissions to the attention of the Nikon representative in your area (address provided separately).

● **Notice concerning prohibition of copying or reproduction**

Note that simply being in possession of material that has been digitally copied or reproduced by means of a scanner, digital camera, or other device may be punishable by law.

• **Items prohibited by law from being copied or reproduced**

Do not copy or reproduce paper money, coins, securities, government bonds, or local government bonds, even if such copies or reproductions are stamped "Sample".

The copying or reproduction of paper money, coins, or securities which are circulated in a foreign country is prohibited.

Unless the prior permission of the government has been obtained, the copying or reproduction of unused postage stamps or post cards issued by the government is prohibited.

The copying or reproduction of stamps issued by the government and of certified documents stipulated by law is prohibited.

• **Cautions on certain copies and reproductions**

The government has issued cautions on copies or reproductions of securities issued by private companies (shares, bills, checks, gift certificates,

etc.), commuter passes, or coupon tickets, except when a minimum of necessary copies are to be provided for business use by a company. Also, do not copy or reproduce passports issued by the government, licenses issued by public agencies and private groups, ID cards, and tickets, such as passes and meal coupons.

- **Comply with copyright notices**

Under copyright law, photographs or recordings of copyrighted works made with the camera cannot be used without the permission of the copyright holder. Exceptions apply to personal use, but note that even personal use may be restricted in the case of photographs or recordings of exhibits or live performances.

- **Use only Nikon brand electronic accessories**

Nikon cameras are designed to the highest standards and include complex electronic circuitry. Only Nikon brand electronic accessories (including lenses, chargers, batteries, AC adapters, and flash accessories) certified by Nikon specifically for use with this Nikon digital camera are engineered and proven to operate within the operational and safety requirements of this electronic circuitry.

The use of non-Nikon electronic accessories could damage the camera and may void your Nikon warranty. The use of third-party rechargeable Li-ion batteries not bearing the Nikon holographic seal shown below could interfere with normal operation of the camera or result in the batteries overheating, igniting, rupturing, or leaking.



For more information about Nikon brand accessories, contact a local authorized Nikon dealer.

- **Memory cards**

- Memory cards may be hot after use. Observe due caution when removing memory cards from the camera.
- Do not perform the following operations during formatting or while data are being recorded, deleted, or copied to a computer or other

device. Failure to observe these precautions could result in loss of data or in damage to the camera or card.

- Do not remove or insert memory cards
- Do not turn the camera off
- Do not remove the battery
- Do not touch the card terminals with your fingers or metal objects.
- Do not use excessive force when handling memory cards. Failure to observe this precaution could damage the card.
- Do not bend or drop memory cards or subject them to strong physical shocks.
- Do not expose memory cards to water, heat, or direct sunlight.
- Do not format memory cards in a computer.

✔ Before taking important pictures

Before taking pictures on important occasions (such as at weddings or before taking the camera on a trip), take a test shot to ensure that the camera is functioning normally. Nikon will not be held liable for damages or lost profits that may result from product malfunction.

✔ Life-long learning

As part of Nikon's "Life-long learning" commitment to ongoing product support and education, continually-updated information is available on-line at the following sites:

- **For users in the U.S.A.:** <https://www.nikonusa.com/>
- **For users in Europe and Africa:** <https://www.europe-nikon.com/support/>
- **For users in Asia, Oceania, and the Middle East:** <https://www.nikon-asia.com/>

Visit these sites to keep up-to-date with the latest product information, tips, answers to frequently-asked questions (FAQs), and general advice on digital imaging and photography. Additional information may be available from the Nikon representative in your area. See the following URL for contact information: <https://imaging.nikon.com/>

Parts of the camera

Camera body

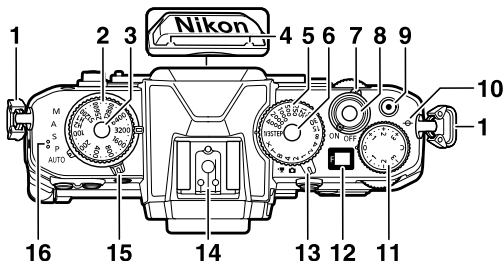

1 Eyelet for camera strap

2 ISO sensitivity dial

3 ISO sensitivity dial lock release

4 Stereo microphone

5 Shutter-speed dial

6 Shutter-speed dial lock release

7 Power switch

8 Shutter-release button

9 Video-record button

10 \ominus (focal plane mark)

11 Exposure compensation dial

12 Control panel

13 Photo/video selector

14 Accessory shoe (for optional flash unit)

15 Mode selector

16 Speaker

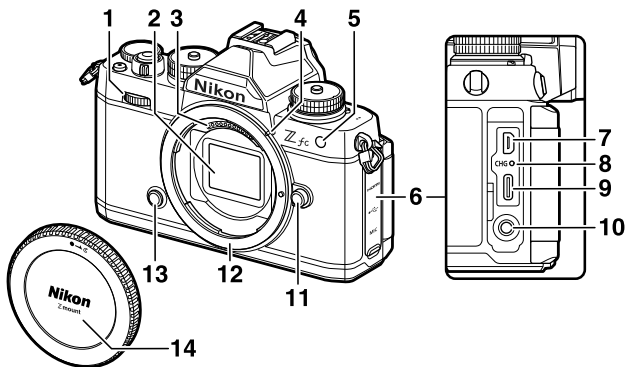

1 Sub-command dial

2 Image sensor

3 CPU contacts

4 Lens mounting mark

5 AF-assist illuminator

Red-eye reduction lamp

Self-timer lamp

6 Cover for HDMI, USB, and
microphone connectors

7 HDMI connector

8 Charge lamp

9 USB connector

10 Connector for external
microphone

11 Lens release button

12 Lens mount

13 Fn button

14 Body cap

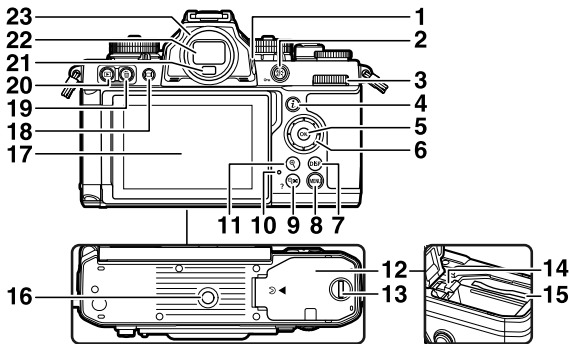

- 1 Diopter adjustment control
- 2 測光 (On) button
- 3 Main command dial
- 4 *i* button
- 5 \otimes button
- 6 Multi selector
- 7 **DISP** button
- 8 **MENU** button
- 9 Q (?) button
- 10 Memory card access lamp
- 11 Q button

- 12 Battery-chamber/memory card slot cover
- 13 Battery-chamber/memory card slot cover latch
- 14 Battery latch
- 15 Memory card slot
- 16 Tripod socket
- 17 Monitor
- 18 \square button
- 19 W button
- 20 P button
- 21 Eye sensor
- 22 Viewfinder
- 23 Rubber eyecup

First steps

Attaching the strap

To attach a strap (whether the supplied strap or one that has been purchased separately):

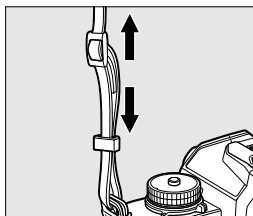
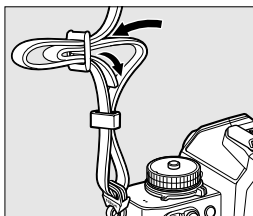
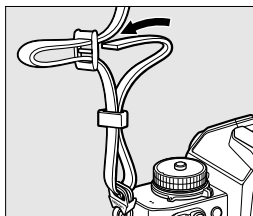
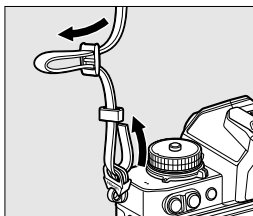

Charging the battery

Charge the supplied EN-EL25 battery in the supplied MH-32 battery charger before use.

✔ The battery and charger

Read and follow the warnings and cautions in "For your safety" (□11) and "Caring for the camera and battery: Cautions" (□44).

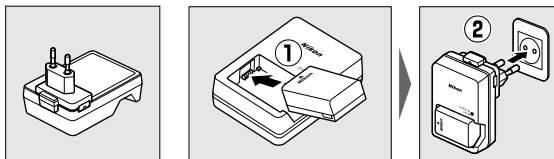

- Plug the charger into a household outlet to charge it. In some countries or regions, the charger may be supplied with the adapter connected. The charger lamp flashes while charging, and lights up when charging is complete.
- An exhausted battery will fully charge in about 2 hours and 30 minutes.

✔ If the CHARGE lamp flashes rapidly

If the **CHARGE** lamp flashes rapidly (8 times a second):

- **A battery charging error has occurred:** Unplug the charger and remove and reinsert the battery.
- **The ambient temperature is too hot or too cold:** Use the battery charger at temperatures within the designated temperature range (0–40 °C/+32–104 °F).

If the problem persists, unplug the charger and end charging. Bring the battery and charger to a Nikon-authorized service representative.

Inserting the battery and a memory card

- Turn the camera off before inserting or removing the battery and memory card.
- Using the battery to keep the orange battery latch pressed to one side, slide the battery into the battery chamber until the latch locks it in place.
- Holding the memory card in the orientation shown, slide it straight into the slot until it clicks into place.

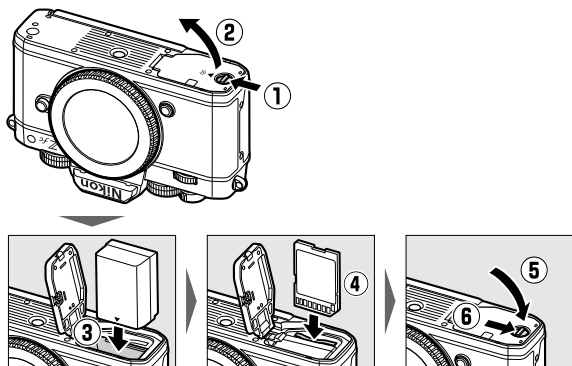

✔ Removing the battery

To remove the battery, turn the camera off and open the battery-chamber/memory card slot cover. Press the battery latch in the direction shown by the arrow to release the battery and then remove the battery by hand.

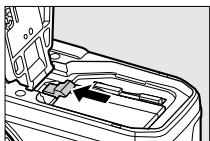

✔ Removing the memory card

After confirming that the memory card access lamp is off, turn the camera off and open the battery-chamber/memory card slot cover. Press the memory card in to eject it (1), and pull it out to remove it (2).

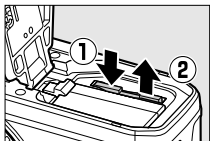

Battery level



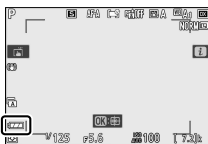

- The battery level is shown in the shooting display while the camera is on.



Monitor



Viewfinder

- The battery level display changes as the battery level diminishes, from  through , and . When the battery level falls to , suspend shooting and charge the battery or ready a spare battery.
- If the message [**Shutter release disabled. Recharge battery.**] is displayed, charge or exchange the battery.

☑ The standby timer

The camera uses a standby timer to help reduce the drain on the battery. If no operations are performed for about 30 seconds, the standby timer will expire and the monitor, viewfinder, and control panel will turn off. A few seconds prior to turning off, the displays will dim. They can be reactivated by pressing the shutter-release button halfway. The length of time before the standby timer expires automatically can be selected using Custom Setting c3 [**Power off delay**] > [**Standby timer**].

Attaching a lens

- The camera can be used with Z mount lenses. The lens generally used in this document for illustrative purposes is a NIKKOR Z DX 16–50mm f/3.5–6.3 VR.
- Be careful to prevent dust entering the camera.
- Confirm that the camera is off before attaching the lens.
 - Remove the camera body cap (①, ②) and rear lens cap (③, ④).

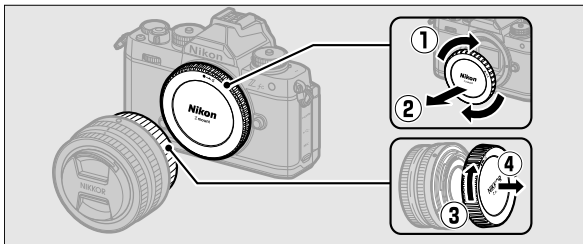

- Align the mounting marks on the camera (⑤) and lens (⑥). Do not touch the image sensor or lens contacts.

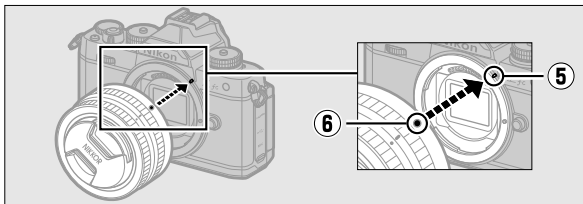

- Rotate the lens as shown until it clicks into place (7).

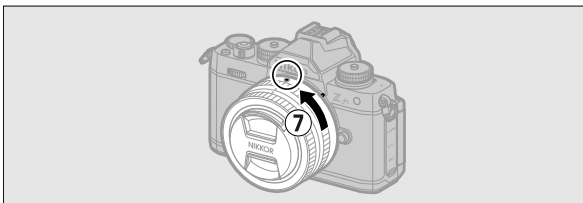

- Remove the front lens cap before taking pictures.

✓ F mount lenses

- Be sure to attach the FTZ mount adapter (available separately) before using F mount lenses.
 - Attempting to attach F mount lenses directly to the camera could damage the lens or image sensor.
-

Detaching lenses

- After turning the camera off, press and hold the lens release button (1) while turning the lens in the direction shown (2).

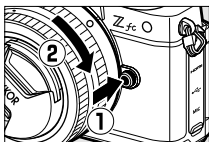

- After removing the lens, replace the lens caps and camera body cap.

Opening the monitor

Slowly rotate the monitor without using excessive force.

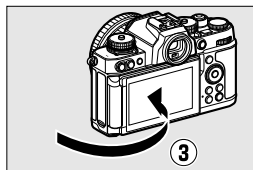
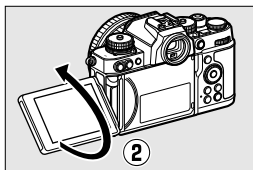
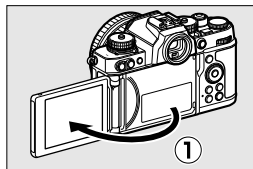
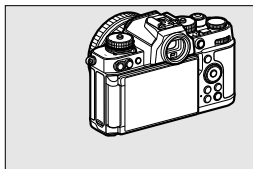

Turning on the camera

When the camera is turned on for the first time, the language selection screen is displayed. Choose a language and then set the camera clock (no other operations can be performed until the clock is set).

1 Turn the camera on.

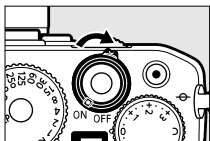

- The [**Language**] selection screen will be displayed.



2 Select a language.

- Press \uparrow or \downarrow to highlight the desired language and press \odot (the languages available vary with the country or region in which the camera was originally purchased).
- The [**Time zone**] screen will be displayed.

3 Choose a time zone.



- Press or to choose a time zone and press .
- The display shows the selected cities in the chosen zone and the difference between the time in the chosen zone and UTC.
- The [**Date format**] screen will be displayed.

4 Choose a date format.

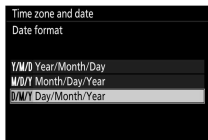

- Highlight the desired date (year, month, and day) display order and press .
- The [**Daylight saving time**] screen will be displayed.

5 Turn daylight saving time on or off.

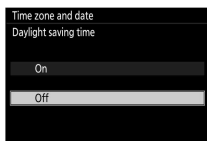

- Highlight [**On**] (daylight saving time on) or [**Off**] (daylight saving time off) and press **OK**.
- Selecting [**On**] advances the clock one hour; to undo the effect, select [**Off**].
- The [**Date and time**] screen will be displayed.

6 Set the clock.

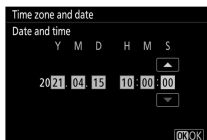

- Press **←** or **→** to highlight date and time items and press **↑** or **↓** to change them.
- Press **OK** to confirm the date and time setting.
- The message [**Done.**] will be displayed and the camera switches to shooting mode.

Basic photography and playback

Taking photographs (AUTO auto)

Select  (auto) mode for simple “point-and-shoot” photography.

✔ Lenses with retractable barrels

Lenses with retractable barrels must be extended before use. Rotate the zoom ring as shown until the lens clicks into the extended position.

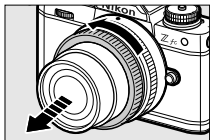

1 Select photo mode by rotating the photo/video selector to .

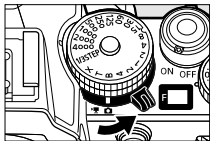

2 Rotate the mode selector to AUTO (.

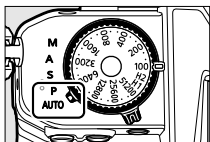

3 Ready the camera.

Holding the handgrip in your right hand and cradling the camera body or lens with your left, bring your elbows in against the sides of your chest.



Landscape (wide)
orientation



Portrait (tall) orientation

4 Frame the photograph.



Position the main subject in the AF-area brackets ([]).

- The AF-area brackets will disappear and a yellow border indicating the focus point appears around the faces of human subjects detected by the camera. If the camera detects the subject's eyes, the yellow focus point will instead appear over one or the other of their eyes.



5 Press the shutter-release button halfway to focus.



- The focus point will be displayed in green when the camera focuses. If the camera is unable to focus, the AF-area brackets will flash.

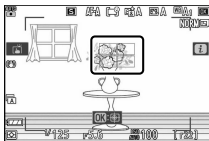

- The AF-assist illuminator may light to assist the focus operation if the subject is poorly lit.
- If the camera detects human faces or eyes, the focus point will light green when the subject is in focus. The focus point will flash in red when the camera does not focus.



✔ **The AF-assist illuminator**

Do not obstruct the AF-assist illuminator while it is lit.



6 Smoothly press the shutter-release button the rest of the way down to take the photograph.



✔ **The memory card access lamp**

The memory card access lamp will light while the photograph is being recorded. **Do not remove the memory card or battery.**

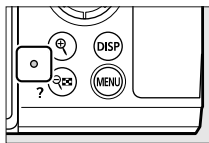

☑ The touch shutter

You can also take a photograph by touching the monitor. Touch your subject to focus and lift your finger to release the shutter.

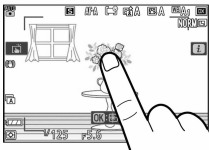

Recording videos (AUTO auto)

 (auto) mode can also be used for simple, “point-and-shoot” video recording.

- 1 Select video mode by rotating the photo/video selector to .**

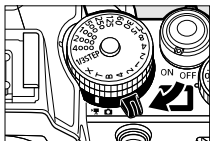

Note that optional flash units cannot be used when the camera is in video mode.

- 2 Rotate the mode selector to AUTO (.**

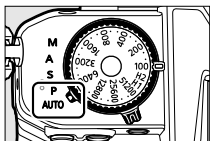

3 Press the video-record button to start recording.

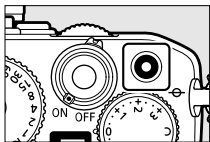

- A recording indicator will be displayed in the monitor. The monitor also shows the time remaining, or in other words the approximate amount of new footage that can be recorded to the memory card.

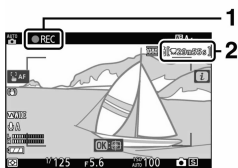

- 1 Recording indicator
- 2 Time remaining

- Sound is recorded via the built-in microphone. Do not cover the microphone during recording.
- If you tap your subject in the monitor during recording, the focus point will track the subject as it moves through the frame.

4 Press the video-record button again to end recording.

✔ The memory card access lamp

The memory card access lamp will light while the video is being recorded. **Do not remove the memory card or battery.**

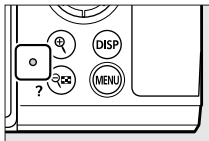

✔ The icon

A  icon indicates that videos cannot be recorded.



✔ Recording videos

- Video recording will end automatically if:
 - The maximum length is reached
 - Another mode is selected
 - The photo/video selector is rotated to 
 - The lens is removed
 - Sounds made by the camera may be audible in footage recorded:
 - During autofocus
 - During vibration reduction
 - When power aperture is used
-

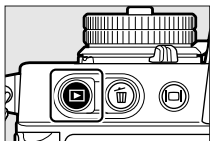

Viewing photos

Press the  button to view photos and videos recorded with the camera in the monitor or viewfinder.

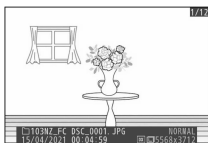

- Press  or , or flick left or right on the monitor to view other images.



- Videos are indicated by a  icon at the upper left of the monitor. Press the  button, or tap the  icon in the monitor to play back videos.



- To end playback and return to shooting mode, press the shutter-release button halfway.

Troubleshooting

Before contacting customer support

You may be able to resolve any issues with the camera by following the steps below. Check this list before consulting your retailer or Nikon-authorized service representative.

STEP 1 **Check the list of common problems.**
Common problems and solutions are listed in the troubleshooting section of the *Reference Guide*.

STEP 2 **Turn the camera off and remove the battery, then wait about a minute, re-insert the battery and turn the camera on.**
 The camera may continue to write data to the memory card after shooting. Wait at least a minute before removing the battery.

STEP 3 **Search Nikon websites.**

- For support information and answers to frequently asked questions, visit the website for your country or region (□18).
- To download the latest firmware for your camera, visit:
<https://downloadcenter.nikonimglib.com/>

STEP 4 **Consult a Nikon-authorized service representative.**

Technical notes

Caring for the camera

Storage

When the camera will not be used for an extended period, remove the battery. Before removing the battery, confirm that the camera is off. Do not store the camera in locations that:

- are poorly ventilated or subject to humidities of over 60%
- are next to equipment that produces strong electromagnetic fields, such as televisions or radios
- are exposed to temperatures above 50 °C (122 °F) or below –10 °C (14 °F)

Caring for the camera and battery:

Cautions

Camera care

- **Do not drop**

Do not drop the camera or lens or subject them to blows. The product may malfunction if subjected to strong shocks or vibration.

- **Keep dry**

Keep the camera dry. Rusting of the internal mechanism caused by water inside the camera can not only be expensive to repair but can in fact cause irreparable damage.

- **Avoid sudden changes in temperature**

If you bring the camera from a cold place to a warm place, or from a warm place to a cold place, water droplets may form inside and outside the camera and cause damage. When you bring the camera to a place with a temperature difference, place the camera in a carrying case or plastic bag and seal it beforehand. When the camera has adapted to the ambient temperature, take it out from the bag and use it.

- **Keep away from strong magnetic fields**

Static charges or the magnetic fields produced by equipment such as radio transmitters could interfere with the monitor, corrupt data stored on the memory card, or affect the product's internal circuitry.

- **Do not leave the lens pointed at the sun**

Do not leave the lens pointed at the sun or other strong light source for extended periods. Intense light may damage the image sensor or cause fading or "burn in". Photographs taken with the camera may exhibit a white blur effect.

- **Lasers and other bright light sources**

Do not direct lasers or other extremely bright light sources toward the lens, as this could damage the camera's image sensor.

- **Cleaning**

When cleaning the camera body, use a blower to gently remove dust and lint, then wipe gently with a soft, dry cloth. After using the camera at the beach or seaside, wipe off any sand or salt using a cloth lightly dampened in fresh water and then dry the camera thoroughly.

- **Cleaning the lens and viewfinder**

These glass elements are easily damaged: remove dust and lint with a blower. If using an aerosol blower, keep the can vertical to prevent the discharge of liquid that could damage glass elements. To remove fingerprints and other stains from the lens, apply a small amount of lens cleaner to a soft cloth and wipe the lens carefully.

- **Do not touch the image sensor**

Under no circumstances should you exert pressure on the image sensor, poke it with cleaning tools, or subject it to powerful air currents from a blower. These actions could scratch or otherwise damage the sensor.

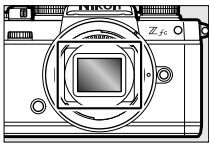

- **The lens contacts**

Keep the lens contacts clean. Avoid touching them with your fingers.

- **Store in a well-ventilated area**

To prevent mold or mildew, store the camera in a dry, well-ventilated area. Do not store the camera with naphtha or camphor moth balls, next to equipment that produces strong electromagnetic, or where it will be exposed to extremely high temperatures, for example near a heater or in an

enclosed vehicle on a hot day. Failure to observe these precautions could result in product malfunction.

- **Long-term storage**

To prevent damage caused by, for example, leaking battery fluid, remove the battery if the product will not be used for an extended period. Store the camera in a plastic bag containing a desiccant. Do not, however, store the leather camera case in a plastic bag, as this may cause the material to deteriorate. Store the battery in a cool, dry place. Note that desiccant gradually loses its capacity to absorb moisture and should be replaced at regular intervals. To prevent mold or mildew, take the camera out of storage at least once a month, insert the battery, and release the shutter a few times.

- **Turn the product off before removing the battery.**

Removing the battery while the camera is on could damage the product. Particular care should be taken not to remove or disconnect the power source while images are being recorded or deleted.

- **Monitor/viewfinder**

- The monitors (including viewfinder) are constructed with extremely high precision; at least 99.99% of pixels are effective, with no more than 0.01% being missing or defective. Hence while these displays may contain pixels that are always lit (white, red, blue, or green) or always off (black), this is not a malfunction. Images recorded with the device are unaffected. Your understanding is requested.
- Images in the monitor may be difficult to see in a bright light.
- Do not apply pressure to the monitor. The monitor could malfunction or suffer damage. Dust or lint on the monitor can be removed with a blower. Stains can be removed by wiping the monitor lightly with a soft cloth or chamois leather. Should the monitor break, care should be taken to avoid injury from broken glass. Be careful that liquid crystal from the monitor does not touch the skin or enter the eyes or mouth.
- Should you experience any of the following symptoms while framing shots in the viewfinder, discontinue use until your condition improves:
 - nausea, eye pain, eye fatigue,

- dizziness, headache, stiffness in your neck or shoulders,
 - queasiness or loss of hand-eye coordination, or
 - motion sickness.
- The display may rapidly flicker on and off during burst photography. Watching the flickering display could cause you to feel unwell. Discontinue use until your condition improves.

● **Bright lights and back-lit subjects**

Noise in the form of lines may in rare cases appear in pictures that include bright lights or back-lit subjects.

✔ **Disposing of data storage devices**

Please note that deleting images or formatting memory cards or other data storage devices does not completely erase the original image data. Deleted files can sometimes be recovered from discarded storage devices using commercially available software, potentially resulting in the malicious use of personal image data. Ensuring the privacy of such data is the user's responsibility.

Before discarding a data storage device or transferring ownership to another person, erase all data using commercial deletion software, or format the device and then completely refill it with images containing no private information (for example, pictures of empty sky). Care should be taken to avoid injury when physically destroying data storage devices. Before discarding the camera or transferring ownership to another person, you should also use the [**Reset all settings**] item in the camera setup menu to delete network settings and other personal information.

Battery care

● **Precautions for use**

- If improperly handled, batteries may rupture or leak, causing the product to corrode. Observe the following precautions when handling batteries:
 - Turn the product off before replacing the battery.
 - Batteries may be hot after extended use.
 - Keep the battery terminals clean.

- Use only batteries approved for use in this equipment.
- Do not short or disassemble batteries or expose them to flame or excessive heat.
- When the battery is not inserted in the camera or charger, keep it in a plastic bag or other non-conductive container so that the terminals are insulated.
- If the battery is hot, for example immediately after use, wait for it to cool before charging. Attempting to charge the battery while its internal temperature is elevated will impair battery performance, and the battery may not charge or charge only partially.
- If the battery will not be used for some time, insert it in the camera and run it flat before removing it from the camera for storage. The battery should be stored in a cool, dry location with an ambient temperature of 15 °C to 25 °C (59 °F to 77 °F). Avoid hot or extremely cold locations.
- Batteries should be charged within six months of use. During long periods of disuse, charge the battery and use the camera to run it flat once every six months before returning it to a cool location for storage.
- Remove the battery from the camera or charger when not in use. The camera and charger draw minute amounts of charge even when off and could draw the battery down to the point that it will no longer function.
- Do not use the battery at ambient temperatures below 0 °C (32 °F) or above 40 °C (104 °F). Failure to observe this precaution could damage the battery or impair its performance. Charge the battery indoors at ambient temperatures of 5 °C–35 °C (41 °F–95 °F). The battery will not charge if its temperature is below 0 °C (32 °F) or above 60 °C (140 °F).
- Capacity may be reduced and charging times increase at battery temperatures from 0 °C (32 °F) to 15 °C (59 °F) and from 45 °C (113 °F) to 60 °C (140 °F).
- Batteries in general exhibit a drop in charging capacity at low ambient temperatures.
- Batteries in general exhibit a drop in available capacity at low ambient temperatures. The change in capacity with temperature is reflected in the camera battery-level display. As a result, the battery display may show a

drop in capacity as the temperature drops, even if the battery is fully charged.

- Batteries may be hot after use. Observe due caution when removing batteries from the camera.

● **Charge batteries before use**

Charge the battery before use. The supplied battery is not fully charged at shipment.

● **Ready spare batteries**

Before taking photographs, ready a spare battery and keep it fully charged. Depending on your location, it may be difficult to purchase replacement batteries on short notice.

● **Have fully-charged spare batteries ready on cold days**

Partially-charged batteries may not function on cold days. In cold weather, charge one battery before use and keep another in a warm place, ready to be exchanged as necessary. Once warmed, a cold battery may recover some of its charge.

● **Battery level**

- Turning the camera on or off repeatedly when the battery is fully discharged will shorten battery life. Batteries that have been fully discharged must be charged before use.
- A marked drop in the time a fully charged battery retains its charge when used at room temperature indicates that it requires replacement. Purchase a new rechargeable battery.

● **Do not attempt to charge fully-charged batteries**

Continuing to charge the battery after it is fully charged can impair battery performance.

● **Recycling used batteries**

Recycle rechargeable batteries in accord with local regulations, being sure to first insulate the terminals with tape.

Using the charger

- Do not move the charger or touch the battery during charging; failure to observe this precaution could in very rare instances result in the charger showing that charging is complete when the battery is only partially charged. Remove and reinsert the battery to begin charging again.
- Do not short the charger terminals. Failure to observe this precaution could result in overheating and damage to the charger.
- Unplug the charger when it is not in use.
- Use the MH-32 Battery Charger with compatible batteries only.
- Do not use chargers with damage that leaves the interior exposed or that produce unusual sounds when used.
- The symbols on this product represent the following:
 - ~ AC, = DC, □ Class II equipment (the construction of the product is double-insulated)

Using the charging AC adapter

- Do not move the camera or touch the battery during charging. Failure to observe this precaution could in very rare instances result in the camera showing that charging is complete when the battery is only partially charged. Disconnect and reconnect the adapter to begin charging again.
- Do not short the adapter terminals. Failure to observe this precaution could result in overheating and damage to the charger.
- Unplug the adapter when it is not in use.
- Do not use adapters with damage that leaves the interior exposed or that produce unusual sounds when used.
- The symbols on this product represent the following:
 - ~ AC, = DC, □ Class II equipment (the construction of the product is double-insulated)

Trademarks and licenses

- The SD, SDHC, and SDXC logos are trademarks of SD-3C, LLC.
- Windows is either a registered trademark or a trademark of Microsoft Corporation in the United States and/or other countries.
- Apple®, App Store®, the Apple logos, iPhone®, iPad®, Mac, and macOS are trademarks of Apple Inc. registered in the U.S. and/or other countries.
- Android, Google Play and the Google Play logo are trademarks of Google LLC. The Android robot is reproduced or modified from work created and shared by Google and used according to terms described in the Creative Commons 3.0 Attribution License.
- IOS is a trademark or registered trademark of Cisco Systems, Inc., in the United States and/or other countries and is used under license.
- HDMI, the HDMI logo and High-Definition Multimedia Interface are trademarks or registered trademarks of HDMI Licensing, LLC.

HDMI

- The Bluetooth® word mark and logo are registered trademarks owned by Bluetooth SIG, Inc., and any use of such marks by Nikon is under license.
- Wi-Fi and the Wi-Fi logo are trademarks or registered trademarks of the Wi-Fi Alliance.
- All other trade names mentioned in this document or the other documentation provided with your Nikon product are trademarks or registered trademarks of their respective holders.
- Use of the Made for Apple badge means that an accessory has been designed to connect specifically to the Apple products identified in the badge, and has been certified by the developer to meet Apple performance standards. Apple is not responsible for the operation of this device or its compliance with safety and regulatory standards. Please note that the use of this accessory with an Apple product may affect wireless performance.

- The software for this product includes open-source software copyrighted by third parties. The terms of the licenses for this open-source software may be found in the *Reference Guide*.
<https://downloadcenter.nikonimglib.com/>

Notices

- **Notices for customers in the U.S.A.**

The battery charger

IMPORTANT SAFETY INSTRUCTIONS—SAVE THESE INSTRUCTIONS DANGER—TO REDUCE THE RISK OF FIRE OR ELECTRIC SHOCK, CAREFULLY FOLLOW THESE INSTRUCTIONS

For connection to a supply not in the U.S.A., use an attachment plug adapter of the proper configuration for the power outlet if needed. This power unit is intended to be correctly oriented in a vertical or floor mount position.

Federal Communications Commission (FCC) Radio Frequency Interference Statement



This equipment has been tested and found to comply with the limits for a Class B digital device, pursuant to Part 15 of the FCC rules. These limits are designed to provide reasonable protection against harmful interference in a residential installation. This equipment generates, uses, and can radiate radio frequency energy and, if not installed and used in accordance with the instructions, may cause harmful interference to radio communications. However, there is no guarantee that interference will not occur in a particular installation. If this equipment does cause harmful interference to radio or television reception, which can be determined by turning the equipment off and on, the user is encouraged to try to correct the interference by one or more of the following measures:

- Reorient or relocate the receiving antenna.
- Increase the separation between the equipment and receiver.

- Connect the equipment into an outlet on a circuit different from that to which the receiver is connected.
- Consult the dealer or an experienced radio/television technician for help.

CAUTIONS

Modifications

The FCC requires the user to be notified that any changes or modifications made to this device that are not expressly approved by Nikon Corporation may void the user's authority to operate the equipment.

Interface cables

Use the interface cables sold or provided by Nikon for your equipment. Using other interface cables may exceed the limits of Class B Part 15 of the FCC rules.

Nikon Inc., 1300 Walt Whitman Road, Melville, New York 11747-3064, U.S.A.

Tel.: 631-547-4200

● **Power cable**

At voltages over AC 125 V (U.S.A. only): The power cable must be rated for the voltage in use, be at least AWG no. 18 gauge, and have SVG insulation or better with a NEMA 6P-15 plug rated for AC 250 V 15 A.

● **Notice for customers in Canada**

CAN ICES-3 B / NMB-3 B

● **Notices for customers in Europe**

CAUTION: RISK OF EXPLOSION IF BATTERY IS REPLACED BY AN INCORRECT TYPE. DISPOSE OF USED BATTERIES ACCORDING TO THE INSTRUCTIONS.

This symbol indicates that electrical and electronic equipment is to be collected separately.



The following apply only to users in European countries:

- This product is designated for separate collection at an appropriate collection point. Do not dispose of as household waste.
- Separate collection and recycling helps conserve natural resources and prevent negative consequences for human health and the environment that might result from incorrect disposal.
- For more information, contact the retailer or the local authorities in charge of waste management.

This symbol on the battery indicates that the battery is to be collected separately.



The following apply only to users in European countries:

- All batteries, whether marked with this symbol or not, are designated for separate collection at an appropriate collection point. Do not dispose of as household waste.
- For more information, contact the retailer or the local authorities in charge of waste management.

Bluetooth and Wi-Fi (wireless LAN)

This product is controlled by the United States Export Administration Regulations (EAR). The permission of the United States government is not required for export to countries other than the following, which as of this writing are subject to embargo or special controls: Cuba, Iran, North Korea, Sudan, and Syria (list subject to change).

The use of wireless devices may be prohibited in some countries or regions. Contact a Nikon-authorized service representative before using the wireless features of this product outside the country of purchase.

The Bluetooth transmitter in this device operates in the 2.4 GHz band.

● **Notice for customers in the U.S.A. and Canada**

This device complies with part 15 of FCC Rules and Innovation, Science and Economic Development Canada's licence-exempt RSSs. Operation is subject to the following two conditions: (1) this device may not cause harmful interference, and (2) this device must accept any interference received, including interference that may cause undesired operation.

FCC WARNING

The FCC requires the user to be notified that any changes or modifications made to this device that are not expressly approved by Nikon Corporation may void the user's authority to operate the equipment.

Compliance with FCC requirement 15.407(c)

Data transmission is always initiated by software, which is then passed down through the MAC, through the digital and analog baseband, and finally to the RF chip. Several special packets are initiated by the MAC. These are the only ways the digital baseband portion will turn on the RF transmitter, which it then turns off at the end of the packet. Therefore, the transmitter will be on only while one of the aforementioned packets is being transmitted. In other words, this device automatically

discontinue transmission in case of either absence of information to transmit or operational failure.

Frequency Tolerance: ± 20 ppm

There are models that support only 2.4GHz or models that support 2.4GHz / 5GHz. The Guam sales model is only compatible with 2.4GHz.

FCC Radio Frequency Interference Statement

Note: This equipment has been tested and found to comply with the limits for a Class B digital device, pursuant to part 15 of the FCC Rules. These limits are designed to provide reasonable protection against harmful interference in a residential installation. This equipment generates, uses and can radiate radio frequency energy and, if not installed and used in accordance with the instructions, may cause harmful interference to radio communications. However, there is no guarantee that interference will not occur in a particular installation. If this equipment does cause harmful interference to radio or television reception, which can be determined by turning the equipment off and on, the user is encouraged to try to correct the interference by one or more of the following measures:

- Reorient or relocate the receiving antenna.
- Increase the separation between the equipment and receiver.
- Connect the equipment into an outlet on a circuit different from that to which the receiver is connected.
- Consult the dealer or an experienced radio/TV technician for help.

Co-location

This transmitter must not be co-located or operated in conjunction with any other antenna or transmitter.

Nikon Inc., 1300 Walt Whitman Road, Melville, New York 11747-3064, U.S.A.

Tel.: 631-547-4200

FCC/ISED RF Exposure Statement

The available scientific evidence does not show that any health problems are associated with using low power wireless devices. There is

no proof, however, that these low power wireless devices are absolutely safe. Low power Wireless devices emit low levels of radio frequency energy (RF) in the microwave range while being used. Whereas high levels of RF can produce health effects (by heating tissue), exposure of low-level RF that does not produce heating effects causes no known adverse health effects. Many studies of low-level RF exposures have not found any biological effects. Some studies have suggested that some biological effects might occur, but such findings have not been confirmed by additional research. This product has been tested and found to comply with FCC/ISED radiation exposure limits set forth for an uncontrolled environment and meets the FCC radio frequency (RF) Exposure Guidelines and RSS-102 of the ISED radio frequency (RF) Exposure rules. Please refer to the SAR test report that was uploaded to FCC website.

Compliance with RSS-247 Issue 2 §6.4

Data transmission is always initiated by software, which is the passed down through the MAC, through the digital and analog baseband, and finally to the RF chip. Several special packets are initiated by the MAC. These are the only ways the digital baseband portion will turn on the RF transmitter, which it then turns off at the end of the packet. Therefore, the transmitter will be on only while one of the aforementioned packets is being transmitted. In other words, this device automatically discontinues transmission in case of either absence of information to transmit or operational failure.

- **Notice for customers in Canada**

For indoor use only (5150-5350MHz).

- **Notice for customers in Europe and in countries complying with the Radio Equipment Directive**

Hereby, Nikon Corporation declares that the radio equipment type Z fc is in compliance with Directive 2014/53/EU.



The full texts of the EU declarations of conformity are available at the following internet addresses:

https://imaging.nikon.com/support/pdf/DoC_N2016.pdf

Wi-Fi

- **Operating frequency:**

- 2412–2462 MHz (channel 11; Africa, Asia, Bolivia, Europe, and Oceania)
- 2412–2462 MHz (channel 11), 5180–5825 MHz (5180–5580 MHz, 5660–5700 MHz, and 5745–5825 MHz) (U.S.A., Canada, Mexico)
- 2412–2462 MHz (channel 11), 5180–5805 MHz (5180–5320 MHz and 5745–5805 MHz) (other countries in the Americas)

- **Maximum output power (EIRP):**

- 2.4 GHz band: 8.1 dBm
- 5 GHz band: 7.9 dBm (countries in the Americas)

Bluetooth

- **Operating frequency:**

- Bluetooth: 2402–2480 MHz
- Bluetooth Low Energy: 2402–2480 MHz

- **Maximum output power (EIRP):**

- Bluetooth: 2.6 dBm
- Bluetooth Low Energy: 1.1 dBm

- **Notice for customers in Singapore**

Trade Name: Nikon
Model: Z fc

This device complies with radio-frequency regulations. The content of certification labels not affixed to the device is given below.

Complies with
IMDA Standards
DA103423

- **Notice for customers in Nigeria**

Connection and use of this communications
equipment is permitted by the Nigerian
Communications Commission

- **Notice for customers in Thailand**

เครื่องโทรคมนาคมและอุปกรณ์นี้ มีความสอดคล้อง ตามมาตรฐานหรือข้อ กําหนดทางเทคนิคของ กสทช.

☑ **Conformity marking**

Some of the information related to standards with which the camera complies can be viewed using the [**Conformity marking**] option in the setup menu.

☑ **Certificates**

• **Maroc/**

المغرب

AGREE PAR L'ANRT MAROC

Numéro d'agrément : MR00027908ANRT2021



• **México**

La operación de este equipo está sujeta a las siguientes dos condiciones:

- (1) es posible que este equipo o dispositivo no cause interferencia perjudicial y
- (2) este equipo o dispositivo debe aceptar cualquier interferencia, incluyendo la que pueda causar su operación no deseada.

• عُمان

Oman-TRA
D090024
R/11325/21

Warranty terms

Warranty terms - Nikon Europe service warranty

Dear Nikon customer,

We thank you for your purchasing this Nikon product. Should your Nikon product require warranty service, please contact the dealer from whom it was purchased or a member of our authorized service network within the sales territory of Nikon Europe B.V. (e.g. Europe/Russia/others). See details under:

<https://www.europe-nikon.com/support>

In order to avoid any unnecessary inconvenience, we advise you to read the user manuals carefully before contacting the dealer or our authorized service network.

Your Nikon equipment is guaranteed against any manufacturing defects for one full year from the date of original purchase. If during this period of guarantee the product proves defective due to improper material or workmanship, our authorized service network within the sales territory of Nikon Europe B.V. will, without charge for labor and parts, repair the product in the terms and conditions set as below. Nikon reserves the right (at its sole discretion) to replace or repair the product.

1. This warranty is only provided upon presentation of the completed warranty card and original invoice or purchase receipt indicating the date of purchase, product type and dealer's name, together with the product. Nikon reserves the right to refuse free-of-charge warranty service if the above documents cannot be presented or if the information contained in it is incomplete or illegible.
2. This warranty will not cover:
 - necessary maintenance and repair or replacement of parts due to normal wear and tear.
 - modifications to upgrade the product from its normal purpose as described in user manuals, without the prior written consent of Nikon.

- transport costs and all risks of transport relating directly or indirectly to the warranty of the products.
 - any damage resulting from modifications or adjustments which may be made to the product, without the prior written consent of Nikon, in order to comply with local or national technical standards in force in any other country than the ones for which the product was originally designed and/or manufactured.
- 3.** The warranty will not be applicable in the case of:
- damage caused by misuse including but not limited to failure to use the product for its normal purpose or according to the user instructions on the proper use and maintenance, and to installation or use of the product inconsistent with the safety standards in force in the country where it is used.
 - damage caused by accidents including but not limited to lightning, water, fire, misuse or neglect.
 - defacing, illegibility or removal of the model or serial number on the product.
 - damage resulting from repairs or adjustments which have been conducted by unauthorized service organizations or persons.
 - defects in any system into which the product is incorporated or with which it is used.
- 4.** This service warranty does not affect the consumer's statutory rights under applicable national laws in force, nor the consumer's right against the dealer arising from their sales/purchase contract.

Notice: An overview of all authorized Nikon Service Stations can be found online by following this Link

(URL = <https://www.europe-nikon.com/service/>).

No reproduction in any form of this manual, in whole or in part (except for brief quotation in critical articles or reviews), may be made without written authorization from NIKON CORPORATION.

NIKON CORPORATION

© 2021 Nikon Corporation



CT1H02(11)
6MOA9411-02