

Nikon

DIGITAL CAMERA

Z 7

Z 6

Reference Manual

This manual is for camera firmware versions 3.00 and later. The latest version of the camera firmware is available for download from the Nikon Download Center.

- Read this manual thoroughly before using the camera.
- To ensure proper use of the camera, be sure to read "For Your Safety" (page xvi).
- After reading this manual, keep it in a readily accessible place for future reference.

Choose from 3 different manuals.

For a guide to all aspects of camera operation, read:

The **Reference Manual** (this manual)

In addition to the material covered in the *User's Manual* supplied with the camera, the *Reference Manual* details the options available in the camera menus and covers such topics as connecting the camera to other devices (for information on wireless networks, see the *Network Guide*).



Among the topics covered in the Reference Manual are:

- Basic shooting and playback operations
- Advanced shooting options
- The camera menus
- Connecting to computers, printers, and HDMI devices
- Flash photography using optional flash units

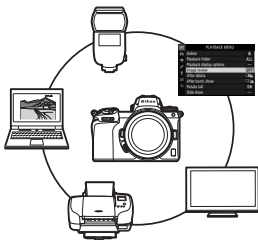

The Reference Manual can also be viewed online in html format.

nikon online manual Z 7



Z 6



https://onlinemanual.nikonimglib.com/z7_z6/en/



Z 7 Model Name: N1710

Z 6 Model Name: N1711

✓ **For a guide to basic shooting and playback, read:**

The *User's Manual* (included)

Master basic camera operations as well as features specific to this camera.

- Table of Contents
- Getting to Know the Camera
- First Steps
- Basic Photography and Playback
- Basic Settings
- Shooting Controls
- The *i* Menu
- Menu List
- Troubleshooting



✓ **For information on wireless connections, read:**

The *Network Guide* (pdf)

The *Network Guide* covers such topics as connecting the camera via Wi-Fi or Bluetooth to a computer or to a smart device such as a smartphone or tablet, and the tasks that can be performed using a WT-7 wireless transmitter.



The Network Guide is available from the Nikon Download Center.

nikon download center Z 7



Z 6



Z 7: https://downloadcenter.nikonimglib.com/en/products/492/Z_7.html

Z 6: https://downloadcenter.nikonimglib.com/en/products/493/Z_6.html

Package Contents

Be sure all items listed here were included with your camera.



BF-N1 body cap



*DK-29 rubber eyecup
(comes attached to
camera, [☞ 417](#))*

Camera

*EN-EL15b rechargeable Li-ion
battery with terminal cover*

*MH-25a battery charger (comes
with either an AC wall adapter or
power cable of a type and shape
that varies with the country or
region of sale)*

AN-DC19 strap ([☞ 27](#))

Warranty

User's Manual

HDMI/USB cable clip ([☞ 419](#))

UC-E24 USB cable ([☞ 339](#))

*BS-1 accessory shoe cover
([☞ 418](#))*

Memory cards are sold separately. Purchasers of lens or mount adapter kits should confirm that the package contains a lens or mount adapter (manuals for the lens or adapter may also be provided).

The Nikon Download Center

In addition to the *Reference Manual*, you can also visit the Nikon download center to download product manuals, firmware updates, and software such as ViewNX-i.

<https://downloadcenter.nikonimglib.com/>

About This Manual

This manual is for use with both the Z 7 and Z 6. The illustrations show the Z 7.

Symbols and Conventions

To make it easier to find the information you need, the following symbols and conventions are used:



This icon marks notes, information that should be read before using this product.



This icon marks tips, additional information you may find helpful when using this product.



This icon marks references to other sections in this manual.

Menu items, options, and messages that appear in the camera displays are shown in **bold**. Throughout this manual, the display in camera monitor and viewfinder during shooting is referred to as the “shooting display”; in most cases, the illustrations show the monitor.

This camera can be used with XQD and CFexpress Type B memory cards. In contexts where no distinction need be made between the two, both types are referred to throughout this manual as “memory cards”.

Throughout this manual, smartphones and tablets are referred to as “smart devices”.

Camera Settings



The explanations in this manual assume that default settings are used.

For Your Safety

Before using the camera for the first time, read the safety instructions in “For Your Safety” (□ xvi).

Table of Contents

Package Contents	ii
For Your Safety	xvi
Notices.....	xx
Getting to Know the Camera	1
<hr/>	
Parts of the Camera	1
Camera Body	1
The Control Panel	5
The Monitor and Viewfinder.....	6
Camera Controls	8
The Viewfinder.....	8
The Monitor Mode Button.....	8
Touch Controls	10
The DISP Button	15
The Sub-Selector.....	17
The AF-ON Button	17
The Command Dials	17
The MENU Button.....	18
The i Button (i Icon).....	21
The Function Buttons (Fn1 and Fn2).....	24
First Steps	27
<hr/>	
Attach the Camera Strap	27
Charge the Battery	28
The Battery Charger	28
Charging AC Adapters	29
Insert the Battery and a Memory Card	32
Attach a Lens	36
Choose a Language and Set the Clock	38

Basic Photography and Playback	41
<hr/>	
Taking Photographs (AUTO Mode)	41
Shooting Movies (AUTO Mode)	45
Basic Playback.....	49
Viewing Movies	49
Deleting Unwanted Pictures	51
Basic Settings	52
<hr/>	
Focus.....	52
Choosing a Focus Mode	52
AF-Area Mode	54
The Touch Shutter	60
Manual Focus	62
White Balance	64
Silent Photography.....	68
Rating Pictures.....	70
Protecting Pictures from Deletion	71
Shooting Controls	72
<hr/>	
The Mode Dial	72
P: Programmed Auto	73
S: Shutter-Priority Auto	73
A: Aperture-Priority Auto.....	74
M: Manual.....	75
User Settings: U1 , U2 , and U3 Modes.....	77
Long Time-Exposures (Mode M)	80
The ISO (ISO Sensitivity) Button	82
Auto ISO Sensitivity Control	83
The  (Exposure Compensation) Button	84
The  (Release Mode/Self-Timer) Button.....	86
The Self-Timer	89

The Sub-Selector.....	91
Focus-Point Selection	91
Autoexposure (AE) Lock	91
Focus Lock	91
The <i>i</i> Menu	94
<hr/>	
Using the <i>i</i> Menu	94
The Photo-Mode <i>i</i> Menu	95
Set Picture Control.....	96
White Balance.....	100
Image Quality	106
Image Size.....	108
Flash Mode	109
Metering.....	110
Wi-Fi Connection.....	111
Active D-Lighting	112
Release Mode.....	113
Vibration Reduction	114
AF-Area Mode.....	115
Focus Mode	115
The Movie-Mode <i>i</i> Menu	116
Set Picture Control.....	117
White Balance.....	117
Frame Size, Frame Rate, and Movie Quality	118
Microphone Sensitivity	120
Choose Image Area	121
Metering.....	122
Wi-Fi Connection.....	122
Active D-Lighting	122
Electronic VR	122
Vibration Reduction	123
AF-Area Mode.....	123
Focus Mode	123

More About Playback **124**

Viewing Pictures	124
Full-Frame Playback.....	124
Thumbnail Playback	125
Photo Information	126
The <i>z</i> Button: Playback	134
Select to Send/Deselect	136
Choose Start/End Point	137
Save Current Frame	140
Taking a Closer Look: Playback Zoom	141
Deleting Pictures	142
During Playback	142
The Playback Menu	143

Menu Guide **145**

Defaults	145
<input type="checkbox"/> The Playback Menu: Managing Images	156
Delete.....	157
Playback Folder	157
Playback Display Options	157
Image Review.....	158
After Delete.....	158
After Burst, Show	159
Rotate Tall.....	159
Slide Show.....	160
Rating.....	161



 The Photo Shooting Menu: Shooting Options	162
Reset Photo Shooting Menu	163
Storage Folder	163
File Naming	167
Choose Image Area	167
Image Quality	168
Image Size.....	168
NEF (RAW) Recording	170
ISO Sensitivity Settings	171
White Balance.....	172
Set Picture Control.....	179
Manage Picture Control.....	181
Color Space	184
Active D-Lighting	184
Long Exposure NR.....	185
High ISO NR.....	185
Vignette Control.....	186
Diffraction Compensation	186
Auto Distortion Control	186
Flicker Reduction Shooting	187
Metering.....	187
Flash Control.....	188
Flash Mode	190
Flash Compensation	191
Focus Mode.....	191
AF-Area Mode.....	191
Vibration Reduction	191
Auto Bracketing.....	192
Multiple Exposure	202
HDR (High Dynamic Range)	209
Interval Timer Shooting	214
Time-Lapse Movie.....	225
Focus Shift Shooting.....	233
Silent Photography	239

▶ The Movie Shooting Menu: Movie Shooting Options ...	240
Reset Movie Shooting Menu	241
File Naming.....	241
Choose Image Area.....	241
Frame Size/Frame Rate.....	241
Movie Quality.....	241
Movie File Type	241
ISO Sensitivity Settings.....	242
White Balance	242
Set Picture Control	243
Manage Picture Control	243
Active D-Lighting.....	243
High ISO NR	243
Vignette Control	244
Diffraction Compensation.....	244
Auto Distortion Control.....	244
Flicker Reduction	244
Metering	245
Focus Mode	245
AF-Area Mode	245
Vibration Reduction.....	245
Electronic VR.....	245
Microphone Sensitivity.....	246
Attenuator.....	246
Frequency Response	247
Wind Noise Reduction	247
Headphone Volume	247
Timecode.....	248

 Custom Settings: Fine-Tuning Camera Settings.....	249
Reset Custom Settings	252
a: Autofocus	253
a1: AF-C Priority Selection.....	253
a2: AF-S Priority Selection	253
a3: Focus Tracking with Lock-On.....	254
a4: Auto-Area AF Face/Eye Detection.....	254
a5: Focus Points Used	255
a6: Store Points by Orientation	255
a7: AF Activation.....	256
a8: Limit AF-Area Mode Selection	257
a9: Focus Point Wrap-Around.....	257
a10: Focus Point Options.....	257
a11: Low-Light AF	258
a12: Built-in AF-Assist Illuminator	258
a13: Manual Focus Ring in AF Mode	259
b: Metering/Exposure	259
b1: EV Steps for Exposure Cntrl.....	259
b2: Easy Exposure Compensation.....	260
b3: Center-Weighted Area	260
b4: Fine-Tune Optimal Exposure	261
c: Timers/AE Lock	261
c1: Shutter-Release Button AE-L	261
c2: Self-Timer	262
c3: Power Off Delay	262
d: Shooting/Display	263
d1: CL Mode Shooting Speed	263
d2: Max. Continuous Release	263
d3: Sync. Release Mode Options.....	263
d4: Exposure Delay Mode	263
d5: Shutter Type	264
d6: Limit Selectable Image Area	264
d7: File Number Sequence.....	265
d8: Apply Settings to Live View	266

d9: Framing Grid Display	266
d10: Peaking Highlights	266
d11: View All in Continuous Mode	266
e: Bracketing/Flash	267
e1: Flash Sync Speed	267
e2: Flash Shutter Speed	268
e3: Exposure Comp. for Flash	268
e4: Auto ⚡ ISO Sensitivity Control	268
e5: Modeling Flash	269
e6: Auto Bracketing (Mode M)	269
e7: Bracketing Order	270
f: Controls	271
f1: Customize i Menu	271
f2: Custom Control Assignment	273
f3: OK Button	281
f4: Shutter Spd & Aperture Lock	283
f5: Customize Command Dials	283
f6: Release Button to Use Dial	285
f7: Reverse Indicators	285
g: Movie	286
g1: Customize i Menu	286
g2: Custom Control Assignment	287
g3: OK Button	292
g4: AF Speed	292
g5: AF Tracking Sensitivity	293
g6: Highlight Display	294
Y The Setup Menu: Camera Setup	295
Format Memory Card	296
Save User Settings	296
Reset User Settings	296
Language	296
Time Zone and Date	297
Monitor Brightness	297
Monitor Color Balance	298

Viewfinder Brightness	299
Viewfinder Color Balance	299
Control Panel Brightness	299
Limit Monitor Mode Selection	300
Information Display	300
AF Fine-Tune	301
Non-CPU Lens Data	302
Clean Image Sensor	302
Image Dust Off Ref Photo	303
Image Comment	305
Copyright Information	306
Beep Options	307
Touch Controls	307
HDMI	308
Location Data	308
Wireless Remote (WR) Options	309
Assign Remote (WR) Fn Button	310
Airplane Mode	310
Connect to Smart Device	310
Connect to PC	311
Wireless Transmitter (WT-7)	311
Conformity Marking	311
Battery Info	312
Slot Empty Release Lock	312
Save/Load Settings	313
Reset All Settings	315
Firmware Version	315
☑ The Retouch Menu: Creating Retouched Copies	316
NEF (RAW) Processing	319
Trim	322
Resize	323
D-Lighting	325
Red-Eye Correction	325
Straighten	326

Distortion Control.....	326
Perspective Control	327
Image Overlay.....	328
Trim Movie	331
Side-by-Side Comparison	331
 My Menu/  Recent Settings.....	333
Connections	338
<hr/>	
Connecting to Smart Devices	338
Connecting to Computers	339
Connecting via USB	339
Wireless Networks (Wi-Fi)	343
Connecting to Printers	344
Printing Pictures One at a Time	345
Printing Multiple Pictures	346
Connecting to HDMI Devices	347
HDMI Recorders	348
On-Camera Flash Photography	351
<hr/>	
“On-Camera” Versus “Remote”	351
Camera-Mounted Flash Units	351
Remote Flash Photography	351
Using an On-Camera Flash	352
Flash Control Mode.....	354
Flash Modes	356
Flash Compensation	358
FV Lock	359
Flash Info for On-Camera Units	361

Remote Flash Photography	364
Using Remote Flash Units	364
Radio AWL	366
Establishing a Wireless Connection.....	366
Adjusting Flash Settings	370
Adding a Shoe-Mounted Flash Unit.....	376
Optical AWL	377
Using Optical AWL with the SB-5000 or SB-500.....	377
Optical/Radio AWL	385
Viewing Flash Info	386
Troubleshooting	389
Problems and Solutions	390
Battery/Display.....	390
Shooting.....	391
Playback.....	393
Bluetooth and Wi-Fi (Wireless Networks).....	395
Miscellaneous	395
Indicators and Error Messages	396
Indicators.....	396
Error Messages	398

The Camera Display and Control Panel	400
The Monitor: Photo Mode	400
The Monitor: Movie Mode	405
The Viewfinder: Photo Mode.....	406
The Viewfinder: Movie Mode.....	408
The Control Panel	409
The Nikon Creative Lighting System	410
Other Accessories.....	415
Attaching a Power Connector and AC Adapter.....	420
Caring for the Camera	422
Storage	422
Cleaning	422
Image Sensor Cleaning.....	423
Manual Cleaning	426
Caring for the Camera and Battery: Cautions.....	428
Specifications.....	433
NIKKOR Z 24–70mm f/4 S Lens User’s Manual.....	452
FTZ Mount Adapter User’s Manual	461
Approved Memory Cards	468
Memory Card Capacity.....	469
Battery Endurance	471
Index.....	472

For Your Safety

To prevent damage to property or injury to yourself or to others, read “For Your Safety” in its entirety before using this product.

Keep these safety instructions where all those who use this product will read them.

⚠ DANGER: Failure to observe the precautions marked with this icon carries a high risk of death or severe injury.

⚠ WARNING: Failure to observe the precautions marked with this icon could result in death or severe injury.

⚠ CAUTION: Failure to observe the precautions marked with this icon could result in injury or property damage.



WARNING

• Do not use while walking or operating a vehicle.

Failure to observe this precaution could result in accidents or other injury.

• Do not disassemble or modify this product. Do not touch internal parts that become exposed as the result of a fall or other accident.

Failure to observe these precautions could result in electric shock or other injury.

• Should you notice any abnormalities such as the product producing smoke, heat, or unusual odors, immediately disconnect the battery or power source.

Continued operation could result in fire, burns or other injury.

• Keep dry. Do not handle with wet hands. Do not handle the plug with wet hands.

Failure to observe these precautions could result in fire or electric shock.

• Do not let your skin remain in prolonged contact with this product while it is on or plugged in.

Failure to observe this precaution could result in low-temperature burns.

• Do not use this product in the presence of flammable dust or gas such as propane, gasoline or aerosols.

Failure to observe this precaution could result in explosion or fire.

- **Do not directly view the sun or other bright light source through the lens.**

Failure to observe this precaution could result in visual impairment.

- **Do not aim the flash or AF-assist illuminator at the operator of a motor vehicle.**

Failure to observe this precaution could result in accidents.

- **Keep this product out of reach of children.**

Failure to observe this precaution could result in injury or product malfunction. In addition, note that small parts constitute a choking hazard. Should a child swallow any part of this product, seek immediate medical attention.

- **Do not entangle, wrap or twist the straps around your neck.**

Failure to observe this precaution could result in accidents.

- **Do not use batteries, chargers, or AC adapters not specifically designated for use with this product. When using batteries, chargers, and AC adapters designated for use with this product, do not:**

- **Damage, modify, forcibly tug or bend the cords or cables, place them under heavy objects, or expose them to heat or flame.**
- **Use travel converters or adapters designed to convert from one voltage to another or with DC-to-AC inverters.**

Failure to observe these precautions could result in fire or electric shock.

- **Do not handle the plug when charging the product or using the AC adapter during thunderstorms.**

Failure to observe this precaution could result in electric shock.

- **Do not handle with bare hands in locations exposed to extremely high or low temperatures.**

Failure to observe this precaution could result in burns, or frostbite.



CAUTION

- **Do not leave the lens pointed at the sun or other strong light sources.**

Light focused by the lens could cause fire or damage to product's internal parts. When shooting backlit subjects, keep the sun well out of the frame. Sunlight focused into the camera when the sun is close to the frame could cause fire.

- **Turn this product off when its use is prohibited. Disable wireless features when the use of wireless equipment is prohibited.**

The radio-frequency emissions produced by this product could interfere with equipment onboard aircraft or in hospitals or other medical facilities.

- **Remove the battery and disconnect the AC adapter if this product will not be used for an extended period.**

Failure to observe this precaution could result in fire or product malfunction.

- **Do not fire the flash in contact with or in close proximity to the skin or objects.**

Failure to observe this precaution could result in burns or fire.

- **Do not leave the product where it will be exposed to extremely high temperatures, for an extended period such as in an enclosed automobile or in direct sunlight.**

Failure to observe this precaution could result in fire or product malfunction.

- **Do not look directly at the AF-assist illuminator.**

Failure to observe this precaution could have adverse effects on vision.

- **Do not transport cameras or lenses with tripods or similar accessories attached.**

Failure to observe this precaution could result in injury or product malfunction.



DANGER (Batteries)

- **Do not mishandle batteries.**

Failure to observe the following precautions could result in the batteries leaking, overheating, rupturing, or catching fire:

- Use only rechargeable batteries approved for use in this product.
 - Do not expose batteries to flame or excessive heat.
 - Do not disassemble.
 - Do not short-circuit the terminals by touching them to necklaces, hairpins, or other metal objects.
 - Do not expose batteries or the products in which they are inserted to powerful physical shocks.
 - Do not step on batteries, pierce them with nails, or strike them with hammers.
-

- **Charge only as indicated.**

Failure to observe this precaution could result in the batteries leaking, overheating, rupturing, or catching fire.

- **If battery liquid comes into contact with the eyes, rinse with plenty of clean water and seek immediate medical attention.**

Delaying action could result in eye injuries.



WARNING (Batteries)

- **Keep batteries out of reach of children.**

Should a child swallow a battery, seek immediate medical attention.

- **Keep batteries out of reach of household pets and other animals.**

The batteries could leak, overheat, rupture, or catch fire if bitten, chewed, or otherwise damaged by animals.

- **Do not immerse batteries in water or expose to rain.**

Failure to observe this precaution could result in fire or product malfunction. Immediately dry the product with a towel or similar object should it become wet.

- **Discontinue use immediately should you notice any changes in the batteries, such as discoloration or deformation. Cease charging EN-EL15b rechargeable batteries if they do not charge in the specified period of time.**

Failure to observe these precautions could result in the batteries leaking, overheating, rupturing, or catching fire.

- **When batteries are no longer needed, insulate the terminals with tape.**

Overheating, rupture, or fire may result should metal objects come into contact with the terminals.

- **If battery liquid comes into contact with a person's skin or clothing, immediately rinse the affected area with plenty of clean water.**

Failure to observe this precaution could result in skin irritation.

Notices

- No part of the manuals included with this product may be reproduced, transmitted, transcribed, stored in a retrieval system, or translated into any language in any form, by any means, without Nikon's prior written permission.
- Nikon reserves the right to change the appearance and specifications of the hardware and software described in these manuals at any time and without prior notice.
- Nikon will not be held liable for any damages resulting from the use of this product.
- While every effort has been made to ensure that the information in these manuals is accurate and complete, we would appreciate it were you to bring any errors or omissions to the attention of the Nikon representative in your area (address provided separately).

Notice Concerning Prohibition of Copying or Reproduction

Note that simply being in possession of material that has been digitally copied or reproduced by means of a scanner, digital camera, or other device may be punishable by law.

• Items prohibited by law from being copied or reproduced

Do not copy or reproduce paper money, coins, securities, government bonds, or local government bonds, even if such copies or reproductions are stamped “Sample.”

The copying or reproduction of paper money, coins, or securities which are circulated in a foreign country is prohibited.

Unless the prior permission of the government has been obtained, the copying or reproduction of unused postage stamps or post cards issued by the government is prohibited.

The copying or reproduction of stamps issued by the government and of certified documents stipulated by law is prohibited.

• Cautions on certain copies and reproductions

The government has issued cautions on copies or reproductions of securities issued by private companies (shares, bills, checks, gift certificates, etc.), commuter passes, or coupon tickets, except when a minimum of necessary copies are to be provided for business use by a company. Also, do not copy or reproduce passports issued by the government, licenses issued by public agencies and private groups, ID cards, and tickets, such as passes and meal coupons.

• Comply with copyright notices

Under copyright law, photographs or recordings of copyrighted works made with the camera cannot be used without the permission of the copyright holder. Exceptions apply to personal use, but note that even personal use may be restricted in the case of photographs or recordings of exhibits or live performances.

Use Only Nikon Brand Electronic Accessories

Nikon cameras are designed to the highest standards and include complex electronic circuitry. Only Nikon brand electronic accessories (including chargers, batteries, AC adapters, and flash accessories) certified by Nikon specifically for use with this Nikon digital camera are engineered and proven to operate within the operational and safety requirements of this electronic circuitry.

The use of non-Nikon electronic accessories could damage the camera and may void your Nikon warranty. The use of third-party rechargeable Li-ion batteries not bearing the Nikon holographic seal shown at right could interfere with normal operation of the camera or result in the batteries overheating, igniting, rupturing, or leaking.

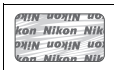

For more information about Nikon brand accessories, contact a local authorized Nikon dealer.

✔ Before Taking Important Pictures

Before taking pictures on important occasions (such as at weddings or before taking the camera on a trip), take a test shot to ensure that the camera is functioning normally. Nikon will not be held liable for damages or lost profits that may result from product malfunction.

✔ Life-Long Learning

As part of Nikon's "Life-Long Learning" commitment to ongoing product support and education, continually-updated information is available on-line at the following sites:

- **For users in the U.S.A.:** <https://www.nikonusa.com/>
 - **For users in Europe and Africa:** <https://www.europe-nikon.com/support/>
 - **For users in Asia, Oceania, and the Middle East:** <https://www.nikon-asia.com/>
- Visit these sites to keep up-to-date with the latest product information, tips, answers to frequently-asked questions (FAQs), and general advice on digital imaging and photography. Additional information may be available from the Nikon representative in your area. See the following URL for contact information: <https://imaging.nikon.com/>

Getting to Know the Camera

Take a few minutes to familiarize yourself with the names and functions of camera controls and displays. You may find it helpful to bookmark this section and refer to it as you read through the rest of the manual.

Parts of the Camera

Refer to this section for the names and locations of camera controls and displays.

Camera Body

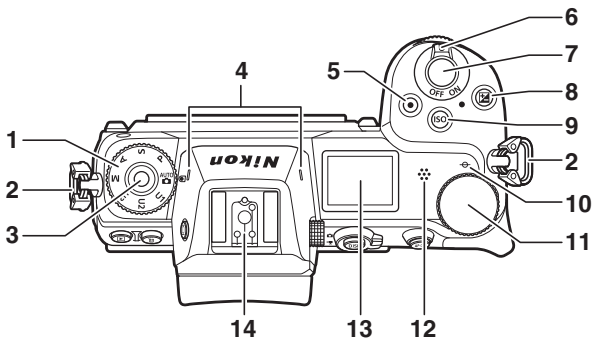

1	Mode dial	72	9	ISO button	82
2	Eyelet for camera strap	27	10	Focal plane mark (—)	63
3	Mode dial lock release	72	11	Main command dial	17, 283
4	Stereo microphone	120	12	Speaker	
5	Movie-record button	45	13	Control panel	5, 299, 400
6	Power switch	38, 41	14	Accessory shoe (for optional flash unit)	410, 418
7	Shutter-release button	41			
8	☑ button	84			

The Camera Body (Continued)

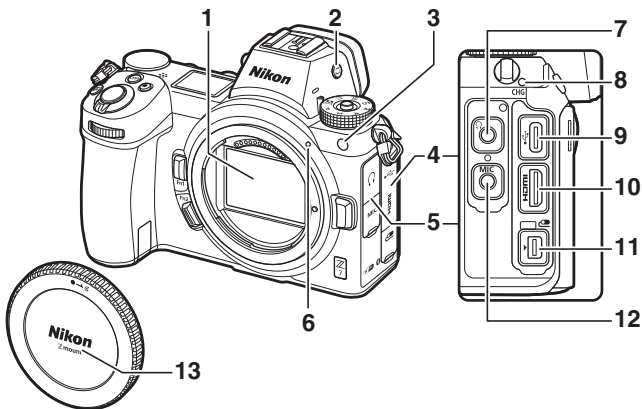

1 Image sensor	423	6 Lens mounting mark	36
2 Monitor mode button	8, 300	7 Headphone connector	247
3 AF-assist illuminator	43, 258	8 CHARGE lamp	29
Red-eye reduction lamp...	109, 356	9 USB connector	339, 415, 419
Self-timer lamp	89	10 HDMI connector	347, 415, 419
4 Cover for accessory terminal and USB and HDMI connectors		11 Accessory terminal.....	415
5 Cover for headphone and microphone connectors		12 Connector for external microphone	415
		13 Body cap.....	36, 415

✓ Do Not Touch the Image Sensor

Under no circumstances should you exert pressure on the image sensor, poke it with cleaning tools, or subject it to powerful air currents from a blower. These actions could scratch or otherwise damage the sensor. For information on cleaning the image sensor, see “Image Sensor Cleaning” (📖 423).

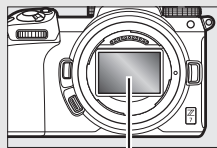
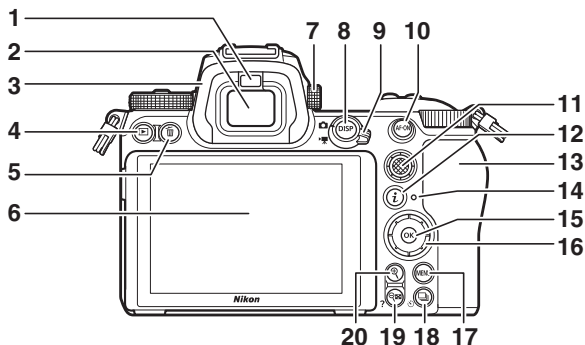

Image sensor



1	Eye sensor	8	11	Sub-selector	17, 91
2	Viewfinder	8	12	i button	21, 94
3	Viewfinder eyepiece	417	13	Memory card slot cover	32
4	▶ button	49	14	Memory card access lamp	44, 88
5	⌫ button	51	15	OK button	18
6	Monitor	10, 60	16	Multi selector	18
7	Diopter adjustment control	8	17	MENU button	18, 145
8	DISP button	15, 126	18	☺ button	86
9	Photo/movie selector	41, 45	19	ⓧ (?) button	20, 125
10	AF-ON button	17	20	ⓧ button	62, 124, 141

✓ The Monitor

The angle of the monitor can be adjusted as shown.

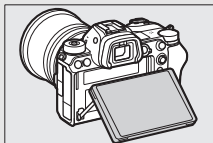
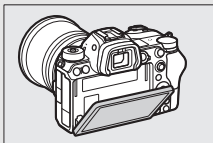

The Camera Body (Continued)

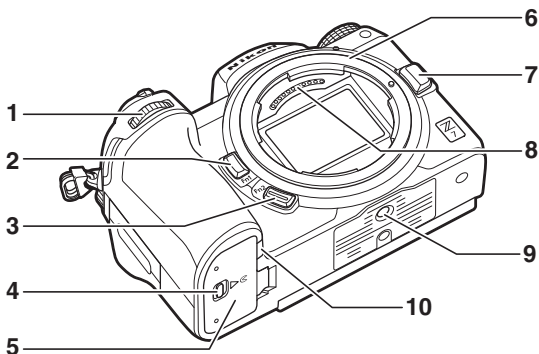

1 Sub-command dial17, 283	6 Lens mount36
2 Fn1 button 24, 64, 273, 287	7 Lens release button37
3 Fn2 button 24, 52, 273, 287	8 CPU contacts
4 Battery-chamber cover latch32	9 Tripod socket80
5 Battery-chamber cover32	10 Power connector cover 420

✓ Product Serial Number

The serial number for this product can be found by opening the monitor.

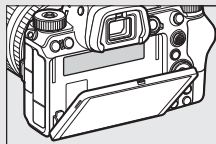

The Control Panel

The control panel lights when the camera is on. At default settings, the following indicators are displayed; for a full list of the indicators that appear in the control panel, see “The Control Panel” (📖 409).

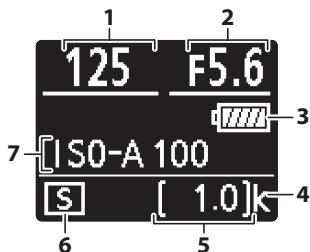

1	Shutter speed	73, 75	5	Number of exposures remaining	34, 469
2	Aperture.....	74	6	Release mode	86
3	Battery indicator	34	7	ISO sensitivity	82
4	“k” (appears when memory remains for over 1000 exposures)	34			

The Monitor and Viewfinder

At default settings, the following indicators appear in the monitor and viewfinder in photo mode; for a full list of indicators, see “The Camera Display and Control Panel” (p. 400).

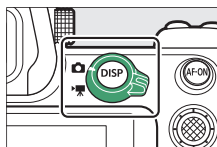

Monitor

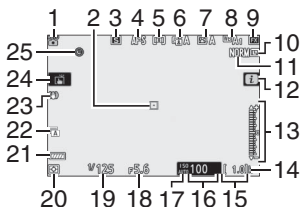

Viewfinder

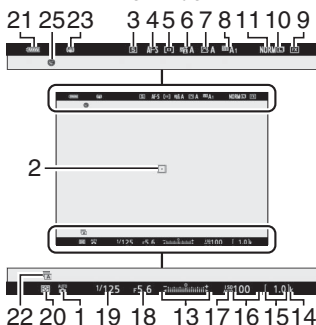

1	Shooting mode72	13	Exposure indicator76
2	Focus point.....43, 54	Exposure compensation display84	
3	Release mode86, 113	14	“k” (appears when memory remains for over 1000 exposures)34
4	Focus mode.....52, 191, 245	15	Number of exposures remaining34, 469
5	AF-area mode54, 191, 245	16	ISO sensitivity82
6	Active D-Lighting 112, 184, 243	17	ISO sensitivity indicator82
7	Picture Control96, 179, 243	Auto ISO sensitivity indicator83	
8	White balance64, 100, 172, 242		
9	Image area 121, 167, 241		
10	Image size..... 108, 168		
11	Image quality 106, 168		
12	i icon..... 13, 21		

18 Aperture.....	74	23 Vibration reduction	
19 Shutter speed	73, 75	indicator.....	114, 191
20 Metering	110, 187, 245	24 Touch shooting	10, 60
21 Battery indicator	34	25 “Clock not set” indicator	40
22 Shutter type	264		

The following items appear in movie mode.

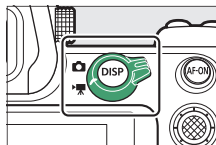

Monitor

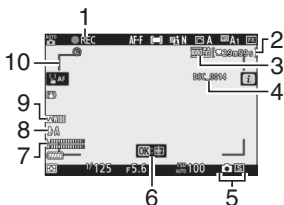

Viewfinder

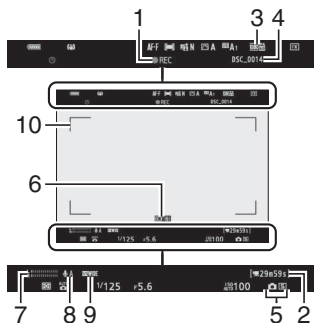

1 Recording indicator.....	45	5 Release mode	
Recording disabled	46	(still photography).....	86
2 Time remaining	45	6 Subject tracking.....	59
3 Frame size and rate/ image quality	118, 241	7 Sound level	120
4 File name	241	8 Microphone sensitivity.....	120, 246
		9 Frequency response.....	247
		10 AF-area brackets	54

Camera Controls

This section outlines how to use various camera controls and displays.

The Viewfinder

Placing your eye to the viewfinder activates the eye sensor, switching the display from the monitor to the viewfinder (note that the eye sensor will also respond to other objects, such as your fingers). The viewfinder can be used for menus and playback if desired.

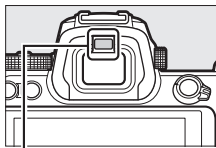

Eye sensor

The Monitor Mode Button

Press the monitor mode button to cycle between viewfinder and monitor displays.



The Diopter Adjustment Control

To focus the viewfinder, lift and rotate the diopter adjustment control, being careful not to put your fingers or fingernails in your eye. Push the control back in once focus is adjusted to your satisfaction.

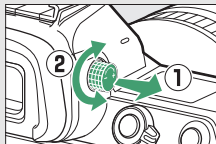

Extended Use

When using the viewfinder for extended periods, you can adjust viewfinder brightness and hue for ease of viewing by selecting **Off** for Custom Setting d8 (**Apply settings to live view**).

Monitor Mode

You can limit the choice of monitor modes available using the **Limit monitor mode selection** option in the setup menu.

Press the monitor mode button to cycle through the displays as follows.

Automatic display switch: The display switches from the monitor to the viewfinder when you place your eye to the viewfinder, and from the viewfinder to the monitor when you take your eye away.



▼

Viewfinder only: The viewfinder is used for shooting, menus, and playback; the monitor remains blank.



▼

Monitor only: The monitor is used for shooting, menus, and playback; the viewfinder display will remain blank even if you put your eye to the viewfinder.



▼

Prioritize viewfinder: The camera functions in a manner similar to existing digital SLR cameras. Placing your eye to the viewfinder turns the viewfinder on and taking your eye away turns the viewfinder off. In photo mode, the monitor remains blank, while in movie mode, during playback, or while menus are displayed, the monitor will turn on when you take your eye away from the viewfinder.



Touch Controls

The touch-sensitive monitor can be used to adjust camera settings, focus and release the shutter, view photos and movies, enter text, and navigate the menus. Touch controls are not available while the viewfinder is in use.

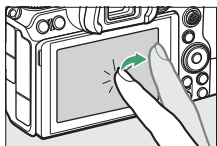

■ ■ *Focusing and Releasing the Shutter*

Touch the monitor to focus on the selected point (touch AF). In photo mode, the shutter will be released when you lift your finger from the display (touch shutter).



Touch AF settings can be adjusted by tapping the  icon (□ 60).



■ ■ Adjusting Settings

Tap highlighted settings in the display and choose the desired option by tapping icons or sliders. Tap **↩** or press **Ⓚ** to select the chosen option and return to the previous display.

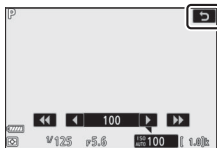

■ ■ Playback

Flick left or right to view other pictures during full-frame playback.

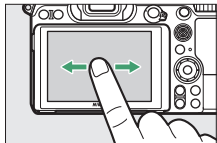

In full-frame view, touching the bottom of the display brings up a frame-advance bar. Slide your finger left or right over the bar to scroll rapidly to other pictures.

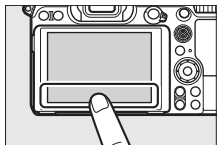

Frame advance bar

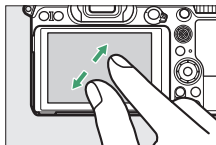

Use stretch and pinch gestures to zoom in and out and slide to scroll. You can also give the display two quick taps to zoom in from full-frame playback or cancel zoom.

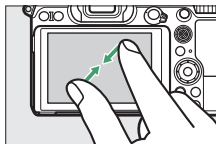

To “zoom out” to a thumbnail view, use a pinch gesture in full-frame playback. Use pinch and stretch to choose the number of images displayed from 4, 9, and 72 frames.



■ **Movie Playback**

Tap the on-screen guide to start movie playback (movies are indicated by a  icon). Tap the display to pause or resume, or tap  to exit to full-frame playback.



Guide

■ ■ The *i* Menu

Tap the  icon to display the *i* menu during shooting (📖 21, 94).



Tap items to view options.

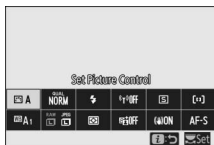

■ ■ Text Entry

When a keyboard is displayed, you can enter text by tapping the keys (to cycle through the upper- and lower-case and symbol keyboards, tap the keyboard selection button) or move the cursor by tapping in the text display area.

Text display area

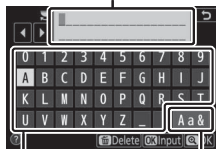

Keyboard area

Keyboard selection

■ Navigating the Menus

Slide up or down to scroll.

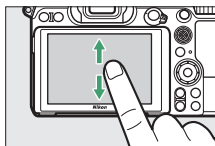

Tap a menu icon to choose a menu.

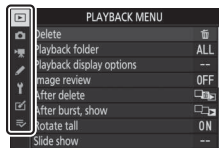

Tap menu items to display options and tap icons or sliders to change.

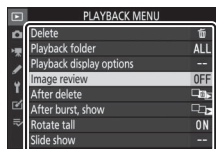

To exit without changing settings, tap ↶.

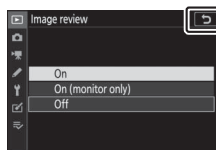

✓ The Touch Screen

The touch screen responds to static electricity and may not respond when covered with third-party protective films, when touched with fingernails or gloved hands, or when touched simultaneously in multiple locations. Do not use excessive force or touch the screen with sharp objects.

✓ Enabling or Disabling Touch Controls

Touch controls can be enabled or disabled using the **Touch controls** option in the setup menu (☞ 307).

The DISP Button

Use the **DISP** button to view or hide indicators in the monitor or viewfinder.

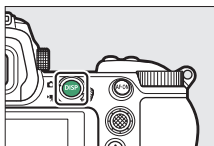

■ Photo Mode

In photo mode, pressing the **DISP** button cycles the display as follows:

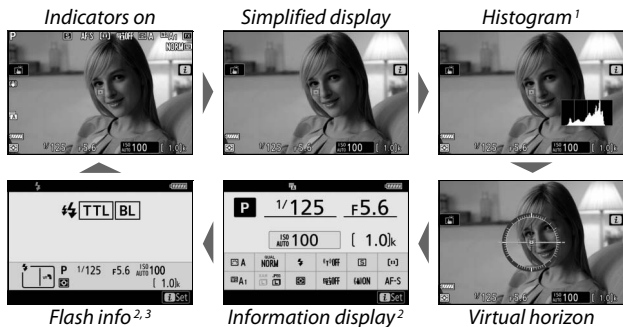

- 1 Not displayed when **Off** is selected for Custom Setting d8 (**Apply settings to live view**) or **On** is selected for **Overlay shooting** in multiple exposure mode.
- 2 Not displayed in the viewfinder.
- 3 Displayed when an optional SB-5000, SB-500, SB-400, or SB-300 flash unit is mounted on the accessory shoe or a WR-R10 wireless remote controller commands a flash unit via radio flash control.

■ ■ *Movie Mode*

In movie mode, pressing the **DISP** button cycles the display as follows:

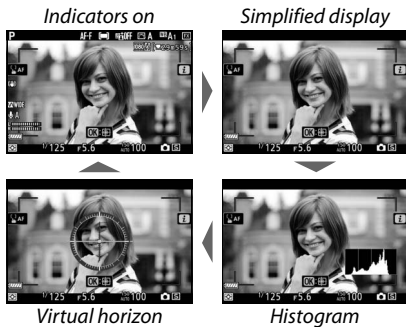

The Sub-Selector

Use the sub-selector as a joystick to select the focus point, or press the center of the sub-selector to lock focus and exposure (📖 91, 92).

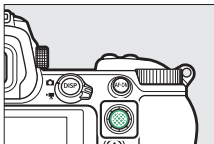

The AF-ON Button

In autofocus mode, the **AF-ON** button can be used to focus.

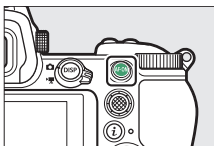

The Command Dials

Use the command dials to adjust shutter speed or aperture or in combination with other buttons to change camera settings.

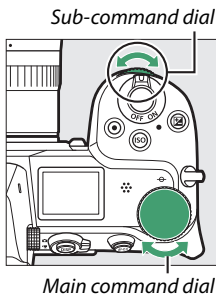

The MENU Button

Press the MENU button to view the menus.

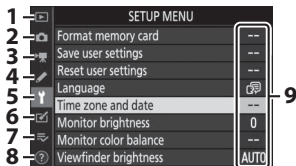
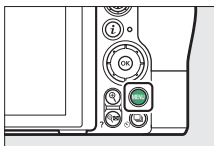

1	▶: Playback menu	156
2	📷: Photo shooting menu.....	162
3	🎬: Movie shooting menu	240
4	🔧: Custom Settings menu.....	249
5	⚙️: Setup menu	295
6	👉: Retouch menu.....	316
7	🏠/🔄: My Menu or recent settings (defaults to My Menu)	333
8	❓: Help icon	20
9	Current settings	145

Using the Menus

You can navigate the menus using the multi selector and **OK** button.

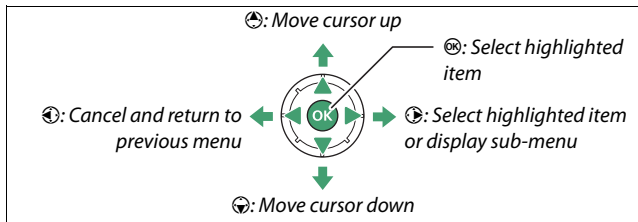

1 Highlight the icon for the current menu.

Press  to highlight the icon for the current menu.

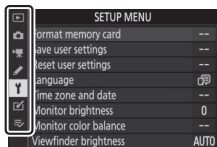

2 Select a menu.

Press  or  to select the desired menu.



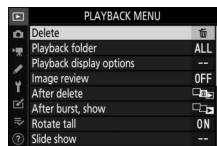

3 Position the cursor in the selected menu.

Press  to position the cursor in the selected menu.



4 Highlight a menu item.

Press  or  to highlight a menu item (items that are displayed in gray are not currently available and cannot be selected).

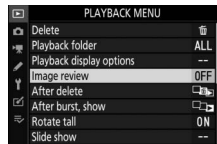

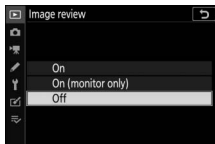

5 Display options.

Press  to display options for the selected menu item.



6 Highlight an option.

Press  or  to highlight an option (options that are displayed in gray are not currently available and cannot be selected).

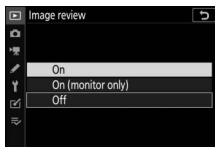





7 Select the highlighted item.

Press  to select the highlighted item. To exit without making a selection, press the MENU button. To exit the menus and return to shooting mode, press the shutter-release button halfway.



You can also navigate the menus using touch controls ( 14).

The (Help) Icon

If a  icon appears at the bottom left corner of the display, you can view a description of the currently selected option or menu by pressing the  (?). Press  or  to scroll the text, or press  (?) again to return to the menus.

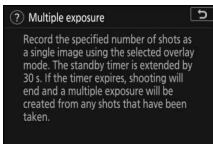
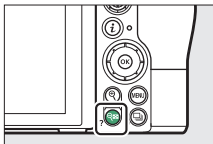

The **i** Button (**i** Icon)

For quick access to frequently-used settings, press the **i** button or tap the **i** icon in the display.



Tap the desired item or highlight items and press **OK** to view options. You can also adjust settings by highlighting items and rotating the command dials. The items displayed in photo mode (📖 95) differ from those displayed in movie mode (📖 116).

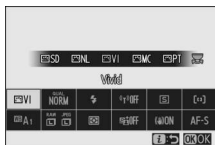

The Playback **i** Menu

Pressing the **i** button during playback displays a context-sensitive menu of frequently-used playback options.

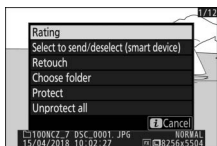

■ Customizing the *i* Menu

The items displayed in the photo-mode *i* menu can be chosen using Custom Setting f1 (**Customize *i* menu**).

1 Select Custom Setting f1.

In the Custom Settings menu, highlight Custom Setting f1 (**Customize *i* menu**) and press **OK** (for information on using the menus, see “The MENU Button”, [p 18](#)).



2 Choose a position.

Highlight a position in the menu you want to edit and press **OK**.



3 Choose an option.

Highlight an option and press **OK** to assign it to the selected position and return to the menu displayed in Step 2. Repeat Steps 2 and 3 as desired.

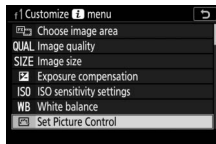

4 Exit.

Press the **MENU** button to save changes and exit.

Options That Can Be Assigned to the **i** Menu

The following options can be assigned to the **i** menu for photo mode:

- Choose image area
- Image quality
- Image size
- Exposure compensation
- ISO sensitivity settings
- White balance
- Set Picture Control
- Color space
- Active D-Lighting
- Long exposure NR
- High ISO NR
- Metering
- Flash mode
- Flash compensation
- Focus mode
- AF-area mode
- Vibration reduction
- Auto bracketing
- Multiple exposure
- HDR (high dynamic range)
- Silent photography
- Release mode
- Custom control assignment
- Exposure delay mode
- Shutter type
- Apply settings to live view
- Split-screen display zoom
- Peaking highlights
- Monitor/viewfinder brightness
- Bluetooth connection
- Wi-Fi connection

The movie-mode **i** menu can be customized using Custom Setting g1 (**Customize  menu**); the options available differ from those for photo mode.

The Function Buttons (Fn1 and Fn2)

The **Fn1** and **Fn2** buttons can also be used for quick access to selected settings during shooting. The settings assigned to these buttons can be chosen using Custom Setting f2 (**Custom control assignment**) and the selected setting adjusted by pressing the button and rotating the command dials. At default settings, the **Fn1** button is used for white balance and the **Fn2** button to select focus and AF-area modes.

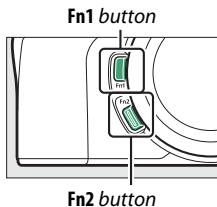

■ Customizing the Function Buttons

The function performed by the function buttons in photo mode are chosen using Custom Setting f2 (**Custom control assignment**).

1 Select Custom Setting f2.

In the Custom Settings menu, highlight Custom Setting f2 (**Custom control assignment**) and press **OK** (for information on using the menus, see “The MENU Button”, [p 18](#)).



2 Choose a button.

Highlight the option for the desired button and press **OK**. Select **Fn1 button** to choose the role played by the **Fn1 button**, **Fn2 button** to choose the role played by the **Fn2 button**.



3 Choose an option.

Highlight an option and press **OK** to assign it to the selected button and return to the menu displayed in Step 2. Repeat Steps 2 and 3 to choose the role played by the remaining button.

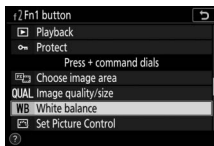

4 Exit.

Press the **MENU** button to save changes and exit.

Roles That Can Be Assigned to the Function Buttons

The following roles can be assigned to the function buttons in photo mode:

- AF-ON
- AF lock only
- AE lock (Hold)
- AE lock (Reset on release)
- AE lock only
- AE/AF lock
- FV lock
- ⚡ Disable/enable
- Preview
- Matrix metering
- Center-weighted metering
- Spot metering
- Highlight-weighted metering
- Bracketing burst
- Sync. release selection
- + NEF (RAW)
- Subject tracking
- Framing grid display
- Zoom on/off
- MY MENU
- Access top item in MY MENU
- Playback
- Protect
- Choose image area
- Image quality/size
- White balance
- Set Picture Control
- Active D-Lighting
- Metering
- Flash mode/compensation
- Focus mode/AF-area mode
- Auto bracketing
- Multiple exposure
- HDR (high dynamic range)
- Exposure delay mode
- Shutter spd & aperture lock
- Peaking highlights
- Rating
- Choose non-CPU lens number
- None

The roles played by the function buttons in movie mode can be chosen using Custom Setting g2 (**Custom control assignment**); the options available differ from those for photo mode.

First Steps

Complete the steps in this chapter before taking pictures for the first time.

Attach the Camera Strap

A strap is supplied with the camera; additional straps are available separately. Attach the strap securely to the camera eyelets.

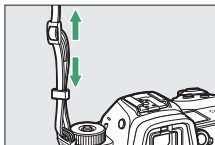
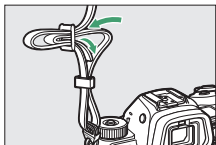
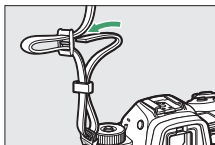
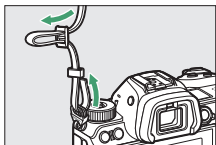

Charge the Battery

Charge the supplied EN-EL15b battery before use.

✔ The Battery and Charger

Read and follow the warnings and cautions in "For Your Safety" (☞ xvi) and "Caring for the Camera and Battery: Cautions" (☞ 428).

The Battery Charger

Insert the supplied EN-EL15b battery and plug the charger in. Depending on the country or region, the charger comes with either an AC wall adapter or a power cable.

- **AC wall adapter:** Insert the AC wall adapter into the charger AC inlet (①). Slide the AC wall adapter latch as shown (②) and rotate the adapter 90° to fix it in place (③). Insert the battery and plug the charger in.

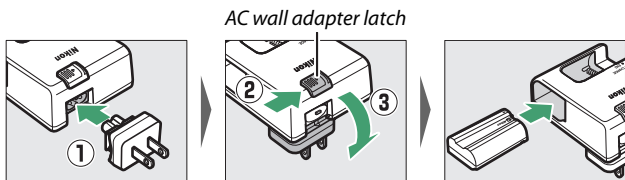

- **Power cable:** After connecting the power cable with the plug in the orientation shown, insert the battery and plug the cable in.

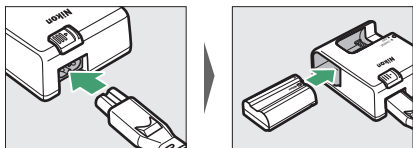

The **CHARGE** lamp will flash while the battery charges. An exhausted battery will fully charge in about two hours and 35 minutes.

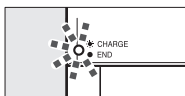

Battery charging

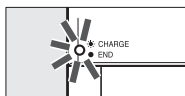

Charging complete

Charging AC Adapters

When inserted in the camera, EN-EL15b rechargeable Li-ion batteries will charge while the camera is connected to an optional EH-7P charging AC adapter (the EH-7P cannot be used to charge EN-EL15a and EN-EL15 batteries; use the supplied MH-25a battery charger instead). An exhausted battery will fully charge in about two hours and 35 minutes. Note that in countries or regions where required, charging AC adapters are supplied with a plug adapter attached; the shape of the plug adapter varies with the country of sale.

-
- 1** Insert the EN-EL15b into the camera (📖 32).

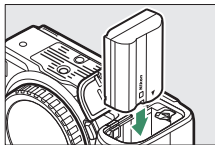

-
- 2** After confirming that the camera is off, connect the charging AC adapter and plug the adapter in. Insert the plug or plug adapter straight into the socket rather than at an angle, and observe the same precaution when unplugging the charging AC adapter.

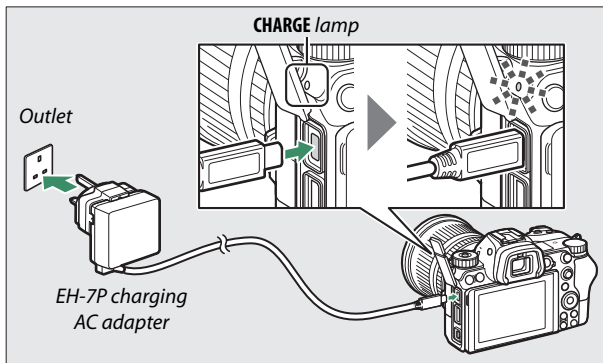

The camera **CHARGE** lamp lights amber while charging is in progress and turns off when charging is complete. Note that although the camera can be used while connected, the battery will not charge and the camera will not draw power from the charging AC adapter while the camera is on.

-
- 3** Unplug and disconnect the charging AC adapter when charging is complete.

 **The CHARGE Lamp**

If the battery cannot be charged using the charging AC adapter, for example because the battery is not compatible or the temperature of the camera is elevated, the **CHARGE** lamp will flash rapidly for about 30 seconds and then turn off. If the **CHARGE** lamp is off and you did not observe the battery charging, turn the camera on and check the battery level.

Insert the Battery and a Memory Card

Before inserting or removing the battery or memory cards, confirm that the camera power switch is in the **OFF** position. Insert the battery in the orientation shown, using the battery to keep the orange battery latch pressed to one side. The latch locks the battery in place when the battery is fully inserted.

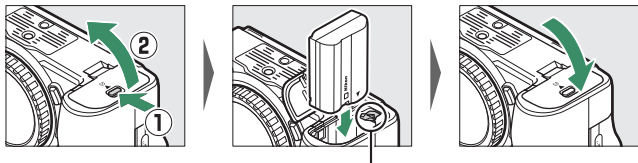

Battery latch

Holding the memory card in the orientation shown, slide it straight into the slot until it clicks into place.

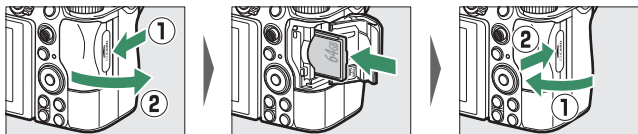

✔ Removing the Battery

To remove the battery, turn the camera off and open the battery-chamber cover. Press the battery latch in the direction shown by the arrow to release the battery and then remove the battery by hand.

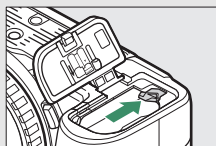

✔ Removing Memory Cards



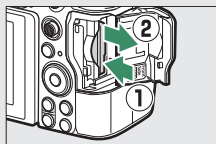



After confirming that the memory card access lamp is off, turn the camera off, open the memory card slot cover, and press the card in to eject it (①). The card can then be removed by hand (②).

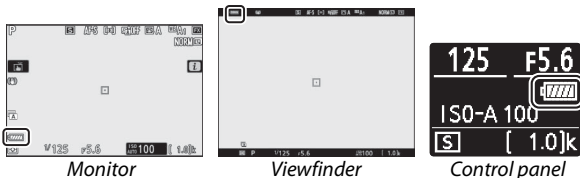

Battery Level

The battery level is shown in the shooting display and control panel while the camera is on.



The battery level display changes as the battery level diminishes, from  through , , and finally, . When the battery level falls to , suspend shooting and charge the battery or ready a spare battery. When the battery is exhausted, the  icon will flash; charge the battery or insert a fully-charged spare battery.

Number of Exposures Remaining

When the camera is on, the shooting display and control panel show the number of photographs that can be taken at current settings (values over 1000 are rounded down to the nearest hundred; e.g., values between 1400 and 1499 are shown as 1.4 k).

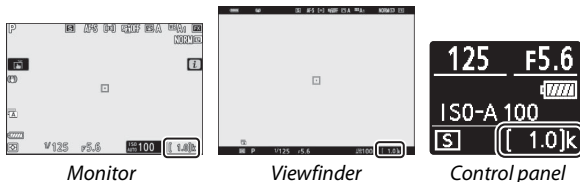

✔ Memory Cards

- Memory cards may be hot after use. Observe due caution when removing memory cards from the camera.
- Turn the power off before inserting or removing memory cards. Do not remove memory cards from the camera, turn the camera off, or remove or disconnect the power source during formatting or while data are being recorded, deleted, or copied to a computer or other device. Failure to observe these precautions could result in loss of data or in damage to the camera or card.
- Do not touch the card terminals with your fingers or metal objects.
- Do not bend, drop, or subject to strong physical shocks.
- Do not apply force to the card casing. Failure to observe this precaution could damage the card.
- Do not expose to water, heat, high levels of humidity, or direct sunlight.
- Do not format memory cards in a computer.

✔ No Memory Card

If no memory card is inserted, a “no memory card” indicator will appear in the shooting display and [-E-] will appear in both the control panel and the shooting display.

Attach a Lens

The camera can be used with Z mount lenses. Before attaching or removing lenses, confirm that the camera power switch is in the **OFF** position. Be careful to prevent dust from entering the camera when the lens or body cap is removed, and be sure to remove the lens cap before taking pictures. The lens generally used in this manual for illustrative purposes is a NIKKOR Z 24–70mm f/4 S.

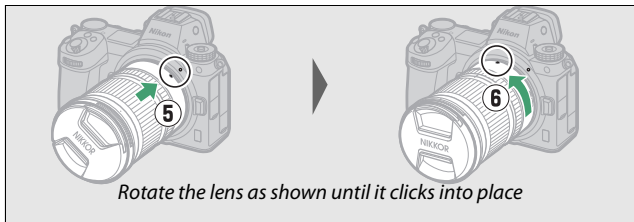
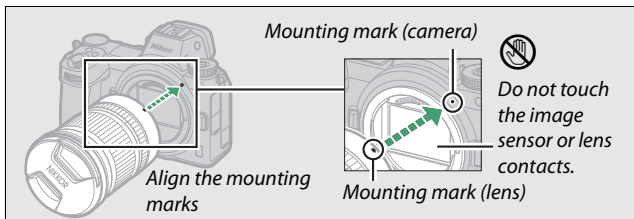
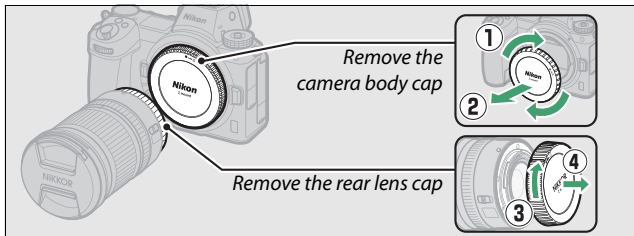

✓ F Mount Lenses

Be sure to attach the FTZ mount adapter (supplied or available separately, □ 461) before using F mount lenses. Attempting to attach F mount lenses directly to the camera could damage the lens or image sensor.

✓ Detaching Lenses

Be sure the camera is off when removing or exchanging lenses. To remove the lens, press and hold the lens release button (①) while turning the lens clockwise (②). After removing the lens, replace the lens caps and camera body cap.

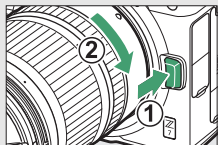

Choose a Language and Set the Clock

The language option in the setup menu is automatically highlighted the first time menus are displayed. Choose a language and set the camera clock.

1 Turn the camera on.

Rotate the power switch to **ON**.



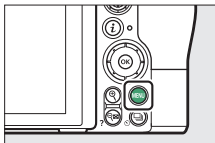

2 Select Language in the setup menu.

Press the **MENU** button to display the camera menus, then highlight **Language** in the setup menu and press **OK** (for information on using menus, see “The MENU Button”,  18).



3 Select a language.

Press  or  to highlight the desired language and press **OK** (the languages available vary with the country or region in which the camera was originally purchased).

4 Select Time zone and date.

Highlight **Time zone and date** and press .



5 Choose a time zone.

Select **Time zone** and choose your current time zone (the display shows selected cities in the chosen zone and the difference between the time in the chosen zone and UTC). Press  to save changes and return to the time zone and date menu.

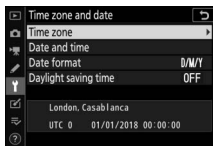

6 Turn daylight saving time on or off.

Select **Daylight saving time**, then highlight **On** or **Off** and press . Selecting **On** advances the clock by one hour.

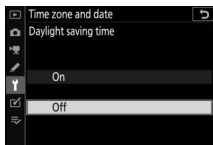

7 Set the clock.

Select **Date and time** and use the multi selector to set the clock. Press  when the clock is set to the current date and time (note that the camera uses a 24-hour clock).

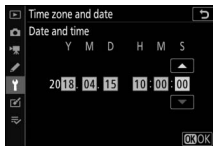

8 Choose a date format.

To choose the order in which the year, month, and day are displayed, select

Date format, then highlight the desired option and press **OK**.

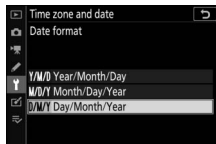

9 Exit to shooting mode.

Press the shutter-release button halfway to exit to shooting mode.



✓ The **⌚** (“Clock Not Set”) Icon

The camera clock is powered by an independent, rechargeable power source, which is charged as necessary when the main battery is installed. Two days of charging will power the clock for about a month. If a **⌚** icon flashes in the display, the clock has been reset and the date and time recorded with new photographs will not be correct. Use the **Time zone and date > Date and time** option in the setup menu to set the clock to the correct time and date (📖 297).

✓ SnapBridge

Use the SnapBridge app to synchronize the camera clock with the clock on a smartphone or tablet (smart device). See SnapBridge online help for details.

Basic Photography and Playback

This chapter explains the basics of taking and viewing photos.

Taking Photographs (AUTO Mode)

Follow the steps below to take photographs in **AUTO** (auto) mode, an automatic “point-and-shoot” mode in which the majority of settings are controlled by the camera in response to shooting conditions.

1 Turn the camera on.

The monitor and control panel will light.



2 Select photo mode.

Rotate the photo/movie selector to .

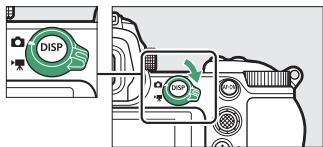

Lenses with Retractable Barrels

Lenses with retractable barrels must be extended before use. Rotate the lens zoom ring as shown until the lens clicks into the extended position.

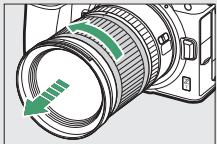

3 Select mode.

Pressing the mode dial lock release on top of the camera, rotate the mode dial to .

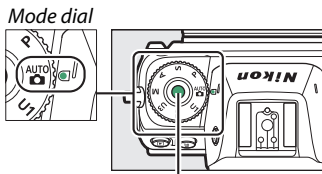

Mode dial lock release

4 Ready the camera.

Hold the handgrip in your right hand and cradle the camera body or lens with your left. Bring your elbows in against the sides of your chest.

Framing photos in the viewfinder



Landscape (wide) orientation



Portrait (tall) orientation

Framing photos in the monitor



Landscape (wide) orientation



Portrait (tall) orientation

7 Shoot.

Smoothly press the shutter-release button the rest of the way down to take the photograph (you can also take a photograph by touching the monitor: touch your subject to focus and lift your finger to release the shutter). The memory card access lamp will light while the photo is recorded to the memory card. *Do not eject the memory card or remove or disconnect the power source until the lamp has gone out and recording is complete.*

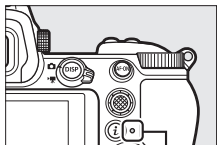

Memory card
access lamp

✓ The Standby Timer

If no operations are performed for about 30 seconds, the display will dim for a few seconds before the monitor, viewfinder, and control panel turn off to reduce the drain on the battery. Press the shutter-release button halfway to reactivate the display. The length of time before the standby timer expires automatically can be selected using Custom Setting c3 (**Power off delay**) > **Standby timer**.

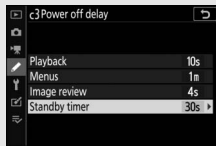

Shooting Movies (AUTO Mode)

^{AUTO} (auto) mode can also be used for simple, “point-and-shoot” movie recording.

1 Turn the camera on.

The monitor and control panel will light.



2 Select movie mode.

Rotate the photo/movie selector to . Note that optional flash units cannot be used when the camera is in movie mode.

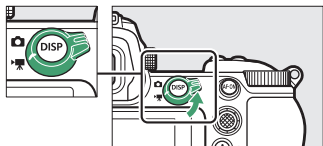

3 Select ^{AUTO} mode.

Pressing the mode dial lock release on top of the camera, rotate the mode dial to ^{AUTO}.

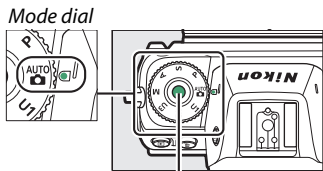

Mode dial lock release

4 Start recording.

Press the movie-record button to start recording. While recording is in progress, the camera will display a recording indicator and the time remaining. The camera can be refocused at any time during recording by pressing the **AF-ON** button or tapping your subject in the display. Sound is recorded via the built-in microphone; do not cover the microphone during recording.

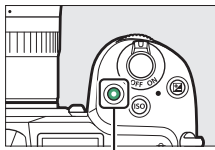

Movie-record button

Recording indicator



Time remaining

5 End recording.

Press the movie-record button again to end recording. The memory card access lamp will light while the camera finishes saving the movie to the memory card. *Do not eject the memory card or remove or disconnect the power source until the lamp has gone out and recording is complete.*

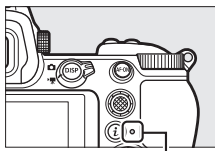
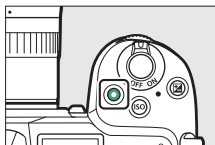

Memory card
access lamp

✓ The Icon

A  icon indicates that movies cannot be recorded.

In movie mode, photos can be taken without interrupting recording by pressing the shutter-release button all the way down. A  icon will flash in the display when a photo is taken.



✓ Taking Photos in Movie Mode

Note that photos can be taken even when the subject is not in focus. Photos are recorded in fine★-quality JPEG format at the dimensions currently selected for movie frame size. In continuous release modes, the frame advance rate while recording is paused varies with the option selected for **Frame size/frame rate**, but only one photo will be taken each time the shutter-release button is pressed while recording is in progress. Up to 50 photographs can be taken with each movie.

✓ During Shooting

Flicker, banding, or distortion may be visible in the display and in photos and movies shot under fluorescent, mercury vapor, or sodium lamps or with subjects that are in motion, particularly if the camera is panned horizontally or an object moves horizontally at high speed through the frame. Jagged edges, color fringing, *moiré*, and bright spots may also appear. Bright regions or bands may appear in some areas of the frame with flashing signs and other intermittent light sources or if the subject is briefly illuminated by a strobe or other bright, momentary light source, while noise (randomly-spaced bright pixels, fog, or lines) and unexpected colors may appear if you zoom in on the view through the lens. Flicker may occur when power aperture is used during movie recording.

Avoid pointing the camera at the sun or other strong light sources. Failure to observe this precaution could result in damage to the camera's internal circuitry.

Recording Movies

Recording ends automatically when the maximum length is reached or the memory card fills or if the lens is removed, another mode is selected, or the photo/movie selector is rotated to . Note that the built-in microphone may record sounds made by the camera or lens during vibration reduction, autofocus, or changes to aperture.

Basic Playback



Photographs and movies can be viewed on the camera.

1 Press the button.

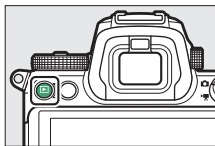
A picture will appear in the display.





2 View additional pictures.

Press  or  to view additional pictures. When pictures are displayed in the monitor, you can view other pictures by flicking a finger left or right over the display. To end playback and return to shooting mode, press the shutter-release button halfway.







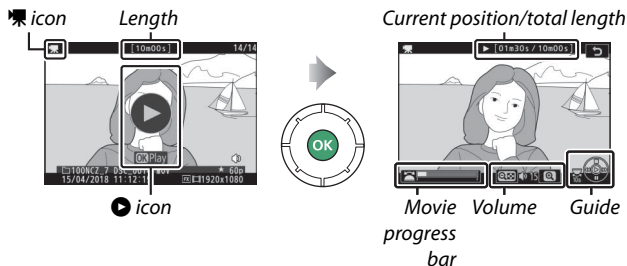







Viewing Movies

Movies are indicated by a  icon. Tap the  icon in the display or press  to start playback; your current position is shown on the movie progress bar.



The following operations can be performed:

Operation	Description
Pause	Press  to pause playback.
Play	Press  to resume playback when playback is paused or during rewind/advance.
Rewind/advance	Press  to rewind,  to advance. Speed increases with each press, from 2x to 4x to 8x to 16x; keep the control pressed to skip to the beginning or end of the movie (the first frame is indicated by a  in the top right corner of the display, the last frame by a ). If playback is paused, the movie rewinds or advances one frame at a time; keep the control pressed for continuous rewind or advance.
Start slow-motion playback	Press  while the movie is paused to start slow-motion playback.
Skip 10 s	Rotate the main command dial one stop to skip ahead or back 10 s.
Skip to last or first frame	Rotate the sub-command dial to skip to the last or first frame.
Adjust volume	Press  to increase volume,  (?) to decrease.
Trim movie	To view movie editing options, pause playback and press the  button.
Exit	Press  or  to exit to full-frame playback.
Return to shooting mode	Press the shutter-release button halfway to exit to shooting mode.

Deleting Unwanted Pictures



Press the  button to delete the current picture. *Note that pictures cannot be recovered once deleted.*

1 Display a picture you wish to delete.

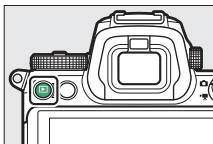
Display a photo or movie you wish to delete as described in “Basic Playback” (📖 49).



2 Delete the picture.

Press the  button. A confirmation dialog will be displayed; press the  button again to delete the picture and return to playback. To exit without deleting the picture, press .

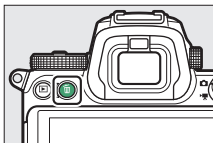

Delete

To delete selected pictures, all pictures taken on selected dates, or all pictures in a chosen location on the memory card, use the **Delete** option in the playback menu.

Basic Settings

This chapter covers basic shooting and playback settings.

Focus

Focus can be adjusted automatically, manually, or using touch controls. How the camera focuses is governed by your choice of focus mode and AF-area mode.

Choosing a Focus Mode

The focus mode controls how the camera focuses. The focus mode can be selected using the **Focus mode** items in the **i** menu and the photo and movie shooting menus (115, 191, 245).



At default settings, the focus mode can also be selected by holding the **Fn2** button and rotating the main command dial (24).

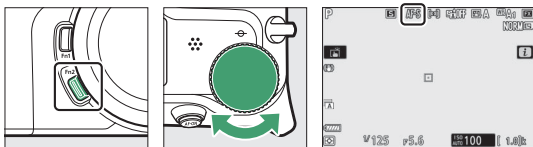

Option	Description
AF-S Single AF	For stationary subjects. Press the shutter-release button halfway to focus. If the camera is able to focus, the focus point will turn from red to green; focus will lock while the shutter-release button is pressed halfway. If the camera fails to focus, the focus point will flash red. At default settings, the shutter can only be released if the camera is able to focus (focus priority).

Option	Description
AF-C Continuous AF	For moving subjects. The camera focuses continuously while the shutter-release button is pressed halfway; if the subject moves, the camera will predict the final distance to the subject and adjust focus as necessary. At default settings, the shutter can be released whether or not the subject is in focus (release priority).
AF-F Full-time AF	The camera adjusts focus continuously in response to subject movement or changes in composition. When the shutter-release button is pressed halfway, the focus point will turn from red to green and focus will lock. This option is only available in movie mode.
MF Manual focus	Focus manually (□ 62). The shutter can be released whether or not the subject is in focus.

✔ Autofocus

The display may brighten or darken while the camera focuses and the focus point may sometimes be displayed in green when the camera is unable to focus. The camera may be unable to focus using autofocus in the following situations:

- The subject contains lines parallel to the long edge of the frame
- The subject lacks contrast
- The subject in the focus point contains areas of sharply contrasting brightness, or includes spot lighting or a neon sign or other light source that changes in brightness
- Flicker or banding appears under fluorescent, mercury-vapor, sodium-vapor, or similar lighting
- A cross (star) filter or other special filter is used
- The subject appears smaller than the focus point
- The subject is dominated by regular geometric patterns (e.g., blinds or a row of windows in a skyscraper)

✔ Turning the Camera Off

The focus position may change if you turn the camera off and then on again after focusing.

✔ Low-Light AF

For improved focus when lighting is poor, select **AF-S** and choose **On** for Custom Setting a11 (**Low-light AF**).



AF-Area Mode



The focus point can be positioned using the sub-selector (📖 91) or multi selector. AF-area mode controls how the camera selects the focus-point for autofocus.

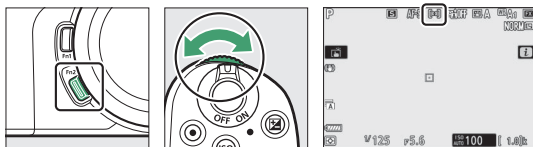





The default setting is **Single-point AF**, but other options can be selected using the **AF-area mode** items in the **i** menu and the photo and movie shooting menus (📖 115, 191, 245).

At default settings, AF-area mode can also be selected by holding the **Fn2** button and rotating the sub-command dial (📖 24).



Option	Description
 Pinpoint AF	Recommended for shots involving static subjects, such as buildings, in-studio product photography, or close-ups. Pinpoint AF is used for pinpoint focus on a selected spot in the frame. This option is only available when photo mode is selected and Single AF is chosen for Focus mode . Focusing may be slower than with single-point AF.
 Single-point AF	The camera focuses on a point selected by the user. Use with stationary subjects.

Option	Description
 Dynamic-area AF	<p>The camera focuses on a point selected by the user. If the subject briefly leaves the selected point, the camera will focus based on information from surrounding focus points. Use for photographs of athletes and other active subjects that are hard to frame using single-point AF. This option is only available when photo mode is selected and Continuous AF is chosen for Focus mode.</p>
 Wide-area AF (S)	<p>As for Single-point AF, except the camera focuses on a wider area, the focus areas for Wide-area AF (L) being larger than those for Wide-area AF (S). Use for snapshots or photos of moving subjects that are hard to frame using single-point AF, or in movie mode for smooth focus during panning and tilting shots or when filming moving subjects. If the selected focus area contains subjects at different distances from the camera, the camera will assign priority to the closest subject.</p>
 Wide-area AF (L)	<p>As for Single-point AF, except the camera focuses on a wider area, the focus areas for Wide-area AF (L) being larger than those for Wide-area AF (S). Use for snapshots or photos of moving subjects that are hard to frame using single-point AF, or in movie mode for smooth focus during panning and tilting shots or when filming moving subjects. If the selected focus area contains subjects at different distances from the camera, the camera will assign priority to the closest subject.</p>

Option	Description
 Auto-area AF	<p>The camera automatically detects the subject and selects the focus area. Use on occasions when you don't have time to select the focus point yourself, for portraits, or for snapshots and other spur-of-the-moment photos. The camera gives priority to portrait subjects; if a portrait subject is detected, an amber border indicating the focus point will appear around the subject's face or, if the camera detects the subject's eyes, one or the other of their eyes (face/eye-detection AF;  57). You can also configure the camera to detect the faces and eyes of dogs and cats by selecting Animal detection for Custom Setting a4 (Auto-area AF face/eye detection; for more information, see "Animal Face/Eye-Detection AF",  58). Face- and eye-detection free you to concentrate on composition and your subject's expression when photographing active human and animal portrait subjects. Subject tracking ( 59) can be activated by pressing the  button or by pressing a button to which subject-tracking AF has been assigned using Custom Setting f2 or g2 (Custom control assignment;  273, 287). Subject-tracking AF can be assigned to the Fn1 and Fn2 buttons on the camera or lens.</p>

 : **The Center Focus Point**

In all AF-area modes except **Auto-area AF**, a dot appears in the focus point when it is in the center of the frame.

 **Quick Focus-Point Selection**

For quicker focus-point selection, choose **Every other point** for Custom Setting a5 (**Focus points used**) to use only a quarter of the available focus points (the number of points available for **Wide-area AF (L)** does not change). If you prefer to use the sub-selector for focus-point selection, you can choose **Select center focus point** for Custom Setting f2 (**Custom control assignment**) > **Sub-selector center** to allow the center of the sub-selector to be used to quickly select the center focus point.

■ ■ Face/Eye-Detection AF

When photographing portrait subjects with **Auto-area AF**, use Custom Setting a4 (**Auto-area AF face/eye detection**) to choose whether the camera detects both faces and eyes (face/eye-detection AF) or only faces (face-detection AF). If **Face and eye detection on** is selected and a portrait subject is detected, an amber border indicating the focus point will appear around the subject's face or, if the camera detects the subject's eyes, one or the other of their eyes (face/eye-

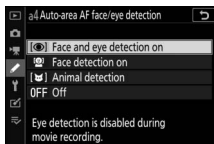

Focus point

detection AF). Faces detected when **Face detection on** is selected are similarly indicated by an amber focus point. If **AF-C** is selected for focus mode, the focus point will light amber when faces or eyes are detected, while if **AF-S** is selected, the focus point will turn green when the camera focuses.

If more than one portrait subject or more than one eye is detected, ◀ and ▶ icons will appear on the focus point, and you will be able to position the focus point over a different face or eye by pressing ◀ or ▶. If the subject looks away after their face is detected, the focus point will move to track their motion.

During playback, you can zoom in on the face or eye used for focus by pressing OK.

✔ Face/Eye-Detection AF

Eye detection is not available in movie mode. Eye and face detection may not perform as expected if:

- the subject's face occupies a very large or very small proportion of the frame,
- the subject's face is lit too brightly or too poorly,
- the subject is wearing glasses or sunglasses,
- the subject's face or eyes are obscured by hair or other objects, or
- the subject moves excessively during shooting.

■ Animal Face/Eye-Detection AF

If **Animal detection** is selected for Custom Setting a4 (**Auto-area AF face/eye detection**) and the camera detects a dog or cat, an amber border indicating the focus point will appear around the subject's face or, if the camera detects the subject's eyes, one or the other of their eyes. If **AF-C** is selected for focus mode, the focus point will light amber when faces or eyes are detected, while if **AF-S** is selected, the focus point will turn green when the camera focuses.

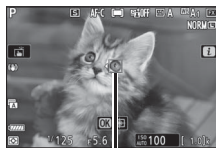
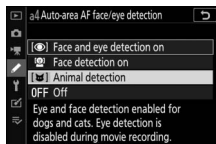

Focus point

If more than one animal or more than one eye is detected, ◀ and ▶ icons will appear on the focus point, and you will be able to position the focus point over a different face or eye by pressing ⌚ or ⌚.

During playback, you can zoom in on the face or eye used for focus by pressing Ⓞ.

✔ Animal Detection AF

Animal eye-detection is not available in movie mode. Animal face- and eye-detection may fail to detect the faces or eyes of some breeds and may not perform as expected if:

- the subject's face occupies a very large or very small proportion of the frame,
- the subject's face is lit too brightly or too poorly,
- the subject's face or eyes are obscured by fur or other objects,
- the subject's eyes are similar in color to the rest of their face, or
- the subject moves excessively during shooting.

The light from the AF-assist illuminator may adversely affect the eyes of some animals; we recommend that you select **Off** for Custom Setting a12 (**Built-in AF-assist illuminator**).

■ ■ Subject Tracking

When **Auto-area AF** is selected for **AF-area mode**, pressing **OK** enables focus tracking. The focus point will change to a targeting reticle; position the reticle over the target and either press **OK** again or press the **AF-ON** button to start tracking.



The focus point will track the selected subject as it moves through the frame (in the case of portrait subjects, focus will track the subject's face). To end tracking and select the center focus point, press **OK** a third time. To exit subject-tracking mode, press the **Q** (?) button.

If **AF-C** is selected for focus mode during still photography and tracking is started using the **AF-ON** button or by pressing the shutter-release button halfway, the camera will track the subject only while the control is pressed. Releasing the control restores the focus point selected before tracking started.

✓ Subject Tracking

The camera may be unable to track subjects if they move quickly, leave the frame or are obscured by other objects, change visibly in size, color, or brightness, or are too small, too large, too bright, too dark, or similar in color or brightness to the background.

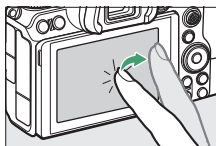

The Touch Shutter

Touch controls can be used to focus and release the shutter. Touch the display to focus and lift your finger to release the shutter.



Tap the icon shown in the illustration to choose the operation performed by tapping the display in shooting mode.

Choose from the following options:

- : Touch the display to position the focus point and focus (if a face is detected, the camera will focus on the face closest to the selected point). Focus locks while your finger remains on the display; lift your finger to release the shutter. Available only in photo mode.
-  AF: As above, except that lifting your finger from the display does not release the shutter. If auto-area AF is selected for AF-area mode, the camera will track the selected subject as it moves through the frame; to switch to a different subject, tap it in the display.
-  OFF: Touch shutter disabled.



✔ Taking Pictures Using Touch Shooting Options

The shutter-release button can be used to focus and take pictures even when the  icon is displayed to show that touch shooting options are active. Touch shooting options can only be used to take pictures one at a time and cannot be used for manual focus or to take photographs during movie recording; for burst photography or to take photos during movie recording, use the shutter-release button.

In cases in which the camera has detected an eye using eye detection or animal eye-detection, the camera may fail to focus on the eye selected using touch controls, in which case it may be necessary to use the multi selector.

In self-timer mode, focus locks on the selected subject when you touch the monitor and the number of shots currently selected in self-timer mode will be taken starting about 10 seconds after you lift your finger from the display.

Manual Focus

Manual focus can be used when autofocus does not produce the desired results. Position the focus point over your subject and rotate the focus or control ring until the subject is in focus.

For greater precision, press the  button to zoom in on the view through the lens.

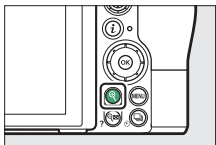
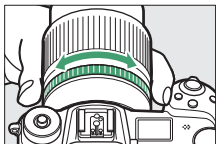

When the subject is in focus, the focus point will light green and the in-focus indicator (●) will appear in the display.

In-focus indicator	Description
●	Subject in focus.
▶	Focus point is between camera and subject.
◀	Focus point is behind subject.
▶ ◀ (flashes)	Camera unable to determine whether subject is in focus.

Focus distance indicator

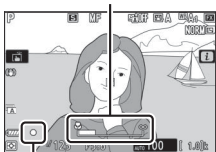

In-focus indicator

When using manual focus with subjects not suited to autofocus, note that the in-focus indicator (●) may be displayed when the subject is not in focus. Zoom in on the view through the lens and check focus. Use of a tripod is recommended when the camera is having trouble focusing.

✓ Lenses with Focus-Mode Selection

Manual focus can be selected using the controls on the lens.

✓ Focal Plane Position

To determine the distance between your subject and the camera, measure from the focal plane mark (⇄) on the camera body. The distance between the lens mounting flange and the focal plane is 16 mm (0.63 in.).

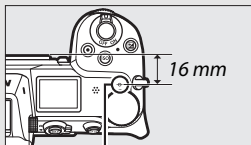

Focal plane mark

✓ Focus Peaking

If focus peaking is enabled using Custom Setting d10 (**Peaking highlights**), objects that are in focus will be indicated by colored outlines in manual focus mode. Note that peaking highlights may not be displayed if the camera is unable to detect outlines, in which case focus can be checked using the view through the lens in the display.

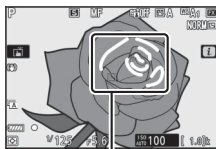

Area in focus

White Balance

White balance ensures that white objects appear white, regardless of the color of the light source. The default setting (**WB A1**) is recommended with most light sources. If the desired results cannot be achieved with auto white balance, choose another option as described below.

White balance can be selected using the **White balance** items in the **i** menu and the photo and movie shooting menus (📖 100, 172, 242).





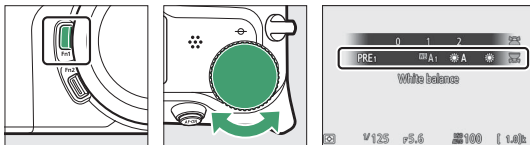



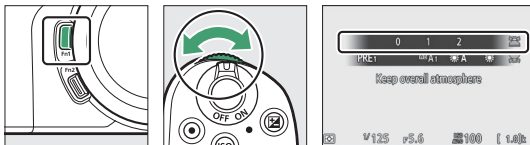

At default settings, white balance can also be selected by holding the **Fn1** button and rotating the main command dial (📖 24).





When **WB A (Auto)**, **☀ (Fluorescent)**, **🌡 (Choose color temperature)**, or **PRE (Preset manual)** is selected, you can choose a sub-option by holding the **Fn1** button and rotating the sub-command dial.



Option	K*	Description
 A Auto		White balance is adjusted automatically for optimal results with most light sources. When an optional flash unit is used, white balance will be adjusted according to the lighting produced by the flash.
Keep white (reduce warm colors)	3500–8000	Eliminate warm color cast produced by incandescent lighting.
Keep overall atmosphere		Partially preserve warm color cast produced by incandescent lighting.
Keep warm lighting colors		Preserve warm color cast produced by incandescent lighting.
 A Natural light auto	4500–8000	When used under natural light, this option produces colors closer to those seen by the naked eye.
 Direct sunlight	5200	Use with subjects lit by direct sunlight.
 Cloudy	6000	Use in daylight under overcast skies.
 Shade	8000	Use in daylight with subjects in shade.
 Incandescent	3000	Use under incandescent lighting.
 Fluorescent		Use under fluorescent lighting; choose bulb type according to light source.
Sodium-vapor lamps	2700	
Warm-white fluorescent	3000	
White fluorescent	3700	
Cool-white fluorescent	4200	
Day white fluorescent	5000	
Daylight fluorescent	6500	
High temp. mercury-vapor	7200	
  Flash	5400	Use with studio strobe lighting and other large flash units.

* Color temperature. All values are approximate and do not reflect fine-tuning (if applicable).

Option	K*	Description
 Choose color temperature	2500–10,000	Choose color temperature from list of values or by holding Fn1 button and rotating sub-command dial.
PRE Preset manual	—	Measure white balance for subject or light source (press and hold Fn1 button to enter direct measurement mode,  103), copy white balance from existing photograph, or choose existing value by holding Fn1 button and rotating sub-command dial.

* Color temperature. All values are approximate and do not reflect fine-tuning (if applicable).

WB A (“Auto”)

The photo info for pictures shot using auto white balance lists the color temperature selected by the camera at the time the picture was taken. You can use this as reference when choosing a value for **Choose color temperature**. To view shooting data during playback, go to **Playback display options** in the playback menu and select **Shooting data**.

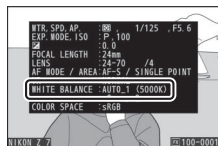

✔ **A** (“Natural Light Auto”)

A (Natural light auto) may not produce the desired results under artificial light. Choose **A (Auto)** or an option that matches the light source.

✔ **Studio Flash Lighting**

A (Auto) may not produce the desired results with large studio flash units. Use preset white balance or set white balance to (**Flash**) and use fine-tuning to adjust white balance.

✔ **White Balance Fine-Tuning**

At settings other than **Choose color temperature**, white balance can be fine-tuned using the **White balance** items in the **i** menu and the photo and movie shooting menus (□ 101).

✔ **Color Temperature**

The perceived color of a light source varies with the viewer and other conditions. Color temperature is an objective measure of the color of a light source, defined with reference to the temperature to which an object would have to be heated to radiate light in the same wavelengths. While light sources with a color temperature in the neighborhood of 5000–5500 K appear white, light sources with a lower color temperature, such as incandescent light bulbs, appear slightly yellow or red. Light sources with a higher color temperature appear tinged with blue.

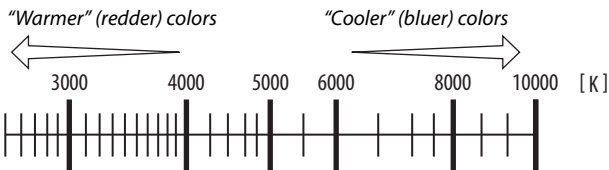

In general, choose lower values if your pictures have a red cast or to intentionally make colors colder, higher values if your pictures are tinged blue or to intentionally make colors warmer.

Silent Photography

To enable the electronic shutter and eliminate the noise and vibration caused by operation of the mechanical shutter, select **On** for **Silent photography** in the photo shooting menu. Regardless of the setting chosen for **Beep options** in the setup menu, no beep will sound when the camera focuses or while the self-timer is counting down. Note that the electronic shutter will be used regardless of the option selected for Custom Setting d5 (**Shutter type**).



An icon is displayed while silent photography is in effect. In release modes other than **Continuous H (extended)**, the display will briefly go dark when the shutter is released to signal that a photo has been taken.



Enabling silent photography changes the frame advance rates for continuous release modes (📖 87) and disables some features, including the flash, long exposure noise reduction, and flicker reduction.

✔ Silent Photography

Selecting **On** for **Silent photography** mutes the shutter, but this does not absolve photographers of the need to respect their subjects' privacy and image rights. Although the noise of the mechanical shutter is muted, other sounds may still be audible, for example during autofocus or aperture adjustment or if the **MENU** or  button is pressed when an option other than **Off** is selected for **Vibration reduction**.

During silent photography, flicker, banding, or distortion may be visible in the display and in the final picture under fluorescent, mercury vapor, or sodium lamps or if the camera or subject moves during shooting. Jagged edges, color fringing, *moiré*, and bright spots may also appear. Bright regions or bands may appear in some areas of the frame with flashing signs and other intermittent light sources or if the subject is briefly illuminated by a strobe or other bright, momentary light source.

Rating Pictures

Selected pictures can be rated or marked as candidates for later deletion. Ratings can also be viewed in Capture NX-D and ViewNX-i. Protected pictures cannot be rated.

1 Select an image.

Press the  button to start playback and display a picture you want to rate.

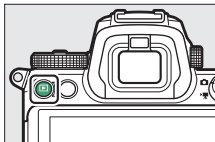

2 Display the *i* menu.

Press the *i* button to view the *i* menu.



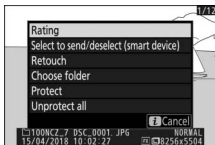

3 Select Rating.

Highlight **Rating** and press .



4 Choose a rating.

Rotate the main command dial to choose a rating of from zero to five stars, or select  to mark the picture as a candidate for later deletion. Press  to complete the operation.



Protecting Pictures from Deletion

Use the **Protect** option in the **i** menu to protect pictures from accidental deletion. Note that this does NOT prevent pictures being deleted when the memory card is formatted.

1 Select an image.

Press the  button to start playback and display a picture you want to protect.

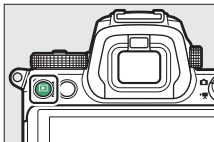



2 Display the **i** menu.

Press the **i** button to view the **i** menu.



3 Select **Protect**.

Highlight **Protect** and press .
Protected pictures are indicated by a  icon; to remove protection, display the picture and repeat Steps 2–3.



Removing Protection from All Pictures

To remove protection from all pictures in the folder or folders currently selected for **Playback folder** in the playback menu, select **Unprotect all** in the **i** menu.

Shooting Controls

This chapter describes controls that can be used during shooting.

The Mode Dial

Press the mode dial lock release and rotate the mode dial to choose from the following modes:

- **AUTO Auto:** A “point-and-shoot” mode in which the camera sets exposure and hue (📖 41, 45).
- **P Programmed auto:** The camera sets shutter speed and aperture for optimal exposure. Recommended for snapshots and in other situations in which there is little time to adjust camera settings.
- **S Shutter-priority auto:** You choose the shutter speed; the camera selects the aperture for best results. Use to freeze or blur motion.
- **A Aperture-priority auto:** You choose the aperture; the camera selects the shutter speed for best results. Use to blur backgrounds or bring both foreground and background into focus.
- **M Manual:** You control both shutter speed and aperture. Set shutter speed to “bulb” or “time” for long time-exposures.
- **U1, U2, U3 User settings modes:** Assign frequently-used settings to these positions for quick recall.

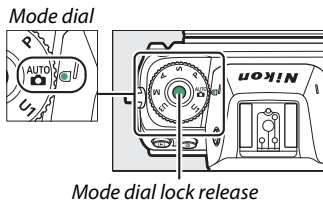

P: Programmed Auto

In this mode, the camera automatically adjusts shutter speed and aperture according to a built-in program to ensure optimal exposure in most situations. Different combinations of shutter speed and aperture that

produce the same exposure can be selected by rotating the main command dial (“flexible program”). While flexible program is in effect, a flexible program indicator (*) is displayed. To restore default shutter speed and aperture settings, rotate the main command dial until the indicator is no longer displayed, choose another mode, or turn the camera off.



S: Shutter-Priority Auto

In shutter-priority auto, you choose the shutter speed while the camera automatically selects the aperture that will produce the optimal exposure. To choose a shutter speed, rotate the main command dial. Shutter speed can be set to “x200” or to values between 30 s and $\frac{1}{8000}$ s and can be locked at the selected setting (📖 283).



Monitor



Control panel

A: Aperture-Priority Auto

In aperture-priority auto, you choose the aperture while the camera automatically selects the shutter speed that will produce the optimal exposure. To choose an aperture between the minimum and maximum values for the lens, rotate the sub-command dial. Aperture can be locked at the selected setting (📖 283).



Monitor

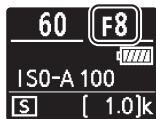

Control panel

✔ Movie Mode Exposure Settings

The following exposure settings can be adjusted in movie mode:

	Aperture	Shutter speed	ISO sensitivity
P, S ¹	—	—	— ^{2,3}
A	✔	—	— ^{2,3}
M	✔	✔	✔ ^{3,4}

- 1 Exposure for mode **S** is equivalent to mode **P**.
- 2 The upper limit for ISO sensitivity can be selected using the **ISO sensitivity settings > Maximum sensitivity** option in the movie shooting menu.
- 3 Regardless of the option chosen for **ISO sensitivity settings > Maximum sensitivity** or for **ISO sensitivity (mode M)**, the upper limit when **On** is selected for **Electronic VR** in the movie shooting menu is ISO 25600 (Z 7) or 51200 (Z 6).
- 4 If **On** is selected for **ISO sensitivity settings > Auto ISO control (mode M)** in the movie shooting menu, the upper limit for ISO sensitivity can be selected using the **Maximum sensitivity** option.

M: Manual

In manual exposure mode, you control both shutter speed and aperture. Rotate the main command dial to choose a shutter speed, and the sub-command dial to set aperture. Shutter speed can be set to “×200” or to values between 30 s and $\frac{1}{8000}$ s, or the shutter can be held open indefinitely for a long time-exposure (80). Aperture can be set to values between the minimum and maximum values for the lens. Use the exposure indicators to check exposure.

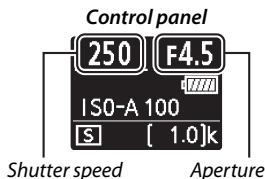
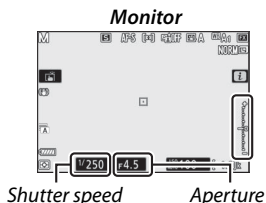

Shutter speed and aperture can be locked at the selected settings.

✓ Exposure Indicators

The exposure indicators show whether the photograph would be under- or over-exposed at current settings. Depending on the option chosen for Custom Setting b1 (**EV steps for exposure cntrl**), the amount of under- or overexposure is shown in increments of $\frac{1}{3}$ or $\frac{1}{2}$ EV. If the limits of the exposure metering system are exceeded, the displays will flash.

Custom Setting b1 set to "1/3 step"			
	Optimal exposure	Underexposed by $\frac{1}{3}$ EV	Overexposed by over 3 EV
Monitor			
Viewfinder			

✓ Auto ISO Sensitivity Control (Mode M)

If auto ISO sensitivity control (☐ 83) is enabled, ISO sensitivity will automatically be adjusted for optimal exposure at the selected shutter speed and aperture.

User Settings: U1, U2, and U3 Modes

Assign frequently-used settings to the **U1**, **U2**, and **U3** positions on the mode dial.

■ Saving User Settings

Follow the steps below to save settings:

1 Select a mode.

Rotate the mode dial to the desired mode.

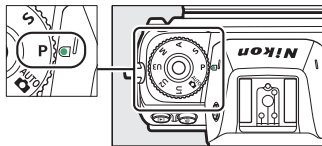

2 Adjust settings.

Make the desired adjustments to camera settings, including:

- photo shooting menu options,
- movie shooting menu options,
- Custom Settings, and
- shooting mode, shutter speed (modes **S** and **M**), aperture (modes **A** and **M**), flexible program (mode **P**), exposure compensation, and flash compensation.

3 Select **Save user settings**.

Highlight **Save user settings** in the setup menu and press .

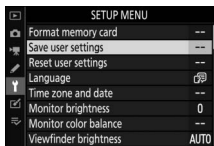

4 Select a position.

Highlight **Save to U1**, **Save to U2**, or **Save to U3** and press .

5 Save user settings.

Highlight **Save settings** and press **OK** to assign the settings selected in Steps 1 and 2 to the mode dial position selected in Step 4.

■ Recalling User Settings

Rotating the mode dial to **U1**, **U2**, or **U3** recalls the settings last saved to that position.

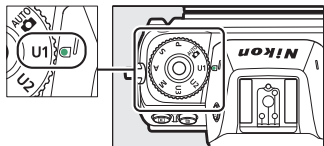

■ Resetting User Settings

To reset settings for **U1**, **U2**, or **U3** to default values:

1 Select **Reset user settings**.

Highlight **Reset user settings** in the setup menu and press **OK**.

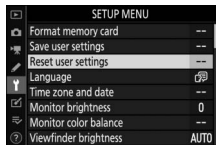

2 Select a position.

Highlight **Reset U1**, **Reset U2**, or **Reset U3** and press **OK**.

3 Reset user settings.

Highlight **Reset** and press **OK** to restore default settings for the selected position. The camera will function in mode **P**.

User Settings

The following cannot be saved to **U1**, **U2**, or **U3**.

Photo shooting menu:

- Storage folder
- Choose image area
- Manage Picture Control
- Multiple exposure
- Interval timer shooting
- Time-lapse movie
- Focus shift shooting

Movie shooting menu:

- Choose image area
- Manage Picture Control

Long Time-Exposures (Mode M)

Select the following shutter speeds for long time-exposures of moving lights, the stars, night scenery, or fireworks.

- **Bulb:** The shutter remains open while the shutter-release button is held down.
- **Time:** The exposure starts when the shutter-release button is pressed and ends when the button is pressed a second time.



- **Shutter speed:** Bulb (35-second exposure)
- **Aperture:** f/25

To prevent blur, mount the camera on a tripod or use an optional wireless remote controller, remote cord, or other remote release device. Nikon also recommends using a fully-charged battery or an optional AC adapter and power connector to prevent loss of power while the shutter is open. Note that noise (bright spots, randomly-spaced bright pixels, or fog) may be present in long exposures. Bright spots and fog can be reduced by choosing **On** for **Long exposure NR** in the photo shooting menu.

1 Ready the camera.

Mount the camera on a tripod or place it on a stable, level surface.

2 Select mode M.

Rotate the mode dial to M.

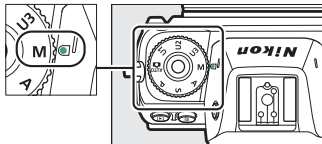

3 Choose a shutter speed.

Rotate the main command dial to choose a shutter speed of **Bulb** or **Time**.

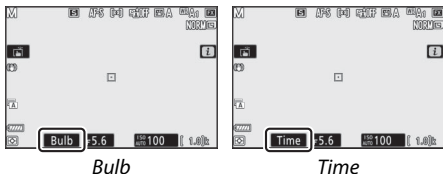

4 Open the shutter.

Bulb: After focusing, press the shutter-release button all the way down. Keep the shutter-release button pressed until the exposure is complete.

Time: Press the shutter-release button all the way down.

5 Close the shutter.

Bulb: Take your finger off the shutter-release button.

Time: Press the shutter-release button all the way down.

The ISO (ISO Sensitivity) Button

Hold the **ISO** button and rotate the main command dial to adjust the camera's sensitivity to light according to the amount of light available. The current setting is shown in the shooting display and control panel. Choose from settings of from ISO 64 to ISO 25600 (or in the case of the Z 6, of from ISO 100 to ISO 51200); settings of from about 0.3 to 1 EV below the lowest of these values and 0.3 to 2 EV above the highest are also available for special situations. **AUTO** mode offers an additional **ISO-A** (auto) option.

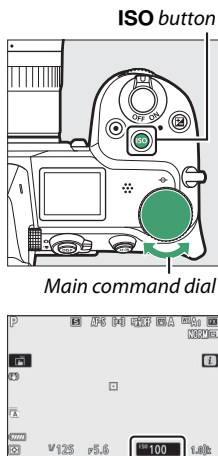

✓ ISO Sensitivity

The higher the ISO sensitivity, the less light needed to make an exposure, allowing faster shutter speeds or smaller apertures, but the more likely the image is to be affected by noise (randomly-spaced bright pixels, fog, or lines). Noise is particularly likely at settings between **Hi 0.3** and **Hi 2**.

✓ Hi 0.3–Hi 2

Hi 0.3 through **Hi 2** correspond to ISO sensitivities 0.3–2 EV over the highest numerical value. **Hi 0.3** is equivalent to ISO 32000 (Z 7) or 64000 (Z 6), **Hi 2** to ISO 102400 (Z 7) or 204800 (Z 6).

✓ Lo 0.3–Lo 1

Lo 0.3 through **Lo 1** correspond to ISO sensitivities 0.3–1 EV below the lowest numerical value. **Lo 0.3** is equivalent to ISO 50 (Z 7) or 80 (Z 6), **Lo 1** to ISO 32 (Z 7) or 50 (Z 6). Use for larger apertures or slow shutter speeds when lighting is bright. Highlights may lose some detail; in most cases, ISO sensitivities at or above the lowest numerical value are recommended.

Auto ISO Sensitivity Control

In modes **P**, **S**, **A**, and **M**, auto ISO sensitivity control can be enabled or disabled by holding the **ISO** button and rotating the sub-command dial. When auto ISO sensitivity control is enabled, ISO sensitivity will automatically be adjusted if optimal exposure cannot be achieved at the value selected with the **ISO** button and main command dial. To prevent ISO sensitivity going too high, you can choose an upper limit of from ISO 100 (Z 7) or 200 (Z 6) to Hi 2 using the **ISO sensitivity settings > Maximum sensitivity** item in the photo shooting menu.

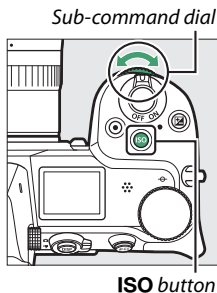

When auto ISO sensitivity control is enabled, the shooting display will show **ISO AUTO** and control panel **ISO-A**. When sensitivity is altered from the value selected by the user, the altered value is shown in the display.



Monitor

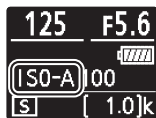

Control panel

✓ Auto ISO Sensitivity Control

If the ISO sensitivity selected by the user is higher than that chosen for **Maximum sensitivity** when auto ISO sensitivity control is enabled, the value selected by the user will be used instead. When a flash is used, shutter speed will be restricted to values between the speed selected for Custom Setting e1 (**Flash sync speed**) and the speed selected for Custom Setting e2 (**Flash shutter speed**).

The (Exposure Compensation) Button

In modes other than **AUTO**, exposure compensation can be used to alter exposure from the value suggested by the camera, making pictures brighter or darker. Choose from values between -5 EV (underexposure) and $+5$ EV (overexposure) in increments of $\frac{1}{3}$ EV (photographs only; the range for movies is -3 to $+3$ EV). In general, positive values make the subject brighter while negative values make it darker.



-1 EV







No exposure
compensation

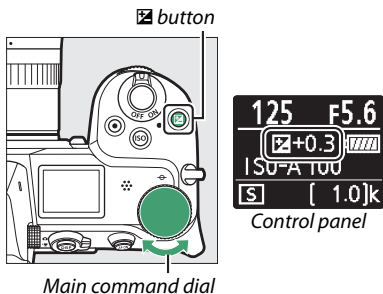

$+1$ EV

To choose a value for exposure compensation, press the  button and rotate the main command dial until the desired value is displayed.



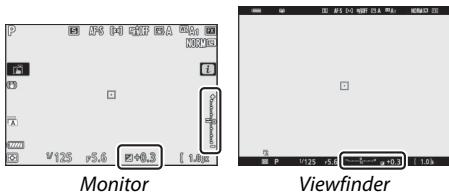

At values other than ± 0.0 , the camera displays a  icon (movie mode) or a  icon and the exposure indicator (photo mode) after you release the  button. The current value for exposure compensation can be confirmed by pressing the  button.



Normal exposure can be restored by setting exposure compensation to ± 0 . Exposure compensation is not reset when the camera is turned off.



Mode M

In mode **M**, exposure compensation affects only the exposure indicator; shutter speed and aperture do not change (ISO sensitivity will, however, automatically be adjusted according to the exposure compensation value selected when auto ISO sensitivity control is enabled;  83). The exposure indicator and the current value for exposure compensation can be displayed by pressing the  button.

Flash Photography



When an optional flash unit is used, exposure compensation affects both flash level and exposure, altering the brightness of both the main subject and the background. Custom Setting e3 (**Exposure comp. for flash**) can be used to restrict the effects of exposure compensation to the background only.

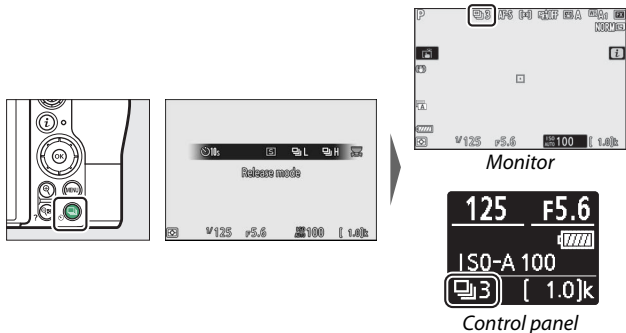

The (Release Mode/Self-Timer) Button

The “release mode” determines what happens when the shutter-release button is pressed. To choose a release mode, hold the  () button and rotate the main command dial. Press  when the desired option is highlighted; the selected option is indicated by icons in the shooting display and control panel.



The following options are available in photo mode.

Option	Description
 Single frame	The camera takes one photograph each time the shutter-release button is pressed.
 Continuous L	While the shutter-release button is held down, the camera records 1–5 frames per second. The frame rate can be chosen by rotating the sub-command dial when Continuous L is highlighted in the release-mode menu.
 Continuous H	While the shutter-release button is held down, the camera records up to about 5.5 frames per second.

Option	Description
 Continuous H (extended)	While the shutter-release button is held down, the camera records up to about 9 frames per second (Z 7) or 12 frames per second (Z 6). Optional flash units cannot be used. Flicker reduction has no effect.
 Self-timer	Take pictures with the self-timer (□ 89).

✓ The Shooting Display

In continuous low-speed and continuous high-speed modes, the display is updated in real time even while shooting is in progress.

✓ Frame Advance Rate

Frame advance rate varies with camera settings. The approximate maximum rates at different settings are given in the table below.

Release mode	Image quality	Bit depth	Silent photography	
			Off	On
Continuous L	JPEG/TIFF	—	5 fps	Z 7: 4 fps
	NEF (RAW)/ NEF (RAW) + JPEG	12		Z 6: 4.5 fps
		14		Z 7: 3.5 fps Z 6: 4 fps
Continuous H	JPEG/TIFF	—	5.5 fps	Z 7: 4 fps
	NEF (RAW)/ NEF (RAW) + JPEG	12		Z 6: 4.5 fps
		14	Z 7: 5 fps Z 6: 5.5 fps	Z 7: 3.5 fps Z 6: 4 fps
Continuous H (extended)	JPEG/TIFF	—	Z 7: 9 fps	Z 7: 8 fps
	NEF (RAW)/ NEF (RAW) + JPEG	12	Z 6: 12 fps	Z 6: 12 fps
		14	Z 7: 8 fps Z 6: 9 fps	Z 7: 6.5 fps Z 6: 8 fps

✔ Continuous H (Extended)

Depending on camera settings, exposure may vary erratically during each burst. This can be prevented by locking exposure (☐ 92).

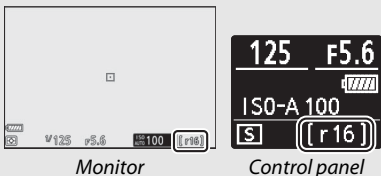

✔ The Memory Buffer

The camera is equipped with a memory buffer for temporary storage, allowing shooting to continue while photographs are being saved to the memory card. The approximate number of images that can be stored in the buffer at current settings is shown in the exposure-count displays while the shutter-release button is pressed halfway.



While photographs are being recorded to the memory card, the memory card access lamp will light. Depending on shooting conditions and memory card performance, recording may take from a few seconds to a few minutes. *Do not remove the memory card or remove or disconnect the power source until the access lamp has gone out.* If the camera is switched off while data remain in the buffer, the power will not turn off until all images in the buffer have been recorded. If the battery is exhausted while images remain in the buffer, the shutter release will be disabled and the images transferred to the memory card.

In movie mode, you can choose the operation performed when the shutter-release button is pressed (☐ 45).

Option	Description
 Single frame	The camera takes one photograph each time the shutter-release button is pressed. Regardless of the option selected, a maximum of 50 photos can be taken with each movie.
 Continuous	The camera takes photographs for up to 3 (Z 7) or 2 (Z 6) seconds at a time while the shutter-release button is held down. The frame rate varies with the option selected for Frame size/frame rate in the movie shooting menu. Only one photograph can be taken at a time while movie recording is in progress.

The Self-Timer

In self-timer mode, pressing the shutter-release button starts a timer, and a photo is taken when the timer expires.

1 Select self-timer mode.

Keeping the  (☺) button pressed, rotate the main command dial to highlight ☺ (self-timer).



2 Choose the shutter-release delay.

Rotate the sub-command dial to select the shutter-release delay and press .



3 Frame the photograph and focus.

If **AF-S** is selected for focus mode, the timer will not start unless the camera is able to focus.



4 Start the timer.

Press the shutter-release button all the way down to start the timer. A  icon will appear in the display and the self-timer lamp will start to flash, stopping two seconds before the photograph is taken.



Taking Multiple Shots

Use Custom Setting c2 (**Self-timer**) to choose the number of shots taken, and the interval between the shots taken, when the self-timer finishes counting down.

The Sub-Selector

Use the sub-selector as a joystick to select the focus point, or press the center to lock focus and/or exposure.

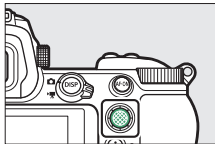

Focus-Point Selection

Use the sub-selector to select the focus point in the shooting display. Focus-point selection is not available when auto-area AF is selected for AF-area mode (☐ 54).

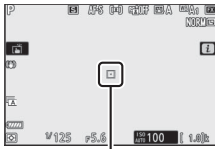

Focus point

Autoexposure (AE) Lock

Pressing the center of the sub-selector locks exposure at the current setting. AE lock can be used to recompose shots after metering a subject that will not be in the selected focus area in the final composition, and is particularly effective with spot or center-weighted metering.

Focus Lock

Press the center of the sub-selector to lock focus on the current subject when **AF-C** is selected for focus mode. When using focus lock, choose an AF-area mode other than auto-area AF.

■ Locking Focus and Exposure

Follow the steps below to use focus and exposure lock.

1 Set focus and exposure.

Position the subject in the selected focus point and press the shutter-release button halfway to set focus and exposure.

2 Lock focus and exposure.

With the shutter-release button pressed halfway, press the center of the sub-selector to lock both focus and exposure (an **AE-L** icon will be displayed).

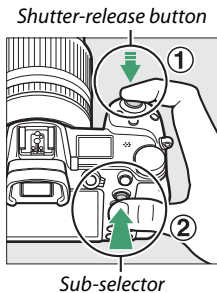

3 Recompose the photograph and shoot.

Focus will remain locked between shots if you keep the shutter-release button pressed halfway (**AF-S**) or keep the center of the sub-selector pressed, allowing several photographs in succession to be taken at the same focus setting.



Do not change the distance between the camera and the subject while focus lock is in effect. If the subject moves, focus again at the new distance.

✓ **AF-S**

When **AF-S** is selected for focus mode, focus will lock while the shutter-release button is pressed halfway (focus will also lock while the center of the sub-selector is pressed).

✓ **Using the Shutter-Release Button for Exposure Lock**

If **On (half press)** is selected for Custom Setting c1 (**Shutter-release button AE-L**), exposure will lock while the shutter-release button is pressed halfway.

The *i* Menu

Pressing the *i* button displays the *i* menu: a menu of frequently-used settings for the current mode.

Using the *i* Menu

Press the *i* button to display the *i* menu.

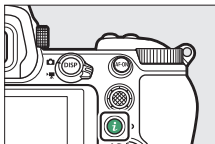

Highlight items using the multi selector and press **OK** to view options, then highlight an option and press **OK** to select it and return to the *i* menu (to exit to the previous display without changing settings, press the *i* button).



The Command Dials

You can also adjust settings for highlighted items by rotating the main command dial to choose an option and then pressing **OK** (sub-options, if available, can be selected by rotating the sub-command dial; in some cases, the same options can be selected using either dial). The current option will also be selected if you highlight another item with the multi selector or press the shutter-release button halfway.

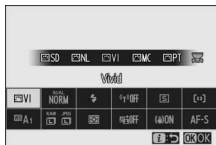

The Photo-Mode *i* Menu



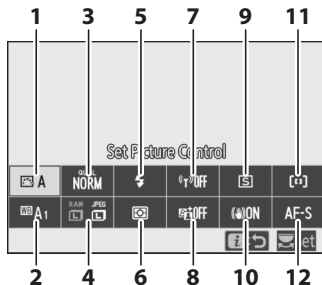







At default settings, the following items appear in the *i* menu for photo mode.





1 Set Picture Control	96	7 Wi-Fi connection	111
2 White balance	100	8 Active D-Lighting	112
3 Image quality	106	9 Release mode	113
4 Image size	108	10 Vibration reduction	114
5 Flash mode	109	11 AF-area mode	115
6 Metering	110	12 Focus mode	115

Set Picture Control

Choose a Picture Control according to the subject or type of scene.

Option	Description
 A Auto	The camera automatically adjusts hues and tones based on the Standard Picture Control. The complexions of portrait subjects will appear softer, and such elements as the foliage and sky in outdoor shots more vivid, than in pictures taken with the Standard Picture Control.
 SD Standard	Standard processing for balanced results. Recommended for most situations.
 NL Neutral	Minimal processing for natural results. Choose for photographs that will later be processed or retouched.
 VI Vivid	Pictures are enhanced for a vivid, photoprint effect. Choose for photographs that emphasize primary colors.
 MC Monochrome	Take monochrome photographs.
 PT Portrait	Process portraits for skin with natural texture and a rounded feel.
 LS Landscape	Produces vibrant landscapes and cityscapes.
 FL Flat	Details are preserved over a wide tone range, from highlights to shadows. Choose for photographs that will later be extensively processed or retouched.
 01– Creative Picture Control  20 Control	Choose from the following Picture Controls, each a unique combination of hue, tone, saturation, and other settings tuned for a particular effect: Dream, Morning, Pop, Sunday, Sombre, Dramatic, Silence, Bleached, Melancholic, Pure, Denim, Toy, Sepia, Blue, Red, Pink, Charcoal, Graphite, Binary, and Carbon.

To view Picture Control settings, highlight a Picture Control and press . Changes to settings can be previewed in the display ( 98).

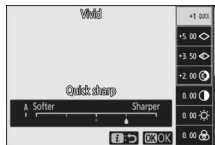

The current Picture Control is indicated by an icon in the display during shooting.



■ ■ Modifying Picture Controls

Picture Controls can be modified to suit the scene or the photographer's creative intent. Highlight **Set Picture Control** in the **i** menu and press **OK** to display the Picture Control list, then highlight a Picture Control and press **Down Arrow** to display Picture Control settings. Press **Up Arrow** or **Down Arrow** to highlight the desired setting and press **Left Arrow** or **Right Arrow** to choose a value in increments of 1, or rotate the sub-command dial to choose a value in increments of 0.25 (the options available vary with the Picture Control selected). Default settings can be restored by pressing the **Reset** button.

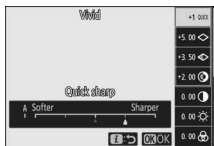

After adjusting settings to your satisfaction, press **OK** to put the changes into effect and return to the **i** menu. Picture Controls that have been modified from default settings are indicated by an asterisk ("*****").



✓ Previous Settings

The **Δ** indicator under the value display in the Picture Control setting menu indicates the previous value for the setting.



✓ "A" (Auto)

Selecting the **A** (auto) option available for some settings lets the camera adjust the setting automatically. Results vary with exposure and the position of the subject in the frame.

✓ The "A Auto" Picture Control

If **A Auto** is selected for Set Picture Control, settings can be adjusted in the range **A-2** to **A+2**.

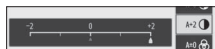

The following settings are available:

Option	Description
Effect level	Mute or heighten the effect of Creative Picture Control.
Quick sharp	Quickly adjust levels for balanced Sharpening , Mid-range sharpening , and Clarity . You can also make individual adjustments to the following parameters:
Sharpening	<ul style="list-style-type: none"> • Sharpening: Control the sharpness of details and outlines.
Mid-range sharpening	<ul style="list-style-type: none"> • Mid-range sharpening: Adjust sharpness according to the fineness of the patterns and lines in mid-tones affected by Sharpening and Clarity.
Clarity	<ul style="list-style-type: none"> • Clarity: Adjust overall sharpness and the sharpness of thicker outlines without affecting brightness or dynamic range.
Contrast	Adjust contrast.
Brightness	Raise or lower brightness without loss of detail in highlights or shadows.
Saturation	Control the vividness of colors.
Hue	Adjust hue.
Filter effects	Simulate the effect of color filters on monochrome pictures.
Toning	Choose the tint used in monochrome pictures. Pressing  when an option other than B&W (black-and-white) is selected displays saturation options.
Toning (Creative Picture Control)	Adjust the shade of color used for Creative Picture Controls.

Filter Effects

Choose from the following:

Mode	Setting
Y (yellow)	These options enhance contrast and can be used to tone down the brightness of the sky in landscape photographs. Orange produces more contrast than yellow, red more contrast than orange.
O (orange)	
R (red)	
G (green)	Green softens skin tones and can be used for portraits.

White Balance

Adjust white balance (for more information, see “White Balance,” p. 64).

Option	Option
WB A Auto	Fluorescent
Keep white (reduce warm colors)	Sodium-vapor lamps
Keep overall atmosphere	Warm-white fluorescent
Keep warm lighting colors	White fluorescent
WB A Natural light auto	Cool-white fluorescent
Direct sunlight	Day white fluorescent
Cloudy	Daylight fluorescent
Shade	High temp. mercury-vapor
Incandescent	WB Flash
	Choose color temperature
	PRE Preset manual

Pressing **WB** when **Auto** or **Fluorescent** is highlighted displays sub-options for the highlighted item.





The current white balance option is indicated by an icon in the display during shooting.

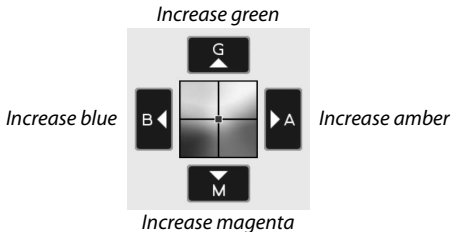
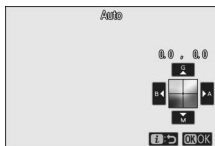

■ Fine-Tuning White Balance

Selecting **White balance** in the **i** menu displays a list of white balance options. If an option other than **Choose color temperature** is highlighted, fine-tuning options can be displayed by pressing . Any changes to fine-tuning options can be previewed in the display.



Tap the arrows in the display or use the multi selector to fine-tune white balance. Press  to save settings and return to the **i** menu.

An asterisk ("*****") next to the white balance icon in the shooting display indicates that fine-tuning is in effect.



■ Choosing a Color Temperature



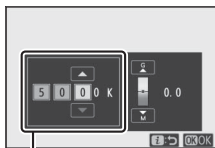

Selecting **White balance** in the **i** menu displays a list of white balance options. When **Choose color temperature** is highlighted, color temperature options can be viewed by pressing .



Value for
Amber-Blue axis



Value for
Green-Magenta axis

Press  or  to highlight digits on the **Amber-Blue** or **Green-Magenta** axis and press  or  to change. Press  to save settings and return to the **i** menu. If a value other than zero is selected for the **Green-Magenta** axis, an asterisk ("*") will be displayed next to the white balance icon.

Choose Color Temperature

Note that the desired results will not be obtained with fluorescent lighting. Choose  (**Fluorescent**) for fluorescent light sources. With other light sources, take a test shot to determine if the selected value is appropriate.

■ Preset Manual

Preset manual is used to record and recall up to six custom white balance settings for shooting under mixed lighting or to compensate for light sources with a strong color cast. Follow the steps below to measure a value for preset manual white balance.

1 Display white balance presets.

Highlight **Preset manual** in the **i** menu white balance display and press \odot to display a list of white balance presets.



2 Select a preset.

Highlight the desired white balance preset (d-1 to d-6) and press \odot to select the highlighted preset and return to the **i** menu.



✔ Protected Presets



Presets indicated by a **⊞** icon are protected and cannot be changed.

3 Select direct measurement mode.

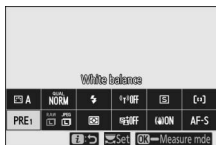
Highlight **White balance** in the **i** menu and press and hold \odot until the **PRE** icons in the shooting display and control panel start to flash and white balance target (\square) is displayed at the selected focus point.



4 Measure white balance.

To measure white balance, tap a white or gray object, or use the multi selector to position the  over a white or gray area of the display and either press  or press the shutter-release button all the way down (note that the  cannot be repositioned when an optional flash unit is attached, in which case you will need to measure white balance with a white or gray object positioned in the center of the frame).



If the camera is unable to measure white balance, a message will be displayed. Try measuring white balance again with a different target.



5 Exit direct measurement mode.

Press the  button to exit direct measurement mode.

✔ Measuring Preset Manual White Balance

Preset manual white balance cannot be measured while HDR or multiple exposure shooting is in progress.

✔ Direct Measurement Mode

Direct measurement mode will end if no operations are performed in the time selected for Custom Setting c3 (**Power off delay**) > **Standby timer**.

✔ Managing Presets

The **White balance** > **Preset manual** option in the photo shooting menu can be used to copy white balance from an existing photograph to a selected preset, add comments, or to protect presets.

✔ Preset Manual: Selecting a Preset

To choose a preset, select **White balance** > **Preset manual** in the photo shooting menu, then highlight a preset and press **OK**. If no value currently exists for the selected preset, white balance will be set to 5200 K, the same as **Direct sunlight**.



Image Quality

Choose a file format for photographs.

Option	Description
NEF (RAW) + JPEG fine★	Record two copies of each photo: an NEF (RAW) image and a JPEG copy. Only the JPEG copy is displayed during playback, but deleting the JPEG copy also deletes the NEF (RAW) image. The NEF (RAW) image can only be viewed using a computer.
NEF (RAW) + JPEG fine	
NEF (RAW) + JPEG normal★	
NEF (RAW) + JPEG normal	
NEF (RAW) + JPEG basic★	
NEF (RAW) + JPEG basic	
NEF (RAW)	Record photos in NEF (RAW) format.
JPEG fine★	Record photos in JPEG format. Compression increases and file size decreases as quality progresses from “fine” through “normal” to “basic”. Choose options with ★ to maximize quality, options without ★ to ensure that all images have more or less the same file size.
JPEG fine	
JPEG normal★	
JPEG normal	
JPEG basic★	
JPEG basic	
TIFF (RGB)	Record photos in uncompressed TIFF-RGB format at a bit depth of 8 bits per channel (24-bit color).

The option currently selected is shown in the display during shooting.



NEF (RAW)

NEF (RAW) image files (extension “*.nef”) contain the raw data output from the image sensor. Using Nikon’s ViewNX-i or Capture NX-D software, you can adjust and re-adjust settings such as exposure compensation and white balance as often as you please without degrading image quality, making this format ideal for photos that will be processed in multiple different ways. ViewNX-i and Capture NX-D are available free-of-charge from the Nikon Download Center.

The process of converting NEF (RAW) images to other formats such as JPEG is referred to as “NEF (RAW) processing”. You can save NEF (RAW) images in other formats using the ViewNX-i and Capture NX-D computer applications or the **NEF (RAW) processing** option in the camera retouch menu.

Image Size

Choose the size at which photographs are recorded.

Option		Description
NEF (RAW)	Large	Choose the size for photos recorded in NEF (RAW) format. NEF (RAW) is available only when an NEF (RAW) option is selected for image quality.
	Medium	
	Small	
JPEG/TIFF	Large	Choose the size for photos recorded in JPEG or TIFF format.
	Medium	
	Small	

The option currently selected is shown in the display during shooting.



The physical dimensions of the photos in pixels varies with the option selected for **Choose image area**.

		Image size		
		Large	Medium	Small
Image area	FX (36 × 24)	8256 × 5504	6192 × 4128	4128 × 2752
	DX (24 × 16)	5408 × 3600	4048 × 2696	2704 × 1800
	5 : 4 (30 × 24)	6880 × 5504	5152 × 4120	3440 × 2752
	1 : 1 (24 × 24)	5504 × 5504	4128 × 4128	2752 × 2752
	16 : 9 (36 × 20)	8256 × 4640	6192 × 3480	4128 × 2320

		Image size		
		Large	Medium	Small
Image area	FX (36 × 24)	6048 × 4024	4528 × 3016	3024 × 2016
	DX (24 × 16)	3936 × 2624	2944 × 1968	1968 × 1312
	1 : 1 (24 × 24)	4016 × 4016	3008 × 3008	2000 × 2000
	16 : 9 (36 × 20)	6048 × 3400	4528 × 2544	3024 × 1696

Flash Mode

Choose a flash mode for optional flash units (📖 356). The options available depend on the mode selected with the mode dial.





Option	Available in	Option	Available in
⚡ Fill flash	AUTO 📷, P, S, A, M	⚡ REAR Rear-curtain sync	P, S, A, M
⚡👁 Red-eye reduction		📷 Flash off	AUTO 📷, P, S, A, M
⚡👁 SLOW Slow sync + red-eye	P, A		
⚡ SLOW Slow sync			

The option currently selected is indicated by an icon in the display during shooting.



Metering

Metering determines how the camera sets exposure. The following options are available:

Option	Description
 Matrix metering	The camera meters a wide area of the frame and sets exposure according to tone distribution, color, composition, and distance for results close to those seen by the naked eye.
 Center-weighted metering	The camera meters the entire frame but assigns the greatest weight to an area in the center of the frame, the size of which can be chosen using Custom Setting b3 (Center-weighted area). This is the classic meter for portraits and is also recommended when using filters with an exposure factor (filter factor) over 1 \times .
 Spot metering	The camera meters a ϕ 4 mm circle (equivalent to approximately 1.5% of the frame) centered on the current focus point, making it possible to meter off-center subjects (if auto-area AF is in effect, the camera will instead meter the center focus point). Spot metering ensures that the subject will be correctly exposed, even when the background is much brighter or darker.
 * Highlight-weighted metering	The camera assigns the greatest weight to highlights. Use this option to reduce loss of detail in highlights, for example when photographing spotlight performers on-stage.

The option currently selected is indicated by an icon in the display during shooting.



Wi-Fi Connection

Enable or disable Wi-Fi. Enable Wi-Fi to establish wireless connections to computers or between the camera and smartphones or tablets (smart devices) running the SnapBridge app.

The camera displays a Wi-Fi icon when Wi-Fi is enabled.



To turn Wi-Fi off, highlight **Wi-Fi connection** in the **i** menu and press **OK**. If Wi-Fi is currently enabled, a **Close Wi-Fi connection** prompt will be displayed; press **OK** to end the connection.

Wireless Connections

For information on establishing wireless connections to computers or smart devices, see the *Network Guide*, available from the Nikon Download Center:

Z7: https://downloadcenter.nikonimglib.com/en/products/492/Z_7.html

Z6: https://downloadcenter.nikonimglib.com/en/products/493/Z_6.html

More information on using SnapBridge is available via the app's online help.

Active D-Lighting

Active D-Lighting preserves details in highlights and shadows, creating photographs with natural contrast. Use for high-contrast scenes, for example when photographing brightly lit outdoor scenery through a door or window or taking pictures of shaded subjects on a sunny day. It is most effective when used with matrix metering.



Off



暗A Auto

Option	Description
暗A Auto	The camera automatically adjusts Active D-Lighting in response to shooting conditions (in mode M , however, 暗A Auto is equivalent to 暗N Normal).
暗H⁺ Extra high	Choose the amount of Active D-Lighting performed from 暗H⁺ Extra high , 暗H High , 暗N Normal , and 暗L Low .
暗H High	
暗N Normal	
暗L Low	
暗OFF Off	Active D-Lighting off.

The option currently selected is indicated by an icon in the display during shooting.



✓ Active D-Lighting

Noise (randomly-spaced bright pixels, fog, or lines) may appear in photos taken with Active D-Lighting. Uneven shading may be visible with some subjects. Active D-Lighting does not apply at high ISO sensitivities (Hi 0.3–Hi 2), including high sensitivities selected via auto ISO sensitivity control.

Release Mode

Choose the operation performed when the shutter-release button is pressed all the way down. For more information, see “The (Release Mode/Self-Timer) Button” (86).

Option	Option
Single frame	Continuous H (extended)
Continuous L	Self-timer
Continuous H	

When **Continuous L** or **Self-timer** is highlighted, additional options can be displayed by pressing .

Pressing when **Continuous L** is highlighted displays frame advance rate options.



Pressing when **Self-timer** is highlighted displays options for the shutter-release delay and the number of shots taken when the timer expires.

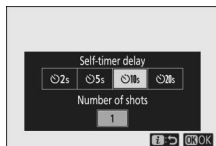



The current release mode is shown by icons in the shooting display and control panel.



Vibration Reduction

Choose whether to enable vibration reduction. The options available vary with the lens.

Option	Description
 On Normal	Choose for enhanced vibration reduction when photographing static subjects.
 Sport	Choose when photographing athletes and other subjects that are moving rapidly and unpredictably.
 Off	Vibration reduction off.

Options other than **Off** are shown by an icon in the display during shooting.



Vibration Reduction







Vibration reduction may be unavailable with some lenses. When using vibration reduction, wait for the image in the display to stabilize before shooting. With some lenses, the image in the display may also jiggle after the shutter is released; this is normal and does not indicate a malfunction.

Sport or **On** is recommended for panning shots. In **Sport**, **Normal**, and **On** modes, vibration reduction applies only to motion that is not part of the pan (if the camera is panned horizontally, for example, vibration reduction will be applied only to vertical shake).

To prevent unintended results, select **Off** when the camera is mounted on a tripod. Note that settings for VR lenses may differ; consult the lens manual for more information. **Normal**, **Sport**, or **On** is recommended if the tripod head is unsecured or the camera is mounted on a monopod.

AF-Area Mode

AF-area mode controls how the camera selects the focus-point for autofocus. For more information, see “AF-Area Mode” (□ 54).

Option	Option
 Pinpoint AF	 Wide-area AF (S)
 Single-point AF	 Wide-area AF (L)
 Dynamic-area AF	 Auto-area AF

The option currently selected is shown by an icon in the display during shooting.



Focus Mode

The focus mode controls how the camera focuses. For more information, see “Choosing a Focus Mode” (□ 52).

Option	Option
AF-S Single AF	MF Manual focus
AF-C Continuous AF	

The option currently selected is shown by an icon in the display during shooting.



The Movie-Mode *i* Menu

At default settings, the following items appear in the *i* menu for movie mode.

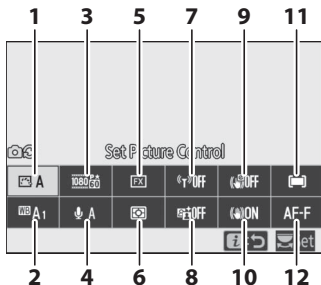

1	Set Picture Control.....	117	7	Wi-Fi connection.....	122
2	White balance.....	117	8	Active D-Lighting	122
3	Frame size and rate/ image quality	118	9	Electronic VR.....	122
4	Microphone sensitivity.....	120	10	Vibration reduction	123
5	Choose image area.....	121	11	AF-area mode	123
6	Metering	122	12	Focus mode.....	123

"Same as Photo Settings"

If **Same as photo settings** is selected for **Set Picture Control, White balance, Active D-Lighting, or Vibration reduction** in the movie shooting menu, a  icon will appear at the top left corner of the *i* menu, indicating that the options selected for these settings in photo mode also apply in movie mode and vice versa.

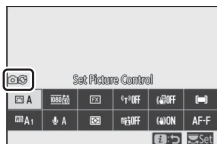

Set Picture Control

Choose a Picture Control for movie recording. For more information, see “Set Picture Control” (📖 96).

White Balance

Adjust white balance for movie recording. For more information, see “White Balance” (📖 64, 100).

Frame Size, Frame Rate, and Movie Quality

Select the movie frame size (in pixels) and frame rate. You can also choose from two **Movie quality** options: **High quality** (indicated by frame size/rate icons with “★”) and **Normal**. Together, these options determine the maximum bit rate, as shown in the following table.

Frame size/frame rate ¹	Max. bit rate (Mbps)		Max. recording time
	High quality	Normal	
3840 × 2160 (4K UHD); 30p	144	— ²	29 min. 59 s ⁴
3840 × 2160 (4K UHD); 25p			
3840 × 2160 (4K UHD); 24p			
1920 × 1080; 120p ³			
1920 × 1080; 100p ³			
/ 1920 × 1080; 60p	56	28	
/ 1920 × 1080; 50p			
/ 1920 × 1080; 30p			
/ 1920 × 1080; 25p	28	14	
/ 1920 × 1080; 24p			
1920 × 1080; 30p × 4 (slow-motion) ³	36	— ²	3 min.
1920 × 1080; 25p × 4 (slow-motion) ³			
1920 × 1080; 24p × 5 (slow-motion) ³			

1 Actual frame rates for values listed as 120p, 60p, 30p, and 24p are respectively 119.88 fps, 59.94 fps, 29.97 fps, and 23.976 fps.

2 **Movie quality** fixed at **High quality**.

3 Image area fixed at **DX** (Z 7) or **FX** (Z 6); face detection not enabled in auto-area AF AF-area mode.

4 Each movie may be recorded across up to 8 files of up to 4 GB each. The number of files and the length of each file vary with the options selected for **Frame size/frame rate** and **Movie quality**. Movies recorded to memory cards formatted in the camera will however be recorded as a single file regardless of size if the card has a capacity over 32 GB.

The option currently selected is shown by an icon in the display.

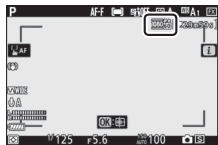

■ Slow-Motion Movies

To record silent slow-motion movies, select a “slow-motion” option for **Frame size/frame rate**. Slow-motion movies are recorded at 4 or 5 times the rated speed and play back at the rated speed. Movies shot at **1920 × 1080; 30p ×4 (slow-motion)**, for example, are recorded at a frame rate of roughly 120 fps and play back at around 30 fps, meaning that 10 seconds recording produces about 40 seconds of footage.

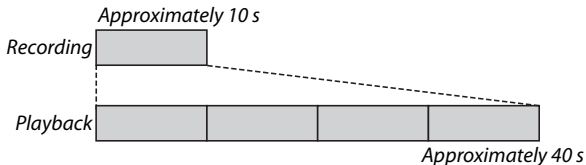

Recording and playback speeds are shown below.

	Frame size/frame rate	Recording speed	Normal
	1920 × 1080; 30p ×4 (slow-motion)	120p (119.88 fps)	30p (29.97 fps)
	1920 × 1080; 25p ×4 (slow-motion)	100p (100 fps)	25p (25 fps)
	1920 × 1080; 24p ×5 (slow-motion)	120p (119.88 fps)	24p (23.976 fps)

✔ Slow-Motion Movies

Features such as flicker reduction, electronic vibration reduction, and time code output cannot be used when a “slow-motion” option is selected.

Microphone Sensitivity

Turn the built-in or external microphones on or off or adjust microphone sensitivity. Choose **Auto** to adjust sensitivity automatically or **Microphone off** to turn sound recording off or adjust microphone sensitivity manually by choosing a value between **1** and **20** (the higher the value, the higher the sensitivity).

At settings other than **Auto**, the option currently selected is shown by an icon in the display.

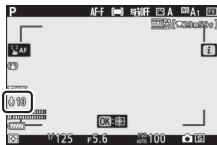

If the sound level is displayed in red, the volume is too high. Reduce microphone sensitivity.



The Icon

Movies recorded with the microphone off are indicated by a  icon in full-frame and movie playback.



Choose Image Area

Choose the size of the area on the image sensor used to record movies. Select **FX** to shoot movies in what is referred to as “FX-based movie format”, **DX** to shoot in “DX-based movie format”. The differences between the two formats are shown in the illustration.

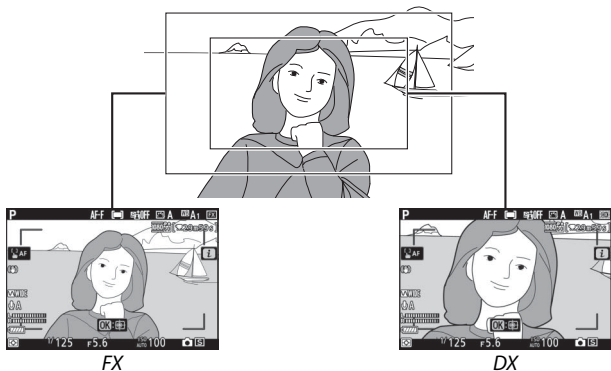

The dimensions of the area recorded vary with the frame size:

Format	Frame size	Area recorded (approximate)	
		Z7	Z6
FX-based movie format	3840 × 2160	35.9 × 20.2 mm	
	1920 × 1080	35.8 × 20.1 mm	35.9 × 20.1 mm
DX-based movie format	3840 × 2160	23.4 × 13.2 mm	
	1920 × 1080	23.5 × 13.2 mm	23.4 × 13.1 mm

The option currently selected is shown by an icon in the display.

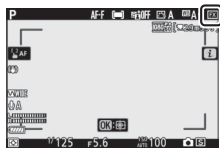

Metering

Choose how the camera sets exposure in movie mode. For more information, see “Metering” (☞ 110), but note that spot metering is not available.

Wi-Fi Connection

Enable or disable Wi-Fi. For more information, see “Wi-Fi Connection” (☞ 111).

Active D-Lighting

Choose an Active D-Lighting option for movie mode. For more information, see “Active D-Lighting” (☞ 112). Note that if **Same as photo settings** is selected for **Active D-Lighting** in the movie shooting menu and **Auto** is selected in the photo shooting menu, movies will be shot at a setting equivalent to **Normal**.

Electronic VR

Select **On** to enable electronic vibration reduction in movie mode. Electronic vibration reduction is not available at frame sizes of **1920 × 1080; 120p**, **1920 × 1080; 100p**, or 1920 × 1080 (slow-motion). Note that when electronic vibration reduction is on, the angle of view will be reduced, slightly increasing the apparent focal length, and the maximum sensitivity for movie recording is fixed at ISO 25600 (Z 7) or 51200 (Z 6).

An icon appears in the display while **On** is selected.

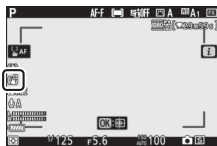





Vibration Reduction

Choose vibration reduction option for movie mode. For more information, see “Vibration Reduction” (📖 114).

AF-Area Mode

Choose how the camera selects the focus point when autofocus is enabled in movie mode. For more information, see “AF-Area Mode” (📖 54).

Option	Option
 Single-point AF	 Wide-area AF (L)
 Wide-area AF (S)	 Auto-area AF

Focus Mode



Choose how the camera focuses in movie mode. For more information, see “Choosing a Focus Mode” (📖 52).

Option	Option
AF-S Single AF	AF-F Full-time AF
AF-C Continuous AF	MF Manual focus

More About Playback





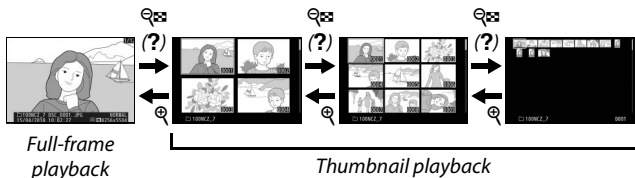

Learn more about viewing pictures and image information, the playback **i** menu, playback zoom, and deleting pictures.

Viewing Pictures

Use the  and  (?) buttons to cycle between full-frame and thumbnail playback.



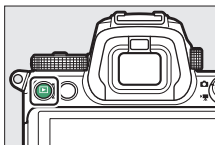

Full-Frame Playback

Press the  button to view the most recent picture full frame in the display. Additional pictures can be displayed by pressing  or ; to view additional information on the current photograph, press  or  or press the **DISP** button ( 126).



Thumbnail Playback

To view multiple images, press the  (?) button when a picture is displayed full frame. The number of images displayed increases from 4 to 9 to 72 each time the  (?) button is pressed, and decreases with each press of the  button. Use the multi selector to highlight images.

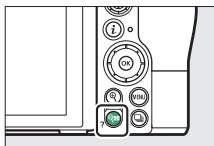

✔ Touch Controls

Touch controls can be used when pictures are displayed in the monitor (📖 11).

✔ Rotate Tall



To display “tall” (portrait-orientation) photographs in tall orientation, select **On** for **Rotate tall** in the playback menu.





✔ Image Review

When **On** is selected for **Image review** in the playback menu, photographs are automatically displayed after shooting (because the camera is already in the correct orientation, images are not rotated automatically during image review). If **On (monitor only)** is selected, photos will not be displayed in the viewfinder. In continuous release modes, display begins when shooting ends, with the first photograph in the current series displayed.

Photo Information

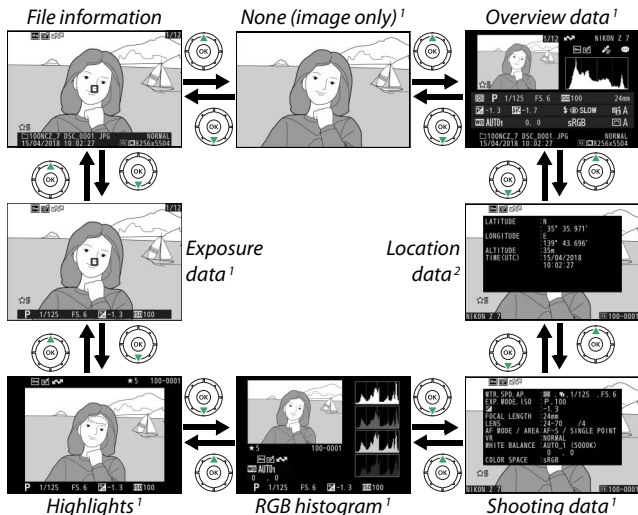
Photo information is superimposed on images displayed in full-frame playback. Press  or  or press the **DISP** button to cycle through photo information as shown below.



- 1 Displayed only if the corresponding option is selected for **Playback display options** in the playback menu.
- 2 Displayed only if embedded in the picture ( 308).

File Information

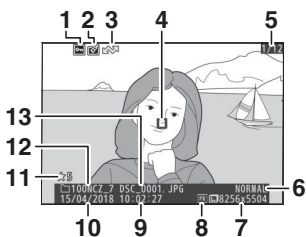

1	Protect status.....	71
2	Retouch indicator	316
3	Upload marking	136
4	Focus point*	54
5	Frame number/ total number of frames	
6	Image quality	106
7	Image size.....	108
8	Image area	121, 167
9	Time of recording	38, 297
10	Date of recording.....	38, 297
11	Rating	70
12	Folder name.....	157
13	File name	167, 241

* Displayed only if **Focus point** is selected for **Playback display options**.

Exposure Data

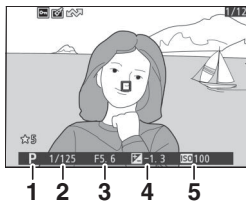

1	Shooting mode	72
2	Shutter speed	73, 75
3	Aperture.....	74
4	Exposure compensation	84
5	ISO sensitivity*	82

* Displayed in red if photo was taken in mode **P**, **S**, **A**, or **M** with auto ISO sensitivity control on.

Highlights

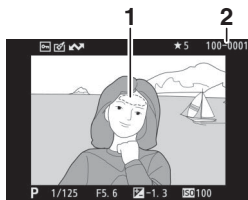

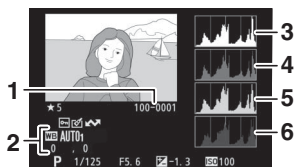

- 1 Highlights (areas that may be overexposed)
- 2 Folder number-frame number 163

RGB Histogram



- 1 Folder number-frame number 163
- 2 White balance64, 100
 - Color temperature 102
 - White balance fine-tuning 101
 - Preset manual 103
- 3 Histogram (RGB channel) 129
- 4 Histogram (red channel)..... 129
- 5 Histogram (green channel)..... 129
- 6 Histogram (blue channel) 129

✔ Playback Zoom

To zoom in on the photograph when the histogram is displayed, press . Use the  and  (?) buttons to zoom in and out and scroll the image with the multi selector. The histogram will be updated to show only the data for the portion of the image visible in the display.



✔ Histograms

Histograms show tone distribution, with pixel brightness (tone) plotted on the horizontal axis and the number of pixels on the vertical axis. Camera histograms are intended as a guide only and may differ from those displayed in imaging applications. Some sample histograms are shown below:

If the image contains objects with a wide range of brightnesses, the distribution of tones will be relatively even.



If the image is dark, tone distribution will be shifted to the left.



If the image is bright, tone distribution will be shifted to the right.



Increasing exposure compensation shifts the distribution of tones to the right, while decreasing exposure compensation shifts the distribution to the left. Histograms can provide a rough idea of overall exposure when bright ambient lighting makes it difficult to see pictures in the display.

Shooting Data

Depending on settings at the time the picture was taken, there may be up to five pages of shooting data: general, flash info, Picture Control, advanced, and copyright information.

■ Shooting Data, Page 1 (General)

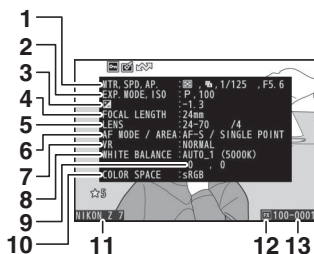

1	Metering	110
	Shutter type	264
	Shutter speed	73, 75
	Aperture	74
2	Shooting mode	72
	ISO sensitivity ¹	82
3	Exposure compensation	84
	Optimal exposure tuning ²	261
4	Focal length	
5	Lens data	
6	Focus mode	52
7	Vibration reduction	114
8	White balance ³	64, 100
9	White balance fine-tuning	101
10	Color space	184
11	Camera name	
12	Image area	121, 167
13	Folder number-frame number	163

■ Shooting Data, Page 2 (Flash Info)⁴

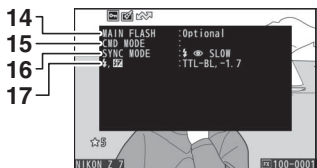

14	Flash type
15	Remote flash control 364
16	Flash mode..... 109, 356
17	Flash control mode 188
	Flash compensation..... 191

■ Shooting Data, Page 3 (Picture Control)

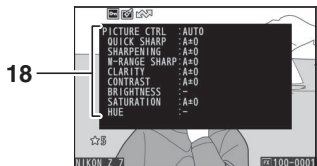

18	Picture Control ⁵ 96, 179
----	--

■ Shooting Data, Page 4 (Advanced)

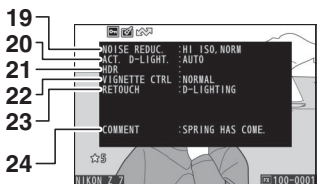

19	High ISO noise reduction..... 185
	Long exposure noise reduction 185
20	Active D-Lighting 112
21	HDR exposure differential 209
	HDR smoothing..... 209
22	Vignette control 186
23	Retouch history 316
24	Image comment 305

■ Shooting Data, Page 5 (Copyright Information)⁶

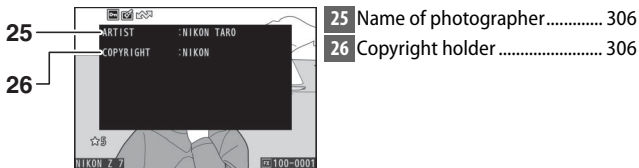

- 1 Displayed in red if photo was taken in mode **P**, **S**, **A**, or **M** with auto ISO sensitivity control on.
- 2 Displayed if Custom Setting b4 (**Fine-tune optimal exposure**) has been set to a value other than zero for any metering method.
- 3 Also includes color temperature of photos taken using auto white balance.
- 4 Displayed only if photo was taken with optional flash unit (📖 410).
- 5 The items displayed vary with the Picture Control selected when the picture was taken.
- 6 Copyright information is only displayed if recorded with the photograph using the **Copyright information** option in the setup menu.

Location Data

The latitude, longitude, and other location data are supplied by and vary with the GPS or smart device (📖 308). In the case of movies, the data give the location at the start of recording.

Overview Data

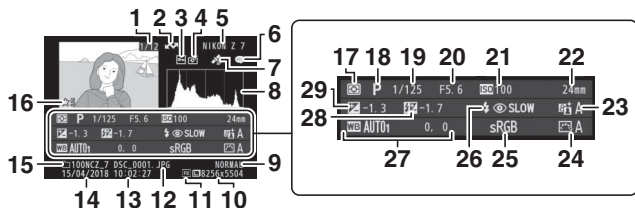

1 Frame number/ total number of frames	17 Metering 110
2 Upload marking 136	18 Shooting mode 72
3 Protect status 71	19 Shutter speed 73, 75
4 Retouch indicator 316	20 Aperture 74
5 Camera name	21 ISO sensitivity ¹ 82
6 Image comment indicator 305	22 Focal length
7 Location data indicator 308	23 Active D-Lighting 112
8 Histogram 129	24 Picture Control 96, 179
9 Image quality 106	25 Color space 184
10 Image size 108	26 Flash mode ² 109, 356
11 Image area 121, 167	27 White balance 64, 100
12 File name 167, 241	Color temperature 102
13 Time of recording 38, 297	White balance fine-tuning 101
14 Date of recording 38, 297	Preset manual 103
15 Folder name 157	28 Flash compensation ² 191
16 Rating 70	Commander mode ²
	29 Exposure compensation 84

1 Displayed in red if photo was taken in mode **P**, **S**, **A**, or **M** with auto ISO sensitivity control on.

2 Displayed only if photo was taken with optional flash unit (□ 410).

The *i* Button: Playback

Pressing the *i* button during playback zoom or full-frame or thumbnail playback displays the *i* menu for playback mode. Select options using the multi selector and \odot button and press the *i* button to exit the menu and return to playback.

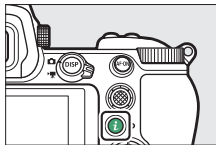

The options available in the playback *i* menu vary with the type of picture.

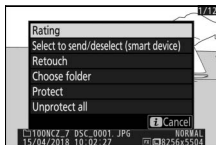

Photos: Pressing the *i* button when a photo is selected displays the options listed below.

- **Quick crop** (displayed only during playback zoom): Save a copy of the current image cropped to the area visible in the display. This option is not available when histograms are displayed.
- **Rating:** Rate the current picture (📖 70).
- **Select to send/deselect (smart device/PC/WT):** Select the current picture for upload. The option displayed varies with the type of device connected (📖 136).
- **Retouch:** Use the options in the retouch menu (📖 316) to create a retouched copy of the current photograph.
- **Choose folder:** Choose a folder for playback. Highlight a folder and press \odot to view the pictures in the highlighted folder.
- **Protect:** Add protection to or remove protection from the current picture (📖 71).
- **Unprotect all** (not available during playback zoom): Remove protection from all pictures in the folder currently selected for **Playback folder** in the playback menu.

Movies: The options below are available when a movie is selected.

- **Rating:** Rate the current picture (📖 70).
- **Select to send/deselect (PC/WT):** Select the current picture for upload. The option displayed varies with the type of device connected (📖 136).
- **Volume control:** Adjust playback volume.
- **Trim movie:** Trim footage from the current movie and save the edited copy in a new file (📖 137).
- **Choose folder:** Choose a folder for playback. Highlight a folder and press ⓧ to view the pictures in the highlighted folder.
- **Protect:** Add protection to or remove protection from the current picture (📖 71).
- **Unprotect all:** Remove protection from all pictures in the folder currently selected for **Playback folder** in the playback menu.

Movies (playback paused): The options below are available when movie playback is paused.

- **Choose start/end point:** Trim footage from the current movie and save the edited copy in a new file (📖 137).
- **Save current frame:** Save a selected frame as a JPEG still (📖 140).

Select to Send/Deselect

Follow the steps below to select the current picture for upload to a smart device, computer, or ftp server. The **i** menu options used to select pictures for upload vary with the type of device connected:

- **Select to send/deselect (smart device):** Displayed when the camera is connected to a smart device via built-in Bluetooth using the **Connect to smart device** item in the setup menu (📖 310).
- **Select to send/deselect (PC):** Displayed when the camera is connected to a computer via built-in Wi-Fi using the **Connect to PC** item in the setup menu (📖 311).
- **Select to send/deselect (WT):** Displayed when the camera is connected to a computer or ftp server via an WT-7 wireless transmitter (available separately) using the **Wireless transmitter (WT-7)** item in the setup menu (📖 311).

1 Select a picture.

Display a picture in full-frame playback or playback zoom or select it in the thumbnail list.

2 Choose Select to send/deselect.

Press the **i** button to display the **i** menu, then highlight **Select to send/deselect** and press **OK**. Pictures selected for upload are indicated by a **📶** icon; to deselect, repeat Steps 1 and 2.

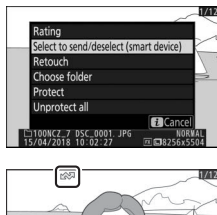

✓ Movies

Movies cannot be uploaded via Bluetooth. The maximum file size for movies uploaded by other means is 4 GB.

Choose Start/End Point

Follow the steps below to create trimmed copies of movies.



1 Display a movie full frame.

2 Pause the movie on the new opening frame.

Play the movie back as described in “Viewing Movies” (□ 49), pressing **OK** to start and resume playback and **⏸** to pause, and pressing **⏪** or **⏩** or rotating the main command dial to locate the desired frame. Your approximate position in the movie can be ascertained from the movie progress bar. Pause playback when you reach the new opening frame.



Movie progress bar

3 Select **Choose start/end point**.

Press the **i** button to display the **i** menu, then highlight **Choose start/end point** and press **OK**.



4 Select Start point.

To create a copy that begins from the current frame, highlight **Start point** and press **OK**. The frames before the current frame will be removed when you save the copy in Step 9.

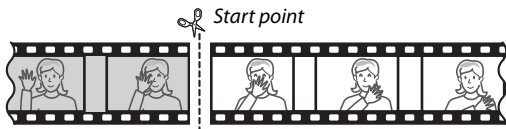
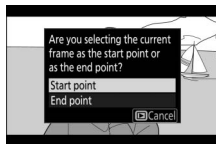

5 Confirm the new start point.

If the desired frame is not currently displayed, press **⏪** or **⏩** to advance or rewind (to skip to 10 s ahead or back, rotate the main command dial; to skip to the first or last frame, rotate the sub-command dial).



6 Choose the end point.

Press the center of the sub-selector to switch from the start point (**▾**) to the end point (**▸**) selection tool and then select the closing frame as described in Step 5. The frames after the selected frame will be removed when you save the copy in Step 9.

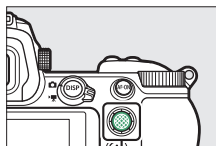

Sub-selector

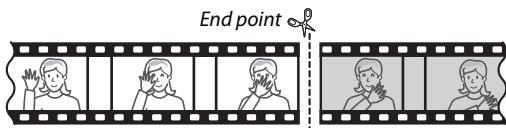

7 Create the copy.

Once the desired frame is displayed, press .

8 Preview the movie.

To preview the copy, highlight

Preview and press  (to interrupt the

preview and return to the save

options menu, press ). To abandon

the current copy and select a new

start point or end point as described above, highlight **Cancel**

and press ; to save the copy, proceed to Step 9.



9 Save the copy.

Highlight **Save as new file** and press

 to save the copy to a new file. To

replace the original movie file with

the edited copy, highlight **Overwrite**

existing file and press .



Trimming Movies

Movies must be at least two seconds long. The copy will not be saved if there is insufficient space available on the memory card.

Copies have the same time and date of creation as the original.

Removing Opening or Closing Footage

To remove only the opening footage from the movie, proceed to Step 7 without pressing the center of the sub-selector in Step 6. To

remove only the closing footage, select **End point** in Step 4, select the closing frame, and proceed to Step 7 without pressing the center of the sub-selector in Step 6.

“Trim Movie”

Movies can also be edited using the **Trim movie** option in the retouch menu.

Save Current Frame

To save a copy of a selected frame as a JPEG still:

1 Pause the movie on the desired frame.

Play the movie back as described in “Viewing Movies” (📖 49), pressing ⏹ to start and resume playback and ⏸ to pause. Pause the movie at the frame you intend to copy.



2 Choose Save current frame.



Press the **i** button to display the **i** menu, then highlight **Save current frame** and press ⏹ to create a JPEG copy of the current frame. The image will be recorded at the dimensions selected for **Frame size/frame rate** in the movie shooting menu.



✔ Save Current Frame



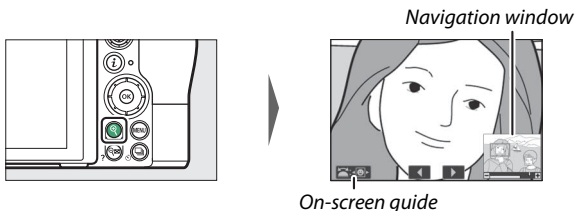

JPEG movie stills created with the **Save current frame** option cannot be retouched. JPEG movie stills lack some categories of photo information.

Taking a Closer Look: Playback Zoom

To zoom in during full-frame playback, press  or .



While zoom is in effect, you can:

- **Zoom in or out/view other areas of the image:** Press  or use stretch gestures to zoom in to a maximum of approximately 32 \times , 24 \times , or 16 \times for large, medium, or small images respectively (Z 7, or in the case of the Z 6, to a maximum of approximately 24 \times , 18 \times , or 12 \times ; all figures are for FX format). Press  or use pinch gestures to zoom out. While the photo is zoomed in, use the multi selector or slide a finger over the screen to view areas not currently visible in the display. Keep the multi selector pressed to scroll rapidly to other areas of the frame. A navigation window is displayed for a few seconds after the zoom ratio is altered; the area currently visible in the display is indicated by an amber border. The bar under the navigation window shows the zoom ratio, turning green at 1 : 1.
- **Select faces:** Faces detected during zoom are indicated by white borders in the navigation window. Rotate the sub-command dial or tap the on-screen guide to view other faces.
- **View other images:** Rotate the main command dial or tap the  or  icons at the bottom of the display to view the same location in other photos at the current zoom ratio. Playback zoom is cancelled when a movie is displayed.
- **Return to shooting mode:** Press the shutter-release button halfway or press the  button to exit to shooting mode.
- **Display the menus:** Press MENU to view the menus.

Deleting Pictures



Press the  button to delete the current picture or use the **Delete** option in the playback menu to delete multiple selected pictures, all pictures taken on a selected date, or all pictures in the current playback folder (protected pictures cannot be deleted). Exercise caution when deleting pictures, as pictures cannot be recovered once deleted.

During Playback

Press the  button to delete the current photograph.

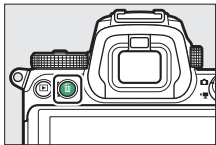



- 1 Press the  button.**
A confirmation dialog will be displayed.



- 2 Press the  button again.**
To delete the picture, press the  button again. To exit without deleting the picture, press .

The Playback Menu



The **Delete** item in the playback menu contains the following options. Note that depending on the number of images, some time may be required for deletion.

Option	Description
 Selected	Delete selected pictures.
 Select date	Delete all pictures taken on selected dates ( 144).
ALL All	Delete all pictures in the folder currently selected for playback ( 157).

■ ■ Selected: Deleting Selected Pictures



To delete multiple selected pictures, choose **Selected** and follow the steps below.

1 Select pictures.

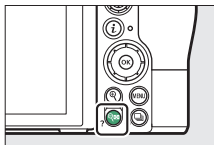
Use the multi selector to highlight a picture and press the  (?) button to select or deselect. Selected pictures are marked by a  icon (to view the highlighted picture full screen, press and hold the  button). Repeat as desired to select additional pictures.



2 Delete the selected pictures.



Press . A confirmation dialog will be displayed; highlight **Yes** and press .



■ Select Date: Deleting Pictures Taken on Selected Dates



To delete all unprotected pictures taken on selected dates, choose **Delete** > **Select date** in the playback menu and follow the steps below.

1 Select dates.

Highlight a date and press  to select all pictures taken on the highlighted date. Selected dates are marked with a icon. Repeat as desired to select additional dates; to deselect a date, highlight it and press .



2 Delete the pictures taken on the selected dates.

Press . A confirmation dialog will be displayed; highlight **Yes** and press .

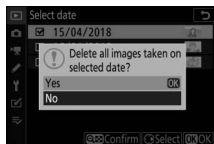

Menu Guide

Learn more about camera menus.

Defaults



The default settings for the options in the camera menus are listed below.

Playback Menu Defaults

Option	Default
Playback folder	All
Image review	Off
After delete	Show next
After burst, show	Last image in burst
Rotate tall	On
Slide show	
Image type	Still images and movies
Frame interval	2 s

Photo Shooting Menu Defaults

Option	Default
Storage folder	
Rename	Z7: NCZ_7 Z6: NCZ_6
Select folder by number	100
File naming	DSC
Choose image area	FX (36×24)
Image quality	JPEG normal
Image size	
JPEG/TIFF	Large
NEF (RAW)	

Option	Default
NEF (RAW) recording	
NEF (RAW) compression	Lossless compressed
NEF (RAW) bit depth	14-bit
ISO sensitivity settings	
ISO sensitivity	
 AUTO	Auto
P, S, A, M	100
Auto ISO sensitivity control	On
Maximum sensitivity	Z 7: 25600 Z 6: 51200
Maximum sensitivity with 	Same as without flash
Minimum shutter speed	Auto
White balance	Auto > Keep overall atmosphere
Fine-tuning	A-B: 0, G-M: 0
Choose color temperature	5000 K
Preset manual	d-1
Set Picture Control	Auto
Color space	sRGB
Active D-Lighting	Off
Long exposure NR	Off
High ISO NR	Normal
Vignette control	Normal
Diffraction compensation	On
Auto distortion control	On
Flicker reduction shooting	Off
Metering	Matrix metering
Flash control	
Flash control mode	TTL
Wireless flash options	Off
Remote flash control	Group flash
Flash mode	Fill flash
Flash compensation	0.0

Option	Default
Focus mode	Single AF
AF-area mode	Single-point AF
Vibration reduction	(Varies with lens)
Auto bracketing	
Auto bracketing set	AE & flash bracketing
Number of shots	0
Increment	1.0
Multiple exposure*	
Multiple exposure mode	Off
Number of shots	2
Overlay mode	Average
Keep all exposures	On
Overlay shooting	On
HDR (high dynamic range)	
HDR mode	Off
Exposure differential	Auto
Smoothing	Normal
Save individual images (NEF)	Off
Interval timer shooting	
Choose start day/time	Now
Interval	1 minute
Intervals×shots/interval	0001×1
Exposure smoothing	Off
Silent photography	Off
Interval priority	Off
Starting storage folder	
New folder	<input type="checkbox"/>
Reset file numbering	<input type="checkbox"/>

Option	Default
Time-lapse movie	
Interval	5 s
Shooting time	25 minutes
Exposure smoothing	On
Silent photography	Off
Choose image area	FX
Frame size/frame rate	1920×1080; 60p
Interval priority	Off
Focus shift shooting	
No. of shots	100
Focus step width	5
Interval until next shot	0
First-frame exposure lock	On
Peaking stack image	Don't create
Silent photography	Off
Starting storage folder	
New folder	<input type="checkbox"/>
Reset file numbering	<input type="checkbox"/>
Silent photography	Off

* Photo shooting menu reset is not available while shooting is in progress.

Movie Shooting Menu Defaults



Option	Default
File naming	DSC
Choose image area	FX
Frame size/frame rate	1920×1080; 60p
Movie quality	High quality
Movie file type	MOV



Option	Default
ISO sensitivity settings	
Maximum sensitivity	Z 7: 25600 Z 6: 51200
Auto ISO control (mode M)	On
ISO sensitivity (mode M)	100
White balance	
Fine-tuning	A-B: 0, G-M: 0
Choose color temperature	5000 K
Preset manual	d-1
Set Picture Control	
Active D-Lighting	Off
High ISO NR	Normal
Vignette control	Normal
Diffraction compensation	On
Auto distortion control	On
Flicker reduction	Auto
Metering	Matrix metering
Focus mode	Full-time AF
AF-area mode	Auto-area AF
Vibration reduction	Same as photo settings
Electronic VR	Off
Microphone sensitivity	Auto
Attenuator	Disable
Frequency response	Wide range
Wind noise reduction	Off
Headphone volume	15
Timecode	
Record timecodes	Off
Count-up method	Record run
Drop frame	On

Custom Settings Menu Defaults

	Option	Default
a1	AF-C priority selection	Release
a2	AF-S priority selection	Focus
a3	Focus tracking with lock-on	3
a4	Auto-area AF face/eye detection	Face and eye detection on
a5	Focus points used	All points
a6	Store points by orientation	No
a7	AF activation	Shutter/AF-ON
a8	Limit AF-area mode selection	
	Pinpoint AF	<input checked="" type="checkbox"/>
	Single-point AF	<input checked="" type="checkbox"/> (cannot be deselected)
	Dynamic-area AF	<input checked="" type="checkbox"/>
	Wide-area AF (S)	<input checked="" type="checkbox"/>
	Wide-area AF (L)	<input checked="" type="checkbox"/>
	Auto-area AF	<input checked="" type="checkbox"/>
a9	Focus point wrap-around	No wrap
a10	Focus point options	
	Manual focus mode	On
	Dynamic-area AF assist	On
a11	Low-light AF	Off
a12	Built-in AF-assist illuminator	On
a13	Manual focus ring in AF mode	Enable
b1	EV steps for exposure cntrl	1/3 step
b2	Easy exposure compensation	Off
b3	Center-weighted area	Ø 12 mm
b4	Fine-tune optimal exposure	
	Matrix metering	0
	Center-weighted metering	0
	Spot metering	0
	Highlight-weighted metering	0

	Option	Default
c1	Shutter-release button AE-L	Off
c2	Self-timer	
	Self-timer delay	10 s
	Number of shots	1
	Interval between shots	0.5 s
c3	Power off delay	
	Playback	10 s
	Menus	1 min
	Image review	4 s
	Standby timer	30 s
d1	CL mode shooting speed	3 fps
d2	Max. continuous release	200
d3	Sync. release mode options	Sync
d4	Exposure delay mode	Off
d5	Shutter type	Auto
d6	Limit selectable image area	
	FX (36×24)	<input checked="" type="checkbox"/> (cannot be deselected)
	DX (24×16)	<input checked="" type="checkbox"/>
	5:4 (30×24) (Z7 only)	<input checked="" type="checkbox"/>
	1:1 (24×24)	<input checked="" type="checkbox"/>
	16:9 (36×20)	<input checked="" type="checkbox"/>
d7	File number sequence	On
d8	Apply settings to live view	On
d9	Framing grid display	Off
d10	Peaking highlights	
	Peaking level	Off
	Peaking highlight color	Red
d11	View all in continuous mode	On

Option		Default
e1	Flash sync speed	1/200 s
e2	Flash shutter speed	1/60 s
e3	Exposure comp. for flash	Entire frame
e4	Auto  ISO sensitivity control	Subject and background
e5	Modeling flash	On
e6	Auto bracketing (mode M)	Flash/speed
e7	Bracketing order	MTR > under > over
f1	Customize  menu	Set Picture Control; White balance; Image quality; Image size; Flash mode; Metering; Wi-Fi connection; Active D-Lighting; Release mode; Vibration reduction; AF-area mode; Focus mode
f2	Custom control assignment	
	Fn1 button	White balance
	Fn2 button	Focus mode/AF-area mode
	AF-ON button	AF-ON
	Sub-selector	Focus point selection
	Sub-selector center	AE/AF lock
	Movie record button	None
	Lens Fn button	AE/AF lock
	Lens Fn2 button	AF-ON
	Lens control ring	(Varies with lens)
f3	OK button	
	Shooting mode	Select center focus point
	Playback mode	Zoom on/off
	Zoom on/off	1 : 1 (100%)
f4	Shutter spd & aperture lock	
	Shutter speed lock	Off
	Aperture lock	

	Option	Default
f5	Customize command dials	
	Reverse rotation	Exposure compensation: <input type="checkbox"/> Shutter speed/aperture: <input type="checkbox"/>
	Change main/sub	Exposure setting: Off Autofocus setting: Off
	Menus and playback	Off
	Sub-dial frame advance	10 frames
f6	Release button to use dial	No
f7	Reverse indicators	
g1	Customize  menu	Set Picture Control; White balance; Frame size and rate/Image quality; Microphone sensitivity; Choose image area; Metering; Wi-Fi connection; Active D-Lighting; Electronic VR; Vibration reduction; AF-area mode; Focus mode
g2	Custom control assignment	
	Fn1 button	White balance
	Fn2 button	Focus mode/AF-area mode
	AF-ON button	AF-ON
	Sub-selector center	AE/AF lock
	Shutter-release button	Take photos
	Lens control ring	(Varies with lens)
g3	OK button	Select center focus point
g4	AF speed	0
	When to apply	Always
g5	AF tracking sensitivity	4
g6	Highlight display	
	Display pattern	Off
	Highlight display threshold	248

Setup Menu Defaults

Option	Default
Time zone and date	
Daylight saving time	Off
Monitor brightness	0
Monitor color balance	A-B: 0, G-M: 0
Viewfinder brightness	Auto
Viewfinder color balance	A-B: 0, G-M: 0
Control panel brightness	Auto
Limit monitor mode selection	
Automatic display switch	<input checked="" type="checkbox"/>
Viewfinder only	<input checked="" type="checkbox"/>
Monitor only	<input checked="" type="checkbox"/>
Prioritize viewfinder	<input checked="" type="checkbox"/>
Information display	Dark on light
AF fine-tune	
AF fine-tune (On/Off)	Off
Clean image sensor	
Automatic cleaning	Clean at shutdown
Beep options	
Beep on/off	Off
Volume	2
Pitch	Low
Touch controls	
Enable/disable touch controls	Enable
Full-frame playback flicks	Left → Right

Option	Default
HDMI	
Output resolution	Auto
Advanced	
Output range	Auto
External recording control	Off
Output data depth	8 bit
N-Log setting	Off
View assist	Off
Location data	
Standby timer	Enable
Set clock from satellite	Yes
Wireless remote (WR) options	
LED lamp	On
Link mode	Pairing
Assign remote (WR) Fn button	None
Airplane mode	Disable
Slot empty release lock	Enable release

▶ The Playback Menu: *Managing Images*

To view playback options, select the ▶ tab in the camera menus.

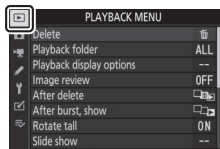

Option	📖
Delete	157
Playback folder	157
Playback display options	157
Image review	158
After delete	158

Option	📖
After burst, show	159
Rotate tall	159
Slide show	160
Rating	161



✔ See Also

For menu defaults, see “Playback Menu Defaults” (📖 145).

Delete

MENU button →  (playback menu)

Delete multiple images.

Option	Description
 Selected	Delete selected pictures.
 Select date	Delete all pictures taken on selected dates.
ALL All	Delete all pictures in the folder currently selected for playback.

Playback Folder

MENU button →  (playback menu)

Choose a folder for playback.

Option	Description
(Folder name)	Pictures in all folders with the selected name will be visible during playback. Folders can be renamed using the Storage folder > Rename option in the photo shooting menu ( 163).
All	Pictures in all folders will be visible during playback.
Current	Only pictures in the current folder will be visible during playback.

Playback Display Options

MENU button →  (playback menu)





Choose the information available in the playback photo information display. Highlight options and press  to select or deselect; items selected for display during full-frame playback are indicated by  icons. To return to the playback menu, press .

Image Review

MENU button →  (playback menu)



Choose whether pictures are displayed automatically immediately after shooting.

Option	Description
On	Pictures appear in the currently-selected display (monitor or viewfinder) as they are taken.
On (monitor only)	Pictures are displayed after shooting only when the monitor is used to frame shots. Pictures are not displayed in the viewfinder during shooting.
Off	Pictures can only be viewed by pressing the  button.

After Delete

MENU button →  (playback menu)

Choose the picture displayed after an image is deleted.

Option	Description
 Show next	The following picture is displayed (if there is no following picture—i.e., if the deleted image was the last picture—the preceding picture will be displayed).
 Show previous	The preceding picture is displayed (if there is no preceding picture—i.e., if the deleted image was the first picture—the next picture will be displayed).
 Continue as before	If you were scrolling through pictures in the order recorded, the following picture will be displayed as described for Show next . If you were scrolling through pictures in reverse order, the preceding picture will be displayed as described for Show previous .

After Burst, Show

MENU button →  (playback menu)

Choose whether the photo displayed immediately after a burst of shots is taken in continuous release mode is the first or last shot in the burst. This option takes effect only when **Image review** ( 158) is off.

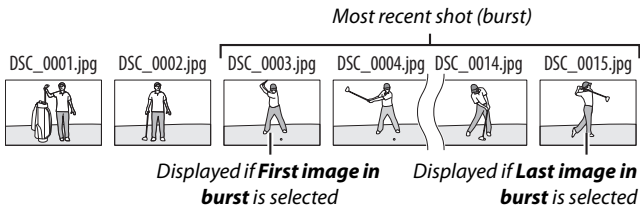



Rotate Tall

MENU button →  (playback menu)

If **On** is selected, “tall” (portrait-orientation) pictures will be automatically rotated for display during playback. Note that because the camera itself is already in the appropriate orientation during shooting, images are not rotated automatically during image review.









Slide Show

MENU button →  (playback menu)

View a slide show of the pictures in the current playback folder ( 157).

Option	Description
Start	Start slide show.
Image type	Choose the type of image displayed from Still images and movies , Still images only , and Movies only , or select By rating to view only pictures with selected ratings (highlight ratings and press  to select or deselect).
Frame interval	Choose how long each picture will be displayed.

To start the slide show, highlight **Start** and press . The following operations can be performed while the show is in progress:

- **Skip back/skip ahead:** Press  to return to the previous frame,  to skip to the next frame.
- **View additional photo info:** Press  or  to change or hide the photo info displayed (still images only).
- **Pause:** Press  to pause the slide show. To restart, highlight **Restart** and press .
- **Adjust volume:** Press  during movie playback to increase the volume,  (?) to decrease.
- **Exit to the playback menu:** Press MENU to end the slide show and return to the playback menu.
- **Exit to playback mode:** Press  to end the slide show and exit to playback mode.
- **Exit to shooting mode:** Press the shutter-release button halfway to return to shooting mode.

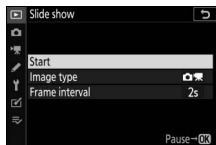



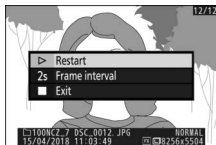



A dialog is displayed when the show ends. Select **Restart** to restart or **Exit** to return to the playback menu.



Rating

MENU button →  (playback menu)

Rate pictures or mark them as candidates for later deletion. Press  or  to highlight pictures and press  or  to choose a rating of from zero to five stars, or select  to mark the picture as a candidate for later deletion (to view the highlighted picture full screen, press and hold the  button). Press  to exit when the operation is complete.



The Photo Shooting Menu: *Shooting Options*

To view the photo shooting menu, select the  tab in the camera menus.



Option	
Reset photo shooting menu	163
Storage folder	163
File naming	167
Choose image area	167
Image quality	168
Image size	168
NEF (RAW) recording	170
ISO sensitivity settings	171
White balance	172
Set Picture Control	179
Manage Picture Control	181
Color space	184
Active D-Lighting	184
Long exposure NR	185
High ISO NR	185
Vignette control	186
Diffraction compensation	186

Option	
Auto distortion control	186
Flicker reduction shooting	187
Metering	187
Flash control	188
Flash mode	190
Flash compensation	191
Focus mode	191
AF-area mode	191
Vibration reduction	191
Auto bracketing	192
Multiple exposure	202
HDR (high dynamic range)	209
Interval timer shooting	214
Time-lapse movie	225
Focus shift shooting	233
Silent photography	239

See Also

For menu defaults, see “Photo Shooting Menu Defaults” ( 145).

Reset Photo Shooting Menu

MENU button →  (photo shooting menu)

Select **Yes** to restore photo shooting menu options to their default values (📖 145).

Storage Folder

MENU button →  (photo shooting menu)

Rename folders and select the folder in which subsequent pictures will be stored.

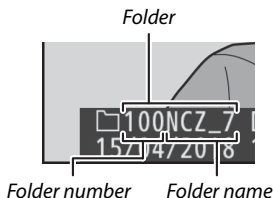

Rename

Folders are identified by a 5-character folder name preceded by a 3-digit folder number assigned automatically by the camera. The default folder name is "NCZ_7" (Z 7) or "NCZ_6" (Z 6); to change the name assigned to new folders, select **Rename**. If desired, the default name can be restored by pressing and holding the  button while the keyboard is displayed. Existing folders cannot be renamed.

✔ Text Entry

A keyboard is displayed when text entry is required. Tap letters on the screen or use the multi selector to highlight characters and press **OK** to insert them at the current cursor position (note that if a character is entered when the field is full, the last character in the field will be deleted). To delete the character under the cursor, press the **⌫** button. To move the cursor to a new position, tap the display or rotate the main command dial. To complete entry and return to the previous menu, press **OK**. To exit without completing text entry, press **MENU**.







Select Folder by Number



To select folders by number or create a new folder with the current folder name and a new folder number:

1 Choose **Select folder by number**.

Highlight **Select folder by number** and press .

2 Choose a folder number.

Press  or  to highlight digits and press  or  to change. If a folder with the selected number already exists, one of the following icons will be displayed:

- : Folder is empty.
 - : Folder is partially full.
 - : Folder contains 5000 pictures or a picture numbered 9999. No further pictures can be stored in this folder.
-



3 Save changes and exit.

Press  to complete the operation and return to the main menu (to exit without changing the storage folder, press the **MENU** button). If a folder with the specified number does not already exist, a new folder will be created. Subsequent photographs will be stored in the selected folder unless it is already full.

Select Folder from List

To choose from a list of existing folders:

1 Choose **Select folder from list**.

Highlight **Select folder from list** and press \odot .

2 Highlight a folder.

Press \odot or \odot to highlight a folder.



3 Select the highlighted folder.

Press \odot to select the highlighted folder and return to the main menu. Subsequent photographs will be stored in the selected folder.

✔ Folder and File Numbers

Once the folder number has reached 999, no new folders will be created (and the shutter release will consequently be disabled) after the file number reaches 9999 or the number of files in the folder reaches 5000, or if you attempt to record a movie when the camera calculates that the number of files needed for a movie of maximum length would result in the creation of a file numbered higher than 9999 or the folder holding over 5000 files. To continue shooting, create a folder with a number less than 999 or try changing the options selected for **Frame size/frame rate** and **Movie quality**.

✔ Startup Time

Additional time may be required for camera startup if the memory card contains a very large number of files or folders.

File Naming

MENU button →  (photo shooting menu)

Photographs are saved using file names consisting of “DSC_” or, in the case of images that use the Adobe RGB color space (📖 184), “_DSC”, followed by a four-digit number and a three-letter extension (e.g., “DSC_0001.JPG” or “_DSC0002.JPG”). The **File naming** option is used to select three letters to replace the “DSC” portion of the file name as described in “Text Entry” (📖 164).

✓ Extensions

The following extensions are used: “.NEF” for NEF (RAW) images, “.TIF” for TIFF (RGB) images, “.JPG” for JPEG images, “.MOV” for MOV movies, “.MP4” for MP4 movies, and “.NDF” for dust off reference data. In each pair of photographs recorded at image-quality settings of NEF (RAW)+JPEG, the NEF and JPEG images have the same file names but different extensions.

Choose Image Area

MENU button →  (photo shooting menu)

The camera offers a choice of the following image areas:





Option	Description
 FX (36×24)	Images are recorded in FX format with an angle of view equivalent to a NIKKOR lens on a 35 mm format camera.
 DX (24×16)	Images are recorded in DX format. To calculate the approximate focal length of the lens in 35 mm format, multiply by 1.5.
 5 : 4 (30×24)	Pictures are recorded with an aspect ratio of 5 : 4 (Z 7 only).
 1 : 1 (24×24)	Pictures are recorded with an aspect ratio of 1 : 1.
 16 : 9 (36×20)	Pictures are recorded with an aspect ratio of 16 : 9.

Image Quality

MENU button →  (photo shooting menu)

Choose a file format for photographs. For more information, see “Image Quality” (📖 106).

Image Size

MENU button →  (photo shooting menu)

Choose the size, in pixels, of photographs recorded with the camera. Select **JPEG/TIFF** to choose the size of JPEG and TIFF images, **NEF (RAW)** to choose the size of NEF (RAW) images.

Z7:

Image area	Option	Size (pixels)	Print size (cm/in.)*
FX (36×24) FX format	Large	8256 × 5504	69.9 × 46.6/27.5 × 18.3
	Medium	6192 × 4128	52.4 × 35.0/20.6 × 13.8
	Small	4128 × 2752	35.0 × 23.3/13.8 × 9.2
DX (24×16) DX format	Large	5408 × 3600	45.8 × 30.5/18.0 × 12.0
	Medium	4048 × 2696	34.3 × 22.8/13.5 × 9.0
	Small	2704 × 1800	22.9 × 15.2/9.0 × 6.0
5 : 4 (30×24)	Large	6880 × 5504	58.3 × 46.6/22.9 × 18.3
	Medium	5152 × 4120	43.6 × 34.9/17.2 × 13.7
	Small	3440 × 2752	29.1 × 23.3/11.5 × 9.2
1 : 1 (24×24)	Large	5504 × 5504	46.6 × 46.6/18.3 × 18.3
	Medium	4128 × 4128	35.0 × 35.0/13.8 × 13.8
	Small	2752 × 2752	23.3 × 23.3/9.2 × 9.2
16 : 9 (36×20)	Large	8256 × 4640	69.9 × 39.3/27.5 × 15.5
	Medium	6192 × 3480	52.4 × 29.5/20.6 × 11.6
	Small	4128 × 2320	35.0 × 19.6/13.8 × 7.7

* Approximate size when printed at 300 dpi. Print size in inches equals image size in pixels divided by printer resolution in dots per inch (dpi; 1 inch = approximately 2.54 cm).

Z 6:

Image area	Option	Size (pixels)	Print size (cm/in.)*
FX (36×24) FX format	Large	6048 × 4024	51.2 × 34.1/20.2 × 13.4
	Medium	4528 × 3016	38.3 × 25.5/15.1 × 10.1
	Small	3024 × 2016	25.6 × 17.1/10.1 × 6.7
DX (24×16) DX format	Large	3936 × 2624	33.3 × 22.2/13.1 × 8.7
	Medium	2944 × 1968	24.9 × 16.7/9.8 × 6.6
	Small	1968 × 1312	16.7 × 11.1/6.6 × 4.4
1 : 1 (24×24)	Large	4016 × 4016	34.0 × 34.0/13.4 × 13.4
	Medium	3008 × 3008	25.5 × 25.5/10.0 × 10.0
	Small	2000 × 2000	16.9 × 16.9/6.7 × 6.7
16 : 9 (36×20)	Large	6048 × 3400	51.2 × 28.8/20.2 × 11.3
	Medium	4528 × 2544	38.3 × 21.5/15.1 × 8.5
	Small	3024 × 1696	25.6 × 14.4/10.1 × 5.7

* Approximate size when printed at 300 dpi. Print size in inches equals image size in pixels divided by printer resolution in **dots per inch (dpi)**; 1 inch = approximately 2.54 cm).



NEF (RAW) Recording

MENU button →  (photo shooting menu)

Choose a compression type and bit depth for NEF (RAW) photographs.

NEF (RAW) Compression

Use compression to reduce file size.

Option	Description
ON  Lossless compressed	NEF images are compressed using a reversible algorithm, reducing file size by about 20–40% with no effect on image quality.
ON  Compressed	NEF images are compressed using a non-reversible algorithm, reducing file size by about 35–55% with almost no effect on image quality.
Uncompressed	NEF images are not compressed.

NEF (RAW) Bit Depth



Bit depth determines the depth of color data recorded.

Option	Description
12-bit 12-bit	NEF (RAW) images are recorded at a bit depth of 12 bits.
14-bit 14-bit	NEF (RAW) images are recorded at a bit depth of 14 bits, producing files larger than those with a bit depth of 12 bits but increasing the color data recorded.

ISO Sensitivity Settings

MENU button →  (photo shooting menu)

Adjust ISO sensitivity settings for photographs.

Option	Description
ISO sensitivity	Adjust ISO sensitivity. Select from values between ISO 64 and 25600 (or in the case of the Z 6, between ISO 100 and ISO 51200). Settings of from about 0.3 to 1 EV below the lowest of these values and 0.3 to 2 EV above the highest are also available for special situations. ^{AUTO}  mode offers an additional Auto option.
Auto ISO sensitivity control	If On is selected, the camera will automatically adjust ISO sensitivity when optimal exposure cannot be achieved at the value selected for ISO sensitivity . The options listed below are available for fine-tuning auto ISO sensitivity control. <ul style="list-style-type: none">• Maximum sensitivity: Choose an upper limit for ISO sensitivity to prevent it being raised too high.• Maximum sensitivity with : Choose the upper ISO sensitivity limit for photos taken using an optional flash unit.• Minimum shutter speed: Choose the shutter speed below which auto ISO sensitivity control will kick in to prevent underexposure in modes P and A. Options range from 1/4000 s to 30 s. An Auto option is also available ( 172).

"Minimum Shutter Speed" > "Auto"

If **Auto** is selected for **Auto ISO sensitivity control** > **Minimum shutter speed**, the camera will choose the minimum shutter speed based on the focal length of the lens. For example, the camera will automatically select fast minimum shutter speeds to reduce the blur that commonly occurs with telephoto lenses.

Auto shutter-speed selection can be fine-tuned for faster or slower minimum values by highlighting **Auto** and pressing ; choosing fast minimum shutter speeds when photographing fast-moving objects reduces blur.

Shutter speeds may drop below the selected minimum if optimum exposure cannot be achieved at the ISO sensitivity chosen for **Maximum sensitivity**.

White Balance

MENU button →  (photo shooting menu)

Adjust white balance. For more information, see the "White Balance" sections in "Basic Settings" (📖 64) and "The  Menu" (📖 100).

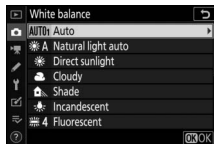

The White Balance Menu: Fine-Tuning

Fine-tuning is available via the camera menus. For more information on fine-tuning, see “Fine-Tuning White Balance” (📖 101). For information on fine-tuning preset manual white balance, see “Fine-Tuning Preset White Balance” (📖 178).

1 Display fine-tuning options.

Go to **White balance** in the photo shooting menu, highlight a white balance option, and press .

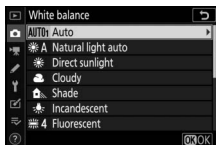

2 Fine-tune white balance.

Use the multi selector to fine-tune white balance. White balance can be fine-tuned on the **Amber–Blue** axis in steps of 0.5 and the **Green–Magenta** axis in steps of 0.25. The horizontal (**Amber–Blue**) axis corresponds to color temperature, while the vertical (**Green–Magenta**) axis has the similar effects to the corresponding color compensation (CC) filters. The horizontal axis is ruled in increments equivalent to about 5 mired, the vertical axis in increments of about 0.05 diffuse density units.

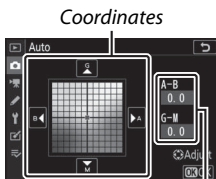

Adjustment

3 Save changes and exit.

Press **OK** to save settings and return to the photo shooting menu. If white balance has been fine-tuned, an asterisk (“*”) will appear next to the white balance icon in the shooting display.



✓ White Balance Fine-Tuning

The colors on the fine-tuning axes are relative, not absolute. For example, moving the cursor to **B** (blue) when a “warm” setting such as **Incandescent** is selected for white balance will make photographs slightly “colder” but will not actually make them blue.

✓ “Mired”

Any given change in color temperature produces a greater difference in color at low color temperatures than it would at higher color temperatures. For example, a change of 1000 K produces a much greater change in color at 3000 K than at 6000 K. Mired, calculated by multiplying the inverse of the color temperature by 10^6 , is a measure of color temperature that takes such variation into account, and as such is the unit used in color-temperature compensation filters. E.g.:

- 4000 K–3000 K (a difference of 1000 K)=83 mired
- 7000 K–6000 K (a difference of 1000 K)=24 mired

The White Balance Menu: Choosing a Color Temperature

Color temperature can be selected using the **White balance** > **Choose color temperature** option in the photo shooting menu. Enter values for the amber–blue and green–magenta axes as described below.

1 Select **Choose color temperature**.

Go to **White balance** in the photo shooting menu, highlight **Choose color temperature** and press \odot .

2 Select values for amber–blue and green–magenta.

Press \leftarrow or \rightarrow to highlight digits on the **Amber–Blue** or **Green–Magenta** axis and press \uparrow or \downarrow to change.

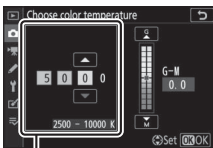

*Value for
Amber–Blue axis*

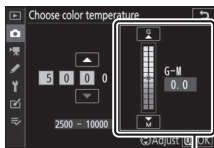

*Value for
Green–Magenta axis*

3 Save changes and exit.

Press \odot to save settings and return to the photo shooting menu. If a value other than zero is selected for the **Green–Magenta** axis, an asterisk (“*”) will appear next to the white balance icon in the shooting display.



 **Choose Color Temperature**

Note that the desired results will not be obtained with fluorescent lighting. Choose  (**Fluorescent**) for fluorescent light sources. With other light sources, take a test shot to determine if the selected value is appropriate.

Preset Manual: Copying White Balance from a Photograph

The **Preset manual** option in the white balance menu can be used to copy a white balance value from an existing photograph. For more information on preset manual white balance, see “Preset Manual” (📖 103).

1 Select **Preset manual**.

Go to **White balance** in the photo shooting menu, highlight **Preset manual**, and press **▶**.

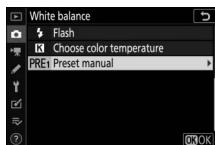

2 Select a destination.

Highlight the destination preset (d-1 to d-6) and press **Ⓜ**.



3 Choose **Select image**.

The preset manual white balance menu will be displayed; highlight **Select image** and press **▶**.

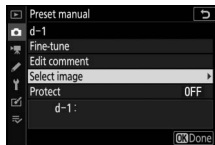

4 Highlight a source image.

Highlight the source image. To view the highlighted image full frame, press and hold the **Ⓜ** button.



5 Copy white balance.

Press **OK** to copy the white balance value from the highlighted photograph to the selected preset. If the highlighted photograph has a comment, the comment will be copied to the comment for the selected preset.

✓ Fine-Tuning Preset White Balance

The current preset can be fine-tuned by selecting **Fine-tune** in the preset manual white balance menu and adjusting white balance as described in “The White Balance Menu: Fine-Tuning” (□ 173).

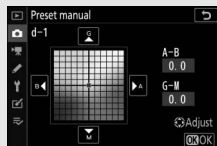

✓ Edit Comment

To enter a descriptive comment of up to 36 characters for the current white-balance preset, select **Edit comment** in the preset manual white balance menu.



✓ Protect

To protect the current white-balance preset, select **Protect** in the preset manual white balance menu, then highlight **On** and press **OK**. Protected presets cannot be modified and the **Fine-tune** and **Edit comment** options cannot be used.

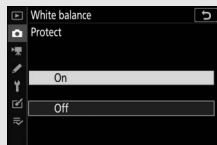

Set Picture Control

MENU button → 📷 (photo shooting menu)

Choose how new photos will be processed. For more information, see “Set Picture Control” (📖 96).

Set Picture Control: Modifying Picture Controls





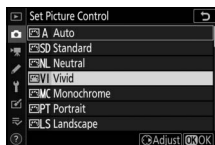

Existing preset or custom Picture Controls can be modified to suit the scene or the user’s creative intent.

1 Select a Picture Control.

Highlight the desired Picture Control in the Picture Control list and press .



2 Adjust settings.

Press  or  to highlight the desired setting and press  or  to choose a value in increments of 1, or rotate the sub-command dial to choose a value in increments of 0.25 (the options available vary with the Picture Control selected). To quickly adjust levels for balanced **Sharpening**, **Mid-range sharpening**, and **Clarity**, highlight **Quick sharp** and press  or . Repeat this step until all settings have been adjusted. Default settings can be restored by pressing the  button.



3 Save changes and exit.

Press  to save changes and return to the Picture Control list.

✔ Custom Picture Controls

Modifications to existing Picture Controls can be saved as custom Picture Controls using the **Manage Picture Control** option in the photo or movie shooting menu. Custom Picture Controls can be copied to a memory card and used in compatible software or shared among cameras of the same model.

✔ The *i* Menu

Modifying Picture Controls from the *i* menu allows the effect to be previewed in the display. Highlight **Set Picture Control** in the *i* menu and press **OK**, then press **⬅** and **➡** to choose a Picture Control and press **⬇** to display Picture Control settings.



Manage Picture Control

MENU button →  (photo shooting menu)

Save modified Picture Controls as custom Picture Controls.

Option	Description
Save/edit	Create a new custom Picture Control based on an existing preset or custom Picture Control, or edit existing custom Picture Controls.
Rename	Rename custom Picture Controls.
Delete	Delete custom Picture Controls.
Load/save	<p>Use the following options to copy custom Picture Controls to and from the memory card. Once copied to the memory card, Picture Controls can be used with other cameras or compatible software.</p> <ul style="list-style-type: none">• Copy to camera: Copy custom Picture Controls from the memory card to custom Picture Controls C-1 through C-9 on the camera and name them as desired.• Delete from card: Delete selected custom Picture Controls from the memory card.• Copy to card: Copy a custom Picture Control (C-1 through C-9) from the camera to a selected destination (1 through 99) on the memory card.

Creating Custom Picture Controls

The Picture Controls supplied with the camera can be modified and saved as custom Picture Controls.

1 Select Save/edit.

Highlight **Save/edit** and press \odot .

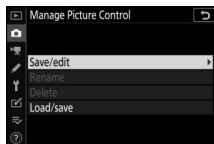

2 Select a Picture Control.

Highlight an existing Picture Control and press \odot , or press \odot to proceed to Step 4 to save a copy of the highlighted Picture Control without further modification.

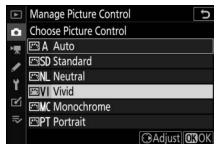

3 Edit the selected Picture Control.

To abandon any changes and start over from default settings, press the ⏏ button. Press \odot when settings are complete.



4 Select a destination.

Choose a destination for the custom Picture Control (C-1 through C-9) and press \odot .

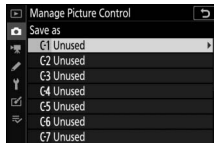

5 Name the Picture Control.

A text-entry dialog will be displayed. By default, new Picture Controls are named by adding a two-digit number (assigned automatically) to the name of the existing Picture Control; to choose a different name, rename the Picture Control as described in “Text Entry” (164). Tap the keyboard selection button to cycle through the upper-case, lower-case, and symbol keyboards. Custom Picture Control names can be up to nineteen characters long. Any characters after the nineteenth will be deleted.

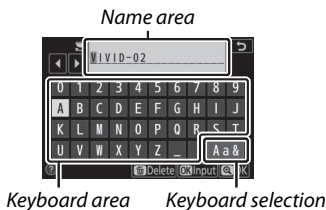

✓ Custom Picture Control Options

The options available with custom Picture Controls are the same as those on which the custom Picture Control was based.

✓ The Original Picture Control Icon

The original preset Picture Control on which the custom Picture Control is based is indicated by an icon in the top right corner of the edit display.

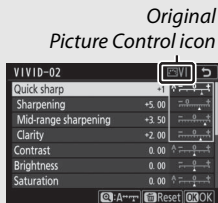

Color Space

MENU button →  (photo shooting menu)

The color space determines the gamut of colors available for color reproduction. **sRGB** is recommended for general-purpose printing and display, **Adobe RGB**, with its broader gamut of colors, for professional publication and commercial printing.

Adobe RGB

For accurate color reproduction, Adobe RGB images require applications, displays, and printers that support color management.

Color Space

ViewNX-i and Capture NX-D automatically select the correct color space when opening photographs created with this camera. Results cannot be guaranteed with third-party software.

Active D-Lighting

MENU button →  (photo shooting menu)

Preserve details in highlights and shadows, creating pictures with natural contrast. For more information, see “Active D-Lighting” ( 112).

Long Exposure NR

MENU button →  (photo shooting menu)

If **On** is selected, photographs taken at shutter speeds slower than 1 s will be processed to reduce noise (bright spots or fog). The time required for processing roughly doubles; during processing, the message “Performing noise reduction” will be displayed, “**Job NR**” will flash in the control panel, and pictures cannot be taken (if the camera is turned off before processing is complete, the picture will be saved but noise reduction will not be performed).

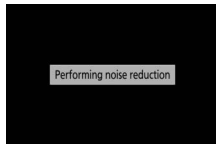
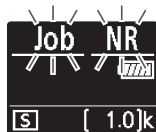

High ISO NR

MENU button →  (photo shooting menu)

Photographs taken at high ISO sensitivities can be processed to reduce “noise”.

Option	Description
High/ Normal/ Low	Reduce noise (randomly-spaced bright pixels), particularly in pictures taken at high ISO sensitivities. Choose the amount of noise reduction performed from High , Normal , and Low .
Off	Noise reduction is performed only as required and never at an amount as high as when Low is selected.

Vignette Control

MENU button →  (photo shooting menu)

Vignette control reduces the drop in brightness that occurs at the edges of the frame. Its effects vary from lens to lens and are most noticeable at maximum aperture. Choose from **High**, **Normal**, **Low**, and **Off**.

Vignette Control

Depending on the scene, shooting conditions, and type of lens, TIFF and JPEG images may exhibit noise (fog) or variations in peripheral brightness, while custom Picture Controls and preset Picture Controls that have been modified from default settings may not produce the desired effect. Take test shots and view the results in the display.

Diffraction Compensation

MENU button →  (photo shooting menu)

Select **On** to reduce diffraction at small apertures (high f/-numbers).

Auto Distortion Control

MENU button →  (photo shooting menu)

Select **On** as required to reduce barrel distortion when shooting with wide-angle lenses and to reduce pin-cushion distortion when shooting with long lenses (note that **On** may be selected automatically with some lenses, in which case the **Auto distortion control** option will be grayed out and unavailable).

Flicker Reduction Shooting

MENU button →  (photo shooting menu)

When **On** is selected, the camera will time photographs to reduce banding, areas of under- or over-exposure, or (in photographs taken in continuous release modes) uneven coloration caused by the flicker of such light sources as fluorescent or mercury-vapor lamps (note that the frame rate may drop while flicker reduction is in effect, and that the frame rate may slow or become erratic during burst shooting).

✔ “Flicker Reduction Shooting” in the Photo Shooting Menu

Flicker reduction can detect flicker at 100 and 120 Hz (associated respectively with AC power supplies of 50 and 60 Hz). Flicker may not be detected or the desired results may not be achieved with dark backgrounds, bright light sources, or decorative lighting displays and other non-standard lighting. Depending on the light source, there may be a slight delay before the shutter is released. The desired results may not be achieved if the frequency of the power supply changes during shooting.

Flicker detection will not take effect at shutter speeds slower than $\frac{1}{100}$ s (including **Bulb** and **Time**) or when **Continuous H (extended)** is selected for release mode or silent photography, HDR, or exposure delay mode is enabled.

Metering

MENU button →  (photo shooting menu)

Metering determines how the camera sets exposure. For more information, see “Metering” (📖 110).

Flash Control

MENU button → 📷 (photo shooting menu)

Adjust settings for wireless remote flash units (📖 364) or optional flash units mounted on the camera accessory shoe (📖 351).

Flash Control Mode

Choose a flash control mode and flash level and adjust other settings for SB-5000, SB-500, SB-400, or SB-300 flash units mounted on the camera accessory shoe (settings for an SB-5000 mounted on the accessory shoe can also be adjusted using the controls on the flash unit, while settings for other flash units can only be adjusted using flash unit controls). The options available under **Flash control mode** vary with the mode selected.

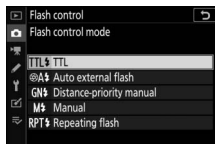



- **TTL:** i-TTL mode. Flash level is adjusted automatically in response to shooting conditions.
- **Auto external flash:** In this mode, output is adjusted automatically according to the amount of light reflected by the subject.
- **Distance-priority manual:** Choose the distance to the subject; flash output will be adjusted automatically.
- **Manual:** Choose the flash level manually.
- **Repeating flash:** The flash fires repeatedly while the shutter is open, producing a multiple-exposure effect.

Wireless Flash Options

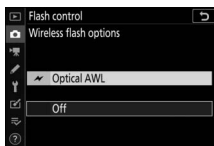
Adjust settings for simultaneous wireless control of multiple remote flash units. This option is available only when an SB-5000 or SB-500 flash unit or a WR-R10 wireless remote controller is mounted on the camera.



Option	Description
 Optical AWL	The remote flash units are controlled using low-intensity flashes emitted by the master flash (□ 377).
 Optical/ radio AWL	Choose this option when using both optically- and radio-controlled flash units (□ 385).
 Radio AWL	The remote flash units are controlled by radio signals from a WR-R10 attached to the camera (□ 366).
Off	Remote flash photography disabled.

Remote Flash Control

Choose from the remote flash photography options listed below (📖 370, 377).

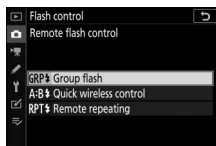

Option	Description
Group flash	Choose a separate flash control mode for each group of remote flash units.
Quick wireless control	Choose the balance between groups A and B and set the output for group C manually.
Remote repeating	The flash units fire repeatedly while the shutter is open, producing a multiple-exposure effect.

Radio Remote Flash Info

View the flash units currently controlled via radio AWL.

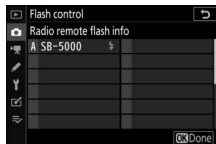

Flash Mode

MENU button → 📷 (photo shooting menu)

Choose the flash mode for wireless remote flash units or flash units mounted on the camera accessory shoe. For more information, see “Flash Mode” (📖 109, 356).

Flash Compensation

MENU button →  (photo shooting menu)

Adjust flash output to control the brightness of the main subject relative to the background (📖 358). Flash output can be increased to make the main subject appear brighter or reduced to prevent unwanted highlights or reflections.

Focus Mode

MENU button →  (photo shooting menu)

The focus mode controls how the camera focuses. For more information, see “Choosing a Focus Mode” (📖 52).

AF-Area Mode

MENU button →  (photo shooting menu)

Choose how the camera selects the focus-point for autofocus. For more information, see “AF-Area Mode” (📖 54).

Vibration Reduction

MENU button →  (photo shooting menu)

Choose whether to enable vibration reduction. For more information, see “Vibration Reduction” (📖 114).

Auto Bracketing

MENU button →  (photo shooting menu)

Vary exposure, flash level, Active D-Lighting (ADL), or white balance slightly with each shot, “bracketing” the current value. Bracketing can be used in situations in which getting the right settings is difficult and there is not time to check results and adjust settings with each shot, or to experiment with different settings for the same subject. The following options are available:

- **Auto bracketing set:** Choose the setting or settings bracketed when auto bracketing is in effect. Choose **AE & flash bracketing** to perform both exposure and flash-level bracketing, **AE bracketing** to bracket only exposure, **Flash bracketing** to perform only flash-level bracketing, **WB bracketing** to perform white-balance bracketing, or **ADL bracketing** to perform bracketing using Active D-Lighting.
- **Number of shots:** Choose the number of shots in the bracketing sequence.
- **Increment:** Choose the amount the selected settings vary with each shot (ADL bracketing excluded).
- **Amount:** Choose how Active D-Lighting varies with each shot (ADL bracketing only).

Exposure and Flash Bracketing

Vary exposure and/or flash level over a series of photographs.



Exposure modified by:
0 EV



Exposure modified by:
-1 EV



Exposure modified by:
+1 EV

1 Choose the bracketing type.

Select an option for **Auto bracketing set**. Choose **AE & flash bracketing** to vary both exposure and flash level, **AE bracketing** to vary only exposure, or **Flash bracketing** to vary only flash level. Note that flash bracketing is available in i-TTL and, where supported, auto aperture (A) flash control modes only (410).

2 Choose the number of shots.

Highlight **Number of shots** and press \leftarrow or \rightarrow to choose the number of shots in the bracketing sequence.



At settings other than **0F**, a bracketing icon will appear in the display.



3 Choose a bracketing increment.
 Highlight **Increment** and press \odot or \odot to choose the bracketing increment. At default settings, the size of the increment can be chosen from 0.3 ($\frac{1}{3}$), 0.7 ($\frac{2}{3}$), 1, 2, and 3 EV. The bracketing programs with an increment of 0.3 ($\frac{1}{3}$) EV are listed below.



"Number of shots"	Bracketing indicator	No. of shots	Bracketing order (EVs)
0F	-0.....+	0	0
+3F	-0 :.....+	3	0/+0.3/+0.7
-3F	-0 :.....+	3	0/-0.7/-0.3
+2F	-0 :.....+	2	0/+0.3
-2F	-0 :.....+	2	0/-0.3
3F	-0 :.....+	3	0/-0.3/+0.3
5F	-0 :.....+	5	0/-0.7/-0.3/+0.3/+0.7
7F	-0 :.....+	7	0/-1.0/-0.7/-0.3/+0.3/ +0.7/+1.0
9F	-0 :.....+	9	0/-1.3/-1.0/-0.7/-0.3/ +0.3/+0.7/+1.0/+1.3

Note that for exposure increments of 2 EV or more, the maximum number of shots is 5; if a higher value was selected in Step 2, the number of shots will automatically be set to 5.

4 Frame a photograph, focus, and shoot.

The camera will vary exposure and/or flash level shot-by-shot according to the bracketing program selected; the modified values for shutter speed and aperture are shown in the display. Modifications to exposure are added to those made with exposure compensation.



While bracketing is in effect, the display shows a bracketing icon, a bracketing progress indicator, and the number of shots remaining in the bracketing sequence. After each shot, a segment will disappear from the indicator and the number of shots remaining will be reduced by one.



No. shots: 3; increment: 0.7

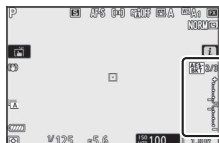

Display after first shot

■ ■ Canceling Bracketing

To cancel bracketing, select **0F** for **Number of shots**.

✔ Exposure and Flash Bracketing

In continuous release modes, shooting will pause after the number of shots specified in the bracketing program have been taken. Shooting will resume the next time the shutter-release button is pressed.

If the memory card fills before all shots in the sequence have been taken, shooting can be resumed from the next shot in the sequence after the memory card has been replaced or shots have been deleted to make room on the memory card. If the camera is turned off before all shots in the sequence have been taken, bracketing will resume from the next shot in the sequence when the camera is turned on.

✔ Exposure Bracketing

The camera modifies exposure by varying shutter speed and aperture (mode **P**), aperture (mode **S**), or shutter speed (modes **A** and **M**). If **On** is selected for **ISO sensitivity settings > Auto ISO sensitivity control** in modes **P**, **S**, and **A**, the camera will automatically vary ISO sensitivity for optimum exposure when the limits of the camera exposure system are exceeded; in mode **M**, the camera will first use auto ISO sensitivity control to bring exposure as close as possible to the optimum and then bracket this exposure by varying shutter speed. Custom Setting e6 (**Auto bracketing (mode M)**) can be used to change how the camera performs exposure and flash bracketing in mode **M**: by varying flash level together with shutter speed and/or aperture, or by varying flash level alone.

White Balance Bracketing

The camera creates multiple copies of each photograph, each with a different white balance.

1 Choose WB bracketing.

Select **WB bracketing** for **Auto bracketing set**.

2 Choose the number of shots.

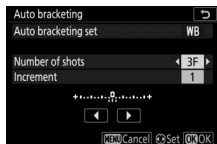

Highlight **Number of shots** and press \leftarrow or \rightarrow to choose the number of shots in the bracketing sequence.



At settings other than **0F**, a bracketing icon will appear in the display.



3 Choose a bracketing increment.

Highlight **Increment** and press  or  to choose the bracketing increment. Each increment is roughly equivalent to 5 mired. Choose from increments of 1 (5 mired), 2 (10 mired), or 3 (15 mired). Higher **B** values correspond to increased amounts of blue, higher **A** values to increased amounts of amber. The bracketing programs with an increment of 1 are listed below.



"Number of shots"	Bracketing indicator	No. of shots	Increment	Bracketing order
0F	+.....o.....+	0	1	0
B3F	+.....:o.....+	3	1B	0/B1/B2
A3F	+.....o:.....+	3	1A	0/A2/A1
B2F	+.....:o.....+	2	1B	0/B1
A2F	+.....o:.....+	2	1A	0/A1
3F	+.....:o.....+	3	1A, 1B	0/A1/B1
5F	+.....:o:.....+	5		0/A2/A1/B1/B2
7F	+.....:o:.....+	7		0/A3/A2/A1/ B1/B2/B3
9F	+.....:o:.....+	9		0/A4/A3/A2/A1/ B1/B2/B3/B4

4 Frame a photograph, focus, and shoot.

Each shot will be processed to create the number of copies specified in the bracketing program, and each copy will have a different white balance.



Modifications to white balance are added to the white balance adjustment made with white balance fine-tuning.

If the number of shots in the bracketing program is greater than the number of exposures remaining, the shutter release will be disabled. Shooting can begin when a new memory card is inserted.

■ ■ *Canceling Bracketing*

To cancel bracketing, select **0F** for **Number of shots**.

✓ **White Balance Bracketing**

White balance bracketing is not available at an image quality of NEF (RAW). Selecting an NEF (RAW) or NEF (RAW) + JPEG option cancels white balance bracketing.

White balance bracketing affects only color temperature (the amber-blue axis in the white balance fine-tuning display). No adjustments are made on the green-magenta axis.

In self-timer mode, the number of copies specified in the bracketing program will be created each time the shutter is released, regardless of the option selected for Custom Setting c2 (**Self-timer**) > **Number of shots**.

If the camera is turned off while the memory card access lamp is lit, the camera will power off only after all photographs in the sequence have been recorded.



ADL Bracketing

The camera varies Active D-Lighting over a series of exposures.

1 Choose ADL bracketing.

Select **ADL bracketing** for **Auto bracketing set**.

2 Choose the number of shots.

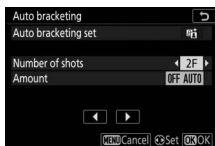

Highlight **Number of shots** and press  or  to choose the number of shots in the bracketing sequence. Choose two shots to take one photograph with Active D-Lighting off and another at the value selected in Step 3. Choose three to five shots to take a series of photographs with Active D-Lighting set to **Off**, **Low**, and **Normal** (three shots), **Off**, **Low**, **Normal**, and **High** (four shots), or **Off**, **Low**, **Normal**, **High**, and **Extra high** (five shots). If you choose more than two shots, proceed to Step 4.

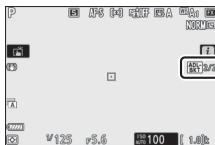

At settings other than **Off**, a bracketing icon will appear in the display.



3 Choose a value for Active D-Lighting.

Highlight **Amount** and press  or  to choose an option. The chosen setting applies when **2F** is selected for **Number of shots**.

Amount	Bracketing order
OFF L	Off/Low
OFF N	Off/Normal
OFF H	Off/High
OFF H ⁺	Off/Extra high
OFF AUTO	Off/Auto

4 Frame a photograph, focus, and shoot.

The camera will vary Active D-Lighting shot-by-shot according to the bracketing program selected.



While bracketing is in effect, the display shows an ADL bracketing icon and the number of shots remaining in the bracketing sequence. After each shot, the number of shots remaining will be reduced by one.



Canceling Bracketing

To cancel bracketing, select **0F** for **Number of shots**.

✓ ADL Bracketing

In continuous release modes, shooting will pause after the number of shots specified in the bracketing program have been taken. Shooting will resume the next time the shutter-release button is pressed.

If the memory card fills before all shots in the sequence have been taken, shooting can be resumed from the next shot in the sequence after the memory card has been replaced or shots have been deleted to make room on the memory card. If the camera is turned off before all shots in the sequence have been taken, bracketing will resume from the next shot in the sequence when the camera is turned on.

Multiple Exposure

MENU button → 📷 (photo shooting menu)

Record two to ten NEF (RAW) exposures as a single photograph. The following options are available:

- **Multiple exposure mode:** Choose from **On (series)** (take a series of multiple exposures, ending when **Off** is selected), **On (single photo)** (take one multiple exposure), or **Off** (exit without creating additional multiple exposures).
- **Number of shots:** Choose the number of exposures that will be combined to form a single photograph.
- **Overlay mode:** Choose from the options below.
 - **Add:** The exposures are overlaid without modification; gain is not adjusted.
 - **Average:** Before the exposures are overlaid, the gain for each is divided by the total number of exposures (the gain for each exposure is set to $\frac{1}{2}$ for 2 exposures, $\frac{1}{3}$ for 3 exposures, etc).
 - **Lighten:** The camera compares the pixels in each exposure and uses only the brightest.

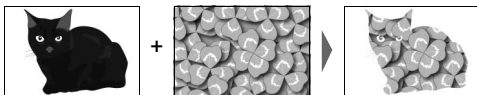

- **Darken:** The camera compares the pixels in each exposure and uses only the darkest.

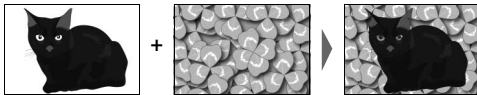

- **Keep all exposures:** Choose **On** to save the individual shots that make up each multiple exposure, **Off** to discard the individual shots and save only the multiple exposure.
- **Overlay shooting:** If **On** is selected, earlier exposures will be superimposed on the view through the lens during shooting.
- **Select first exposure (NEF):** Choose the first exposure from the NEF (RAW) images on the memory card.

Creating a Multiple Exposure



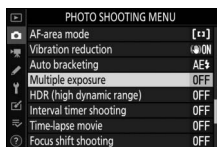

Follow the steps below to shoot a multiple exposure.

1 Select Multiple exposure.

Highlight **Multiple exposure** in the photo shooting menu and press .



2 Select a mode.

Highlight **Multiple exposure mode** and press , then press  or  to choose the desired mode and press  to select.



If **On (series)** or **On (single photo)** is selected, an icon will appear in the display.



3 Choose the number of shots.

Highlight **Number of shots** and press . Press or to choose the number of exposures that will be combined to form a single photograph and press .

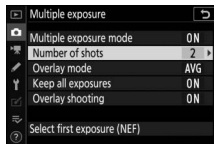

4 Choose the overlay mode.

Highlight **Overlay mode** and press , then press or to choose the desired mode and press to select.

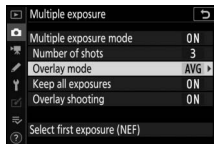

5 Choose whether to keep individual exposures.

To choose whether to keep or delete the individual shots that make up the multiple exposure, highlight **Keep all exposures** and press , then press or to choose the desired option and press to select.



6 Choose whether to view progress in the display.

To choose whether earlier exposures are superimposed over the view through the lens as shooting progresses, highlight **Overlay shooting** and press , then press or to choose the desired option and press to select.

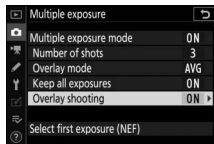

7 Choose the first exposure.

To choose the first exposure from existing photos taken with **Large** selected for **Image size** > **NEF (RAW)** in the photo shooting menu, highlight **Select first exposure (NEF)** and press \odot . Use the multi selector to highlight the desired image and press \odot to select (to view the highlighted image full screen, press and hold the Q button).

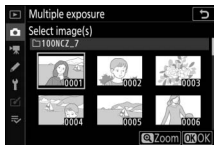

8 Frame a photograph, focus, and shoot.

Continue shooting until all exposures have been taken and the final photograph has been recorded (if you selected an existing NEF (RAW) image as the first exposure in Step 7, shooting will start from the second exposure). If **On (single photo)** was selected in Step 2, multiple exposure shooting will end when the photo is recorded; otherwise, you can continue taking multiple exposures until multiple exposure shooting is turned off.





✔ Release Mode

In continuous release modes, the camera records all exposures in a single burst. If **On (series)** is selected, a new multiple exposure will start as each previous multiple exposure ends; if **On (single photo)** is selected, multiple exposure shooting will end after the first multiple exposure is recorded. In self-timer mode, the camera will automatically record the number of exposures selected in Step 3, regardless of the option selected for Custom Setting c2 (**Self-timer**) > **Number of shots**; the interval between shots is however controlled by Custom Setting c2 (**Self-timer**) > **Interval between shots**. In other release modes, one photograph will be taken each time the shutter-release button is pressed; continue shooting until all exposures have been recorded.

✔ Image Quality

Multiple exposures shot with an NEF (RAW) option selected for image quality will be recorded in JPEG fine★ format.

The **i** Menu

The options listed below can be accessed during multiple exposure shooting by pressing the  button followed by the **i** button. Highlight items and press  to select.

- **View progress:** View a preview created from the exposures recorded to the current point.
- **Retake last exposure:** Retake the most recent exposure.
- **Save and exit:** Create a multiple exposure from the exposures taken to current point.
- **Discard and exit:** Exit without recording a multiple exposure. If **On** is selected for **Keep all exposures**, the individual exposures will be kept.

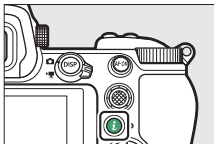

Multiple Exposure

Shooting may also end if camera settings are changed before the exposure is complete. The shooting settings and photo info for multiple exposure photographs are those for the first exposure.



Do not remove or replace the memory card while recording a multiple exposure.

Multiple exposures may be affected by noise (randomly-spaced bright pixels, fog, or lines).

Other Settings

While a multiple exposure is being shot, memory cards cannot be formatted and some menu items are grayed out and cannot be changed.

Ending Multiple Exposures

To end a multiple exposure before the specified number of exposures have been taken, select **Off** for **Multiple exposure mode** or press the  button followed by the  button and select either **Save and exit** or **Discard and exit**. If shooting ends or you select **Save and exit** before the specified number of exposures have been taken, a multiple exposure will be created from the exposures that have been recorded to that point. If **Average** is selected for **Overlay mode**, gain will be adjusted to reflect the number of exposures actually recorded. Note that shooting will end automatically if the standby timer expires.

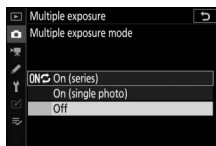

The Standby Timer

Menus and playback can be used between exposures, but note that if no operations are performed for about 40 seconds during playback or 90 seconds while menus are displayed, shooting will end and a multiple exposure will be created from the exposures recorded to that point. The time available to record the next exposure can be extended by choosing longer times for Custom Setting c3 (**Power off delay**) > **Playback** and **Menus**.

HDR (High Dynamic Range)

MENU button → 📷 (photo shooting menu)

Used with high contrast subjects, High Dynamic Range (HDR) preserves details in highlights and shadows by combining two shots taken at different exposures. HDR is most effective when used with matrix metering (with spot or center-weighted metering, an exposure differential of **Auto** is equivalent to about 2 EV). It cannot be combined with some camera features, including NEF (RAW) recording, flash photography, bracketing, multiple exposure, shutter speeds of **Bulb** and **Time**, or interval timer, focus shift, or time-lapse recording.



+



First exposure (darker)

Second exposure
(brighter)

Combined HDR image

The following options are available:

- **HDR mode:** Choose from **On (series)** (take a series of HDR photographs, ending when **Off** is selected), **On (single photo)** (take one HDR photograph), and **Off** (exit without taking additional HDR photographs).
- **Exposure differential:** Choose the difference in exposure between the two shots that are combined to make an HDR photograph. Choose larger values for high-contrast subjects, or select **Auto** to let the camera adjust the exposure differential according to the scene.
- **Smoothing:** Choose how much to smooth the boundaries between the shots that make up each HDR photograph.

- **Save individual images (NEF):** Choose **On** to save each of the individual shots used to create the HDR image. The photos are saved as large-size NEF (RAW) files regardless of the options selected for image quality and size in the photo shooting menu.

3 Choose the exposure differential.

To choose the difference in exposure between the two shots, highlight **Exposure differential** and press .

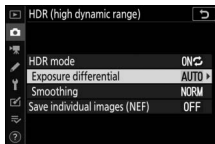

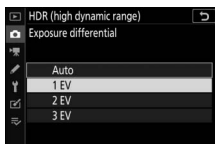

Highlight an option and press . Choose higher values for high-contrast subjects, but note that choosing a value higher than required may not produce the desired results; if **Auto** is selected, the camera will automatically adjust exposure to suit the scene.

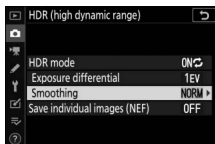

4 Choose the amount of smoothing.

To choose how much the boundaries between the two images are smoothed, highlight **Smoothing** and press .



Highlight an option and press . Higher values produce a smoother composite image. Uneven shading may be visible with some subjects.

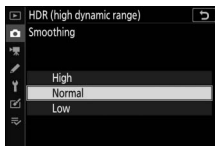

5 Choose whether to keep individual exposures.

To choose whether to save the individual NEF (RAW) images that make up the HDR photograph, highlight **Save individual images (NEF)** and press \odot , then press \uparrow or \downarrow to choose the desired option and press \odot to select.

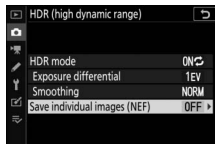

6 Frame a photograph, focus, and shoot.

The camera takes two exposures when the shutter-release button is pressed all the way down. “**Job**” and “**HDR**” will flash in the control panel while the images are combined; no photographs can be taken until recording is complete. Regardless of the option currently selected for release mode, only one photograph will be taken each time the shutter-release button is pressed.

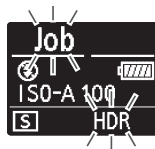

If **On (series)** is selected, HDR will only turn off when **Off** is selected for HDR mode; if **On (single photo)** is selected, HDR turns off automatically after the photograph is taken.

✓ Framing HDR Photographs

The edges of the image will be cropped out. The desired results may not be achieved if the camera or subject moves during shooting. Use of a tripod is recommended. Depending on the scene, shadows may appear around bright objects or halos may appear around dark objects; this effect can be reduced by adjusting the amount of smoothing.

Interval Timer Shooting

MENU button →  (photo shooting menu)

Take photographs at the selected interval until the specified number of shots has been recorded. Select a release mode other than **Self-timer** (☺) when using the interval timer.

Selecting **Interval timer shooting** displays the options below.

- **Start:** Start interval timer shooting, either after 3 s (**Now** selected for **Choose start day/time**) or at a selected date and time (**Choose day/time**). Shooting will continue at the selected interval until all shots have been taken.
- **Choose start day/time:** Choose a start option. To start shooting immediately, select **Now**. To start shooting at a chosen date and time, select **Choose day/time**.
- **Interval:** Choose the interval (hours, minutes, and seconds) between shots.
- **Intervals×shots/interval:** Choose the number of intervals and the number of shots per interval.
- **Exposure smoothing:** Selecting **On** allows the camera to adjust exposure to match previous shot in modes other than **M** (note that exposure smoothing only takes effect in mode **M** if auto ISO sensitivity control is on). Large changes in subject brightness during shooting may result in apparent variations in exposure, in which case it may be necessary to shorten the interval between shots.
- **Silent photography:** Select **On** to silence the shutter during shooting.

- **Interval priority:** Select **On** to ensure that photos shot in modes **P** and **A** are taken at the chosen interval, **Off** to ensure that photos are correctly exposed. If **On** is selected, check that the minimum shutter speed chosen for **ISO sensitivity settings** > **Auto ISO sensitivity control** in the photo shooting menu is faster than the interval and that **Release** is chosen for Custom Setting a1 (**AF-C priority selection**) or Custom Setting a2 (**AF-S priority selection**) according to the focus mode currently selected.
- **Starting storage folder:** Highlight options and press  to select or deselect. Choose **New folder** to create a new folder for each new sequence, **Reset file numbering** to reset file numbering to 0001 when a new folder is created.

Interval Timer Photography

✓ Before Shooting

Before beginning interval timer photography, take a test shot at current settings and view the results. Before choosing a starting time, select **Time zone and date** in the setup menu and make sure that the camera clock is set to the correct time and date. To ensure that shooting is not interrupted, be sure the camera battery is fully charged. If in doubt, charge the battery before use or use an AC adapter and power connector (available separately).

1 Select Interval timer shooting.

Highlight **Interval timer shooting** in the photo shooting menu and press .

Interval timer shooting options will be displayed.

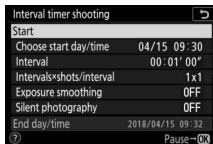
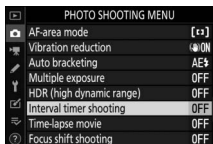

2 Adjust interval timer settings.

Adjust the following settings:

- **Choose start day/time:** Choose the starting date and time.

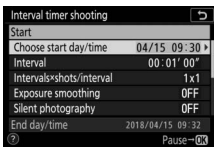

Highlight **Choose start day/time** and press .



Highlight an option and press .

To start shooting immediately, select **Now**. To start shooting at a chosen date and time, select **Choose day/time**, then choose the date and time and press .

- **Interval:** Choose the interval, in hours, minutes, and seconds.

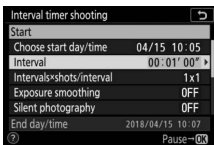

Highlight **Interval** and press .

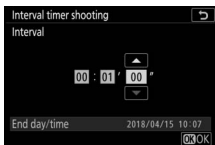

Choose an interval and press .

- **Intervals×shots/interval:** Choose the number of intervals and the number of shots per interval.

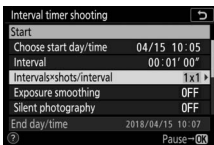

Highlight **Intervals×shots/interval** and press \rightarrow .

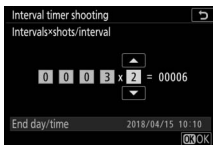

Choose the number of intervals and shots/interval and press \updownarrow .

In single frame release mode, the photographs for each interval will be taken at the rate chosen for Custom Setting d1 (**CL mode shooting speed**). When silent photography is enabled, the number of shots per interval is fixed at one.

- **Exposure smoothing:** Enable or disable exposure smoothing.

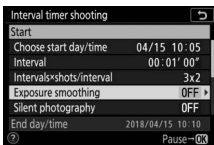

Highlight **Exposure smoothing** and press \rightarrow .

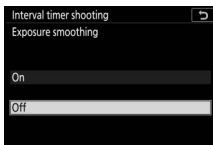

Highlight an option and press \updownarrow .

- **Silent photography:** Enable or disable silent photography.

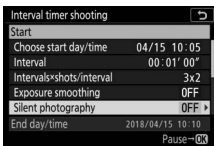

Highlight **Silent photography** and press \rightarrow .

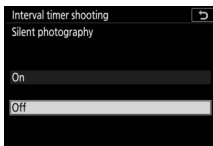

Highlight an option and press \updownarrow .

- **Interval priority:** Enable or disable **Interval priority**.

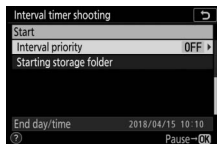

Highlight **Interval priority** and press **↵**.

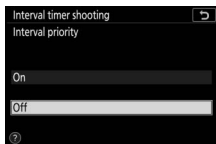

Highlight an option and press **OK**.

- **Starting storage folder:** Choose starting folder options.

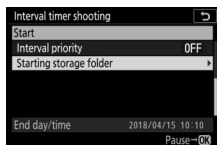

Highlight **Starting storage folder** and press **↵**.

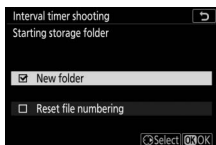

Highlight options and press **↵** to select or deselect; press **OK** to proceed.

3 Start shooting.

Highlight **Start** and press **OK**. The first series of shots will be taken at the specified starting time, or after about 3 s if **Now** was selected for **Choose start day/time** in Step 2. The display turns off during shooting; shooting will continue at the selected interval until all shots have been taken.

✔ During Shooting

During interval timer photography, the memory card access lamp will flash.

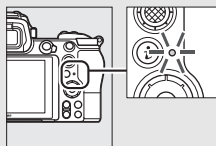

If the display is turned on by pressing the shutter-release button halfway, the message “Interval timer shooting” will be displayed and the  icon will flash.

Settings can be adjusted, the menus used, and pictures played back while interval

timer photography is in progress. The

display will turn off automatically shortly before each interval. Note that changing camera settings while the interval timer is active may cause shooting to end.

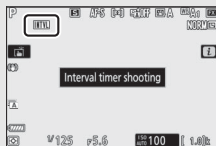

■ Pausing Interval Timer Photography

Interval timer photography can be paused between intervals by pressing **OK** (**Now** selected for **Choose start day/time**) or selecting **Pause** in the interval timer menu (**Choose day/time** selected for **Choose start day/time**).

■ Resuming Interval Timer Photography

To resume shooting immediately, select **Restart**.

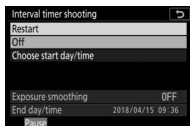

Highlight **Restart** and press **OK**.

To resume shooting at a specified time:

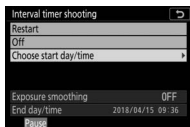

In the interval timer menu, highlight **Choose day/time** and press **OK**.

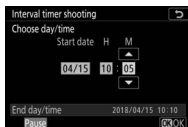

Choose a starting date and time and press **OK**.

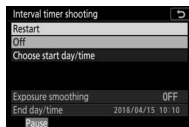

Highlight **Restart** and press **OK**.

■ Ending Interval Timer Shooting

To end interval timer photography before all the photos are taken, select **Off** in the interval timer menu.

■ ■ *No Photograph*

Photographs will not be taken at the selected interval if the current interval ends before the photograph or photographs for the previous interval have been taken, the memory card is full, or **AF-S** is selected and the camera is unable to focus (note that the camera focuses before each shot). If **Off** is selected for **Interval priority** in autofocus mode, shooting will resume with the next interval.

✔ Out of Memory

If the memory card is full, the interval timer will remain active but no pictures will be taken. Resume shooting after deleting some pictures or turning the camera off and inserting another memory card.

✔ Interval Timer Photography

Choose an interval longer than the time needed to take the selected number of shots and, if you are using a flash, the time needed for the flash to charge. If the interval is too short, the number of photos taken may be less than the total listed in Step 2 (the number of intervals multiplied by the number of shots per interval) or the flash may fire at less than the power needed for full exposure. Interval timer photography will not start if the interval is set to **00:00'0.5"** and both **Silent photography** and **Interval priority** are enabled. Interval timer photography cannot be combined with some camera features, including movie recording, time-lapse movies, long time-exposures (bulb or time photography), multiple exposure, HDR (high dynamic range), and focus shift. Note that because the shutter speed, frame rate, and time needed to record images may vary from one interval to the next, the time between the end of one interval and the beginning of the next may vary. If shooting cannot proceed or changes cannot be applied at current settings (for example, if a shutter speed of **Bulb** or **Time** is currently selected in mode **M**, the interval is zero, or the start time is in less than a minute), a warning will be displayed.

Interval timer shooting will pause when **Self-timer** (☺) is selected for release mode or if the camera is turned off and then on again (when the camera is off, batteries and memory cards can be replaced without ending interval timer photography). Pausing shooting does not affect interval timer settings.

✔ Release Mode

Regardless of the release mode selected, the camera will take the specified number of shots at each interval.

✔ Bracketing

Adjust bracketing settings before starting interval timer photography. If exposure, flash, or ADL bracketing is active while interval timer photography is in effect, the camera will take the number of shots in the bracketing program at each interval, regardless of the number of shots specified in the interval timer menu. If white balance bracketing is active while interval timer photography is in effect, the camera will take one shot at each interval and process it to create the number of copies specified in the bracketing program. Note that bracketing cannot be used during interval timer photography when **On** is selected for **Interval priority**.

✔ Silent Photography

Selecting **On** for **Silent photography** disables some camera features, including:

- ISO sensitivities of Hi 0.3 through Hi 2
- Flash photography
- Long exposure noise reduction
- Flicker reduction

Time-Lapse Movie

MENU button →  (photo shooting menu)

The camera automatically takes photos at selected intervals to create a silent time-lapse movie.



Selecting **Time-lapse movie** displays the options below.

- **Start:** Start time-lapse recording. Shooting starts after about 3 s and continues at the selected interval for the selected shooting time.
- **Interval:** Choose the interval between shots in minutes and seconds.
- **Shooting time:** Choose how long the camera will continue to take pictures (hours and minutes).
- **Exposure smoothing:** Selecting **On** smooths abrupt changes in exposure in modes other than **M** (note that exposure smoothing only takes effect in mode **M** if auto ISO sensitivity control is on). Large changes in subject brightness during shooting may result in apparent variations in exposure, in which case it may be necessary to shorten the interval between shots.
- **Silent photography:** Select **On** to silence the shutter during shooting.
- **Choose image area:** Choose an image area (FX or DX).
- **Frame size/frame rate:** Choose the frame size and rate for the final movie.

- **Interval priority:** Select **On** to ensure that frames shot in modes **P** and **A** are taken at the chosen interval, **Off** to ensure that photos are correctly exposed. If **On** is selected, check that the minimum shutter speed chosen for **ISO sensitivity settings** > **Auto ISO sensitivity control** in the photo shooting menu is faster than the interval and that **Release** is chosen for Custom Setting a1 (**AF-C priority selection**) or Custom Setting a2 (**AF-S priority selection**) according to the focus mode currently selected.

Recording Time-Lapse Movies

✔ Before Shooting

Before shooting a time-lapse movie, select **Time zone and date** in the setup menu and make sure that the camera clock is set to the correct time and date, and then take a test shot at current settings and view the results. Time-lapse movies are shot using the movie crop; to check the composition, press the  button in the **Time-lapse movie** display (to return to the **Time-lapse movie** display, press the  button). For consistent coloration, choose a white balance setting other than **WB A** (auto) or  **A** (natural light auto).

To ensure that shooting is not interrupted, be sure the camera battery is fully charged. If in doubt, charge the battery before use or use an AC adapter and power connector (available separately).

1 Select Time-lapse movie.

Highlight **Time-lapse movie** in the photo shooting menu and press .

Time-lapse movie options will be displayed.

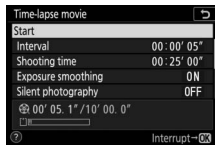
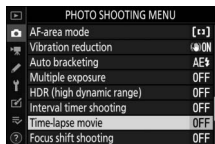

2 Adjust time-lapse movie settings.

Adjust the following settings:

- **Interval:** The interval (in minutes and seconds) should be longer than the slowest anticipated shutter speed.

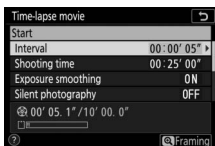

Highlight **Interval** and press

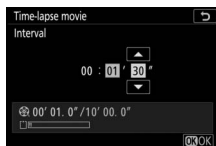

Choose an interval and press

- **Shooting time:** The total shooting time (in hours and minutes) can be up to 7 hours and 59 minutes.

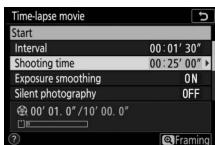

Highlight **Shooting time** and press

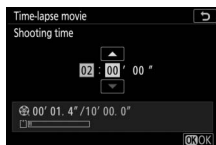

Choose a shooting time and press

- **Exposure smoothing:** Enable or disable exposure smoothing.

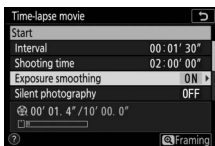

Highlight **Exposure smoothing** and press

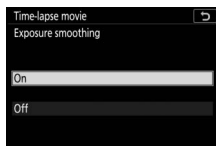

Highlight an option and press

- **Silent photography:** Enable or disable silent photography.

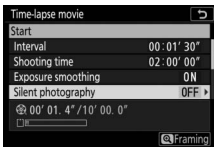

Highlight **Silent photography** and press

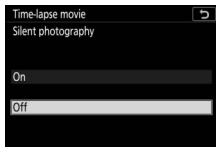

Highlight an option and press

- **Choose image area:** Choose an image area for time-lapse recording.

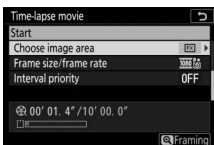

Highlight **Choose image area** and press

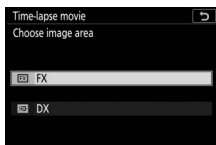

Highlight an option and press

- **Frame size/frame rate:** Choose the frame size and rate at which the final movie will play back.

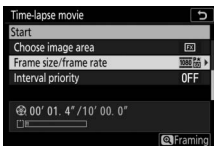

Highlight **Frame size/frame rate** and press



Highlight an option and press

- **Interval priority:** Enable or disable **Interval priority**.

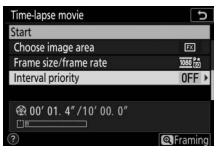

Highlight **Interval priority** and press **OK**.

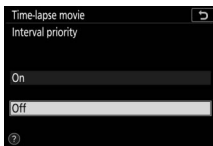

Highlight an option and press **OK**.

3 Start shooting.

Highlight **Start** and press **OK**.

Shooting starts after about 3 s. The display turns off and the camera takes photographs at the selected interval for the selected shooting time.

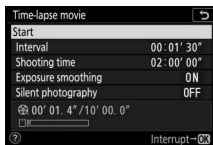

✓ During Shooting

During shooting, the time-lapse recording indicator will be displayed in the control panel and the memory card access lamp will light. Regardless of the option selected for Custom Setting c3 (**Power off delay**, □ 262) > **Standby timer**, the standby timer will not expire during shooting.

To end shooting (□ 231) or view such settings as exposure smoothing, the interval, and the time remaining, press the **MENU** button between shots (the time-lapse movie dialog may not be displayed if the interval is very short). Note that you cannot adjust settings, play pictures back, or use the menus while shooting is in progress.

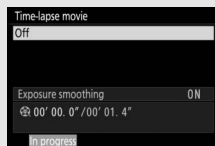
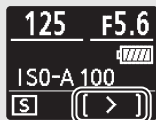

Ending Shooting

To end shooting before all the photos are taken, highlight **Off** in the time-lapse movie menu and press \odot (note that this may not end shooting if the value selected for **Interval** is very short, in which case shooting can be ended by turning the camera off). A movie will be created from the frames shot to that point. Note that if the power source is removed or disconnected or the memory card is ejected, shooting ends (but no beep will sound) and no movie will be recorded.

No Photograph

The camera focuses before each shot. If the currently-selected focus mode is **AF-S** and **Off** is selected for **Interval priority**, the camera will skip to the next interval when unable to focus.

Calculating the Length of the Final Movie

The total number of frames in the final movie can be calculated by dividing the shooting time by the interval, rounding up, and adding 1. The length of the final movie can then be calculated by dividing the number of shots by the frame rate selected for **Frame size/frame rate**. A 48-frame movie recorded at $1920 \times 1080; 24p$, for example, will be about two seconds long. The maximum length for time-lapse movies is 20 minutes.

Frame size/frame rate

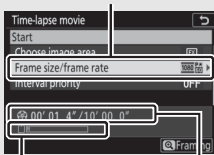

Memory card indicator

Length recorded/
maximum length

✔ Time-Lapse Movies

Time-lapse cannot be combined with some camera features, including movie recording, long time-exposures (bulb or time photography), the self-timer, bracketing, HDR (high dynamic range), multiple exposure, interval timer photography, and focus shift. Active D-Lighting is disabled automatically. Note that because shutter speed and the time needed to record the image to the memory card may vary from shot to shot, the interval between a shot being recorded and the start of the next shot may vary. Changes to settings will not be applied and shooting will not begin if a time-lapse movie cannot be recorded at current settings (for example, if the memory card is full, the interval or shooting time is zero, or the interval is longer than the shooting time).

Shooting may end if camera controls are used or settings are changed or HDMI cable is connected. A movie will be created from the frames shot to the point where shooting ended.

✔ Image Review

The  button cannot be used to view pictures while shooting is in progress, but the current frame will be displayed for a few seconds after each shot if **On** or **On (monitor only)** is selected for **Image review** in the playback menu (the frame may not be displayed if the interval is very short). Other playback operations cannot be performed while the frame is displayed.

✔ Silent Photography

Selecting **On** for **Silent photography** disables some camera features, including:

- ISO sensitivities of Hi 0.3 through Hi 2
- Flash photography
- Long exposure noise reduction
- Flicker reduction

Focus Shift Shooting

MENU button →  (photo shooting menu)

Focus shift, which automatically varies focus over a series of shots, is used to take photos that will later be combined using focus stacking to create a single image with increased depth of field. Before using focus shift, choose a focus mode of **AF-S** or **AF-C** and a release mode other than **Self-timer** (☺).

Selecting **Focus shift shooting** displays the options below.

- **Start:** Start shooting. The camera will change the focus distance by the selected amount with each shot.
- **No. of shots:** Choose the number of shots (maximum 300).
- **Focus step width:** Choose the amount the focus distance changes with each shot.
- **Interval until next shot:** The time between shots, in seconds. Select 00 to take photos at up to about 5.5 fps.
- **First-frame exposure lock:** If **On** is selected, the camera will lock exposure for all images at the setting for the first frame.
- **Peaking stack image:** If **Create** is selected, the camera will employ focus peaking to create a black-and-white preview stack that can be used to check focus after shooting.
- **Silent photography:** Select **On** to silence the shutter during shooting.
- **Starting storage folder:** Highlight options and press  to select or deselect. Choose **New folder** to create a new folder for each new sequence, **Reset file numbering** to reset file numbering to 0001 when a new folder is created.

Focus Shift Photography

✓ Before Shooting

Before beginning focus shift photography, take a test shot at current settings and view the results. To ensure that shooting is not interrupted, be sure the camera battery is fully charged. If in doubt, charge the battery before use or use an AC adapter and power connector (available separately).

1 Select Focus shift shooting.

Highlight **Focus shift shooting** in the photo shooting menu and press .

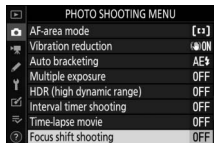

Focus shift options will be displayed.

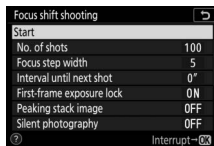

2 Adjust focus shift settings.

Adjust the following settings:

- **No. of shots:** Choose the number of shots.



Highlight **No. of shots** and press .

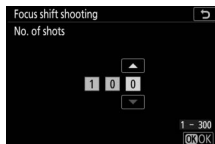





Choose the number of shots and press .

- **Focus step width:** Choose the amount the focus distance changes with each shot.

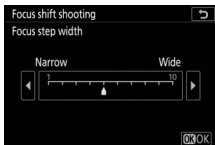

Highlight **Focus step width** and press .



Press  to reduce the focus step width,  to increase. Press  to proceed.

Because depth of field is reduced at short focus distances, we recommend choosing smaller focus steps and increasing the number of shots when photographing subjects close to the camera.

- **Interval until next shot:** Choose the interval between shots.



Highlight **Interval until next shot** and press .

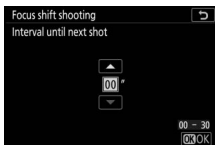

Choose the interval (in seconds) and press .

To ensure the correct exposure when using a flash, choose an interval long enough for the flash to charge.

- **First-frame exposure lock:** Enable or disable exposure lock.



Highlight **First-frame exposure lock** and press .

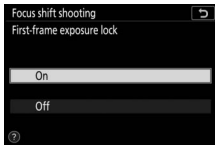

Highlight an option and press .

- **Peaking stack image:** Enable or disable **Peaking stack image**.

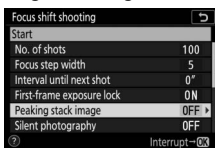

Highlight **Peaking stack image** and press .

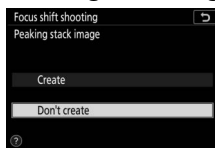

Highlight an option and press .

- **Silent photography:** Enable or disable silent photography.



Highlight **Silent photography** and press .

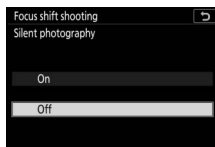

Highlight an option and press .

- **Starting storage folder:** Choose starting folder options.

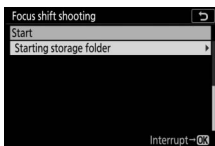

Highlight **Starting storage folder** and press .

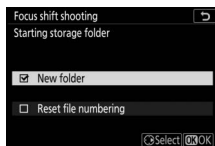

Highlight options and press to select or deselect. Press to proceed.

3 Start shooting.

Highlight **Start** and press **OK**.

Shooting starts after about 3 s. The display turns off and the camera takes photographs at the selected interval, starting at the focus distance selected at the start of shooting and progressing out toward infinity by the selected focus step distance with each shot. Shooting ends when the selected number of shots has been taken or focus reaches infinity. To end shooting before all shots have been taken, press the shutter-release button halfway or press the **OK** button between shots.



✓ Aperture

To prevent the loss of definition that can occur at smaller apertures, choose an aperture with an f-number lower than $f/11$ – $f/8$.

✓ During Shooting

During focus shift photography, the release mode indicator in the control panel will turn off and the memory card access lamp will flash. Regardless of the option selected for Custom Setting c3 (**Power off delay**) > **Standby timer**, the standby timer will not expire during shooting. Note that changing camera settings while focus shift photography is in progress may cause shooting to end. Shooting will end if focus is adjusted during shooting.

✓ Peaking Stack Image

During playback, a  icon appears on photographs shot with **Create** selected for **Peaking stack image**, indicating that a focus stack preview can be displayed by pressing the **i** button and selecting **Display peaking stack image**. The areas displayed in white will be in focus when the pictures are stacked. Focus stack previews can only be viewed on the camera used to create them.

✔ Focus Shift Photography

If you are using a flash, choose an interval longer than the time needed for the flash to charge. If the interval is too short, the flash may fire at less than the power needed for full exposure. Focus shift cannot be combined with some camera features, including movie recording, time-lapse movies, bracketing, the self-timer, long time-exposures (bulb or time photography), HDR (high dynamic range), multiple exposure, and interval timer photography. Note that because the shutter speed and time needed to record images may vary from one shot to the next, the time between the end of one interval and the beginning of the next may vary. If shooting cannot proceed at current settings (for example, if shutter speed is set to **Bulb** or **Time**), a warning will be displayed.

✔ Silent Photography

Selecting **On** for **Silent photography** disables some camera features, including:

- ISO sensitivities of Hi 0.3 through Hi 2
- Flash photography
- Exposure delay mode
- Flicker reduction

Silent Photography

MENU button →  (photo shooting menu)

Select **On** to reduce vibrations caused by the shutter when shooting landscapes and other static subjects (□ 68). Use of a tripod is recommended. Pictures are taken using the electronic shutter, regardless of the option selected for Custom Setting d5 (**Shutter type**). Regardless of the option selected for **Beep options** in the setup menu, a beep will not sound when the camera focuses or the self-timer is counting down, and both the flash and long-exposure noise reduction will be disabled. In continuous release modes, the frame advance rate will change (□ 87).

🎬 The Movie Shooting Menu: *Movie Shooting Options*

To view the movie shooting menu, select the 🎬 tab in the camera menus.

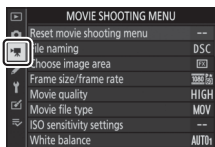

Option	
Reset movie shooting menu	241
File naming	241
Choose image area	241
Frame size/frame rate	241
Movie quality	241
Movie file type	241
ISO sensitivity settings	242
White balance	242
Set Picture Control	243
Manage Picture Control	243
Active D-Lighting	243
High ISO NR	243
Vignette control	244
Diffraction compensation	244

Option	
Auto distortion control	244
Flicker reduction	244
Metering	245
Focus mode	245
AF-area mode	245
Vibration reduction	245
Electronic VR	245
Microphone sensitivity	246
Attenuator	246
Frequency response	247
Wind noise reduction	247
Headphone volume	247
Timecode	248

✔ See Also

For menu defaults, see “Movie Shooting Menu Defaults” (📖 148).

Reset Movie Shooting Menu

MENU button →  (movie shooting menu)

Select **Yes** to restore movie shooting menu options to their default values (📖 148).

File Naming

MENU button →  (movie shooting menu)

Choose the three-letter prefix used in naming the image files in which movies are stored. The default prefix is “DSC” (📖 167).

Choose Image Area

MENU button →  (movie shooting menu)

Choose a movie crop (image area) from FX or DX.

Frame Size/Frame Rate

MENU button →  (movie shooting menu)

Choose the movie frame size (in pixels) and frame rate. For more information, see “Frame Size, Frame Rate, and Movie Quality” (📖 118).

Movie Quality

MENU button →  (movie shooting menu)

Choose from **High quality** and **Normal**.

Movie File Type

MENU button →  (movie shooting menu)

Record movies in MOV or MP4 format.

ISO Sensitivity Settings

MENU button →  (movie shooting menu)

Adjust the following ISO sensitivity settings.

- **Maximum sensitivity:** Choose the upper limit for auto ISO sensitivity control from values between ISO 200 and Hi 2. Auto ISO sensitivity control is used in modes **P**, **S**, and **A** and when **On** is selected for **Auto ISO control (mode M)** in mode **M**.
- **Auto ISO control (mode M):** Select **On** to enable auto ISO sensitivity control in mode **M**, **Off** to use the value selected for **ISO sensitivity (mode M)**.
- **ISO sensitivity (mode M):** Choose the ISO sensitivity for mode **M** from values between ISO 64 (Z 7) or 100 (Z 6) and Hi 2. Auto ISO sensitivity control is used in other modes.

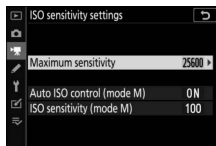

Auto ISO Sensitivity Control

At high ISO sensitivities, the camera may have difficulty focusing and noise (randomly-spaced bright pixels, fog, or lines) may increase. This can be prevented by choosing a lower value for **ISO sensitivity settings > Maximum sensitivity**.

White Balance

MENU button →  (movie shooting menu)

Choose the white balance for movies (📖 64). Select **Same as photo settings** to use the option currently selected for photos.

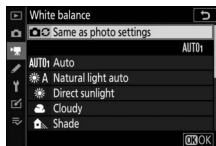

Set Picture Control

MENU button →  (movie shooting menu)

Choose a Picture Control for movies (📖 96). Select **Same as photo settings** to use the option currently selected for photos.

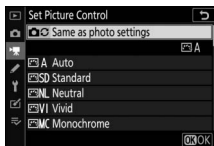

Manage Picture Control

MENU button →  (movie shooting menu)

Create custom Picture Controls (📖 181).

Active D-Lighting

MENU button →  (movie shooting menu)

Preserve details in highlights and shadows, creating movies with natural contrast. Select **Same as photo settings** to use the option currently selected for photos (📖 112, 122).

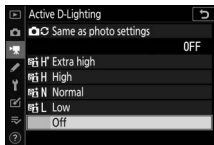

High ISO NR

MENU button →  (movie shooting menu)

Reduce “noise” (randomly-spaced bright pixels) in movies recorded at high ISO sensitivities (📖 185).

Vignette Control

MENU button →  (movie shooting menu)

Reduce vignetting in movies (📖 186). Select **Same as photo settings** to use the option currently selected for photos.

Diffraction Compensation

MENU button →  (movie shooting menu)

Reduce diffraction in movies (📖 186).

Auto Distortion Control

MENU button →  (movie shooting menu)

Reduce barrel and pin-cushion distortion in movies (📖 186).

Flicker Reduction

MENU button →  (movie shooting menu)

Reduce flicker and banding when shooting movies under fluorescent or mercury-vapor lighting. Choose **Auto** to allow the camera to automatically choose the correct frequency, or manually match the frequency to that of the local AC power supply.

“Flicker Reduction” in the Movie Shooting Menu

If **Auto** fails to produce the desired results and you are unsure as to the frequency of the local power supply, test both the 50 and 60 Hz options and choose the one that produces the best results. Flicker reduction may not produce the desired results if the subject is very bright, in which case you should try choosing a smaller aperture (higher f-number). To prevent flicker, select mode **M** and choose a shutter speed adapted to the frequency of the local power supply: $\frac{1}{125}$ s, $\frac{1}{60}$ s, or $\frac{1}{30}$ s for 60 Hz; $\frac{1}{100}$ s, $\frac{1}{50}$ s, or $\frac{1}{25}$ s for 50 Hz.

Metering

MENU button →  (movie shooting menu)

Choose how the camera meters exposure in movie mode (📖 110). Spot metering is not available.

Focus Mode

MENU button →  (movie shooting menu)

Choose a focus mode for movie recording (📖 52).

AF-Area Mode

MENU button →  (movie shooting menu)

Choose how the camera focuses in movie mode (📖 54).

Vibration Reduction

MENU button →  (movie shooting menu)

Choose a vibration reduction option for movie recording (📖 114). Select **Same as photo settings** to use the option currently selected for photos.

Electronic VR

MENU button →  (movie shooting menu)

Choose whether to enable electronic vibration reduction in movie mode.

Microphone Sensitivity

MENU button →  (movie shooting menu)

Turn built-in or external microphones on or off or adjust microphone sensitivity. Choose **Auto** to adjust sensitivity automatically or **Microphone off** to turn sound recording off; to select microphone sensitivity manually, select **Manual** and choose a sensitivity.

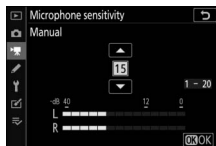

The Icon

Movies that were recorded without sound are indicated by a  icon in movie and full-frame playback.





Attenuator

MENU button →  (movie shooting menu)

Select **Enable** to reduce microphone gain and prevent audio distortion when recording movies in loud environments.

Frequency Response

MENU button →  (movie shooting menu)

If  **Wide range** is selected, built-in and external microphones will respond to a wide range of frequencies, from music to the bustling hum of a city street. Choose  **Vocal range** to bring out human voices.



Wind Noise Reduction

MENU button →  (movie shooting menu)

Select **On** to enable the low-cut filter for the built-in microphone (optional stereo microphones are unaffected), reducing noise produced by wind blowing over the microphone (note that other sounds may also be affected). Wind-noise reduction for optional stereo microphones that support this feature can be enabled or disabled using microphone controls.

Headphone Volume

MENU button →  (movie shooting menu)

Press  or  to adjust headphone volume.

Timecode

MENU button →  (movie shooting menu)

Choose whether to record time codes giving the hour, minute, second, and frame number for each frame when shooting movies. Time codes are available only with movies recorded in MOV format. Before proceeding, select **Time zone and date** in the setup menu and confirm that the clock is set correctly.

Option	Description
Record timecodes	<ul style="list-style-type: none">• On: Time codes are recorded and appear in the display.• On (with HDMI output): Time codes will be included with footage saved to Atomos SHOGUN, NINJA, or SUMO-series Monitor recorders connected via an HDMI cable.• Off: Time codes are not recorded.
Count-up method	<ul style="list-style-type: none">• Record run: Time codes are incremented only while recording is in progress.• Free run: Time codes are incremented continuously, including while the camera is off.
Timecode origin	<ul style="list-style-type: none">• Reset: Reset the time code to 00:00:00.00.• Enter manually: Enter the hour, minute, second, and frame number manually.• Current time: Set the time code to the current time as provided by the camera clock.
Drop frame	Select On to compensate for discrepancies between the frame count and the actual recording time at frame rates of 30 and 60 fps.

HDMI Devices

Selecting **On (with HDMI output)** for **Record timecodes** may disrupt footage output to HDMI devices.

Custom Settings: Fine-Tuning Camera Settings

To view Custom Settings, select the  tab in the camera menus.

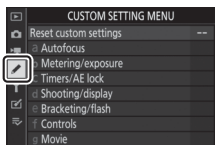

Custom Settings are used to customize camera settings to suit individual preferences.

Custom Setting groups

Main menu

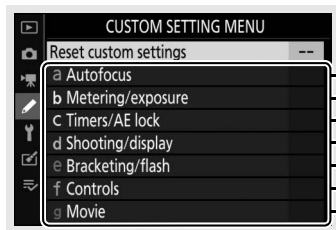

The following Custom Settings are available:

Custom Setting ¹		
Reset custom settings		252
a Autofocus		
a1	AF-C priority selection	253
a2	AF-S priority selection	253
a3	Focus tracking with lock-on	254
a4	Auto-area AF face/eye detection	254
a5	Focus points used	255
a6	Store points by orientation	255
a7	AF activation	256
a8	Limit AF-area mode selection	257
a9	Focus point wrap-around	257
a10	Focus point options	257
a11	Low-light AF	258
a12	Built-in AF-assist illuminator	258
a13	Manual focus ring in AF mode ²	259
b Metering/exposure		
b1	EV steps for exposure cntrl	259
b2	Easy exposure compensation	260
b3	Center-weighted area	260
b4	Fine-tune optimal exposure	261
c Timers/AE lock		
c1	Shutter-release button AE-L	261
c2	Self-timer	262
c3	Power off delay	262



d Shooting/display		
d1	CL mode shooting speed	263
d2	Max. continuous release	263
d3	Sync. release mode options	263
d4	Exposure delay mode	263
d5	Shutter type	264
d6	Limit selectable image area	264
d7	File number sequence	265
d8	Apply settings to live view	266
d9	Framing grid display	266
d10	Peaking highlights	266
d11	View all in continuous mode	266
e Bracketing/flash		
e1	Flash sync speed	267
e2	Flash shutter speed	268
e3	Exposure comp. for flash	268
e4	Auto ISO sensitivity control	268
e5	Modeling flash	269
e6	Auto bracketing (mode M)	269
e7	Bracketing order	270
f Controls		
f1	Customize menu	271
f2	Custom control assignment	273
f3	OK button	281
f4	Shutter spd & aperture lock	283
f5	Customize command dials	283
f6	Release button to use dial	285
f7	Reverse indicators	285

Custom Setting¹



g	Movie	
g1	Customize menu	286
g2	Custom control assignment	287
g3	OK button	292
g4	AF speed	292
g5	AF tracking sensitivity	293
g6	Highlight display	294

1 Items modified from default values are indicated by asterisks (“*”).

2 Available with compatible lenses only.

See Also

For menu defaults, see “Custom Settings Menu Defaults” (📖 150).

Reset Custom Settings

MENU button → (Custom Settings menu)



Select **Yes** to restore Custom Settings to their default values (📖 150).

a: Autofocus

a1: AF-C Priority Selection

MENU button →  (Custom Settings menu)

Choose whether photos can be taken before the camera focuses in focus mode **AF-C**.



Option	Description
 Release	Photos can be taken whenever the shutter-release button is pressed (<i>release priority</i>).
 Focus	Photos can be taken only when the camera is in focus (<i>focus priority</i>).

Regardless of the option selected, focus will not lock when **AF-C** is selected for focus mode. The camera will continue to adjust focus until the shutter is released.

a2: AF-S Priority Selection

MENU button →  (Custom Settings menu)

Choose whether photos can be taken before the camera focuses in focus mode **AF-S**.

Option	Description
 Release	Photos can be taken whenever the shutter-release button is pressed (<i>release priority</i>).
 Focus	Photos can be taken only when the camera is in focus (<i>focus priority</i>).

Regardless of the option selected, if focus point is displayed in green when **AF-S** is selected for autofocus mode, focus will lock while the shutter-release button is pressed halfway. Focus lock continues until the shutter is released.

a3: Focus Tracking with Lock-On

MENU button →  (Custom Settings menu)

Choose how quickly focus responds when something passes between the subject and the camera in focus mode **AF-C**. Choose from values between **5 (Delayed)** and **1 (Quick)**. The higher the value, the slower the response and the less likely you are to lose focus on your original subject. The lower the value, the quicker the response and the easier it is to shift focus to objects crossing your field of view. Note that **2** and **1 (Quick)** are equivalent to **3** when auto-area AF is selected for AF-area mode.

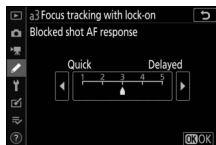

a4: Auto-Area AF Face/Eye Detection

MENU button →  (Custom Settings menu)

Choose whether the camera detects human portrait subjects or dogs and cats and focuses on their faces or on their faces and eyes when auto-area AF is selected for AF-area mode.

Option	Description
Face and eye detection on	When the camera detects a human portrait subject, it automatically focuses on one or the other of the subject's eyes, or on the subject's face if the eyes are not detected.
Face detection on	When the camera detects a portrait subject, it automatically focuses on the subject's face.
Animal detection	When the camera detects a dog or cat, it automatically focuses on one or the other of the subject's eyes, or on the subject's face if the eyes are not detected.
Off	Face and eye detection disabled.

a5: Focus Points Used

MENU button →  (Custom Settings menu)

Choose the number of focus points available for manual focus-point selection.

Option	Description
ALL All points	Every focus point available in the current AF-area mode can be selected.
1/2 Every other point	The number of available focus points is reduced by three quarters (the number of focus points available in Wide-area AF (L) mode does not change). Use for quick focus-point selection.

a6: Store Points by Orientation

MENU button →  (Custom Settings menu)

Choose whether separate focus points can be selected for “wide” (landscape) orientation, for “tall” (portrait) orientation with the camera rotated 90° clockwise, and for “tall” orientation with the camera rotated 90° counterclockwise.

Select **No** to use the same focus point regardless of camera orientation.

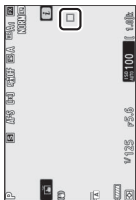

Camera rotated
90° counter-clockwise



Landscape (wide)
orientation



Camera rotated
90° clockwise

Select **Yes** to enable separate focus-point selection.

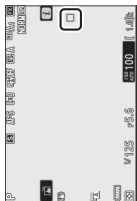

Camera rotated
90° counter-clockwise



Landscape (wide)
orientation



Camera rotated
90° clockwise

a7: AF Activation

MENU button →  (Custom Settings menu)

Choose whether the shutter-release button can be used to focus (**Shutter/AF-ON**) or if focus can only be adjusted using the **AF-ON** button or other controls to which **AF-ON** has been assigned (**AF-ON only**).



Out-of-Focus Release

To choose whether the shutter can be released even in circumstances in which it would normally be disabled, select Custom Setting a7 (**AF activation**), highlight **AF-ON only**, and press . Selecting **Enable** allows the shutter to be released at any time.

Option	Description
Enable	Shutter-release enabled.
Disable	Shutter-release disabled.

a8: Limit AF-Area Mode Selection

MENU button →  (Custom Settings menu)

Choose the options that can be selected by rotating the sub-command dial when AF-area mode is assigned to the **i** menu or a camera control. Highlight the desired modes and press  to select or deselect. Press  to save changes when settings are complete.

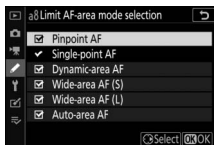

a9: Focus Point Wrap-Around

MENU button →  (Custom Settings menu)

Choose whether focus-point selection “wraps around” from one edge of the display to another. If **Wrap** is selected, focus-point selection will “wrap around” from top to bottom, bottom to top, right to left, and left to right, so that, for example, pressing the sub-selector right when a focus point at the right edge of the display is highlighted selects the corresponding focus point at the left edge of the display.

a10: Focus Point Options

MENU button →  (Custom Settings menu)

Choose from the following focus point display options:

- **Manual focus mode:** Choose **On** to display the active focus point in manual focus mode, **Off** to display the focus point only during focus point selection.
- **Dynamic-area AF assist:** If **On** is selected, both the selected focus point and the surrounding focus points will be displayed in dynamic-area AF mode. Choose **Off** to display only the selected focus point.

a11: Low-Light AF

MENU button →  (Custom Settings menu)

Choose **On** for more accurate focus under low-light conditions when **AF-S** is selected for focus mode, but note that camera may require more time to focus. This option takes effect only in photo mode when a setting other than **AUTO**  is chosen with the mode dial. While low-light AF is in effect, “Low-light” will appear in the display and the display refresh rate may drop.

a12: Built-in AF-Assist Illuminator

MENU button →  (Custom Settings menu)

Choose whether the built-in AF-assist illuminator lights to assist the focus operation in photo mode when lighting is poor.

Option	Description
On	The illuminator lights as required (AF-S focus mode only).
Off	The illuminator does not light to assist the focus operation. The camera may not be able to focus when lighting is poor.

The AF-Assist Illuminator

The AF-assist illuminator has a range of about 1–3 m (3 ft 4 in.–9 ft 10 in.); when using the illuminator, remove the lens hood. Do not obstruct the AF-assist illuminator while it is lit.



a13: Manual Focus Ring in AF Mode

MENU button →  (Custom Settings menu)

Choose whether the lens focus ring can be used for manual focus in autofocus mode. Choose from the options below.

- **Enable:** Autofocus can be over-ridden by rotating the lens focus ring while the shutter-release button is pressed halfway (autofocus with manual override). To refocus using autofocus, lift your finger from the shutter-release button and then press it halfway again.
- **Disable:** The lens focus ring cannot be used for manual focus while autofocus mode is selected.

b: Metering/Exposure

b1: EV Steps for Exposure Cntrl



MENU button →  (Custom Settings menu)

Select the increments used for adjustments to shutter speed, aperture, ISO sensitivity, bracketing, and exposure and flash compensation.

b2: Easy Exposure Compensation

MENU button →  (Custom Settings menu)

Choose whether the  button is needed for exposure compensation.

- **On (auto reset):** In modes **P**, **S**, and **A**, exposure compensation can be set by rotating the command dial not currently used for shutter speed or aperture (easy exposure compensation is not available in mode **M**). The setting selected using the command dial is reset when the camera turns off or the standby timer expires (exposure compensation settings selected using the  button are not reset).
- **On:** As above, except that the exposure compensation value selected using the command dial is not reset when the camera turns off or the standby timer expires.
- **Off:** Exposure compensation is set by pressing the  button and rotating the main command dial.

b3: Center-Weighted Area

MENU button →  (Custom Settings menu)

Choose the size of the area given the most weight in center-weighted metering.

b4: Fine-Tune Optimal Exposure

MENU button →  (Custom Settings menu)

Use this option to fine-tune the exposure value selected by the camera. Exposure can be fine-tuned separately for each metering method by from +1 to -1 EV in steps of $\frac{1}{6}$ EV.

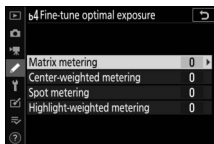

Fine-Tuning Exposure



The exposure compensation () icon is not displayed when exposure fine-tuning is in effect. The only way to determine how much exposure has been altered is to view the amount in the fine-tuning menu.

c: Timers/AE Lock

c1: Shutter-Release Button AE-L

MENU button →  (Custom Settings menu)



Choose whether exposure locks when the shutter-release button is pressed.

Option	Description
 ON On (half press)	Pressing the shutter-release button halfway locks exposure.
 ON On (burst mode)	Exposure only locks while the shutter-release button is pressed all the way down.
Off	Pressing the shutter-release button does not lock exposure.

c2: Self-Timer

MENU button →  (Custom Settings menu)

Choose the length of the shutter release delay, the number of shots taken, and the interval between shots in self-timer mode.

- **Self-timer delay:** Choose the length of the shutter-release delay.
- **Number of shots:** Press  and  to choose the number of shots taken each time the shutter-release button is pressed.
- **Interval between shots:** Choose the interval between shots when **Number of shots** is more than 1.

c3: Power Off Delay

MENU button →  (Custom Settings menu)

Choose how long the control panel and camera displays remain on when no operations are performed. Different settings can be chosen for **Playback**, **Menus**, **Image review**, and **Standby timer**, the last of which determines how long both the monitor or viewfinder display and the control panel remain on when no operations are performed during shooting (the monitor and viewfinder dim a few seconds before the standby timer expires). Choose shorter power-off delays for longer battery life.

d: Shooting/Display

d1: CL Mode Shooting Speed

MENU button →  (Custom Settings menu)

Choose the frame advance rate for low-speed continuous release mode.

d2: Max. Continuous Release

MENU button →  (Custom Settings menu)

The maximum number of shots that can be taken in a single burst in continuous release modes can be set to any value between 1 and 200. Note that regardless of the option selected, there is no limit to the number of photos that can be taken in a single burst when a shutter speed of 1 s or slower is selected in mode **S** or **M**.

The Memory Buffer

Regardless of the option selected for Custom Setting d2, shooting will slow when the memory buffer fills (**r00**).

d3: Sync. Release Mode Options

MENU button →  (Custom Settings menu)

Choose whether the shutters on the remote cameras are synchronized with the shutter on the master camera when using an optional wireless remote controller.

d4: Exposure Delay Mode



MENU button →  (Custom Settings menu)

In situations where the slightest camera movement can blur pictures, shutter release can be delayed by from about 0.2 to 3 seconds after the shutter-release button is pressed.

d5: Shutter Type

MENU button →  (Custom Settings menu)

Choose the type of shutter used for photographs.

Option	Description
 Auto	The camera chooses the shutter type automatically according to shutter speed. The electronic front-curtain shutter is used to reduce blur caused by camera shake at slow shutter speeds.
 Mechanical shutter	The camera uses the mechanical shutter for all photos.
 Electronic front-curtain shutter	The camera uses the electronic front-curtain shutter for all photos.

"Mechanical Shutter"

Mechanical shutter is not available with some lenses.

"Electronic Front-Curtain Shutter"

The fastest shutter speed available when **Electronic front-curtain shutter** is selected is $1/2000$ s.

d6: Limit Selectable Image Area

MENU button →  (Custom Settings menu)

Choose the options available when image-area selection is assigned to the **i** menu or to the command dials and a camera control. Highlight the desired options and press  to select or deselect. Press **OK** to save changes when settings are complete.



d7: File Number Sequence

MENU button →  (Custom Settings menu)

When a picture is taken, the camera names the file by adding one to the last file number used. This option controls whether file numbering continues from the last number used when a new folder is created, the memory card is formatted, or a new memory card is inserted in the camera.

Option	Description
On	File numbering continues from the last number used. This simplifies file management by minimizing the occurrence of duplicate file names.
Off	File numbering restarts from 0001 or from the largest file number in the current folder (if you turn sequential file numbering off and then on again, file numbering will resume from the last number used).
Reset	As for On , except that the next picture taken after Reset is selected is assigned a file number by adding one to the largest file number in the current folder. If the folder is empty, file numbering is reset to 0001.

File Number Sequence

If a picture is taken when the current folder contains 5000 pictures or a picture numbered 9999, a new folder will be created and file numbering will restart from 0001. The new folder is assigned a number one higher than current folder number or, if a folder with that number already exists, the lowest available folder number. If the current folder is numbered 999, the camera will not be able to create a new folder and the shutter release will be disabled (in addition, movie recording may be disabled if the camera calculates that the number of files needed to record a movie of the maximum length would result in the folder containing over 5000 files or a file with a number over 9999). To resume shooting, choose **Reset** for Custom Setting d7 (**File number sequence**) and then either format the current memory card or insert a new memory card.

d8: Apply Settings to Live View

MENU button →  (Custom Settings menu)

Choose **On** to preview how changes to such settings as white balance, Picture Controls, and exposure compensation affect color and brightness in photo mode, or select **Off** to adjust brightness and hue for ease of viewing (regardless of the option selected, the effects of the aforementioned settings are always visible in movie mode). A  icon is displayed when **Off** is selected.

d9: Framing Grid Display

MENU button →  (Custom Settings menu)

Choose **On** to display a grid for reference when framing shots.

d10: Peaking Highlights

MENU button →  (Custom Settings menu)

When focus peaking is enabled in manual focus mode, objects that are in focus are indicated by colored outlines in the display. Choose the peaking level and outline color.

- **Peaking level:** Choose from **3 (high sensitivity)**, **2 (standard)**, **1 (low sensitivity)**, and **Off**; the higher the value, the greater the depth that will be shown as being in focus.
- **Peaking highlight color:** Choose the highlight color.

d11: View All in Continuous Mode

MENU button →  (Custom Settings menu)

If **Off** is selected, the display will go blank during burst photography.

e: Bracketing/Flash

e1: Flash Sync Speed

MENU button →  (Custom Settings menu)

Choose the flash sync speed.

- **1/200 s (Auto FP):** Auto FP high-speed sync is enabled with compatible flash units and the maximum sync speed for other flash units is set to $\frac{1}{200}$ s. When the camera shows a shutter speed of $\frac{1}{200}$ s in mode **P** or **A**, auto FP high-speed sync will be activated if the actual shutter speed is faster than $\frac{1}{200}$ s, and shutter speeds as fast as $\frac{1}{8000}$ s can be selected by the camera (modes **P** and **A**) or by the user (modes **S** and **M**).
- **1/200 s–1/60 s:** Set the maximum flash sync speed to the selected value.

Fixing Shutter Speed at the Flash Sync Speed Limit

To fix shutter speed at the sync speed limit in mode **S** or **M**, choose a speed one setting slower than the slowest speed possible (30 s or **Time**). A flash sync indicator (“X”) will appear in the display and control panel together with the flash sync speed.

Auto FP High-Speed Sync

Auto FP high-speed sync allows the flash to be used at the highest shutter speed supported by the camera, making it possible to choose the maximum aperture for reduced depth of field even in bright sunlight. The flash information display shows “FP” when **1/200 s (Auto FP)** is selected.

e2: Flash Shutter Speed



MENU button →  (Custom Settings menu)

Choose the slowest shutter speed available when front- or rear-curtain sync or red-eye reduction is used in mode **P** or **A** (regardless of the setting chosen, shutter speeds can be as slow as 30 s in modes **S** and **M** or at flash settings of slow sync, slow rear-curtain sync, or red-eye reduction with slow sync).

e3: Exposure Comp. for Flash

MENU button →  (Custom Settings menu)



Choose how the camera adjusts flash level when exposure compensation is used.

Option	Description
 Entire frame	Both flash level and exposure compensation are adjusted to modify exposure over the entire frame.
 Background only	Exposure compensation applies to background only.

e4: Auto ISO Sensitivity Control

MENU button →  (Custom Settings menu)

Choose how the camera adjusts flash level when auto ISO sensitivity control is enabled.

Option	Description
 Subject and background	The camera takes both the main subject and background lighting into account when adjusting ISO sensitivity.
 Subject only	ISO sensitivity is adjusted only to ensure that the main subject is correctly exposed.

e5: Modeling Flash





MENU button →  (Custom Settings menu)

If **On** is selected when the camera is used with an optional flash unit that supports the Nikon Creative Lighting system, pressing the button to which **Preview** has been assigned using Custom Setting f2 (**Custom control assignment**) emits a modeling flash that can be used to preview the effects of flash lighting. No modeling flash is emitted if **Off** is selected.

e6: Auto Bracketing (Mode M)

MENU button →  (Custom Settings menu)



Choose which settings are affected when **AE & flash bracketing** or **AE bracketing** is selected for **Auto bracketing > Auto bracketing set** in the photo shooting menu and the mode dial is rotated to **M**.

Option	Description
 Flash/speed	The camera varies shutter speed (AE bracketing) or shutter speed and flash level (AE & flash bracketing).
 Flash/speed/aperture	The camera varies shutter speed and aperture (AE bracketing) or shutter speed, aperture, and flash level (AE & flash bracketing).
 Flash/aperture	The camera varies aperture (AE bracketing) or aperture and flash level (AE & flash bracketing).
 Flash only	The camera varies flash level only (AE & flash bracketing).

Flash bracketing is performed only with i-TTL or  (auto aperture) flash control. If auto ISO sensitivity control is enabled when a setting other than **Flash only** is selected, ISO sensitivity will be fixed at the value for the first shot unless the flash is used.

e7: Bracketing Order



MENU button →  (Custom Settings menu)























At the default setting of **MTR > under > over** ()^(N), exposure, flash, and white balance bracketing are performed in the following order: the unmodified shot is taken first, followed by the shot with the lowest value, followed by the shot with the highest value. If **Under > MTR > over** ()^(-→+) is selected, shooting will proceed in order from the lowest to the highest value. This setting has no effect on ADL bracketing.

f: Controls

f1: Customize Menu







MENU button →  (Custom Settings menu)

Choose the options displayed in the  menu for photo mode. The following options can be assigned to any position in the menu by highlighting the desired position, pressing , and choosing the desired option.

Option		Option	
 Choose image area	167	BKT Auto bracketing	192
QUAL Image quality	106	 Multiple exposure	202
SIZE Image size	108	HDR HDR (high dynamic range)	209
 Exposure compensation	84	 Silent photography	68
ISO ISO sensitivity settings	82, 171	 Release mode	86
WB White balance	64, 100	 Custom control assignment	273
 Set Picture Control	96	DLY Exposure delay mode	263
RGB Color space	184	 Shutter type	264
 Active D-Lighting	112	 Apply settings to live view	266
 Long exposure NR	185	 Split-screen display zoom	272
ISO NR High ISO NR	185	PEAK Peaking highlights	266
 Metering	110	 Monitor/viewfinder brightness	297, 299
 Flash mode	109, 356	 Bluetooth connection	310
 Flash compensation	191	 Wi-Fi connection	111
AF/MF Focus mode	52, 115		
 AF-area mode	54, 115		
 Vibration reduction	114		

Split-Screen Display Zoom

When assigned to the **i** menu, **Split-screen display zoom** can be used to split the display into two boxes showing separate areas of the frame side-by-side at a high zoom ratio. The positions of the magnified areas are shown in the navigation window, making it easier to check focus at two different locations when photographing a building or other wide object situated at right angles to the camera.

Use the  and  buttons to zoom in and out, or use the  button to select a box and press  or  to scroll the selected area left or right. Pressing  or  scrolls both areas up or down simultaneously. To focus on the subject at the center of the selected area, press the shutter-release button halfway. To exit the split-screen display, press the **i** button.

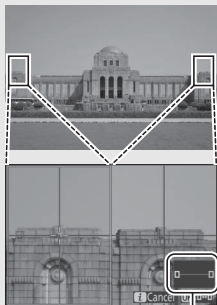

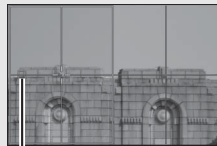

Navigation window











Area in focus

f2: Custom Control Assignment



















MENU button →  (Custom Settings menu)

To choose the functions assigned to the following controls in photo mode, whether used individually or in combination with the command dials, highlight the desired option and press .



	Fn1 button		Fn2 button
	AF-ON button		Sub-selector
	Center of sub-selector		Movie-record button
	Lens Fn button		Lens Fn2 button
	Lens control ring		

The roles that can be assigned to these controls are as follows:

Option									
 RESET Select center focus point	—	—	✓	—	✓	—	—	—	—
 AF-ON	✓	✓	✓	—	✓	—	✓	✓	—
 AF lock only	✓	✓	✓	—	✓	—	✓	✓	—
 AE lock (Hold)	✓	✓	✓	—	✓	✓	✓	✓	—
 AE lock (Reset on release)	✓	✓	✓	—	✓	✓	✓	✓	—
 AE lock only	✓	✓	✓	—	✓	—	✓	✓	—
 AE/AF lock	✓	✓	✓	—	✓	—	✓	✓	—
 FV lock	✓	✓	—	—	✓	—	✓	✓	—
 Disable/enable	✓	✓	—	—	✓	—	✓	✓	—
 Preview	✓	✓	—	—	✓	✓	✓	✓	—













Option	Fn1	Fn2	AF-ON				L.Fn	L.Fn2	
Matrix metering	✓	✓	—	—	✓	—	✓	✓	—
Center-weighted metering	✓	✓	—	—	✓	—	✓	✓	—
Spot metering	✓	✓	—	—	✓	—	✓	✓	—
Highlight-weighted metering	✓	✓	—	—	✓	—	✓	✓	—
Bracketing burst	✓	✓	—	—	✓	—	✓	✓	—
Sync. release selection	✓	✓	—	—	✓	—	✓	✓	—
+ NEF (RAW)	✓	✓	—	—	✓	✓	✓	✓	—
Subject tracking	✓	✓	—	—	—	—	✓	✓	—
Framing grid display	✓	✓	—	—	✓	✓	✓	✓	—
Zoom on/off	✓	✓	✓	—	—	✓	✓	✓	—
MY MENU	✓	✓	—	—	—	✓	✓	✓	—
Access top item in MY MENU	✓	✓	—	—	—	✓	✓	✓	—
Playback	✓	✓	—	—	—	—	✓	✓	—
Protect	✓	✓	—	—	—	—	—	—	—
Choose image area	✓	✓	—	—	✓	✓	—	—	—
Image quality/size	✓	✓	—	—	—	✓	—	—	—
White balance	✓	✓	—	—	—	✓	—	—	—
Set Picture Control	✓	✓	—	—	—	✓	—	—	—
Active D-Lighting	✓	✓	—	—	—	✓	—	—	—
Metering	✓	✓	—	—	—	✓	—	—	—
Flash mode/compensation	✓	✓	—	—	—	✓	—	—	—
Focus mode/AF-area mode	✓	✓	—	—	—	✓	—	—	—





Option									
BKT	Auto bracketing	✓	✓	—	—	—	✓	—	—
	Multiple exposure	✓	✓	—	—	—	✓	—	—
HDR	HDR (high dynamic range)	✓	✓	—	—	—	✓	—	—
DLY	Exposure delay mode	✓	✓	—	—	—	✓	—	—
	Shutter spd & aperture lock	✓	✓	—	—	—	✓	—	—
PEAK	Peaking highlights	✓	✓	—	—	—	—	—	—
★	Rating	✓	✓	—	—	—	—	—	—
Non-CPU	Choose non-CPU lens number	✓	✓	—	—	✓	✓	—	—
=	Same as multi selector	—	—	—	✓	—	—	—	—
[]	Focus point selection	—	—	—	✓	—	—	—	—
M/A	Focus (M/A)	—	—	—	—	—	—	—	✓ ^{1, 2}
	Aperture	—	—	—	—	—	—	—	✓ ²
	Exposure compensation	—	—	—	—	—	—	—	✓ ²
ISO	ISO sensitivity	—	—	—	—	—	—	—	✓ ²
	None	✓	✓	✓	—	✓	✓	✓	✓ ²











1 Available only with compatible lenses.







2 Regardless of the option selected, in manual focus mode the control ring can only be used to adjust focus.















The following options are available:

Option	Description
 RESET Select center focus point	Pressing the control selects the center focus point.
 AF-ON	Pressing the control initiates autofocus.
 AF lock only	Focus locks while the control is pressed.
 AE lock (Hold)	Exposure locks when the control is pressed, and remains locked until the control is pressed a second time or the standby timer expires.
 AE lock (Reset on release)	Exposure locks when the control is pressed, and remains locked until the control is pressed a second time, the shutter is released, or the standby timer expires.
 AE lock only	Exposure locks while the control is pressed.
 AE/AF lock	Focus and exposure lock while the control is pressed.
 FV lock	Press the control to lock flash value for optional flash units. Press again to cancel FV lock.
 Disable/enable	If the flash is currently off, front-curtain sync will be selected while the control is pressed. If the flash is currently enabled, it will instead be disabled while the control is pressed.
 Preview	Keep the control pressed to preview color, exposure, and depth of field.
 Matrix metering	Matrix metering is activated while the control is pressed.
 Center-weighted metering	Center-weighted metering is activated while the control is pressed.

Option	Description
 Spot metering	Spot metering is activated while the control is pressed.
 * Highlight-weighted metering	Highlight-weighted metering is activated while the control is pressed.
 Bracketing burst	If the control is pressed while exposure, flash, or ADL bracketing is active in single frame release mode, all shots in the current bracketing program will be taken each time the shutter-release button is pressed. If white balance bracketing is active or a continuous release mode is selected, the camera will repeat the bracketing burst while the shutter-release button is held down.
 Sync. release selection	<p>When an optional wireless remote controller is connected, the control can be used to toggle between remote release and master or synchronized release. The options available depend on the setting chosen for Custom Setting d3 (Sync. release mode options):</p> <ul style="list-style-type: none"> • If Sync is selected, you can choose from Master release only (keep the control pressed to take pictures with the master camera only) and Remote release only (keep the control pressed to take pictures with the remote cameras only). • If No sync is selected, you can choose from Synchronized release (keep the control pressed to synchronize the releases on the master and remote cameras) and Remote release only (keep the control pressed to take pictures with the remote cameras only).

Option	Description
 + NEF (RAW)	If a JPEG option is currently selected for image quality, “RAW” will be displayed and an NEF (RAW) copy will be recorded with the next picture taken after the control is pressed (the original image quality setting will be restored when you remove your finger from the shutter-release button). NEF (RAW) copies are recorded at the settings currently selected for NEF (RAW) recording and Image size > NEF (RAW) in the photo shooting menu. To exit without recording an NEF (RAW) copy, press the control again.
 Subject tracking	Pressing the control during auto-area AF enables subject tracking; the focus point will change to a targeting reticle and the monitor to a subject-tracking display. To end subject-tracking AF, press the control again or press the  (?) button.
 Framing grid display	Press the control to turn the framing grid display on or off.
 Zoom on/off	Press the control to zoom the display in on the area around the current focus point. Press the control again to zoom out.
 MY MENU	Pressing the control displays “MY MENU”.
 Access top item in MY MENU	Press the control to jump to the top item in “MY MENU.” Select this option for quick access to a frequently-used menu item.
 Playback	Press the control to start playback.
 Protect	Press the control during playback to protect the current picture.
 Choose image area	Press the control and rotate a command dial to choose the image area.

Option	Description
QUAL Image quality/size	Press the control and rotate the main command dial to choose an image quality option and the sub-command dial to select image size.
WB White balance	Press the control and rotate the main command dial to choose a white balance option (in some cases, a sub-option can be selected using the sub-command dial).
 Set Picture Control	Press the control and rotate a command dial to choose a Picture Control.
 Active D-Lighting	Press the control and rotate a command dial to adjust Active D-Lighting.
 Metering	Press the control and rotate a command dial to choose a metering option.
 Flash mode/compensation	Press the control and rotate the main command dial to choose a flash mode and the sub-command dial to adjust flash output.
AF/[+] Focus mode/AF-area mode	Press the control and rotate the main and sub-command dials to choose the focus and AF-area modes.
BKT Auto bracketing	Press the control and rotate the main command dial to choose the number of shots and the sub-command dial to select the bracketing increment or Active D-Lighting amount.
 Multiple exposure	Press the control and rotate the main command dial to choose the mode and the sub-command dial to choose the number of shots.
HDR HDR (high dynamic range)	Press the control and rotate the main command dial to choose the mode and the sub-command dial to choose the exposure differential.
 Exposure delay mode	Press the control and rotate a command dial to choose the shutter-release delay.

Option	Description
 Shutter spd & aperture lock	Press the control and rotate the main command dial to lock shutter speed in modes S and M ; press the control and rotate the sub-command dial to lock aperture in modes A and M .
 Peaking highlights	Press the control and rotate the main command dial to choose a peaking level and the sub-command dial to select the peaking color.
 Rating	Press the control and rotate the main command dial to rate the current picture during playback.
 Choose non-CPU lens number	Press the control and rotate a command dial to choose a lens number saved using the Non-CPU lens data option in the setup menu.
 Same as multi selector	Pressing the sub-selector up, down, left, and right during shooting or playback has the same effect as pressing  ,  ,  , and  on the multi selector. To choose the role played by sub-selector during zoom, highlight Same as multi selector and press  . Choose from Scroll (scroll the display) and Display next/previous frame (view other photos at the same zoom ratio).
 Focus point selection	Use the control to select the focus point. Using the control during playback ends playback and enables focus-point selection.
 Focus (M/A)	Autofocus can be over-riden by rotating the control ring while the shutter-release button is pressed halfway (autofocus with manual override). To refocus using autofocus, lift your finger from the shutter-release button and then press it halfway again.
 Aperture	Use the control to adjust aperture.
 Exposure compensation	Use the control to adjust exposure compensation.
 ISO sensitivity	Use the control to adjust ISO sensitivity.
None	The control has no effect.





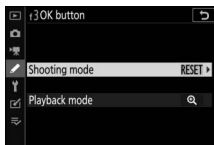

f3: OK Button

MENU button →  (Custom Settings menu)





Choose the role assigned to the  button in photo mode and during playback.



- **Shooting mode:** Choose from the options below. Regardless of the option selected, the  button can be used for focus tracking when auto-area AF is selected for AF-area mode.

Option	Description
 Select center focus point	Pressing  selects the center focus point.
 Zoom on/off	Press  to zoom the display in on the area around the current focus point (to choose the zoom ratio, highlight Zoom on/off and press ). Press  again to return to the previous display.
None	Pressing  during shooting has no effect.

- **Playback mode:** Choose from the options below. Regardless of the option selected, pressing **OK** when a movie is displayed full frame starts movie playback.

Option	Description
 Thumbnail on/off	Toggle between full-frame and thumbnail playback.
 View histograms	In both full-frame and thumbnail playback, a histogram is displayed while the OK button is pressed.
 Zoom on/off	Toggle between full-frame or thumbnail playback and playback zoom (to choose the zoom ratio, highlight Zoom on/off and press OK). The zoom display is centered on the active focus point.
 Choose folder	A folder-selection dialog will be displayed; highlight a folder and press OK to view the pictures in the selected folder.

f4: Shutter Spd & Aperture Lock



MENU button →  (Custom Settings menu)

Selecting **On** for **Shutter speed lock** locks shutter speed at the value currently selected in mode **S** or **M**. Selecting **On** for **Aperture lock** locks aperture at the value currently selected in mode **A** or **M**. While shutter speed or aperture lock is in effect, a  icon will be displayed. Shutter speed and aperture lock are not available in mode **P**.

f5: Customize Command Dials



MENU button →  (Custom Settings menu)

Customize the operation of the main and sub-command dials.

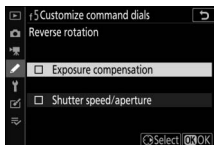
- **Reverse rotation:** Reverse the direction of rotation of the command dials for selected operations. Highlight options and press  to select or deselect, and then press  to save changes and exit.





- **Change main/sub:** Choose the roles played by the command dials for exposure and focus operations.
 - **Exposure setting:** If **On** is selected, the main command dial will control aperture and the sub-command dial shutter speed. If **On (Mode A)** is selected, the main command dial will be used to set aperture in mode **A** only.
 - **Autofocus setting:** This option applies to the control assigned **Focus mode/AF-area mode** using Custom Setting f2 (**Custom control assignment**). If **On** is selected, the focus mode can be chosen by keeping the control pressed and rotating the sub-command dial, AF-area mode by keeping the control pressed and rotating the main command dial.

- **Menus and playback:** Select **Off** to use the multi selector for menus and playback. If **On** or **On (image review excluded)** is selected, the main command dial can be used to choose the picture displayed during full-frame playback and to highlight thumbnails and menu items. The sub-command dial is used in full-frame playback to skip forward or back according to the option selected for **Sub-dial frame advance** and in thumbnail playback to page up or down. While menus are displayed, rotating the sub-command dial right displays the sub-menu for the highlighted option, while rotating it left displays the previous menu. To make a selection, press  or . Select **On (image review excluded)** to prevent the command dials from being used for playback during image review.
- **Sub-dial frame advance:** When **On** or **On (image review excluded)** is selected for **Menus and playback**, the sub-command dial can be rotated during full-frame playback to select a folder, to skip forward or back 10 or 50 frames at a time, or to skip to the next or previous protected picture, the next or previous photo, the next or previous movie, or the next or previous picture with a selected rating (to choose the rating, highlight **Rating** and press ).



f6: Release Button to Use Dial

MENU button →  (Custom Settings menu)

Selecting **Yes** allows adjustments that are normally made by holding a button and rotating a command dial to be made by rotating the command dial after the button is released. This ends when the button is pressed again, the shutter-release button is pressed halfway, or the standby timer expires. This setting applies to the , **ISO**, and  (☺) buttons and also to controls to which the following roles have been assigned using Custom Settings f2 or g2 (**Custom control assignment**): **Choose image area, Image quality/size, White balance, Set Picture Control, Active D-Lighting, Metering, Flash mode/compensation, Focus mode/AF-area mode, Auto bracketing, Multiple exposure, HDR (high dynamic range), Exposure delay mode, Shutter spd & aperture lock, Peaking highlights, Choose non-CPU lens number, and Microphone sensitivity.**

f7: Reverse Indicators



MENU button →  (Custom Settings menu)





















If  (-0+) is selected, the exposure indicator is displayed with negative values on the left and positive values on the right. Select  (+0-) to display positive values on the left and negative values on the right.

g: Movie

g1: Customize Menu

MENU button →  (Custom Settings menu)

Choose the options displayed in the  menu for movie mode. The following options can be assigned to any position in the menu by highlighting the desired position, pressing , and choosing the desired option.







Option		Option	
 Choose image area	121	 Microphone sensitivity	120
 Frame size and rate/ Image quality	118	 Attenuator	246
 Exposure compensation	84	 Frequency response	247
ISO ISO sensitivity settings	242	 Wind noise reduction	247
WB White balance	64, 100	 Headphone volume	247
 Set Picture Control	96	 Peaking highlights	266
 Active D-Lighting	112, 122	 Highlight display	294
 Metering	110, 122	 Monitor/viewfinder brightness	297, 299
AF/MF Focus mode	52, 123	 Bluetooth connection	310
 AF-area mode	54, 123	 Wi-Fi connection	111
 Vibration reduction	114		
 Electronic VR	122		

g2: Custom Control Assignment



















MENU button →  (Custom Settings menu)

















To choose the functions assigned to the following controls in movie mode, whether used individually or in combination with the command dials, highlight the desired option and press .



	Fn1 button		Fn2 button
	AF-ON button		Center of sub-selector
	Shutter-release button		Lens control ring

The roles that can be assigned to these controls are as follows:









Option						
 Power aperture (open)	✓	—	—	—	—	—
 Power aperture (close)	—	✓	—	—	—	—
 Exposure compensation +	✓	—	—	—	—	—
 Exposure compensation -	—	✓	—	—	—	—
 Subject tracking	✓	✓	—	—	—	—
 Framing grid display	✓	✓	—	✓	—	—
 Protect	✓	✓	—	—	—	—
RESET Select center focus point	—	—	✓	✓	—	—
 AF-ON	—	—	✓	—	—	—
 AF lock only	—	—	✓	✓	—	—
 AE lock (Hold)	—	—	✓	✓	—	—
 AE lock only	—	—	✓	✓	—	—
 AE/AF lock	—	—	✓	✓	—	—









Option							
	Zoom on/off	—	—	✓	—	—	—
	Take photos	—	—	—	—	✓	—
	Record movies	—	—	✓	✓	✓	—
	Choose image area	✓	✓	—	✓	—	—
WB	White balance	✓	✓	—	—	—	—
	Set Picture Control	✓	✓	—	—	—	—
	Active D-Lighting	✓	✓	—	—	—	—
	Metering	✓	✓	—	—	—	—
AF/[+]	Focus mode/AF-area mode	✓	✓	—	—	—	—
	Microphone sensitivity	✓	✓	—	—	—	—
PEAK	Peaking highlights	✓	✓	—	—	—	—
★	Rating	✓	✓	—	—	—	—
M/A	Focus (M/A)	—	—	—	—	—	✓ ^{1,2}
	Power aperture	—	—	—	—	—	✓ ²
	Exposure compensation	—	—	—	—	—	✓ ²
ISO	ISO sensitivity	—	—	—	—	—	✓ ²
	None	✓	✓	✓	✓	—	✓ ²









1 Available only with compatible lenses.

2 Regardless of the option selected, in manual focus mode the control ring can only be used to adjust focus.

The following options are available:

Option	Description
 Power aperture (open)	Aperture widens while the control is pressed. Use in combination with Custom Setting g2 (Custom control assignment) > Fn2 button > Power aperture (close) for button-controlled aperture adjustment.
 Power aperture (close)	Aperture narrows while the control is pressed. Use in combination with Custom Setting g2 (Custom control assignment) > Fn1 button > Power aperture (open) for button-controlled aperture adjustment.
 Exposure compensation +	Exposure compensation increases while the control is pressed. Use in combination with Custom Setting g2 (Custom control assignment) > Fn2 button > Exposure compensation – for button-controlled exposure compensation.
 Exposure compensation –	Exposure compensation decreases while the control is pressed. Use in combination with Custom Setting g2 (Custom control assignment) > Fn1 button > Exposure compensation + for button-controlled exposure compensation.
 Subject tracking	Pressing the control during auto-area AF enables subject tracking; the focus point will change to a targeting reticle and the monitor to a subject-tracking display. To end subject-tracking AF, press the control again or press the  (?) button.
 Framing grid display	Press the control to turn the framing grid display on or off.
 Protect	Press the control during playback to protect the current picture.

Option	Description
RESET Select center focus point	Pressing the control selects the center focus point.
 AF-ON	Pressing the control initiates autofocus.
 AF lock only	Focus locks while the control is pressed.
 AE lock (Hold)	Exposure locks when the control is pressed, and remains locked until the control is pressed a second time or the standby timer expires.
 AE lock only	Exposure locks while the control is pressed.
 AE/AF lock	Focus and exposure lock while the control is pressed.
 Zoom on/off	Press the control to zoom the display in on the area around the current focus point. Press the control again to zoom out.
 Take photos	Press the shutter-release button all the way down to take a photograph with an aspect ratio of 16 : 9.
 Record movies	Press the shutter-release button halfway to focus (autofocus mode only) and press it all the way down to start or end movie recording. The shutter-release button cannot be used for other purposes in movie mode. The shutter-release button on an optional wireless remote controller or remote cord functions in the same way as the camera shutter-release button.
 Choose image area	Press the control and rotate a command dial to choose the image area. Note that the image area cannot be changed while recording is in progress.
WB White balance	Press the control and rotate the main command dial to choose a white balance option (in some cases, a sub-option can be selected using the sub-command dial).



Option	Description
 Set Picture Control	Press the control and rotate a command dial to choose a Picture Control.
 Active D-Lighting	Press the control and rotate a command dial to adjust Active D-Lighting.
 Metering	Press the control and rotate a command dial to choose a metering option.
AF/[+] Focus mode/ AF-area mode	Press the control and rotate the main and sub-command dials to choose the focus and AF-area modes.
 Microphone sensitivity	Press the control and rotate a command dial to adjust microphone sensitivity.
 Peaking highlights	Press the control and rotate the main command dial to choose a peaking level and the sub-command dial to select the peaking color.
 Rating	Press the control and rotate the main command dial to rate the current picture during playback.
M/A Focus (M/A)	Use the control to focus manually, independent of the option selected for focus mode. Press the shutter-release button halfway or press the AF-ON button to refocus using autofocus.
 Power aperture	Use the control to adjust aperture.
 Exposure compensation	Use the control to adjust exposure compensation.
ISO ISO sensitivity	Use the control to adjust ISO sensitivity.
None	The control has no effect.

Power Aperture







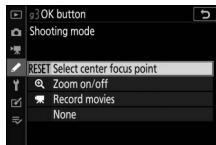

Power aperture is available only in modes **A** and **M** (a  icon indicates that power aperture cannot be used). The display may flicker while aperture is adjusted.

g3: OK Button

MENU button →  (Custom Settings menu)

Choose the role assigned to the  button in movie mode. Regardless of the option selected, the  button can be used for focus tracking when auto-area AF is selected for AF-area mode.



Option	Description
 Select center focus point	Pressing  selects the center focus point.
 Zoom on/off	Press  to zoom the display in on the area around the current focus point (to choose the zoom ratio, highlight Zoom on/off and press  .
 Record movies	Press  to start and stop movie recording.
None	Pressing  has no effect.

g4: AF Speed

MENU button →  (Custom Settings menu)

Choose the focus speed for movie mode. To choose when the selected option applies, highlight **When to apply** and press . Choose from **Always** (the selected option applies whenever the camera is in movie mode) and **Only while recording** (the selected option applies only while recording is in progress; at other times, the focus speed is “+5”, or in other words as fast possible).

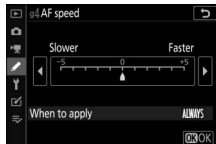

g5: AF Tracking Sensitivity

MENU button →  (Custom Settings menu)

Choose how quickly focus responds when your subject leaves the focus point or something passes between the subject and the camera in movie mode. Choose from values between **7 (Low)** and **1 (High)**. The higher the value, the slower the response and the less likely you are to lose focus on your original subject when something passes between the subject and the camera. The lower the value, the quicker the camera is to respond to the subject leaving the focus area by shifting focus to a new subject in the same area.

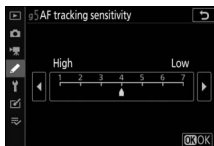

g6: Highlight Display

MENU button →  (Custom Settings menu)

Choose whether shading is used to indicate highlights (bright areas of the frame) and select the level of brightness needed to trigger the highlight display.

- **Display pattern:** To enable the highlight display, select **Pattern 1** or **Pattern 2**.

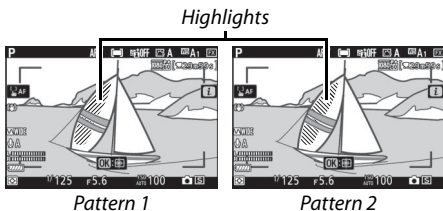

- **Highlight display threshold:** Choose the brightness needed to trigger the movie highlight display. The lower the value, the greater the range of brightnesses that will be shown as highlights. If **255** is selected, the highlight display will show only areas that are potentially overexposed.

Highlight Display

If both the highlight display and peaking highlights are enabled, only peaking highlights will be displayed in manual focus mode. To view the highlight display, select **Off** for Custom Setting d10 (**Peaking highlights**) > **Peaking level**.

Y The Setup Menu: Camera Setup

To view the setup menu, select the Y tab in the camera menus.

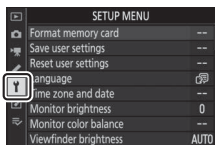

Option	
Format memory card	296
Save user settings	296
Reset user settings	296
Language	296
Time zone and date	297
Monitor brightness	297
Monitor color balance	298
Viewfinder brightness	299
Viewfinder color balance	299
Control panel brightness	299
Limit monitor mode selection	300
Information display	300
AF fine-tune	301
Non-CPU lens data	302
Clean image sensor	302
Image Dust Off ref photo	303
Image comment	305

Option	
Copyright information	306
Beep options	307
Touch controls	307
HDMI	308
Location data	308
Wireless remote (WR) options	309
Assign remote (WR) Fn button	310
Airplane mode	310
Connect to smart device	310
Connect to PC	311
Wireless transmitter (WT-7)	311
Conformity marking	311
Battery info	312
Slot empty release lock	312
Save/load settings	313
Reset all settings	315
Firmware version	315

✓ See Also

For menu defaults, see “Setup Menu Defaults” (📖 154).

Format Memory Card

MENU button →  (setup menu)

Select **Yes** to format the memory card.

Note that formatting permanently deletes all pictures and other data on the card.

Before formatting, be sure to make backup copies as required.



During Formatting

Do not turn the camera off or remove memory cards during formatting.

Save User Settings

MENU button →  (setup menu)

Frequently-used combinations of settings can be assigned to the **U1**, **U2**, and **U3** positions on the mode dial (📖 77).

Reset User Settings

MENU button →  (setup menu)

Reset settings for **U1**, **U2**, and **U3** to default values (📖 78).

Language

MENU button →  (setup menu)

Choose a language for camera menus and messages. The languages available vary with the country or region in which the camera was originally purchased.

Time Zone and Date

MENU button →  (setup menu)



Change time zones, set the camera clock, choose the date display order, and turn daylight saving time on or off. Be sure to check the camera clock regularly against more accurate timepieces and adjust time and date settings as necessary.

Option	Description
Time zone	Choose a time zone. The camera clock is automatically set to the time in the new time zone.
Date and time	Set the camera clock.
Date format	Choose the order in which the day, month, and year are displayed.
Daylight saving time	Turn daylight saving time on or off. The camera clock will automatically be advanced or set back one hour. The default setting is Off .

If the clock is reset, a  indicator will be displayed.



Monitor Brightness

MENU button →  (setup menu)

Press  or  to adjust monitor brightness. Choose higher values for increased brightness, lower values for reduced brightness. Note that monitor brightness can only be adjusted when the monitor is the active display; it cannot be adjusted in the “viewfinder only” monitor mode or when your eye is to the viewfinder.

Monitor Color Balance

MENU button →  (setup menu)

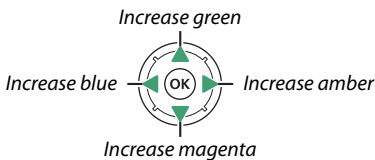
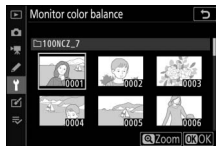

Use the multi selector as shown below to adjust monitor color balance with reference to a sample image. The sample image is the last photograph taken or, in playback mode, the last photograph displayed; to choose a different image, press the  (?) button and select an image from a thumbnail list (to view the highlighted image full frame, press and hold ). If the memory card contains no photographs, an empty frame with a gray border will be displayed in place of the sample image. Press  to exit when adjustments are complete.



Note that monitor color balance can only be adjusted when the monitor is the active display; it cannot be adjusted in the “viewfinder only” monitor mode or when your eye is to the viewfinder. Monitor color balance applies only to the shooting, playback, and menu displays; pictures taken with the camera are not affected.

Viewfinder Brightness

MENU button →  (setup menu)

Adjust viewfinder brightness. If **Auto** is selected, viewfinder brightness will be adjusted automatically in response to lighting conditions; to adjust brightness manually, select **Manual** and press  or  (choose higher values for increased brightness, lower values for reduced brightness). Note that viewfinder brightness can only be adjusted when the viewfinder is the active display; it cannot be adjusted when the viewfinder is off or in the “monitor only” monitor mode.



Viewfinder Color Balance

MENU button →  (setup menu)

Use the multi selector to adjust viewfinder color balance as described in “Monitor Color Balance” (□ 298). Note that viewfinder color balance can only be adjusted when the viewfinder is the active display; it cannot be adjusted when the viewfinder is off or in the “monitor only” monitor mode.



Control Panel Brightness

MENU button →  (setup menu)

Adjust the brightness of the control panel. If **Auto** is selected, control panel brightness will be adjusted automatically in response to lighting conditions; to adjust brightness manually, select **Manual** and press  or . Selecting **Off** turns the control panel off.

Limit Monitor Mode Selection

MENU button →  (setup menu)

Choose the monitor modes that can be selected using the monitor mode button. Highlight the desired options and press  to select or deselect. Press  to save changes when settings are complete.

Information Display

MENU button →  (setup menu)

Adjust the color of the lettering in the information display for ease of viewing. Choose **Dark on light (B)** to display black letters on a white background or **Light on dark (W)** to display white letters on a dark background.



Dark on light

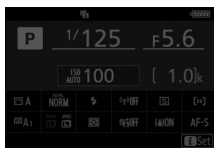







Light on dark

AF Fine-Tune

MENU button →  (setup menu)

Fine-tune focus for up to 30 lens types. Use only as required. We recommend that you perform fine-tuning at a focus distance you use frequently; if you perform focus-tuning at a short focus distance, for example, you may find it less effective at longer distances.

- **AF fine-tune (On/Off):** Choose **On** to turn AF tuning on, **Off** to turn it off.
- **Saved value:** Tune AF for the current lens. Press  to move focal point away from camera or  to move focal point toward camera; choose from values between +20 and -20. The camera can store values for up to 30 lens types. Only one value can be stored for each type of lens.
- **Default:** Choose the AF tuning value used when no previously saved value exists for the current lens.
- **List saved values:** List previously saved AF tuning values. To delete a lens from the list, highlight the desired lens and press . To change a lens identifier (for example, to choose an identifier that is the same as the last two digits of the lens serial number to distinguish it from other lenses of the same type in light of the fact that **Saved value** can be used with only one lens of each type), highlight the desired lens and press . A menu will be displayed; press  or  to choose an identifier and press  to save changes and exit.

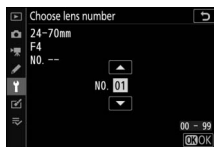
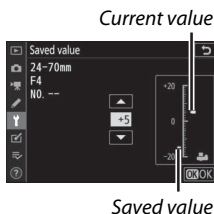

Non-CPU Lens Data

MENU button →  (setup menu)

Non-CPU lenses can be attached via a mount adapter (available separately). Use **Non-CPU lens data** to record the focal length and maximum aperture of non-CPU lenses, allowing them to be used with on-camera vibration reduction and certain other camera features.

- **Lens number:** Choose a number to identify the lens.
- **Focal length (mm):** Enter the lens focal length.
- **Maximum aperture:** Enter the maximum aperture.

Clean Image Sensor

MENU button →  (setup menu)

Dirt or dust entering the camera when lenses are exchanged or the body cap is removed may adhere to the image sensor and affect your photographs. The **Clean image sensor** option vibrates the sensor to remove dust.

Option	Description
Clean now	Perform image sensor cleaning immediately.
Automatic cleaning	<ul style="list-style-type: none">• Clean at shutdown: The image sensor is automatically cleaned during shutdown each time the camera is turned off.• Cleaning off: Automatic image sensor cleaning off.

Acquire reference data for the Image Dust Off option in Capture NX-D (for more information, refer to Capture NX-D online help). Image Dust Off cannot be used with small or medium-sized NEF (RAW) images.

An FX lens with a focal length of at least 50 mm is recommended when recording Image Dust Off reference data. When using a zoom lens, zoom all the way in.

1 Choose a start option.

Highlight one of the following options and press . To exit without acquiring image dust off data, press MENU.

- **Start:** A message will be displayed.
- **Clean sensor and then start:** Select this option to clean the image sensor before starting. A message will be displayed when cleaning is complete.

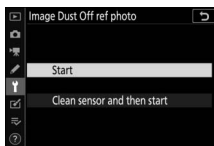

2 Frame a featureless white object in the display.

With the lens about ten centimeters (four inches) from a well-lit, featureless white object, frame the object so that it fills the display and then press the shutter-release button halfway.

In autofocus mode, focus will automatically be set to infinity; in manual focus mode, set focus to infinity manually.

3 Acquire dust off reference data.

Press the shutter-release button the rest of the way down to acquire Image Dust Off reference data. The monitor turns off when the shutter-release button is pressed.

If the reference object is too bright or too dark, the camera may be unable to acquire Image Dust Off reference data and a message will be displayed. Choose another reference object and repeat the process from Step 1.

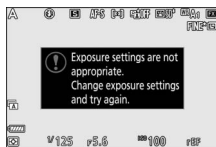

✔ Image Sensor Cleaning

Dust off reference data recorded before image sensor cleaning is performed cannot be used with photographs taken after image sensor cleaning is performed. Select **Clean sensor and then start** only if the dust off reference data will not be used with existing photographs.

✔ Image Dust Off Reference Data

The same reference data can be used for photographs taken with different lenses or at different apertures. Reference images cannot be viewed using computer imaging software. A grid pattern is displayed when reference images are viewed on the camera.

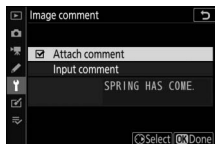

Image Comment

MENU button → **Y** (setup menu)

Add a comment to new photographs as they are taken. Comments can be viewed as metadata in ViewNX-i or Capture NX-D. The comment is also visible on the shooting data page in the photo information display. The following options are available:

- **Input comment:** Input a comment as described in “Text Entry” (☞ 164). Comments can be up to 36 characters long.
- **Attach comment:** Select this option to attach the comment to all subsequent photographs. Highlight **Attach comment** and press **▶** to turn it on or off. After choosing the desired setting, press **OK** to exit.



Add copyright information to new photographs as they are taken. Copyright information is included in the shooting data shown in the photo information display and can be viewed as metadata in ViewNX-i or in Capture NX-D. The following options are available:

- **Artist:** Enter a photographer name as described in “Text Entry” (📖 164). Photographer names can be up to 36 characters long.
- **Copyright:** Enter the name of the copyright holder as described in “Text Entry” (📖 164). Copyright holder names can be up to 54 characters long.
- **Attach copyright information:** Select this option to attach copyright information to all subsequent photographs. Highlight **Attach copyright information** and press **▶** to turn it on or off. After choosing the desired setting, press **OK** to exit.



✔ Copyright Information

To prevent unauthorized use of the artist or copyright holder names, make sure that **Attach copyright information** is not selected and that the **Artist** and **Copyright** fields are blank before lending or transferring the camera to another person. Nikon does not accept liability for any damages or disputes arising from the use of the **Copyright information** option.

Beep Options

MENU button →  (setup menu)

Choose the pitch and volume of the beep that sounds when:

- The self-timer is in operation
- Time-lapse recording ends
- The camera focuses in photo mode (note that a beep will not sound if **AF-C** is selected for focus mode or if **Release** is selected for Custom Setting a2, **AF-S priority selection**)
- The touch screen is used

Note that a beep will not sound while the self-timer is in operation or when the camera focuses if **On** is selected for **Silent photography** in the photo shooting menu.

The **Beep options** menu contains the following items:

- **Beep on/off:** Turn the beep speaker on or off, or select **Off (touch controls only)** to disable the beep associated with touch controls while enabling it for other purposes.
- **Volume:** Adjust beep volume.
- **Pitch:** Choose the pitch of the beep from **High** and **Low**.

Touch Controls

MENU button →  (setup menu)

Adjust settings for monitor touch controls.

- **Enable/disable touch controls:** Select **Disable** to prevent accidental use of touch-screen controls, or **Playback only** to enable touch-screen controls in playback mode only.
- **Full-frame playback flicks:** Choose whether the next image in full-frame playback is displayed by flicking left or by flicking right.

HDMI

MENU button →  (setup menu)

Adjust settings for connection to HDMI devices (📖 348).

Location Data

MENU button →  (setup menu)

Adjust settings for use when the camera is connected to a device that provides location data, namely a GPS receiver or a smart device running the SnapBridge app (for more information on SnapBridge, see the app's online help).

- **Standby timer:** If **Enable** is selected when a GPS receiver is connected, the exposure meters will turn off automatically if no operations are performed for the period specified Custom Setting c3 (**Power off delay**) > **Standby timer**, reducing the drain on the battery.
- **Position:** View the location data supplied by the GPS receiver or smart device (the items displayed vary with the source).
- **Set clock from satellite:** Select **Yes** to synchronize the camera clock with the time reported by the GPS device.

Wireless Remote (WR) Options

MENU button →  (setup menu)





Adjust settings for optional WR-R10 wireless remote controllers and for optional radio-controlled flash units that support Advanced Wireless Lighting.

LED Lamp

Enable or disable the status LEDs on a WR-R10 wireless remote controller mounted on the camera. For more information, see the documentation supplied with the wireless remote controller.

Link Mode

Choose a link mode for WR-R10 wireless remote controllers mounted on other cameras or radio-controlled flash units that support Advanced Wireless Lighting. Be sure that the same mode is selected for the other devices.

- **Pairing:** To pair the camera with other devices, mount the WR-R10 on the camera and press the pairing button.
- **PIN:** Connect using a four-digit PIN code. Press  or  to highlight digits and press  or  to change, then press  to enter and display the selected PIN.



Regardless of the option selected for **Link mode**, signals from paired wireless remote controllers will always be received by the WR-R10. Users of the WR-1 wireless remote controller will need to select pairing as the WR-1 link mode.









The WR-R10 Wireless Remote Controller

Be sure the firmware for the WR-R10 has been updated to the latest version (version 3.0 or later). For information on firmware updates, see the Nikon website for your area.

Assign Remote (WR) Fn Button

MENU button →  (setup menu)

Choose the role played by the **Fn** button on optional wireless remote controllers equipped with an **Fn** button. See Custom Setting f2 (**Custom control assignment**) for more information.

Option	Option
 AF-ON	 FV lock
 AF lock only	 Disable/enable
 AE lock (Reset on release)	 Preview
 AE lock only	 + NEF (RAW)
 AE/AF lock	None

Airplane Mode

MENU button →  (setup menu)

Select **Enable** to disable the camera's built-in Bluetooth and Wi-Fi functions. The Bluetooth and Wi-Fi functions of optional peripheral devices connected to the camera can only be disabled by disconnecting the devices.

Connect to Smart Device

MENU button →  (setup menu)

Adjust settings for connection to a smart device. For information on connecting to smart devices, see SnapBridge online help or the *Network Guide*.

Connect to PC

MENU button →  (setup menu)

Adjust settings for connection to computers using the camera's built-in Wi-Fi. For more information, see the *Network Guide*.

Wireless Transmitter (WT-7)

MENU button →  (setup menu)

Adjust settings for connection to computers or ftp servers via wireless or Ethernet networks. This option is available only when an optional WT-7 wireless transmitter is connected. See the WT-7 manual for details.

Conformity Marking

MENU button →  (setup menu)

View some of the standards with which the camera complies.

Wireless Connections

For information on establishing wireless connections to computers or smart devices, see the *Network Guide*, available from the Nikon Download Center:



Z7: https://downloadcenter.nikonimglib.com/en/products/492/Z_7.html

Z6: https://downloadcenter.nikonimglib.com/en/products/493/Z_6.html

Battery Info

MENU button →  (setup menu)

View information on the battery currently inserted in the camera.

- **Charge:** The current battery level expressed as a percentage.
- **No. of shots:** The number of times the shutter has been released with the current battery since the battery was last charged. Note that the camera may sometimes release the shutter without recording a photograph, for example when measuring preset white balance.
- **Battery age:** A five-level display showing battery age. **0** () indicates that battery performance is unimpaired, **4** () that the battery has reached the end of its charging life and should be replaced. Note that fresh batteries charged at temperatures under about 5 °C (41 °F) may show a temporary drop in charging life; the battery age display will however return to normal once the battery has been recharged at a temperature of about 20 °C (68 °F) or higher.

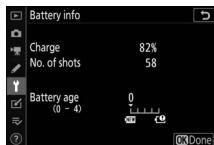

Slot Empty Release Lock

MENU button →  (setup menu)

Selecting **Enable release** allows the shutter to be released when no memory card is inserted, although no pictures will be recorded (they will however be displayed in demo mode). If **Release locked** is selected, the shutter-release button is only enabled when a memory card is inserted in the camera.

Save/Load Settings

MENU button →  (setup menu)

Select **Save settings** to save the following settings to the memory card (if the card is full, an error will be displayed). Use this option to share settings among cameras of the same model.

Playback menu	Photo shooting menu (continued)
Playback display options	Flicker reduction shooting
Image review	Metering
After delete	Flash control
After burst, show	Flash mode
Rotate tall	Flash compensation
Photo shooting menu	Focus mode
File naming	AF-area mode
Choose image area	Vibration reduction (settings vary with lens)
Image quality	Auto bracketing
Image size	Silent photography
NEF (RAW) recording	Movie shooting menu
ISO sensitivity settings	File naming
White balance	Choose image area
Set Picture Control (Custom Picture Controls are saved as Auto)	Frame size/frame rate
Color space	Movie quality
Active D-Lighting	Movie file type
Long exposure NR	ISO sensitivity settings
High ISO NR	White balance
Vignette control	Set Picture Control (Custom Picture Controls are saved as Auto)
Diffraction compensation	Active D-Lighting
Auto distortion control	

Movie shooting menu (continued)	Setup menu
High ISO NR	Language
Vignette control	Time zone and date (excepting Date and time)
Diffraction compensation	Limit monitor mode selection
Auto distortion control	Information display
Flicker reduction	Non-CPU lens data
Metering	Clean image sensor
Focus mode	Image comment
AF-area mode	Copyright information
Vibration reduction (settings vary with lens)	Beep options
Electronic VR	Touch controls
Microphone sensitivity	HDMI
Attenuator	Location data (excepting Position)
Frequency response	Wireless remote (WR) options
Wind noise reduction	Assign remote (WR) Fn button
Headphone volume	Slot empty release lock
Timecode (excepting Timecode origin)	
Custom Settings	
All Custom Settings except d3 (Sync. release mode options)	

Settings saved using the camera or other cameras of the same model can be restored by selecting **Load settings**. Note that **Save/load settings** is only available when a memory card is inserted in the camera, and that the **Load settings** option is only available if the card contains saved settings.

Saved Settings

Settings are saved in a file with a name beginning with "NCSET" and ending with three characters that differ from camera to camera. The camera will not be able to load settings if the file name is changed.

Reset All Settings

MENU button →  (setup menu)

Reset all settings except **Language** and **Time zone and date** to their default values. Copyright information and other user-generated entries are also reset. We recommend that you save settings using the **Save/load settings** option in the setup menu before performing a reset.

Firmware Version

MENU button →  (setup menu)





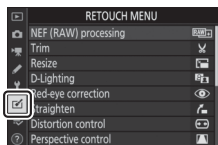

View the current camera firmware version.







The Retouch Menu: *Creating Retouched Copies*

To view the retouch menu, select the  tab in the camera menus.



The options in the retouch menu are used to create trimmed or retouched copies of existing pictures. The retouch menu is only displayed when a memory card containing photographs is inserted in the camera.

Option	
 NEF (RAW) processing	319
 Trim	322
 Resize	323
 D-Lighting	325
 Red-eye correction	325
 Straighten	326

Option	
 Distortion control	326
 Perspective control	327
 Image overlay ¹	328
 Trim movie	331
 Side-by-side comparison ²	331

- 1 Can only be selected by pressing **MENU** and selecting .
- 2 Can only be displayed by pressing **i** and selecting **Retouch** when a retouched image or original is displayed.

Creating Retouched Copies

To create a retouched copy:

1 Select an item in the retouch menu.

Press or to highlight an item, to select.

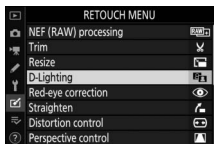

2 Select a picture.

Highlight a picture and press . To view the highlighted picture full screen, press and hold the button.



Retouch

In the case of images recorded at image quality settings of NEF + JPEG, only the NEF (RAW) image will be retouched. The camera may not be able to display or retouch images created with other devices.

3 Select retouch options.

For more information, see the section for the selected item. To exit without creating a retouched copy, press **MENU**.

Power off Delay

The display will turn off and the operation will be cancelled if no actions are performed for a brief period. Any unsaved changes will be lost. To increase the time the display remains on, choose a longer menu display time using Custom Setting c3 (**Power off delay**) > **Menus**.

4 Create a retouched copy.

Press **OK** to create a retouched copy. Retouched copies are indicated by a  icon.



Retouching the Current Image

To create a retouched copy of the current image, press **i** and select **Retouch**.

Retouching Copies

Most options can be applied to copies created using other retouch options, although (with the exception of **Trim movie**) each option can be applied only once (note that multiple edits may result in loss of detail). Options that cannot be applied to the current image are grayed out and unavailable.

Image Quality and Size

Except in the case of copies created with **NEF (RAW) processing**, **Trim**, and **Resize**, copies are the same size as the original. Copies created from JPEG images are the same quality as the original, while cropped and resized copies created from NEF (RAW) and TIFF (RGB) images are saved in JPEG fine★ format.

NEF (RAW) Processing

MENU button →  (retouch menu)

Create JPEG copies of NEF (RAW) photographs. If you displayed the retouch menu by pressing the MENU button, you can use this option to copy multiple images.

- 1 Select NEF (RAW) processing.**
Highlight **NEF (RAW) processing** in the retouch menu and press .

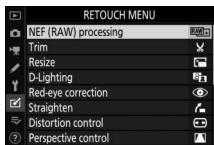

- 2 Choose how images are selected.**
Choose from the following options:

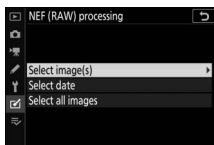

- **Select image(s):** Select one or more images manually.
- **Select date:** Create JPEG copies of all the NEF (RAW) images taken on selected dates.
- **Select all images:** Create JPEG copies of all the NEF (RAW) images on the memory card (proceed to Step 4).



3 Select photographs.



If you chose **Select image(s)** in Step 2, a picture selection dialog will be displayed listing only NEF (RAW) images created with this camera.

Highlight images using the multi selector and press the  (?) button

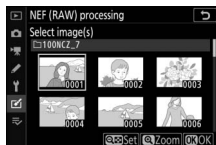
to select or deselect; selected images are indicated by a ✓ icon. To view the highlighted image full screen, press and hold the  button. Press  to proceed to Step 4 when your selection is complete.



If you chose **Select date** in Step 2, a list of dates will be displayed.

Highlight dates using the multi selector and press  to select or deselect. Press  to select all NEF (RAW) pictures taken on the chosen dates and proceed to Step 4.

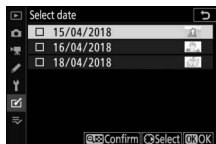

4 Choose settings for the JPEG copies.

Adjust the settings listed below, or select **Original** (if available) to use the setting in effect when the photograph was taken (the original settings are listed below the preview). Note that exposure compensation can only be set to values between -2 and $+2$ EV.

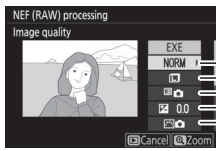

1
2
3
4
5

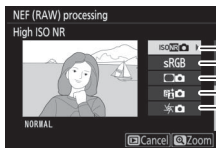

6
7
8
9
10

1	Image quality	106	6	High ISO NR	185
2	Image size	108	7	Color space	184
3	White balance64, 100	8	Vignette control	186
4	Exposure compensation84	9	Active D-Lighting	112
5	Set Picture Control	96, 179	10	Diffraction compensation	186

5 Copy the photographs.



Highlight **EXE** and press **OK** to create a JPEG copy of the selected photograph (if multiple photos are selected, a confirmation dialog will be displayed; highlight **Yes** and press **OK** to create JPEG copies of the selected photos). To exit without copying the photographs, press the **▶** button.



Trim

MENU button →  (retouch menu)

Create a cropped copy of the selected photograph. The selected photograph is displayed with the selected crop shown in yellow; create a cropped copy as described below.

- **To reduce size of the crop:** Press  (?).
- **To increase size of the crop:** Press .
- **To change the crop aspect ratio:** Rotate the main command dial.
- **To position the crop:** Use the multi selector.
- **To create a cropped copy:** Press  to save the current crop as a separate file. The size of the copy varies with crop size and aspect ratio and appears at upper left in the crop display.



Viewing Cropped Copies



Playback zoom may not be available when cropped copies are displayed.

Resize

MENU button →  (retouch menu)

Use the **Resize** option in the camera menu  tab to create small copies of selected photographs.

1 Select **Resize**.

Highlight **Resize** in the  tab and press .

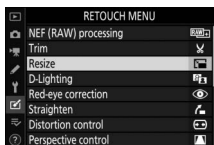

2 Choose a size.

Highlight **Choose size** and press .

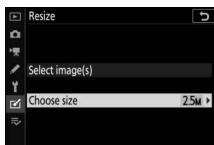

Highlight the desired size and press .

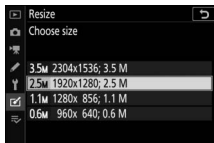

3 Choose pictures.

Highlight **Select image(s)** and press



Highlight pictures and press \mathbb{Q} (?) to select or deselect (to view the highlighted picture full screen, press and hold the \mathbb{Q} button). Selected pictures are marked by a icon. Press \mathbb{O} when the selection is complete. Note that photographs taken at an image-area setting of **1 : 1 (24x24)**, **16 : 9 (36x20)**, or (Z 7 only) **5 : 4 (30x24)** cannot be resized.



4 Save the resized copies.

A confirmation dialog will be displayed. Highlight **Yes** and press \mathbb{O} to save the resized copies.

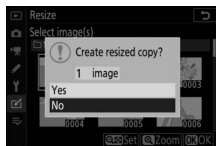

Viewing Resized Copies

Playback zoom may not be available when resized copies are displayed.

D-Lighting

MENU button →  (retouch menu)

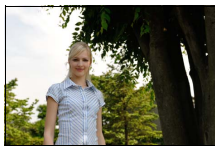

D-Lighting brightens shadows, making it ideal for dark or backlit photographs.

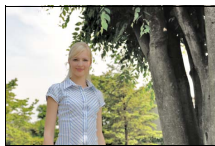

Before



After

Press  or  to choose the amount of correction performed. The effect can be previewed in the edit display. Press  to save the retouched copy.







Red-Eye Correction

MENU button →  (retouch menu)

This option is used to correct “red-eye” and is available only with photographs taken using a flash. The photograph selected for red-eye correction can be previewed in the edit display. Confirm the effects of red-eye correction and press  to create a copy. Note that red-eye correction may not always produce the expected results and may in very rare circumstances be applied to portions of the image that are not affected by red-eye; check the preview thoroughly before proceeding.

Straighten

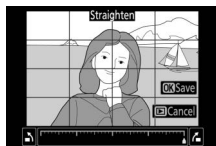

MENU button →  (retouch menu)

Create a straightened copy of the selected image. Press  to rotate the image clockwise by up to five degrees in increments of approximately 0.25 degrees,  to rotate it counter-clockwise (the effect can be previewed in the edit display; note that edges of the image will be trimmed to create a square copy). Press  to save the retouched copy.



Distortion Control

MENU button →  (retouch menu)

Create copies with reduced peripheral distortion. Select **Auto** to let the camera correct distortion automatically and then make fine adjustments using the multi selector, or select **Manual** to reduce distortion manually. Note that **Auto** is not available with photos taken using auto distortion control. Press  to reduce barrel distortion,  to reduce pincushion distortion (the effect can be previewed in the edit display; note that greater amounts of distortion control result in more of the edges being cropped out). Press  to save the retouched copy.

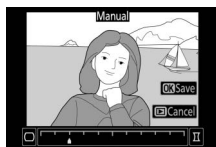

Perspective Control

MENU button →  (retouch menu)

Create copies that reduce the effects of perspective in photos taken looking up from the base of a tall object. Use the multi selector to adjust perspective (note that greater amounts of perspective control result in more of the edges being cropped out). The results can be previewed in the edit display. Press  to save the retouched copy.

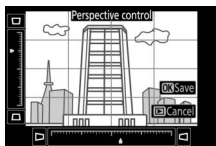

Before



After

Image Overlay

MENU button →  (retouch menu)

Image overlay combines two existing NEF (RAW) photographs to create a new picture that is saved separately from the originals.



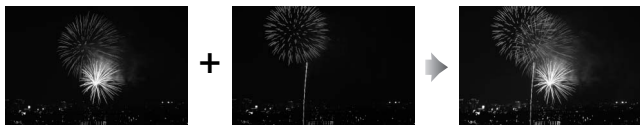
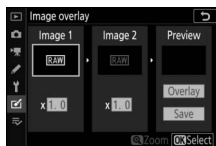

1 Select Image overlay.

Highlight **Image overlay** in the retouch menu and press . Image overlay options will be displayed, with **Image 1** highlighted; press  to display a picture selection dialog listing only large NEF (RAW) images created with this camera (small and medium NEF/RAW images cannot be selected).



2 Select the first image.

Use the multi selector to highlight the first photograph in the overlay. To view the highlighted photograph full frame, press and hold the  button. Press  to select the highlighted photograph and return to the preview display.

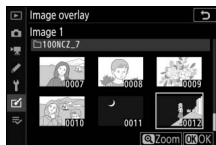

3 Select the second image.

The selected image will appear as **Image 1**. Highlight **Image 2** and press **OK**, then select the second photo as described in Step 2.

4 Adjust gain.

Highlight **Image 1** or **Image 2** and optimize exposure for the overlay by pressing **▲** or **▼** to select the gain from values between 0.1 and 2.0. Repeat for the second image. The default value is 1.0; select 0.5 to halve gain or 2.0 to double it. The effects of gain are visible in the **Preview** column.

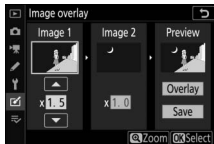

5 Preview the overlay.

To preview the composition, press **◀** or **▶** to place the cursor in the **Preview** column, then press **▲** or **▼** to highlight **Overlay** and press **OK** (note that colors and brightness in the preview may differ from the final image). To save the overlay without displaying a preview, select **Save**. To return to Step 4 and select new photos or adjust gain, press **Q** (?).



6 Save the overlay.

Press **OK** while the preview is displayed to save the overlay. After an overlay is created, the resulting image will be displayed full-frame.



Image Overlay

Only large NEF (RAW) photographs with the same image area and bit-depth can be combined. The overlay is saved in JPEG fine★ format and has the same photo info (including date of recording, metering, shutter speed, aperture, shooting mode, exposure compensation, focal length, and image orientation) and values for white balance and Picture Control as the photograph selected for **Image 1**. The current image comment is appended to the overlay when it is saved; copyright information, however, is not copied.

Trim Movie

MENU button →  (retouch menu)

Create a copy from which unwanted footage has been removed ( 137).

Side-by-Side Comparison

(see below)

Compare retouched copies to the original photographs. This option can only be accessed by pressing the  button and selecting **Retouch** when a copy or original is displayed.

- 1 Select a retouched copy (shown by a  icon) or an original that has been retouched.





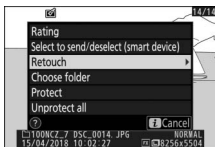

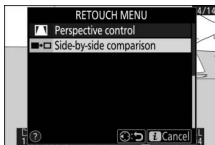

- 2 Display retouch options.
Press  and select **Retouch**.



- 3 Select **Side-by-side comparison**.
Highlight **Side-by-side comparison** and press .



4 Compare the copy with the original.

The source image is displayed on the left, the retouched copy on the right, with the options used to create the copy listed at the top of the display. Press  or  to switch between the source image and the retouched copy. To view the highlighted picture full frame, press and hold the  button. If the copy was created from two source images using **Image overlay**, or if the source has been copied multiple times, press  or  to view the other images. To exit to playback, press the  button, or press  to exit to full-frame playback with the highlighted image displayed.

Options used to create copy

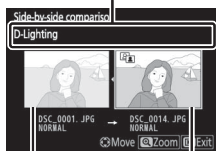

Source image

Retouched copy

Side-by-Side Comparison

The source image will not be displayed if the copy was created from a photograph that was protected or has since been deleted.

☰ My Menu/☰ Recent Settings

To view My Menu, select the ☰ tab in the camera menus.



The **MY MENU** option can be used to create and edit a customized list of up to 20 items from the playback, photo shooting, movie shooting, Custom Settings, setup, and retouch menus. If desired, recent settings can be displayed in place of My Menu.

Options can be added, deleted, and reordered as described below.

Adding Options to My Menu

1 Select **Add items**.

In My Menu (☰), highlight **Add items** and press **▶**.

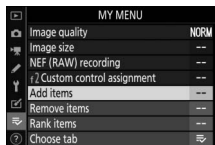

2 Select a menu.

Highlight the name of the menu containing the option you wish to add and press **▶**.

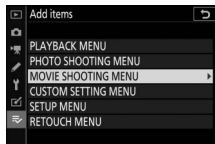

3 Select an item.

Highlight the desired menu item and press **OK**.

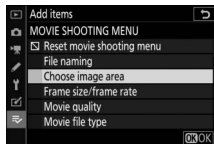

4 Position the new item.

Press **▲** or **▼** to move the new item up or down in My Menu. Press **OK** to add the new item.

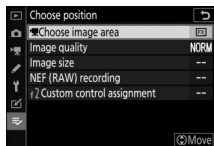

5 Add more items.

The items currently displayed in My Menu are indicated by a check mark. Items indicated by a **☒** icon cannot be selected. Repeat Steps 1–4 to select additional items.

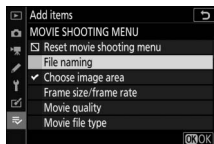

Deleting Options from My Menu

1 Select Remove items.

In My Menu (⇨), highlight **Remove items** and press (⏏).

2 Select items.

Highlight items and press (⏏) to select or deselect. Selected items are indicated by a check mark.

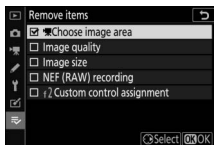

3 Delete the selected items.

Press (⏏). A confirmation dialog will be displayed; press (⏏) again to delete the selected items.

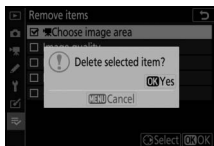

✓ Deleting Items in My Menu

To delete the item currently highlighted in My Menu, press the (⏏) button. A confirmation dialog will be displayed; press (⏏) again to remove the selected item from My Menu.

Reordering Options in My Menu

1 Select Rank items.



In My Menu (≡), highlight **Rank items** and press .

2 Select an item.

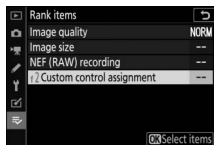
Highlight the item you wish to move and press .



3 Position the item.

Press  or  to move the item up or down in My Menu and press . Repeat Steps 2–3 to reposition additional items.



4 Exit to My Menu.

Press the **MENU** button to return to My Menu.

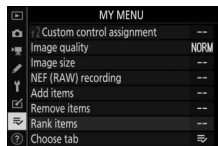
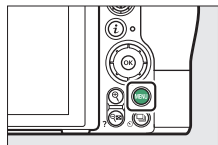

Recent Settings

To display the twenty most recently used settings, select **RECENT SETTINGS** for **MY MENU** > **Choose tab**.

1 Select **Choose tab**.

In My Menu (⇨), highlight **Choose tab** and press (⏎).

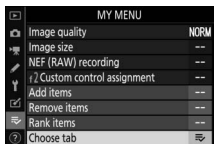

2 Select **RECENT SETTINGS**.

Highlight **RECENT SETTINGS** and press (⏎). The name of the menu will change from "MY MENU" to "RECENT SETTINGS."

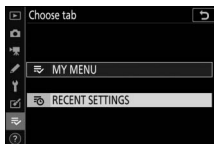

Menu items will be added to the top of the recent settings menu as they are used. To view My Menu again, select **MY MENU** for **RECENT SETTINGS** > **Choose tab**.

✓ Removing Items from the Recent Settings Menu

To remove an item from the recent settings menu, highlight it and press the (🗑️) button. A confirmation dialog will be displayed; press (⏎) again to delete the selected item.

Connections

Expand your photographic horizons by connecting the camera to smartphones or tablets (smart devices), computers or ftp servers, or printers or HDMI devices.

Connecting to Smart Devices

Use SnapBridge to control the camera remotely from a smart device and download pictures from the camera.

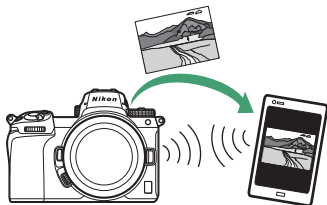

SnapBridge is available free-of-charge from the Apple App Store® and on Google Play™.



Visit the Nikon website for the latest SnapBridge news. For more information on connecting to the camera and using the SnapBridge app, see SnapBridge online help.

Wireless Connections

For information on establishing wireless connections to computers or smart devices, see the *Network Guide*, available from the Nikon Download Center:

Z7: https://downloadcenter.nikonimglib.com/en/products/492/Z_7.html

Z6: https://downloadcenter.nikonimglib.com/en/products/493/Z_6.html

Connecting to Computers

To upload pictures to a computer, connect the camera via a wireless network or using the supplied USB cable.

Connecting via USB

If the supplied USB cable is used to connect the camera to a computer running ViewNX-i, you can copy pictures to the computer, where they can be viewed, edited, and organized.

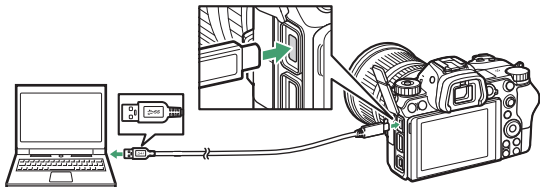

■ ■ *Installing ViewNX-i*

Download the ViewNX-i installer from the following website and follow the on-screen instructions to complete installation (existing users should be sure to download the latest version, as earlier versions may not support the camera). An Internet connection is required. For system requirements and other information, see the Nikon website for your region.

<https://downloadcenter.nikonimglib.com/>

✓ **Capture NX-D**

Use Nikon's Capture NX-D software to fine-tune photos or to change settings for NEF (RAW) pictures and save them in other formats.

Capture NX-D is available for download from:

<https://downloadcenter.nikonimglib.com/>

■ Copying Pictures to the Computer

For detailed instructions, see the online help for ViewNX-i.

1 Connect the USB cable.

After turning the camera off and ensuring that a memory card is inserted, connect the supplied USB cable as shown.

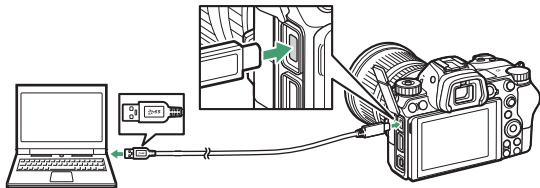

✓ USB Hubs

Connect the camera directly to the computer; do not connect the cable via a USB hub or keyboard.

✓ Use a Reliable Power Source

To ensure that data transfer is not interrupted, be sure the camera battery is fully charged.

✓ Connecting Cables

Be sure the camera is off when connecting or disconnecting interface cables. Do not use force or attempt to insert the connectors at an angle.

2 Turn the camera on.

The Nikon Transfer 2 component of ViewNX-i will start (if a message is displayed prompting you to choose a program, select Nikon Transfer 2). If Nikon Transfer 2 does not start automatically, launch ViewNX-i and click the “Import” icon.

✓ Windows 7

If the following dialog is displayed, select Nikon Transfer 2 as described below.

- 1 Under **Import pictures and videos**, click **Change program**. A program selection dialog will be displayed; select Nikon Transfer 2 and click **OK**.

- 2 Double-click .



✓ Windows 10 and Windows 8.1

Windows 10 and Windows 8.1 may display an AutoPlay prompt when the camera is connected. Tap or click the dialog and then tap or click **Nikon Transfer 2** to select Nikon Transfer 2.

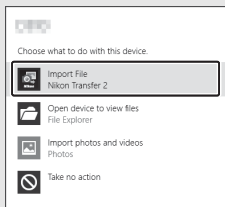
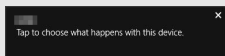

✓ macOS/OS X

If Nikon Transfer 2 does not start automatically, confirm that the camera is connected and then launch Image Capture (an application that comes with macOS or OS X) and select Nikon Transfer 2 as the application that opens when the camera is detected.

3 Click **Start Transfer**.

Pictures on the memory card will be copied to the computer.

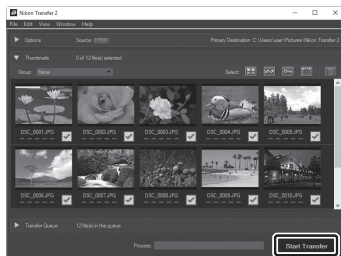

*Click **Start Transfer***

✔ **Transferring Movies**

Do not attempt to transfer movies from the memory card while it is inserted in another camera. Doing so could result in the movies being deleted without being transferred.

✔ **During Transfer**

Do not turn the camera off or disconnect the USB cable while transfer is in progress.

4 Turn the camera off.

Turn the camera off and disconnect the USB cable when transfer is complete.

Wireless Networks (Wi-Fi)

The following methods can be used to connect to a computer via Wi-Fi. For more information, see the *Network Guide*.

■ ■ Built-in Wi-Fi

Use the **Connect to PC** option in the camera setup menu to connect to computers either directly or via a wireless router.



Connection via a wireless router



Direct wireless connection

■ ■ The WT-7 Wireless Transmitter

When the camera is connected to an optional WT-7 wireless transmitter, the **Wireless transmitter (WT-7)** option in the setup menu can be used for connection to computers or ftp servers.

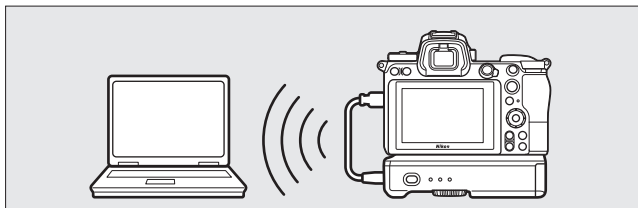

Use the WT-7 for connection to Ethernet networks and for more reliable connections to wireless networks. With Camera Control Pro 2 (available separately), the camera can be controlled remotely and pictures saved directly to the computer as they are taken.

Connecting to Printers

Selected JPEG images can be printed on a PictBridge printer connected directly to the camera using the supplied USB cable. When connecting the cable, do not use force or attempt to insert the connectors at an angle.

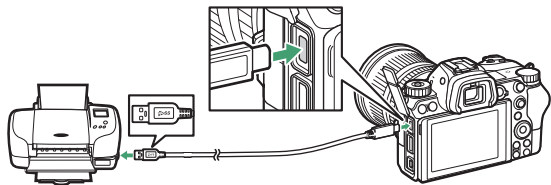

When the camera and printer are turned on, a welcome screen will be displayed, followed by a PictBridge playback display.

✔ Selecting Photographs for Printing

Images created at image quality settings of NEF (RAW) or TIFF (RGB) cannot be selected for printing. JPEG copies of NEF (RAW) images can be created using the **NEF (RAW) processing** option in the retouch menu.

✔ Printing Via Direct USB Connection







Be sure the battery is fully charged or use an AC adapter and power connector (available separately). When taking photographs to be printed via direct USB connection, set **Color space** to **sRGB**.

✔ See Also





See “Error Messages” (📖 398) for information on what to do if an error occurs during printing.







Printing Pictures One at a Time

1 Display the desired picture.

Press  or  to view additional pictures. Press the  button to zoom in on the current frame (press  to exit zoom). To view six pictures at a time, press the  (?) button. Use the multi selector to highlight pictures, or press the  button to display the highlighted picture full frame.

2 Adjust printing options.

Press  to display the following items, then press  or  to highlight an item and press  to view options (only options supported by the current printer are listed; to use the default option, select **Printer default**). After selecting an option, press  to return to the printer settings menu.

- **Page size:** Choose a page size.
- **No. of copies:** This option is listed only when pictures are printed one at a time. Press  or  to choose number of copies (maximum 99).
- **Border:** Choose whether to frame photos in white borders.
- **Print date:** Choose whether to print the dates of recording on photos.
- **Cropping:** This option is listed only when pictures are printed one at a time. To exit without cropping, highlight **No cropping** and press . To crop the current picture, highlight **Crop** and press . A crop selection dialog will be displayed; press  to increase the size of the crop,  (?) to decrease, and use the multi selector to position the crop. Note that print quality may drop if small crops are printed at large sizes.

3 Start printing.

Select **Start printing** and press **OK** to start printing. To cancel printing before all copies have been printed, press **OK**.

Printing Multiple Pictures

1 Display the PictBridge menu.

Press the **MENU** button in the PictBridge playback display.

2 Choose an option.

Highlight one of the following options and press **OK**.

- **Print select:** Select pictures for printing. Press **Left** or **Right** to scroll through pictures (to view the highlighted picture full screen, press and hold the **OK** button) and press **Up** or **Down** to choose the number of prints. To deselect a picture, set the number of prints to zero.
- **Index print:** Create an index print of all JPEG pictures on the memory card. Note that if the memory card contains more than 256 pictures, only the first 256 images will be printed. A warning will be displayed if the page size selected in Step 3 is too small for an index print.

3 Adjust printing options.

Adjust printer settings as described in Step 2 of "Printing Pictures One at a Time" (□ 345).

4 Start printing.

Select **Start printing** and press **OK** to start printing. To cancel printing before all copies have been printed, press **OK**.

Connecting to HDMI Devices

The optional High-Definition Multimedia Interface (HDMI) cable (📖 415) or a type C HDMI cable (available separately from third-party suppliers) can be used to connect the camera to high-definition video devices. Always turn the camera off before connecting or disconnecting an HDMI cable.

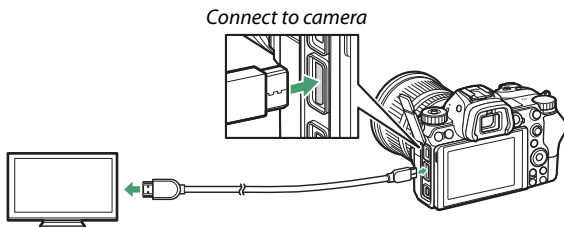

*Connect to high-definition device
(choose cable with connector for
HDMI device)*

■ ■ HDMI Displays



After connecting the camera to an HDMI television or other display, tune the device to the HDMI channel, then turn the camera on and press the  button. During playback, images will be displayed on the television screen. Volume can be adjusted using television controls; the camera controls cannot be used.

HDMI Recorders

The camera can record video directly to connected HDMI recorders. Some recorders will even start and stop recording in response to camera controls. Use the **HDMI** option in the setup menu to adjust settings for HDMI output.



- **Output Resolution:** Choose the format for images output to the HDMI device. If **Auto** is selected, the camera will automatically select the appropriate format.
- **Advanced:** Adjust the settings below.
 - **Output range:** **Auto** is recommended in most situations. If the camera is unable to determine the correct RGB video signal output range for the HDMI device, you can choose **Limited range** for devices with an RGB video signal input range of 16 to 235 or **Full range** for devices with an RGB video signal input range of 0 to 255. Choose **Limited range** if you notice a loss of detail in shadows, **Full range** if shadows are “washed out” or too bright.

- **External recording control:** Enabling external recording control allows camera controls to be used to start and stop recording when the camera is connected via HDMI to a third-party recorder that supports the Atomos Open Protocol (Atomos SHOGUN, NINJA, or SUMO-series Monitor recorders). An icon will be displayed in the camera monitor:  **STBY** is displayed in movie live view, while  **REC** is displayed during movie recording. During recording, check the recorder and recorder display to ensure that footage is being saved to the device (note that the footage output to the device may be disrupted while external recording control is in effect). The camera display will turn off automatically when the standby timer expires, ending HDMI output; when recording movies to an external device, select **Standby timer** for Custom Setting c3 (**Power off delay**) and choose **No limit** or a time longer than the anticipated recording time. See the manual provided with the recorder for more information on device features and operation.
- **Output data depth:** Choose from **8 bit** and **10 bit**.

- **N-Log setting:** Select **On (cannot record to card)** to preserve details in highlights and shadows and avoid over-saturated colors when recording movies. Choose this option (available only when **10 bit** is selected for **Output data depth**) when recording footage that will later be color-corrected. The footage will be recorded directly to the external device and cannot be saved to the camera memory card. The **ISO sensitivity settings > Maximum sensitivity** and **ISO sensitivity (Mode M)** options in the movie shooting menu can be set respectively to values of from ISO 1600 to 25600 (Z 7) or 51200 (Z 6) and ISO 800 to 25600 (Z 7) or 51200 (Z 6).
- **View assist:** Choose **On** for a live preview of video footage recorded with **On (cannot record to card)** selected for **N-Log setting**. The colors in the preview will differ from those of the final movie, but this has no effect on the footage actually recorded.

✔ HDMI Output

HDMI output is not available while movies are being recorded at movie frame sizes of 1920 × 1080 120p, 1920 × 1080 100p, or 1920 × 1080 slow-motion or when the camera is connected to a computer running Camera Control Pro 2.

✔ 10-Bit Output Data Depth

10 bit can be used only with compatible recorders. Regardless of the display mode selected, the camera monitor will turn on and the viewfinder will remain blank. No photos can be taken; during movie recording, the following additional restrictions apply when 3840 × 2160 is selected for frame size:

- Movies are not recorded to memory cards inserted in the camera.
- Icons and characters in the monitor will display at low resolution.
- Selecting the DX image area on the Z 7 reduces the angle of view to about 90%. The angle of view on the Z 6 is always about 90%.

✔ Zoom

Movies filmed at a frame size of 3840 × 2160 are displayed at a size of 1920 × 1080 when zoomed in.

On-Camera Flash Photography

The camera can be used with optional external flash units.

- When using a flash, select **Off** for **Silent photography** in the photo shooting menu.

“On-Camera” Versus “Remote”

You can take pictures using a flash unit mounted on the camera accessory shoe or one or more remote flash units.

Camera-Mounted Flash Units

Take pictures using a flash unit mounted on the camera as described in “Using an On-Camera Flash” (📖 352).

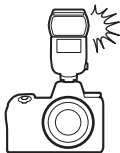

Remote Flash Photography

Take pictures with one or more remote flash units using wireless flash control (Advanced Wireless Lighting, or AWL) as described in “Remote Flash Photography” (📖 364).



Using an On-Camera Flash

Follow the steps below to mount an optional flash unit on the camera and take photographs using the flash.

1 Mount the unit on the accessory shoe.

See the manual provided with the unit for details.

✔ Use Only Nikon Flash Accessories

Use only Nikon flash units. Negative voltages or voltages over 250 V applied to the accessory shoe could not only prevent normal operation, but damage the sync circuitry of the camera or flash.

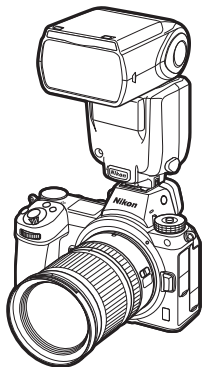

2 Turn on the camera and flash unit.

The flash will begin charging; the flash-ready indicator (⚡) will be displayed when charging is complete.

3 Adjust flash settings.

Choose the flash control mode (□ 354) and flash mode (□ 356).

4 Adjust shutter speed and aperture.

5 Take pictures.

✔ Shutter Speed

Shutter speed can be set as follows when an optional flash unit is used:

Mode	Shutter speed
	Set automatically by camera ($1/200$ s– $1/60$ s)
P, A	Set automatically by camera ($1/200$ s– $1/60$ s)*
S	Value selected by user ($1/200$ s–30 s)
M	Value selected by user ($1/200$ s–30 s, Bulb, Time)

* Shutter speed may be set as slow as 30 s if slow sync, slow rear-curtain sync, or slow sync with red-eye reduction is selected for flash mode.

Flash Control Mode

When a flash unit that supports unified flash control (an SB-5000, SB-500, SB-400, or SB-300) is mounted on the camera, the flash control mode, flash level, and other flash settings can be adjusted using the **Flash control > Flash**

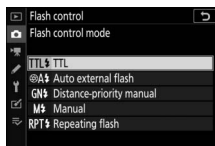

control mode item in the photo shooting menu (in the case of the SB-5000, these settings can also be adjusted using the controls on the flash unit). The options available vary with the flash used, while the options displayed under **Flash control mode** vary with the mode selected. Settings for other flash units can only be adjusted using flash unit controls.

- **TTL:** i-TTL mode. In the cases of the SB-500, SB-400, and SB-300, flash compensation can be adjusted using the **Flash compensation** item in the photo shooting menu.
- **Auto external flash:** In this mode, output is adjusted automatically according to the amount of light reflected by the subject; flash compensation is also available. Auto external flash supports “auto aperture” (Ⓐ) and “non-TTL auto” (A) modes. See the flash unit manual for details.
- **Distance-priority manual:** Choose the distance to the subject; flash output will be adjusted automatically. Flash compensation is also available.
- **Manual:** Choose the flash level manually.

- **Repeating flash:** The flash fires repeatedly while the shutter is open, producing a multiple-exposure effect. Choose the flash level (**Output**), the maximum number of times the unit fires (**Times**), and the number of times the flash fires per second (**Frequency**, measured in Hertz). The options available for **Times** vary depending on the options selected for **Output** and **Frequency**; see the documentation provided with the flash unit for details.

✓ **Unified Flash Control**

Unified flash control allows the camera and flash unit to share settings. If a flash unit that supports unified flash control is mounted on the camera, changes to flash settings made with either the camera or flash unit are reflected on both devices, as are changes made using optional Camera Control Pro 2 software.





✓ **i-TTL Flash Control**



When a CLS-compatible flash unit is set to TTL, the camera automatically selects one of the following types of flash control:

- **i-TTL balanced fill-flash:** The flash unit emits a series of nearly invisible preflashes (monitor preflashes) immediately before the main flash. The camera analyzes preflashes reflected from objects in all areas of the frame and adjusts flash output for a natural balance between the main subject and ambient background lighting.
- **Standard i-TTL fill-flash:** Flash output is adjusted to bring lighting in the frame to standard level; the brightness of the background is not taken into account. Recommended for shots in which the main subject is emphasized at the expense of background details, or when exposure compensation is used. Standard i-TTL fill-flash is activated automatically when spot metering is selected.

Flash Modes

Use the **Flash mode** option in the photo shooting menu to choose the flash mode. The options available depend on the mode selected with the mode dial.

Option	Description	Available in
 Fill flash (front-curtain sync)	The flash fires with every shot. In modes P and A , shutter speed will automatically be set to values between $\frac{1}{200}$ s (or $\frac{1}{8000}$ s with Auto FP High-Speed Sync) and $\frac{1}{60}$ s.	AUTO, P, S, A, M
 Red-eye reduction (red-eye reduction)	Use for portraits. The flash fires with every shot, but before it fires, the red-eye reduction lamp on the flash unit or camera lights to reduce "red-eye" (a flash unit with red-eye reduction is required). Not recommended with moving subjects or in other situations in which quick shutter response is required. Do not move camera during shooting.	
 Slow sync + red-eye (red-eye reduction with slow sync)	As for Red-eye reduction except that shutter speed slows automatically to capture background lighting at night or under low light. Use when you want to include background lighting in portraits. Use of a tripod is recommended to prevent blurring caused by camera shake.	P, A
 Slow sync (slow sync)	As for Fill flash except that shutter speed slows automatically to capture background lighting at night or under low light. Use when you want to capture both subject and background. Use of a tripod is recommended to prevent blurring caused by camera shake.	

Option	Description	Available in
 Rear-curtain sync (rear-curtain sync)	The flash fires just before the shutter closes, creating the effect of a stream of light behind moving light sources. Use of a tripod is recommended to prevent blurring caused by camera shake. Selecting P or A after choosing this option sets the flash mode to Slow sync . Note that this option cannot be used with studio flash systems, as the correct synchronization cannot be obtained.	P, S, A, M
 Flash off	The flash does not fire.	<small>AUTO</small>  P, S, A, M

Flash Compensation

Flash compensation is used to alter flash output by from -3 EV to $+1$ EV in increments of $\frac{1}{3}$ EV, changing the brightness of the main subject relative to the background. Flash output can be increased to make the main subject appear brighter, or reduced to prevent unwanted highlights or reflections. In general, choose positive values to make the main subject brighter, negative values to make it darker.

To choose a value for flash compensation, use the **Flash compensation** item in the photo shooting menu. At values other than ± 0.0 , a  icon will appear in the display and the control panel.



Normal flash output can be restored by setting flash compensation to ± 0.0 . Flash compensation is not reset when the camera is turned off.

FV Lock

This feature is used to lock flash output, allowing photographs to be recomposed without changing the flash level and ensuring that flash output is appropriate to the subject even when the subject is not positioned in the center of the frame. Flash output is adjusted automatically for any changes in ISO sensitivity and aperture. FV lock is not available in **AUTO** mode.

To use FV lock:

1 Assign FV lock to a camera control.

Assign **FV lock** to a control using Custom Setting f2 (**Custom control assignment**).

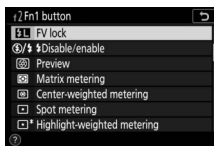

2 Attach a CLS-compatible flash unit.

Mount a CLS-compatible flash unit on the camera accessory shoe.

3 Set the flash unit to the appropriate mode.

Turn the flash unit on and select **TTL** or **Auto external flash** for **Flash control > Flash control mode** (SB-5000, SB-500, SB-400, or SB-300) or set the flash control mode to TTL, monitor pre-flash **ⓈA**, or monitor pre-flash A (other flash units; see the documentation provided with the flash unit for details).

4 Focus.

Position the subject in the center of the frame and press the shutter-release button halfway to focus.



5 Lock flash level.

After confirming that the flash-ready indicator (⚡) appears in the camera display, press the control selected in Step 1. The flash unit will emit a monitor pre-flash to determine the appropriate flash level. Flash output will be locked at this level and FV lock icon (FV) will appear in the camera display.



6 Recompose the photograph.

Flash output will remain locked at the value metered in Step 5.



7 Take the photograph.

Press the shutter-release button the rest of the way down to shoot. If desired, additional pictures can be taken without releasing FV lock.

8 Release FV lock.

Press the control selected in Step 1 to release FV lock. Confirm that the FV lock icon (FV) is no longer displayed.

Flash Info for On-Camera Units

When a unit that supports unified flash control (the SB-5000, SB-500, SB-400, or SB-300) is mounted on the camera accessory shoe, flash info can be viewed in the camera display by pressing the **DISP** button in photo mode (☰ 15). The information displayed varies with the flash control mode.

TTL

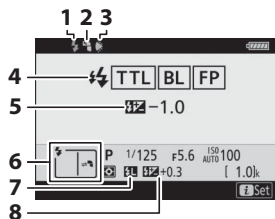

1	Flash-ready indicator	352
2	Bounce icon (displayed if flash head is tilted upwards)	
3	Zoom head position warning (displayed if zoom head is not in correct position)	
4	Flash control mode	188, 354
	FP indicator	267
5	Flash compensation (TTL)	354
6	Flash mode	356
7	FV lock indicator	359
8	Flash compensation	358

Auto External Flash

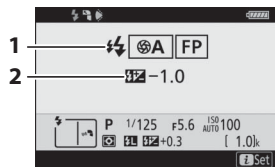

1	Flash control mode	188, 354
	FP indicator	267
2	Auto external flash compensation	354

Distance-Priority Manual

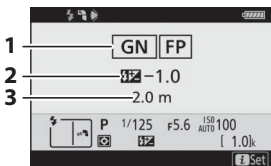

- 1 Flash control mode 188, 354
Flash indicator 267
- 2 Flash compensation
(distance-priority manual)..... 354
- 3 Distance 354

Manual

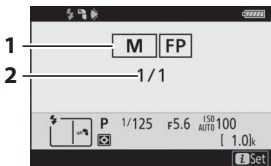

- 1 Flash control mode 188, 354
Flash indicator 267
- 2 Flash level 354

Repeating Flash

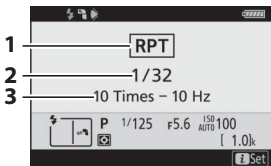

- 1 Flash control mode 188, 354
- 2 Flash level (output) 354
- 3 Number emitted (times) 354
Frequency 354

✓ Flash Info and Camera Settings

The flash information display shows selected camera settings, including shooting mode, shutter speed, aperture, and ISO sensitivity.



✓ Changing Flash Settings

Flash settings can be changed by pressing the **i** button in the flash info display. The options available vary with the flash unit and the settings selected. You can also test-fire the flash.

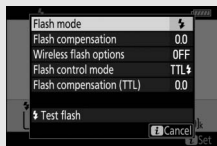

Remote Flash Photography

The camera can be used with one or more remote flash units (Advanced Wireless Lighting, or AWL). For information on using a flash unit mounted on the camera accessory shoe, see “On-Camera Flash Photography” (📖 351).

Throughout this chapter, operations involving an accessory connected to the camera are indicated by 📷, operations involving remote flash units by 📷. For more information on 📷, see the manual provided with the flash unit.

Using Remote Flash Units

Remote flash units can be controlled via optical signals from a flash unit mounted on the camera accessory shoe (*optical AWL*) or via radio signals from a WR-R10 (available separately) connected to the camera (*radio AWL*). These forms of flash control can be combined as follows:

- Radio AWL with one or more remote flash units (📖 366)

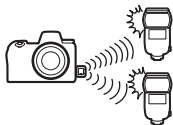

- Optical AWL with one or more remote flash units (📖 377)

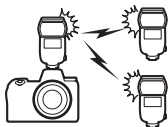

- Radio AWL with additional lighting provided by a shoe-mounted flash unit (📖 376)



- Radio AWL combined with optical AWL provided by a shoe-mounted flash unit (📖 385)

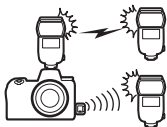

Radio AWL

Radio AWL is available with SB-5000 flash units. Attach a WR-R10 wireless remote controller to the camera and establish a wireless connection between the flash units and the WR-R10.

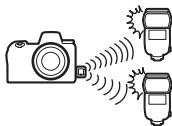

Establishing a Wireless Connection

Before using radio AWL, establish a wireless connection between the WR-R10 and the remote flash units.

1 **Connect the WR-R10.**

For more information, see the documentation provided with the WR-R10.

2 **Select Radio AWL.**

Select **Radio AWL** for **Flash control** > **Wireless flash options** in the photo shooting menu.

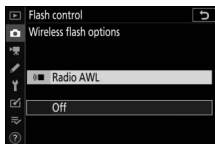

The WR-R10 Wireless Remote Controller

Be sure to update the WR-R10 firmware to version 3.0 or later; for information on firmware updates, see the Nikon website for your area.

3 Choose a channel.

Set the WR-R10 channel selector to the desired channel.

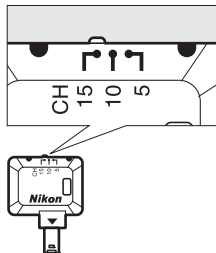

4 Choose a link mode.

Select **Wireless remote (WR) options** > **Link mode** in the setup menu and choose from the following options:

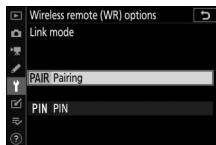

- **Pairing:** The camera connects only to devices with which it has previously been paired, preventing signal interference from other devices in the vicinity. Given that each device must be paired separately, **PIN** is recommended when connecting to a large number of devices.
- **PIN:** Communication is shared among all devices with the same four-digit PIN, making this a good choice for photography featuring a large number of remote devices. If there are multiple cameras present that share the same PIN, the flash units will be under the sole control of the camera that connects first, preventing all other cameras from connecting (the LEDs on the WR-R10 units connected to the affected cameras will blink).

5 : Establish a wireless connection.

Set the remote flash units to radio AWL remote mode and set the devices to the channel you selected in Step 3, then pair each of the remote units with the WR-R10 according to the option selected in Step 4:

- **Pairing:** Initiate pairing on the remote unit and press the WR-R10 pairing button. Pairing is complete when the **LINK** lamps on the WR-R10 and flash unit flash orange and green; once a connection is established, the **LINK** lamp on the remote flash unit will light green.
- **PIN:** Use the controls on the remote flash unit to enter the PIN you selected in Step 4. The **LINK** lamp on the remote unit will light green once a connection is established.

6 : Confirm that the flash-ready lights for all flash units are lit.

In radio AWL, the flash-ready indicator will light in the camera display when all flash units are ready.

Listing Remote Flash Units

To view the flash units currently controlled using radio AWL, select **Flash control > Radio remote flash info** in the photo shooting menu. The identifier (remote flash unit name) for each unit can be changed using flash unit controls.

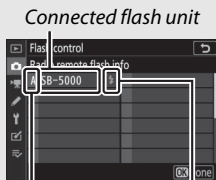

Group

Flash-ready indicator

 **Reconnecting**

As long as the channel, link mode, and other settings remain the same, the WR-R10 will automatically connect to previously paired flash units when you select remote mode and Steps 3–5 can be omitted. The flash unit **LINK** lamp lights green when a connection is established.

Adjusting Flash Settings

After selecting **Radio AWL** for **Flash control** > **Wireless flash options** in the photo shooting menu, select **Group flash**, **Quick wireless control**, or **Remote repeating** for **Remote flash control** and adjust settings as described below.

■ Group Flash

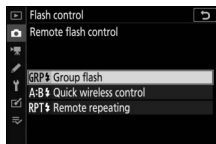

Select this option to adjust settings separately for each group.

- 1** : **Select Group flash.**
Select **Group flash** for **Flash control** > **Remote flash control** in the photo shooting menu.

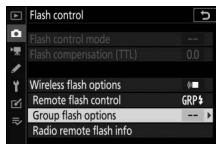

- 2** : **Select Group flash options.**
Highlight **Group flash options** in the flash control display and press .



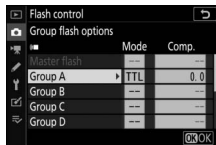

- 3** : **Choose the flash control mode.**
Choose the flash control mode and flash level for the master flash and the flash units in each group:
 - **TTL**: i-TTL flash control
 -  **A**: Auto aperture (available only with compatible flash units)
 - **M**: Choose the flash level manually
 - **-- (off)**: The units do not fire and the flash level cannot be adjusted



4 : Group the remote flash units.

Choose a group (A–F) for each of the remote flash units. The master flash can control up to 18 flash units in any combination.

5 /: Compose the shot.

Compose the shot and arrange the flash units. See the documentation provided with the flash units for more information. After arranging the units, press the  button in the flash info display ( 388) and select  **Test flash** to test-fire the units and confirm that they are functioning normally.



6 : Take the photograph.

■ Quick Wireless Control

Select this option to control overall flash compensation for, and the relative balance between, groups A and B, while setting output for group C manually.

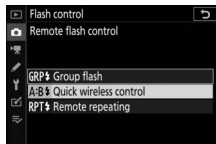
- 1** : Select **Quick wireless control**.
Select **Quick wireless control** for **Flash control > Remote flash control** in the photo shooting menu.



- 2** : Select **Quick wireless control options**.
Highlight **Quick wireless control options** in the flash control display and press .

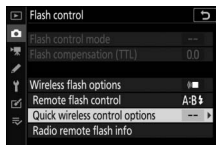

- 3** : Adjust flash settings.
Choose the balance between groups A and B.

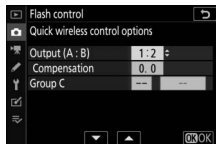

Adjust flash compensation for groups A and B.

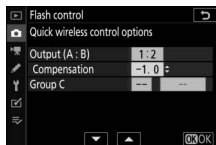

Choose a flash control mode and flash level for the units in group C:

- **M**: Choose the flash level manually.
- --: The units in group C do not fire.

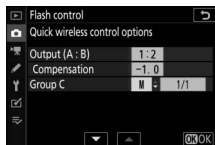

4 : Group the remote flash units.

Choose a group (A, B, or C). The master flash can control up to 18 flash units in any combination.

5 : Compose the shot.

Compose the shot and arrange the flash units. See the documentation provided with the flash units for more information. After arranging the units, press the **i** button in the flash info display (📖 388) and select **⚡ Test flash** to test fire the units and confirm that they are functioning normally.



6 : Take the photograph.

■ Remote Repeating

When this option is selected, the flash units fire repeatedly while the shutter is open, producing a multiple-exposure effect.

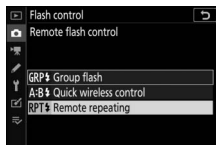
- 1** : **Select Remote repeating.**
Select **Remote repeating** for **Flash control** > **Remote flash control** in the photo shooting menu.



- 2** : **Select Remote repeating options.**
Highlight **Remote repeating options** in the flash control display and press .

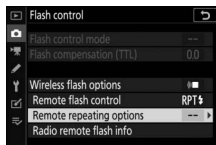

- 3** : **Adjust flash settings.**
Choose the flash level (**Output**), the maximum number of times the flash units fire (**Times**), and the number of times the flash units fire per second (**Frequency**).

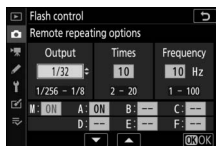

Enable or disable selected groups. Select **ON** to enable the selected group, -- to disable the selected group.

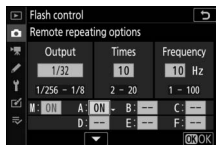

- 4** : **Group the remote flash units.**
Choose a group (A–F) for each of the remote flash units. The master flash can control up to 18 flash units in any combination.

5 : Compose the shot.

Compose the shot and arrange the flash units. See the documentation provided with the flash units for more information. After arranging the units, press the **i** button in the flash info display (📖 388) and select **⚡ Test flash** to test-fire the units and confirm that they are functioning normally.

6 : Take the photograph.

Adding a Shoe-Mounted Flash Unit

Radio-controlled flash units can be combined with any of the following flash units mounted on the camera accessory shoe:

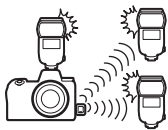

- **SB-5000:** Before attaching the flash unit, set it to radio-controlled master flash mode (a  icon will appear at the top left corner of the display) and choose group or remote repeating flash control. Once the unit is attached, settings can be adjusted using the controls on the flash unit or the options listed in the camera menus under **Group flash options > Master flash** or under “M” in the **Remote repeating options** display.
- **SB-910, SB-900, SB-800, SB-700, SB-600:** Configure the flash for standalone use and use the controls on the flash unit to adjust flash settings.
- **SB-500, SB-400, SB-300:** Mount the unit on the camera and adjust settings using the camera **Group flash options > Master flash** option.

Optical AWL

Remote flash units can be controlled via optical signals from an optional flash unit mounted on the camera accessory shoe and functioning as a master flash (optical AWL; for information on compatible flash units, see

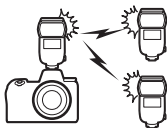

“The Nikon Creative Lighting System”, □ 410). If the flash unit in question is an SB-5000 or SB-500, settings can be adjusted from the camera (see below); otherwise settings must be adjusted using flash unit controls as described in the documentation provided with the unit. For information on flash placement and other topics, see the documentation provided with the flash units.

Using Optical AWL with the SB-5000 or SB-500

Mount the flash unit on the camera accessory shoe and select **Optical AWL for Flash control > Wireless flash options** in the photo shooting menu.

Group flash settings can be adjusted using **Flash control > Remote flash control**;

the **Remote flash control** item for the SB-5000 also offers **Quick wireless control** and **Remote repeating** settings.

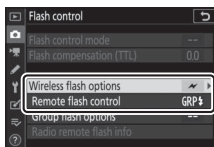

✓ The SB-5000

When an SB-5000 is mounted on the camera accessory shoe, **Flash control** settings can also be changed using the controls on the flash unit.

■ Group Flash

Select this option to adjust settings separately for each group.

- 1** : **Select Group flash.**
Select **Group flash** for **Flash control** > **Remote flash control** in the photo shooting menu.

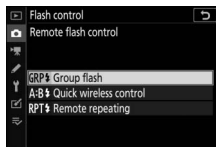

- 2** : **Select Group flash options.**
Highlight **Group flash options** in the flash control display and press .

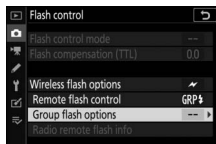

- 3** : **Adjust settings for the master flash.**
Choose the flash control mode and flash level for the master flash and the flash units in each group:

- **TTL**: i-TTL flash control
- **A**: Auto aperture (available only with compatible flash units)
- **M**: Choose the flash level manually
- **-- (off)**: The units do not fire and the flash level cannot be adjusted

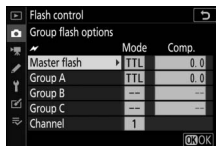

Choose a channel for the master flash. If the remote flash units include an SB-500, you must choose channel 3, but otherwise you can choose any channel between 1 and 4.

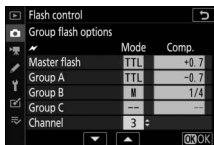



4 : Set the remote flash units to the same channel as the master flash.

Set the remote flash units to the channel selected in Step 3.

5 : Group the remote flash units.

Choose a group (A, B, or C, or if you are using an SB-500 master flash, A or B) for each remote flash unit. Although there is no limit on the number of remote flash units that may be used, the practical maximum is three per group. With more than this number, the light emitted by the remote flash units will interfere with performance.

6 : Compose the shot.

Compose the shot and arrange the flash units. See the documentation provided with the flash units for more information. After arranging the units, press the test button on the master flash to test-fire the flash and confirm that the units are functioning normally. Flash units can also be test-fired by pressing the  button in the flash info display (388) and selecting  **Test flash**.

7 : Take the photograph.



Take the photograph after confirming that the flash-ready lights for all flash units are lit.

■ Quick Wireless Control (SB-5000 Only)

Select this option to control overall flash compensation for, and the relative balance between, groups A and B, while setting output for group C manually.

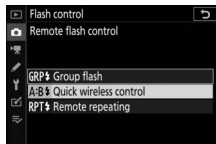
- 1** : Select **Quick wireless control**.
Select **Quick wireless control** for **Flash control > Remote flash control** in the photo shooting menu.



- 2** : Select **Quick wireless control options**.
Highlight **Quick wireless control options** in the flash control display and press .

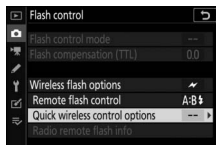

- 3** : Adjust flash settings.
Choose the balance between groups A and B.

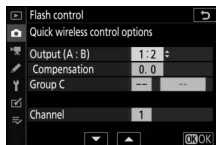

Adjust flash compensation for groups A and B.

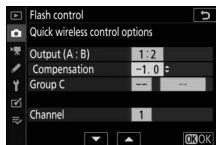

Choose a flash control mode and flash level for the units in group C:

- **M**: Choose the flash level manually
- **--**: The units in group C do not fire.

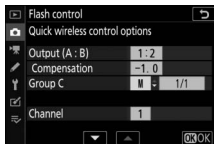

Choose a channel for the master flash. If the remote flash units include an SB-500, you must choose channel 3, but otherwise you can choose any channel between 1 and 4.

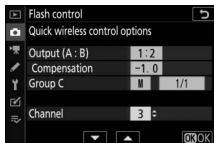

4 : Set the remote flash units to the same channel as the master flash.

Set the remote flash units to the channel selected in Step 3.

5 : Group the remote flash units.

Choose a group (A, B, or C). Although there is no limit on the number of remote flash units that may be used, the practical maximum is three per group. With more than this number, the light emitted by the remote flash units will interfere with performance.

6 : Compose the shot.

Compose the shot and arrange the flash units. See the documentation provided with the flash units for more information. After arranging the units, press the test button on the master flash to test-fire the flash and confirm that the units are functioning normally. Flash units can also be test-fired by pressing the **i** button in the flash info display (📖 388) and selecting **⚡ Test flash**.

7 : Take the photograph.



Take the photograph after confirming that the flash-ready lights for all flash units are lit.

■ **Remote Repeating (SB-5000 Only)**

When this option is selected, the flash units fire repeatedly while the shutter is open, producing a multiple-exposure effect.

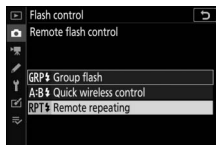
- 1 : **Select Remote repeating.**
Select **Remote repeating** for **Flash control** > **Remote flash control** in the photo shooting menu.



- 2 : **Select Remote repeating options.**
Highlight **Remote repeating options** in the flash control display and press .

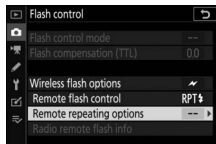

3 Adjust flash settings.

Choose the flash level (**Output**), the maximum number of times the flash units fire (**Times**), and the number of times the flash units fire per second (**Frequency**).

Enable or disable selected groups. Select **ON** to enable the selected group, -- to disable the selected group.

Choose a channel for the master flash. If the remote flash units include an SB-500, you must choose channel 3, but otherwise you can choose any channel between 1 and 4.

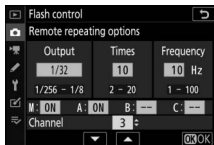
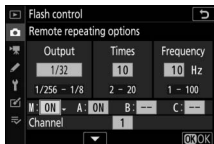
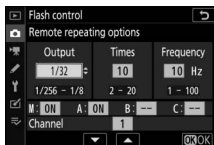



4 Set the remote flash units to the same channel as the master flash.

Set the remote flash units to the channel selected in Step 3.

5 : Group the remote flash units.

Choose a group (A, B, or C) for each remote flash unit. Although there is no limit on the number of remote flash units that may be used, the practical maximum is three per group. With more than this number, the light emitted by the remote flash units will interfere with performance.

6 / : Compose the shot.

Compose the shot and arrange the flash units. See the documentation provided with the flash units for more information. After arranging the units, press the test button on the master flash to test-fire the flash and confirm that the units are functioning normally. Flash units can also be test-fired by pressing the  button in the flash info display (□ 388) and selecting  **Test flash**.

7 / : Take the photograph.

Take the photograph after confirming that the flash-ready lights for all flash units are lit.

Optical AWL

Position the sensor windows on the remote flash units to pick up the light from the master flash (particular care is required if the camera is not mounted on a tripod). Be sure that direct light or strong reflections from the remote flash units do not enter the camera lens (in TTL mode) or the photocells on the remote flash units (⊗A mode), as this may interfere with exposure. To prevent low-intensity timing flashes emitted by the master flash from appearing in photographs taken at short range, choose low ISO sensitivities or small apertures (high f-numbers). After positioning the remote flash units, take a test shot and view the results in the camera display.

Optical/Radio AWL

Optical and radio AWL can be used together. Radio flash control is provided by a WR-R10 connected to the camera, optical control by an SU-800 wireless Speedlight commander or an SB-910, SB-900, SB-800, SB-700, or SB-500

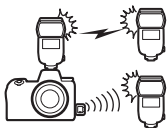

flash unit mounted on the camera accessory shoe. Before proceeding, establish a wireless connection between the radio-controlled flash units and the WR-R10 (📖 366). If an SB-500 is mounted on the camera accessory shoe, select **Optical/radio AWL for Flash control > Wireless flash options** in the photo shooting menu; with other flash units or the SU-800, this option is selected automatically.

The only option available for **Remote flash control** will be **Group flash**.

Choose a group (A–F) for each of the remote flash units. Place optically-controlled flash units in groups A through C and radio-controlled units in groups D through F (to display options for groups D through F, press ⬆️ or ⬇️ in the group flash options display).

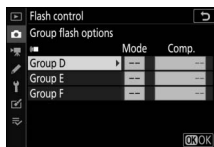

Viewing Flash Info

The camera can display flash info for SB-5000 and SB-500 flash units mounted on the camera accessory shoe and configured as a master flash for optical AWL, as well as for remote flash units controlled via radio AWL using a WR-R10. Flash info can be viewed in the camera display by pressing the **DISP** button in photo mode (📖 15). The information displayed varies with the flash control mode.

Group Flash

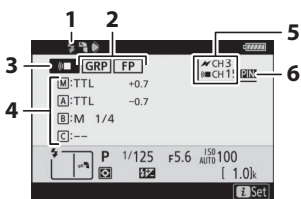

1	Flash-ready indicator ¹	366
2	Remote flash control FP indicator.....	190 267
3	Remote flash control mode ²	189, 190
4	Group flash control mode ³ Group flash mode Flash level (output)/ flash compensation.....	370, 378 370, 378 370, 378
5	Channel ²	189, 366
6	Link mode ⁴	366

Quick Wireless Control

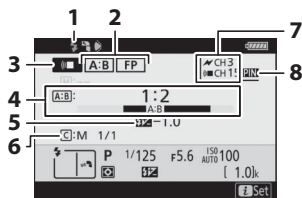



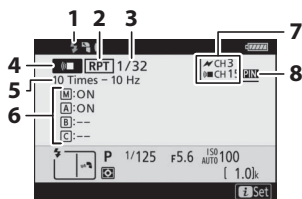

1	Flash-ready indicator ¹	366
2	Remote flash control	190
	FP indicator	267
3	Remote flash control mode ²	189, 190
4	A : B ratio.....	372, 380
5	Flash compensation.....	372, 380
6	Group C flash control mode and flash level (output) ...	372, 380
7	Channel ²	189, 366
8	Link mode ⁴	366

Remote Repeating



1	Flash-ready indicator ¹	366
2	Remote flash control	190
3	Flash level (output)	374, 382
4	Remote flash control mode ²	189, 190
5	Number emitted (times) ... Frequency.....	374, 382 374, 382
6	Group status (enabled/disabled)	374, 382
7	Channel ²	189, 366
8	Link mode ⁴	366

- 1 Displayed in radio AWL when all flash units are ready.
- 2 Optical AWL is indicated by , radio AWL by , joint optical and radio AWL by  and . Optical AWL channel for joint optical and radio AWL is displayed only when SB-500 is used as master flash.
- 3 Icons are displayed for each group when joint optical and radio AWL is used.
- 4 Displayed only when radio AWL or join optical and radio AWL is used.

✓ Flash Info and Camera Settings

The flash information display shows selected camera settings, including shooting mode, shutter speed, aperture, and ISO sensitivity.



✓ Changing Flash Settings

Flash settings can be changed by pressing the **i** button in the flash info display. The options available vary with the flash unit and the settings selected. You can also test-fire the flash.



Troubleshooting

You may be able to resolve any issues with the camera by following the steps below. Check this list before consulting your retailer or Nikon-authorized service representative.

STEP 1

Check the common problems listed in the following sections:

- “Problems and Solutions” (□ 390)
- “Indicators and Error Messages” (□ 396)

STEP 2

Turn the camera off and remove the battery. After waiting for about a minute, re-insert the battery and turn the camera on.

- ✓ If you have just finished shooting, wait at least a minute before removing the battery, as the camera may still be writing data to the memory card.

STEP 3

Search Nikon websites.

For support information and answers to frequently asked questions, visit the website for your country or region (□ xxii). To download the latest firmware for your camera, visit:
<https://downloadcenter.nikonimglib.com>

STEP 4

Consult a Nikon-authorized service representative.

✓ Restoring Default Settings

Depending on current settings, some menu items and other features may be unavailable. To access menu items that are grayed out or features that are otherwise unavailable, try restoring default settings using the **Reset all settings** item in the setup menu (□ 315). Note, however, that wireless network profiles, copyright information, and other user-generated entries will also be reset. We recommend that you save settings using the **Save/load settings** option in the setup menu before performing a reset.

Problems and Solutions

Solutions to some common issues are listed below.

Battery/Display

The camera is on but does not respond: Wait for recording to end. If the problem persists, turn the camera off. If the camera does not turn off, remove and reinsert the battery or, if you are using an AC adapter, disconnect and reconnect the AC adapter. Note that although any data currently being recorded will be lost, data that have already been recorded will not be affected by removing or disconnecting the power source.

The viewfinder or monitor does not turn on:

- Choose a different monitor mode using the monitor mode button (note that you may first need to enable the desired mode using the **Limit monitor mode selection** option in the setup menu).
 - Dust, lint, or other foreign matter on the eye sensor may prevent it functioning normally. Clean the eye sensor with a blower.
-

The viewfinder is out of focus: Rotate the diopter adjustment control to focus the viewfinder. If this does not correct the problem, select **AF-S**, single-point AF, and the center focus point, and then frame a high-contrast subject in the center focus point and press the shutter-release button halfway to focus the camera. With the camera in focus, use the diopter adjustment control to bring the subject into clear focus in the viewfinder.

The displays turn off without warning: Choose longer delays for Custom Setting c3 (**Power off delay**).

The control panel is unresponsive and dim: Control panel response times and brightness vary with temperature.

Shooting

The camera takes time to turn on: Delete files or folders.

The shutter-release is disabled:

- The memory card is full.
 - **Release locked** is selected for **Slot empty release lock** in the setup menu and no memory card is inserted.
 - Mode **S** selected with **Bulb** or **Time** chosen for shutter speed.
-

The camera is slow to respond to the shutter-release button: Select **Off** for Custom Setting d4 (**Exposure delay mode**).

Only one shot is taken each time the shutter-release button is pressed in continuous release modes: Turn HDR off.

Photos are out of focus: To focus using autofocus, select **AF-S**, **AF-C**, or **AF-F** for focus mode. If the camera is unable to focus using autofocus (□ 53), use manual focus or focus lock.

Beeps do not sound:

- **Off** is selected for **Beep options > Beep on/off** in the setup menu.
 - **AF-C** is selected for focus mode.
 - **On** is selected for **Silent photography** in the photo shooting menu.
 - The camera is in movie mode.
-

The full range of shutter speeds is not available: A flash in use. Flash sync speed can be selected using Custom Setting e1 (**Flash sync speed**); when using compatible flash units, choose **1/200 s (Auto FP)** to access the full range of shutter speeds.

Focus does not lock when the shutter-release button is pressed halfway: When **AF-C** is selected for focus mode, focus can be locked by pressing the center of the sub-selector.

The focus point cannot be changed: Focus-point selection is unavailable in auto-area AF; choose another AF-area mode.

The camera is slow to record photos: Turn long exposure noise reduction off.

Photographs and movies do not appear to have the same exposure as the preview shown in the display: To preview the effects of changes to settings that affect exposure and color, select **On** for Custom Setting d8 (**Apply settings to live view**). Note that changes to **Monitor brightness** and **Viewfinder brightness** have no effect on images recorded with the camera.

Flicker or banding appears in movie mode: Select **Flicker reduction** in the movie shooting menu and choose an option that matches the frequency of the local AC power supply.

Bright regions or bands appear in the view through the lens: The shot is being framed under flashing sign, flash, or other light source with brief duration.

Smudges appear in photographs: Clean the front and rear lens elements. If the problem persists, perform image sensor cleaning.

Bokeh is irregular: With fast shutter speeds and/or fast lenses, you may notice irregularities in how *bokeh* is shaped. The effect can be mitigated by choosing slower shutter speeds and/or higher f-numbers.

Pictures are affected by noticeable ghosting or flare: You may notice ghosting or flare in shots that include the sun or other bright light sources. These effects can be mitigated by attaching a lens hood or by composing shots with bright light sources well out of the frame. You can also try such techniques as removing lens filters, choosing a different shutter speed, or using silent photography.

Shooting ends unexpectedly or does not start: Shooting may end automatically to prevent damage to the camera's internal circuits if the ambient temperature is high or the camera has been used extensively for burst shooting, movie recording, or the like. If you are unable to shoot because the camera has overheated, wait for the internal circuits to cool and then try again. Note that the camera may feel warm to the touch, but this does not indicate a malfunction.

Image artifacts appear in the display during shooting: “Noise” (randomly-spaced bright pixels, fog, or lines) and unexpected colors may appear if you zoom in on the view through the lens. Randomly-spaced bright pixels, fog, or bright spots may also arise as a result of increases in the temperature of the camera’s internal circuits during shooting; turn the camera off when it is not in use. At high ISO sensitivities, noise may become more noticeable in long exposures or in pictures recorded when the camera temperature is elevated. Note that the distribution of noise in the display may differ from that in the final picture. To reduce noise, adjust settings such as ISO sensitivity, shutter speed, or Active D-Lighting.

The camera cannot measure white balance: The subject is too dark or too bright.

Images cannot be selected as source for preset white balance: The images in question were created with a different model of camera.

White balance bracketing is unavailable:

- An NEF (RAW) or NEF+JPEG image quality option is selected for image quality.
 - Multiple exposure or HDR (high dynamic range) photography is on.
-

The effects of Picture Controls differ from image to image: **Auto** is selected for **Set Picture Control**, a Picture Control based on **Auto** is selected, or **A** (auto) is selected for **Quick sharp**, contrast, or saturation. For consistent results over a series of photographs, choose another setting.

Metering cannot be changed: Autoexposure lock is in effect.

Exposure compensation cannot be used: Choose mode **P**, **S**, or **A**.

Noise (colored splotches or other artifacts) appears in long time-exposures: Enable long exposure noise reduction.

The AF-assist illuminator does not light:

- Select **On** for Custom Setting a12 (**Built-in AF-assist illuminator**).
 - The illuminator does not light in movie mode or when **AF-C** or **MF** is selected for focus mode.
-

Sound is not recorded with movies: Microphone off is selected for **Microphone sensitivity** in the movie shooting menu.

Playback

NEF (RAW) images are not played back: The pictures were taken at image qualities of NEF + JPEG.

The camera does not display pictures recorded with other cameras: Pictures recorded with other makes of camera may not be displayed correctly.

Some photos are not displayed during playback: Select **All** for **Playback folder**.

“Tall” (portrait) orientation photos are displayed in “wide” (landscape) orientation:

- Select **On** for **Rotate tall** in the playback menu.
 - The photos are displayed in image review.
 - The camera was pointed up or down when photo was taken.
-

Pictures cannot be deleted: The pictures are protected. Remove protection.

Pictures cannot be retouched: The picture cannot be edited with this camera.

The camera displays a message stating that the folder contains no images: Select **All** for **Playback folder**.

Pictures cannot be printed: NEF (RAW) and TIFF photos cannot be printed by direct USB connection. Transfer the photos to a computer and print them using Capture NX-D. NEF (RAW) photos can be saved in JPEG format using the **NEF (RAW) processing** option in the retouch menu.

Pictures are not displayed on HDMI devices: Confirm that an HDMI cable (available separately) is connected.

Output to HDMI devices does not function as expected:

- Check that the HDMI cable is correctly connected.
 - Select **Off** for **HDMI > Advanced > External recording control** in the setup menu.
 - Check again after selecting **Reset all settings** in the setup menu.
-

The Image Dust Off option in Capture NX-D does not have desired effect: Image sensor cleaning changes the position of dust on the image sensor. Dust off reference data recorded before image sensor cleaning is performed cannot be used with photographs taken after image sensor cleaning is performed; similarly, dust off reference data recorded after image sensor cleaning is performed cannot be used with photographs taken before image sensor cleaning is performed.

Computers do not display NEF (RAW) images the same way as the camera does: Third-party software does not display effects of Picture Controls, Active D-Lighting, vignette control, or the like. Use Capture NX-D or ViewNX-i.

Pictures cannot be transferred to a computer: The computer operating system is not compatible with the camera or image transfer software. Use a card reader or card slot to copy the pictures to a computer.

Bluetooth and Wi-Fi (Wireless Networks)

Smart devices do not display the camera SSID (network name):

- Confirm that **Disable** is selected for **Airplane mode** in the camera setup menu.
- Confirm that **Enable** is selected for **Connect to smart device > Pairing (Bluetooth) > Bluetooth connection** in the camera setup menu.
- Try turning the smart device Wi-Fi off and then on again.

The camera cannot connect to wireless printers and other wireless devices: This camera can connect only to computers and smart devices.

Miscellaneous

The date of recording is not correct: The camera clock is less accurate than most watches and household clocks. Check the clock regularly against more accurate timepieces and reset as necessary.



Some menu items cannot be selected: Some options are not available at certain combinations of settings or when no memory card is inserted.

Indicators and Error Messages

This section lists the indicators and error messages that appear in the control panel and camera display.

Indicators

The following indicators appear in the control panel and/or camera display:

Indicator		Problem	Solution
Camera display	Control panel		
		Low battery.	Ready a fully-charged spare battery.
		Battery exhausted.	Recharge or replace battery.
	 (flashes)	Battery info unavailable.	Battery cannot be used. Contact Nikon-authorized service representative.
		Battery not supported.	Replace with Nikon battery.
		Battery temperature high.	Remove battery and wait for it to cool.
	F---	Lens is not correctly attached.	Ensure that the lens is correctly attached and that retractable lenses are extended. This indicator is also displayed when a non-CPU lens is attached via a mount adapter, but in this case no action need be taken.
	Bulb (flashes)	Bulb selected in mode S .	Change shutter speed or select mode M .
	Time (flashes)	Time selected in mode S .	
	Busy (flashes)	Processing in progress.	Wait until processing is complete.

Indicator		Problem	Solution
Camera display	Control panel		
 (flashes)	—	Flash has fired at full power; photo may be underexposed.	Check photo in display; if underexposed, adjust settings and try again.
(Exposure indicators and shutter speed or aperture display flash)		Subject too bright; photo will be overexposed.	<ul style="list-style-type: none"> • Decrease ISO sensitivity. • Use optional ND filter. In mode: S Increase shutter speed A Choose a smaller aperture (higher f-number)
		Subject too dark; photo will be underexposed.	<ul style="list-style-type: none"> • Increase ISO sensitivity. • Use optional flash. In mode: S Lower shutter speed A Choose larger aperture (lower f-number)
Full (flashes)		Memory insufficient to record further pictures at current settings, or camera has run out of file or folder numbers.	<ul style="list-style-type: none"> • Reduce quality or size. • Delete pictures after copying important images to computer or other device. • Insert new memory card.
Err (flashes)		Camera malfunction.	Release shutter. If error persists or appears frequently, consult Nikon-authorized service representative.

Error Messages

Error messages in the camera display are sometimes accompanied by indicators in the control panel.

Message	Control panel	Problem	Solution
No memory card.	[–E–]	Camera cannot detect memory card.	Turn camera off and confirm that card is correctly inserted.
Cannot access this memory card. Insert another card.	Card, Err (flashes)	Error accessing memory card.	<ul style="list-style-type: none">• Use Nikon-approved card.• If error persists after card has been repeatedly ejected and reinserted, card may be damaged. Contact retailer or Nikon-authorized service representative.
		Unable to create new folder.	Delete files or insert new memory card after copying important pictures to computer or other device.
This card is not formatted. Format the card.	For (flashes)	Memory card has not been formatted for use in camera.	Format memory card or insert new memory card.
Unable to start live view. Please wait.	—	The internal temperature of the camera is high.	Wait for the internal circuits to cool before resuming shooting.
Folder contains no images.	—	No viewable pictures on memory card.	Insert memory card containing viewable pictures.
		No viewable pictures in folder(s) selected for playback.	Use Playback folder item in playback menu to select folder containing viewable pictures.

Message	Control panel	Problem	Solution
Cannot display this file.	—	File was edited on computer or does not comply with DCF standards, or file is corrupt.	File cannot be viewed on camera.
Cannot select this file.	—	Selected picture cannot be retouched.	Pictures created with other devices cannot be retouched.
This movie cannot be edited.	—	Selected movie cannot be edited.	<ul style="list-style-type: none"> • Movies created with other devices cannot be edited. • Movies must be at least two seconds long.
Check printer.	—	Printer error.	Check printer. To resume, select Continue (if available)*.
Check paper.	—	Paper in printer is not of selected size.	Insert paper of correct size and select Continue *.
Paper jam.	—	Paper is jammed in printer.	Clear jam and select Continue *.
Out of paper.	—	Printer is out of paper.	Insert paper of selected size and select Continue *.
Check ink supply.	—	Ink error.	Check ink. To resume, select Continue *.
Out of ink.	—	Printer is out of ink.	Replace ink and select Continue *.

* See printer manual for more information.

11	AF-area mode	54, 191, 245	25	"k" (appears when memory remains for over 1000 exposures)	34
12	Active D-Lighting.....	112, 184, 243	26	Number of exposures remaining	34, 469
13	Picture Control.....	96, 179, 243	27	ISO sensitivity	82
14	White balance.....	64, 100, 172, 242	28	ISO sensitivity indicator	82
15	Image quality.....	106, 168		Auto ISO sensitivity indicator	83
16	Image area.....	121, 167, 241	29	Exposure compensation indicator.....	84
17	Image size.....	108, 168	30	Flash compensation indicator	358
18	Wi-Fi connection indicator	111	31	Subject tracking.....	59
19	 icon	13, 21	32	Aperture.....	74
20	Exposure and flash bracketing indicator	193	33	Aperture lock icon	283
	WB bracketing indicator	197	34	Shutter speed	73, 75
	ADL bracketing indicator.....	200	35	Flash sync indicator.....	267
	HDR indicator.....	209	36	Shutter speed lock icon	283
	Multiple exposure indicator.....	202	37	FV lock indicator	359, 413
21	Number of shots remaining in exposure and flash bracketing sequence	193	38	Metering	110, 187, 245
	Number of shots remaining in white balance bracketing sequence	197	39	Autoexposure (AE) lock.....	91, 92
	Number of shots remaining in ADL bracketing sequence.....	200	40	Battery indicator	34
	HDR exposure differential	209	41	Flicker detection	187
	Number of exposures (multiple exposure)	202	42	Shutter type	264
22	Exposure indicator.....	76		Silent photography	68, 239
	Exposure compensation display.....	84	43	Exposure delay mode	263
	Bracketing progress indicator: Exposure and flash bracketing.....	193	44	Vibration reduction indicator.....	114, 191
23	Bluetooth connection indicator	310	45	Touch shooting	10, 60
	Airplane mode.....	310	46	Live view preview indicator	266
24	Flash-ready indicator	414	47	Temperature warning.....	402

Temperature Warnings

If the camera temperature becomes elevated, a temperature warning will be displayed together with a count-down timer (the timer turns red when the thirty second mark is reached). In some cases, the timer may be displayed immediately after the camera is turned on. When the timer reaches zero, the shooting display will turn off automatically to protect the camera's internal circuits.

■ The Information Display

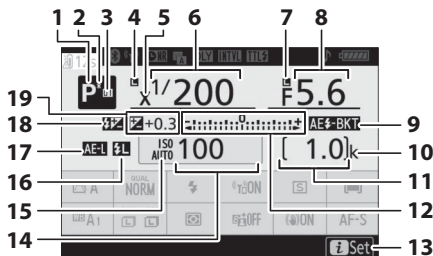

1 Shooting mode	72	12 Exposure indicator	76
2 Flexible program indicator	73	Exposure compensation	
3 User setting mode	77	display	84
4 Shutter speed lock icon	283	Bracketing progress indicator:	
5 Flash sync indicator	267	Exposure and flash	
6 Shutter speed	73, 75	bracketing	193
7 Aperture lock icon	283	WB bracketing	197
8 Aperture	74	ADL bracketing	200
9 Exposure and flash bracketing		13 i icon	13, 21
indicator	193	14 ISO sensitivity	82
WB bracketing indicator	197	15 ISO sensitivity indicator	82
ADL bracketing indicator	200	Auto ISO sensitivity indicator	83
HDR indicator	209	16 FV lock indicator	359, 413
Multiple exposure indicator	202	17 Autoexposure (AE) lock	91, 92
10 "k" (appears when memory		18 Flash compensation indicator	358
remains for over 1000		19 Exposure compensation	
exposures)	34	indicator	84
11 Number of exposures		Exposure compensation	
remaining	34, 469	value	84

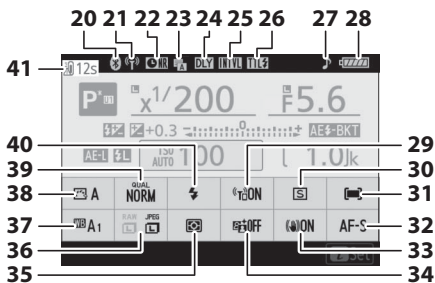

20 Bluetooth connection indicator 310	29 Built-in Wi-Fi 111, 343
Airplane mode 310	30 Release mode 86, 113
21 Wi-Fi connection indicator 111	31 AF-area mode 54, 191, 245
22 Long exposure noise reduction indicator 185	32 Focus mode 52, 191, 245
23 Shutter type 264	33 Vibration reduction 114, 191
Silent photography 68, 239	34 Active D-Lighting 112, 184, 243
24 Exposure delay mode 263	35 Metering 110, 187, 245
25 Interval timer indicator 214	36 Image size 108, 168
"Clock not set" indicator 40	37 White balance 64, 100, 172, 242
26 Flash control mode 188	38 Picture Control 96, 179, 243
27 "Beep" indicator 307	39 Image quality 106, 168
28 Battery indicator 34	40 Flash mode 109, 356
	41 Temperature warning 402

The Monitor: Movie Mode

The following indicators appear in the monitor in movie mode.

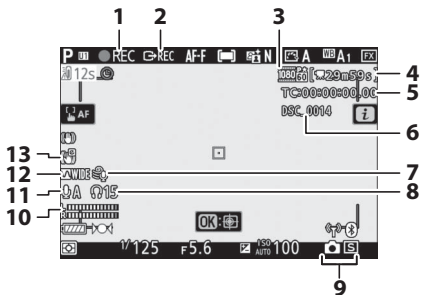

1	Recording indicator.....	45	7	Wind noise reduction	247
	"No movie" indicator.....	46	8	Headphone volume	247
2	External recording control.....	348	9	Release mode (still photography).....	86
3	Frame size and rate/image quality.....	118, 241	10	Sound level	120
4	Time remaining	45	11	Microphone sensitivity.....	120, 246
5	Time code	248	12	Frequency response.....	247
6	File name	241	13	Electronic VR indicator	122, 245

The Viewfinder: Photo Mode

The following indicators appear in the viewfinder in photo mode.

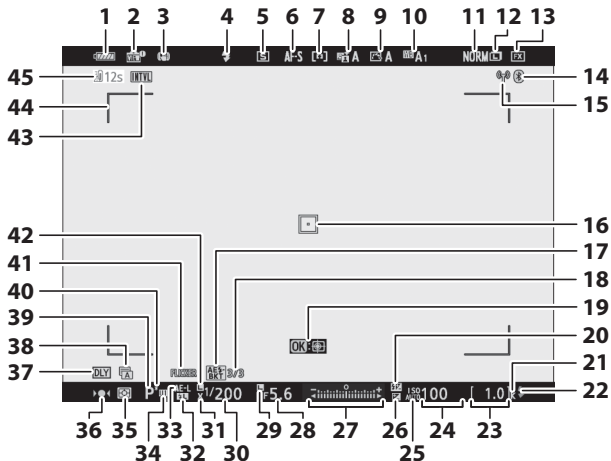

1 Battery indicator34	12 Image size 108, 168
2 Live view preview indicator 266	13 Image area 121, 167, 241
3 Vibration reduction indicator 114, 191	14 Bluetooth connection indicator..... 310
4 Flash mode..... 109, 356	Airplane mode 310
5 Release mode86, 113	15 Wi-Fi connection indicator..... 111
6 Focus mode.....52, 191, 245	16 Focus point 43, 54
7 AF-area mode54, 191, 245	17 Exposure and flash bracketing indicator..... 193
8 Active D-Lighting indicator 112, 184, 243	WB bracketing indicator 197
9 Picture Control indicator96, 179, 243	ADL bracketing indicator 200
10 White balance64, 100, 172, 242	HDR indicator 209
11 Image quality 106, 168	Multiple exposure indicator 202

18	Number of shots remaining in exposure and flash bracketing sequence 193	28	Aperture..... 74
	Number of shots remaining in white balance bracketing sequence 197	29	Aperture lock icon 283
	Number of shots remaining in ADL bracketing sequence 200	30	Shutter speed 73, 75
	HDR exposure differential 209	31	Flash sync indicator 267
	Number of exposures (multiple exposure) 202	32	FV lock indicator 359, 413
19	Subject tracking 59	33	Autoexposure (AE) lock 91, 92
20	Flash compensation indicator 358	34	User setting mode 77
21	“k” (appears when memory remains for over 1000 exposures) 34	35	Metering 110, 187, 245
22	Flash-ready indicator 414	36	Focus indicator 62
23	Number of exposures remaining..... 34, 469	37	Exposure delay mode 263
24	ISO sensitivity 82	38	Shutter type 264
25	ISO sensitivity indicator..... 82		Silent photography 68, 239
	Auto ISO sensitivity indicator 83	39	Shooting mode 72
26	Exposure compensation indicator 84	40	Flexible program indicator..... 73
27	Exposure indicator..... 76	41	Flicker detection 187
	Exposure compensation display..... 84	42	Shutter speed lock icon 283
	Bracketing progress indicator:	43	Interval timer indicator 214
	Exposure and flash bracketing 193		“Clock not set” indicator 40
			“No memory card” indicator 32, 35
		44	AF-area brackets 54
		45	Temperature warning..... 402

The Viewfinder: Movie Mode

The following indicators appear in the viewfinder in movie mode.

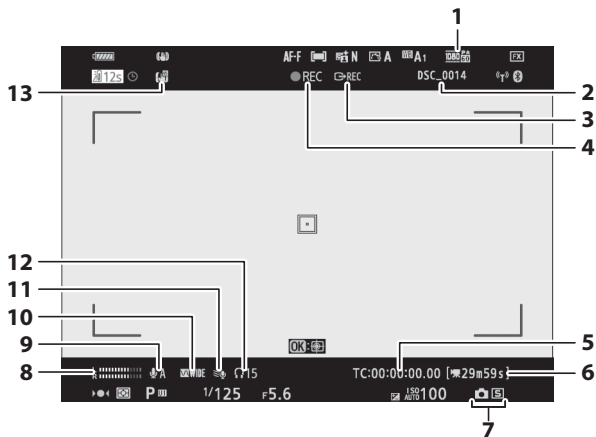

1	Frame size and rate/image quality..... 118, 241	7	Release mode (still photography)86
2	File name 167	8	Sound level 120
3	External recording control 348	9	Microphone sensitivity 120, 246
4	Recording indicator45 "No movie" indicator46	10	Frequency response 247
5	Time code 248	11	Wind noise reduction..... 247
6	Time remaining.....45	12	Headphone volume..... 247
		13	Electronic VR indicator 122, 245

The Control Panel

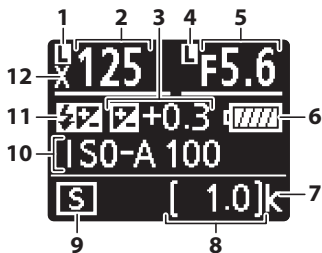

1 Shutter-speed lock icon 283	8 Number of exposures remaining 34, 469
2 Shutter speed 73, 75	9 Release mode 86
3 Exposure compensation indicator 84	10 ISO sensitivity 82
Exposure compensation value 84	11 Flash compensation indicator 358
4 Aperture lock icon 283	"Flash off" icon 109
5 Aperture 74	12 Flash sync indicator 267
6 Battery indicator 34	
7 "k" (appears when memory remains for over 1000 exposures) 34	

The Nikon Creative Lighting System

Nikon's advanced Creative Lighting System (CLS) offers improved communication between the camera and compatible flash units for improved flash photography.

CLS-Compatible Flash Units

The following features are available with CLS-compatible flash units:





		SB-5000	SB-800	SB-900	SB-910	SB-700	SB-600	SB-500	SU-800	SB-R200	SB-400	SB-300
Single flash	i-TTL	i-TTL balanced fill flash ¹	✓	✓	✓	✓	✓	✓	—	—	✓	✓
		Standard i-TTL fill flash	✓ ²	✓ ²	✓	✓ ²	✓	—	—	—	✓	✓
	 A	Auto aperture	✓	✓ ³	—	—	—	—	—	—	—	—
	A	Non-TTL auto	—	✓ ³	—	—	—	—	—	—	—	—
	GN	Distance-priority manual	✓	✓	✓	—	—	—	—	—	—	—
	M	Manual	✓	✓	✓	✓	✓ ⁴	—	—	—	✓ ⁴	✓ ⁴
	RPT	Repeating flash	✓	✓	—	—	—	—	—	—	—	—

✓ Flash Photography

Flash photography cannot be combined with some camera features, including:

- Silent photography
- Movie recording
- HDR (high dynamic range)
- High-speed continuous (extended)

		SB-5000	SB-800	SB-900	SB-910	SB-700	SB-600	SB-500	SU-800	SB-R200	SB-400	SB-300	
Optical Advanced Wireless Lighting	Master	Remote flash control	✓	✓	✓	—	✓ ⁴	✓	—	—	—	—	
		i-TTL	✓	✓	✓	—	✓ ⁴	—	—	—	—	—	
		[A:B]	Quick wireless flash control	✓	—	✓	—	—	✓ ⁵	—	—	—	—
		 A	Auto aperture	✓	✓	—	—	—	—	—	—	—	—
		A	Non-TTL auto	—	—	—	—	—	—	—	—	—	—
		M	Manual	✓	✓	✓	—	✓ ⁴	—	—	—	—	—
	RPT	Repeating flash	✓	✓	—	—	—	—	—	—	—	—	
	Remote	i-TTL	✓	✓	✓	✓	✓	✓	—	✓	—	—	—
		[A:B]	Quick wireless flash control	✓	✓	✓	✓	✓	—	✓	—	—	—
		 A/A	Auto aperture/ Non-TTL auto	✓ ⁶	✓ ⁶	—	—	—	—	—	—	—	—
		M	Manual	✓	✓	✓	✓	✓	—	✓	—	—	—
		RPT	Repeating flash	✓	✓	✓	✓	✓	—	—	—	—	—
	Radio-controlled Advanced Wireless Lighting		✓ ⁷	—	—	—	—	—	—	—	—	—	—
	Color information communication (flash)		✓	✓	✓	✓	✓	✓	—	—	✓	✓	✓
	Color information communication (LED light)		—	—	—	—	—	✓	—	—	—	—	—
	Auto FP High-Speed Sync ⁸		✓	✓	✓	✓	✓	✓	✓	✓	✓	—	—
FV lock ⁹		✓	✓	✓	✓	✓	✓	✓	✓	✓	✓	✓	
Red-eye reduction		✓	✓	✓	✓	✓	✓	—	—	✓	—	—	
Camera modeling illumination		✓	✓	✓	✓	✓	✓	✓	✓	—	—	—	
Unified flash control		✓	—	—	—	—	✓	—	—	✓	✓	✓	
Camera flash unit firmware update		✓	✓ ¹⁰	✓	—	✓	—	✓	—	—	—	✓	

- 1 Not available with spot metering.
- 2 Can also be selected with flash unit.
- 3 A/A mode selection performed on flash unit using custom settings.
- 4 Can only be selected using the camera **Flash control** option.
- 5 Available only during close-up photography.
- 6 Choice of A and **A** depends on the option selected with the master flash.
- 7 Supports the same features as remote flash units with optical AWL.
- 8 Available only in i-TTL, A, **A**, **GN**, and **M** flash-control modes.
- 9 Available only in i-TTL flash control mode or when the flash is set to emit monitor pre-flashes in A or **A** flash control mode.
- 10 Firmware updates for the SB-910 and SB-900 can be performed from the camera.

The SU-800 Wireless Speedlight Commander

When mounted on a CLS-compatible camera, the SU-800 can be used as a commander for SB-5000, SB-910, SB-900, SB-800, SB-700, SB-600, SB-500, or SB-R200 flash units in up to three groups. The SU-800 itself is not equipped with a flash.

Modeling Illumination

Pressing the control to which **Preview** has been assigned using Custom Setting f2 (**Custom control assignment**) causes CLS-compatible flash units to emit a modeling flash. This feature can be used with Advanced Wireless Lighting to preview the total lighting effect achieved with multiple flash units; the effect is best viewed by looking directly at the subject rather than at the camera display. Modeling illumination can be turned off using Custom Setting e5 (**Modeling flash**).

Studio Strobe Lighting

To adjust the color and brightness of the view through the lens so that shots are easier to frame, select **Off** for Custom Setting d8 (**Apply settings to live view**).

✓ Flash Compensation

In i-TTL and auto aperture (⊗A) flash control modes, the flash compensation selected with the optional flash unit or the camera **Flash control** option is added to the flash compensation selected with the **Flash compensation** option in the photo shooting menu.

✓ Other Flash Units

The following flash units can be used in non-TTL auto and manual modes.

Flash unit		SB-80DX, SB-28DX, SB-28, SB-26, SB-25, SB-24	SB-50DX, SB-23, SB-29, SB-21B, SB-29S	SB-30, SB-27 ¹ , SB-22S, SB-22, SB-20, SB-16B, SB-15
Flash mode				
A	Non-TTL auto	✓	—	✓
M	Manual	✓	✓	✓
	Repeating flash	✓	—	—
REAR	Rear-curtain sync ²	✓	✓	✓

- 1 Flash mode is automatically set to TTL and shutter-release is disabled. Set flash unit to **A** (non-TTL auto flash).
- 2 Available when camera is used to select flash mode.

✓ Using FV Lock with Optional Flash Units

FV lock is available with optional flash units in TTL and (where supported) monitor pre-flash ⊗A and monitor pre-flash A flash control modes (see the manual provided with the flash unit for more information). Note that when Advanced Wireless Lighting is used to control remote flash units, you will need to set the flash control mode for the master or at least one remote group to **TTL**, ⊗A, or **A**. The area metered for FV lock is as follows:

Flash unit	Flash mode	Metered area
Stand-alone flash unit	i-TTL	6-mm circle in center of frame
	⊗A	Area metered by flash exposure meter
Used with other flash units (Advanced Wireless Lighting)	i-TTL	Entire frame
	⊗A	Area metered by flash exposure meter
	A	

✓ Notes on Optional Flash Units

Refer to the flash unit manual for detailed instructions. If the unit supports CLS, refer to the section on CLS-compatible digital SLR cameras. Note that this camera is not included in the “digital SLR” category in the SB-80DX, SB-28DX, and SB-50DX manuals.

i-TTL flash control can be used at ISO sensitivities between 64 and 12800 (Z 7) or between 100 and 12800 (Z 6). At values over 12800, the desired results may not be achieved at some ranges or aperture settings. If the flash-ready indicator (⚡) flashes for about three seconds after a photograph is taken in i-TTL or non-TTL auto mode, the flash has fired at full power and the photograph may be underexposed (CLS-compatible flash units only).

When an SC-series 17, 28, or 29 sync cable is used for off-camera flash photography, correct exposure may not be achieved in i-TTL mode. We recommend that you select standard i-TTL fill-flash. Take a test shot and view the results in the camera display.

In i-TTL, use the flash panel or bounce adapter provided with the flash unit. Do not use other panels such as diffusion panels, as this may produce incorrect exposure.

In mode **P**, the maximum aperture (minimum f-number) is limited according to ISO sensitivity, as shown below:

Maximum aperture at ISO equivalent of:								
64	100	200	400	800	1600	3200	6400	12800
3.5	4	5	5.6	7.1	8	10	11	13

If the maximum aperture of the lens is smaller than given above, the maximum value for aperture will be the maximum aperture of the lens.

AF-assist illumination is provided by the camera, not the flash unit; the SB-5000, SB-910, SB-900, SB-800, SB-700, SB-600, SB-500, and SB-400 do, however, provide red-eye reduction.

Noise in the form of lines may appear in flash photographs taken with an SD-9 or SD-8A high-performance battery pack attached directly to the camera. Reduce ISO sensitivity or increase the distance between the camera and the power pack.

Other Accessories

A variety of accessories are available for your Nikon camera.

Power sources	<ul style="list-style-type: none">• EN-EL15b Rechargeable Li-ion Battery: Additional EN-EL15b batteries are available from local retailers and Nikon service representatives. EN-EL15a/EN-EL15 batteries can also be used, but note that you may not be able to take as many pictures on a single charge (☐ 471).• MH-25a Battery Charger: The MH-25a can be used to recharge EN-EL15b batteries. MH-25 battery chargers can also be used.• MB-N10 Battery Pack: A battery pack for Nikon mirrorless cameras. Attached to the camera, it allows the use of two EN-EL15b rechargeable Li-ion batteries as a power source.• EH-7P Charging AC Adapter: The EH-7P can be used to charge EN-EL15b batteries inserted in the camera (the battery only charges when the camera is off). It cannot be used to charge EN-EL15a/EN-EL15 batteries.• EP-5B Power Connector, EH-5c and EH-5b AC Adapters: These accessories can be used to power the camera for extended periods. The EP-5B is required to connect the camera to the EH-5c/EH-5b; see “Attaching a Power Connector and AC Adapter” (☐ 420) for details.
Filters	<ul style="list-style-type: none">• Neutral Color (NC) filters can be used to protect the lens.• To prevent ghosting, avoid using filters when the subject is framed against a bright light, or when a bright light source is in the frame.• Center-weighted metering is recommended if matrix metering fails to produce the desired results for filters with exposure factors (filter factors) over 1× (Y44, Y48, Y52, O56, R60, X0, X1, C-PL, ND2S, ND4, ND4S, ND8, ND8S, ND400, A2, A12, B2, B8, B12). See the filter manual for details.• Filters intended for special-effects photography may interfere with autofocus or the in-focus indicator (●).
Mount adapters	FTZ Mount Adapter (☐ 461)

Remote cords	MC-DC2 Remote Cord (length 1 m/3 ft 4 in.): When connected to the camera accessory terminal, the MC-DC2 can be used to release the shutter remotely.
GPS units	GP-1/GP-1A GPS Unit: When connected to the camera accessory terminal, existing GP-1/GP-1A units can be used to record the current latitude, longitude, altitude, and UTC (Universal Coordinated Time) with pictures taken with the camera. Note that production of GP-1/GP-1A units has ended.
USB cables	<ul style="list-style-type: none"> • UC-E24 USB cable: A USB cable with a type C connector for connection to the camera and a type A connector for connection to the USB device. • UC-E25 USB cable: A USB cable with two type C connectors.
HDMI cables	HC-E1 HDMI Cable: An HDMI cable with a type C connector for connection to the camera and a type A connector for connection to HDMI devices.
Hot shoe adapters	AS-15 Sync Terminal Adapter: Mount the AS-15 on the camera hot shoe to connect studio strobe lights or other flash equipment via a sync terminal.
Accessory shoe covers	BS-1 Accessory Shoe Cover: A cover protecting the accessory shoe when no flash unit is attached.
Body caps	BF-N1 Body Cap: The body cap prevents dust entering the camera when a lens is not in place.
Wireless transmitters	<p>WT-7 Wireless Transmitter: Use the WT-7 to upload pictures over a wireless network, to control the camera from a computer running Camera Control Pro 2 (available separately), or to take and browse pictures remotely from a computer or smart device.</p> <p>Note: A wireless network and some basic network knowledge is required when using a wireless transmitter. Be sure to update the wireless transmitter software to the latest version.</p>

Wireless remote controllers

- **WR-R10 Wireless Remote Controller/WR-T10 Wireless Remote Controller:** When a WR-R10 wireless remote controller is attached to the accessory terminal, the camera can be controlled wirelessly using a WR-T10 wireless remote controller (when connecting the WR-R10, be sure the cover for the accessory terminal and the USB and HDMI connectors is fully open). The WR-R10 can also be used to control radio-controlled flash units. For synchronized release involving more than one camera, ready multiple cameras with paired WR-R10 units attached.
- **WR-1 Wireless Remote Controller:** WR-1 units are used with WR-R10 or WR-T10 wireless remote controllers or with other WR-1 remote controllers, with the WR-1 units functioning as either transmitters or receivers. As a transmitter, the WR-1 can be used to control the camera and take pictures via signals transmitted to a receiver (a WR-R10 or a second WR-1) connected to the camera accessory terminal, while as a receiver it receives remote commands from a WR-T10 or a separate WR-1 transmitter.

Note: Be sure the firmware for the WR-R10 and WR-1 has been updated to the latest version (WR-R10 firmware version 3.0 or later and WR-1 firmware version 1.0.1 or later). For information on firmware updates, see the Nikon website for your area. Consult a Nikon-authorized service representative when updating the firmware for the WR-R10 from versions prior to version 2.0 to version 3.0 or later.

Viewfinder eyepiece accessories

DK-29 Rubber Eyecup: The DK-29 makes the image in the viewfinder easier to see, preventing eye fatigue.

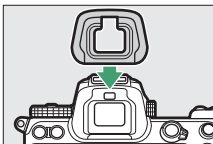
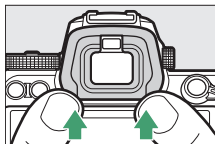

Microphones	<ul style="list-style-type: none"> • ME-1 Stereo Microphone: Connect the ME-1 to the camera microphone jack to record stereo sound and reduce the chance of picking up equipment noise (such as the sounds produced by the lens during autofocus). • ME-W1 Wireless Microphone: Use this wireless Bluetooth microphone for off-camera recording.
Software	<p>Camera Control Pro 2: Control the camera remotely from a computer and save photographs directly to the computer hard disk. When Camera Control Pro 2 is used to capture photographs directly to the computer, a PC connection indicator (PC) will appear in the control panel.</p> <p>Note: Use the latest versions of Nikon software; see the Nikon website for your region for the latest information on supported operating systems. At default settings, Nikon Message Center 2 will periodically check for updates to Nikon software and firmware while you are logged in to an account on the computer and the computer is connected to the Internet. A message is automatically displayed when an update is found.</p>

Availability may vary with country or region. See our website or brochures for the latest information.

✓ Attaching and Removing the Accessory Shoe Cover

The BS-1 accessory shoe cover slides into the accessory shoe as shown. To remove the cover, hold the camera firmly, press the cover down with a thumb and slide it in the direction shown.

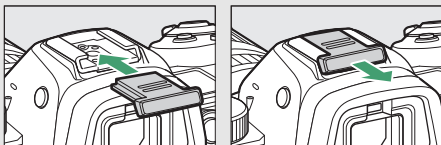

✓ The HDMI/USB Cable Clip

To prevent accidental disconnection, attach the supplied clip to HDMI cables or to the supplied USB cable as shown (the illustration shows the USB cable; note that the clip may not fit all third-party HDMI cables). Keep the monitor in the storage position when using the cable clip.

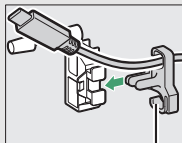
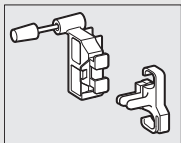

HDMI cable goes here

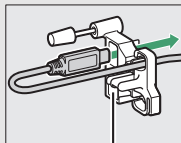

HDMI cable goes here

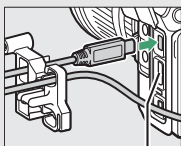

HDMI cable goes here

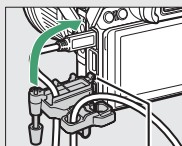

Insert tab into matching slot on camera and attach cable clip

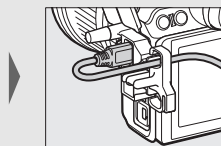
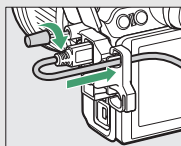

USB cable

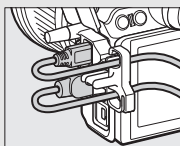

HDMI cable and USB cable used simultaneously

Attaching a Power Connector and AC Adapter

Turn the camera off before attaching an optional power connector and AC adapter.

1 Ready the camera.

Open the battery-chamber cover (1) and power connector cover (2) covers.

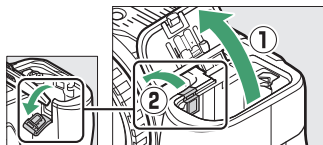

2 Insert the EP-5B power connector.

Be sure to insert the connector in the orientation shown, using the connector to keep the orange battery latch pressed to one side. The latch locks the connector in place when the connector is fully inserted.

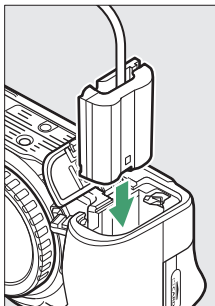

3 Close the battery-chamber cover.

Position the power connector cable so that it passes through the power connector slot and close the battery-chamber cover.

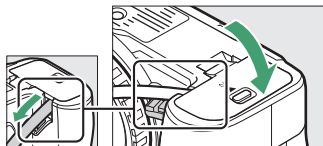

4 Connect the EH-5c/EH-5b AC adapter.

Connect the AC adapter power cable to the AC socket on the AC adapter (③) and the power cable to the DC socket (④). A  icon is displayed when the camera is powered by the AC adapter and power connector.

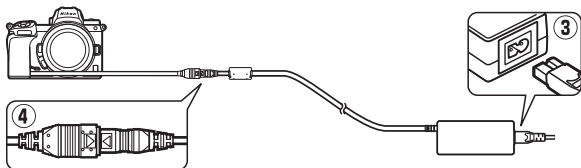

Caring for the Camera

Learn how to store, clean, and care for your camera.

Storage

When the camera will not be used for an extended period, remove the battery and store it in a cool, dry area with the terminal cover in place. To prevent mold or mildew, store the camera in a dry, well-ventilated area. Do not store your camera with naphtha or camphor moth balls or in locations that:

- are poorly ventilated or subject to humidities of over 60%,
- are next to equipment that produces strong electromagnetic fields, such as televisions or radios, or
- are exposed to temperatures above 50 °C (122 °F) or below -10 °C (14 °F)

Cleaning

Do not use alcohol, thinner, or other volatile chemicals.

- **Camera body:** Use a blower to remove dust and lint, then wipe gently with a soft, dry cloth. After using the camera at the beach or seaside, wipe off sand or salt with a cloth lightly dampened in distilled water and dry thoroughly. **Important:** *Dust or other foreign matter inside the camera may cause damage not covered under warranty.*
- **Lenses, viewfinder:** Glass surfaces are easily damaged. Remove dust and lint with a blower. If using an aerosol blower, keep the can vertical to prevent the discharge of liquid. To remove fingerprints and other stains, apply a small amount of lens cleaner to a soft cloth and clean with care.
- **Monitor:** Remove dust and lint with a blower. When removing fingerprints and other stains, wipe the surface lightly with a soft cloth or chamois leather. Do not apply pressure, as this could result in damage or malfunction.

Image Sensor Cleaning

If you suspect that dirt or dust on the image sensor is appearing in photographs, you can clean the sensor using the **Clean image sensor** option in the setup menu. The sensor can be cleaned at any time using the **Clean now** option, or cleaning can be performed automatically when the camera is turned off. If image sensor cleaning fails to resolve the problem, contact a Nikon-authorized service representative.

■ “Clean Now”

Holding the camera base down, select **Clean image sensor** in the setup menu, then highlight **Clean now** and press **OK**. The camera will check and clean the image sensor. No other operations can be performed until cleaning is complete; do not remove or disconnect the power source until cleaning ends and the setup menu is displayed.

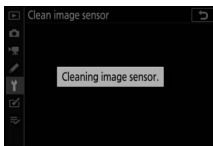
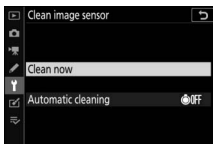
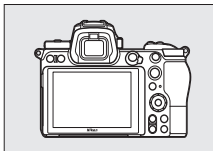



Image Sensor Cleaning

Using camera controls during shutdown interrupts image sensor cleaning.

If image sensor cleaning is performed several times in succession, image sensor cleaning may be temporarily disabled to protect the camera's internal circuitry. Cleaning can be performed again after a short wait.

■ ■ “Automatic Cleaning”

Choose from the following options:

 OFF Clean at shutdown	The image sensor is automatically cleaned during shutdown each time the camera is turned off.
Cleaning off	Automatic image sensor cleaning off.

1 Select Automatic Cleaning.

Display the **Clean image sensor** menu as described in “Clean Now” (book 423). Highlight **Automatic Cleaning** and press .

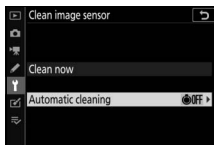

2 Select an option.

Highlight an option and press .

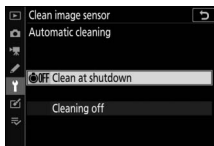

Manual Cleaning

If foreign matter cannot be removed from the image sensor using image sensor cleaning, the sensor can be cleaned manually as described below. Note, however, that the sensor is extremely delicate and easily damaged; we recommend that manual cleaning be performed only by a Nikon-authorized service representative.

1 Remove the lens.

Turn the camera off and remove the lens or body cap.

2 Examine the image sensor.

Holding the camera so that light falls on the image sensor, examine the sensor for dust or lint. If no foreign objects are present, proceed to Step 4.

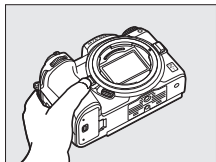

3 Clean the sensor.

Remove any dust and lint from the sensor with a blower. Do not use a blower-brush, as the bristles could damage the sensor. Dirt that cannot be removed with a blower can only be removed by Nikon-authorized service personnel. Under no circumstances should you touch or wipe the sensor.

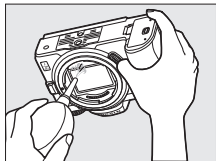

4 Replace the lens or body cap.

✔ Foreign Matter on the Image Sensor

Foreign matter entering the camera when lenses or body caps are removed or exchanged (or in rare circumstances lubricant or fine particles from the camera itself) may adhere to the image sensor, where it may appear in photographs taken under certain conditions. To protect the camera when no lens is in place, be sure to replace the body cap provided with the camera, being careful to first remove all dust and other foreign matter that may be adhering to the camera mount, lens mount, and body cap. Avoid attaching the body cap or exchanging lenses in dusty environments.

Should foreign matter find its way onto the image sensor, use the image sensor cleaning option as described in “Image Sensor Cleaning” (☞ 423). If the problem persists, clean the sensor manually (☞ 426) or have the sensor cleaned by authorized Nikon service personnel. Photographs affected by the presence of foreign matter on the sensor can be retouched using the clean image options available in some imaging applications.

✔ Servicing the Camera and Accessories

The camera is a precision device and requires regular servicing. Nikon recommends that the camera be inspected by the original retailer or a Nikon-authorized service representative once every one to two years, and that it be serviced once every three to five years (note that fees apply to these services). Frequent inspection and servicing are particularly recommended if the camera is used professionally. Any accessories regularly used with the camera, such as lenses or optional flash units, should be included when the camera is inspected or serviced.

Caring for the Camera and Battery: Cautions

Do not drop: The product may malfunction if subjected to strong shocks or vibration.

Keep dry: This product is not waterproof, and may malfunction if immersed in water or exposed to high levels of humidity. Rusting of the internal mechanism can cause irreparable damage.

Avoid sudden changes in temperature: Sudden changes in temperature, such as those that occur when entering or leaving a heated building on a cold day, can cause condensation inside the device. To prevent condensation, place the device in a carrying case or plastic bag before exposing it to sudden changes in temperature.

Keep away from strong magnetic fields: Do not use or store this device in the vicinity of equipment that generates strong electromagnetic radiation or magnetic fields. Static charges or the magnetic fields produced by equipment such as radio transmitters could interfere with the display, damage data stored on the memory card, or affect the product's internal circuitry.

Do not leave the lens pointed at the sun: Do not leave the lens pointed at the sun or other strong light source for an extended period. Intense light may cause the image sensor to deteriorate or produce a white blur effect in photographs.

Lasers and other bright light sources: Do not direct lasers or other extremely bright light sources toward the lens, as this could damage the camera's image sensor.

Turn the product off before removing or disconnecting the power source: Do not unplug the product or remove the battery while the product is on or while images are being recorded or deleted. Forcibly cutting power in these circumstances could result in loss of data or in damage to product memory or internal circuitry. To prevent an accidental interruption of power, avoid carrying the product from one location to another while an AC adapter is connected.

Cleaning: When cleaning the camera body, use a blower to gently remove dust and lint, then wipe gently with a soft, dry cloth. After using the camera at the beach or seaside, wipe off any sand or salt using a cloth lightly dampened in pure water and then dry the camera thoroughly. In rare instances, static electricity may cause the LCD displays to light up or go dark. This does not indicate a malfunction, and the display will soon return to normal.

Lenses, viewfinders, and other glass elements are easily damaged. Dust and lint should be gently removed with a blower. When using an aerosol blower, keep the can vertical to prevent discharge of liquid. To remove fingerprints and other stains from glass surfaces, apply a small amount of lens cleaner to a soft cloth and wipe the glass carefully.

Do not touch the image sensor: Under no circumstances should you exert pressure on the image sensor, poke it with cleaning tools, or subject it to powerful air currents from a blower. These actions could scratch or otherwise damage the sensor. For information on cleaning the image sensor, see “Image Sensor Cleaning” (□ 423).

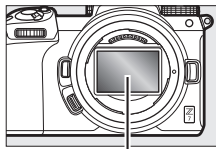

Image sensor

Lens contacts: Keep the lens contacts clean and be careful not to touch them with your fingers or with tools or other objects.

Storage: To prevent mold or mildew, store the camera in a dry, well-ventilated area. If you are using an AC adapter, unplug the adapter to prevent fire. If the product will not be used for an extended period, remove the battery to prevent leakage and store the camera in a plastic bag containing a desiccant. Do not, however, store the camera case in a plastic bag, as this may cause the material to deteriorate. Note that desiccant gradually loses its capacity to absorb moisture and should be replaced at regular intervals.

To prevent mold or mildew, take the camera out of storage at least once a month. Turn the camera on and release the shutter a few times before putting it away.

Store the battery in a cool, dry place. Replace the terminal cover before putting the battery away.

Notes on the monitor and viewfinder: These displays are constructed with extremely high precision; at least 99.99% of pixels are effective, with no more than 0.01% being missing or defective. Hence while these displays may contain pixels that are always lit (white, red, blue, or green) or always off (black), this is not a malfunction and has no effect on images recorded with the device.

Images in the monitor may be difficult to see in a bright light. Do not apply pressure to the monitor, as this could cause damage or malfunction. Dust or lint can be removed with a blower. Stains can be removed by wiping lightly with a soft cloth or chamois leather. Should the monitor break, care should be taken to avoid injury from broken glass and to prevent liquid crystal from the monitor touching the skin or entering the eyes and mouth.

Should you feel unwell or experience any of the following symptoms while framing shots in the viewfinder, discontinue use until your condition improves: nausea, eye pain, eye fatigue, dizziness, headache, stiffness in your neck or shoulders, carsickness, or loss of hand-eye coordination. The same applies should you start to feel unwell when watching the shooting display flicker rapidly on and off during burst photography.

Noise in the form of lines may in rare cases appear in pictures that include bright lights or back-lit subjects.

The battery and charger: Batteries may leak or explode if improperly handled. Observe the following precautions when handling batteries and chargers:

- Use only batteries approved for use in this equipment.
- Do not expose the battery to flame or excessive heat.
- Keep the battery terminals clean.
- Turn the product off before replacing the battery.
- The battery may become hot while in use. Observe caution when handling the battery immediately after use.

- Remove the battery from the camera or charger when not in use and replace the terminal cover. These devices draw minute amounts of charge even when off and could draw the battery down to the point that it will no longer function. If the battery will not be used for some time, insert it in the camera and run it flat before removing it from the camera for storage. The battery should be stored in a cool location with an ambient temperature of 15 °C to 25 °C (59 °F to 77 °F; avoid hot or extremely cold locations). Repeat this process at least once every six months.
- Turning the camera on or off repeatedly when the battery is fully discharged will shorten battery life. Batteries that have been fully discharged must be charged before use.
- The internal temperature of the battery may rise while the battery is in use. Attempting to charge the battery while the internal temperature is elevated will impair battery performance, and the battery may not charge or charge only partially. Wait for the battery to cool before charging.
- Charge the battery indoors at ambient temperatures of 5 °C to 35 °C (41 °F to 95 °F). Do not use the battery at ambient temperatures below 0 °C (32 °F) or above 40 °C (104 °F); failure to observe this precaution could damage the battery or impair its performance. Capacity may be reduced and charging times increase at battery temperatures from 0 °C (32 °F) to 15 °C (59 °F) and from 45 °C (113 °F) to 60 °C (140 °F). The battery will not charge if its temperature is below 0 °C (32 °F) or above 60 °C (140 °F).
- If the **CHARGE** lamp flashes quickly (about eight times a second) during charging, confirm that the temperature is in the correct range and then unplug the charger and remove and reinsert the battery. If the problem persists, cease use immediately and take battery and charger to your retailer or a Nikon-authorized service representative.
- Do not move the charger or touch the battery during charging. Failure to observe this precaution could in very rare instances result in the charger showing that charging is complete when the battery is only partially charged. Remove and reinsert the battery to begin charging again.

- Battery capacity may temporarily drop if the battery is charged at low temperatures or used at a temperature below the temperature at which it was charged. If the battery is charged at a temperature below 5 °C (41 °F), the battery life indicator in the **Battery info** display may show a temporary decrease.
- Continuing to charge the battery after it is fully charged can impair battery performance.
- A marked drop in the time a fully charged battery retains its charge when used at room temperature indicates that it requires replacement. Purchase a new EN-EL15b battery.
- The supplied power cable and AC wall adapter are for use with the MH-25a only. Use the charger with compatible batteries only. Unplug when not in use.
- Do not short the charger terminals. Failure to observe this precaution could result in overheating and damage to the charger.
- Charge the battery before use. When taking photographs on important occasions, ready a spare battery and keep it fully charged. Depending on your location, it may be difficult to purchase replacement batteries on short notice. Note that on cold days, the capacity of batteries tends to decrease. Be sure the battery is fully charged before taking photographs outside in cold weather. Keep a spare battery in a warm place and exchange the two as necessary. Once warmed, a cold battery may recover some of its charge.
- Recycle rechargeable batteries in accord with local regulations, being sure to first insulate the terminals with tape.

The charging AC adapter: Observe the precautions below when using the charging AC adapter.

- Do not move the camera during charging. Failure to observe this precaution could in very rare instances result in the camera showing that charging is complete when the battery is only partially charged. Disconnect and reconnect the adapter to begin charging again.
- Do not short the adapter terminals. Failure to observe this precaution could result in overheating and damage to the adapter.
- Unplug the adapter when it is not in use.

Specifications

Nikon Z 7/Z 6 Digital Camera

Type	
Type	Digital camera with support for interchangeable lenses
Lens mount	Nikon Z mount
Lens	
Compatible lenses	<ul style="list-style-type: none">• Z mount NIKKOR lenses• F mount NIKKOR lenses with mount adapter; restrictions may apply
Effective pixels	
Effective pixels	<ul style="list-style-type: none">• Z 7: 45.7 million• Z 6: 24.5 million
Image sensor	
Image sensor	35.9 × 23.9 mm CMOS sensor (Nikon FX format)
Total pixels	<ul style="list-style-type: none">• Z 7: 46.89 million• Z 6: 25.28 million
Dust-Reduction System	Image Dust Off reference data (requires Capture NX-D); image sensor cleaning
Storage	
Image size (pixels)	<ul style="list-style-type: none">• Z 7:<ul style="list-style-type: none">- FX (36×24) image area<ul style="list-style-type: none">8256 × 5504 (Large: 45.4 M)6192 × 4128 (Medium: 25.6 M)4128 × 2752 (Small: 11.4 M)- DX (24×16) image area<ul style="list-style-type: none">5408 × 3600 (Large: 19.5 M)4048 × 2696 (Medium: 10.9 M)2704 × 1800 (Small: 4.9 M)- 5 : 4 (30×24) image area<ul style="list-style-type: none">6880 × 5504 (Large: 37.9 M)5152 × 4120 (Medium: 21.2 M)3440 × 2752 (Small: 9.5 M)

Storage

Image size (pixels)

- **1 : 1 (24×24) image area**
 - 5504 × 5504 (Large: 30.3 M)
 - 4128 × 4128 (Medium: 17.0 M)
 - 2752 × 2752 (Small: 7.6 M)
- **16 : 9 (36×20) image area**
 - 8256 × 4640 (Large: 38.3 M)
 - 6192 × 3480 (Medium: 21.5 M)
 - 4128 × 2320 (Small: 9.6 M)
- **Photographs taken during movie recording at a frame size of 3840 × 2160:** 3840 × 2160
- **Photographs taken during movie recording at other frame sizes:** 1920 × 1080
- **Z 6:**
 - **FX (36×24) image area**
 - 6048 × 4024 (Large: 24.3 M)
 - 4528 × 3016 (Medium: 13.7 M)
 - 3024 × 2016 (Small: 6.1 M)
 - **DX (24×16) image area**
 - 3936 × 2624 (Large: 10.3 M)
 - 2944 × 1968 (Medium: 5.8 M)
 - 1968 × 1312 (Small: 2.6 M)
 - **1 : 1 (24×24) image area**
 - 4016 × 4016 (Large: 16.1 M)
 - 3008 × 3008 (Medium: 9.0 M)
 - 2000 × 2000 (Small: 4.0 M)
 - **16 : 9 (36×20) image area**
 - 6048 × 3400 (Large: 20.6 M)
 - 4528 × 2544 (Medium: 11.5 M)
 - 3024 × 1696 (Small: 5.1 M)
 - **Photographs taken during movie recording at a frame size of 3840 × 2160:** 3840 × 2160
 - **Photographs taken during movie recording at other frame sizes:** 1920 × 1080



Storage	
File format	<ul style="list-style-type: none"> • NEF (RAW): 12 or 14 bit (lossless compressed, compressed, or uncompressed); large, medium, and small available (medium and small images are recorded at a bit depth of 12 bits using lossless compression) • TIFF (RGB) • JPEG: JPEG-Baseline compliant with fine (approx. 1 : 4), normal (approx. 1 : 8), or basic (approx. 1 : 16) compression; optimal quality compression available • NEF (RAW)+JPEG: Single photograph recorded in both NEF (RAW) and JPEG formats
Picture Control System	Auto, Standard, Neutral, Vivid, Monochrome, Portrait, Landscape, Flat, Creative Picture Controls (Dream, Morning, Pop, Sunday, Somber, Dramatic, Silence, Bleached, Melancholic, Pure, Denim, Toy, Sepia, Blue, Red, Pink, Charcoal, Graphite, Binary, Carbon); selected Picture Control can be modified; storage for custom Picture Controls
Media	XQD and CFexpress (Type B) memory cards
File system	DCF 2.0, Exif 2.31, PictBridge
Viewfinder	
Viewfinder	1.27-cm/0.5-in. approx. 3690k-dot (Quad VGA) OLED electronic viewfinder with color balance and auto and 11-level manual brightness controls
Frame coverage	Approx. 100% horizontal and 100% vertical
Magnification	Approx. 0.8× (50 mm lens at infinity, -1.0 m^{-1})
Eyepoint	21 mm (-1.0 m^{-1} ; from center surface of viewfinder eyepiece lens)
Diopter adjustment	$-4 - +2 \text{ m}^{-1}$
Eye sensor	Automatically switches between monitor and viewfinder displays

Monitor	
Monitor	8-cm/3.2-in., approx. 2100k-dot tilting TFT touch-sensitive LCD with 170° viewing angle, approximately 100% frame coverage, and color balance and 11-level manual brightness controls
Shutter	
Type	Electronically-controlled vertical-travel focal-plane mechanical shutter; electronic front-curtain shutter; electronic shutter
Speed	$\frac{1}{8000}$ – 30 s in steps of $\frac{1}{3}$ or $\frac{1}{2}$ EV, bulb, time, X200
Flash sync speed	$X = \frac{1}{200}$ s; synchronizes with shutter at $\frac{1}{200}$ s or slower; Auto FP High-Speed sync supported
Release	
Release mode	Single frame, low-speed continuous, high-speed continuous, high-speed continuous (extended), self-timer
Approximate maximum frame advance rate (measured under Nikon-specified test conditions)	<ul style="list-style-type: none"> • Z 7: <ul style="list-style-type: none"> - Low-speed continuous: 1–5 fps - High-speed continuous: 5.5 fps (14-bit NEF/RAW: 5 fps) - High-speed continuous (extended): 9 fps (14-bit NEF/RAW: 8 fps) • Z 6: <ul style="list-style-type: none"> - Low-speed continuous: 1–5 fps - High-speed continuous: 5.5 fps - High-speed continuous (extended): 12 fps (14-bit NEF/RAW: 9 fps)
Self-timer	2 s, 5 s, 10 s, 20 s; 1–9 exposures at intervals of 0.5, 1, 2, or 3 s

Exposure	
Metering system	TTL metering using camera image sensor
Metering mode	<ul style="list-style-type: none"> • Matrix metering • Center-weighted metering: Weight of 75% given to 12 mm circle in center of frame; weighting can instead be based on average of entire frame • Spot metering: Meters 4 mm circle (about 1.5% of frame) centered on selected focus point • Highlight-weighted metering
Range (ISO 100, f/2.0 lens, 20 °C/68 °F)	<ul style="list-style-type: none"> • Z7: -3 – +17 EV • Z6: -4 – +17 EV
Mode	Auto (AUTO); programmed auto with flexible program (P); shutter-priority auto (S); aperture-priority auto (A); manual (M); user settings (U1, U2, U3)
Exposure compensation	-5 – +5 EV in increments of 1/3 or 1/2 EV available in modes P, S, A, and M
Exposure lock	Luminosity locked at detected value
ISO sensitivity (Recommended Exposure Index)	<ul style="list-style-type: none"> • Z7: ISO 64 – 25600 in steps of 1/3 or 1/2 EV. Can also be set to approx. 0.3, 0.5, 0.7, or 1 EV (ISO 32 equivalent) below ISO 64 or to approx. 0.3, 0.5, 0.7, 1, or 2 EV (ISO 102400 equivalent) above ISO 25600; auto ISO sensitivity control available • Z6: ISO 100 – 51200 in steps of 1/3 or 1/2 EV. Can also be set to approx. 0.3, 0.5, 0.7, or 1 EV (ISO 50 equivalent) below ISO 100 or to approx. 0.3, 0.5, 0.7, 1, or 2 EV (ISO 204800 equivalent) above ISO 51200; auto ISO sensitivity control available
Active D-Lighting	Can be selected from Auto, Extra high, High, Normal, Low, or Off
Multiple exposure	Add, average, lighten, darken
Other options	HDR (high dynamic range), photo mode flicker reduction

Focus	
Autofocus	Hybrid phase-detection/contrast AF with AF assist
Detection range (single-servo AF, photo shooting mode, ISO 100, f/2.0 lens, 20 °C/68 °F)	<ul style="list-style-type: none"> • Z7: -2 – +19 EV (with low-light AF: -4 – +19 EV) • Z6: -3.5 – +19 EV (with low-light AF: -6 – +19 EV)
Lens servo	<ul style="list-style-type: none"> • Autofocus (AF): Single-servo AF (AF-S); continuous-servo AF (AF-C); full-time AF (AF-F; available only in movie mode); predictive focus tracking • Manual focus (M): Electronic rangefinder can be used
Focus points (single-point AF, photo shooting mode, FX image area)	<ul style="list-style-type: none"> • Z7: 493 • Z6: 273
AF-area mode	Pinpoint, single-point, and dynamic-area AF (pinpoint and dynamic-area AF available in photo mode only); wide-area AF (S); wide-area AF (L); auto-area AF
Focus lock	Focus can be locked by pressing shutter-release button halfway (single-servo AF) or by pressing center of sub-selector
Vibration reduction (VR)	
Camera VR	5-axis image sensor shift
Lens VR	Lens shift (available with VR lenses)
Flash	
Flash control	TTL: i-TTL flash control; i-TTL balanced fill-flash is used with matrix, center-weighted, and highlight-weighted metering, standard i-TTL fill-flash with spot metering
Flash mode	Front-curtain sync, slow sync, rear-curtain sync, red-eye reduction, red-eye reduction with slow sync, off
Flash compensation	-3 – +1 EV in increments of 1/3 or 1/2 EV available in modes P , S , A , and M

Flash	
Flash-ready indicator	Lights when optional flash unit is fully charged; flashes as underexposure warning after flash is fired at full output
Accessory shoe	ISO 518 hot-shoe with sync and data contacts and safety lock
Nikon Creative Lighting System (CLS)	i-TTL flash control, radio-controlled Advanced Wireless Lighting, optical Advanced Wireless Lighting, modeling illumination, FV lock, Color Information Communication, Auto FP High-Speed Sync, unified flash control
White balance	
White balance	Auto (3 types), natural light auto, direct sunlight, cloudy, shade, incandescent, fluorescent (7 types), flash, choose color temperature (2500 K–10,000 K), preset manual (up to 6 values can be stored), all except choose color temperature with fine-tuning
Bracketing	
Bracketing types	Exposure, flash, white balance, and ADL
Movie	
Metering system	TTL metering using camera image sensor
Metering mode	Matrix, center-weighted, or highlight-weighted
Frame size (pixels) and frame rate	<ul style="list-style-type: none"> • 3840 × 2160 (4K UHD); 30p (progressive), 25p, 24p • 1920 × 1080; 120p, 100p, 60p, 50p, 30p, 25p, 24p • 1920×1080 (slow-motion); 30p ×4, 25p ×4, 24p ×5 <p>Actual frame rates for 120p, 100p, 60p, 50p, 30p, 25p, and 24p are 119.88, 100, 59.94, 50, 29.97, 25, and 23.976 fps respectively; quality selection available at all sizes except 3840 × 2160, 1920 × 1080 120p/100p, and 1920 × 1080 slow-motion, when quality is fixed at ★ (high)</p>

Movie	
File format	MOV, MP4
Video compression	H.264/MPEG-4 Advanced Video Coding
Audio recording format	Linear PCM, AAC
Audio recording device	Built-in stereo or external microphone with attenuator option; sensitivity adjustable
Exposure compensation	-3 – +3 EV in increments of $\frac{1}{3}$ or $\frac{1}{2}$ EV available in modes P , S , A , and M
ISO sensitivity (Recommended Exposure Index)	<ul style="list-style-type: none"> • Z7: <ul style="list-style-type: none"> - : Auto ISO sensitivity control (ISO 64 to 25600) - P, S, A: Auto ISO sensitivity control (ISO 64 to Hi 2) with selectable upper limit - M: Auto ISO sensitivity control (ISO 64 to Hi 2) available with selectable upper limit; manual selection (ISO 64 to 25600 in steps of $\frac{1}{3}$ or $\frac{1}{2}$ EV) with additional options available equivalent to approximately 0.3, 0.5, 0.7, 1, or 2 EV (ISO 102400 equivalent) above ISO 25600 • Z6: <ul style="list-style-type: none"> - : Auto ISO sensitivity control (ISO 100 to 51200) - P, S, A: Auto ISO sensitivity control (ISO 100 to Hi 2) with selectable upper limit - M: Auto ISO sensitivity control (ISO 100 to Hi 2) available with selectable upper limit; manual selection (ISO 100 to 51200 in steps of $\frac{1}{3}$ or $\frac{1}{2}$ EV) with additional options available equivalent to approximately 0.3, 0.5, 0.7, 1, or 2 EV (ISO 204800 equivalent) above ISO 51200
Active D-Lighting	Can be selected from Same as photo settings , Extra high , High , Normal , Low , or Off
Other options	Time-lapse movies, electronic vibration reduction, time codes, movie log output (N-Log)

Playback	
Playback	Full-frame and thumbnail (4, 9, or 72 images) playback with playback zoom, playback zoom cropping, movie playback, photo and/or movie slide shows, histogram display, highlights, photo information, location data display, picture rating, and auto image rotation
Interface	
USB	Type C connector (SuperSpeed USB); connection to built-in USB port is recommended
HDMI output	Type C HDMI connector
Accessory terminal	Can be used with MC-DC2 and other optional accessories
Audio input	Stereo mini-pin jack (3.5 mm diameter; plug-in power supported)
Audio output	Stereo mini-pin jack (3.5 mm diameter)
Wi-Fi/Bluetooth	
Wi-Fi	<ul style="list-style-type: none"> • Standards: <ul style="list-style-type: none"> - IEEE 802.11b/g/n/a/ac (Europe, U.S.A., Canada, Mexico) - IEEE 802.11b/g/n/a (other countries in the Americas) • Operating frequency: <ul style="list-style-type: none"> - 2412–2462 MHz (channel 11) and 5180–5825 MHz (U.S.A., Canada, Mexico) - 2412–2462 MHz (channel 11) and 5180–5805 MHz (other countries in the Americas) - 2412–2462 MHz (channel 11) and 5745–5805 MHz (Georgia) - 2412–2462 MHz (channel 11) and 5180–5320 MHz (other European countries) • Maximum output power (EIRP): <ul style="list-style-type: none"> - Z7: 2.4 GHz band: 7.0 dBm 5 GHz band: 9.1 dBm (Georgia) 5 GHz band: 12.1 dBm (other countries) - Z6: 2.4 GHz band: 7.4 dBm 5 GHz band: 9.2 dBm (Georgia) 5 GHz band: 12.2 dBm (other countries) • Authentication: Open system, WPA2-PSK

Wi-Fi/Bluetooth	
Bluetooth	<ul style="list-style-type: none"> • Communication protocols: Bluetooth Specification Version 4.2 • Operating frequency: Bluetooth: 2402–2480 MHz Bluetooth Low Energy: 2402–2480 MHz • Maximum output power (EIRP): <ul style="list-style-type: none"> - Z 7: Bluetooth: 1.5 dBm Bluetooth Low Energy: 0 dBm - Z 6: Bluetooth: 1.9 dBm Bluetooth Low Energy: 0.4 dBm
Range (line of sight)	Approximately 10 m (32 ft) without interference; range may vary with signal strength and presence or absence of obstacles
Power source	
Battery	One EN-EL15b rechargeable Li-ion battery (☐ 471); EN-EL15a/EN-EL15 can also be used, but note that you may not be able to take as many pictures on a single charge and that charging AC adapter can be used to charge EN-EL15b batteries only
Battery pack	MB-N10 battery pack (available separately); takes two EN-EL15b * batteries * EN-EL15a/EN-EL15 batteries can be used in place of the EN-EL15b. The number of pictures that can be taken on a single charge (i.e., battery endurance) may however drop compared to the EN-EL15b.
Charging AC adapter	EH-7P charging AC adapter (available separately)
AC adapter	EH-5c/EH-5b AC adapter (requires EP-5B power connector, which is available separately)
Tripod socket	
Tripod socket	1/4 in. (ISO 1222)

Dimensions/weight	
Dimensions (W × H × D)	Approx. 134 × 100.5 × 67.5 mm (5.3 × 4 × 2.7 in.)
Weight	Approx. 675 g (1 lb. 7.9 oz.) with battery and memory card but without body cap; approx. 585 g/1 lb. 4.7 oz. (camera body only)
Operating environment	
Temperature	0 °C–40 °C (+32 °F–104 °F)
Humidity	85% or less (no condensation)

- Unless otherwise stated, all measurements are performed in conformity with Camera and Imaging Products Association (CIPA) standards or guidelines.
- All figures are for a camera with a fully-charged battery.
- The sample images displayed on the camera and the images and illustrations in the manuals are for expository purposes only.
- Nikon reserves the right to change the appearance and specifications of the hardware and software described in this manual at any time and without prior notice. Nikon will not be held liable for damages that may result from any mistakes that this manual may contain.

■ ■ MH-25a Battery Charger

Rated input	AC 100–240 V, 50/60 Hz, 0.23–0.12 A
Rated output	DC 8.4 V/1.2 A
Supported batteries	Nikon EN-EL15b rechargeable Li-ion batteries
Charging time	Approx. 2 hours and 35 minutes at an ambient temperature of 25 °C (77 °F) when no charge remains
Operating temperature	0 °C–40 °C (+32 °F–104 °F)
Dimensions (W × H × D)	Approx. 95 × 33.5 × 71 mm (3.7 × 1.3 × 2.8 in.), excluding projections
Length of power cable	Approx. 1.5 m (4.9 ft), if supplied
Weight	Approx. 115 g (4.1 oz), excluding supplied power connector (power cable or AC wall adapter)

The symbols on this product represent the following:

~ AC, --- DC,  Class II equipment (The construction of the product is double-insulated.)

■ ■ EH-7P Charging AC Adapter (Available Separately)

Rated input	AC 100–240 V, 50/60 Hz, MAX 0.5 A
Rated output	DC 5.0 V/3.0 A, 15.0 W
Supported batteries	Nikon EN-EL15b rechargeable Li-ion batteries
Operating temperature	0 °C–40 °C (+32 °F–104 °F)
Average active efficiency	81.80%
Efficiency at low load (10%)	72.50%
No-load power consumption	0.075 W
Dimensions (W × H × D)	Approx. 65.5 × 26.5 × 58.5 mm (2.6 × 1.1 × 2.4 in.), excluding plug adapter
Weight	Approx. 135 g (4.8 oz), excluding plug adapter

The EH-7P comes with a plug adapter attached in countries or regions where required; the shape of the plug adapter varies with the country of sale. Do not attempt to remove the plug adapter, as this could damage the product.

The symbols on this product represent the following:

~ AC, --- DC,  Class II equipment (The construction of the product is double-insulated.)

Notice for Customers in Europe

Distributor (Importer for EU Countries)

Nikon Europe B.V.

Tripolis 100, Burgerweeshuispad 101, 1076 ER Amsterdam, The Netherlands
+31-20-7099-000

Commercial registration number: 34036589



■ ■ EN-EL15b Rechargeable Li-ion Battery

Type	Rechargeable lithium-ion battery
Rated capacity	7.0 V/1900 mAh
Operating temperature	0 °C–40 °C (+32 °F–104 °F)
Dimensions (W × H × D)	Approx. 40 × 56 × 20.5 mm (1.6 × 2.2 × 0.8 in.)
Weight	Approx. 80 g (2.9 oz), excluding terminal cover

Nikon reserves the right to change the appearance and specifications of the hardware and software described in this manual at any time and without prior notice. Nikon will not be held liable for damages that may result from any mistakes that this manual may contain.

Disposing of Data Storage Devices

Please note that deleting images or formatting memory cards or other data storage devices does not completely erase the original image data. Deleted files can sometimes be recovered from discarded storage devices using commercially available software, potentially resulting in the malicious use of personal image data. Ensuring the privacy of such data is the user's responsibility.

Before discarding a data storage device or transferring ownership to another person, erase all data using commercial deletion software, or format the device and then completely refill it with images containing no private information (for example, pictures of empty sky). Care should be taken to avoid injury when physically destroying data storage devices.

Before discarding the camera or transferring ownership to another person, you should also use the **Reset all settings** option in the camera setup menu to delete network settings and other personal information.

Supported Standards

- **DCF Version 2.0:** The **D**esign **R**ule for **C**amera **F**ile **S**ystem (DCF) is a standard widely used in the digital camera industry to ensure compatibility among different makes of camera.
- **Exif version 2.31:** The camera supports Exif (**E**xchangeable **I**mage **F**ile **F**ormat for **D**igital **S**till **C**ameras) version 2.31, a standard in which information stored with photographs is used for optimal color reproduction when the images are output on Exif-compliant printers.
- **PictBridge:** A standard developed through cooperation with the digital camera and printer industries, allowing photographs to be output directly to a printer without first transferring them to a computer.
- **HDMI:** **H**igh-**D**efinition **M**ultimedia **I**nterface is a standard for multimedia interfaces used in consumer electronics and AV devices capable of transmitting audiovisual data and control signals to HDMI-compliant devices via a single cable connection.

Trademark Information

CFexpress is a trademark of the CompactFlash Association in the United States and other countries. NVM Express is a trademark of NVM Express Inc. in the United States and other countries. IOS is a trademark or registered trademark of Cisco Systems, Inc., in the United States and/or other countries and is used under license. Windows is either a registered trademark or a trademark of Microsoft Corporation in the United States and/or other countries. Mac, macOS, OS X, Apple®, App Store®, the Apple logos, iPhone®, iPad®, and iPod touch® are trademarks of Apple Inc. registered in the U.S. and/or other countries. Android, Google Play and the Google Play logo are trademarks of Google LLC. The Android robot is reproduced or modified from work created and shared by Google and used according to terms described in the Creative Commons 3.0 Attribution License. PictBridge is a trademark of the Camera and Imaging Products Association (CIPA). XQD is a trademark of Sony Corporation. HDMI, the HDMI logo and High-Definition Multimedia Interface are trademarks or registered trademarks of HDMI Licensing, LLC.

HDMI

Wi-Fi and the Wi-Fi logo are trademarks or registered trademarks of the Wi-Fi Alliance. The Bluetooth® word mark and logos are registered trademarks owned by Bluetooth SIG, Inc. and any use of such marks by Nikon Corporation is under license.

All other trade names mentioned in this manual or the other documentation provided with your Nikon product are trademarks or registered trademarks of their respective holders.

Use of the Made for Apple badge means that an accessory has been designed to connect specifically to the Apple products identified in the badge, and has been certified by the developer to meet Apple performance standards. Apple is not responsible for the operation of this device or its compliance with safety and regulatory standards. Please note that the use of this accessory with an Apple product may affect wireless performance.

 **FreeType License (FreeType2)**

Portions of this software are copyright © 2012 The FreeType Project (<https://www.freetype.org>). All rights reserved.

 **MIT License (HarfBuzz)**

Portions of this software are copyright © 2018 The HarfBuzz Project (<https://www.freedesktop.org/wiki/Software/HarfBuzz>). All rights reserved.

Unicode® Character Database License (Unicode® Character Database)

This software incorporates Unicode® Character Database open-source code. The license for this open-source code is given below.

COPYRIGHT AND PERMISSION NOTICE

Copyright © 1991-2019 Unicode, Inc. All rights reserved.

Distributed under the Terms of Use in

<https://www.unicode.org/copyright.html>.

Permission is hereby granted, free of charge, to any person obtaining a copy of the Unicode data files and any associated documentation (the "Data Files") or Unicode software and any associated documentation (the "Software") to deal in the Data Files or Software without restriction, including without limitation the rights to use, copy, modify, merge, publish, distribute, and/or sell copies of the Data Files or Software, and to permit persons to whom the Data Files or Software are furnished to do so, provided that either

- (a) this copyright and permission notice appear with all copies of the Data Files or Software, or
- (b) this copyright and permission notice appear in associated Documentation.

THE DATA FILES AND SOFTWARE ARE PROVIDED "AS IS", WITHOUT WARRANTY OF ANY KIND, EXPRESS OR IMPLIED, INCLUDING BUT NOT LIMITED TO THE WARRANTIES OF MERCHANTABILITY, FITNESS FOR A PARTICULAR PURPOSE AND NONINFRINGEMENT OF THIRD PARTY RIGHTS.

IN NO EVENT SHALL THE COPYRIGHT HOLDER OR HOLDERS INCLUDED IN THIS NOTICE BE LIABLE FOR ANY CLAIM, OR ANY SPECIAL INDIRECT OR CONSEQUENTIAL DAMAGES, OR ANY DAMAGES WHATSOEVER RESULTING FROM LOSS OF USE, DATA OR PROFITS, WHETHER IN AN ACTION OF CONTRACT, NEGLIGENCE OR OTHER TORTIOUS ACTION, ARISING OUT OF OR IN CONNECTION WITH THE USE OR PERFORMANCE OF THE DATA FILES OR SOFTWARE.

Except as contained in this notice, the name of a copyright holder shall not be used in advertising or otherwise to promote the sale, use or other dealings in these Data Files or Software without prior written authorization of the copyright holder.

AVC Patent Portfolio License

THIS PRODUCT IS LICENSED UNDER THE AVC PATENT PORTFOLIO LICENSE FOR THE PERSONAL AND NON-COMMERCIAL USE OF A CONSUMER TO (i) ENCODE VIDEO IN COMPLIANCE WITH THE AVC STANDARD ("AVC VIDEO") AND/OR (ii) DECODE AVC VIDEO THAT WAS ENCODED BY A CONSUMER ENGAGED IN A PERSONAL AND NON-COMMERCIAL ACTIVITY AND/OR WAS OBTAINED FROM A VIDEO PROVIDER LICENSED TO PROVIDE AVC VIDEO. NO LICENSE IS GRANTED OR SHALL BE IMPLIED FOR ANY OTHER USE. ADDITIONAL INFORMATION MAY BE OBTAINED FROM MPEG LA, L.L.C. SEE <http://www.mpegla.com>

BSD License (NVM Express Driver)

The license conditions for the open source software incorporated in the camera's NVM Express driver are as follows:

[ComponentName.c]

Copyright (c) 2013, Intel Corporation. All rights reserved.

This program and the accompanying materials are licensed and made available under the terms and conditions of the BSD License which accompanies this distribution. The full text of the license may be found at <http://opensource.org/licenses/bsd-license.php>.

THE PROGRAM IS DISTRIBUTED UNDER THE BSD LICENSE ON AN "AS IS" BASIS, WITHOUT WARRANTIES OR REPRESENTATIONS OF ANY KIND, EITHER EXPRESS OR IMPLIED.

[NvmExpress.c]

Copyright (c) 2013 - 2017, Intel Corporation. All rights reserved.

This program and the accompanying materials are licensed and made available under the terms and conditions of the BSD License which accompanies this distribution. The full text of the license may be found at <http://opensource.org/licenses/bsd-license.php>.

THE PROGRAM IS DISTRIBUTED UNDER THE BSD LICENSE ON AN "AS IS" BASIS, WITHOUT WARRANTIES OR REPRESENTATIONS OF ANY KIND, EITHER EXPRESS OR IMPLIED.

[NvmExpress.h]

(C) Copyright 2016 Hewlett Packard Enterprise Development LP

Copyright (c) 2013 - 2018, Intel Corporation. All rights reserved.

This program and the accompanying materials are licensed and made available under the terms and conditions of the BSD License which accompanies this distribution. The full text of the license may be found at <http://opensource.org/licenses/bsd-license.php>.

THE PROGRAM IS DISTRIBUTED UNDER THE BSD LICENSE ON AN "AS IS" BASIS, WITHOUT WARRANTIES OR REPRESENTATIONS OF ANY KIND, EITHER EXPRESS OR IMPLIED.

[NvmExpressBlockIo.c]

Copyright (c) 2013 - 2018, Intel Corporation. All rights reserved.

This program and the accompanying materials are licensed and made available under the terms and conditions of the BSD License which accompanies this distribution. The full text of the license may be found at <http://opensource.org/licenses/bsd-license.php>.

THE PROGRAM IS DISTRIBUTED UNDER THE BSD LICENSE ON AN "AS IS" BASIS, WITHOUT WARRANTIES OR REPRESENTATIONS OF ANY KIND, EITHER EXPRESS OR IMPLIED.

[NvmExpressBlockIo.h]

Copyright (c) 2013 - 2016, Intel Corporation. All rights reserved.

This program and the accompanying materials are licensed and made available under the terms and conditions of the BSD License which accompanies this distribution. The full text of the license may be found at <http://opensource.org/licenses/bsd-license.php>

THE PROGRAM IS DISTRIBUTED UNDER THE BSD LICENSE ON AN "AS IS" BASIS, WITHOUT WARRANTIES OR REPRESENTATIONS OF ANY KIND, EITHER EXPRESS OR IMPLIED.

[NvmExpressDiskInfo.c]

Copyright (c) 2013, Intel Corporation. All rights reserved.

This program and the accompanying materials are licensed and made available under the terms and conditions of the BSD License which accompanies this distribution. The full text of the license may be found at <http://opensource.org/licenses/bsd-license.php>.

THE PROGRAM IS DISTRIBUTED UNDER THE BSD LICENSE ON AN "AS IS" BASIS, WITHOUT WARRANTIES OR REPRESENTATIONS OF ANY KIND, EITHER EXPRESS OR IMPLIED.

[NvmExpressDiskInfo.h]

Copyright (c) 2013, Intel Corporation. All rights reserved.

This program and the accompanying materials are licensed and made available under the terms and conditions of the BSD License which accompanies this distribution. The full text of the license may be found at <http://opensource.org/licenses/bsd-license.php>

THE PROGRAM IS DISTRIBUTED UNDER THE BSD LICENSE ON AN "AS IS" BASIS, WITHOUT WARRANTIES OR REPRESENTATIONS OF ANY KIND, EITHER EXPRESS OR IMPLIED.

[NvmExpressDxe.inf]

Copyright (c) 2013 - 2018, Intel Corporation. All rights reserved.

This program and the accompanying materials are licensed and made available under the terms and conditions of the BSD License which accompanies this distribution. The full text of the license may be found at <http://opensource.org/licenses/bsd-license.php>.

THE PROGRAM IS DISTRIBUTED UNDER THE BSD LICENSE ON AN "AS IS" BASIS, WITHOUT WARRANTIES OR REPRESENTATIONS OF ANY KIND, EITHER EXPRESS OR IMPLIED.

[NvmExpressDxe.uni]

Copyright (c) 2013 - 2014, Intel Corporation. All rights reserved.

This program and the accompanying materials are licensed and made available under the terms and conditions of the BSD License which accompanies this distribution. The full text of the license may be found at <http://opensource.org/licenses/bsd-license.php>.

THE PROGRAM IS DISTRIBUTED UNDER THE BSD LICENSE ON AN "AS IS" BASIS, WITHOUT WARRANTIES OR REPRESENTATIONS OF ANY KIND, EITHER EXPRESS OR IMPLIED.

[NvmExpressDxeExtra.uni]

Copyright (c) 2014 - 2018, Intel Corporation. All rights reserved.

This program and the accompanying materials are licensed and made available under the terms and conditions of the BSD License which accompanies this distribution. The full text of the license may be found at <http://opensource.org/licenses/bsd-license.php>

THE PROGRAM IS DISTRIBUTED UNDER THE BSD LICENSE ON AN "AS IS" BASIS, WITHOUT WARRANTIES OR REPRESENTATIONS OF ANY KIND, EITHER EXPRESS OR IMPLIED.

[NvmExpressHci.c]

Copyright (c) 2013 - 2018, Intel Corporation. All rights reserved.

This program and the accompanying materials are licensed and made available under the terms and conditions of the BSD License which accompanies this distribution. The full text of the license may be found at <http://opensource.org/licenses/bsd-license.php>.

THE PROGRAM IS DISTRIBUTED UNDER THE BSD LICENSE ON AN "AS IS" BASIS, WITHOUT WARRANTIES OR REPRESENTATIONS OF ANY KIND, EITHER EXPRESS OR IMPLIED.

[NvmExpressHci.h]

(C) Copyright 2016 Hewlett Packard Enterprise Development LP

Copyright (c) 2013 - 2015, Intel Corporation. All rights reserved.

This program and the accompanying materials are licensed and made available under the terms and conditions of the BSD License which accompanies this distribution. The full text of the license may be found at <http://opensource.org/licenses/bsd-license.php>.

THE PROGRAM IS DISTRIBUTED UNDER THE BSD LICENSE ON AN "AS IS" BASIS, WITHOUT WARRANTIES OR REPRESENTATIONS OF ANY KIND, EITHER EXPRESS OR IMPLIED.

[NvmExpressPassthru.c]

(C) Copyright 2014 Hewlett-Packard Development Company, L.P.

Copyright (c) 2013 - 2018, Intel Corporation. All rights reserved.

This program and the accompanying materials are licensed and made available under the terms and conditions of the BSD License which accompanies this distribution. The full text of the license may be found at <http://opensource.org/licenses/bsd-license.php>.

THE PROGRAM IS DISTRIBUTED UNDER THE BSD LICENSE ON AN "AS IS" BASIS, WITHOUT WARRANTIES OR REPRESENTATIONS OF ANY KIND, EITHER EXPRESS OR IMPLIED.

NIKKOR Z 24–70mm f/4 S Lens User's Manual

This section is included as a lens manual for purchasers of the NIKKOR Z 24–70mm f/4 S lens kit. Note that lens kits may not be available in some countries or regions.

Using the Lens

■ Parts of the Lens: Names and Functions

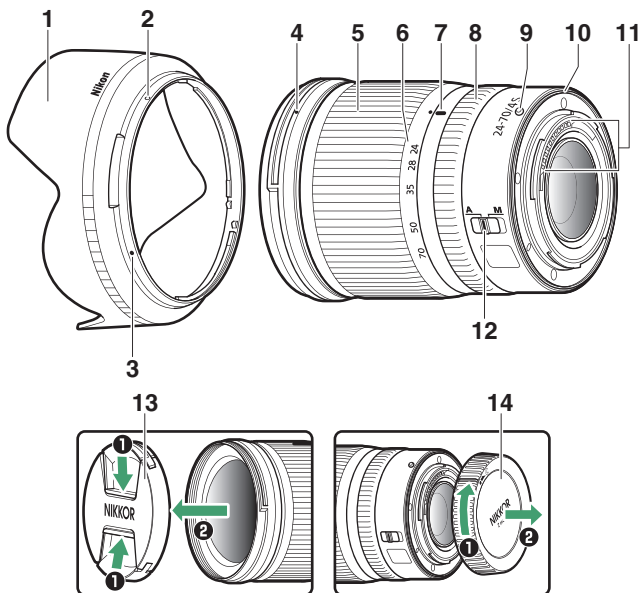

1 Lens hood	Lens hoods block stray light that would otherwise cause flare or ghosting. They also serve to protect the lens.
2 Lens hood lock mark	
3 Lens hood alignment mark	Use when attaching the lens hood.
4 Lens hood mounting mark	Use when attaching the lens hood.
5 Zoom ring	Rotate to zoom in or out. Be sure to extend the lens before use.
6 Focal length scale	Determine the approximate focal length when zooming the lens in or out.
7 Focal length mark	
8 Control ring	<ul style="list-style-type: none"> • Autofocus mode selected: In autofocus mode, you can rotate this customizable ring to perform a function selected with the camera. • Manual focus mode selected: Rotate to focus.
9 Lens mounting mark	Use when mounting the lens on the camera.
10 Rubber lens-mount gasket	—
11 CPU contacts	Used to transfer data to and from the camera.
12 Focus-mode switch	Choose A for autofocus, M for manual focus. Note that regardless of the setting chosen, focus must be adjusted manually when manual focus mode is selected using camera controls.
13 Front lens cap	—
14 Rear lens cap	—

■ Attachment and Removal

Attaching the Lens

- 1** Turn the camera off, remove the body cap, and detach the rear lens cap.
-
- 2** Position the lens on the camera body, keeping the mounting mark on the lens aligned with the mounting mark on the camera body, and then rotate the lens counterclockwise until it clicks into place.

Removing the Lens

- 1** Turn the camera off.
-
- 2** Press and hold the lens release button while turning the lens clockwise.

■ ■ Before Use

The lens is retractable and must be extended before use. Rotate the zoom ring as shown until the lens clicks into the extended position. Pictures can only be taken when the focal length mark points to positions between 24 and 70 on the focal length scale.

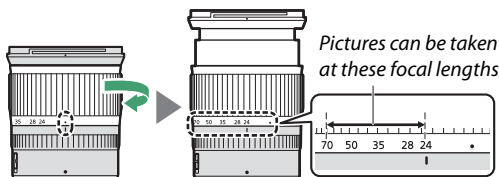

To retract the lens, rotate the zoom ring in the opposite direction, stopping when you reach the (●) position on the focal length scale.

If the camera is turned on with the lens retracted, a warning will be displayed. Extend the lens before use.

■ ■ *Attaching and Removing the Lens Hood*

Align the lens hood mounting mark (●) with the lens hood alignment mark (●) and then rotate the hood (②) until the ● mark is aligned with the lens hood lock mark (○).

To remove the hood, reverse the above steps.

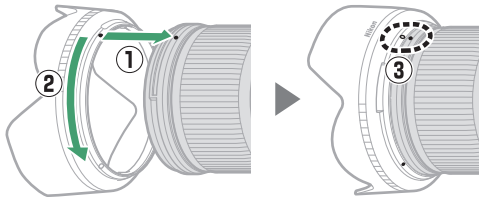

When attaching or removing the hood, hold it near the ● symbol on its base and avoid gripping it too tightly. The hood can be reversed and mounted on the lens when not in use.

■ ■ *When the Lens Is Attached*

The focus position may change if you turn the camera off and then on again after focusing. Refocus before shooting. If you have focused on a pre-selected location while waiting for your subject to appear, we recommend that you do not turn the camera off until the picture is taken.

Precautions for Use

- Do not pick up or hold the lens or camera using only the lens hood.
- Keep the CPU contacts clean.
- Should the rubber lens-mount gasket be damaged, cease use immediately and take the lens to a Nikon-authorized service center for repair.
- Replace the front and rear lens caps when the lens is not in use.
- To protect the interior of the lens, store it out of direct sunlight.
- Keep the lens dry. Rusting of the internal mechanism can cause irreparable damage.
- Leaving the lens in extremely hot locations could damage or warp parts made from reinforced plastic.
- Rapid changes in temperature may cause damaging condensation inside and outside the lens. Before taking the lens from a warm to a cold environment or vice versa, place it in its case or a plastic bag to slow the change in temperature.
- We recommend that you place the lens in its case to protect it from scratches during transport.

Lens Care

- Removing dust is normally sufficient to clean the glass surfaces of the lens.
- Smudges and fingerprints can be removed from fluorine-coated lens elements using a soft, clean cotton cloth or lens cleaning tissue; clean from the center outwards using a circular motion. To remove stubborn stains, wipe gently using a soft cloth lightly dampened with a small amount of distilled water, ethanol, or lens cleaner. Any drop-shaped marks left from this process on the water- and oil-repellent surface can subsequently be removed with a dry cloth.
- When cleaning lens elements that are not fluorine-coated, remove smudges and fingerprints using a soft, clean cotton cloth or lens cleaning tissue lightly dampened with a small amount of ethanol or lens cleaner. Wipe gently from the center outwards in a circular motion, taking care not to leave smears or touch the lens with your fingers.
- Never use organic solvents such as paint thinner or benzene to clean the lens.
- Neutral Color (NC) filters (available separately) and the like can be used to protect the front lens element.
- If the lens will not be used for an extended period, store it in a cool, dry location to prevent mold and rust. Do not store in direct sunlight or with naphtha or camphor moth balls.

Accessories

■ ■ Supplied Accessories

- LC-72B 72 mm snap-on Front Lens Cap
- LF-N1 Rear Lens Cap
- HB-85 Bayonet Hood
- CL-C1 Lens Case

✓ Using the Lens Case

- The case is intended to protect the lens from scratches, not from falls or other physical shocks.
- The case is not water resistant.
- The material used in the case may fade, bleed, shrink, or change color when rubbed or wet.
- Remove dust with a soft brush.
- Water and stains can be removed from the surface with a soft, dry cloth. Do not use alcohol, benzene, thinner, or other volatile chemicals.
- Do not store in locations exposed to direct sunlight or high temperatures or humidity.
- Do not use the case to clean the monitor or lens elements.
- Be careful that the lens does not fall from the case during transport.

Material: Polyester

■ ■ Compatible Accessories

72 mm screw-on filters

✓ Filters

Use only one filter at a time. Remove the lens hood before attaching filters or rotating circular polarizing filters.

Specifications

Mount	Nikon Z mount
Focal length	24 – 70 mm
Maximum aperture	f/4
Lens construction	14 elements in 11 groups (including 1 ED lens element, 1 aspherical ED element, 3 aspherical elements, elements with Nano Crystal Coat, and a fluorine-coated front lens element)
Angle of view	<ul style="list-style-type: none">• FX format: 84° – 34° 20′• DX format: 61° – 22° 50′
Focal length scale	Graduated in millimeters (24, 28, 35, 50, 70)
Focusing system	Internal focusing system
Minimum focus distance	0.3 m (0.99 ft) from focal plane at all zoom positions
Diaphragm blades	7 (rounded diaphragm opening)
Aperture range	f/4 – 22
Filter-attachment size	72 mm (P = 0.75 mm)
Dimensions	Approx. 77.5 mm maximum diameter × 88.5 mm (distance from camera lens mount flange when lens is retracted)
Weight	Approx. 500 g (1 lb 1.7 oz)

Nikon reserves the right to change the appearance, specifications, and performance of this product at any time and without prior notice.

FTZ Mount Adapter User's Manual

This mount adapter allows Nikon F mount NIKKOR lenses to be mounted on Nikon Z mount mirrorless cameras. It cannot be mounted on F mount (Nikon digital SLR) or 1 mount cameras (Nikon 1 advanced cameras with interchangeable lenses) or used with 1 NIKKOR lenses. This section is included as a mount-adapter manual for purchasers of the mount-adapter kit. Note that mount-adapter kits may not be available in some countries or regions.

Note that depending on the lens, the adapter may limit autofocus or other camera features.

Compatible F Mount Lenses

For information on lenses that can be mounted on the FTZ mount adapter for use with Z mount cameras, see *Compatible F Mount Lenses*, available from the Nikon Download Center:

<https://downloadcenter.nikonimglib.com/en/products/491/FTZ.html>

The Mount Adapter

Parts of the Adapter

Lens mount

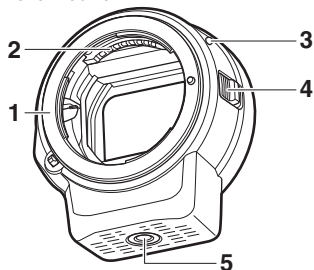

Camera mount

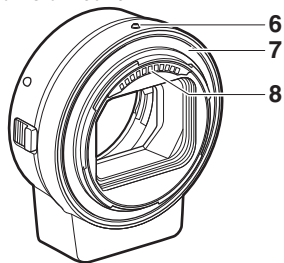

1 Nikon F mount (attaches to lens)

2 Lens signal contacts

3 Lens mounting mark

4 Lens release

5 Tripod socket

6 Adapter mounting mark

7 Nikon Z mount (attaches to camera)

8 CPU contacts

■ Attachment and Removal

Turn the camera off before attaching the adapter to or removing it from the camera or attaching lenses to or removing lenses from the adapter. Choose a location out of direct sunlight and be careful to prevent dust from entering the devices. While attaching lenses, avoid pressing the camera or adapter lens release.

Attaching the Adapter and Lens

1 Remove the body and rear lens caps from the adapter and the body cap from the camera.

2 Attach the adapter to the camera.

Keeping the adapter mounting mark aligned with the mounting mark on the camera body (①), position the adapter on the camera and then rotate it counterclockwise until it clicks into place (②).

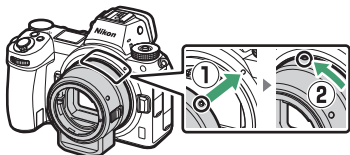

3 Remove the rear lens cap.

4 Attach the lens to the adapter.

Keeping the lens mounting mark aligned with the lens mounting mark on the adapter (③), position the lens on the adapter and then rotate it counterclockwise until it clicks into place (④).

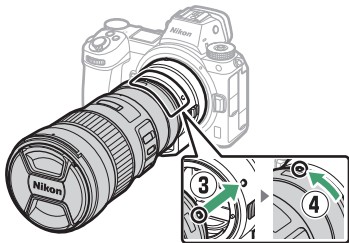

Detaching the Lens and Adapter

1 Detach the lens.

Press and hold the adapter lens release (①) while turning the lens clockwise (②). Attach the front and rear caps to the lens after removal.

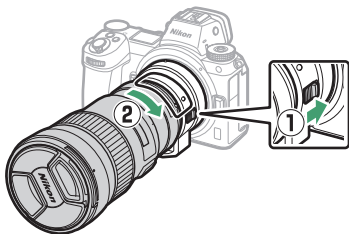

2 Detach the adapter.

Press and hold the camera lens release button (③) while turning the adapter clockwise (④). After removing the adapter, attach the body and rear caps to the adapter and the body cap to the camera.



✔ CPU Lenses with Aperture Rings

Select minimum aperture (the highest f/-number) before attaching CPU lenses equipped with aperture rings.

✔ Incompatible Lenses and Accessories

The following lenses and accessories cannot be used. Attempting to forcibly attach any of this equipment could damage the adapter or the lens. Individual variation may render lenses other than those listed below incompatible; do not use force if you encounter resistance when attempting to attach a lens.

- Non-AI lenses
- IX-NIKKOR
- TC-16A AF Teleconverter
- Lenses that require the AU-1 focusing unit (400mm f/4.5, 600mm f/5.6, 800mm f/8, 1200mm f/11)
- Fisheye (6mm f/5.6, 7.5mm f/5.6, 8mm f/8, OP 10mm f/5.6)
- 2.1cm f/4
- K2 Extension Ring
- 180–600mm f/8 ED (serial numbers 174041–174180)
- 360–1200mm f/11 ED (serial numbers 174031–174127)
- 200–600mm f/9.5 (serial numbers 280001–300490)
- AF lenses for the F3AF (AF 80mm f/2.8, AF 200mm f/3.5 ED, TC-16 AF Teleconverter)
- PC 28mm f/4 (serial number 180900 or earlier)
- PC 35mm f/2.8 (serial numbers 851001–906200)
- PC 35mm f/3.5 (old type)
- Reflex 1000mm f/6.3 (old type)
- NIKKOR-H Auto 2.8cm f/3.5 (28mm f/3.5) lenses with serial numbers below 362000
- NIKKOR-S Auto 3.5cm f/2.8 (35mm f/2.8) lenses with serial numbers below 928000
- NIKKOR-S Auto 5cm f/2 (50mm f/2)
- NIKKOR-Q Auto 13.5cm f/3.5 (135mm f/3.5) lenses with serial numbers below 753000
- Micro-NIKKOR 5.5cm f/3.5
- Medical-NIKKOR Auto 200mm f/5.6
- Auto NIKKOR Telephoto-Zoom 85–250mm f/4–4.5
- Auto NIKKOR Telephoto-Zoom 200–600mm f/9.5–10.5

Using the Mount Adapter

- Autofocus may not function as expected when the adapter is used with an F mount NIKKOR lens. If the camera has trouble focusing, set the AF-area mode to single point and select the center focus area, or focus manually.
- With some lenses, the camera vibration reduction feature may not function as expected or may cause vignetting or a drop in peripheral illumination.

Precautions for Use

- When using the adapter with lenses weighing over 1300 g (2 lb 13.9 oz), support the lens when holding the camera and do not use the camera strap. Failure to observe these precautions could damage the camera lens mount.
- When using telephoto lenses equipped with a tripod collar, attach the tripod to the lens tripod collar rather than to the adapter tripod socket.
- Keep the CPU and lens signal contacts clean.
- Keep the adapter dry. Rusting of the internal mechanism can cause irreparable damage.
- Leaving the adapter in extremely hot locations could damage or warp parts made from reinforced plastic.

Caring for the Adapter

- Do not touch the interior of the mount adapter. Use a blower or soft brush to remove dust, being careful not to rub or scratch the inside of the adapter.
- When cleaning the adapter, use a blower to remove dust and lint and then wipe the adapter gently with a soft, dry cloth.
- Never use organic solvents such as paint thinner or benzene to clean the adapter.
- If the adapter will not be used for an extended period, store it in a cool, dry location to prevent mold and rust. Do not store in direct sunlight or with naphtha or camphor moth balls.

Accessories

■ ■ *Supplied Accessories*

- BF-1B Body Cap
- LF-N1 Rear Lens Cap

Specifications

Type	Mount adapter
Supported cameras	Nikon Z mount mirrorless cameras
Dimensions	Approx. 70 mm diameter (excluding projections) × 80 mm
Weight	Approx. 135 g (4.8 oz)

Nikon reserves the right to change the appearance, specifications, and performance of this product at any time and without prior notice.

Approved Memory Cards

The camera can be used with XQD and CFexpress (Type B) memory cards. Cards with write speeds of 45 MB/s (300×) or better are recommended for movie recording; slower speeds may interrupt recording or playback or result in playback that is jerky and uneven. For information on compatibility and operation, contact the manufacturer.

Memory Card Capacity

The following table shows the approximate number of pictures that can be stored on a 64 GB Sony G-series QD-G64E XQD card at different image quality and size settings when **FX (36 × 24)** is selected for **Choose image area** (as of July 2018).

Z7:

Image quality			Image size	File size ¹	No. of images ¹	Buffer capacity ²	
NEF (RAW)	Lossless compressed	12-bit	Large	44.7 MB	748	23	
			Medium	31.5 MB	1000	19	
			Small	24.5 MB	1400	19	
	Compressed	14-bit	Large		55.8 MB	654	19
					40.7 MB	1000	23
					49.4 MB	845	19
					74.1 MB	748	23
					85.1 MB	654	18
Uncompressed	12-bit	Large		74.1 MB	748	23	
				85.1 MB	654	18	
TIFF (RGB)			Large	134.6 MB	412	21	
			Medium	76.5 MB	723	22	
			Small	34.8 MB	1500	25	
JPEG ³	Fine	Large		17.2 MB	1900	25	
		Medium		11.7 MB	3200	25	
		Small		6.8 MB	6500	25	
	Normal	Large		11.8 MB	3700	25	
		Medium		7.0 MB	6400	25	
		Small		3.5 MB	12,700	25	
	Basic	Large		3.8 MB	7500	25	
		Medium		2.6 MB	12,300	25	
		Small		1.6 MB	24,100	25	

Z 6:

Image quality			Image size	File size ¹	No. of images ¹	Buffer capacity ²	
NEF (RAW)	Lossless compressed	12-bit	Large	22.5 MB	1300	35	
			Medium	16.1 MB	1900	26	
			Small	12.7 MB	2500	26	
	Compressed	14-bit	Large	Large	28.2 MB	1100	43
				Medium	20.4 MB	1800	37
				Medium	24.8 MB	1500	43
				Small	38.5 MB	1300	33
				Small	44.1 MB	1100	34
Uncompressed	12-bit	Large	Large	69.3 MB	759	27	
			Medium	39.5 MB	1300	31	
TIFF (RGB)			Small	18.4 MB	2800	35	
			Fine	Large	9.4 MB	3400	44
				Medium	6.6 MB	5600	50
Small	4.0 MB	10,400		51			
JPEG ³	Normal		Large	6.4 MB	6700	44	
			Medium	3.9 MB	10,900	50	
			Small	2.1 MB	19,900	51	
	Basic		Large	2.3 MB	13,000	46	
			Medium	1.7 MB	20,800	50	
			Small	1.2 MB	35,200	50	

- 1 All figures are approximate. File size, and with it the buffer capacity and number of images that can be recorded, varies with scene recorded.
- 2 Maximum number of exposures that can be stored in memory buffer at ISO 100. May drop in some situations, for example at image qualities marked with a star ("★") or if auto distortion control is on.
- 3 Figures assume size-priority JPEG compression. Selecting an image-quality option marked with a star ("★"; optimal compression) increases the file size of JPEG images; number of images and buffer capacity drop accordingly.

Battery Endurance

The approximate length of footage or number of shots that can be recorded with a fully-charged EN-EL15b¹ battery varies with the monitor mode. The figures for photographs² are as follows:

- **Viewfinder only:** 330 shots (Z 7), 310 shots (Z 6)
- **Monitor only:** 400 shots (Z 7), 380 shots (Z 6)

The figures for movies³ are:

- **Viewfinder only:** 85 minutes
- **Monitor only:** 85 minutes

Actions such as the following can reduce battery endurance:

- Keeping the shutter-release button pressed halfway
- Repeated autofocus operations
- Taking NEF (RAW) photographs
- Slow shutter speeds
- Using camera Wi-Fi (wireless LAN) and Bluetooth features
- Using the camera with optional accessories connected
- Repeatedly zooming in and out

To ensure that you get the most from rechargeable Nikon EN-EL15b batteries:

- Keep the battery contacts clean. Soiled contacts can reduce battery performance.
- Use batteries immediately after charging. Batteries will lose their charge if left unused.

1 EN-EL15a/EN-EL15 batteries can also be used, but note that you may not be able to take as many pictures on a single charge. Endurance varies with the condition of the battery, the temperature, the interval between shots, and the length of time menus are displayed.

2 CIPA standard. Measured at 23 °C/73.4 °F (±2 °C/3.6 °F) with a NIKKOR Z 24–70mm f/4 S lens and a SONY QD-G64E memory card (data current as of July 2018) under the following test conditions: one photograph taken at default settings once every 30 s.

3 Measured at 23 °C/73.4 °F (±2 °C/3.6 °F) with the camera at default settings, a NIKKOR Z 24–70mm f/4 S lens, and a SONY QD-G64E memory card (data current as of July 2018) under conditions specified by the Camera and Imaging Products Association (CIPA). Individual movies can be up to 29 minutes 59 seconds in length; recording may end before this limit is reached if the camera temperature rises.

Index

Symbols

(Auto mode)	41, 45
P (Programmed auto)	72, 73
S (Shutter-priority auto)	72, 73
A (Aperture-priority auto)	72, 74
M (Manual)	72, 75
U1/U2/U3	72, 77
(Single frame)	86, 89
L (Continuous L)	86, 113
H (Continuous H)	86, 113
H ⁺ (Continuous H (extended))	87, 113
(Self-timer)	87, 89
(Silent photography)	68
(Electronic front-curtain shutter) ..	264
(Mechanical shutter)	264
(Pinpoint AF)	54
(Single-point AF)	54
(Dynamic-area AF)	55
(Wide-area AF (S))	55
(Wide-area AF (L))	55
(Auto-area AF)	56
(Matrix)	110
(Center-weighted)	110
(Spot)	110
* (Highlight-weighted)	110
(Red-eye reduction)	109, 356
SLOW (Slow sync)	109, 356
REAR (Rear-curtain sync)	109, 357
(Exposure compensation)	84
button	49, 124
button	51
MENU button	18
(Self-timer) button	86
ISO button	82, 83
(?) button	20, 124, 125



button	124, 141
button	21, 94
button	18
(In-focus indicator)	62
(Flash-ready indicator)	414
icon	40

Numerics

1 : 1 (24 × 24)	108
16 : 9 (36 × 20)	108
5 : 4 (30 × 24)	108

A

AC adapter	415, 420
Accessories	415
Accessory terminal	441
Active D-Lighting	112
ADL bracketing	200
AE & flash bracketing	193
AE bracketing	193
AE lock	91, 92
AF	52, 253
AF activation	256
AF fine-tune	301
AF lock	91, 92
AF speed	292
AF tracking sensitivity	293
AF-area mode	54
AF-assist	43, 258
AF-C	53
AF-C priority selection	253
AF-F	53, 123
AF-ON button	17
AF-S	52
AF-S priority selection	253
After burst, show	159
After delete	158
Airplane mode	310

Animal face/eye-detection AF.....	58	Charging the battery	28
Aperture	74	Choose color temp. (White balance)	66, 102, 175
Aperture-priority auto	74	Choose image area.....	121, 167
Apply settings to live view.....	266	Choose start/end point	137
Assign remote (WR) Fn button	310	CL mode shooting speed.....	263
Attaching the lens.....	36	Clean image sensor.....	302, 423
Attenuator	246	Clock.....	38, 40
Auto (Set Picture Control)	96	Clock battery	40
Auto (White balance)	65, 100	Cloudy (White balance)	65, 100
Auto bracketing.....	192, 269	Color space.....	184
Auto  ISO sensitivity control	268	Color temperature.....	66, 102, 175
Auto distortion control	186, 244	Command dial	17, 283
Auto external flash.....	354, 361	Compatible lenses.....	433
Auto FP high-speed sync.....	267	Conformity marking	311
Auto ISO sensitivity control ...	83, 171	Connect to PC	311, 339
Auto-area AF	56	Connect to smart device	310, 338
Auto-area AF face/eye detection	254	Continuous.....	86, 89
Autoexposure lock.....	91, 92	Continuous H	86, 113
Autofocus.....	52, 253	Continuous H (extended)	87, 113
Automatic display switch.....	9	Continuous L	86, 113
B		Continuous release mode	86, 89, 113
<hr/>			
Battery	28, 32	Control panel.....	5, 409
Battery charger	28, 443	Control panel brightness	299
Battery endurance	471	Control ring.....	62, 453
Battery info	312	Copyright.....	306
Battery level.....	34	CPU contacts	453
Beep options.....	307	Creative Lighting System (CLS)....	410
Body cap.....	36, 416	Creative Picture Control	96
Bracketing.....	269	Crop	134
Bracketing order	270	Custom control assignment .	24, 273, 287
Bulb	80	Custom Picture Control	180, 181, 243
C		Custom Settings.....	150, 249
<hr/>			
Cable clip.....	419	Customize  menu	22, 271, 286
Camera Control Pro 2	418	D	
Capture NX-D.....	70, 339	<hr/>	
Center-weighted	110, 260	Date and time	39, 297
CHARGE lamp	29, 30	Date format.....	40, 297
Charging AC adapter	29, 415, 432, 444	Daylight saving time.....	39, 297
		DCF.....	445

Default settings	145, 389	Filter effects	99
Delete	51, 142, 157	Fine-tune optimal exposure	261
Delete all images	143	Fine-tuning white balance ..	101, 173
Delete current image	51, 142	Firmware version	315
Delete selected images	143	Flash	109, 351, 410
Diffraction compensation	186, 244	Flash (White balance)	65, 100
Diopter adjustment control	8	Flash bracketing	193
Direct sunlight (White balance)	65, 100	Flash compensation	191, 358
DISP button	15	Flash control	188, 354
Distance-priority manual	354, 362	Flash info	361, 386
Distortion control	326	Flash mode	109, 356
D-Lighting	325	Flash ready indicator	414
Download center	ii	Flash shutter speed	268
DX	108	Flash sync speed	267, 353
DX format	121	Flat (Set Picture Control)	96
Dynamic-area AF	55, 115	Flexible program	73
E		Flick	11
<hr/>			
Edit movie	137, 331	Flicker reduction	187, 244
Electronic VR	122, 245	Fluorescent (White balance) ..	65, 100
Error messages	396, 398	Fn1 button	24
EV steps for exposure cntrl	259	Fn2 button	24
Exif	445	Focal length	455
Exposure	84, 259	Focal length scale	455
Exposure compensation	84, 260, 268	Focal plane mark	63
Exposure data	127	Focus indicator	62
Exposure delay mode	263	Focus lock	91, 92
Exposure indicator	76	Focus mode	52
Exposure lock	91, 92	Focus point	91
Exposures remaining	34	Focus shift shooting	233
Extensions	167	Focus tracking with lock-on	254
External microphone	120, 418	Format memory card	296
Eye sensor	8	Frame rate	87, 118
Eye-detection AF	57	Frame size/frame rate	118, 241
F		Framing grid display	266
<hr/>			
Face-detection AF	57	Frequency response	247
File information	127	Full-frame playback	11, 49, 124
File naming	167, 241	Function buttons	24
File number sequence	265	FV lock	359, 413
		FX	108, 121

G

Group flash 370, 378, 386

H

HDMI 308, 347, 445

HDMI cable 416

HDMI connector 347

HDMI recorders 348

Headphone volume 247

Headphones 247

Help 20

Hi 82

High Dynamic Range (HDR) 209

High ISO NR 185, 243

Highlight display 294

Highlights 63, 110, 128

Highlight-weighted 110

Histogram 128, 129

I

Image area 121, 167

Image comment 305

Image Dust Off ref photo 303

Image overlay 328

Image quality 106, 168

Image review 125, 158

Image sensor 2, 423, 429

Image size 108, 168

Incandescent (White balance) 65,
100

In-focus indicator 62

Information display 15, 300, 403

Interval timer shooting 214

ISO sensitivity 82, 171, 242

i-TTL 354, 355, 410

J

JPEG 106

L

L (large) 108

Landscape (Set Picture Control) 96

Language 38, 296

LED lamp 309

Lens 36, 452

Lens mount 36

Lens mounting mark 36

Limit AF-area mode selection 257

Limit monitor mode selection 300

Limit selectable image area 264

LINK mode 309, 367

Lo 82

Location data 132, 308

Long exposure NR 185

Low-light AF 258

M

M (medium) 108

Main command dial 17

Manage Picture Control 181, 243

Manual 75, 354, 362

Manual focus 53, 62

Manual focus ring in AF mode 259

Matrix metering 110

Max. continuous release 263

Maximum aperture 414

Maximum sensitivity 83, 171

Memory buffer 88

Memory card 32, 468, 469

Memory card capacity 469

Menu guide 145

Metering 110

MF 53

Microphone 120, 418

Microphone sensitivity 120, 246

Minimum aperture 465

Minimum shutter speed 171

Mired 174

Mode dial 72

Mode dial lock release.....	72	Photo shooting menu.....	145, 162
Modeling flash	269	Photo/movie selector.....	41, 45
Monitor	6, 10, 400	PictBridge	344, 445
Monitor brightness.....	297	Picture Controls.....	96, 179, 243
Monitor color balance	298	Pinpoint AF	54, 115
Monitor mode button	8	Playback.....	11, 49, 124
Monitor pre-flash	413	Playback display options	157
Monochrome (Set Picture Control) ...	96	Playback folder	157
Mount adapter	461	Playback menu	145, 156
Movie file type.....	241	Playback zoom.....	12, 129, 141
Movie quality	118, 241	Portrait (Set Picture Control)	96
Movie shooting menu	148, 240	Power connector	415, 420
Movie-record button	46	Power off delay.....	262
Movies.....	45, 49, 116	Power switch	38
Multi selector	18	Preset manual (White balance).....	66, 100, 103, 177
Multiple exposure.....	202	Press the shutter-release button all	
My Menu	333	the way down	44
N		Press the shutter-release button	
Natural light auto (White balance)	65, 100	halfway	43
NEF (RAW).....	106, 170	Prioritize viewfinder.....	9
NEF (RAW) processing.....	319	Problems and solutions.....	390
NEF (RAW) recording	170	Product serial number	4
Neutral (Set Picture Control).....	96	Programmed auto	73
N-Log setting.....	350	Protecting photographs	71
Non-CPU lens.....	302	Q	
Number of focus points.....	255	Quick crop	134
Number of shots.....	471	Quick sharp.....	99
O		Quick wireless control..	372, 380, 387
OK button	281, 292	R	
Optical AWL	377, 384	Radio AWL	366
Optical/radio AWL	385	Rating.....	161
Overview data	133	Rear-curtain sync	109
P		Recent settings.....	333, 337
Peaking highlights.....	266	Rechargeable Li-ion battery .	28, 415, 444
Perspective control	327	Red-eye correction.....	325
Photo information	126	Red-eye reduction	109
		Release button to use dial	285

Release mode	86, 113
Remote cord.....	80, 416
Remote flash photography..	351, 364
Remote repeating	374, 382, 387
Removing the lens from the camera 37	
Repeating flash	355, 362
Reset	163, 241, 252, 315
Reset all settings.....	315
Reset custom settings	252
Reset movie shooting menu	241
Reset photo shooting menu	163
Reset user settings.....	78, 296
Resize.....	323
Restoring default settings.....	389
Retouch menu.....	316
Reverse indicators.....	285
RGB.....	128, 167, 184
Rotate tall.....	125, 159

S

S (small)	108
Same as photo settings.....	116
Save current frame	140
Save user settings	77, 296
Save/load settings	313
Select date	143, 144
Select to send to smart device	136
Select to send/deselect.....	136
Self-timer	89, 113, 262
Sensitivity.....	82
Set Picture Control.....	96, 179, 243
Setup menu.....	154, 295
Shade (White balance)	100
Shooting data.....	130
Shutter spd & aperture lock.....	283
Shutter speed	73, 75
Shutter type	264
Shutter-priority auto.....	73
Shutter-release button.....	43, 44
Shutter-release button AE-L.....	261

Side-by-side comparison	331
Silent photography.....	68, 239
Single frame.....	86, 89, 113
Single-point AF	54, 115, 123
Size	108, 168
Slide show	160
Slot empty release lock.....	312
Slow sync	109
Slow-motion movies.....	119
Smart device.....	111, 310, 338
SnapBridge.....	40, 338
Specifications	433
Splitscreen display zoom	272
Spot.....	110
Standard (Set Picture Control)	96
Standard i-TTL fill-flash	410
Standby timer	44, 262, 308
Storage folder	163
Store points by orientation	255
Straighten.....	326
Sub-command dial.....	17
Subject tracking	59
Sub-selector.....	17, 91
Sync. release mode options.....	263

T

Text entry.....	13, 164
Thumbnail	12
TIFF (RGB).....	106
Tilting monitor.....	3
Time.....	80
Time zone	39, 297
Time zone and date	39, 297
Timecode	248
Time-lapse movie	225
Touch controls.....	10, 60, 307
Touch screen	10, 60
Touch shutter	10, 60
Trademark Information	446
Trim.....	322
Trimming movies.....	137, 331

Tripod.....	80
Troubleshooting.....	389

U

Unified flash control.....	355
USB	339, 344
User settings	77, 296
Using an on-camera flash	352

V

Vibration reduction	114, 191, 245
View all in continuous mode	266
Viewfinder	8, 406
Viewfinder brightness	299
Viewfinder color balance	299
Viewfinder eyepiece	8, 417
Viewfinder eyepiece cap	417
Viewfinder focus.....	8
ViewNX-i.....	70, 339
Vignette control	186, 244
Virtual horizon.....	15, 16
Vivid (Set Picture Control).....	96
Volume.....	50, 307

W

WB (White balance)	64, 100
WB bracketing	197
White balance	64, 100
Wide-area AF	55, 115, 123
Wi-Fi	111, 343
Wind noise reduction	247
Wireless.....	343
Wireless remote (WR) options	309
Wireless remote controller .	309, 366, 417
Wireless transmitter (WT-7)	311, 343, 416

X

XQD memory card	468
-----------------------	-----

No reproduction in any form of this manual, in whole or in part (except for brief quotation in critical articles or reviews), may be made without written authorization from NIKON CORPORATION.

NIKON CORPORATION

© 2018 Nikon Corporation



SB1D05(11)
6MOA1011-05