

Nikon

DIGITAL CAMERA

D5

User's Manual

- Read this manual thoroughly before using the camera.
- To ensure proper use of the camera, be sure to read "For Your Safety" (page x).
- After reading this manual, keep it in a readily accessible place for future reference.

En

To get the most from your camera, please be sure to read all instructions thoroughly and keep them where they will be read by all who use the product.

The Menu and Network Guides

A *Network Guide* and *Menu Guide* can be downloaded from the Nikon website in pdf format as described below and viewed using Adobe Reader or Adobe Acrobat Reader. The *Network Guide* describes how to connect the camera to a network, while the *Menu Guide* describes the options available in the camera menus.

- 1 On your computer, launch a web browser and open the Nikon manual download site at <http://downloadcenter.nikonimglib.com/>
- 2 Navigate to the page for the desired product and download the manual.

Nikon User Support for India and Australia

Contact a Nikon representative for technical assistance with the operation of your Nikon product or products. For information on the Nikon representatives in your area, visit <http://www.nikon-asia.com/support>.

Nikon Manual Viewer 2



Install the Nikon Manual Viewer 2 app on your smartphone or tablet to view Nikon digital camera manuals, anytime, anywhere. Nikon Manual Viewer 2 can be downloaded free of charge from the App Store and Google Play. Download of the app and any product manuals requires an Internet connection, for which fees may be levied by your phone or Internet service provider.

⚠ For Your Safety

Before using the camera for the first time, read the safety instructions in "For Your Safety" (☞ x-xiii).

D5-a (XQD Card Type)

D5-b (CF Card Type)

Symbols and Conventions

To make it easier to find the information you need, the following symbols and conventions are used:



This icon marks cautions; information that should be read before use to prevent damage to the camera.



This icon marks notes; information that should be read before using the camera.



This icon marks references to other pages in this manual.

Menu items, options, and messages displayed in the camera monitor are shown in **bold**.

This camera is available in XQD- and CompactFlash-compatible models. The instructions in this manual assume an XQD memory card is used, but the operations for both models are identical.

Camera Settings

The explanations in this manual assume that default settings are used.

Package Contents

Be sure all items listed here were included with your camera.



- D5 digital camera (☐ 1)



- BF-1B body cap (☐ 25, 339)



- BS-3 accessory shoe cover (☐ 14)

- EN-EL18c rechargeable Li-ion battery with terminal cover (☐ 19, 22)
- MH-26a battery charger with power cable and two contact protectors (shape of power cable depends on country of sale; ☐ 19, 380)

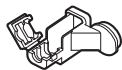

- USB cable clip (☐ 278)

- UC-E22 USB cable (☐ 278, 283)
- *User's Manual* (this guide)
- AN-DC15 strap (☐ 19)



- HDMI cable clip (☐ 286)

- Warranty

Memory cards are sold separately. Cameras purchased in Japan display menus and messages in English and Japanese only; other languages are not supported. We apologize for any inconvenience this may cause.

ViewNX-i and Capture NX-D Software

Use ViewNX-i to fine-tune photos or to copy pictures to a computer for viewing. ViewNX-i is available for download from the following website:
<http://downloadcenter.nikonimglib.com/>

Use Capture NX-D to fine-tune pictures that have been copied to a computer and to convert NEF (RAW) images to other formats. Capture NX-D is available for download from:
<http://downloadcenter.nikonimglib.com/>

You can also visit this website for the latest information on Nikon software, including system requirements.

Table of Contents

For Your Safety	x
Notices.....	xiv
Introduction	1
<hr/>	
Getting to Know the Camera	1
Camera Body	1
The Top Control Panel.....	6
The Rear Control Panel	8
The Viewfinder Display	10
Using the Touch Screen.....	12
The Accessory Shoe Cover	14
Tutorial	15
<hr/>	
Camera Menus.....	15
Using Camera Menus.....	16
First Steps	19
Attach the Camera Strap.....	19
Charge the Battery.....	19
Insert the Battery.....	22
Attach a Lens	25
Basic Setup	27
Insert a Memory Card	30
Format the Memory Card.....	33
Adjust Viewfinder Focus.....	35
Basic Photography and Playback	37
The Battery Level and Number of Exposures	
Remaining	37
Ready the Camera.....	39
Focus and Shoot.....	40
Viewing Photographs.....	42
Deleting Unwanted Photographs.....	43

Live View Photography **44**

Autofocus	48
Manual Focus	50
Using the i Button	51
Silent Mode	54
The Live View Display	56
The Information Display	57

Movies **59**

Recording Movies	59
Indices	63
Using the i Button	63
The Live View Display	65
Maximum Length	67
The Information Display	68
The Movie Crop	69
Taking Photos in Movie Mode	71
Time-Lapse Movies	74
Viewing Movies	80
Editing Movies	82
Trimming Movies	82
Saving Selected Frames	85

Image Recording Options **87**

Image Area	87
Image Quality	92
Image Size	95
Using Two Memory Cards	97

Focus

98

Autofocus	98
Autofocus Mode	101
AF-Area Mode	104
Focus Point Selection	108
Focus Lock	111
Manual Focus	114

Release Mode

116

Choosing a Release Mode	116
Quick Release-Mode Selection	119
Self-Timer Mode	120
Mirror up Mode	122

ISO Sensitivity

124

Manual Adjustment	124
Auto ISO Sensitivity Control	126

Exposure

129

Metering	129
Exposure Mode	131
P : Programmed Auto	133
S : Shutter-Priority Auto	134
A : Aperture-Priority Auto	135
M : Manual	136
Long Time-Exposures (M Mode Only)	138
Shutter-Speed and Aperture Lock	140
Autoexposure (AE) Lock	141
Exposure Compensation	143
Bracketing	146

White Balance **159**

White Balance Options	159
Fine-Tuning White Balance	162
Choosing a Color Temperature	165
Preset Manual	168
Viewfinder Photography	169
Live View (Spot White Balance)	173
Managing Presets	176

Image Enhancement **179**

Picture Controls	179
Selecting a Picture Control	179
Modifying Picture Controls	181
Creating Custom Picture Controls	184
Preserving Detail in Highlights and Shadows	187
Active D-Lighting	187
High Dynamic Range (HDR)	189

Flash Photography **194**

Using a Flash	194
On-Camera Flash Photography	197
Flash Modes	198
Flash Compensation	200
FV Lock	202
Remote Flash Photography	204
Setup	205
Taking Photos	209
Viewing Flash Info	216

Other Shooting Options **220**

The  Button.....	220
The <i>i</i> button	223
Two-Button Reset: Restoring Default Settings	224
Flicker Reduction	227
Multiple Exposure	229
Interval Timer Photography	236
Non-CPU Lenses.....	243
Location Data.....	246









More About Playback **248**

Viewing Images.....	248
Full-Frame Playback.....	248
Thumbnail Playback.....	248
Playback Controls	249
Using the Touch Screen.....	251
The <i>i</i> Button	253
Photo Information.....	254
Taking a Closer Look: Playback Zoom.....	263
Protecting Photographs from Deletion.....	265
Rating Pictures.....	267
Deleting Photographs	268
Full-Frame and Thumbnail Playback	268
The Playback Menu	270

Voice Memos **272**

Recording Voice Memos	272
During Playback	272
During Shooting.....	273
Playing Voice Memos.....	276

Installing ViewNX-i	277
Copying Pictures to the Computer	278
Ethernet and Wireless Networks	281
Printing Photographs.....	283
Connecting the Printer	283
Printing Pictures One at a Time	284
Printing Multiple Pictures	285
Viewing Photographs on TV	286
HDMI Options	287

 The Playback Menu: Managing Images	289
 The Photo Shooting Menu: Shooting Options	291
 The Movie Shooting Menu: Movie Shooting Options	296
 Custom Settings: Fine-Tuning Camera Settings	299
 The Setup Menu: Camera Setup.....	310
 The Retouch Menu: Creating Retouched Copies	314
 My Menu/  Recent Settings.....	316
Retouch Menu Options	317
NEF (RAW) Processing.....	317
Trim.....	319
Image Overlay.....	320

Compatible Lenses	323
The Nikon Creative Lighting System (CLS)	330
Other Accessories	336
Attaching a Power Connector and AC Adapter	342
Caring for the Camera	344
Storage	344
Cleaning	344
The Low-Pass Filter	345
“Clean Now”	345
“Clean at Startup/Shutdown”	346
Manual Cleaning	347
Replacing the Clock Battery	351
Caring for the Camera and Battery: Cautions	353
Exposure Program	357
Troubleshooting	358
Battery/Display	358
Shooting	358
Playback	362
Miscellaneous	363
Error Messages	364
Specifications	370
Calibrating Batteries	380
Approved Memory Cards	383
Memory Card Capacity	385
Battery Life	388
Index	390

For Your Safety

To prevent damage to your Nikon product or injury to yourself or to others, read the following safety precautions in their entirety before using this equipment. Keep these safety instructions where all those who use the product will read them.

The consequences that could result from failure to observe the precautions listed in this section are indicated by the following symbol:



This icon marks warnings. To prevent possible injury, read all warnings before using this Nikon product.

■ ■ WARNINGS

Keep the sun out of the frame

Keep the sun well out of the frame when shooting backlit subjects. Sunlight focused into the camera when the sun is in or close to the frame could cause a fire.

Do not look at the sun through the viewfinder

Viewing the sun or other strong light source through the viewfinder could cause permanent visual impairment.

Using the viewfinder diopter adjustment control

When operating the viewfinder diopter adjustment control with your eye to the viewfinder, care should be taken not to put your finger in your eye accidentally.

Turn off immediately in the event of malfunction

Should you notice smoke or an unusual smell coming from the equipment or AC adapter (available separately), unplug the AC adapter and remove the battery immediately, taking care to avoid burns. Continued operation could result in injury. After removing the battery, take the equipment to a Nikon-authorized service center for inspection.

Do not disassemble

Touching the product's internal parts could result in injury. In the event of malfunction, the product should be repaired only by a qualified technician. Should the product break open as the result of a fall or other accident, remove the battery and/or AC adapter and then take the product to a Nikon-authorized service center for inspection.

⚠ Do not use in the presence of flammable gas

Do not use electronic equipment in the presence of flammable gas, as this could result in explosion or fire.

⚠ Keep out of reach of children

Failure to observe this precaution could result in injury. In addition, note that small parts constitute a choking hazard. Should a child swallow any part of this equipment, consult a physician immediately.

⚠ Do not place the strap around the neck of an infant or child

Placing the camera strap around the neck of an infant or child could result in strangulation.

⚠ Do not remain in contact with the camera, battery, or charger for extended periods while the devices are on or in use

Parts of the device become hot. Leaving the device in direct contact with the skin for extended periods may result in low-temperature burns.

⚠ Do not leave the product where it will be exposed to extremely high temperatures, such as in an enclosed automobile or in direct sunlight

Failure to observe this precaution could cause damage or fire.

⚠ Observe proper precautions when handling batteries

Batteries may leak, overheat, rupture, or catch fire if improperly handled. Observe the following precautions when handling batteries for use in this product:

- Use only batteries approved for use in this equipment.
- Use only CR1616 lithium batteries to replace the clock battery. Using another type of battery could cause an explosion. Dispose of used batteries as directed.
- Do not short or disassemble the battery.
- Do not expose the battery or the camera in which it is inserted to powerful physical shocks.
- Be sure the product is off before replacing the battery. If you are using an AC adapter, be sure it is unplugged.
- Do not attempt to insert the battery upside down or backwards.
- Do not expose the battery to flame or to excessive heat.
- Do not immerse in or expose to water.
- Replace the terminal cover when transporting the battery. Do not transport or store the battery with metal objects such as necklaces or hairpins.

- Batteries are prone to leakage when fully discharged. To avoid damage to the product, be sure to remove the battery when no charge remains.
- When the battery is not in use, attach the terminal cover and store in a cool, dry place.
- The battery may be hot immediately after use or when the product has been used on battery power for an extended period. Before removing the battery turn the camera off and allow the battery to cool.
- Discontinue use immediately should you notice any changes in the battery, such as discoloration or deformation.

⚠ Observe proper precautions when handling the charger

- Keep dry. Failure to observe this precaution could result in injury or product malfunction due to fire or electric shock.
- Dust on or near the metal parts of the plug should be removed with a dry cloth. Continued use could result in fire.
- Do not handle the power cable or go near the charger during thunderstorms. Failure to observe this precaution could result in electric shock.

- Do not damage, modify, or forcibly tug or bend the power cable. Do not place it under heavy objects or expose it to heat or flame. Should the insulation be damaged and the wires become exposed, take the power cable to a Nikon-authorized service representative for inspection. Failure to observe this precaution could result in fire or electric shock.
- Do not handle the plug or charger with wet hands. Failure to observe this precaution could result in injury or product malfunction due to fire or electric shock.
- Do not use with travel converters or adapters designed to convert from one voltage to another or with DC-to-AC inverters. Failure to observe this precaution could damage the product or cause overheating or fire.

⚠ Use appropriate cables

When connecting cables to the input and output jacks, use only the cables provided or sold by Nikon for the purpose to maintain compliance with product regulations.

⚠ Do not aim a flash at the operator of a motor vehicle

Failure to observe this precaution could result in accidents.

⚠ Observe caution when using the flash

- Using optional flash units in close contact with the skin or other objects could cause burns.
- Using optional flash units close to the subject's eyes could cause temporary visual impairment. The flash should be no less than one meter (3 ft 4 in.) from the subject. Particular care should be observed when photographing infants.

⚠ Avoid contact with liquid crystal

Should the monitor break, care should be taken to avoid injury due to broken glass and to prevent the liquid crystal from the monitor touching the skin or entering the eyes or mouth.

⚠ Do not carry tripods with a lens or camera attached

You could trip or accidentally strike others, resulting in injury.

⚠ Follow the instructions of airline and hospital personnel

Notices

- No part of the manuals included with this product may be reproduced, transmitted, transcribed, stored in a retrieval system, or translated into any language in any form, by any means, without Nikon's prior written permission.
- Nikon reserves the right to change the appearance and specifications of the hardware and software described in these manuals at any time and without prior notice.
- Nikon will not be held liable for any damages resulting from the use of this product.
- While every effort has been made to ensure that the information in these manuals is accurate and complete, we would appreciate it were you to bring any errors or omissions to the attention of the Nikon representative in your area (address provided separately).

Notices for Customers in Canada

CAN ICES-3 B / NMB-3 B

Notices for Customers in Europe

CAUTION: RISK OF EXPLOSION IF BATTERY IS REPLACED BY AN INCORRECT TYPE. DISPOSE OF USED BATTERIES ACCORDING TO THE INSTRUCTIONS.

This symbol indicates that electrical and electronic equipment is to be collected separately.



The following apply only to users in European countries:

- This product is designated for separate collection at an appropriate collection point. Do not dispose of as household waste.
- Separate collection and recycling helps conserve natural resources and prevent negative consequences for human health and the environment that might result from incorrect disposal.
- For more information, contact the retailer or the local authorities in charge of waste management.

This symbol on the battery indicates that the battery is to be collected separately.



The following apply only to users in European countries:

- All batteries, whether marked with this symbol or not, are designated for separate collection at an appropriate collection point. Do not dispose of as household waste.
- For more information, contact the retailer or the local authorities in charge of waste management.

Notices for Customers in the U.S.A.

The Battery Charger

IMPORTANT SAFETY INSTRUCTIONS—SAVE THESE INSTRUCTIONS

DANGER—TO REDUCE THE RISK OF FIRE OR ELECTRIC SHOCK, CAREFULLY FOLLOW THESE INSTRUCTIONS

For connection to a supply not in the U.S.A., use an attachment plug adapter of the proper configuration for the power outlet if needed. This power unit is intended to be correctly oriented in a vertical or floor mount position.

Federal Communications Commission (FCC) Radio Frequency Interference Statement

This equipment has been tested and found to comply with the limits for a Class B digital device, pursuant to Part 15 of the FCC rules. These limits are designed to provide reasonable protection against harmful interference in a residential installation. This equipment generates, uses, and can radiate radio frequency energy and, if not installed and used in accordance with the instructions, may cause harmful interference to radio communications. However, there is no guarantee that interference will not occur in a particular installation. If this equipment does cause harmful interference to radio or television reception, which can be determined by turning the equipment off and on, the user is encouraged to try to correct the interference by one or more of the following measures:

- Reorient or relocate the receiving antenna.
- Increase the separation between the equipment and receiver.
- Connect the equipment into an outlet on a circuit different from that to which the receiver is connected.
- Consult the dealer or an experienced radio/television technician for help.



Nikon
D5-a/D5-b

CAUTIONS

Modifications

The FCC requires the user to be notified that any changes or modifications made to this device that are not expressly approved by Nikon Corporation may void the user's authority to operate the equipment.

The accessory power cord must be used

For USA only: Over AC 125 V

Use a power cord over AWG 18 in size suited to the voltage in use with plugs rated for AC 250 V 15 A (NEMA 6P-15) and a minimum of SVT type cord for insulation.

Power Supply Cord

Use a UL Listed, 1.8 to 3 m (6 to 10 ft), SPT-2, AWG no. 18 power supply cord rated for 125 V 7 A, with a non-polarized NEMA 1-15P plug rated for 125 V 15 A.

Nikon Inc., 1300 Walt Whitman Road,
Melville, New York 11747-3064, U.S.A.
Tel.: 631-547-4200

Disposing of Data Storage Devices

Please note that deleting images or formatting memory cards or other data storage devices does not completely erase the original image data. Deleted files can sometimes be recovered from discarded storage devices using commercially available software, potentially resulting in the malicious use of personal image data. Ensuring the privacy of such data is the user's responsibility.

Before discarding a data storage device or transferring ownership to another person, erase all data using commercial deletion software, or format the device and then completely refill it with images containing no private information (for example, pictures of empty sky). Care should be taken to avoid injury when physically destroying data storage devices.

Before discarding the camera or transferring ownership to another person, you should also use the **Reset all settings** option in the camera setup menu to delete any personal network information.

AVC Patent Portfolio License

THIS PRODUCT IS LICENSED UNDER THE AVC PATENT PORTFOLIO LICENSE FOR THE PERSONAL AND NON-COMMERCIAL USE OF A CONSUMER TO (i) ENCODE VIDEO IN COMPLIANCE WITH THE AVC STANDARD ("AVC VIDEO") AND/OR (ii) DECODE AVC VIDEO THAT WAS ENCODED BY A CONSUMER ENGAGED IN A PERSONAL AND NON-COMMERCIAL ACTIVITY AND/OR WAS OBTAINED FROM A VIDEO PROVIDER LICENSED TO PROVIDE AVC VIDEO. NO LICENSE IS GRANTED OR SHALL BE IMPLIED FOR ANY OTHER USE. ADDITIONAL INFORMATION MAY BE OBTAINED FROM MPEG LA, L.L.C. SEE

<http://www.mpegla.com>

Notice Concerning Prohibition of Copying or Reproduction

Note that simply being in possession of material that has been digitally copied or reproduced by means of a scanner, digital camera, or other device may be punishable by law.

- **Items prohibited by law from being copied or reproduced**

Do not copy or reproduce paper money, coins, securities, government bonds, or local government bonds, even if such copies or reproductions are stamped "Sample."

The copying or reproduction of paper money, coins, or securities which are circulated in a foreign country is prohibited.

Unless the prior permission of the government has been obtained, the copying or reproduction of unused postage stamps or post cards issued by the government is prohibited.

The copying or reproduction of stamps issued by the government and of certified documents stipulated by law is prohibited.

- **Cautions on certain copies and reproductions**

The government has issued cautions on copies or reproductions of securities issued by private companies (shares, bills, checks, gift certificates, etc.), commuter passes, or coupon tickets, except when a minimum of necessary copies are to be provided for business use by a company. Also, do not copy or reproduce passports issued by the government, licenses issued by public agencies and private groups, ID cards, and tickets, such as passes and meal coupons.

- **Comply with copyright notices**

Under copyright law, photographs or recordings of copyrighted works made with the camera can not be used without the permission of the copyright holder. Exceptions apply to personal use, but note that even personal use may be restricted in the case of photographs or recordings of exhibits or live performances.

Use Only Nikon Brand Electronic Accessories

Nikon cameras are designed to the highest standards and include complex electronic circuitry. Only Nikon brand electronic accessories (including chargers, batteries, AC adapters, and flash accessories) certified by Nikon specifically for use with this Nikon digital camera are engineered and proven to operate within the operational and safety requirements of this electronic circuitry.

The use of non-Nikon electronic accessories could damage the camera and may void your Nikon warranty. The use of third-party rechargeable Li-ion batteries not bearing the Nikon holographic seal shown at right could interfere with normal operation of the camera or result in the batteries overheating, igniting, rupturing, or leaking.

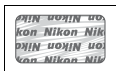

For more information about Nikon brand accessories, contact a local authorized Nikon dealer.

Use Only Nikon Brand Accessories

Only Nikon brand accessories certified by Nikon specifically for use with your Nikon digital camera are engineered and proven to operate within its operational and safety requirements. THE USE OF NON-NIKON ACCESSORIES COULD DAMAGE YOUR CAMERA AND MAY VOID YOUR NIKON WARRANTY.

Before Taking Important Pictures

Before taking pictures on important occasions (such as at weddings or before taking the camera on a trip), take a test shot to ensure that the camera is functioning normally. Nikon will not be held liable for damages or lost profits that may result from product malfunction.

Life-Long Learning

As part of Nikon's "Life-Long Learning" commitment to ongoing product support and education, continually-updated information is available on-line at the following sites:

- **For users in the U.S.A.:** <http://www.nikonusa.com/>
- **For users in Europe and Africa:** <http://www.europe-nikon.com/support/>
- **For users in Asia, Oceania, and the Middle East:** <http://www.nikon-asia.com/>

Visit these sites to keep up-to-date with the latest product information, tips, answers to frequently-asked questions (FAQs), and general advice on digital imaging and photography. Additional information may be available from the Nikon representative in your area. See the following URL for contact information: <http://imaging.nikon.com/>



Introduction

Getting to Know the Camera

Take a few moments to familiarize yourself with camera controls and displays. You may find it helpful to bookmark this section and refer to it as you read through the rest of the manual.

Camera Body

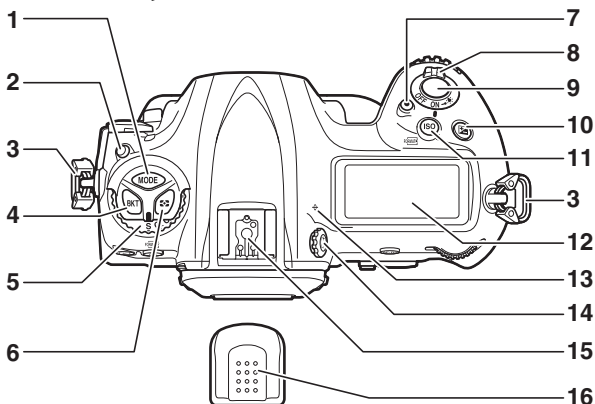

1 MODE button	131	10 button	143
2 Release mode dial lock release ...	116	11 ISO/QUAL button	33, 124, 128
3 Eyelet for camera strap.....	19	12 Top control panel	6
4 BKT button	147, 151, 155, 193, 231, 307	13 Focal plane mark (∅)	115
5 Release mode dial	116	14 Diopter adjustment control	35
6 button	130	15 Accessory shoe (for optional flash unit)	14, 194
7 Movie-record button	61, 307	16 Accessory shoe cover... 14, 194, 355	
8 Power switch.....	9, 27		
9 Shutter-release button.....	40, 41		



Camera Body (Continued)

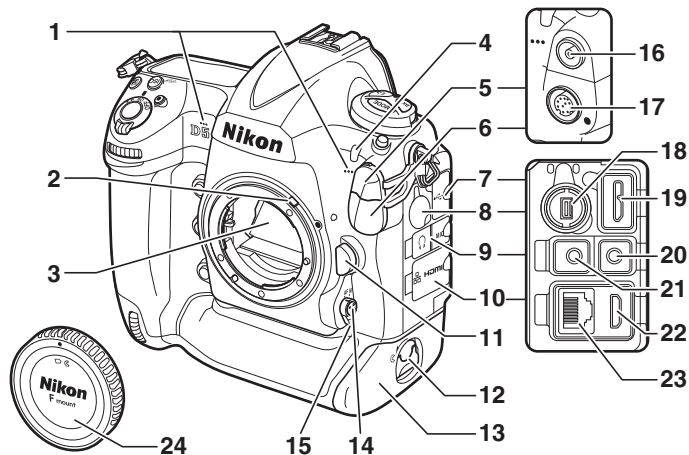

1 Stereo microphone (for movies).....61, 63, 298	13 Battery-chamber cover 22
2 Meter coupling lever373	14 AF-mode button 48, 50, 101, 105
3 Mirror.....122, 347	15 Focus-mode selector 48, 98, 114
4 Self-timer lamp 121	16 Flash sync terminal 195
5 Flash sync terminal cover 195	17 Ten-pin remote terminal ...246, 339
6 Ten-pin remote terminal cover.....246, 339	18 Peripheral connector337
7 USB connector cover278, 283	19 USB connector278, 283
8 Peripheral connector cover.....337	20 Connector for external microphone 64, 341
9 Audio connector cover..... 64, 341	21 Headphone connector 64, 66
10 HDMI/Ethernet connector cover.....281, 286	22 HDMI connector286
11 Lens release button 26	23 Ethernet connector281
12 Battery-chamber cover latch..... 22	24 Body cap25, 339

Close the Connector Cover

Close the connector cover when the connectors are not in use. Foreign matter in the connectors can interfere with data transfer.

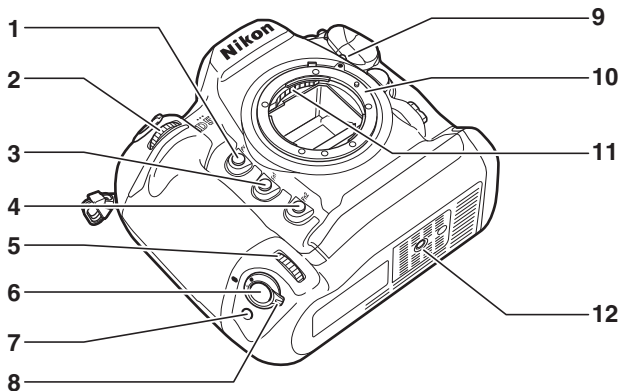

1 Pv button50, 132, 307, 309	7 Fn button (vertical)39, 307
2 Sub-command dial..... 308	8 Vertical shooting shutter-release button lock.....39
3 Fn1 button 307, 309	9 Lens mounting mark.....26
4 Fn2 button 307, 309	10 Lens mount26, 115
5 Sub-command dial for vertical shooting.....39, 308	11 CPU contacts
6 Shutter-release button for vertical shooting.....39	12 Tripod socket

✓ The Speaker

Do not place the speaker in close proximity to magnetic devices. Failure to observe this precaution could affect the data recorded on the magnetic devices.

Camera Body (Continued)

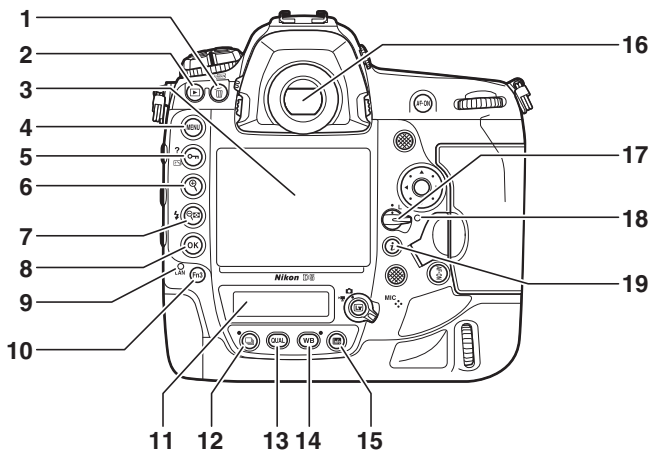

1	Fn button33, 43, 268	11	Rear control panel..... 8
2	▶ button 42, 248	12	▶ button 116, 119, 224, 304
3	Monitor 12, 42, 44, 59, 248, 310	13	QUAL button..... 93, 96
4	MENU button 15, 289	14	WB button 159, 163, 167, 169, 224
5	(L3/?) button 16, 180, 265	15	info (info) button 57, 68, 220
6	Q button.....263	16	Viewfinder..... 10, 35
7	AE-L/AF-ON button..... 199, 200, 248, 263	17	Focus selector lock..... 108
8	OK (OK) button..... 16, 249	18	Memory card access lamp..... 31, 41
9	Network indicator	19	i button 51, 63, 223, 253
10	Fn3 button 273, 276, 307, 309		

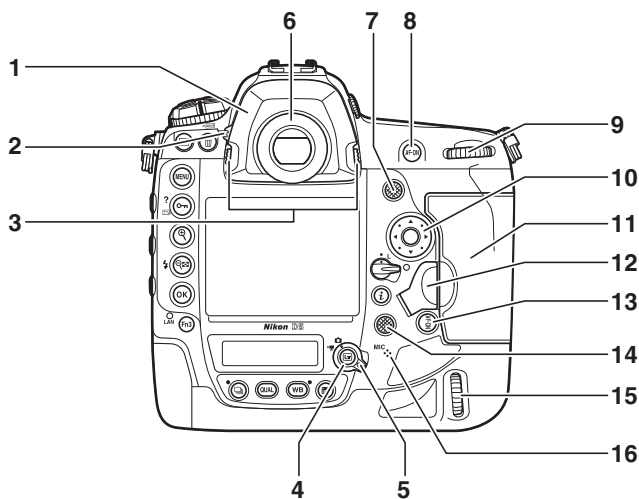

1 Eyepiece adapter36, 338	11 Memory card slot cover 30, 32
2 Eyepiece shutter lever 120	12 Card slot cover release button (under cover)30
3 Eyepiece adapter latch36	13 Fn button39, 102, 307
4 Lv button 44, 59, 173, 309	14 Multi selector (vertical)39, 307
5 Live view selector 44, 59	15 Main command dial (vertical)39, 308
6 Viewfinder eyepiece36, 120	Speaker81, 276
7 Sub-selector109, 111, 141, 307, 309	16 Microphone (for voice memos)..... 272
8 AF-ON button102, 112, 300, 307	
9 Main command dial 308	
10 Multi selector 16, 41, 250	

The Top Control Panel

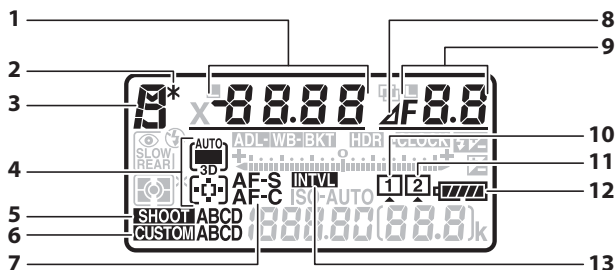

<p>1 Shutter speed..... 134, 136 AF-area mode..... 104, 106 Exposure compensation value..... 143 Flash compensation value 200 Number of shots in exposure and flash bracketing sequence 147 Number of shots in WB bracketing sequence..... 151 Number of intervals for interval timer photography 239 Focal length (non-CPU lenses)..... 245</p>	<p>8 Aperture stop indicator 135, 326 9 Aperture (f-number)..... 135, 136 Aperture (number of stops)..... 135, 326 Bracketing increment..... 148, 152 Number of shots in ADL bracketing sequence 155 Number of shots per interval 239 HDR exposure differential 193 Number of exposures (multiple exposure) 231 Maximum aperture (non-CPU lenses) 245 PC mode indicator..... 339</p>
<p>2 Flexible program indicator..... 133 3 Exposure mode 131 4 AF-area mode indicator 104, 106 5 Photo shooting menu bank..... 291 6 Custom settings bank 299 7 Autofocus mode 101</p>	<p>10 Memory card icon (Slot 1) 32, 33 11 Memory card icon (Slot 2) 32, 33 12 Battery indicator 37 13 Interval timer indicator 239 Time-lapse on indicator..... 79</p>

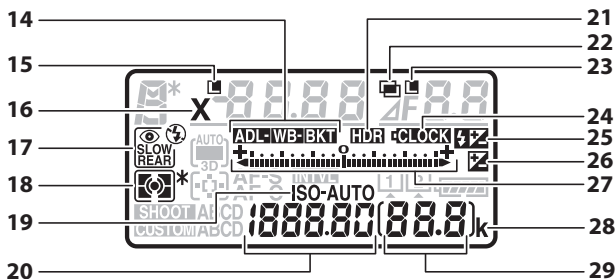

<table border="0"> <tr><td>14</td><td>Exposure and flash bracketing indicator.....</td><td>147</td></tr> <tr><td></td><td>WB bracketing indicator</td><td>151</td></tr> <tr><td></td><td>ADL bracketing indicator.....</td><td>155</td></tr> <tr><td>15</td><td>Shutter-speed lock icon</td><td>140</td></tr> <tr><td>16</td><td>Flash sync indicator.....</td><td>305</td></tr> <tr><td>17</td><td>Flash mode.....</td><td>198</td></tr> <tr><td>18</td><td>Metering</td><td>130</td></tr> <tr><td>19</td><td>ISO sensitivity indicator</td><td>124</td></tr> <tr><td></td><td>Auto ISO sensitivity indicator ...</td><td>128</td></tr> <tr><td>20</td><td>Frame count.....</td><td>38</td></tr> <tr><td></td><td>ISO sensitivity</td><td>124</td></tr> <tr><td></td><td>ISO sensitivity (high/low gain)</td><td>125</td></tr> <tr><td></td><td>White balance preset number.....</td><td>170</td></tr> <tr><td></td><td>Overlay mode</td><td>232</td></tr> <tr><td>21</td><td>HDR indicator</td><td>190</td></tr> <tr><td>22</td><td>Multiple exposure indicator.....</td><td>230</td></tr> <tr><td>23</td><td>Aperture lock icon</td><td>140</td></tr> <tr><td>24</td><td>Clock battery indicator</td><td>29, 351</td></tr> <tr><td>25</td><td>Flash compensation indicator.....</td><td>200</td></tr> <tr><td>26</td><td>Exposure compensation indicator.....</td><td>143</td></tr> </table>	14	Exposure and flash bracketing indicator.....	147		WB bracketing indicator	151		ADL bracketing indicator.....	155	15	Shutter-speed lock icon	140	16	Flash sync indicator.....	305	17	Flash mode.....	198	18	Metering	130	19	ISO sensitivity indicator	124		Auto ISO sensitivity indicator ...	128	20	Frame count.....	38		ISO sensitivity	124		ISO sensitivity (high/low gain)	125		White balance preset number.....	170		Overlay mode	232	21	HDR indicator	190	22	Multiple exposure indicator.....	230	23	Aperture lock icon	140	24	Clock battery indicator	29, 351	25	Flash compensation indicator.....	200	26	Exposure compensation indicator.....	143	<table border="0"> <tr><td>27</td><td>Exposure indicator.....</td><td>137</td></tr> <tr><td></td><td>Exposure compensation display</td><td>143</td></tr> <tr><td></td><td>Bracketing progress indicator: Exposure and flash bracketing.....</td><td>147</td></tr> <tr><td></td><td>WB bracketing</td><td>151</td></tr> <tr><td></td><td>ADL bracketing.....</td><td>155</td></tr> <tr><td></td><td>PC connection indicator.....</td><td>339</td></tr> <tr><td>28</td><td>"k" (appears when memory remains for over 1000 exposures)</td><td>38</td></tr> <tr><td>29</td><td>Number of exposures remaining</td><td>38, 385</td></tr> <tr><td></td><td>Number of shots remaining before memory buffer fills.....</td><td>118, 385</td></tr> <tr><td></td><td>Preset white balance recording indicator.....</td><td>170</td></tr> <tr><td></td><td>Active D-Lighting amount.....</td><td>156</td></tr> <tr><td></td><td>HDR mode</td><td>193</td></tr> <tr><td></td><td>Multiple exposure mode.....</td><td>231</td></tr> <tr><td></td><td>Manual lens number.....</td><td>245</td></tr> <tr><td></td><td>Time-lapse recording indicator...79</td><td></td></tr> <tr><td></td><td>Capture mode indicator</td><td>339</td></tr> </table>	27	Exposure indicator.....	137		Exposure compensation display	143		Bracketing progress indicator: Exposure and flash bracketing.....	147		WB bracketing	151		ADL bracketing.....	155		PC connection indicator.....	339	28	"k" (appears when memory remains for over 1000 exposures)	38	29	Number of exposures remaining	38, 385		Number of shots remaining before memory buffer fills.....	118, 385		Preset white balance recording indicator.....	170		Active D-Lighting amount.....	156		HDR mode	193		Multiple exposure mode.....	231		Manual lens number.....	245		Time-lapse recording indicator...79			Capture mode indicator	339
14	Exposure and flash bracketing indicator.....	147																																																																																																											
	WB bracketing indicator	151																																																																																																											
	ADL bracketing indicator.....	155																																																																																																											
15	Shutter-speed lock icon	140																																																																																																											
16	Flash sync indicator.....	305																																																																																																											
17	Flash mode.....	198																																																																																																											
18	Metering	130																																																																																																											
19	ISO sensitivity indicator	124																																																																																																											
	Auto ISO sensitivity indicator ...	128																																																																																																											
20	Frame count.....	38																																																																																																											
	ISO sensitivity	124																																																																																																											
	ISO sensitivity (high/low gain)	125																																																																																																											
	White balance preset number.....	170																																																																																																											
	Overlay mode	232																																																																																																											
21	HDR indicator	190																																																																																																											
22	Multiple exposure indicator.....	230																																																																																																											
23	Aperture lock icon	140																																																																																																											
24	Clock battery indicator	29, 351																																																																																																											
25	Flash compensation indicator.....	200																																																																																																											
26	Exposure compensation indicator.....	143																																																																																																											
27	Exposure indicator.....	137																																																																																																											
	Exposure compensation display	143																																																																																																											
	Bracketing progress indicator: Exposure and flash bracketing.....	147																																																																																																											
	WB bracketing	151																																																																																																											
	ADL bracketing.....	155																																																																																																											
	PC connection indicator.....	339																																																																																																											
28	"k" (appears when memory remains for over 1000 exposures)	38																																																																																																											
29	Number of exposures remaining	38, 385																																																																																																											
	Number of shots remaining before memory buffer fills.....	118, 385																																																																																																											
	Preset white balance recording indicator.....	170																																																																																																											
	Active D-Lighting amount.....	156																																																																																																											
	HDR mode	193																																																																																																											
	Multiple exposure mode.....	231																																																																																																											
	Manual lens number.....	245																																																																																																											
	Time-lapse recording indicator...79																																																																																																												
	Capture mode indicator	339																																																																																																											

Note: Display shown with all indicators lit for illustrative purposes.

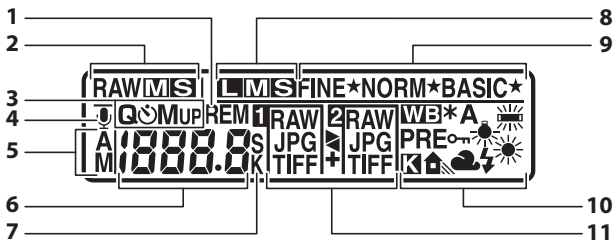

The Rear Control Panel



<p>1 "Remaining" indicator.....385</p> <p>2 Image size (NEF/RAW)..... 96</p> <p>3 Release mode..... 116, 119</p> <p>4 Voice memo status indicator274, 275</p> <p>5 Voice memo recording mode....274</p> <p>6 Release mode..... 116, 119</p> <p>Continuous shooting speed..... 116, 303</p> <p>Self-timer shot count/self-timer delay 121, 303</p> <p>Number of exposures remaining.....93, 96, 385</p> <p>Length of voice memo274</p> <p>White balance fine-tuning..... 163</p> <p>White balance preset number 170</p> <p>Color temperature..... 161, 167</p> <p>PC mode indicator339</p>	<p>7 "k" (appears when memory remains for over 1000 exposures)..... 38</p> <p>Color temperature indicator 167</p> <p>Supplementary seconds display 121, 274</p> <p>8 Image size (JPEG and TIFF images)..... 96</p> <p>9 Image quality 92</p> <p>10 White balance 159</p> <p>White balance fine-tuning indicator 163</p> <p>White balance preset protection indicator..... 172</p> <p>11 Role played by memory card in Slot 2 97</p> <p>Image quality 92</p>
---	--

Note: Display shown with all indicators lit for illustrative purposes.

LCD Illuminators

Rotating the power switch toward  activates the backlights for the buttons and control panels, making it easier to use the camera in the dark. After the power switch is released, the backlights will remain lit for a few seconds while the standby timer is active or until the shutter is released or the power switch is rotated toward  again.

Power switch

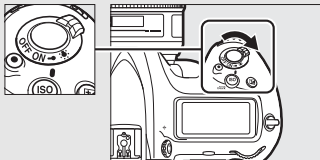

The Control Panel and Viewfinder Displays

The brightness of the control panel and viewfinder displays varies with temperature, and the response times of the displays may drop at low temperatures. This is normal and does not indicate a malfunction.



The Viewfinder Display

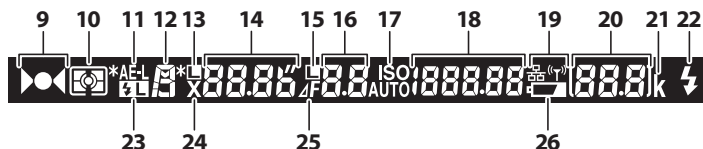
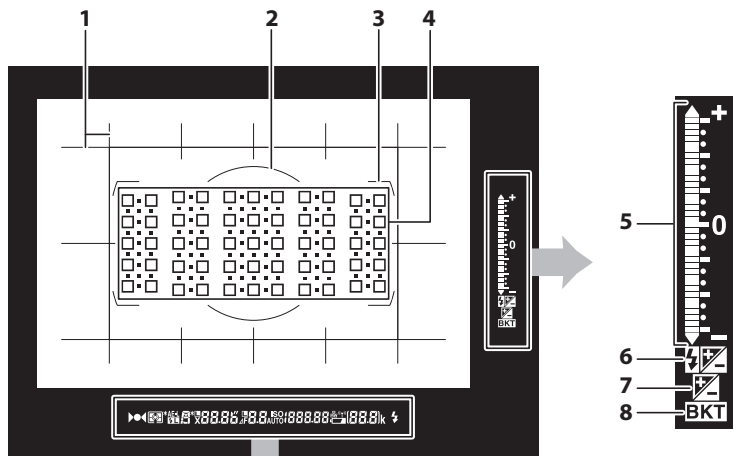

1 Framing grid (displayed when On is selected for Custom Setting d8) 304	5 Exposure indicator 137 Exposure compensation display 143
2 12-mm reference circle for center-weighted metering 129	Bracketing progress indicator: Exposure and flash bracketing 147
3 AF area brackets 35	Pitch indicator ²
4 Focus points 40, 108, 300 Spot metering targets 129 AF-area mode indicator 105 Roll indicator ¹	6 Exposure compensation indicator 143 7 Flash compensation indicator 200

<p>8 Bracketing indicator: Exposure and flash bracketing 147 WB bracketing 151 ADL bracketing 155</p> <p>9 Focus indicator 40, 115</p> <p>10 Metering 129</p> <p>11 Autoexposure (AE) lock 141</p> <p>12 Exposure mode 131</p> <p>13 Shutter speed lock icon 140</p> <p>14 Shutter speed 134, 136 Autofocus mode 98, 101</p> <p>15 Aperture lock icon 140</p> <p>16 Aperture (f-number) 135, 136 Aperture (number of stops) 135, 326</p> <p>17 ISO sensitivity indicator 124 Auto ISO sensitivity indicator 127</p> <p>18 ISO sensitivity 124 Active D-Lighting amount AF-area mode 105, 106</p>	<p>19 Network display 281</p> <p>20 Number of exposures remaining 38, 385 Number of shots remaining before memory buffer fills 40, 118, 385 Preset white balance recording indicator 170 Exposure compensation value 143 Flash compensation value 200 PC mode indicator 339 Flicker detection indicator 227</p> <p>21 “k” (appears when memory remains for over 1000 exposures) 38</p> <p>22 Flash-ready indicator³ 194, 203, 374</p> <p>23 FV lock indicator 203</p> <p>24 Flash sync indicator 305</p> <p>25 Aperture stop indicator 135, 326</p> <p>26 Low battery warning 37</p>
--	---



- 1 Functions as a pitch indicator when camera is rotated to take pictures in “tall” (portrait) orientation.
- 2 Functions as a roll indicator when camera is rotated to take pictures in “tall” (portrait) orientation.
- 3 Displayed when an optional flash unit is attached (□ 194). The flash-ready indicator lights when the flash is charged.

Note: Display shown with all indicators lit for illustrative purposes.

No Battery

When the battery is totally exhausted or no battery is inserted, the display in the viewfinder will dim. This is normal and does not indicate a malfunction. The viewfinder display will return to normal when a fully-charged battery is inserted.

Using the Touch Screen

The touch-sensitive monitor supports the following operations:

Flick

Flick a finger a short distance left or right across the monitor.

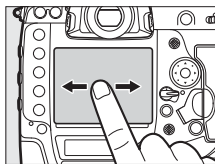

Slide

Slide a finger over the monitor.

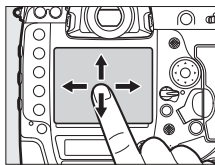

Stretch/Pinch

Place two fingers on the monitor and move them apart or pinch them together.

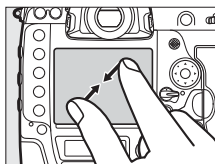
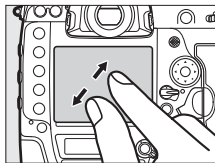

■ ■ *Using the Touch Screen*

During playback (☞ 251), the touch screen can be used to:

- View other images
- Zoom in or out
- View thumbnails
- View movies

The touch screen can be used to position the focus point during live view (☞ 49), to measure a value for preset manual white balance using spot white balance tool (☞ 173), and for typing (☞ 185).



✓ **The Touch Screen**

The touch screen responds to static electricity and may not respond when covered with third-party protective films or when touched with fingernails or gloved hands. Do not use excessive force or touch the screen with sharp objects.

✓ **Using the Touch Screen**

The touch screen may not respond as expected if you attempt to operate it while leaving your palm or another finger resting on it in second location. It may not recognize other gestures if your touch is too soft, your fingers are moved too quickly or too short a distance or do not remain in contact with the screen, or if the movement of the two fingers in a pinch or stretch is not correctly coordinated.

✍ **Enabling or Disabling Touch Controls**

Touch controls can be enabled or disabled using the **Touch controls** option in the setup menu (☞ 312).

✍ **See Also**

The **Touch controls** option in the setup menu can be used to choose the direction you flick your finger to view other images in full-frame playback (☞ 312).

The Accessory Shoe Cover

The supplied accessory shoe cover can be used to protect the accessory shoe or to prevent light reflected from the metal parts of the shoe from appearing in photographs. The cover attaches to the camera accessory shoe as shown at right.

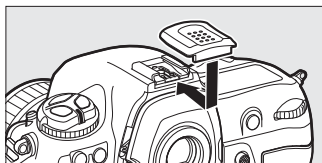

To remove the accessory shoe cover, hold it down with your thumb and slide it off as shown at right while keeping a firm grip on the camera.

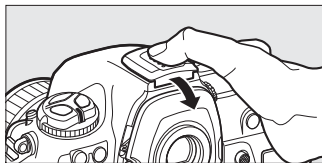

Tutorial

Camera Menu

Most shooting, playback, and setup options can be accessed from the camera menu. To view the menus, press the **MENU** button.

MENU button

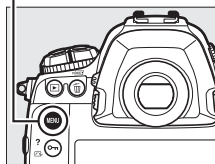

Tabs

Choose from the following menus:

- **Playback** (📖 289)
- **Photo Shooting** (📖 291)
- **Movie Shooting** (📖 296)
- **Custom Settings** (📖 299)
- **Setup** (📖 310)
- **Retouch** (📖 314)
- **MY MENU** or **RECENT SETTINGS**
(defaults to **MY MENU**; 📖 316)

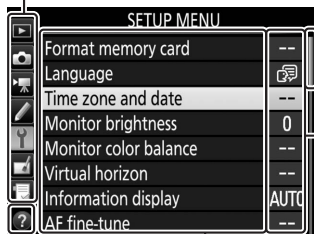

Slider shows position in current menu.

Current settings are shown by icons.

Menu options
Options in current menu.

Help icon (📖 16)

Using Camera Menu

Menu Controls

The multi selector and **OK** button are used to navigate the menus.

Multi selector

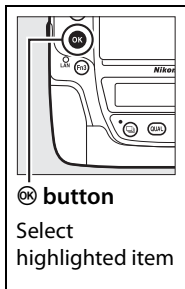
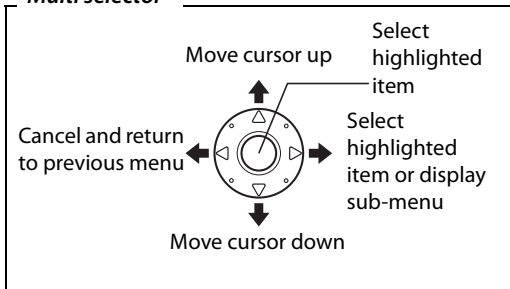

The ? (Help) Icon

If a ? icon is displayed at the bottom left corner of the monitor, help can be displayed by pressing the **?** (**?**) button.

A description of the currently selected option or menu will be displayed while the button is pressed. Press **▲** or **▼** to scroll through the display.

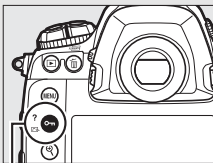

? (?**) button**

? Multiple exposure

Record the specified number of shots as a single image using the selected overlay mode. The standby timer is extended by 30 s. If the timer expires, shooting will end and a multiple exposure will be created from any shots that have been taken.

■ Navigating the Menus

Follow the steps below to navigate the menus.

1 Display the menus.

Press the **MENU** button to display the menus.

MENU button

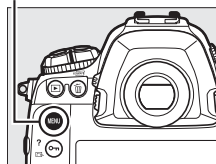

2 Highlight the icon for the current menu.

Press  to highlight the icon for the current menu.

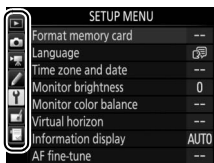

3 Select a menu.

Press  or  to select the desired menu.



4 Position the cursor in the selected menu.

Press  to position the cursor in the selected menu.

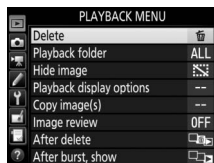

5 Highlight a menu item.

Press or to highlight a menu item.

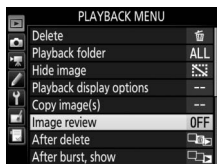

6 Display options.

Press to display options for the selected menu item.



7 Highlight an option.

Press or to highlight an option.



8 Select the highlighted item.

Press to select the highlighted item. To exit without making a selection, press the MENU button.

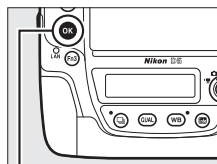

button

Note the following points:

- Menu items that are displayed in gray are not currently available.
- While pressing or the center of the multi selector generally has the same effect as pressing , there are some items for which selection can only be made by pressing .
- To exit the menus and return to shooting mode, press the shutter-release button halfway (□ 40).

First Steps

Attach the Camera Strap

Attach the strap securely to the camera eyelets.

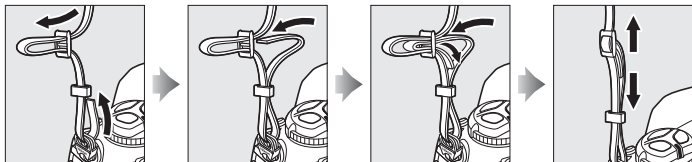

Charge the Battery

The D5 is powered by an EN-EL18c rechargeable Li-ion battery (supplied). To maximize shooting time, charge the battery in the supplied MH-26a battery charger before use. Batteries take about 2 hours and 35 minutes to fully recharge when no charge remains.

1 Plug the charger in.

Insert the AC adapter plug into the battery charger and plug the power cable into an electrical outlet.

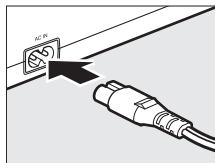

2 Remove the terminal cover.

Remove the terminal cover from the battery.



See Also

For information on using the MH-26a to charge two batteries, see page 381.

3 Remove the contact protector.

Remove the contact protector from the charger battery chamber.

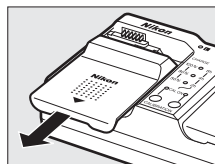

4 Charge the battery.

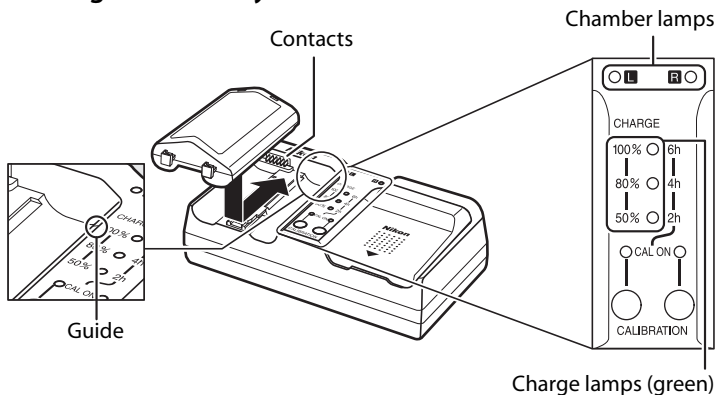

Insert the battery (terminals first), aligning the end of the battery with the guide and then sliding the battery in the direction indicated until it clicks into place. The chamber lamp and charge lamps will flash slowly while the battery charges:

Charge state	Chamber lamp	Charge lamps		
		50%	80%	100%
Less than 50% of maximum capacity	☼ (flashes slowly)	☼ (flashes slowly)	● (off)	● (off)
50–80% of maximum capacity	☼ (flashes slowly)	○ (glows)	☼ (flashes slowly)	● (off)
More than 80% but less than 100% of maximum capacity	☼ (flashes slowly)	○ (glows)	○ (glows)	☼ (flashes slowly)
100% of maximum capacity	○ (glows)	● (off)	● (off)	● (off)

Charging is complete when the chamber lamp stops flashing and the charge lamps turn off. About 2 hours and 35 minutes are required to fully charge an exhausted battery; note that the battery will not charge if its temperature is below 0 °C (32 °F) or above 60 °C (140 °F).

5 Remove the battery when charging is complete.

Remove the battery and unplug the charger.



✓ Calibration

See page 380 for more information on calibration.

Insert the Battery

1 Turn the camera off.

✓ Inserting and Removing Batteries

Before inserting or removing the battery, confirm that power switch is in the **OFF** position.

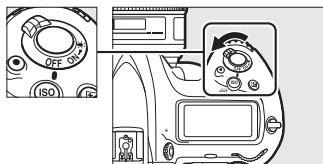

2 Remove the battery-chamber cover.

Lift the battery-chamber cover latch, turn it to the open (☞) position (①) and remove the BL-6 battery-chamber cover (②).

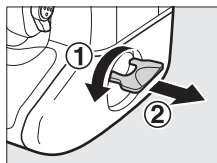

3 Attach the cover to the battery.

If the battery release is positioned so that the arrow (◀) is visible, slide the battery release to cover the arrow. Insert the two projections on the battery into the matching slots in the cover and slide the battery release to completely reveal the arrow.

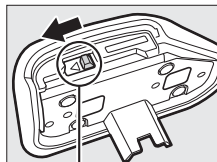

Battery release

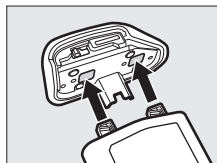

✎ The BL-6 Battery-Chamber Cover

The battery can be charged with the BL-6 attached. To prevent dust from accumulating inside the battery chamber when the battery is not inserted, slide the battery release in the direction indicated by the arrow (◀), remove the BL-6 from the battery, and replace it on the camera. *Other battery covers can not be used with this camera.*

4 Insert the battery.

Insert the battery as shown at right.

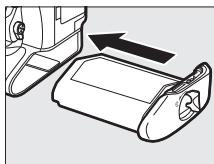

5 Latch the cover.

To prevent the battery from becoming dislodged during operation, rotate the latch to the closed position and fold it down as shown at right. Be sure the cover is securely latched.

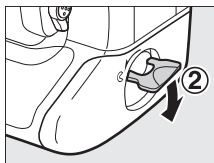
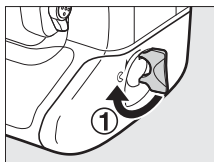

Removing the Battery

Before removing the battery, turn the camera off, lift the battery-chamber cover latch, and turn it to the open (☞) position. Note that the battery may be hot after use; observe due caution when removing the battery. To prevent short-circuits, replace the terminal cover when the battery is not in use.

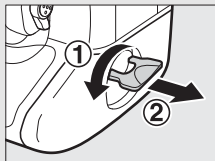

EN-EL18c Rechargeable Li-ion Batteries

The supplied EN-EL18c shares information with compatible devices, enabling the camera to show battery charge state in six levels (☞ 37). The **Battery info** option in the setup menu details battery charge, battery life, and the number of pictures taken since the battery was last charged (☞ 313). The battery can be recalibrated as necessary to ensure that battery level continues to be reported accurately (☞ 380).

The Battery and Charger

Read and follow the warnings and cautions on pages x–xiii and 353–356 of this manual. Do not use the battery at ambient temperatures below 0 °C (32 °F) or above 40 °C (104 °F); failure to observe this precaution could damage the battery or impair its performance. Capacity may be reduced and charging times increase at battery temperatures from 0 °C (32 °F) to 15 °C (59 °F) and from 45 °C (113 °F) to 60 °C (140 °F).

Do not short the charger terminals; failure to observe this precaution could result in overheating and damage to the charger. Charge indoors at ambient temperatures of 5 °C (41 °F) to 35 °C (95 °F). Battery capacity may temporarily drop if the battery is charged at low temperatures or used at a temperature below the temperature at which it was charged. If the battery is charged at a temperature below 5 °C (41 °F), the battery life indicator in the **Battery info** (🔋 313) display may show a temporary decrease.

Use the charger with compatible batteries only. Unplug when not in use.

A marked drop in the time a fully charged battery retains its charge when used at room temperature indicates that it requires replacement. Purchase a new battery.

Attach a Lens

Care should be taken to prevent dust from entering the camera when the lens is removed. The lens generally used in this manual for illustrative purposes is an AF-S NIKKOR 50mm f/1.4G.

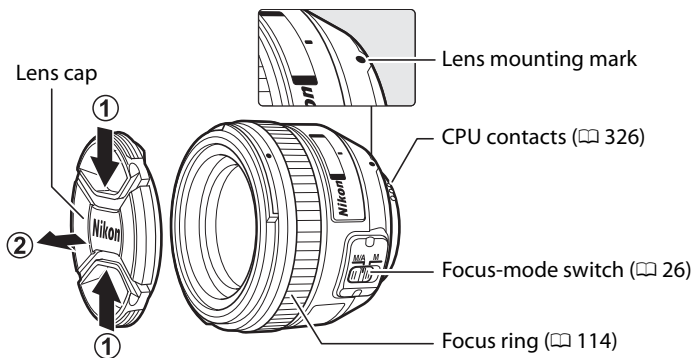

1 Turn the camera off.

2 Remove the rear lens cap and the camera body cap.

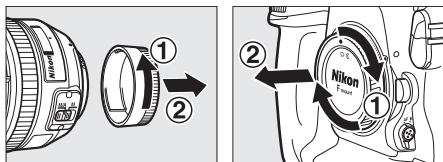

3 Attach the lens.

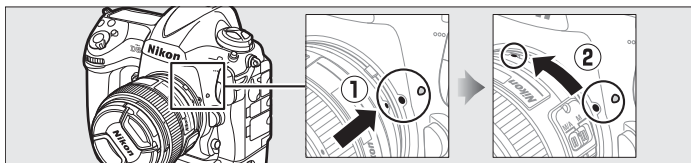

Keeping the mounting mark on the lens aligned with the mounting mark on the camera body, position the lens in the camera's bayonet mount (①). Being careful not to press the lens-release button, rotate the lens counter-clockwise until it clicks into place (②).

✎ Detaching the Lens

Be sure the camera is off when removing or exchanging lenses. To remove the lens, press and hold the lens release button (①) while turning the lens clockwise (②). After removing the lens, replace the lens caps and camera body cap.

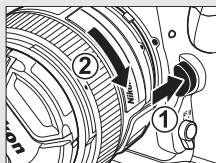

✎ Lens Focus Mode

If the lens is equipped with a focus mode switch, select autofocus mode (A, M/A, or A/M).

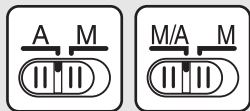

✔ CPU Lenses with Aperture Rings

In the case of CPU lenses equipped with an aperture ring (326), lock aperture at the minimum setting (highest f-number).

✎ Image Area

The DX format image area is automatically selected when a DX lens is attached (88).



Image area

Basic Setup

The language option in the setup menu is automatically highlighted the first time menus are displayed. Choose a language and set the camera clock.

1 Turn the camera on.

Power switch

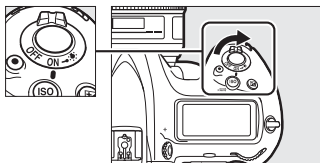

2 Select Language in the setup menu.

Press the MENU button to display the camera menus, then highlight **Language** in the setup menu and press . For information on using menus, see “Using Camera Menus” (📖 16).

MENU button

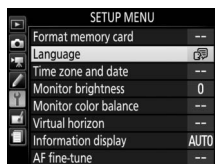
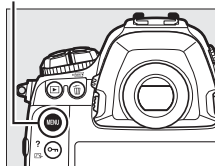

3 Select a language.

Press or to highlight the desired language and press .





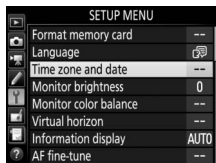

4 Select Time zone and date.

Select **Time zone and date** and press .



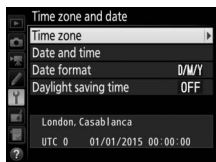

5 Set time zone.

Select **Time zone** and press . Press  or  to highlight the local time zone (the **UTC** field shows the difference between the selected time zone and Coordinated Universal Time, or UTC, in hours) and press .







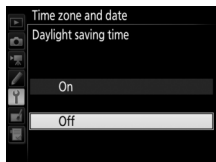

6 Turn daylight saving time on or off.

Select **Daylight saving time** and press . Daylight saving time is off by default; if daylight saving time is in effect in the local time zone, press  to highlight **On** and press .



7 Set the date and time.

Select **Date and time** and press . Press  or  to select an item,  or  to change. Press  when the clock is set to the current date and time (note that the camera uses a 24-hour clock).

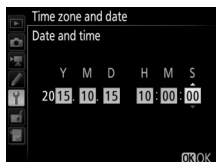

8 Set date format.

Select **Date format** and press . Press or to choose the order in which the year, month, and day will be displayed and press .

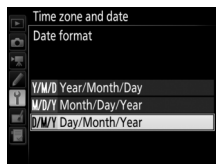

9 Exit to shooting mode.

Press the shutter-release button halfway to exit to shooting mode.



The Clock Battery

The camera clock is powered by a separate, non-rechargeable CR1616 lithium battery with a life of about two years. When this battery is low, a icon will be displayed in the top control panel while the standby timer is on. For information on replacing the clock battery, see page 351.

The Camera Clock

The camera clock is less accurate than most watches and household clocks. Check the clock regularly against more accurate time pieces and reset as necessary.

GPS Units (📖 246)

If a GPS unit (📖 340) is connected, the camera clock will be set to the time and date provided by the GPS unit (📖 247).



Insert a Memory Card

Pictures are stored on memory cards (available separately;  383). The camera is equipped with slots for either two XQD or two Type I CompactFlash cards. Type II cards and microdrives can not be used.

1 Turn the camera off.

Power switch

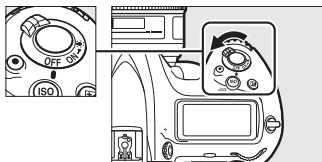

Inserting and Removing Memory Cards

Always turn the camera off before inserting or removing memory cards.

2 Open the card slot cover.

Open the door protecting the card-slot cover release button (1) and press the release button (2) to open the card slot (3).

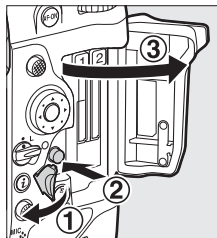

3 Insert the memory card.

Insert the card into the card slot with the rear label toward the monitor. When the memory card is fully inserted, the eject button will pop up and the green memory card access lamp will light briefly.

Eject button

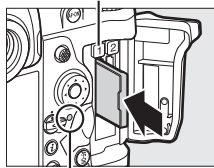

Memory card access lamp

✓ Inserting Memory Cards

Insert memory cards terminals first. Inserting a card upside down or backwards could damage the camera or the card. Check to be sure that the card is in the correct orientation.

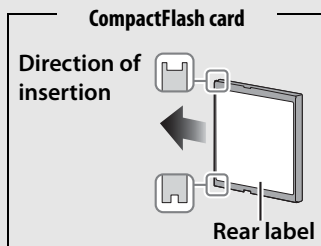
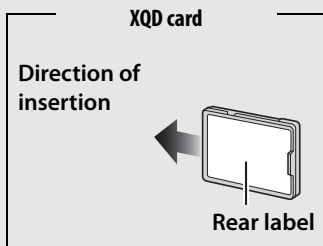

4 Close the card slot cover.

If this is the first time the memory card will be used after being used or formatted in another device, format the card as described on page 33.

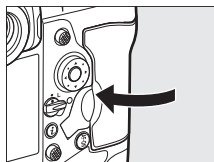

Memory Card Icons

The memory card icons light when memory cards are inserted (the example at right shows the display when two memory cards are inserted). If the memory card is full or an error has occurred, the icon for the affected card will flash ( 366).

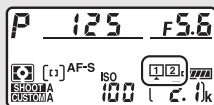

Top control panel

Removing Memory Cards

After confirming that the memory card access lamp is off, turn the camera off and open the memory card slot cover. Press the eject button (1) to partially eject the card (2). The memory card can then be removed by hand. Do not push on the memory card while pressing the eject button. Failure to observe this precaution could damage the camera or memory card.

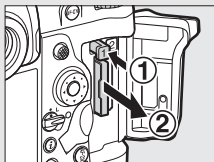

See Also

Use the **Role played by card in Slot 2** option in the photo shooting menu to choose the role played by memory cards inserted in Slot 2 ( 97).

Format the Memory Card

Memory cards must be formatted before first use or after being used or formatted in other devices.



✓ Formatting Memory Cards

Formatting memory cards permanently deletes any data they may contain.

Be sure to copy any photographs and other data you wish to keep to a computer before proceeding (□ 278).

1 Turn the camera on.

2 Press the (FORMAT) and ISO (FORMAT) buttons.

Hold the  (FORMAT) and ISO (FORMAT) buttons down simultaneously until a flashing **F o r** appears in the shutter-speed displays in the top control panel and viewfinder. If two memory cards are inserted, the card to be formatted is shown by a flashing icon. By default, Slot 1 (□ 97) will be selected; you can choose Slot 2 by rotating the main command dial. To exit without formatting the memory card, wait until **F o r** stops flashing (about six seconds) or press any button other than the  (FORMAT) and ISO (FORMAT) buttons.

 (FORMAT) button ISO (FORMAT) button

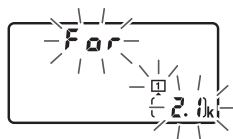
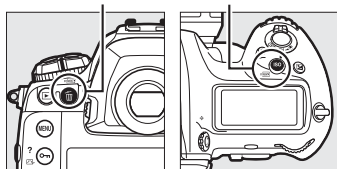

3 Press the (FORMAT) and ISO (FORMAT) buttons again.

Press the  (FORMAT) and ISO (FORMAT) buttons together a second time while **F** **5.6** is flashing to format the memory card. *Do not remove the memory card or remove or disconnect the power source during formatting.*



Memory Cards

- Memory cards may be hot after use. Observe due caution when removing memory cards from the camera.
- Turn the power off before inserting or removing memory cards. Do not remove memory cards from the camera, turn the camera off, or remove or disconnect the power source during formatting or while data are being recorded, deleted, or copied to a computer. Failure to observe these precautions could result in loss of data or in damage to the camera or card.
- Do not touch the card terminals with your fingers or metal objects.
- Do not bend, drop, or subject to strong physical shocks.
- Do not apply force to the card casing. Failure to observe this precaution could damage the card.
- Do not expose to water, high levels of humidity, or direct sunlight.
- Do not format memory cards in a computer.

No Memory Card

If no memory card is inserted, the top control panel and viewfinder will show (-E-). If the camera is turned off with a charged battery and no memory card inserted, (-E-) will be displayed in the top control panel.

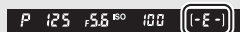
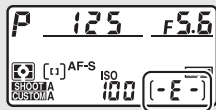

See Also

See page 310 for information on formatting memory cards using the **Format memory card** option in the setup menu.

Adjust Viewfinder Focus

The camera is equipped with diopter adjustment to accommodate individual differences in vision. Check that the display in the viewfinder is in focus before shooting.

1 Turn the camera on.

Remove the lens cap and turn the camera on.

2 Lift the diopter adjustment control (1).

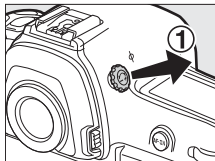

3 Focus the viewfinder.

Rotate the diopter adjustment control (2) until the viewfinder display, focus points, and AF area brackets are in sharp focus. When operating the control with your eye to the viewfinder, be careful not to put your fingers or fingernails in your eye.

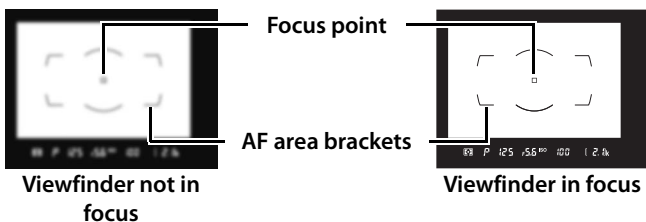
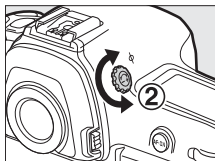



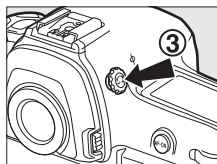

4 Replace the diopter adjustment control.

Push the diopter adjustment control back in (3).



Adjusting Viewfinder Focus

If you are unable to focus the viewfinder as described above, select single-servo AF (**AF-S**;  101), single-point AF ( 104), and the center focus point ( 108), and then frame a high-contrast subject in the center focus point and press the shutter-release button halfway to focus the camera. With the camera in focus, use the diopter adjustment control to bring the subject into clear focus in the viewfinder. If necessary, viewfinder focus can be further adjusted using optional corrective lenses ( 338).

Diopter-Adjustment Viewfinder Lenses

Corrective lenses (available separately;  338) can be used to further adjust viewfinder diopter. Before attaching a diopter-adjustment viewfinder lens, remove the DK-17F viewfinder eyepiece by pressing the latches on either side of the eyepiece adapter to release the eyepiece lock (1) and then unscrewing the eyepiece as shown at right (2).

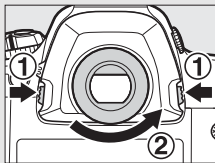

Basic Photography and Playback

The Battery Level and Number of Exposures Remaining

Before taking photographs, check the battery level and number of exposures remaining as described below.

■ ■ *Battery Level*

The battery level is shown in the top control panel and viewfinder.

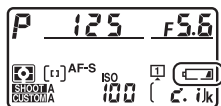

Top control panel



Viewfinder

Icon		Description	
Control panel	Viewfinder		
	—	Battery fully charged.	
	—		
	—		Battery partially discharged.
	—		
		Low battery. Charge battery or ready spare battery.	
 (flashes)	 (flashes)	Shutter release disabled. Charge or exchange battery.	

■ Number of Exposures Remaining

The top control panel shows the number of photographs that can be taken at current settings (values over 1000 are rounded down to the nearest hundred; e.g., values between 2100 and 2199 are shown as 2.1 k). If two memory cards are inserted, the displays show the space available on the card to which new photos will be saved. When this number reaches zero, 0 will flash in the exposure-count displays while the shutter-speed displays will show a flashing **F u L L** or **F u L** and the icon for the affected card will flash. Insert another memory card or delete some photos.

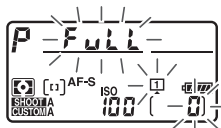
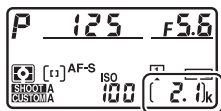

✎ Camera Off Display

If the camera is turned off with a battery and memory card inserted, the memory card icon, the number of exposures remaining, and the number of photos in the current folder will be displayed (depending on the memory card, the camera may in rare cases not display this information when a card is inserted; this can be addressed by turning the camera on).

Number of photos in current folder

Number of exposures remaining

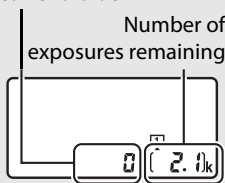

Top control panel

Ready the Camera

When framing photographs in the viewfinder, hold the handgrip in your right hand and cradle the camera body or lens with your left. Keep your elbows propped lightly against your torso for support and place one foot half a pace ahead of the other to keep your upper body stable.

When framing photographs in portrait (tall) orientation, hold the camera as shown in the bottom of the three illustrations at right.

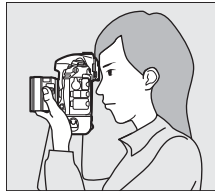

☑ Framing Photos in Portrait (Tall) Orientation

The camera is equipped with controls for use in portrait (tall) orientation, including a vertical shutter-release, **Fn**, and **AF-ON** buttons, main and sub-command dials, and multi selector (☐ 102, 109, 307). Rotate the vertical shooting shutter-release button lock to **L** to avoid accidentally operating these controls when the camera is in landscape (wide) orientation.

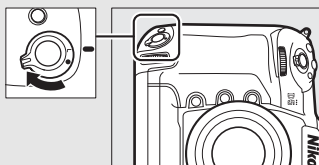

Vertical shooting shutter-release button lock

Focus and Shoot

1 Press the shutter-release button halfway.

At default settings, the camera will focus on the subject in the center focus point. Frame a photo in the viewfinder with the main subject positioned in the center focus point and press the shutter-release button halfway.

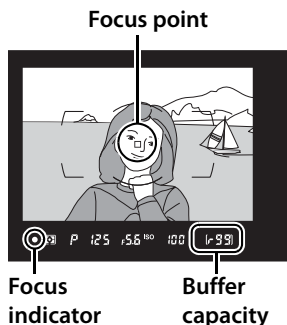

2 Check indicators in the viewfinder.

When the focus operation is complete, the in-focus indicator (●) will appear in the viewfinder.

Viewfinder display	Description
●	Subject in focus.
▶	Focus point is between camera and subject.
◀	Focus point is behind subject.
▶ ◀ (flashes)	Camera unable to focus on subject in focus point using autofocus.

While the shutter-release button is pressed halfway, focus will lock and the number of exposures that can be stored in the memory buffer ("1-99"; □ 118) will be shown in the viewfinder display.



For information on what to do if the camera is unable to focus using autofocus, see "Getting Good Results with Autofocus" (□ 113).

3 Shoot.

Smoothly press the shutter-release-button the rest of the way down to take the photograph. While the photograph is being recorded to the memory card, the memory card access lamp will light. *Do not eject the memory card or remove or disconnect the power source until the lamp has gone out and recording is complete.*

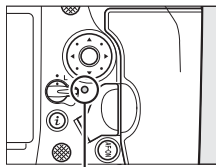

Memory card access lamp

The Standby Timer (Viewfinder Photography)

The shutter speed and aperture displays in the top control panel and viewfinder will turn off if no operations are performed for about six seconds, reducing the drain on the battery. Press the shutter-release button halfway to reactivate the displays.

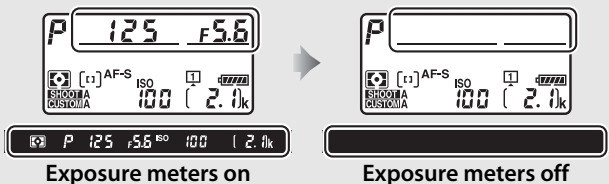

Exposure meters on

Exposure meters off

The length of time before the standby timer expires automatically can be adjusted using Custom Setting c2 (**Standby timer**, 303).

The Multi Selector

The multi selector can be used to select the focus point while the exposure meters are on (108).

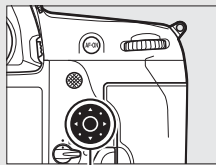

Multi selector



Viewing Photographs



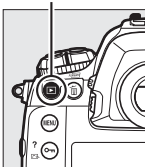

1 Press the button.

A photograph will be displayed in the monitor. The memory card containing the picture currently displayed is shown by an icon.

 button



2 View additional pictures.

Additional pictures can be displayed by pressing  or  or flicking a finger left or right over the display (📖 251). To view additional information on the current photograph, press  and  (📖 254).

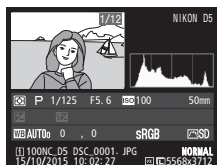

To end playback and return to shooting mode, press the shutter-release button halfway.

Image Review

When **On** is selected for **Image review** in the playback menu (📖 290), photographs are automatically displayed in the monitor after shooting.

See Also

See page 249 for information on choosing a memory card slot.

Deleting Unwanted Photographs



Unwanted photographs can be deleted by pressing the  (FORMAT) button. Note that photographs can not be recovered once deleted.

1 Display the photograph.

Display the photograph you wish to delete as described in “Viewing Photographs” on the previous page. The location of the current image is shown by an icon at the bottom left corner of the display.



2 Delete the photograph. (FORMAT) button

Press the  (FORMAT) button. A confirmation dialog will be displayed; highlight **Selected image** and press  (FORMAT) again to delete the image and return to playback (for information on the **All images** option, see page 268). To exit without deleting the picture, press .

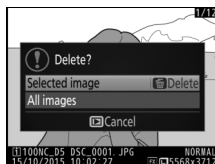
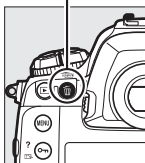

Delete

To delete multiple images or to select the memory card from which images will be deleted, use the **Delete** option in the playback menu (270).

Live View Photography

Follow the steps below to take photographs in live view.

- 1 Rotate the live view selector to  (live view photography).**

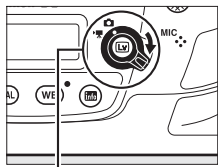

Live view selector

- 2 Press the  button.**
The mirror will be raised and the view through the lens will be displayed in the camera monitor. The subject will no longer be visible in the viewfinder.

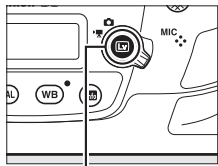

LV button

- 3 Position the focus point.**
Position the focus point over your subject as described on page 49.

4 Focus.

Press the shutter-release button halfway to focus.



The focus point will flash green and the shutter release will be disabled while the camera focuses. If the camera is able to focus, the focus point will be displayed in green; if the camera is unable to focus, the focus point will flash red (note that pictures can be taken even when the focus point flashes red; check focus in the monitor before shooting). Exposure can be locked by pressing the center of the sub-selector (☐ 141); focus locks while the shutter-release button is pressed halfway.

Using Autofocus in Live View

Use an AF-S or AF-P lens. The desired results may not be achieved with other lenses or teleconverters. Note that in live view, autofocus is slower and the monitor may brighten or darken while the camera focuses. The focus point may sometimes be displayed in green when the camera is unable to focus. The camera may be unable to focus in the following situations:

- The subject contains lines parallel to the long edge of the frame
- The subject lacks contrast
- The subject in the focus point contains areas of sharply contrasting brightness, or includes spot lighting or a neon sign or other light source that changes in brightness
- Flicker or banding appears under fluorescent, mercury-vapor, sodium-vapor, or similar lighting
- A cross (star) filter or other special filter is used
- The subject appears smaller than the focus point
- The subject is dominated by regular geometric patterns (e.g., blinds or a row of windows in a skyscraper)
- The subject is moving



5 Take the picture.

Press the shutter-release button the rest of the way down to shoot. The monitor will turn off.



6 Exit live view.

Press the **Lv** button to exit live view.

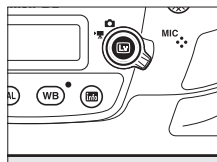



Exposure Preview

During live view, you can press **OK** to preview the effects of shutter speed, aperture, and ISO sensitivity on exposure. When **Off** is selected for **Silent live view photography** in the photo shooting menu, exposure can be adjusted by ± 5 EV (□ 143), although only values between -3 and $+3$ EV are reflected in the preview display. Note that the preview may not accurately reflect the final results when flash lighting is used, Active D-Lighting (□ 187), High Dynamic Range (HDR; □ 189), or bracketing is in effect, **A** (auto) is selected for the Picture Control **Contrast** parameter (□ 182), or **x 25.0** is selected for shutter speed. If the subject is very bright or very dark, the exposure indicators will flash to warn that the preview may not accurately reflect exposure. Exposure preview is not available when **b** or **-** is selected for shutter speed.



Live View Zoom Preview

Press the  button to magnify the view in the monitor up to a maximum of about 11x. A navigation window will appear in a gray frame at the bottom right corner of the display. Use the multi selector to scroll to areas of the frame not visible in the monitor, or press  (⚡) to zoom out.

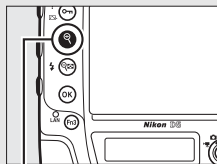

 button



Navigation window



Autofocus

To take pictures using autofocus, rotate the focus-mode selector to **AF**.

Focus-mode selector

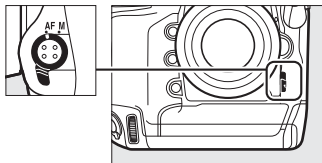

■ ■ Choosing a Focus Mode

The following autofocus modes are available in live view:

Mode	Description
AF-S	Single-servo AF: For stationary subjects. Focus locks when shutter-release button is pressed halfway.
AF-F	Full-time-servo AF: For moving subjects. Camera focuses continuously until shutter-release button is pressed. Focus locks when shutter-release button is pressed halfway.

To choose an autofocus mode, press the AF-mode button and rotate the main command dial until the desired mode is displayed in the monitor.

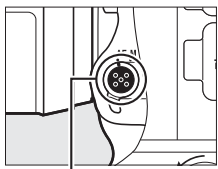

AF-mode button

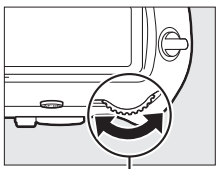





Main command dial



Monitor

■ ■ Choosing an AF-Area Mode

The following AF-area modes can be selected in live view:

Mode	Description
	Face-priority AF: Use for portraits. The camera automatically detects and focuses on portrait subjects; the selected subject is indicated by a double yellow border (if multiple faces, up to a maximum of 35, are detected, the camera will focus on the closest subject; to choose a different subject, use the multi selector). If the camera can no longer detect the subject (because, for example, the subject has turned to face away from the camera), the border will no longer be displayed.
	Wide-area AF: Use for hand-held shots of landscapes and other non-portrait subjects. Use the multi selector to move the focus point anywhere in the frame, or press the center of the multi selector to position the focus point in the center of the frame.
	Normal-area AF: Use for pin-point focus on a selected spot in the frame. Use the multi selector to move the focus point anywhere in the frame, or press the center of the multi selector to position the focus point in the center of the frame. A tripod is recommended.
	Subject-tracking AF: Position the focus point over your subject and press the center of the multi selector. The focus point will track the selected subject as it moves through the frame. To end tracking, press the center of the multi selector again. Note that the camera may be unable to track subjects if they move quickly, leave the frame or are obscured by other objects, change visibly in size, color, or brightness, or are too small, too large, too bright, too dark, or similar in color or brightness to the background.

Live View

During live view, you can position the focus point by tapping your subject in the monitor.

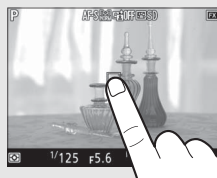

To choose an AF-area mode, press the AF-mode button and rotate the sub-command dial until the desired mode is displayed in the monitor.

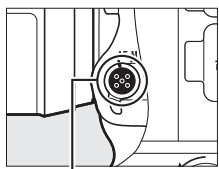

AF-mode button

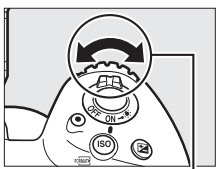

Sub-command dial





Monitor

Manual Focus

To focus in manual focus mode (📖 114), rotate the lens focus ring until the subject is in focus. To magnify the view in the monitor for precise focus, press the  button (📖 47).

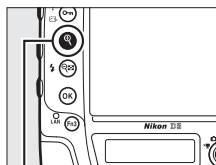
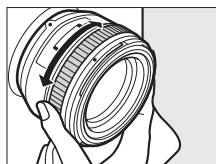
LV



 button

Previewing Focus During Live View

To temporarily select maximum aperture for an improved focus preview during live view, press the **Pv** button; the maximum aperture indicator (📖 56) will be displayed. To return aperture to its original value, press the button again or focus using autofocus. If the shutter-release button is pressed all the way down to take a picture during focus preview, aperture will return to the original value before the photo is taken.

Using the **i** Button

The options listed below can be accessed by pressing the **i** button during live view photography. Highlight items using the multi selector and press **⏏** to view options for the highlighted item. After choosing the desired setting, press **OK** to return to the **i**-button menu. Press the **i** button again to exit to the shooting display.

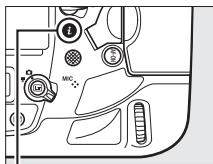



i button

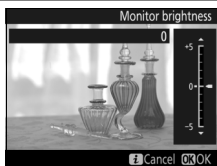

Option	Description
Choose image area	Choose an image area for live view photography (☞ 87).
Active D-Lighting	Adjust Active D-Lighting (☞ 187).
Electronic front-curtain shutter	Enable or disable the electronic front-curtain shutter for mirror-up photography (☞ 304).
Monitor brightness	Press ⏏ or ⏏ to adjust monitor brightness for live view (note that this affects live view only and has no effect on photographs or movies or on the brightness of the monitor for menus or playback; to adjust the brightness of the monitor for menus and playback, use the Monitor brightness option in the setup menu as described on page 310).

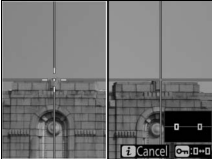

Option	Description
<p>Photo live view display WB</p>	<p>During live view photography, the white balance (hue) of the monitor can be set to a value different from that used for photographs (□ 159). This can be effective if the lighting under which shots are framed is different from that used when the photographs are taken, as is sometimes the case when a flash or preset manual white balance is used. Adjusting the photo live view display white balance to produce a similar effect to that used for the actual photographs makes it easier to picture the results. To use the same white balance for both the view in the monitor and the photograph, select None. Note that regardless of the option selected, same white balance is also used for both the view in the monitor and the photograph when Silent photography is on (□ 54). Monitor white balance is reset when the camera is turned off, but the last value used can be selected by pressing the  button while pressing and holding the WB button.</p> 
<p>Split-screen display zoom</p>	<p>View two separate areas of the frame side-by-side (□ 53). This option can be used, for example, to align buildings with the horizon.</p> 
<p>Silent photography</p>	<p>The shutter remains open during shooting, eliminating the sound made by the shutter (□ 54).</p>

■ ■ Split-Screen Display Zoom

Selecting **Split-screen display zoom** in the live view photography **i** button menu splits the display into two boxes showing separate areas of the frame side-by-side at a high zoom ratio. The positions of the magnified areas are shown in the navigation window.

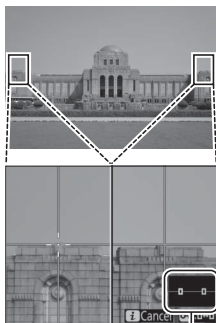

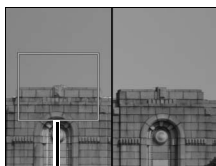

Navigation window

Use the **Q** and **Q** (**↔**) buttons to zoom in and out, or use the **OK** (**↔**/?) button to select a box and press **←** or **→** to scroll the selected area left or right. Pressing **↑** or **↓** scrolls both areas up or down simultaneously. To focus on the subject at the center of the selected area, press the shutter-release button halfway. To exit the split-screen display, press the **i** button.



Area in focus

Silent Mode

When **On** is selected for **Silent photography** in the **i**-button menu (☞ 52) or **On** is selected for **Silent live view photography** in the photo shooting menu (☞ 295),  is displayed in the monitor and the mirror remains up and the shutter stays open during live view photography. While the shutter-release button is pressed, the camera will take up to five seconds of JPEG photos at about 15 fps in continuous low-speed and quiet continuous release modes, or at about 30 fps in continuous high-speed release mode; the time remaining is shown in the exposure-count display. In other release modes, one photo will be taken each time the shutter-release button is pressed. ISO sensitivity is set automatically except in exposure mode **M**, when you can choose from values between ISO 100 and Hi 5 (☞ 124). In exposure mode **M**, shutter speed can be set to values between $1/30$ s and $1/8000$ s. Exposure can be previewed in the monitor (☞ 46); to view or hide an indicator (☞ 137) showing the difference between the value selected by the camera and the value you have selected, press .



Silent Mode

In silent mode, the flash will not fire, the self-timer, bracketing (☐ 146), Active D-Lighting (☐ 187), HDR (☐ 189), vignette control (☐ 294), distortion control (☐ 294), multiple exposure (☐ 229), high ISO noise reduction (☐ 294), and exposure-delay mode (☐ 304) turn off, and image quality is fixed at JPEG fine★ (if **RAW Slot 1 - JPEG Slot 2** is selected for **Role played by card in Slot 2**, JPEG images will be recorded to the cards in both slots). Image size is determined solely by the option selected for **Image area** (☐ 88) and is unaffected by the option selected for **Image size**:

- **FX (36 × 24) 1.0x**: 2784 × 1856
- **DX (24 × 16) 1.5x**: 1824 × 1216
- **1.2x (30 × 20) 1.2x**: 2320 × 1544
- **5:4 (30 × 24)**: 2320 × 1856

Exposure compensation can be adjusted by ±3 EV (☐ 143); the other exposure settings (aperture, shutter speed, and ISO sensitivity) that can be adjusted are shown in the following table:

	Aperture	Shutter speed	ISO sensitivity
P, S	—	—	—
A	✓	—	—
M	✓	✓	✓

Note that silent mode is not completely silent: the shutter sounds and the mirror is raised and lowered at the start and end of live view photography.

HDMI

If the camera is connected to an HDMI video device during live view photography, the camera monitor will remain on and the video device will display the view through the lens.

See Also

For information on choosing the roles played by the movie-record button and command dials and by the center of the multi selector, see Custom Settings f1 (**Custom control assignment**) > **Movie record button** + ☑ (☐ 307) and f2 (**Multi selector center button**, ☐ 308). See Custom Setting c4 (**Monitor off delay**, ☐ 303) for information on choosing how long the monitor remains on during live view. For information on preventing unintended operation of the  button, see Custom Setting f8 (**Live view button options**, ☐ 309).



The Live View Display

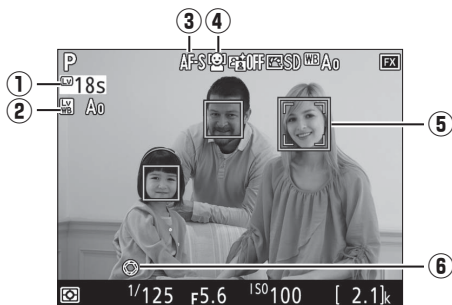

Item	Description	
① Time remaining	The amount of time remaining before live view ends automatically. Displayed if shooting will end in 30 s or less.	—
② Photo live view display white balance indicator	Monitor hue (photo live view display white balance).	52
③ Autofocus mode	The current autofocus mode.	48
④ AF-area mode	The current AF-area mode.	49
⑤ Focus point	The current focus point. The display varies with the option selected for AF-area mode.	49
⑥ Maximum aperture indicator	Displayed when the Pv button is pressed to select maximum aperture.	50

The Count Down Display

A count down will be displayed 30 s before live view ends automatically (the timer turns red if live view is about to end to protect the internal circuits or, if an option other than **No limit** is selected for Custom Setting c4—**Monitor off delay** > **Live view**; 303—5 s before the monitor is due to turn off automatically). Depending on shooting conditions, the timer may appear immediately when live view is selected.

The Information Display

To hide or display indicators in the monitor, press the **Info** button.

Virtual horizon

(**310**)

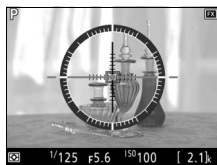

Information on



Information off

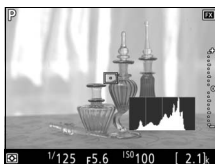

Histogram

(exposure preview
and silent
photography only;

46, 54)

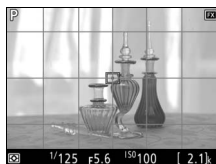

Framing guides





Shooting in Live View

To prevent light entering via the viewfinder from interfering with photographs or exposure, close the viewfinder eyepiece shutter (☞ 120).

Although they will not appear in the final picture unless **On** is selected for **Silent photography** (☞ 54), jagged edges, color fringing, moiré, and bright spots may appear in the monitor, while bright bands may appear in some areas with flashing signs and other intermittent light sources or if the subject is briefly illuminated by a strobe or other bright, momentary light source. In addition, distortion may occur if the camera is panned horizontally or an object moves at high speed through the frame. Flicker and banding visible in the monitor under fluorescent, mercury vapor, or sodium lamps can be reduced using the **Flicker reduction** option in the movie shooting menu (☞ 298), although they may still be visible in the final photograph at some shutter speeds. When shooting in live view, avoid pointing the camera at the sun or other strong light sources. Failure to observe this precaution could result in damage to the camera's internal circuitry.

Regardless of the option selected for Custom Setting c2 (**Standby timer**, ☞ 303), the standby timer will not expire during shooting.

Auto Tuning AF for the Current Lens

The camera offers an AF fine-tuning option for up to 20 lens types, with auto fine-tuning available in live view. Use only as required; AF tuning is not recommended in most situations and may interfere with normal focus. To use auto fine-tuning, first ready the camera by mounting it on a tripod and selecting maximum aperture (recommended), rotating the live view selector to , selecting single-servo autofocus (**AF-S**), setting the AF-area mode to wide- or normal-area AF, selecting the center focus point, and if possible engaging focus zoom for accurate focus. You can then focus the camera and then press the AF mode and movie-record buttons until instructions are displayed (you will need to press the buttons for a little over 2 seconds). Highlight **Yes** and press  to save the new value. Only one value can be saved for each lens type.

AF fine-tuning can be turned on and off using the **AF fine-tune > AF fine-tune (On/Off)** option in the setup menu (☞ 310). **AF fine-tune** lists the value for the current lens under **Saved value**; to view values for other lenses, select **List saved values**.

Movies

Read this section for information on recording and viewing movies.

Recording Movies

Movies can be recorded in live view.

- 1 Rotate the live view selector to  (movie live view).**

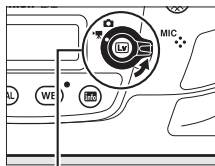

Live view selector

- 2 Press the  button.**

The mirror will be raised and the view through the lens will be displayed in the camera monitor, modified for the effects of exposure. The subject will no longer be visible in the viewfinder.

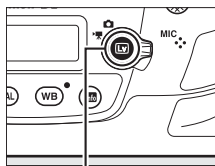

Lv button

The Icon

A  icon ([□ 65](#)) indicates that movies can not be recorded.

White Balance

White balance can be set at any time by pressing the **WB** button and rotating the main command dial ([□ 159](#)).



3 Choose a focus mode (📖 48).



4 Choose an AF-area mode (📖 49).



5 Focus.

Frame the opening shot and press the **AF-ON** button to focus. Note that the number of subjects that can be detected in face-priority AF drops during movie recording.

AF-ON button

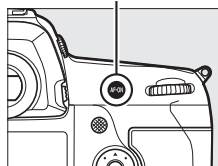

Focusing

Focus can also be adjusted by pressing the shutter-release button halfway before beginning recording, or you can focus manually as described on page 50.

6 Start recording.

Press the movie-record button to start recording. A recording indicator and the time available are displayed in the monitor. Exposure can be locked by pressing the center of the sub-selector (☐ 141) or altered by up to ± 3 EV using exposure compensation (☐ 143); spot metering is not available. In autofocus mode, the camera can be refocused by pressing the **AF-ON** button.

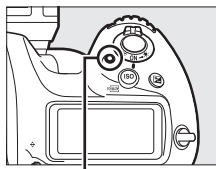

Movie-record button

Recording indicator



Time remaining

Audio

The camera can record both video and sound; do not cover the microphone on the front of the camera during movie recording. Note that the built-in microphone may record sounds made by the camera or lens during autofocus, vibration reduction, or changes to aperture.

7 End recording.

Press the movie-record button again to end recording. Recording will end automatically when the maximum length is reached, or the memory card is full.

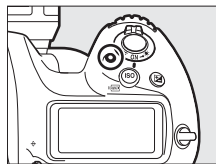

Maximum Length

The maximum length for individual movie files is 4 GB (for maximum recording times, see page 67); note that depending on memory card write speed, shooting may end before this length is reached.

8 Exit live view.

Press the  button to exit live view.

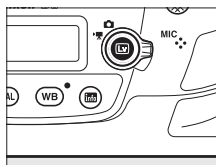

Exposure Mode

The following exposure settings can be adjusted in movie mode:

	Aperture	Shutter speed	ISO sensitivity
P, S	—	—	— 1, 2
A	✓	—	— 1, 2
M	✓	✓	✓ 2, 3

- 1 The upper limit for ISO sensitivity can be selected using the **Movie ISO sensitivity settings > Maximum sensitivity** option in the movie shooting menu (☐ 297).
- 2 The upper limit when **On** is selected for **Electronic VR** in the movie shooting menu is ISO 102400.
- 3 If **On** is selected for **Movie ISO sensitivity settings > Auto ISO control (mode M)** in the movie shooting menu, the upper limit for ISO sensitivity can be selected using the **Maximum sensitivity** option.

In exposure mode **M**, shutter speed can be set to values between $1/25$ s and $1/8000$ s (the slowest available shutter speed varies with the frame rate; ☐ 67). In other exposure modes, shutter speed is adjusted automatically. If the subject is over- or under-exposed in mode **P** or **S**, end live view and start live view again or select exposure **A** and adjust aperture.

See Also

The role played by the center of the multi selector can be chosen using Custom Setting f2 (**Multi selector center button**; ☐ 308) and the roles of the **Fn1**, **Fn2**, **Fn3** and **Pv** buttons and the center of the sub-selector using Custom Setting g1 (**Custom control assignment**; ☐ 309). Custom Setting g1 (**Custom control assignment**) > **Shutter-release button** controls whether the shutter-release button can be used to start live view, or to start and end movie recording, or (when pressed all the way down) to take photographs during movie recording. For information on preventing unintended operation of the  button, see Custom Setting f8 (**Live view button options**; ☐ 309).

Indices

If **Index marking** is assigned to a control using Custom Setting g1 (**Custom control assignment**, 309), you can press the selected control during recording to add indices that can be used to locate frames during editing and playback (81). Up to 20 indices can be added to each movie.



Index

Using the *i* Button



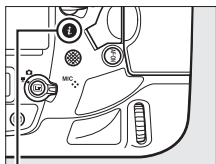



The options listed below can be accessed by pressing the *i* button in movie mode. Highlight items using the multi selector and press \blacktriangleright to view options for the highlighted item. After choosing the desired setting, press \odot to return to the *i*-button menu. Press the *i* button again to exit to the shooting display.



i button



Option	Description
Choose image area	Choose image area for movies (80).
Frame size/ frame rate	Select a frame size and rate (67).
Movie quality	Choose movie quality (67).
Microphone sensitivity	Press \odot or \ominus to adjust microphone sensitivity (298).

Option	Description
Frequency response	Control microphone frequency response (☞ 298).
Wind noise reduction	Enable or disable wind noise reduction using the built-in microphone's low-cut filter (☞ 298).
Destination	When two memory cards are inserted, you can choose the card to which movies are recorded (☞ 296).
Monitor brightness	Press  or  to adjust monitor brightness (note that this affects live view only and has no effect on photographs or movies or on the brightness of the monitor for menus or playback; ☞ 51).
 Highlight display	Choose whether the brightest areas of the frame (highlights) are shown by slanting lines in the display. <div style="text-align: right;">  </div>
Headphone volume	Press  or  to adjust headphone volume.
Electronic VR	Select On to enable electronic vibration reduction during movie recording, but note that this reduces the angle of view, resulting in the edges of the frame being cropped out. Not available at a frame size of 3840 × 2160 or 1920 × 1080 crop (☞ 67).

Using an External Microphone

The optional ME-1 stereo microphone or ME-W1 wireless microphone can be used to record sound for movies (☞ 341).

Headphones

Third-party headphones can be used. Note that high sound levels may result in high volume; particular care should be taken when headphones are used.

The Live View Display





Item	Description	
① Headphone volume	Volume of audio output to headphones. Displayed when third-party headphones are connected.	64
② Microphone sensitivity	Microphone sensitivity.	63
③ Sound level	Sound level for audio recording. Displayed in red if level is too high; adjust microphone sensitivity accordingly.	—
④ Frequency response	The current frequency response.	64
⑤ Wind noise reduction	Displayed when wind noise reduction is on.	64
⑥ “No movie” indicator	Indicates that movies can not be recorded.	—
⑦ Movie frame size	The frame size for movie recording.	67
⑧ Time remaining	The recording time available for movies.	61
⑨ Highlight display indicator	Displayed when highlight display is on.	64
⑩ Electronic VR indicator	Displayed when electronic vibration reduction is on.	64



The Count-Down Display

A count down will be displayed 30 s before live view ends automatically (☐ 56). Depending on shooting conditions, the timer may appear immediately when movie recording begins. Note that regardless of the amount of recording time available, live view will still end automatically when the timer expires. Wait for the internal circuits to cool before resuming movie recording.















Adjusting Settings During Movie Recording



Headphone volume can not be adjusted during recording. If an option other than  (microphone off) is currently selected, microphone sensitivity can be changed to any setting other than  while recording is in progress.



Maximum Length

The maximum length varies with the options selected for **Movie quality** and **Frame size/frame rate** in the movie shooting menu (☞ 296).

	Option ¹	Maximum bit rate (Mbps) (★ high quality/Normal)	Maximum length
	3840 × 2160 (4K UHD); 30p ²	144 ³	29 min. 59 s ⁴
	3840 × 2160 (4K UHD); 25p ²		
	3840 × 2160 (4K UHD); 24p ²		
	1920 × 1080; 60p	48/24	
	1920 × 1080; 50p		
	1920 × 1080; 30p	24/12	
	1920 × 1080; 25p		
	1920 × 1080; 24p		
	1280 × 720; 60p		
	1280 × 720; 50p		
	1920 × 1080; 60p crop ⁵		
	1920 × 1080; 50p crop ⁵		
	1920 × 1080; 30p crop ⁵		
	1920 × 1080; 25p crop ⁵		
	1920 × 1080; 24p crop ⁵		

- 1 Actual frame rate is 29.97 fps for values listed as 30p, 23.976 fps for values listed as 24p, and 59.94 fps for values listed as 60p.
- 2 When this option is selected,  is displayed in the monitor and movie quality is fixed at “high”.
- 3 Available in high quality only.
- 4 Each movie will be recorded across up to 8 files of up to 4 GB each. The number of files and the length of each file vary with the options selected for **Frame size/frame rate** and **Movie quality**.
- 5  is displayed in the monitor when this option is selected.



The Information Display

To hide or display indicators in the monitor, press the **info** button.

Virtual horizon

(310)



Information on



Information off



Histogram



Framing guides

HDMI

If the camera is connected to an HDMI device (286), the view through the lens will appear both in the camera monitor and on the HDMI device.

The Movie Crop

Movies have an aspect ratio of 16 : 9 and are recorded using a crop that varies with the frame size.

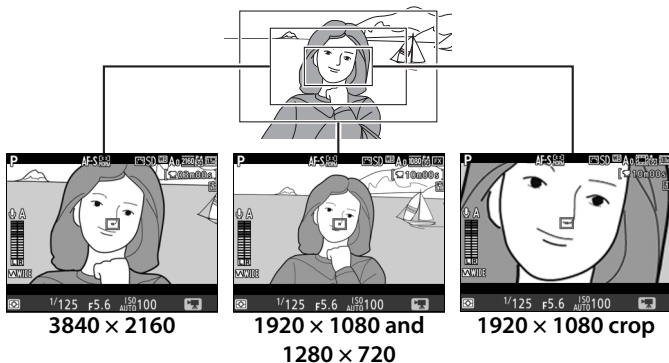

Going from a frame size of 1920 × 1080 or 1280 × 720 to 3840 × 2160 increases the apparent focal length by approximately 1.5x, while going from 1920 × 1080 or 1280 × 720 to 1920 × 1080 crop increases the apparent focal length by approximately 3x.



Image Area

At frame sizes of 1920 × 1080 and 1280 × 720, you can choose an image area using the **Image area > Choose image area** option in the movie shooting menu. Select **FX** to shoot movies in what is referred to as “FX-based movie format”, **DX** to shoot in “DX-based movie format”. The differences between the two are illustrated below.



The sizes of the areas recorded are approximately 35.9 × 20.2 mm (FX-based movie format) and 23.5 × 13.2 mm (DX-based movie format).

 Movies shot with a DX-format lens and **On** is selected for **Image area > Auto DX crop** (88) in the movie shooting menu are recorded in DX-based movie format. Enabling electronic vibration reduction (64) reduces the size of the crop, slightly increasing the apparent focal length.

At frame sizes of 3840 × 2160 and 1920 × 1080 crop, image-area selection is not available and image area remains the same regardless of the type of lens used.

Taking Photos in Movie Mode

To take photos in movie mode (either in live view or during movie recording), select **Take photos** for Custom Setting g1 (**Custom control assignment**) > **Shutter-release**



button (☞ 309). Photos with an aspect ratio of 16 : 9 can then be taken at any time by pressing the shutter-release button all the way down. If movie recording is in progress, recording will end and the footage recorded to that point will be saved.



Except at a frame size of 1920 × 1080 crop or 3840 × 2160 (☞ 67), photographs are recorded in the format selected for **Image quality** in the photo shooting menu (☞ 92); photos taken at a frame size of 1920 × 1080 crop or 3840 × 2160 are recorded at an image quality of JPEG fine★. For information on image size, see page 72. Note that the exposure for photographs can not be previewed when the live view selector is rotated to ; mode **P**, **S**, or **A** is recommended but accurate results can be achieved in mode **M** by previewing exposure with the live view selector rotated to .



Image Size

The size of photos taken in movie mode varies with the movie frame size (☞ 67) and, in the case of photos taken at frame sizes of 1920 × 1080 and 1280 × 720, with the image area and the option selected for **Image size > JPEG/TIFF** in the photo shooting menu (☞ 95).

Frame size	Image area	Image size	Size (pixels)	Print size (cm/in.)*
3840 × 2160	—		3840 × 2160	32.5 × 18.3/12.8 × 7.2
1920 × 1080 1280 × 720	FX	Large	5568 × 3128	47.1 × 26.5/18.6 × 10.4
		Medium	4176 × 2344	35.4 × 19.8/13.9 × 7.8
		Small	2784 × 1560	23.6 × 13.2/ 9.3 × 5.2
	DX	Large	3648 × 2048	30.9 × 17.3/12.2 × 6.8
		Medium	2736 × 1536	23.2 × 13.0/ 9.1 × 5.1
Small		1824 × 1024	15.4 × 8.7/ 6.1 × 3.4	
1920 × 1080 crop	—		1920 × 1080	16.3 × 9.1/ 6.4 × 3.6

* Approximate size when printed at 300 dpi. Print size in inches equals image size in pixels divided by printer resolution in dots per inch (dpi); 1 inch = approximately 2.54 cm).

Metering Exposure and White Balance

The area used for metering exposure or auto white balance when photographs are recorded at a movie frame size of 1920 × 1080 crop (☐ 67) is not the same as the area in the final photograph, with the result that optimal results may not be achieved. Take test shots and check the results in the monitor.

Wireless Remote Controllers and Remote Cords

If **Record movies** is selected for Custom Setting g1 (**Custom control assignment**) > **Shutter-release button** (☐ 309), the shutter-release buttons on optional wireless remote controllers and remote cords (☐ 337, 339) can be used to start live view and to start and end movie recording.

Recording Movies

Movies are recorded in the sRGB color space. Flicker, banding, or distortion may be visible in the monitor and in the final movie under fluorescent, mercury vapor, or sodium lamps or if the camera is panned horizontally or an object moves at high speed through frame (for information on reducing flicker and banding, see **Flicker reduction**, ☐ 298). Flicker may also appear while power aperture is in use. Jagged edges, color fringing, moiré, and bright spots may also appear. Bright bands may appear in some areas of the frame with flashing signs and other intermittent light sources or if the subject is briefly illuminated by a strobe or other bright, momentary light source. When recording movies, avoid pointing the camera at the sun or other strong light sources. Failure to observe this precaution could result in damage to the camera's internal circuitry. Note that noise (randomly-spaced bright pixels, fog, or lines) and unexpected colors may appear if you zoom in on the view through the lens (☐ 47) in movie mode.

Flash lighting can not be used.

Recording ends automatically if the lens is removed or the live view selector is rotated to a new setting.



Time-Lapse Movies

The camera automatically takes photos at selected intervals to create a silent time-lapse movie using the options currently selected for **Choose image area** (☞ 70), **Frame size/frame rate**, **Movie quality**, and **Destination** in the movie shooting menu (☞ 296). The photos are taken using viewfinder photography.

Before Shooting

Before shooting a time-lapse movie, take a test shot at current settings and view the results in the monitor. For consistent coloration, choose a white balance setting other than auto (☞ 159).

Use of a tripod is recommended. Mount the camera on a tripod before shooting begins. To ensure that shooting is not interrupted, use an optional AC adapter and power connector or a fully-charged battery. To prevent light entering via the viewfinder interfering with photographs and exposure, close the viewfinder eyepiece shutter (☞ 120).

1 Select Time-lapse movie.

Highlight **Time-lapse movie** in the movie shooting menu and press  to display time-lapse movie settings.

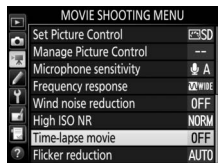

2 Adjust time-lapse movie settings.

Choose an interval, total shooting time, and exposure smoothing option.

- To choose the interval between frames:

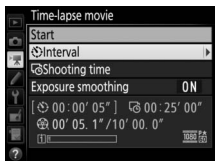

Highlight **Interval** and press .





Choose an interval longer than the slowest anticipated shutter speed (minutes and seconds) and press .

- To choose the total shooting time:

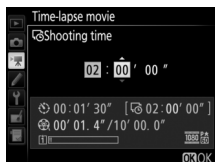

Highlight **Shooting time** and press .



Choose shooting time (up to 7 hours 59 minutes) and press .



- To enable or disable exposure smoothing:

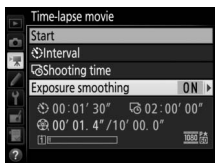

Highlight **Exposure smoothing** and press \odot .

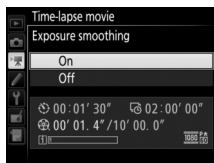

Highlight an option and press \odot .

Selecting **On** smooths abrupt changes in exposure in modes other than **M** (note that exposure smoothing only takes effect in mode **M** if auto ISO sensitivity control is enabled in the photo shooting menu).

3 Start shooting.

Highlight **Start** and press \odot . Shooting starts after about 3 s. The camera takes photographs at the selected interval for the selected shooting time. When complete, time-lapse movies are recorded to the memory card selected for **Destination** in movie shooting menu (📖 296).

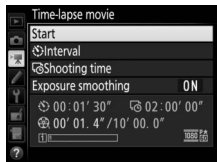

■ ■ *Ending Shooting*

To end shooting before all the photos are taken, highlight **Off** in the time-lapse movie menu and press **OK**, or press **OK** between frames or immediately after a frame is recorded. A movie will be created from the frames shot to the point where shooting ended. Note that shooting will end and no movie will be recorded if the power source is removed or disconnected or the destination memory card is ejected.

■ ■ *No Photograph*

The camera will skip the current frame if the camera is unable to focus in **AF-S** (note that the camera focuses again before each shot). Shooting will resume with the next frame.



✓ **Time-Lapse Movies**

Time-lapse is not available during live view (□ 44) or movie recording (□ 59), at a shutter speed of **bulb** or **- -** (□ 138) or when bracketing (□ 146), High Dynamic Range (HDR, □ 189), multiple exposure (□ 229), or interval timer photography (□ 236) is active. Note that because shutter speed and the time needed to record the image to the memory card may vary from shot to shot, the interval between a shot being recorded and the start of the next shot may vary. Shooting will not begin if a time-lapse movie can not be recorded at current settings (for example, if the memory card is full, the interval or shooting time is zero, or the interval is longer than the shooting time).

Shooting may end if camera controls are used or settings are changed or HDMI cable is connected. A movie will be created from the frames shot to the point where shooting ended. To end shooting and record a photograph, press the shutter-release button all the way down.

✓ Frame Size

The area used for metering exposure, flash level, or auto white balance when photographs are recorded at a movie frame size of 1920 × 1080 crop (☞ 67) is not the same as the area in the final photograph, with the result that optimal results may not be achieved. Take test shots and check the results in the monitor.

✍ Calculating the Length of the Final Movie

The total number of frames in the final movie can be calculated by dividing the shooting time by the interval and rounding up. The length of the final movie can then be calculated by dividing the number of shots by the frame rate selected for **Frame size/frame rate** in movie shooting menu (☞ 67). A 48 frame movie recorded at **1920 × 1080; 24p**, for example, will be about two seconds long. The maximum length for time-lapse movies is 20 minutes.

Length recorded/
maximum length





Memory card
indicator

Frame size/frame rate

During Shooting

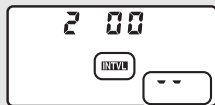
During shooting, **INTVL** will flash and the time-lapse recording indicator will be displayed in the top control panel. The time remaining (in hours and minutes) appears in the shutter-speed display immediately before each frame is recorded. At other times, the time remaining can be viewed by pressing the shutter-release button halfway. Regardless of the option selected for Custom Setting c2 (**Standby timer**,  303), the standby timer will not expire during shooting.



To view current time-lapse movie settings or end shooting ( 77), press the **MENU** button between shots. While shooting is in progress, the time-lapse movie menu will show exposure smoothing, the interval, and the time remaining. These settings can not be changed while shooting is in progress, nor can pictures be played back or other menu settings adjusted.

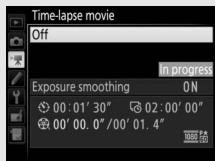





Image Review

The  button can not be used to view pictures while shooting is in progress, but the current frame will be displayed for a few seconds after each shot if **On** is selected for **Image review** in the playback menu ( 290). Other playback operations can not be performed while the frame is displayed.

Release Mode



Regardless of the release mode selected, the camera will take one shot at each interval. The self-timer can not be used.

See Also

The **Beep** option in the setup menu controls whether a beep sounds when shooting is complete ( 312).







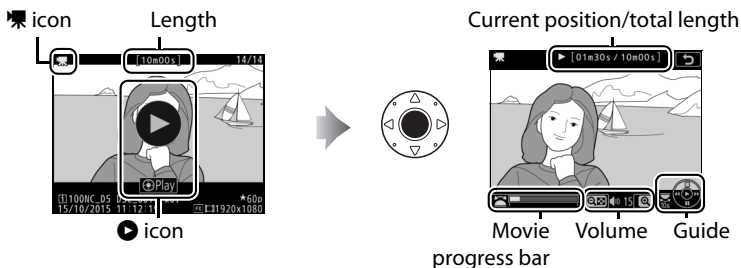







Viewing Movies

Movies are indicated by a  icon in full-frame playback ( 248). Tap the  icon in the monitor or press the center of the multi selector to start playback; your current position is indicated by the movie progress bar.





The following operations can be performed:

To	Use	Description
Pause		Pause playback.
Play		Resume playback when movie is paused or during rewind/advance.
Rewind/advance		Speed increases with each press, from 2x to 4x to 8x to 16x; keep pressed to skip to beginning or end of movie (first frame is indicated by  in top right corner of monitor, last frame by ). If playback is paused, movie rewinds or advances one frame at a time; hold for continuous rewind or advance.
Skip 10 s		Rotate the main command dial to skip ahead or back 10 s.

To	Use	Description
Skip ahead/ back		Rotate the sub-command dial to skip to next or previous index, or to skip to the last or first frame if the movie contains no indices.
Adjust volume		Press  to increase volume,  to decrease.
Trim movie		See page 82 for more information.
Exit		Exit to full-frame playback.
Return to shooting mode		Press the shutter-release button halfway to exit to shooting mode.





The Icon

Movies with indices () 63) are indicated by a  icon in full-frame playback.





The Icon

 is displayed in full-frame and movie playback if the movie was recorded without sound () 298).



Editing Movies

Trim footage to create edited copies of movies or save selected frames as JPEG stills.

Option	Description
 Choose start/end point	Create a copy from which unwanted footage has been removed.
 Save selected frame	Save a selected frame as a JPEG still.



Trimming Movies



To create trimmed copies of movies:

1 Display a movie full frame (📖 248).

2 Pause the movie on the new opening frame.

Play the movie back as described on page 80, pressing the center of the multi-selector to start and resume playback and  to pause and pressing  or  or rotating the main or sub-command dial to locate the desired frame. Your

approximate position in the movie can be ascertained from the movie progress bar. Pause playback when you reach the new opening frame.



Movie progress bar

3 Select Choose start/end point.

Press **i** or **OK**, then highlight **Choose start/end point** and press **OK**.



4 Select Start point.

To create a copy that begins from the current frame, highlight **Start point** and press **OK**. The frames before the current frame will be removed when you save the copy in Step 9.

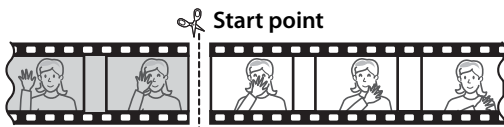
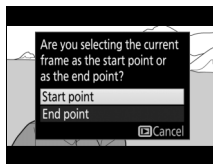

5 Confirm the new start point.

If the desired frame is not currently displayed, press **Left Arrow** or **Right Arrow** to advance or rewind (to skip to 10 s ahead or back, rotate the main command dial; to skip to an index, or to the first or last frame if the movie contains no indices, rotate the sub-command dial).



6 Choose the end point.

Press **OK** (↵/?) to switch from the start point (⏮) to the end point (⏭) selection tool and then select the closing frame as described in Step 5. The frames after the selected frame will be removed when you save the copy in Step 9.

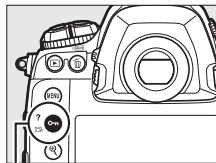

OK (↵/?) button

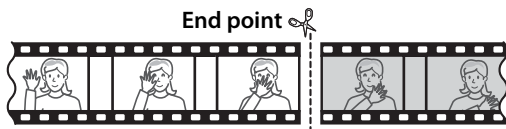

7 Create the copy.

Once the desired frame is displayed, press **OK**.

8 Preview the movie.

To preview the copy, highlight **Preview** and press **OK** (to interrupt the preview and return to the save options menu, press **ESC**). To abandon the current copy and select a new start point or end point as described on the foregoing pages, highlight **Cancel** and press **OK**; to save the copy, proceed to Step 9.



9 Save the copy.

Highlight **Save as new file** and press **OK** to save the copy to a new file. To replace the original movie file with the edited copy, highlight **Overwrite existing file** and press **OK**.

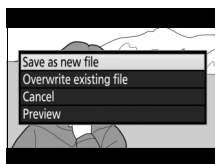

✓ **Trimming Movies**

Movies must be at least two seconds long. The copy will not be saved if there is insufficient space available on the memory card.

Copies have the same time and date of creation as the original.

✎ **Removing Opening or Closing Footage**

To remove only the opening footage from the movie, proceed to Step 7 without pressing the **OK** (↵/?) button in Step 6. To remove only the closing footage, select **End point** in Step 4, select the closing frame, and proceed to Step 7 without pressing the **OK** (↵/?) button in Step 6.

Saving Selected Frames

To save a copy of a selected frame as a JPEG still:

1 **Pause the movie on the desired frame.**

Play the movie back as described on page 80, pressing the center of the multi-selector to start and resume playback and **STOP** (⏏) to pause. Pause the movie at the frame you intend to copy.



2 **Choose Save selected frame.**

Press **i** or **ⓘ**, then highlight **Save selected frame** and press **OK** (↵).

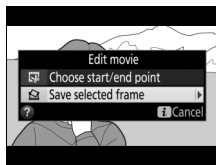

3 Create a still copy.

Press  to create a still copy of the current frame.



4 Save the copy.

Highlight **Yes** and press  to create a fine★-quality (📄 92) JPEG copy of the selected frame.

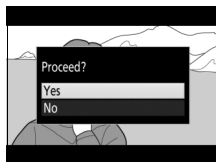

Save Selected Frame

JPEG movie stills created with the **Save selected frame** option can not be retouched. JPEG movie stills lack some categories of photo information (📄 254).

The Retouch Menu

Movies can also be edited using the **Edit movie** option in the retouch menu (📄 315).

Image Recording Options

Image Area

Choose from image areas of **FX (36 × 24) 1.0×** (FX format), **DX (24 × 16) 1.5×** (DX format), **5 : 4 (30 × 24)**, and **1.2×** (30 × 20) **1.2×**. See page 385 for information on the number of pictures that can be stored at different image area settings.

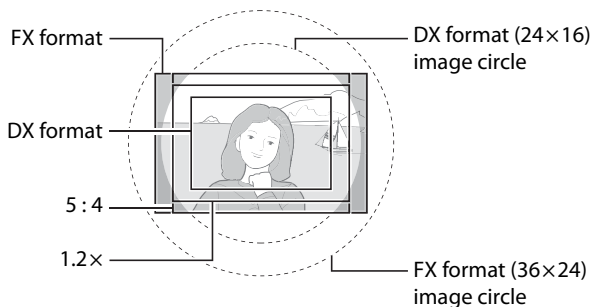





Image Area Options

The camera offers a choice of the following image areas:

Option	Description
 FX (36×24) 1.0×	Images are recorded in FX format with an angle of view equivalent to a NIKKOR lens on a 35 mm format camera.
 1.2× (30×20) 1.2×	Selecting this option reduces the angle of view and increases the apparent focal length of the lens by approximately 1.2×.
 DX (24×16) 1.5×	Images are recorded in DX format. To calculate the approximate focal length of the lens in 35 mm format, multiply by 1.5.
 5 : 4 (30×24)	Pictures are recorded with an aspect ratio of 5 : 4.

Automatic Crop Selection

To automatically select to a DX crop when a DX lens is attached, select **On** for **Image area > Auto DX crop** in the photo shooting menu (☰ 292). The image area selected in the photo shooting menu or with the camera controls will be used only when a non-DX lens is attached. Select **Off** to use the currently-selected image area with all lenses.

Auto DX Crop

The controls listed on page 91 can not be used to select image area when a DX lens is attached and **Auto DX crop** is on.

Image Area

The selected option is shown in the information display.



DX Lenses

DX lenses are designed for use with DX format cameras and have a smaller angle of view than lenses for 35 mm format cameras. If **Auto DX crop** is off and an option other than **DX (24 × 16)** (DX format) is selected for **Image area** when a DX lens is attached, the edges of the image may be eclipsed. This may not be apparent in the viewfinder, but when the images are played back you may notice a drop in resolution or that the edges of the picture are blacked out.

The Viewfinder Display

The 1.2 ×, DX format, and 5 : 4 crops are shown below.



1.2 ×

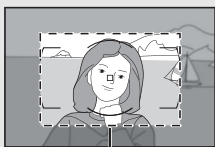

DX format



5 : 4

See Also

See page 69 for information on the crops available for movie recording.



The image area can be selected using the **Image area > Choose image area** option in the photo shooting menu or by pressing a control and rotating a command dial.

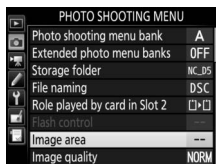

■ The Image Area Menu

- 1 Select Image area.**
Highlight **Image area** in the photo shooting menu and press .



- 2 Select Choose image area.**
Highlight **Choose image area** and press .



- 3 Adjust settings.**
Choose an option and press . The selected crop is displayed in the viewfinder ( 89).

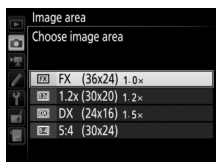



Image Size

Image size varies with the option selected for image area.

■ Camera Controls

1 Assign image area selection to a camera control.

Use Custom Setting f1 (**Custom control assignment**,  307) to assign **Choose image area** to a control.

2 Use the selected control to choose an image area.

The image area can be selected by pressing the selected control and rotating the main or sub-command dial until the desired crop is displayed in the viewfinder ( 89).

The option currently selected for image area can be viewed by pressing the control to display the image area in the top control panel or information display. FX format is displayed as “**36-24**”, 1.2 × as “**30-20**”, DX format as “**24-16**”, and 5 : 4 as “**30-24**”.

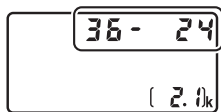
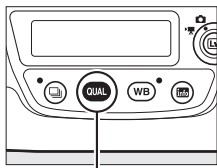

Image Quality

The D5 supports the following image quality options. See page 385 for information on the number of pictures that can be stored at different image quality and size settings.

Option	File type	Description
NEF (RAW)	NEF	RAW data from the image sensor are saved without additional processing. Settings such as white balance and contrast can be adjusted after shooting.
NEF (RAW)+ JPEG fine★/ NEF (RAW)+ JPEG fine	NEF/ JPEG	Two images are recorded, one NEF (RAW) image and one fine-quality JPEG image.
NEF (RAW)+ JPEG normal★/ NEF (RAW)+ JPEG normal		Two images are recorded, one NEF (RAW) image and one normal-quality JPEG image.
NEF (RAW)+ JPEG basic★/ NEF (RAW)+ JPEG basic		Two images are recorded, one NEF (RAW) image and one basic-quality JPEG image.
JPEG fine★/ JPEG fine	JPEG	Record JPEG images at a compression ratio of roughly 1:4 (fine quality).
JPEG normal★/ JPEG normal		Record JPEG images at a compression ratio of roughly 1:8 (normal quality).
JPEG basic★/ JPEG basic		Record JPEG images at a compression ratio of roughly 1:16 (basic quality).
TIFF (RGB)	TIFF (RGB)	Record uncompressed TIFF-RGB images at a bit depth of 8 bits per channel (24-bit color). TIFF is supported by a wide variety of imaging applications.

Image quality is set by pressing the **QUAL** button and rotating the main command dial until the desired setting is displayed in the rear control panel.



QUAL button

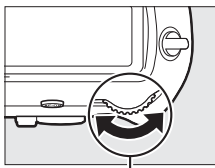

Main command dial



Rear control panel

Number of Exposures Remaining

Pressing the **QUAL** button displays the number of exposures remaining in the rear control panel. The number of exposures remaining changes with the option selected for image quality.



Rear control panel

JPEG Compression

Image quality options with a star ("★") use compression intended to ensure maximum quality; the size of the files varies with the scene. Options without a star use a type of compression designed to produce smaller files; files tend to be roughly the same size regardless of the scene recorded.

NEF+JPEG



When photographs taken at settings of NEF (RAW) + JPEG are viewed on the camera with only one memory card inserted, only the JPEG image will be displayed. If both copies are recorded to the same memory card, both copies will be erased when the photo is deleted. If the JPEG copy is recorded to a separate memory card using the **Role played by card in Slot 2 > RAW Slot 1 - JPEG Slot 2** option, each copy must be deleted separately.

The Image Quality Menu

Image quality can also be adjusted using the **Image quality** option in the photo shooting menu (📖 292).

■■ NEF (RAW) Compression

To choose the type of compression for NEF (RAW) images, highlight **NEF (RAW) recording** > **NEF (RAW) compression** in the photo shooting menu and press .

Option	Description
ON  Lossless compressed	NEF images are compressed using a reversible algorithm, reducing file size by about 20–40% with no effect on image quality.
ON  Compressed	NEF images are compressed using a non-reversible algorithm, reducing file size by about 35–55% with almost no effect on image quality.
Uncompressed	NEF images are not compressed.

■■ NEF (RAW) Bit Depth

To choose a bit depth for NEF (RAW) images, highlight **NEF (RAW) recording** > **NEF (RAW) bit depth** in the photo shooting menu and press .

Option	Description
12-bit 12-bit	NEF (RAW) images are recorded at a bit-depth of 12 bits.
14-bit 14-bit	NEF (RAW) images are recorded at a bit depth of 14 bits, producing files larger than those with a bit depth of 12 bits but increasing the color data recorded.

NEF (RAW) Images

JPEG copies of NEF (RAW) images can be created using Capture NX-D or other software or the **NEF (RAW) processing** option in the retouch menu (□ 314).

Image Size





Image size is measured in pixels. Choose from  **Large**,  **Medium**, or  **Small** (note that image size varies depending on the option selected for **Image area**,  87):

Image area	Option	Size (pixels)	Print size (cm/in.)*
FX (36×24) 1.0× (FX format)	Large	5568 × 3712	47.1 × 31.4/18.6 × 12.4
	Medium	4176 × 2784	35.4 × 23.6/13.9 × 9.3
	Small	2784 × 1856	23.6 × 15.7/ 9.3 × 6.2
1.2× (30×20) 1.2×	Large	4640 × 3088	39.3 × 26.2/15.5 × 10.3
	Medium	3472 × 2312	29.4 × 19.6/11.6 × 7.7
	Small	2320 × 1544	19.6 × 13.1/ 7.7 × 5.1
DX (24×16) 1.5× (DX format)	Large	3648 × 2432	30.9 × 20.6/12.2 × 8.1
	Medium	2736 × 1824	23.2 × 15.4/ 9.1 × 6.1
	Small	1824 × 1216	15.4 × 10.3/ 6.1 × 4.1
5 : 4 (30×24)	Large	4640 × 3712	39.3 × 31.4/15.5 × 12.4
	Medium	3472 × 2784	29.4 × 23.6/11.6 × 9.3
	Small	2320 × 1856	19.6 × 15.7/ 7.7 × 6.2

* Approximate size when printed at 300 dpi. Print size in inches equals image size in pixels divided by printer resolution in dots per inch (dpi; 1 inch = approximately 2.54 cm).



Image size for JPEG and TIFF images can be set by pressing the **QUAL** button and rotating the sub-command dial until the desired option is displayed in the rear control panel. To choose the size of NEF (RAW) images, use the **Image size > NEF (RAW)** option in the photo shooting menu.

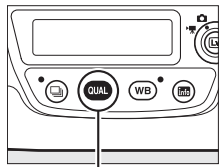

QUAL button

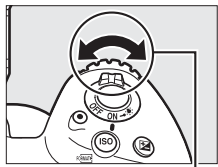

Sub-command dial



Rear control panel



Number of Exposures Remaining

Pressing the **QUAL** button displays the number of exposures remaining in the rear control panel. The number of exposures remaining changes with the option selected for image size.



Rear control panel

The Image Size Menu

Image size for JPEG and TIFF images can also be adjusted using the **Image size > JPEG/TIFF** option in the photo shooting menu (292). Small and medium sized NEF (RAW) images are recorded in lossless compressed 12-bit format, regardless of the options selected for **NEF (RAW) compression** and **NEF (RAW) bit depth** in the **NEF (RAW) recording** menu.

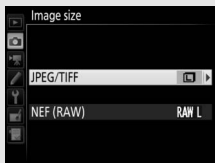

Using Two Memory Cards

When two memory cards are inserted in the camera, you can use the **Role played by card in Slot 2** item in the photo shooting menu to choose the role played by the card in Slot 2. Choose from **Overflow** (the card in Slot 2 is used only when the card in Slot 1 is full), **Backup** (each picture is recorded twice, once to the card in Slot 1 and again to the card in Slot 2), and **RAW Slot 1 - JPEG Slot 2** (as for **Backup**, except that the NEF/RAW copies of photos recorded at settings of NEF/RAW + JPEG are recorded only to the card in Slot 1 and the JPEG copies only to the card in Slot 2).



"Backup" and "RAW Slot 1 - JPEG Slot 2"

When **Backup** or **RAW Slot 1 - JPEG Slot 2** is selected, the camera shows the number of exposures remaining on the card with the least amount of memory, and voice memos (🗨 272) are recorded to the card in Slot 1. Shutter release will be disabled when either card is full.

Recording Movies

When two memory cards are inserted in the camera, the slot used to record movies can be selected using the **Destination** option in the movie shooting menu (🗨 296).

Focus

This section describes the focus options available when photographs are framed in the viewfinder. Focus can be adjusted automatically (see below) or manually (📖 114). The user can also select the focus point for automatic or manual focus (📖 108) or use focus lock to focus and recompose photographs after focusing (📖 111).

Autofocus

To use autofocus, rotate the focus-mode selector to **AF**.

Focus-mode selector

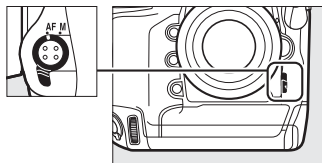

The camera focuses using 153 focus points, of which the 55 shown by □ in the illustration at right can be selected by the user (📖 108).

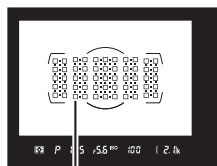

User-selectable focus points

Cross Sensors

The availability of cross-sensor focus points varies with the lens used.

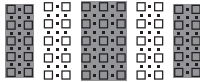
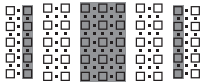
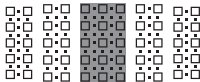
Lens	Cross sensors (cross-sensor focus points highlighted in gray ²⁾)
AF-S and AF-P lenses other than those listed below with maximum apertures of f/4 or faster ¹	 <p>99 cross sensors</p>
<ul style="list-style-type: none">• AF-S DX Zoom-Nikkor 12–24mm f/4G IF-ED• AF-S Micro NIKKOR 60mm f/2.8G ED• AF-S NIKKOR 600mm f/4G ED VR• AF-S NIKKOR 600mm f/4E FL ED VR• AF-S Nikkor 600mm f/4D IF-ED II• AF-S Nikkor 600mm f/4D IF-ED	 <p>63 cross sensors</p>
<ul style="list-style-type: none">• AF-S NIKKOR 200–400mm f/4G ED VR II• AF-S VR Zoom-Nikkor 200–400mm f/4G IF-ED• AF-S NIKKOR 500mm f/4G ED VR• AF-S Nikkor 500mm f/4D IF-ED II• AF-S Nikkor 500mm f/4D IF-ED• AF-S and AF-P lenses with maximum apertures slower than f/4¹• Non-AF-S, non-AF-P lenses	 <p>45 cross sensors</p>

1 At maximum zoom, in the case of zoom lenses.

2 Other focus points use line sensors, which detect horizontal lines.



AF-S/AF-I Teleconverters and Available Focus Points

When an AF-S or AF-I teleconverter is attached, the focus points shown in the illustrations can be used for autofocus and electronic rangefinding (note that at maximum combined apertures slower than f/5.6, the camera may not be able to focus on dark or low-contrast subjects).

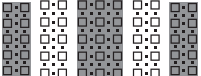
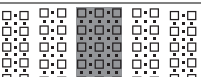
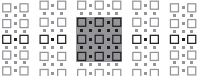
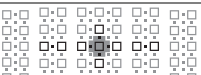
Teleconverter	Max. lens aperture ¹	Available focus points (cross-sensor focus points highlighted in gray ²)
TC-14E, TC-14E II, TC-14E III TC-17E II TC-20E, TC-20E II, TC-20E III	f/2	
TC-14E, TC-14E II, TC-14E III	f/2.8	153 focus points (55 selectable) with 99 cross sensors
TC-17E II TC-20E, TC-20E II, TC-20E III	f/2.8	
TC-14E, TC-14E II, TC-14E III	f/4	153 focus points (55 selectable) with 45 cross sensors
TC-17E II	f/4	
TC-800-1.25E ED	f/5.6	37 focus points (17 selectable) with 25 cross sensors
TC-20E, TC-20E II, TC-20E III	f/4	
TC-14E, TC-14E II, TC-14E III	f/5.6	15 focus points (9 selectable) with 5 cross sensors

1 At maximum zoom, in the case of zoom lenses.

2 Other focus points use line sensors, which detect horizontal lines, but note that if there are only 5 cross sensors, only those shown by  detect vertical lines.

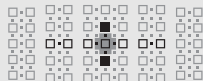

Autofocus is not available when teleconverters are used with AF-S VR Micro-Nikkor 105mm f/2.8G IF-ED lenses.

Autofocus Mode

Choose from the following autofocus modes:

Mode	Description
AF-S	Single-servo AF: For stationary subjects. Focus locks when shutter-release button is pressed halfway. At default settings, shutter can only be released when in-focus indicator (●) is displayed (<i>focus priority</i> ; □ 299).
AF-C	Continuous-servo AF: For moving subjects. Camera focuses continuously while shutter-release button is pressed halfway; if subject moves, camera will engage <i>predictive focus tracking</i> (□ 103) to predict final distance to subject and adjust focus as necessary. At default settings, shutter can be released whether or not subject is in focus (<i>release priority</i> ; □ 299).

Autofocus mode can be selected by pressing the AF-mode button and rotating the main command dial until the desired setting is displayed in the viewfinder and top control panel.

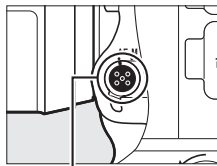

AF-mode button

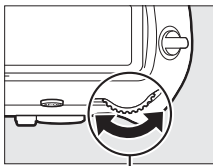

Main command dial

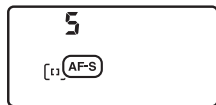





Top control panel



Viewfinder



See Also

For information on using focus priority in continuous-servo AF, see Custom Setting a1 (**AF-C priority selection**,  299). For information on using release priority in single-servo AF, see Custom Setting a2 (**AF-S priority selection**,  299). For information on preventing the camera from focusing when the shutter-release button is pressed halfway, see Custom Setting a8 (**AF activation**,  300). See Custom Setting a10 (**Autofocus mode restrictions**,  301) for information on limiting focus-mode selection to **AF-S** or **AF-C** and f4 (**Customize command dials**) > **Change main/sub** ( 308) for information on using the sub-command dial to choose the focus mode. See page 48 for information on the autofocus options available in live view or during movie recording.

The AF-ON Buttons

For the purpose of focusing the camera, pressing either of the **AF-ON** buttons has the same effect as pressing the shutter-release button halfway (note that the **AF-ON** button for vertical shooting can only be used when the vertical shooting shutter-release button lock is unlocked;  39).

AF-ON button

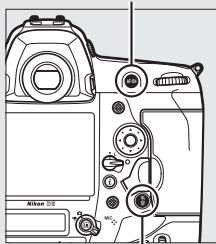

AF-ON button for vertical shooting

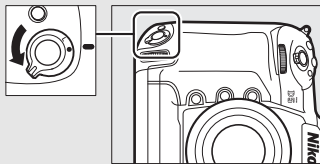

Vertical shooting shutter-release button lock

Predictive Focus Tracking

In **AF-C** mode, the camera will initiate predictive focus tracking if the subject moves toward or away from the camera while the shutter-release button is pressed halfway or either of the **AF-ON** buttons is pressed. This allows the camera to track focus while attempting to predict where the subject will be when the shutter is released.





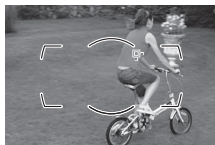
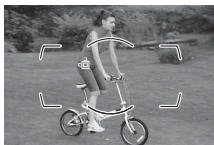
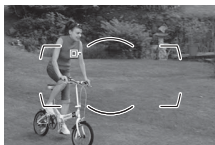

AF-Area Mode

Choose how the focus point for autofocus is selected.

- **Single-point AF:** Select the focus point as described on page 108; the camera will focus on the subject in the selected focus point only. Use with stationary subjects.
- **Dynamic-area AF:** Select the focus point as described on page 108. In **AF-C** focus mode, the camera will focus based on information from surrounding focus points if the subject briefly leaves the selected point. The number of focus points varies with the mode selected:
 - **9- or 25-point dynamic-area AF:** Choose when there is time to compose the photograph or when photographing subjects that are moving predictably (e.g., runners or race cars on a track).
 - **72-point dynamic-area AF:** Choose when photographing subjects that are moving unpredictably (e.g., players at a football game).
 - **153-point dynamic-area AF:** Choose when photographing subjects that are moving quickly and can not be easily framed in the viewfinder (e.g., birds).
- **3D-tracking:** Select the focus point as described on page 108. In **AF-C** focus mode, the camera will track subjects that leave the selected focus point and select new focus points as required. Use to quickly compose pictures with subjects that are moving erratically from side to side (e.g., tennis players). If the subject leaves viewfinder, remove your finger from the shutter-release button and recompose the photograph with the subject in the selected focus point.



- **Group-area AF:** The camera focuses using a group of focus points selected by the user, reducing the risk of the camera focusing on the background instead of on the main subject. Choose for subjects that are difficult to photograph using a single focus point. If faces are detected in **AF-S** focus mode, the camera will give priority to portrait subjects.
- **Group-area AF (HL)/Group-area AF (VL):** HL and VL stand for “horizontal line” and “vertical line”, respectively. The user selects a row (HL) or column (VL) of focus points, and the camera gives priority to the point in the selected row or column containing the subject closest to the camera. Press  or  to choose the row (HL),  or  to choose the column (VL).
- **Auto-area AF:** The camera automatically detects the subject and selects the focus point; if a face is detected, the camera will give priority to the portrait subject. The active focus points are highlighted briefly after the camera focuses; in **AF-C** mode, the main focus point is displayed after the other focus points have turned off.

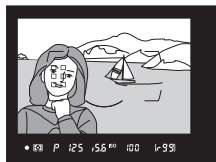

AF-area mode can be selected by pressing the AF-mode button and rotating the sub-command dial until the desired setting is displayed in the viewfinder and top control panel.

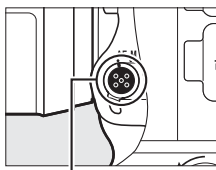

AF-mode button

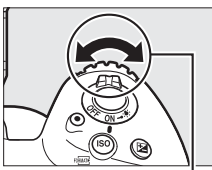

Sub-command dial

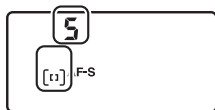



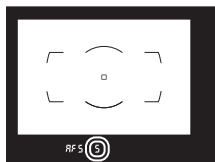









Top control panel



Viewfinder

AF-Area Mode

AF-area mode is shown in the top control panel and viewfinder.

AF-area mode	Top control panel	Viewfinder	Viewfinder focus-point display
Single-point AF	S		
9-point dynamic-area AF*	d 9		
25-point dynamic-area AF*	d 25		
72-point dynamic-area AF*	d 72		
153-point dynamic-area AF*	d 153		
3D-tracking	3d		
Group-area AF	GrP		
Group-area AF (HL)	GrP HL		
Group-area AF (VL)	GrP VL		
Auto-area AF	Auto		

* Only active focus point is displayed in the viewfinder. Remaining focus points provide information to assist focus operation.

3D-tracking

When the shutter-release button is pressed halfway, the colors in the area surrounding the focus point are stored in the camera.

Consequently 3D-tracking may not produce the desired results with subjects that are similar in color to the background or that occupy a very small area of the frame.







AF-S/AF-I Teleconverters

If 3D-tracking or auto-area AF is selected for AF-area mode when an AF-S/AF-I teleconverter is used, single-point AF will automatically be selected at combined apertures slower than f/5.6.

Manual Focus

Single-point AF is automatically selected when manual focus is used.

See Also

For information on how autofocus adjusts to changes in the distance to the subject, see Custom Setting a3 (**Focus tracking with lock-on**,  299). To adjust settings for 3D-tracking, use Custom Settings a4 (**3D-tracking face-detection**,  300) and a5 (**3D-tracking watch area**,  300). See Custom Setting a7 (**Store by orientation**,  300) for information on choosing different focus points and/or AF-area modes for portrait- and landscape-orientation photographs, a9 (**Limit AF-area mode selection**,  300) for information on limiting AF-area mode selection, a12 (**Focus point options**,  301) for information on choosing how the focus point is displayed in dynamic-area AF, and f4 (**Customize command dials**) > **Change main/sub** ( 308) for information on using the main command dial to choose the AF-area mode. See page 49 for information on the autofocus options available in live view or during movie recording.



Focus Point Selection

The camera focuses using 153 focus points, of which 55 shown at right can be selected manually, allowing photographs to be composed with the main subject positioned almost anywhere in the frame. Follow the steps below to choose the focus point (in group-area AF, you can follow these steps to choose a group, row, or column of focus points).

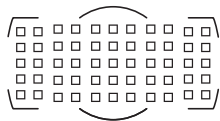

1 Rotate the focus selector lock to ●.

This allows the multi selector to be used to select the focus point.

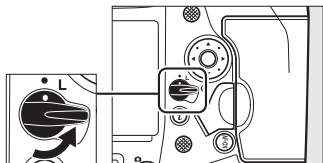

Focus selector lock

2 Select the focus point.

Use the multi selector to select the focus point in the viewfinder while the exposure meters are on. The center focus point can be selected by pressing the center of the multi selector.

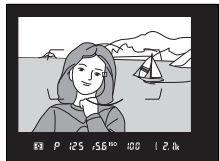

The focus selector lock can be rotated to the locked (L) position following selection to prevent the selected focus point from changing when the multi selector is pressed.

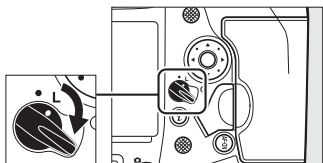

The Sub-selector

The sub-selector can be used in place of the multi selector to select the focus point. Focus and exposure lock while the center of the sub-selector is pressed (☞ 111, 141). Be careful not to put your fingers or fingernails in your eye when using the sub-selector.

Sub-selector

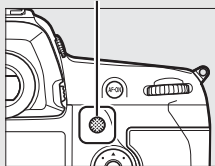

Portrait (Tall-Orientation) Photographs

When framing shots in portrait (“tall”) orientation, use the multi selector for vertical shooting to select the focus point. For more information, see Custom Setting f1 (**Custom control assignment**) > **Multi selector for vertical shooting** (☞ 307).

Using the Sub-selector and Multi Selector for Vertical Shooting

Use as shown at right. Pressing the sides may not have the desired effect.









Auto-area AF

The focus point for auto-area AF is selected automatically; manual focus-point selection is not available.



See Also

For information on choosing the number of focus points that can be selected using the multi selector, see Custom Setting a6 (**Number of focus points**,  300). For information on choosing separate focus points and/or AF-area modes for vertical and horizontal orientations, see Custom Setting a7 (**Store by orientation**,  300). For information on setting focus-point selection to “wrap around,” see Custom Setting a11 (**Focus point wrap-around**,  301). For information on choosing when the focus point is illuminated, see Custom Setting a12 (**Focus point options**,  301). For information on changing the role played by the sub-selector, see Custom Setting f1 (**Custom control assignment**) > **Sub-selector** ( 307) and **Sub-selector center** ( 307). For information on changing the role of the multi selector center button, see Custom Setting f2 (**Multi selector center button**,  308).



Focus Lock

Focus lock can be used to change the composition after focusing, making it possible to focus on a subject that will not be in a focus point in the final composition. If the camera is unable to focus using autofocus (☐ 113), focus lock can also be used to recompose the photograph after focusing on another object at the same distance as your original subject. Focus lock is most effective when an option other than auto-area AF is selected for AF-area mode (☐ 104).

1 Focus.

Position the subject in the selected focus point and press the shutter-release button halfway to initiate focus. Check that the in-focus indicator (●) appears in the viewfinder.

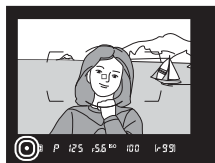

2 Lock focus.

AF-C focus mode (☐ 101): With the shutter-release button pressed halfway (①), press the center of the sub-selector (②) to lock both focus and exposure (an **AE-L** icon will be displayed in the viewfinder). Focus will remain locked while the center of the sub-selector is pressed, even if you later remove your finger from the shutter-release button.

Shutter-release button

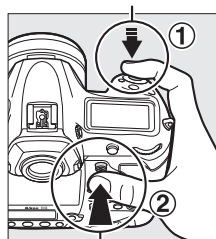

Sub-selector



AF-S focus mode: Focus locks automatically when the in-focus indicator (●) appears, and remains locked until you remove your finger from the shutter-release button. Focus can also be locked by pressing the center of the sub-selector as described on the previous page.

3 Recompose the photograph and shoot.

Focus will remain locked between shots if you keep the shutter-release button pressed halfway (**AF-S**) or keep the center of the sub-selector pressed, allowing several photographs in succession to be taken at the same focus setting.

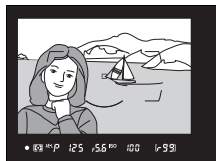

Do not change the distance between the camera and the subject while focus lock is in effect. If the subject moves, focus again at the new distance.



Locking Focus with the AF-ON Button

During viewfinder photography, focus can be locked using either of the **AF-ON** buttons in place of the shutter-release button (📖 102). If **AF-ON only** is selected for Custom Setting a8 (**AF activation**, 📖 300), the camera will not focus when the shutter-release button is pressed halfway; instead, the camera will focus when an **AF-ON** button is pressed, at which point focus will lock and remain locked until either **AF-ON** button is pressed again.

See Also

See Custom setting c1 (**Shutter-release button AE-L**, 📖 302) for information on using the shutter-release button to lock exposure.

Getting Good Results with Autofocus

Autofocus does not perform well under the conditions listed below. The shutter release may be disabled if the camera is unable to focus under these conditions, or the in-focus indicator (●) may be displayed and the camera may sound a beep, allowing the shutter to be released even when the subject is not in focus. In these cases, use manual focus (📖 114) or use focus lock (📖 111) to focus on another subject at the same distance and then recompose the photograph.



There is little or no contrast between the subject and the background.

Example: Subject is the same color as the background.



The focus point contains objects at different distances from the camera.

Example: Subject is inside a cage.



The subject is dominated by regular geometric patterns.

Example: Blinds or a row of windows in a skyscraper.

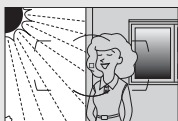

The focus point contains areas of sharply contrasting brightness.

Example: Subject is half in the shade.



Background objects appear larger than the subject.

Example: A building is in the frame behind the subject.

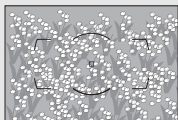

The subject contains many fine details.

Example: A field of flowers or other subjects that are small or lack variation in brightness.



Manual Focus

Manual focus is available for lenses that do not support autofocus (non-AF NIKKOR lenses) or when the autofocus does not produce the desired results (☞ 113).

- **AF lenses:** Set the lens focus mode switch (if present) and camera focus-mode selector to **M**.

Focus-mode selector

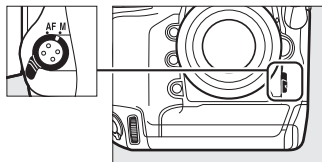

✓ AF Lenses

Do not use AF lenses with the lens focus-mode switch set to **M** and the camera focus-mode selector set to **AF**. Failure to observe this precaution could damage the camera or lens. This does not apply to AF-S and AF-P lenses, which can be used in **M** mode without setting the camera focus-mode selector to **M**.

- **Manual focus lenses:** Focus manually.

To focus manually, adjust the lens focus ring until the image displayed on the clear matte field in the viewfinder is in focus.

Photographs can be taken at any time, even when the image is not in focus.

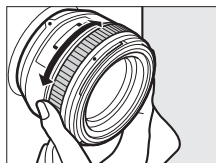

■ The Electronic Rangefinder

The viewfinder focus indicator can be used to confirm whether the subject in the selected focus point is in focus (the focus point can be selected from any of the 55 focus points).

After positioning the subject in the selected focus point, press the shutter-release button halfway and rotate the lens focus ring until the in-focus indicator (●) is displayed. Note that with the subjects listed on page 113, the in-focus indicator may sometimes be displayed when the subject is not in focus; confirm focus in the viewfinder before shooting. For information on using the electronic rangefinder with optional AF-S/AF-I teleconverters, see page 100.

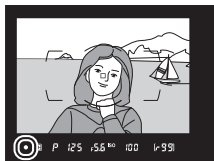

✎ AF-P Lenses

When an AF-P lens (📖 323) is used in manual focus mode, the in-focus indicator will flash in the viewfinder (or in live view, the focus point will flash in the monitor) to warn that continuing to rotate the focus ring in the current direction will not bring the subject into focus.

✎ Focal Plane Position

To determine the distance between your subject and the camera, measure from the focal plane mark (⊖) on the camera body. The distance between the lens mounting flange and the focal plane is 46.5 mm (1.83 in.).

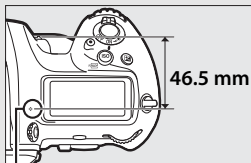

Focal plane mark







Release Mode

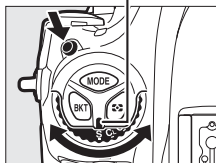

Choosing a Release Mode

To choose a release mode, press the release mode dial lock release and turn the release mode dial so that the pointer aligns with the desired setting.

Pointer



Mode	Description
S	Single frame: The camera takes one photograph each time the shutter-release button is pressed.
CL	Continuous low speed: The frame rate can be selected from values between 1 and 10 fps by pressing the  button and rotating the sub-command dial. The camera records photographs at the selected rate while the shutter-release button is pressed ( 117).
CH	Continuous high speed: The frame rate can be selected by pressing the  button and rotating the sub-command dial. Choose from 10, 11, 12, and 14 fps. The camera records photographs at the selected rate while the shutter-release button is pressed ( 117).
Q	Quiet shutter-release: As for single frame, except that the mirror does not click back into place while the shutter-release button is fully pressed, allowing the user to control the timing of the click made by the mirror, which is also quieter than in single frame mode. In addition, a beep does not sound regardless of the setting selected for Beep in the setup menu ( 312). Continuous release can also be selected by pressing  and rotating a command dial until  is displayed in the rear control panel, in which case the camera will take pictures at about 3 fps while the shutter-release button is pressed.

Mode	Description
	Self-timer: Take pictures with the self-timer (📖 120).
MUP	Mirror up: Choose this mode to minimize camera shake in telephoto or close-up photography or in other situations in which the slightest camera movement can result in blurred photographs (📖 122).
	Quick release-mode selection: Press and hold the  button and rotate the main command dial to select the release mode (📖 119).

Continuous Release Modes

The frame rates for continuous low- and high-speed modes can also be selected using Custom Setting d1 (**Continuous shooting speed**, 📖 303). The stated rates assume continuous-servo AF, manual or shutter-priority auto exposure, a shutter speed of $1/250$ s or faster, and other settings at default values. The stated rates may not be available with some lenses; in addition, frame rates may drop at extremely small apertures (high f-numbers) or slow shutter speeds, when vibration reduction (available with VR lenses) or auto ISO sensitivity control (📖 126) is on, or when the battery is low, a non-CPU lens is attached, **Aperture ring** is selected for Custom Setting f4 (**Customize command dials**) > **Aperture setting** (📖 308), or flicker is detected when flicker reduction is enabled in the photo shooting menu (📖 227).

Taking Pictures at 14 Frames per Second

When **14 fps (mirror up)** is selected in continuous high-speed release mode, the mirror will be raised when the shutter-release button is pressed all the way down, focus and exposure will lock at the values selected for the first frame in each burst, and optional flash units will not fire. The view through the lens is not visible in the viewfinder during shooting.

The Memory Buffer

The camera is equipped with a memory buffer for temporary storage, allowing shooting to continue while photographs are being saved to the memory card. Note, however, that frame rate will drop when the buffer is full (r00).

The approximate number of images that can be stored in the memory buffer at current settings is shown in the exposure-count displays in the viewfinder and top control panel while the shutter-release button is pressed halfway. The illustration at right shows the display when space remains in the buffer for about 99 pictures.

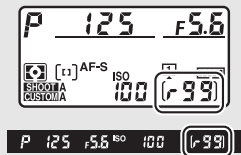



While photographs are being recorded to the memory card, the memory card access lamp will light. Depending on shooting conditions and memory card performance, recording may take from a few seconds to a few minutes. *Do not remove the memory card or remove or disconnect the power source until the access lamp has gone out.* If the camera is switched off while data remain in the buffer, the power will not turn off until all images in the buffer have been recorded. If the battery is exhausted while images remain in the buffer, the shutter release will be disabled and the images transferred to the memory card.

See Also

For information on choosing the order in which the photos in each burst are displayed after shooting, see **After burst, show** (□ 290). For information on choosing the maximum number of photographs that can be taken in a single burst, see Custom Setting d2 (**Max. continuous release**, □ 303). For information on the number of pictures that can be taken in a single burst, see page 385.

Quick Release-Mode Selection

When the release mode dial is rotated to , the release mode can be selected by keeping the  button pressed while rotating the main command dial.

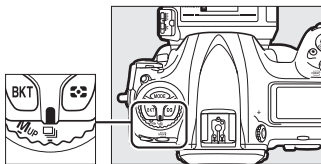

Release mode dial

To adjust settings for the selected release mode, press and hold the  button and rotate the sub-command dial.

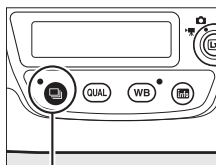



 button

Release mode settings are shown in the rear control panel.



Rear control panel

See Also

For information on choosing the release modes that can be selected with the  button, see Custom Setting d3 (**Limit release mode selection**,  304).

Self-Timer Mode

The self-timer can be used to reduce camera shake or for self-portraits.

1 Mount the camera on a tripod.

Mount the camera on a tripod or place the camera on a stable, level surface.

2 Select self-timer mode.

Press the release mode dial lock release and turn the release mode dial to .

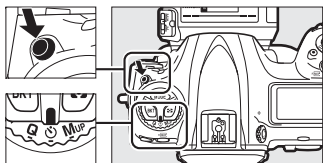

Release mode dial

3 Frame the photograph and focus.

In single-servo AF (📖 101), photographs can only be taken if the in-focus (●) indicator appears in the viewfinder.



Close the Viewfinder Eyepiece Shutter

When taking photos without your eye to the viewfinder, close the viewfinder eyepiece shutter to prevent light entering via the viewfinder from appearing in photographs or interfering with exposure.

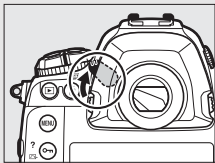

4 Start the timer.

Press the shutter-release button all the way down to start the timer. The self-timer lamp will start to flash. Two seconds before the photograph is taken, the self-timer lamp will stop flashing. The shutter will be released about ten seconds after the timer starts.



To turn the self-timer off before a photograph is taken, turn the release mode dial to another setting.





Setting the Timer

To choose the timer duration, press and hold the  button and rotate a command dial. The timer can be set to 20, 10, 5, or 2 seconds.



Rear control panel

See Also

For information on choosing the duration of the self-timer, the number of shots taken, and the interval between shots, see Custom Setting c3 (**Self-timer**,  303). The beeps that sound when the self-timer is used can be controlled using the **Beep** option in the setup menu ( 312).

Mirror up Mode

Choose this mode to minimize blurring caused by camera movement when the mirror is raised. To use mirror-up mode, press the release mode dial lock release and rotate the release mode dial to **MUP** (mirror up). After pressing the shutter-release button halfway to set focus and exposure, press the shutter-release button the rest of the way down to raise the mirror. **rdy** will be displayed in the control panels; press the shutter-release button all the way down again to take the picture (in live view, there is no need to raise the mirror; the picture is taken the first time the shutter-release button is pressed all the way down). A beep will sound, unless **Off** is selected for **Beep** in the setup menu (📖 312). The mirror lowers when shooting ends.

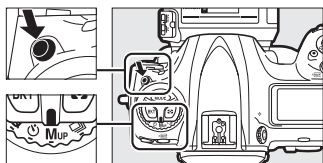

Release mode dial

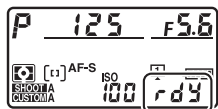

Mirror Up

While the mirror is raised, photos can not be framed in the viewfinder and autofocus and metering will not be performed.

Mirror up Mode

A picture will be taken automatically if no operations are performed for about 30 s after the mirror is raised.

Preventing Blur

To prevent blurring caused by camera movement, press the shutter-release button smoothly. Use of a tripod is recommended.

See Also

For information on using the electronic front-curtain shutter to further reduce blur, see Custom Setting d6 (**Electronic front-curtain shutter**,  304).



ISO Sensitivity

Manual Adjustment

The camera's sensitivity to light can be adjusted according to the amount of light available. Choose from settings that range from ISO 100 and ISO 102400 in steps equivalent to $\frac{1}{3}$ EV. Settings of from about 0.3 to 1 EV below ISO 100 and 0.3 to 5 EV above ISO 102400 are also available for special situations. The higher the ISO sensitivity, the less light needed to make an exposure, allowing higher shutter speeds or smaller apertures.

ISO sensitivity can be adjusted by pressing the **ISO (FORMAT)** button and rotating the main command dial until the desired setting is displayed in the top control panel and viewfinder.

ISO (FORMAT) button

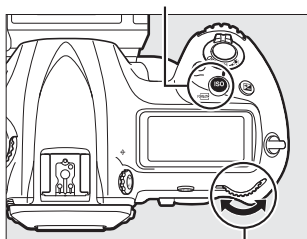

Main command dial

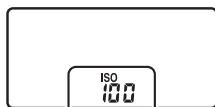

Top control panel



Viewfinder

The ISO Sensitivity Menu

ISO sensitivity can also be adjusted using the **ISO sensitivity settings** option in the photo shooting menu ( 293).

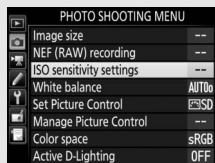

ISO Sensitivity

The higher the ISO sensitivity, the less light needed to make an exposure, allowing faster shutter speeds or smaller apertures, but the more likely the image is to be affected by noise (randomly-spaced bright pixels, fog, or lines). Noise is particularly likely at settings between **Hi 0.3** and **Hi 5**.

Hi 0.3–Hi 5

The settings **Hi 0.3** through **Hi 5** correspond to ISO sensitivities 0.3–5 EV over ISO 102400 (ISO 128000–3280000 equivalent).

Lo 0.3–Lo 1

The settings **Lo 0.3** through **Lo 1** correspond to ISO sensitivities 0.3–1 EV below ISO 100 (ISO 80–50 equivalent). Use for larger apertures when lighting is bright. Contrast is slightly higher than normal; in most cases, ISO sensitivities of ISO 100 or above are recommended.

See Also

For information on choosing the ISO sensitivity step size, see Custom Setting b1 (**ISO sensitivity step value**;  301). For information on using the **High ISO NR** options in the photo and movie shooting menus to reduce noise at high ISO sensitivities, see pages 294 (photos) and 298 (movies).

Auto ISO Sensitivity Control

If **On** is selected for **ISO sensitivity settings > Auto ISO sensitivity control** in the photo shooting menu, ISO sensitivity will automatically be adjusted if optimal exposure can not be achieved at the value selected by the user (ISO sensitivity is adjusted appropriately when the flash is used).

1 Select Auto ISO sensitivity control.

Select **ISO sensitivity settings** in the photo shooting menu, highlight **Auto ISO sensitivity control** and press .

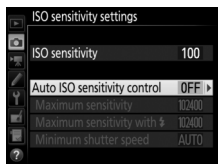

2 Select On.

Highlight **On** and press  (if **Off** is selected, ISO sensitivity will remain fixed at the value selected by the user).

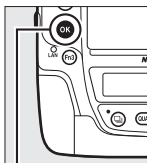

 **button**

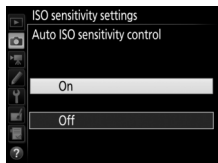

3 Adjust settings.

The maximum value for auto ISO sensitivity can be selected using **Maximum sensitivity** (the minimum value for auto ISO sensitivity is automatically set to ISO 100; note that if the ISO sensitivity selected by the user is higher than that chosen for **Maximum sensitivity**, the value selected by the user will be used instead). In exposure modes **P** and **A**, sensitivity will only be adjusted if underexposure would result at the shutter speed selected for **Minimum shutter speed** ($1/4000$ –30 s, or **Auto**; in modes **S** and **M**, ISO sensitivity will be adjusted for optimal exposure at the shutter speed selected by the user). If **Auto** is selected, the camera will choose the minimum shutter speed based on the focal length of the lens. Press **OK** to exit when settings are complete.

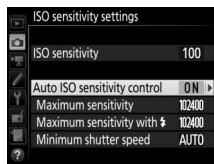

To choose the maximum ISO sensitivity for photos taken using an optional flash unit (□ 330), use **Maximum sensitivity with flash**. Selecting **Same as without flash** sets the maximum ISO sensitivity for flash photography to the value currently selected for **Maximum sensitivity**.

When **On** is selected, the viewfinder and top control panel show **ISO-AUTO**. When sensitivity is altered from the value selected by the user, these indicators flash and the altered value is shown in the viewfinder and top control panel.

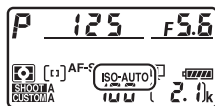

Minimum Shutter Speed



Auto shutter-speed selection can be fine-tuned by highlighting **Auto** and pressing : for example, values faster than those usually selected automatically can be used with telephoto lenses to reduce blur. Note, however, that **Auto** functions only with CPU lenses; if a non-CPU lens is used without lens data, minimum shutter speed is fixed at $1/30$ s. Shutter speeds may drop below the selected minimum if optimum exposure can not be achieved at the ISO sensitivity chosen for **Maximum sensitivity**.

Turning Auto ISO Sensitivity Control On or Off

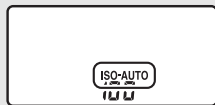

You can turn auto ISO sensitivity control on or off by pressing the **ISO** () button and rotating the sub-command dial. The top control panel and viewfinder display **ISO-AUTO** icons when auto ISO sensitivity control is on and **ISO** when it is off.



Auto ISO Sensitivity Control

When a flash is used, minimum shutter speed will be set to the value selected for **Minimum shutter speed** unless this value is faster than Custom Setting e1 (**Flash sync speed**,  305) or slower than Custom Setting e2 (**Flash shutter speed**,  306), in which case the value selected for Custom Setting e2 will be used instead. Note that ISO sensitivity may be raised automatically when auto ISO sensitivity control is used in combination with slow sync flash modes (available with optional flash units;  198), possibly preventing the camera from selecting slow shutter speeds.

See Also





For information on choosing the reference used to set exposure when a flash is used with auto ISO sensitivity control, see Custom Setting e4 (**Auto  ISO sensitivity control**,  306).



Exposure

Metering

Metering determines how the camera sets exposure. The following options are available:

Option	Description
	Matrix: Produces natural results in most situations. Camera meters wide area of the frame and sets exposure according to tone distribution, color, composition, and, with type G, E, or D lenses (☐ 323), distance information (3D color matrix metering III; with other CPU lenses, camera uses color matrix metering III, which does not include 3D distance information).
	Center-weighted: Camera meters entire frame but assigns greatest weight to center area (if CPU lens is attached, size of area can be selected using Custom Setting b6, Center-weighted area , ☐ 302; if non-CPU lens is attached, area is equivalent to circle 12 mm in diameter). Classic meter for portraits; recommended when using filters with an exposure factor (filter factor) over 1×.
	Spot: Camera meters circle 4 mm (0.16 in.) in diameter (approximately 1.5% of frame), ensuring that subject will be correctly exposed, even when background is much brighter or darker. Metered area is centered on current focus point. Note, however, that the camera will meter center focus point if: <ul style="list-style-type: none">• auto-area AF, group-area AF (HL), or group-area AF (VL) is selected for AF-area mode (☐ 104), or• non-CPU lens is attached
 *	Highlight-weighted: Camera assigns greatest weight to highlights. Use to reduce loss of detail in highlights, for example when photographing spotlight performers on-stage.



To choose a metering option, press the  button and rotate the main command dial until the desired setting is displayed in the viewfinder and top control panel.

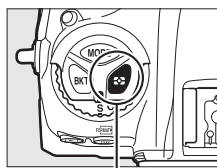

 button

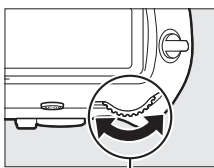

Main command dial





Top control panel





Viewfinder

Non-CPU Lens Data

Specifying the focal length and maximum aperture of non-CPU lenses using the **Non-CPU lens data** option in the setup menu ( 243) allows the camera to use color matrix metering when matrix is selected and improves the accuracy of center-weighted and spot metering. Center-weighted metering will be used if highlight-weighted metering is selected with non-CPU lenses or if matrix metering is selected with non-CPU lenses for which lens data have not been supplied. Note that center-weighted metering may also be used if highlight-weighted metering is selected with certain CPU lenses (AI-P NIKKOR lenses and AF lenses that are not of type G, E, or D;  323).

See Also

See Custom Setting b5 (**Matrix metering**,  302) for information on choosing whether matrix metering uses face detection. For information on making separate adjustments to optimal exposure for each metering method, see Custom Setting b7 (**Fine-tune optimal exposure**,  302).

Exposure Mode

To determine how the camera sets shutter speed and aperture when adjusting exposure, press the **MODE** button and rotate the main command dial until the desired option appears in the top control panel.

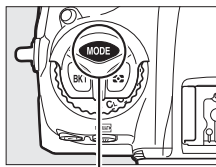

MODE button

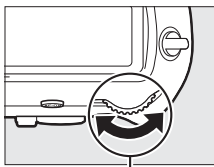

Main command dial

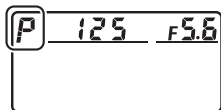

Top control panel

Mode	Description
P	Programmed auto (☞ 133): Camera sets shutter speed and aperture for optimal exposure. Recommended for snapshots and in other situations in which there is little time to adjust camera settings.
S	Shutter-priority auto (☞ 134): User chooses shutter speed; camera selects aperture for best results. Use to freeze or blur motion.
A	Aperture-priority auto (☞ 135): User chooses aperture; camera selects shutter speed for best results. Use to blur background or bring both foreground and background into focus.
M	Manual (☞ 136): User controls both shutter speed and aperture. Set shutter speed to Bulb (b u l b) or Time (- -) for long time-exposures.



Lens Types

When using a CPU lens equipped with an aperture ring (□ 326), lock the aperture ring at the minimum aperture (highest f-number). Type G and E lenses are not equipped with an aperture ring.

When using non-CPU lenses (□ 243), select exposure mode **A** (aperture-priority auto) or **M** (manual). In other modes, exposure mode **A** is automatically selected when a non-CPU lens is attached (□ 326). The exposure mode indicator (**P** or **S**) will flash in the top control panel and **A** will be displayed in the viewfinder.

Depth-of-Field Preview

To preview the effects of aperture, press and hold the **Pv** button. The lens will be stopped down to the aperture value selected by the camera (modes **P** and **S**) or the value chosen by the user (modes **A** and **M**), allowing depth of field to be previewed in the viewfinder.

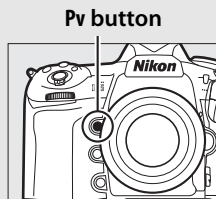

Custom Setting e5—Modeling Flash

This setting controls whether optional flash units that support the Nikon Creative Lighting System (CLS; □ 330) will emit a modeling flash when the **Pv** button is pressed.



P: Programmed Auto

In this mode, the camera automatically adjusts shutter speed and aperture according to a built-in program to ensure optimal exposure in most situations.

Flexible Program

In exposure mode **P**, different combinations of shutter speed and aperture can be selected by rotating the main command dial while the exposure meters are on (“flexible program”). Rotate the dial to the right for large apertures (low f-numbers) that blur background details or fast shutter speeds that “freeze” motion. Rotate the dial to the left for small apertures (high f-numbers) that increase depth of field or slow shutter speeds that blur motion. All combinations produce the same exposure. While flexible program is in effect, an asterisk (“*”) appears in the top control panel. To restore default shutter speed and aperture settings, rotate the dial until the asterisk is no longer displayed, choose another mode, or turn the camera off.



Main command dial

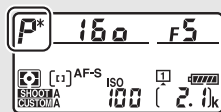

See Also

See page 357 for information on the built-in exposure program. For information on activating the exposure meters, see “The Standby Timer (Viewfinder Photography)” on page 41.

S: Shutter-Priority Auto

In shutter-priority auto, you choose the shutter speed while the camera automatically selects the aperture that will produce the optimal exposure.

To choose a shutter speed, rotate the main command dial while the exposure meters are on. Shutter speed can be set to "x 250" or to values between 30 s and $1/8000$ s. Shutter speed can be locked at the selected setting (📖 140).



Main command dial

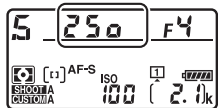

A: Aperture-Priority Auto

In aperture-priority auto, you choose the aperture while the camera automatically selects the shutter speed that will produce the optimal exposure.

To choose an aperture between the minimum and maximum values for the lens, rotate the sub-command dial while the exposure meters are on. Aperture can be locked at the selected setting (📖 140).

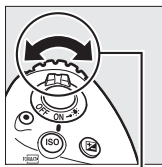

Sub-command dial

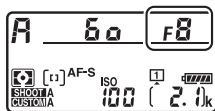

Non-CPU Lenses (📖 324, 326)

Use the lens aperture ring to adjust aperture. If the maximum aperture of the lens has been specified using the **Non-CPU lens data** item in setup menu (📖 244) when a non-CPU lens is attached, the current f-number will be displayed in the viewfinder and top control panel, rounded to the nearest full stop.

Otherwise the aperture displays will show only the number of stops (ΔF , with maximum aperture displayed as $\Delta F0$) and the f-number must be read from the lens aperture ring.

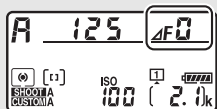

M: Manual

In manual exposure mode, you control both shutter speed and aperture. While the exposure meters are on, rotate the main command dial to choose a shutter speed, and the sub-command dial to set aperture. Shutter speed can be set to “x 250” or to values between 30 s and $1/8000$ s, or the shutter can be held open indefinitely for a long time-exposure (bulb or - -, [138](#)). Aperture can be set to values between the minimum and maximum values for the lens. Use the exposure indicators to check exposure.

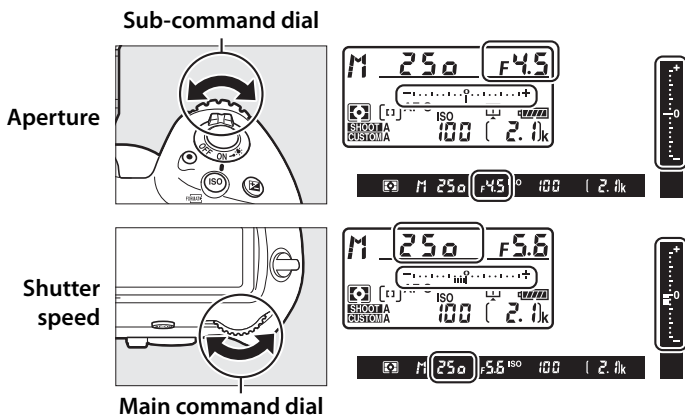







Shutter speed and aperture can be locked at the selected setting ([140](#)).

AF Micro NIKKOR Lenses

Provided that an external exposure meter is used, the exposure ratio need only be taken into account when the lens aperture ring is used to set aperture.

Exposure Indicators

The exposure indicators in the viewfinder and top control panel show whether the photograph would be under- or over-exposed at current settings. Depending on the option chosen for Custom Setting b2 (**EV steps for exposure cntrl**,  301), the amount of under- or over-exposure is shown in increments of $\frac{1}{3}$ EV, $\frac{1}{2}$ EV, or 1 EV. If the limits of the exposure metering system are exceeded, the displays will flash.

Custom Setting b2 set to 1/3 step			
	Optimal exposure	Underexposed by $\frac{1}{3}$ EV	Overexposed by over 3 EV
Top control panel			
Viewfinder			

See Also

For information on reversing the exposure indicators so that negative values are displayed on the right and positive values on the left, see Custom Setting f7 (**Reverse indicators**,  309).



Long Time-Exposures (M Mode Only)

Select the following shutter speeds for long time-exposures of moving lights, the stars, night scenery, or fireworks.

- **Bulb** (b, L, B): The shutter remains open while the shutter-release button is held down. To prevent blur, use a tripod or an optional wireless remote controller (□ 337) or remote cord (□ 339).
- **Time** (- -): Start the exposure by using the shutter-release button on the camera or on an optional remote cord, or wireless remote controller. The shutter remains open until the button is pressed a second time.



Length of exposure: 35 s
Aperture: f/25



1 Ready the camera.

Mount the camera on a tripod or place it on a stable, level surface.

Long Time-Exposures

Close the viewfinder eyepiece shutter to prevent the photograph being affected by light entering via the viewfinder (□ 120). Nikon recommends using a fully charged battery or an optional AC adapter and power connector to prevent loss of power while the shutter is open. Note that noise (bright spots, randomly-spaced bright pixels or fog) may be present in long exposures. Bright spots and fog can be reduced by choosing **On** for **Long exposure NR** in the photo shooting menu (□ 294).

2 Select exposure mode M.

Press the **MODE** button and rotate the main command dial until **M** is displayed in the top control panel.

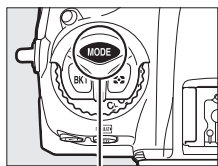

MODE button

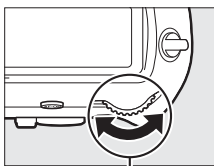

Main command dial

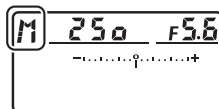

Top control panel

3 Choose a shutter speed.

While the exposure meters are on, rotate the main command dial to choose a shutter speed of Bulb (**b u l b**) or Time (**- -**). The exposure indicators do not appear when Bulb (**b u l b**) or Time (**- -**) is selected.

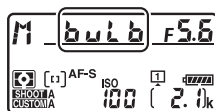

Bulb

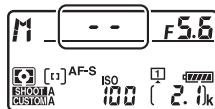

Time

4 Open the shutter.

Bulb: After focusing, press the shutter-release button on the camera or optional remote cord or wireless remote controller all the way down. Keep the shutter-release button pressed until the exposure is complete.

Time: Press the shutter-release button all the way down.

5 Close the shutter.

Bulb: Take your finger off the shutter-release button.

Time: Press the shutter-release button all the way down.



Shutter-Speed and Aperture Lock

Shutter speed lock is available in shutter-priority auto and manual exposure modes, aperture lock in aperture-priority auto and manual exposure modes. Shutter speed and aperture lock are not available in programmed auto exposure mode.

1 Assign shutter speed and aperture lock to a camera control.

Assign **Shutter spd & aperture lock** to a control using Custom Setting f1 (**Custom control assignment**,  307).

2 Lock shutter speed and/or aperture.

Shutter speed (exposure modes S and M):

Press the selected control and rotate the main command dial until  icons appear in the viewfinder and top control panel.

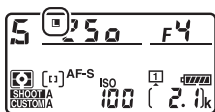

To unlock shutter speed, press the control and rotate the main command dial until the  icons disappear from the displays.

Aperture (exposure modes A and M): Press the selected control and rotate the sub-command dial until  icons appear in the viewfinder and the top control panel.

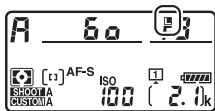

To unlock aperture, press the control and rotate the sub-command dial until the  icons disappear from the displays.

See Also

Use Custom Setting f3 (**Shutter spd & aperture lock**;  308) to keep shutter speed and/or aperture locked at the selected values.

Autoexposure (AE) Lock

Use autoexposure lock to recompose photographs after using center-weighted metering and spot metering (129) to meter exposure.

1 Lock exposure.

Position the subject in the selected focus point and press the shutter-release button halfway. With the shutter-release button pressed halfway and the subject positioned in the focus point, press the center of the sub-selector to lock exposure (if you are using autofocus, confirm that the ● in-focus indicator appears in the viewfinder).

Shutter-release button

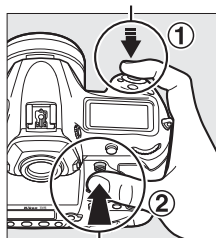

Sub-selector

While exposure lock is in effect, an **AE-L** indicator will appear in the viewfinder.

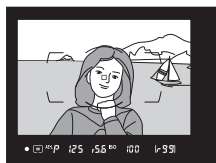
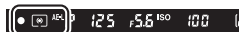

2 Recompose the photograph.

Keeping the center of the sub-selector pressed, recompose the photograph and shoot.

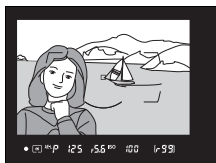

Metered Area

In spot metering, exposure will be locked at the value metered at the selected focus point (☐ 129). In center-weighted metering, exposure will be locked at the value metered in a 12-mm circle in the center of the viewfinder.

Adjusting Shutter Speed and Aperture

While exposure lock is in effect, the following settings can be adjusted without altering the metered value for exposure:

Exposure mode	Setting
P	Shutter speed and aperture (flexible program; ☐ 133)
S	Shutter speed
A	Aperture

The new values can be confirmed in the viewfinder and top control panel. Note that the metering method can not be changed while exposure lock is in effect.

See Also

If **On (half press)** is selected for Custom Setting c1 (**Shutter-release button AE-L**, ☐ 302), exposure will lock when the shutter-release button is pressed halfway.



Exposure Compensation

Exposure compensation is used to alter exposure from the value suggested by the camera, making pictures brighter or darker. It is most effective when used with center-weighted or spot metering (☞ 129). Choose from values between -5 EV (underexposure) and $+5$ EV (overexposure) in increments of $\frac{1}{3}$ EV. In general, positive values make the subject brighter while negative values make it darker.



-1 EV



No exposure
compensation



+1 EV

To choose a value for exposure compensation, press the  button and rotate the main command dial until the desired value is displayed in the viewfinder or top control panel.

 button

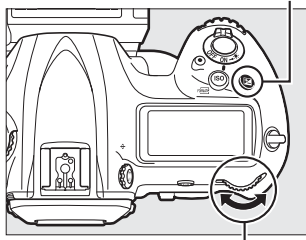

Main command dial



Top control panel

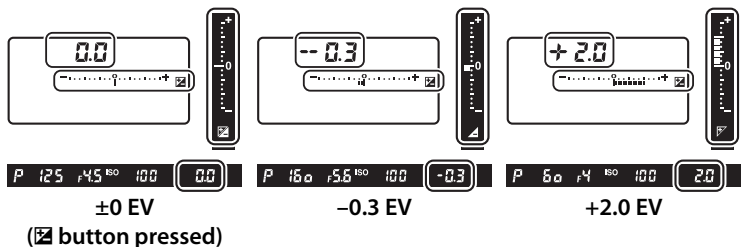

At values other than ± 0.0 , the 0 at the center of the exposure indicators will flash (exposure modes **P**, **S**, and **A** only) and a ☒ icon will be displayed in the viewfinder and top control panel after you release the ☒ button. The current value for exposure compensation can be confirmed in the exposure indicator by pressing the ☒ button.

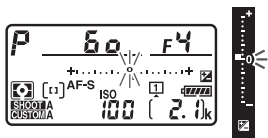

Normal exposure can be restored by setting exposure compensation to ± 0.0 . Exposure compensation is not reset when the camera is turned off.





Exposure Mode M

In exposure mode **M**, exposure compensation affects only the exposure indicator; shutter speed and aperture do not change.

Using a Flash

When a flash is used, exposure compensation affects both flash level and exposure, altering the brightness of both the main subject and the background. Custom Setting e3 (**Exposure comp. for flash**,  306) can be used to restrict the effects of exposure compensation to the background only.

See Also

For information on choosing the size of the increments available for exposure compensation, see Custom Setting b3 (**Exp./flash comp. step value**,  301). For information on making adjustments to exposure compensation without pressing the  button, see Custom Setting b4 (**Easy exposure compensation**,  302). For information on automatically varying exposure, flash level, white balance, or Active D-Lighting, see page 146.



Bracketing

Bracketing automatically varies exposure, flash level, **Active D-Lighting (ADL)**, or white balance slightly with each shot, “bracketing” the current value. Choose in situations in which getting the right settings is difficult and there is not time to check results and adjust settings with each shot, or to experiment with different settings for the same subject.

Bracketing is adjusted using the **Auto bracketing set** option in the photo shooting menu, which contains the following options:

- **AE & flash:** The camera varies exposure and flash level over a series of photographs (📖 147). Note that flash bracketing is available in i-TTL and, where supported, auto aperture (⊗A) flash control modes only (📖 196, 331).
- **AE only:** The camera varies exposure over a series of photographs.
- **Flash only:** The camera varies flash level over a series of photographs.
- **WB bracketing:** The camera creates multiple copies of each photograph, each with a different white balance (📖 151).
- **ADL bracketing:** The camera varies Active D-Lighting over a series of photographs (📖 155).

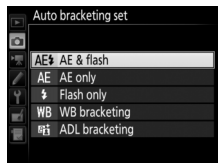

■ ■ Exposure and Flash Bracketing

To vary exposure and/or flash level over a series of photographs:



Exposure modified by:
0 EV



Exposure modified by:
-1 EV



Exposure modified by:
+1 EV

1 Choose the number of shots.

Pressing the **BKT** button, rotate the main command dial to choose the number of shots in the bracketing sequence. The number of shots is shown in the top control panel.

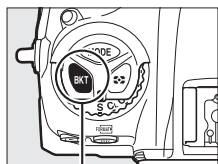

BKT button



Main command dial

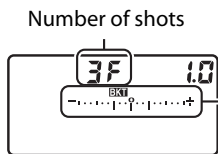

Top control panel

Exposure and flash
bracketing indicator

At settings other than zero, a **BKT** icon and exposure and flash bracketing indicator will be displayed in the viewfinder and top control panel.



2 Select an exposure increment.

Pressing the **BKT** button, rotate the sub-command dial to choose the exposure increment.

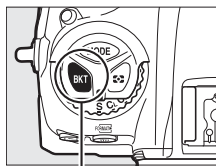

BKT button

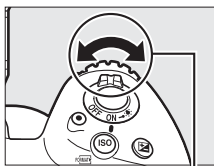

Sub-command dial

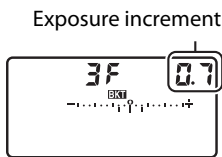

Top control panel

At default settings, the size of the increment can be chosen from 0.3 ($1/3$), 0.7 ($2/3$), 1, 2, and 3 EV. The bracketing programs with an increment of 0.3 ($1/3$) EV are listed below.

Control panel display	No. of shots	Bracketing order (EVs)
0F 0.3 -.....o.....+	0	0
+ 3F 0.3 -.....i...+...	3	0/+0.3/+0.7
-- 3F 0.3 -.....i...+...	3	0/-0.7/-0.3
+ 2F 0.3 -.....i...+...	2	0/+0.3
-- 2F 0.3 -.....i...+...	2	0/-0.3
3F 0.3 -.....i...+...	3	0/-0.3/+0.3
5F 0.3 -.....i...+...	5	0/-0.7/-0.3/+0.3/+0.7
7F 0.3 -.....i...+...	7	0/-1.0/-0.7/-0.3/+0.3/ +0.7/+1.0
9F 0.3 -.....i...+...	9	0/-1.3/-1.0/-0.7/-0.3/ +0.3/+0.7/+1.0/+1.3

Note that for exposure increments of 2 EV or more, the maximum number of shots is 5; if a higher value was selected in Step 1, the number of shots will automatically be set to 5.

3 Frame a photograph, focus, and shoot.



The camera will vary exposure and/or flash level shot-by-shot according to the bracketing program selected. Modifications to exposure are added to those made with exposure compensation (see page 143).

While bracketing is in effect, a bracketing progress indicator will be displayed in the viewfinder and top control panel. A segment will disappear from the indicator after each shot.

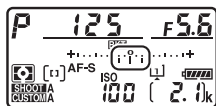

No. shots: 3; increment: 0.7

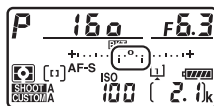

Display after first shot

■ Canceling Bracketing

To cancel bracketing, press the **BKT** button and rotate the main command dial until the number of shots in the bracketing sequence is zero (**0F**) and **BKT** is no longer displayed. The program last in effect will be restored the next time bracketing is activated. Bracketing can also be cancelled by performing a two-button reset (□ 224), although in this case the bracketing program will not be restored the next time bracketing is activated.

■ See Also

For information on choosing the size of the exposure increment, see Custom Setting b2 (**EV steps for exposure cntrl**, □ 301). For information on choosing the order in which bracketing is performed, see Custom Setting e7 (**Bracketing order**, □ 307). For information on choosing the role of the **BKT** button, see Custom Setting f1 (**Custom control assignment**) > **BKT button** +  (□ 307).

Exposure and Flash Bracketing

In continuous low speed, continuous high speed, and quiet continuous modes, shooting will pause after the number of shots specified in the bracketing program have been taken. Shooting will resume the next time the shutter-release button is pressed. In self-timer mode, the camera will take the number of shots selected in Step 1 on page 147 each time the shutter-release button is pressed, regardless of the option selected for Custom Setting c3 (**Self-timer**) > **Number of shots** (☐ 303); the interval between shots is however controlled by Custom Setting c3 (**Self-timer**) > **Interval between shots**. In other modes, one shot will be taken each time the shutter-release button is pressed.

If the memory card fills before all shots in the sequence have been taken, shooting can be resumed from the next shot in the sequence after the memory card has been replaced or shots have been deleted to make room on the memory card. If the camera is turned off before all shots in the sequence have been taken, bracketing will resume from the next shot in the sequence when the camera is turned on.

Exposure Bracketing

The camera modifies exposure by varying shutter speed and aperture (programmed auto), aperture (shutter-priority auto), or shutter speed (aperture-priority auto, manual exposure mode). If **On** is selected for **ISO sensitivity settings > Auto ISO sensitivity control** (☐ 126) in modes **P**, **S**, and **A**, the camera will automatically vary ISO sensitivity for optimum exposure when the limits of the camera exposure system are exceeded; in mode **M**, the camera will first use auto ISO sensitivity control to bring exposure as close as possible to the optimum and then bracket this exposure by varying shutter speed. Custom Setting e6 (**Auto bracketing (mode M)**, ☐ 307) can be used to change how the camera performs exposure and flash bracketing in manual exposure mode. Bracketing can be performed by varying flash level together with shutter speed and/or aperture, or by varying flash level alone.



■ ■ White Balance Bracketing

The camera creates multiple copies of each photograph, each with a different white balance.

1 Choose the number of shots.

Pressing the **BKT** button, rotate the main command dial to choose the number of shots in the bracketing sequence. The number of shots is shown in the top control panel.

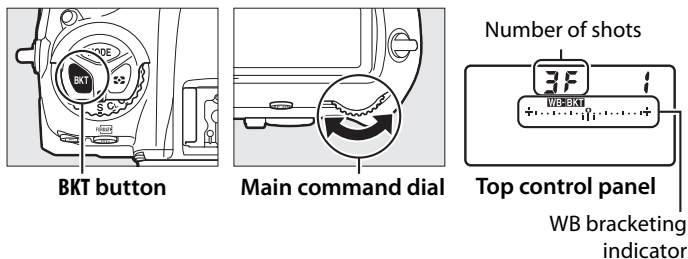

At settings other than zero, a **WB-BKT** icon and WB bracketing indicator will appear in the top control panel and **BKT** will be displayed in the viewfinder.



2 Select a white balance increment.

Pressing the **BKT** button, rotate the sub-command dial to choose the white balance adjustment. Each increment is roughly equivalent to 5 mired.

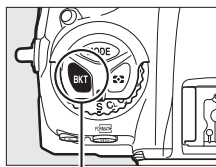

BKT button

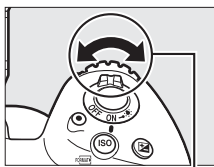

Sub-command dial

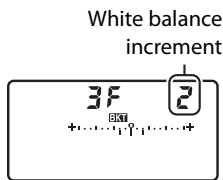

Top control panel

Choose from increments of 1 (5 mired), 2 (10 mired), or 3 (15 mired). Higher **B** values correspond to increased amounts of blue, higher **A** values to increased amounts of amber (162). The bracketing programs with an increment of 1 are listed below.

Control panel display	No. of shots	White balance increment	Bracketing order
0F 1 +.....°.....+	0	1	0
b3F 1 +.....:.....+	3	1 B	0 / 1 B / 2 B
A3F 1 +.....:.....+	3	1 A	0 / 2 A / 1 A
b2F 1 +.....:.....+	2	1 B	0 / 1 B
A2F 1 +.....:.....+	2	1 A	0 / 1 A
3F 1 +.....:.....+	3	1 A, 1 B	0 / 1 A / 1 B
5F 1 +.....:.....+	5	1 A, 1 B	0 / 2 A / 1 A / 1 B / 2 B
7F 1 +.....:.....+	7	1 A, 1 B	0 / 3 A / 2 A / 1 A / 1 B / 2 B / 3 B
9F 1 +.....:.....+	9	1 A, 1 B	0 / 4 A / 3 A / 2 A / 1 A / 1 B / 2 B / 3 B / 4 B

See Also

See page 164 for a definition of “mired.”

3 Frame a photograph, focus, and shoot.



Each shot will be processed to create the number of copies specified in the bracketing program, and each copy will have a different white balance. Modifications to white balance are added to the white balance adjustment made with white balance fine-tuning.

If the number of shots in the bracketing program is greater than the number of exposures remaining, **FuLL** and the icon for the affected card will flash in the top control panel, a flashing **FuL** icon will appear in the viewfinder as shown at right, and the shutter release will be disabled.

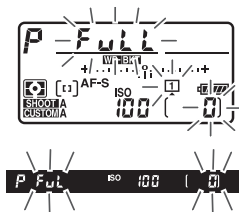

Shooting can begin when a new memory card is inserted.



■ ■ *Canceling Bracketing*

To cancel bracketing, press the **BKT** button and rotate the main command dial until the number of shots in the bracketing sequence is zero (0 F) and **WB-BKT** is no longer displayed. The program last in effect will be restored the next time bracketing is activated. Bracketing can also be cancelled by performing a two-button reset (☐ 224), although in this case the bracketing program will not be restored the next time bracketing is activated.



White Balance Bracketing

White balance bracketing is not available at an image quality of NEF (RAW). Selecting an NEF (RAW) or NEF (RAW) + JPEG option cancels white balance bracketing.

White balance bracketing affects only color temperature (the amber-blue axis in the white balance fine-tuning display, ☐ 162). No adjustments are made on the green-magenta axis.

In self-timer mode, the number of copies specified in the bracketing program will be created each time the shutter is released, regardless of the option selected for Custom Setting c3 (**Self-timer**) > **Number of shots** (☐ 303).

If the camera is turned off while the memory card access lamp is lit, the camera will power off only after all photographs in the sequence have been recorded.

■ ■ ADL Bracketing

The camera varies Active D-Lighting over a series of exposures.

1 Choose the number of shots.

Pressing the **BKT** button, rotate the main command dial to choose the number of shots in the bracketing sequence. The number of shots is shown in the top control panel.

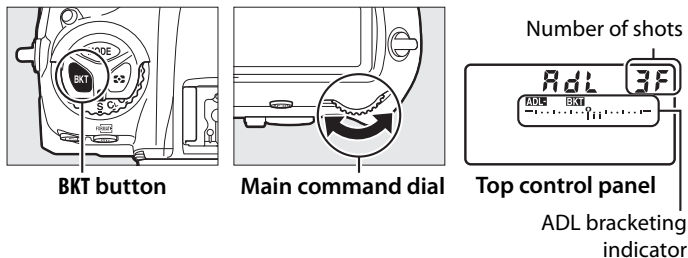

At settings other than zero, a **ADL-BKT** icon and an ADL bracketing indicator appear in the top control panel and **BKT** will be displayed in the viewfinder. Choose two shots to take one photograph with Active D-Lighting off and another at a selected value. Choose three to five shots to take a series of photographs with Active D-Lighting set successively to values between **Off** and **Normal** (three shots), between **Off** and **High** (four shots), or between **Off** and **Extra high 1** or **Low** and **Extra high 2** (five shots). If you choose more than two shots, proceed to Step 3.



2 Select Active D-Lighting.

Pressing the **BKT** button, rotate the sub-command dial to choose Active D-Lighting.

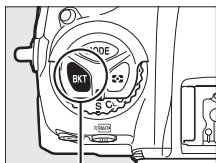

BKT button

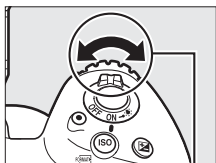

Sub-command dial

Active D-Lighting is shown in the top control panel.

Control panel display	ADL	Control panel display	ADL
The control panel display shows 'AdL 2F' at the top. Below it is a horizontal bar with a scale from 0 to 100. A small 'A' icon is visible on the left side of the bar. At the bottom of the display is a button with the letter 'A'.	暗A Auto	The control panel display shows 'AdL 2F' at the top. Below it is a horizontal bar with a scale from 0 to 100. A small 'H' icon is visible on the left side of the bar. At the bottom of the display is a button with the letter 'H'.	暗H High
The control panel display shows 'AdL 2F' at the top. Below it is a horizontal bar with a scale from 0 to 100. A small 'L' icon is visible on the left side of the bar. At the bottom of the display is a button with the letter 'L'.	暗L Low	The control panel display shows 'AdL 2F' at the top. Below it is a horizontal bar with a scale from 0 to 100. A small 'H1' icon is visible on the left side of the bar. At the bottom of the display is a button with the letters 'H1'.	暗H1 Extra high 1
The control panel display shows 'AdL 2F' at the top. Below it is a horizontal bar with a scale from 0 to 100. A small 'n' icon is visible on the left side of the bar. At the bottom of the display is a button with the letter 'n'.	暗N Normal	The control panel display shows 'AdL 2F' at the top. Below it is a horizontal bar with a scale from 0 to 100. A small 'H2' icon is visible on the left side of the bar. At the bottom of the display is a button with the letters 'H2'.	暗H2 Extra high 2

3 Frame a photograph, focus, and shoot.



The camera will vary Active D-Lighting shot-by-shot according to the bracketing program selected. While bracketing is in effect, a bracketing progress indicator will be displayed in the top control panel. A segment will disappear from the indicator after each shot.

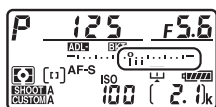

No. shots: 3

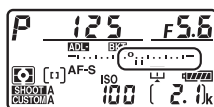

Display after first shot



■ ■ *Canceling Bracketing*

To cancel bracketing, press the **BKT** button and rotate the main command dial until the number of shots in the bracketing sequence is zero (0) and **ADL-BKT** is no longer displayed. The program last in effect will be restored the next time bracketing is activated. Bracketing can also be cancelled by performing a two-button reset (☐ 224), although in this case the bracketing program will not be restored the next time bracketing is activated.

ADL Bracketing





In continuous low speed, continuous high speed, and quiet continuous modes, shooting will pause after the number of shots specified in the bracketing program have been taken. Shooting will resume the next time the shutter-release button is pressed. In self-timer mode, the camera will take the number of shots selected in Step 1 on page 155 each time the shutter-release button is pressed, regardless of the option selected for Custom Setting c3 (**Self-timer**) > **Number of shots** (☐ 303); the interval between shots is however controlled by Custom Setting c3 (**Self-timer**) > **Interval between shots**. In other modes, one shot will be taken each time the shutter-release button is pressed.

If the memory card fills before all shots in the sequence have been taken, shooting can be resumed from the next shot in the sequence after the memory card has been replaced or shots have been deleted to make room on the memory card. If the camera is turned off before all shots in the sequence have been taken, bracketing will resume from the next shot in the sequence when the camera is turned on.

White Balance

White Balance Options

White balance ensures that colors are unaffected by the color of the light source. Auto white balance is recommended with most light sources. If the desired results can not be achieved with auto white balance, choose an option from the list below or use preset white balance.

Option	Color temp. *	Description
AUTO Auto	3500–8000 K	White balance is adjusted automatically. For best results, use type G, E or D lens. If optional flash fires, results are adjusted appropriately. Color temperature can be viewed in the playback info display after shooting (☐ 254).
Keep white (reduce warm colors)		
Normal		
Keep warm lighting colors		
 Incandescent	3000 K	Use under incandescent lighting.
 Fluorescent		Use with:
Sodium-vapor lamps	2700 K	• Sodium-vapor lighting (found in sports venues).
Warm-white fluorescent	3000 K	• Warm-white fluorescent lights.
White fluorescent	3700 K	• White fluorescent lights.
Cool-white fluorescent	4200 K	• Cool-white fluorescent lights.
Day white fluorescent	5000 K	• Daylight white fluorescent lights.
Daylight fluorescent	6500 K	• Daylight fluorescent lights.
High temp. mercury-vapor	7200 K	• High color temperature light sources (e.g. mercury-vapor lamps).

Option	Color temp.*	Description
Direct sunlight	5200 K	Use with subjects lit by direct sunlight.
Flash	5400 K	Use with optional flash units.
Cloudy	6000 K	Use in daylight under overcast skies.
Shade	8000 K	Use in daylight with subjects in the shade.
Choose color temp.	2500–10,000 K	Choose color temperature from list of values (📖 165).
PRE Preset manual	—	Use subject, light source, or existing photograph as reference for white balance (📖 168).

* All values are approximate and do not reflect fine-tuning (if applicable).

White balance can be selected by pressing the **WB** button and rotating the main command dial until the desired setting is displayed in the rear control panel.

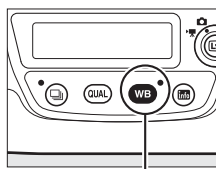

WB button

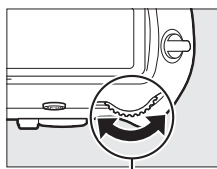

Main command dial

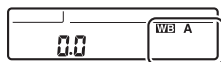

Rear control panel



The Photo Shooting Menu

White balance can also be adjusted using the **White balance** option in the photo or movie shooting menu (📖 293, 297), which also can be used to fine-tune white balance (📖 162) or manage white-balance presets (📖 168). The **Auto** option in the **White balance** menu offers a choice of **Keep white (reduce warm colors)**,

Normal, and **Keep warm lighting colors**. **Keep white (reduce warm colors)** makes whites recorded under incandescent lighting appear white, while **Keep warm lighting colors** preserves the warm tints we normally perceive under incandescent lighting. The **Fluorescent** option can be used to select the light source from the bulb types.



Studio Flash Lighting

Auto white balance may not produce the desired results with large studio flash units. Use preset white balance or set white balance to **Flash** and use fine-tuning to adjust white balance.













Color Temperature

The perceived color of a light source varies with the viewer and other conditions. Color temperature is an objective measure of the color of a light source, defined with reference to the temperature to which an object would have to be heated to radiate light in the same wavelengths. While light sources with a color temperature in the neighborhood of 5000–5500 K appear white, light sources with a lower color temperature, such as incandescent light bulbs, appear slightly yellow or red. Light sources with a higher color temperature appear tinged with blue.

“Warmer” (redder) colors

“Cooler” (bluer) colors



①	 (sodium-vapor lamps): 2700 K	⑥	 (direct sunlight): 5200 K
②	 (incandescent)/  (warm-white fluorescent.): 3000 K	⑦	 (flash): 5400 K
③	 (white fluorescent): 3700 K	⑧	 (cloudy): 6000 K
④	 (cool-white fluorescent): 4200 K	⑨	 (daylight fluorescent): 6500 K
⑤	 (day white fluorescent): 5000 K	⑩	 (high temp. mercury-vapor): 7200 K
		⑪	 (shade): 8000 K

Note: All figures are approximate.

See Also

White balance bracketing (📖 151) creates several copies of each photograph taken, varying white balance to “bracket” the current value.

Fine-Tuning White Balance

At settings other than **☑ (Choose color temp.)**, white balance can be “fine-tuned” to compensate for variations in the color of the light source or to introduce a deliberate color cast into an image.

■ ■ The White Balance Menu

To fine-tune white balance from the photo shooting menu, select **White balance** and follow the steps below.

1 Display fine-tuning options.

Highlight a white balance option and press **⏏** (if a sub-menu is displayed, select the desired option and press **⏏** again to display fine-tuning options; for information on fine-tuning preset manual white balance, see page 178).

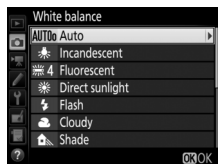

2 Fine-tune white balance.

Use the multi selector to fine-tune white balance. White balance can be fine-tuned on the amber (A)–blue (B) axis in steps of 0.5 and the green (G)–magenta (M) axis in steps of 0.25. The horizontal (amber–blue) axis corresponds to color temperature, while the vertical (green–magenta) axis has the similar effects to the corresponding color compensation (CC) filters. The horizontal axis is ruled in increments equivalent to about 5 mired, the vertical axis in increments of about 0.05 diffuse density units.

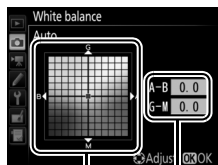

Coordinates
Adjustment

3 Press .

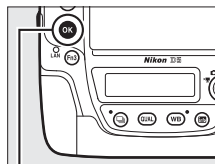

Press  to save settings and return to the photo shooting menu. If white balance has been fine-tuned, an asterisk (“*”) will be displayed in the rear control panel.

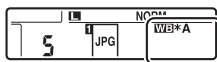

 **button**



■ ■ The WB Button

At settings other than  (**Choose color temp.**) and **PRE (Preset manual)**, the **WB** button can be used to fine-tune white balance on the amber (A)–blue (B) axis ( 162; to fine-tune white balance when **PRE** is selected, use the photo shooting menu as described on page 178). Press the **WB** button and rotate the sub-command dial to fine-tune white balance in steps of 0.5 (with each full increment equivalent to about 5 mired) until the desired value is displayed in the rear control panel. Rotating the sub-command dial to the left increases the amount of amber (A). Rotating the sub-command dial to the right increases the amount of blue (B). At settings other than 0, an asterisk (“*”) appears in the rear control panel.

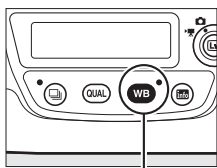

WB button

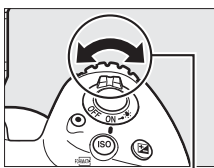

Sub-command dial

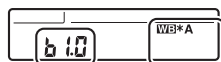

Rear control panel



The Information Display

During viewfinder photography, you can press the **WB** button to adjust white balance settings in the information display. Rotate the main command dial to choose the white balance mode and rotate the sub-command dial to choose the color temperature (mode **K**, “choose color temperature”) or white balance preset (preset manual mode), or use the multi-selector to fine-tune white balance on the amber (A)–blue (B) and green (G)–magenta (M) axes (other white balance modes).

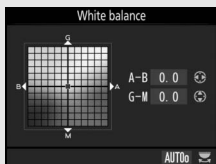

White Balance Fine-Tuning

The colors on the fine-tuning axes are relative, not absolute. For example, moving the cursor to **B** (blue) when a “warm” setting such as  (**Incandescent**) is selected for white balance will make photographs slightly “colder” but will not actually make them blue.

“Mired”

Any given change in color temperature produces a greater difference in color at low color temperatures than it would at higher color temperatures. For example, a change of 1000 K produces a much greater change in color at 3000 K than at 6000 K. Mired, calculated by multiplying the inverse of the color temperature by 10^6 , is a measure of color temperature that takes such variation into account, and as such is the unit used in color-temperature compensation filters. E.g.:

- 4000 K–3000 K (a difference of 1000 K)=83 mired
- 7000 K–6000 K (a difference of 1000 K)=24 mired

Choosing a Color Temperature

Follow the steps below to choose a color temperature when **K** (**Choose color temp.**) is selected for white balance.

☑ Choose Color Temperature

Note that the desired results will not be obtained with flash or fluorescent lighting. Choose **⚡ (Flash)** or **☀ (Fluorescent)** for these sources. With other light sources, take a test shot to determine if the selected value is appropriate.

■ The White Balance Menu

Color temperature can be selected using the **White balance** options in the photo shooting menu. Enter values for the amber–blue and green–magenta axes as described below.

1 Select Choose color temp.

Select **White balance** in the photo shooting menu, then highlight **Choose color temp.** and press **⏎**.

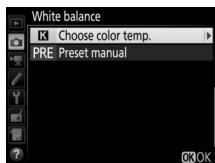

2 Select a value for amber-blue.

Press **⏎** or **⏪** to highlight digits and press **⏪** or **⏩** to change.

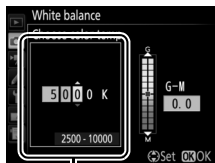

Value for amber (A)-
blue (B) axis



3 Select a value for green-magenta.

Press or to highlight the **G** (green) or **M** (magenta) axis and press or to select a value.

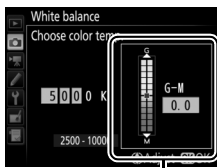

Value for green (G)-magenta (M) axis

4 Press .



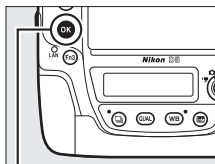

Press to save changes and return to the photo shooting menu. If a value other than 0 is selected for the green (G)-magenta (M) axis, an asterisk (“*”) will be displayed in the rear control panel.



button



■ ■ The WB Button

When **☑ (Choose color temp.)** is selected, the **WB** button can be used to select the color temperature, although only for the amber (A)–blue (B) axis. Press the **WB** button and rotate the sub-command dial until the desired value is displayed in the rear control panel (adjustments are made in mireds;  164). To enter a color temperature directly, press the **WB** button and press  or  to highlight a digit and press  or  to change.

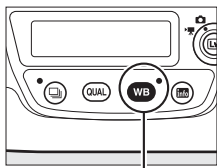

WB button

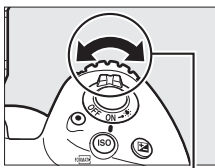

Sub-command dial



Rear control panel



Preset Manual

Preset manual is used to record and recall custom white balance settings for shooting under mixed lighting or to compensate for light sources with a strong color cast. The camera can store up to six values for preset white balance in presets d-1 through d-6. Two methods are available for setting preset white balance:

Method	Description
Direct measurement	Neutral gray or white object is placed under lighting that will be used in final photograph and white balance is measured by camera (☞ 169). During live view (☞ 44, 59), white balance can be measured in a selected area of the frame (spot white balance, ☞ 173).
Copy from existing photograph	White balance is copied from photo on memory card (☞ 176).



White Balance Presets

Changes to white balance presets apply to all photo shooting menu banks (☞ 291).

Viewfinder Photography

1 Light a reference object.

Place a neutral gray or white object under the lighting that will be used in the final photograph. In studio settings, a standard gray panel can be used as a reference object. Note that exposure is automatically increased by 1 EV when measuring white balance; in exposure mode **M**, adjust exposure so that the exposure indicator shows ± 0 (☞ 137).

2 Set white balance to PRE (Preset manual).

Press the **WB** button and rotate the main command dial until **PRE** is displayed in the rear control panel.

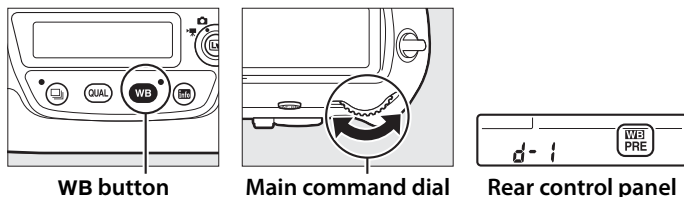

Measuring Preset Manual White Balance (Viewfinder Photography)

Preset manual white balance can not be measured while you are shooting an HDR photograph (☞ 189) or multiple exposure (☞ 229), or if **Record movies** is selected for Custom Setting g1 (**Custom control assignment**) > **Shutter-release button** (☞ 309) and the live view selector is rotated to  during live view.

3 Select a preset.

Press the **WB** button and rotate the sub-command dial until the desired white balance preset (d-1 to d-6) is displayed in the rear control panel.

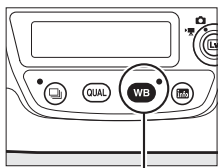

WB button

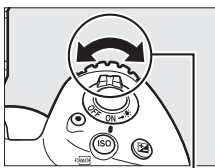

Sub-command dial

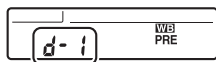

Rear control panel

4 Select direct measurement mode.

Release the **WB** button briefly and then press the button until the **PRE** icon in the rear control panel starts to flash. A flashing **P-r-E** will also appear in the top control panel and viewfinder.

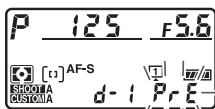

Top control panel



Rear control panel



Viewfinder

5 Measure white balance.

In the few seconds before the indicators stop flashing, frame the reference object so that it fills the viewfinder and press the shutter-release button all the way down. The camera will measure a value for white balance and store it in the preset selected in Step 3. No photograph will be recorded; white balance can be measured accurately even when the camera is not in focus.



6 Check the results.

If the camera was able to measure a value for white balance, **Good** will flash in the control panels, while the viewfinder will show a flashing **Good**. Press the shutter-release button halfway to exit to shooting mode.



Top control panel



Rear control panel



Viewfinder

If lighting is too dark or too bright, the camera may be unable to measure white balance. A flashing **no Good** will appear in the control panels and viewfinder. Press the shutter-release button halfway to return to Step 5 and measure white balance again.

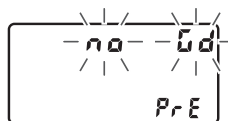

Top control panel



Rear control panel



Viewfinder



✔ **Direct Measurement Mode**

If no operations are performed during viewfinder photography while the displays are flashing, direct measurement mode will end in the time selected for Custom Setting c2 (**Standby timer**, 303).

✍ **Protected Presets**

If the current preset is protected (178), **P** will flash in the top control panel and viewfinder (and **OK** in the rear control panel) if you attempt to measure a new value.

✍ **Selecting a Preset**

Selecting **Preset manual** for the **White balance** option in the photo shooting menu displays the dialog shown at right; highlight a preset and press **OK**. If no value currently exists for the selected preset, white balance will be set to 5200 K, the same as **Direct sunlight**.



Live View (Spot White Balance)

During live view (☐ 44, 59), white balance can be measured in a selected area of the frame, eliminating the need to prepare a reference object or change lenses during telephoto photography.

1 Press the **Lv** button.

The mirror will be raised and the view through the lens will be displayed in the camera monitor.

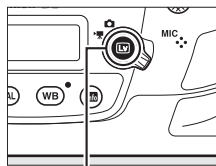

Lv button

2 Set white balance to PRE (Preset manual).

Press the **WB** button and rotate the main command dial until **PRE** is displayed in the rear control panel.

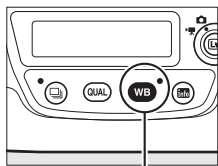

WB button



Main command dial

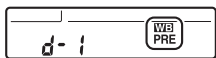

Rear control panel

3 Select a preset.

Press the **WB** button and rotate the sub-command dial until the desired white balance preset (d-1 to d-6) is displayed in the rear control panel.

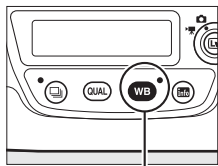

WB button

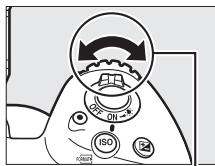

Sub-command dial

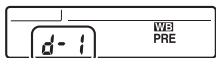

Rear control panel



4 Select direct measurement mode.

Release the **WB** button briefly and then press the button until the **PRE** icon in the rear control panel starts to flash. A spot white balance target (□) will be displayed at the selected focus point.

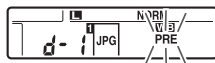

Rear control panel

5 Position the target over a white or grey area.

While **PRE** flashes in the display, use the multi selector to position the □ over a white or grey area of the subject. To zoom the area around the target in for more precise positioning, press the **Q** button. You can also measure white balance anywhere in the frame by tapping your subject in the monitor, in which case there is no need to press the center of the multi selector or the shutter-release button as described in Step 6.



6 Measure white balance.

Press the center of the multi selector or press the shutter-release button all the way down to measure white balance. The time available to measure white balance is that selected for Custom Setting c4 (**Monitor off delay**) > **Live view** (□ 303).



If the camera is unable to measure white balance, the message shown at right will be displayed. Choose a new white balance target and repeat the process from Step 5.



7 Exit direct measurement mode.

Press the **WB** button to exit direct measurement mode.

White balance presets can be viewed by selecting **Preset manual** for **White balance** in the photo or movie shooting menu. The position of the targets used to measure preset white balance is displayed on presets recorded during live view.



Measuring Preset Manual White Balance (Live View)

Preset manual white balance can not be measured while an HDR exposure is in progress (□ 189), when **None** is selected for **Photo live view display WB** (□ 52), or if **Record movies** is selected for Custom Setting g1 (**Custom control assignment**) > **Shutter-release button** (□ 309) and the live view selector is rotated to **📷**.

Managing Presets

■ Copying White Balance from a Photograph

Follow the steps below to copy a value for white balance from an existing photograph to a selected preset.

1 Select Preset manual.

Select **White balance** in the photo shooting menu, then highlight **Preset manual** and press .

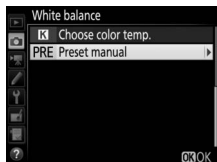

2 Select a destination.

Highlight the destination preset (d-1 to d-6) and press the center of the multi-selector.





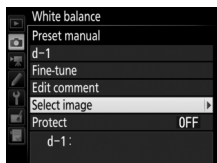

3 Choose Select image.

Highlight **Select image** and press .





4 Highlight a source image.

Highlight the source image. To view the highlighted image full frame, press and hold the  button.

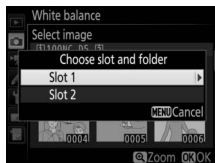
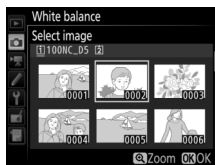

To view images in other locations, press  () and select the desired card and folder ( 249).



5 Copy white balance.

Press  to copy the white balance value for the highlighted photograph to the selected preset. If the highlighted photograph has a comment ( 311), the comment will be copied to the comment for the selected preset.

Choosing a White Balance Preset

Press  to highlight the current white balance preset (d-1 – d-6) and press  to select another preset.

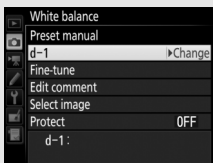

Fine-Tuning Preset White Balance

The selected preset can be fine-tuned by selecting **Fine-tune** and adjusting white balance as described on page 162.

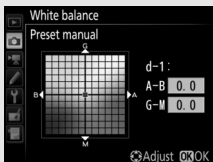

Edit Comment

To enter a descriptive comment of up to 36 characters for the current white-balance preset, select **Edit comment** in the preset manual white balance menu and enter a comment as described on page 185.



Protect

To protect the current white-balance preset, select **Protect** in the preset manual white balance menu, then highlight **On** and press . Protected presets can not be modified and the **Fine-tune** and **Edit comment** options can not be used.

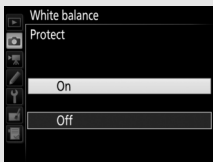









Image Enhancement

Picture Controls

Selecting a Picture Control

Choose a Picture Control according to the subject or type of scene.

Option	Description
 SD Standard	Standard processing for balanced results. Recommended for most situations.
 NL Neutral	Minimal processing for natural results. Choose for photographs that will later be processed or retouched.
 VI Vivid	Pictures are enhanced for a vivid, photoprint effect. Choose for photographs that emphasize primary colors.
 MC Monochrome	Take monochrome photographs.
 PT Portrait	Process portraits for skin with natural texture and a rounded feel.
 LS Landscape	Produces vibrant landscapes and cityscapes.
 FL Flat	Details are preserved over a wide tone range, from highlights to shadows. Choose for photographs that will later be extensively processed or retouched.



- 1** Press **Fn** (Fn/?).
A list of Picture Controls will be displayed.

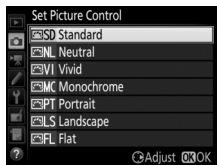
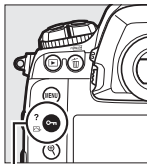

Fn (Fn/?) **button**

- 2** **Select a Picture Control.**
Highlight the desired Picture Control and press **OK**.

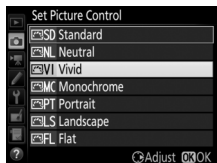
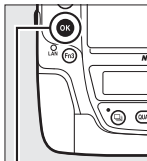

OK button

Custom Picture Controls

Custom Picture Controls are created through modifications to existing Picture Controls using the **Manage Picture Control** option in the photo or movie shooting menu (☞ 184). Custom Picture Controls can be saved to a memory card for sharing among other cameras of the same model and compatible software.

The Picture Control Indicator

The current Picture Control is shown in the information display when the **info** button is pressed.



Picture Control indicator

The Shooting Menus

Picture Controls can also be selected using the **Set Picture Control** option in the photo or movie shooting menu (☞ 293, 297).

Modifying Picture Controls





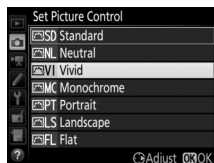

Existing preset or custom Picture Controls (☞ 184) can be modified to suit the scene or the user's creative intent. Choose a balanced combination of settings using **Quick adjust**, or make manual adjustments to individual settings.

1 Select a Picture Control.

Highlight the desired Picture Control in the Picture Control list (☞ 179) and press .



2 Adjust settings.

Press  or  to highlight the desired setting and press  or  to choose a value in increments of 1, or rotate the sub-command dial to choose a value in increments of 0.25 (☞ 182). Repeat this step until all settings have been adjusted, or select a preset combination of settings by highlighting **Quick adjust** and pressing  or . Default settings can be restored by pressing the  (**FORMAT**) button.



3 Press .

Modifications to Original Picture Controls

Picture Controls that have been modified from default settings are indicated by an asterisk ("*****") in the **Set Picture Control** menu.

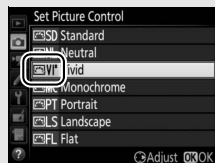

Picture Control Settings

Option	Description	
Quick adjust	Mute or heighten the effect of the selected Picture Control (note that this resets all manual adjustments). Not available with Neutral , Monochrome , Flat , or custom Picture Controls (☞ 184).	
Manual adjustments (all Picture Controls)	Sharpening	Control the sharpness of outlines. Select A to adjust sharpening automatically according to the type of scene.
	Clarity	Adjust clarity manually or select A to let the camera adjust clarity automatically. Depending on the scene, shadows may appear around bright objects or halos may appear around dark objects at some settings. Clarity is not applied to movies.
	Contrast	Adjust contrast manually or select A to let the camera adjust contrast automatically.
	Brightness	Raise or lower brightness without loss of detail in highlights or shadows.
Manual adjustments (non-monochrome only)	Saturation	Control the vividness of colors. Select A to adjust saturation automatically according to the type of scene.
	Hue	Adjust hue.
Manual adjustments (monochrome only)	Filter effects	Simulate the effect of color filters on monochrome photographs (☞ 183).
	Toning	Choose the tint used in monochrome photographs (☞ 183).



✔ "A" (Auto)

Results for auto sharpening, clarity, contrast, and saturation vary with exposure and the position of the subject in the frame. Use a type G, E, or D lens for best results.

✎ Switching Between Manual and Auto

Press the  button to switch back and forth between manual and auto (A) settings for sharpening, clarity, contrast, and saturation.

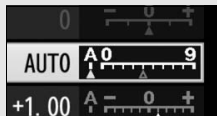

✎ Previous Settings

The  indicator under the value display in the Picture Control setting menu indicates the previous value for the setting. Use this as a reference when adjusting settings.



✎ Filter Effects (Monochrome Only)



The options in this menu simulate the effect of color filters on monochrome photographs. The following filter effects are available:

Option	Description
Y	Yellow
O	Orange
R	Red
G	Green

Enhances contrast. Can be used to tone down the brightness of the sky in landscape photographs. Orange produces more contrast than yellow, red more contrast than orange.

Softens skin tones. Can be used for portraits.

✎ Toning (Monochrome Only)

Pressing  when **Toning** is selected displays saturation options. Press  or  to adjust saturation. Saturation control is not available when **B&W** (black-and-white) is selected.



✎ Custom Picture Control Options

The options available with custom Picture Controls are the same as those on which the custom Picture Control was based.



Creating Custom Picture Controls

The Picture Controls supplied with the camera can be modified and saved as custom Picture Controls.

1 Select Manage Picture Control.

Highlight **Manage Picture Control** in the photo shooting menu and press **OK**.

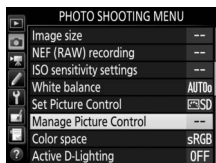

2 Select Save/edit.

Highlight **Save/edit** and press **OK**.

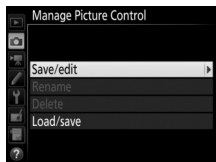

3 Select a Picture Control.

Highlight an existing Picture Control and press **OK**, or press **OK** to proceed to Step 5 to save a copy of the highlighted Picture Control without further modification.

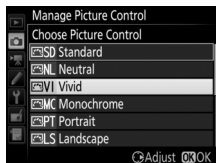

4 Edit the selected Picture Control.

See page 182 for more information. To abandon any changes and start over from default settings, press the **FORMAT** button. Press **OK** when settings are complete.



5 Select a destination.



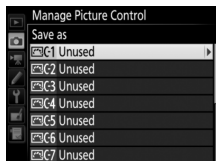

Choose a destination for the custom Picture Control (C-1 through C-9) and press **OK**.

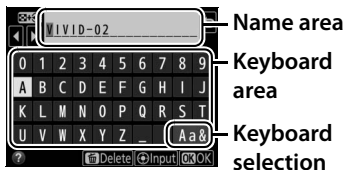

6 Name the Picture Control.

The text-entry dialog shown at right will be displayed. By default, new Picture Controls are named



by adding a two-digit number (assigned automatically) to the name of the existing Picture Control; to use the default name, proceed to Step 7. To move the cursor in the name area, tap the display or hold the  button and press  or . To enter a new letter at the current cursor position, tap the letters on the touch-screen keyboard (tap the keyboard selection button to cycle through the upper-case, lower-case, and symbol keyboards). You can also use the multi selector to highlight the desired character in the keyboard area and press the center of the multi selector. To delete the character at the current cursor position, press the  () button.

Custom Picture Control names can be up to nineteen characters long. Any characters after the nineteenth will be deleted.

7 Save changes and exit.

Press  to save changes and exit. The new Picture Control will appear in the Picture Control list.

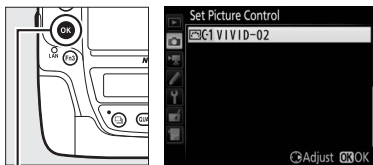

 button

Manage Picture Control > Rename

Custom Picture Controls can be renamed at any time using the **Rename** option in the **Manage Picture Control** menu.

Manage Picture Control > Delete

The **Delete** option in the **Manage Picture Control** menu can be used to delete selected custom Picture Controls when they are no longer needed.

The Original Picture Control Icon

The original preset Picture Control on which the custom Picture Control is based is indicated by an icon in the top right corner of the edit display.

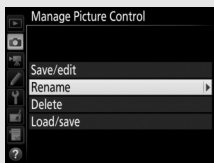

Original Picture Control icon



Sharing Custom Picture Controls

The **Load/save** item in the **Manage Picture Control** menu offers the options listed below. Use these options to copy custom Picture Controls to and from memory cards (these options are available only with the memory card in Slot 1 and can not be used with the card in Slot 2). Once copied to memory cards, Picture Controls can be used with other cameras or compatible software.

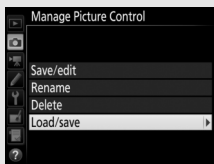

- **Copy to camera:** Copy custom Picture Controls from the memory card to custom Picture Controls C-1 through C-9 on the camera and name them as desired.
- **Delete from card:** Delete selected custom Picture Controls from the memory card.
- **Copy to card:** Copy a custom Picture Control (C-1 through C-9) from the camera to a selected destination (1 through 99) on the memory card.

Preserving Detail in Highlights and Shadows

Active D-Lighting

Active D-Lighting preserves details in highlights and shadows, creating photographs with natural contrast. Use for high contrast scenes, for example when photographing brightly lit outdoor scenery through a door or window or taking pictures of shaded subjects on a sunny day. It is most effective when used with matrix metering (📖 129).



Active D-Lighting off



Active D-Lighting: 暗 A Auto



“Active D-Lighting” versus “D-Lighting”

The **Active D-Lighting** option in the photo shooting menu adjusts exposure before shooting to optimize the dynamic range, while the **D-Lighting** option in the retouch menu (📖 314) brightens shadows in images after shooting.





To use Active D-Lighting:

1 Select Active D-Lighting.

Highlight **Active D-Lighting** in the photo shooting menu and press .



2 Choose an option.

Highlight the desired option and press . If  **Auto** is selected, the camera will automatically adjust Active D-Lighting according to shooting conditions (in exposure mode **M**, however,  **Auto** is equivalent to  **Normal**).



Active D-Lighting

Active D-Lighting can not be used with movies. Noise (randomly-spaced bright pixels, fog, or lines) may appear in photographs taken with Active D-Lighting. Uneven shading may be visible with some subjects.

See Also

When **ADL bracketing** is selected for **Auto bracketing set** in photo shooting menu (📖 146), the camera varies Active D-Lighting over a series of shots (📖 155).

High Dynamic Range (HDR)

Used with high-contrast subjects, High Dynamic Range (HDR) preserves details in highlights and shadows by combining two shots taken at different exposures. HDR is most effective when used with matrix metering (☐ 129; with spot or center-weighted metering and a non-CPU lens, an exposure differential of **Auto** is equivalent to about 2 EV). It can not be used to record NEF (RAW) images. Flash lighting (☐ 194), bracketing (☐ 146), multiple exposure (☐ 229), and time lapse (☐ 74) can not be used while HDR is in effect and shutter speeds of $\frac{1}{2000}$ and $\frac{1}{4000}$ are not available.



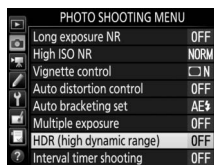

- Select HDR (high dynamic range).** Highlight **HDR (high dynamic range)** in the photo shooting menu and press \blacktriangleright .

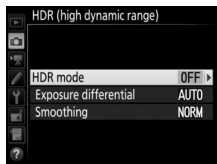

2 Select a mode.

Highlight **HDR mode** and press .



Highlight one of the following and press .

- **To take a series of HDR photographs**, select **ON  On (series)**. HDR shooting will continue until you select **Off** for **HDR mode**.
- **To take one HDR photograph**, select **On (single photo)**. Normal shooting will resume automatically after you have created a single HDR photograph.
- **To exit without creating additional HDR photographs**, select **Off**.

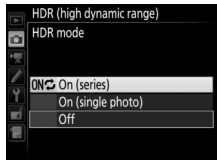

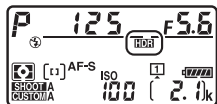

If **On (series)** or **On (single photo)** is selected, a  icon will be displayed in the top control panel.

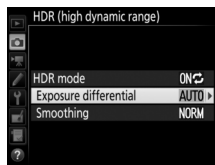

3 Choose the exposure differential.

To choose the difference in exposure between the two shots, highlight **Exposure differential** and press .



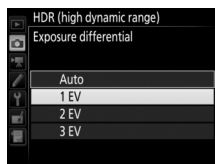

The options shown at right will be displayed. Highlight an option and press . Choose higher values for high-contrast subjects, but note that choosing a value higher than required may not produce the desired results; if **Auto** is selected, the camera will automatically adjust exposure to suit the scene.

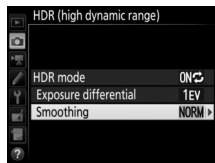

4 Choose the amount of smoothing.

To choose how much the boundaries between the two images are smoothed, highlight **Smoothing** and press .



The options shown at right will be displayed. Highlight an option and press . Higher values produce a smoother composite image. Uneven shading may be visible with some subjects.



5 Frame a photograph, focus, and shoot.

The camera takes two exposures when the shutter-release button is pressed all the way down. “Job HDR” will flash in the top control panel and *Job Hdr* in the viewfinder while the images are combined; no photographs can be taken until recording is complete. Regardless of the option currently selected for release mode, only one photograph will be taken each time the shutter-release button is pressed.

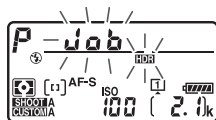

Top control panel



Viewfinder



If **On (series)** is selected, HDR will only turn off when **Off** is selected for **HDR mode**; if **On (single photo)** is selected, HDR turns off automatically after the photograph is taken. The HDR icon clears from the display when HDR shooting ends.



Framing HDR Photographs

The edges of the image will be cropped out. The desired results may not be achieved if the camera or subject moves during shooting. Use of a tripod is recommended. Depending on the scene, the effect may not be visible, shadows may appear around bright objects, or halos may appear around dark objects; this effect can be reduced by adjusting the amount of smoothing.

The BKT Button

If **HDR (high dynamic range)** is selected for Custom Setting f1 (**Custom control assignment**) > **BKT button** +  (☐ 307), you can select the HDR mode by pressing the **BKT** button and rotating the main command dial and the exposure differential by pressing the **BKT** button and rotating the sub-command dial. The mode and exposure differential are shown in the top control panel: the icons representing the mode are  **FF** for **Off**,  for **On (single photo)**, and  for **On (series)**.



Interval Timer Photography

If **On (series)** is selected for **HDR mode** before interval timer shooting begins, the camera will continue to shoot HDR photographs at the selected interval (if **On (single photo)** is selected, interval timer shooting will end after a single shot).

Photo Shooting Menu Banks

HDR settings can be adjusted separately for each bank (☐ 291), but switching to a bank in which HDR is active during multiple exposure (☐ 229) or interval timer shooting (☐ 236) disables HDR. HDR is also disabled if you switch to a bank in which an NEF (RAW) option is selected for image quality.



Flash Photography

To take photos with a flash, attach an optional flash unit (☑ 330) to the camera accessory shoe. You can also use one or more remote flash units for off-camera flash photography. For information on using flash units, see the documentation provided with the device.

Using a Flash

Follow the steps below to mount an optional flash unit on the camera and take photographs using the flash.

1 Mount the unit on the accessory shoe.

See the manual provided with the unit for details.

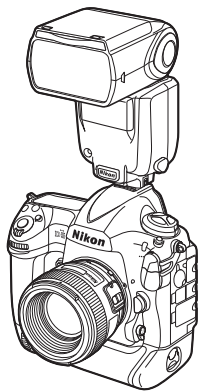

2 Turn on the camera and flash unit.

The flash will begin charging; the flash-ready indicator (⚡) will be displayed in the viewfinder when charging is complete.



3 Adjust flash settings.

Choose the flash mode (☐ 198) and flash control mode (☐ 197).

4 Adjust shutter speed and aperture.

5 Take pictures.

☑ Use Only Nikon Flash Accessories

Use only Nikon flash units. Negative voltages or voltages over 250 V applied to the accessory shoe could not only prevent normal operation, but damage the sync circuitry of the camera or flash. Before using a Nikon flash unit not listed in this section, contact a Nikon-authorized service representative for more information.

✎ Shutter Speed

Shutter speed can be set as follows when an optional flash unit is used:

Mode	Shutter speed
P, A	Set automatically by camera ($1/250$ s– $1/60$ s) *
S	Value selected by user ($1/250$ s–30 s)
M	Value selected by user ($1/250$ s–30 s, Bulb (♣ ♣ ♣), Time (- -))

* Shutter speed may be set as slow as 30 s if slow sync, slow rear-curtain sync, or slow sync with red-eye reduction is selected for flash mode.

✎ The Sync Terminal

A sync cable can be connected to the sync terminal as required. Do not connect another flash unit via a sync cable when performing rear-curtain sync flash photography with a flash unit mounted on the camera accessory shoe.

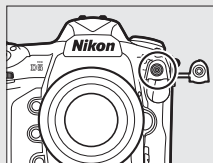

Unified Flash Control

Unified flash control allows the camera and flash unit to share settings. If a flash unit that supports unified flash control is mounted on the camera, changes to flash settings made with either the camera or flash unit are reflected on both devices, as are changes made using optional Camera Control Pro 2 software.

i-TTL Flash Control

When a CLS-compatible flash unit is set to TTL, the camera automatically selects one of the following types of flash control:

- **i-TTL balanced fill-flash for digital SLR:** Flash unit emits series of nearly invisible preflashes (monitor preflashes) immediately before main flash. Preflashes reflected from objects in all areas of frame are picked up by RGB sensor with approximately 180K (180,000) pixels and are analyzed in combination with range information from matrix metering system to adjust flash output for natural balance between main subject and ambient background lighting. If type G, E, or D lens is used, distance information is included when calculating flash output. Precision of calculation can be increased for non-CPU lenses by providing lens data (focal length and maximum aperture; see page 243). Not available when spot metering is used.
- **Standard i-TTL fill-flash for digital SLR:** Flash output adjusted to bring lighting in frame to standard level; brightness of background is not taken into account. Recommended for shots in which main subject is emphasized at expense of background details, or when exposure compensation is used. Standard i-TTL fill-flash for digital SLR is activated automatically when spot metering is selected.



On-Camera Flash Photography

When an SB-5000, SB-500, SB-400, or SB-300 is mounted on the camera, the flash control mode, flash level, and other flash settings can be adjusted using the **Flash control > Flash control mode** item in the photo shooting menu (in the case of the SB-5000, these

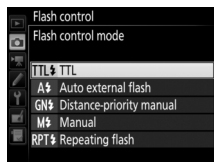







settings can also be adjusted using the controls on the flash unit). The options available vary with the flash used (□ 331), while the options displayed under **Flash control mode** vary with the mode selected. Settings for other flash units can only be adjusted using flash unit controls.

- **TTL:** i-TTL mode. In the cases of the SB-500, SB-400, and SB-300, flash compensation can be adjusted using the  button (□ 200).
- **Auto external flash:** In this mode, output is adjusted automatically according to the amount of light reflected by the subject; flash compensation is also available. Auto external flash supports “auto aperture” (⊕A) and “non-TTL auto” (A) modes; non-TTL auto is selected automatically if a non-CPU lens is attached without specifying the focal length and maximum aperture using the **Non-CPU lens data** option in the setup menu (□ 243). See the flash unit manual for details.
- **Distance-priority manual:** Choose the distance to the subject; flash output will be adjusted automatically. Flash compensation is also available.
- **Manual:** Choose the flash level manually.
- **Repeating flash:** The flash fires repeatedly while the shutter is open, producing a multiple-exposure effect. Choose the flash level (**Output**), the number of times the units fire (**Times**), and the number of times the flash fires per second (**Frequency**, measured in Hertz). Note that the number of times the units fire in total may vary depending on the options selected for **Output** and **Frequency**; see the documentation provided with the flash unit for details.



Flash Modes



The camera supports the following flash modes:

Flash mode	Description
 Front-curtain sync	This mode is recommended for most situations. In programmed auto and aperture-priority auto modes, shutter speed will automatically be set to values between $1/250$ and $1/60$ s ($1/8000$ to $1/60$ s with Auto FP High-Speed Sync;  305).
 Red-eye reduction	If flash unit supports red-eye reduction, choose this mode to reduce “red-eye” effect sometimes caused by flash. Not recommended with moving subjects or in other situations in which quick shutter response is required. Do not move camera during shooting.
 Red-eye reduction with slow sync	Combines red-eye reduction with slow sync. Use for portraits taken against a backdrop of night scenery. This mode is only available in programmed auto and aperture-priority auto exposure modes. Use of tripod is recommended to prevent blurring caused by camera shake.
 Slow sync	Flash is combined with shutter speeds as slow as 30 s to capture both subject and background at night or under dim light. This mode is only available in programmed auto and aperture-priority auto exposure modes. Use of tripod is recommended to prevent blurring caused by camera shake.
 Rear-curtain sync	In shutter-priority auto or manual exposure mode, flash fires just before the shutter closes. Use to create effect of a stream of light behind moving objects. In programmed auto and aperture-priority auto, slow rear-curtain sync is used to capture both subject and background. Use of tripod is recommended to prevent blurring caused by camera shake.
 Flash off	Flash does not fire.

■ ■ Choosing a Flash Mode

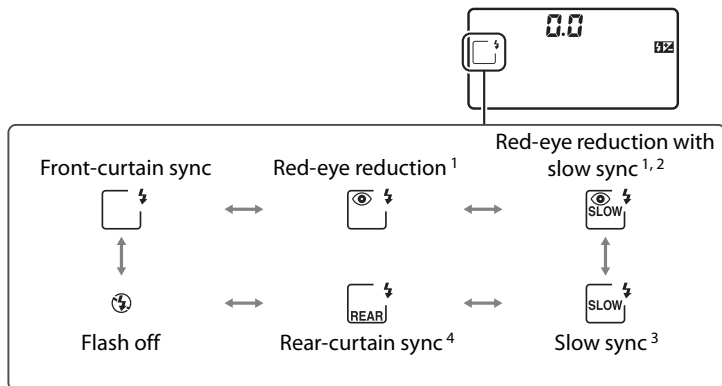
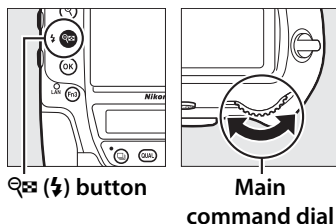
To choose the flash mode, press the  button and rotate the main command dial until the desired flash mode is selected in the top control panel:



- 1  icon flashes if flash unit does not support red-eye reduction.
- 2 Red-eye reduction with slow sync is available only in exposure modes **P** and **A**. In modes **S** and **M**, red-eye reduction with slow sync becomes red-eye reduction.
- 3 Available only in exposure modes **P** and **A**. In modes **S** and **M**, slow sync becomes front-curtain sync.
- 4 In exposure modes **P** and **A**, flash-sync mode will be set to slow rear-curtain sync when the  button is released.



■ Studio Flash Systems



Rear-curtain sync can not be used with studio flash systems, as the correct synchronization can not be obtained.

Flash Compensation

Flash compensation is used to alter flash output by from -3 EV to $+1$ EV in increments of $\frac{1}{3}$ EV, changing the brightness of the main subject relative to the background. Flash output can be increased to make the main subject appear brighter, or reduced to prevent unwanted highlights or reflections. In general, choose positive values to make the main subject brighter, negative values to make it darker.

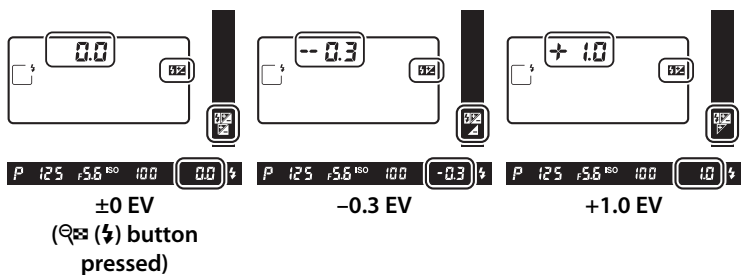
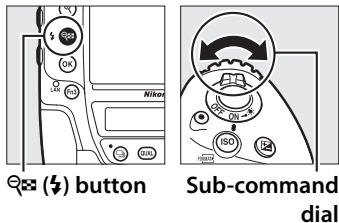

To choose a value for flash compensation, press the  button and rotate the sub-command dial until the desired value is displayed in the top control panel.





At values other than ± 0.0 , a  icon will be displayed in the top control panel and viewfinder after you release the  button. The current value for flash compensation can be confirmed by pressing the  button.

Normal flash output can be restored by setting flash compensation to ± 0.0 . Flash compensation is not reset when the camera is turned off.

Optional Flash Units

In i-TTL and auto aperture () flash control modes, the flash compensation selected with the optional flash unit or the **Flash control** option in the photo shooting menu is added to the flash compensation selected with the  button and command dial.

See Also

For information on choosing the size of the increments available for flash compensation, see Custom Setting b3 (**Exp./flash comp. step value**,  301). For information on choosing whether flash compensation is applied in addition to exposure compensation when the flash is used, see Custom Setting e3 (**Exposure comp. for flash**,  306). For information on automatically varying flash level over a series of shots, see page 147.



FV Lock

This feature is used to lock flash output, allowing photographs to be recomposed without changing the flash level and ensuring that flash output is appropriate to the subject even when the subject is not positioned in the center of the frame. Flash output is adjusted automatically for any changes in ISO sensitivity and aperture. FV lock is available with CLS compatible flash units only (📖 330).

To use FV lock:

1 Assign FV lock to a camera control.

Assign **FV lock** to a control using Custom Setting f1 (**Custom control assignment**, 📖 307).

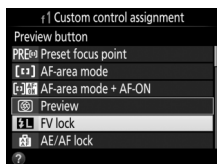

2 Attach a CLS-compatible flash unit.

Mount a CLS-compatible flash unit (📖 330) on the camera accessory shoe.

3 Set the flash unit to the appropriate mode.

Turn the flash unit on and set the flash mode to TTL, monitor pre-flash ⊗A , or monitor pre-flash A. See the documentation provided with the flash unit for details.



4 Focus.

Position the subject in the center of the frame and press the shutter-release button halfway to focus.



5 Lock flash level.

After confirming that the flash-ready indicator (⚡) is displayed in the viewfinder, press the control selected in Step 1. The flash will emit a monitor preflash to determine the appropriate flash level. Flash output will be locked at this level and FV lock icon (🔒) will appear in the viewfinder.



6 Recompose the photograph.

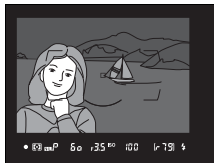

7 Take the photograph.

Press the shutter-release button the rest of the way down to shoot. If desired, additional pictures can be taken without releasing FV lock.

8 Release FV lock.

Press the control selected in Step 1 to release FV lock. Confirm that the FV lock icon (🔒) is no longer displayed in the viewfinder.

Metering

The metering areas for FV lock are as follows:

Flash unit	Flash mode	Metered area
Stand-alone flash unit	i-TTL	6-mm circle in center of frame
	⊗A	Area metered by flash exposure meter
Used with other flash units (Advanced Wireless Lighting)	i-TTL	Entire frame
	⊗A	Area metered by flash exposure meter
	A (master flash)	



Remote Flash Photography

Use remotely controlled flash units for off-camera lighting (Advanced Wireless Lighting, or AWL; □ 331). The camera supports two types of remote flash control: optical AWL, in which the master flash controls the remote flash units using optical signals (low-intensity flash pulses), and radio AWL, in which the remote flash units are controlled by means of radio signals emitted by a WR-R10 mounted on the camera. When an SB-5000 or SB-500 flash unit or a WR-R10 wireless remote controller is mounted on the camera, the remote flash control mode can be selected using the **Flash control > Wireless flash options** item in the camera photo shooting menu.

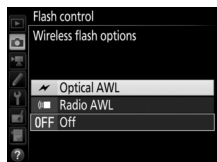

Option	Description
Optical AWL	The remote flash units are controlled using low-intensity flashes emitted by the master flash. Available only with an SB-5000 or SB-500 mounted on the camera accessory shoe and remote flash units that support optical AWL (□ 205).
Optical/radio AWL	This option is for flash photography using both optically- and radio-controlled flash units and is available when both an SB-500 and a WR-R10 are attached (for more information and for information on other flash units that support optical/radio AWL, see “Optical/Radio AWL”, □ 208). Remote flash control is automatically set to Group flash (□ 209).
Radio AWL	The remote flash units are controlled by radio signals emitted by a WR-R10 attached to the camera (□ 206). Available only with the WR-R10 and remote flash units that support radio AWL. If desired, additional lighting can be provided by a flash unit mounted on the camera accessory shoe (□ 207).
Off	Remote flash photography disabled.



Setup

This section details the steps involved in setting up a WR-R10 or a master flash mounted on the camera accessory shoe (📷) and remote flash units (📷) for wireless flash photography. More information on using optional flash units can be found in the documentation provided with the devices.

■ ■ *Optical AWL*

The following instructions assume that the master flash is an SB-5000 or SB-500. When an SB-910, SB-900, SB-800, SB-700, or SU-800 is used as a master flash, settings must be adjusted using the controls on the individual flash units; see the flash unit manuals for details.

1 📷: Connect the master flash.

Mount an SB-5000 or SB-500 on the camera accessory shoe.

2 📷: Enable optical AWL.

In the photo shooting menu, select **Optical AWL** for **Flash control** > **Wireless flash options**.

You can now take photos as described on page 209.



■ Radio AWL

Radio AWL is available with compatible remote flash units when a WR-R10 is attached to the camera.

1 Connect the WR-R10.

For more information, see the documentation provided with the WR-R10.

2 Enable radio AWL.

In the photo shooting menu, select **Radio AWL for Flash control** > **Wireless flash options**.

3 Set the WR-R10 to the desired channel.

Set the WR-R10 channel selector to the desired channel.

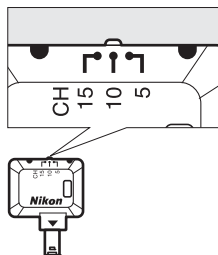

4 Choose a link mode.

Select **Wireless remote (WR) options** > **Link mode** in the setup menu (📖 312) and choose from the following options:

- **Pairing:** Pair the flash unit with the WR-R10.
- **PIN:** Connect the camera and flash unit using a four-digit PIN.

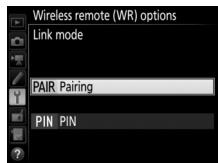

Radio AWL

A WR-A10 adapter is required when using the WR-R10. Be sure to update the WR-R10 firmware to the latest version; for information on firmware updates, see the Nikon website for your area.

5 : Establish a wireless connection.

Set the flash units to remote mode and set the devices to the channel you selected in Step 3, then pair the flash units with the WR-R10 according to the option selected in Step 4:

- **Pairing:** Initiate pairing on the flash unit and press the WR-R10 pairing button. Pairing is complete when the LINK lamps on the WR-R10 and flash unit flash orange and green; once a connection is established, the flash unit LINK lamp will light green.
- **PIN:** Use the flash unit controls to enter the PIN you selected in Step 4. The flash unit LINK lamp lights green once a connection is established.

Repeat Step 5 until all the remote flash units have been paired.

You can now take photos as described on page 209.

Reconnecting

As long as the channel, link mode, and other settings remain the same, the camera will automatically connect to previously paired flash units when you select remote mode and Steps 3–5 can be omitted. The flash unit LINK lamp lights green when a connection is established.

Radio-Controlled Flash Units

Radio-controlled flash units can be combined with any of the following flash units mounted on the camera accessory shoe:

- **SB-5000:** Before attaching the flash unit, set it to radio-controlled master flash mode (a  icon will appear at the top left corner of the display) and choose group or remote repeating flash control. Once the unit is attached, settings can be adjusted using the controls on the flash unit or the options listed in the camera menus under **Group flash options > Master flash** or under “M” in the **Remote repeating options** display.
- **SB-910, SB-900, SB-800, SB-700:** Configure the flash for stand-alone use and use the controls on the flash unit to adjust flash settings.
- **SB-500, SB-400, SB-300:** Mount the unit on the camera and adjust settings using the camera **Group flash options > Master flash** option.



■ Optical/Radio AWL

For remote flash lighting that incorporates both optically- and radio-controlled flash units, connect a WR-R10 and mount one of the following on the camera accessory shoe: an SB-500, an SB-910, SB-900, SB-800, or SB-700 configured for use as a master flash, or an SU-800. Configure the radio-controlled units as described under “Radio AWL” (□ 206), but note that if you are using an SB-500 you will need to select **Optical/radio AWL** for **Flash control** > **Wireless flash options** in Step 2 (with other units, **Optical/radio AWL** is selected automatically). Place optically-controlled units in group A, B, or C and radio-controlled units in group D, E, or F. You can now take photos as described on page 209.



Remote Flash Info

To view the flash units currently controlled using radio AWL, select **Flash control** > **Radio remote flash info** in the photo shooting menu. The identifier (“remote flash name”) for each unit can be changed using flash unit controls.

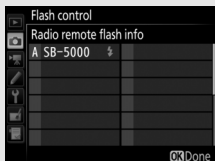

Taking Photos

The **Flash control > Remote flash control** item in the photo shooting menu offers three options for remote flash photography: **Group flash**, **Quick wireless control**, and **Remote repeating**.

■ ■ Group Flash

Select this option to adjust settings separately for each group.

1 📷: Select Group flash options.

Highlight **Group flash options** in the flash control display and press .

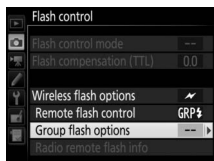

2 📷: Choose the flash control mode.

Choose the flash control mode and flash level for the master flash and the flash units in each group:

- **TTL**: i-TTL flash control (📖 196).
- **⊗A**: Auto aperture (available only with compatible flash units).
- **M**: Choose the flash level manually.
- **-- (off)**: The units do not fire and the flash level can not be adjusted.

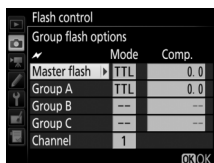

If **Optical AWL** or **Optical/radio AWL** is selected for **Flash control > Wireless flash options** in the photo shooting menu (📖 292), choose a channel for the master flash. If the remote flash units include an SB-500, you must choose channel 3, but otherwise you can choose any channel between 1 and 4.

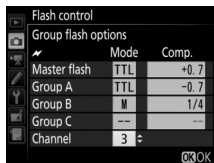

3 : Set the channel (optical AWL only).

Set the remote flash units to the channel selected in Step 2.

4 : Group the remote flash units.

Optical AWL

Choose a group (A, B, or C, or if you are using an SB-500 master flash, A or B) for each remote flash unit. Although there is no limit on the number of remote flash units that may be used, the practical maximum is three per group. With more than this number, the light emitted by the remote flash units will interfere with performance.

Radio AWL

Choose a group (A–F) for each of the remote flash units. The master flash can control up to 18 flash units in any combination.

5 / : Compose the shot.

Compose the shot and arrange the flash units. See the documentation provided with the flash units for more information. After arranging the units, take a test shot to confirm that all flash units are functioning. You can also test-fire radio-controlled flash units by pressing the  button in the flash info display (☞ 216) and selecting **Test flash**.

6 / : Frame the photograph, focus, and shoot.

In radio AWL, the flash-ready indicator will light in the camera viewfinder (☞ 10) or flash information display when all flash units are ready. The status of radio-controlled units can also be viewed by selecting **Flash control > Radio remote flash info** in the photo shooting menu.

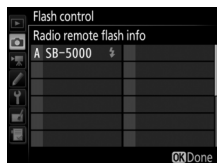

■ Quick Wireless Control

Select this option to control overall flash compensation for, and the relative balance between, groups A and B, while setting output for group C manually.

1 Select Quick wireless control options.

Highlight **Quick wireless control options** in the flash control display and press .

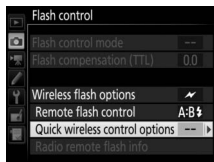

2 Adjust flash settings.

Choose the balance between groups A and B.

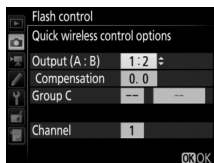

Adjust flash compensation for groups A and B.

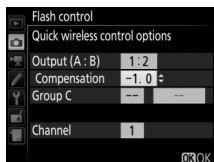

Choose a flash control mode and flash level for the units in group C:

- **M**: Choose the flash level manually.
- **--**: The units in group C do not fire.

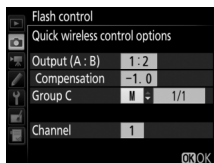

If **Optical AWL** is selected for **Flash control** > **Wireless flash options** in the photo shooting menu (☰ 292), choose a channel for the master flash. If the remote flash units include an SB-500, you must choose channel 3, but otherwise you can choose any channel between 1 and 4.

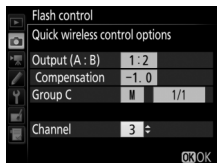

3 : Set the channel (optical AWL only).

Set the remote flash units to the channel selected in Step 2.

4 : Group the remote flash units.

Choose a group (A, B, or C).

Optical AWL

Although there is no limit on the number of remote flash units that may be used, the practical maximum is three per group. With more than this number, the light emitted by the remote flash units will interfere with performance.

Radio AWL

The master flash can control up to 18 flash units in any combination.

5 : Compose the shot.

Compose the shot and arrange the flash units. See the documentation provided with the flash units for more information. After arranging the units, take a test shot to confirm that all flash units are functioning. You can also test-fire radio-controlled flash units by pressing the **i** button in the flash info display (☰ 216) and selecting **Test flash**.

6 : Frame the photograph, focus, and shoot.

In radio AWL, the flash-ready indicator will light in the camera viewfinder (10) or flash information display when all flash units are ready. The status of radio-controlled units can also be viewed by selecting **Flash control** > **Radio remote flash info** in the photo shooting menu.

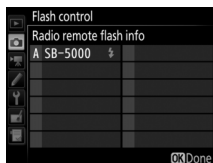

■ **Remote Repeating**

When this option is selected, the flash units fire repeatedly while the shutter is open, producing a multiple-exposure effect.

1 : Select Remote repeating options.

Highlight **Remote repeating options** in the flash control display and press .

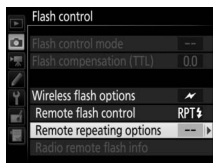

2 : Adjust flash settings.

Choose the flash level (**Output**), the maximum number of times the flash units fire (**Times**), and the number of times the flash units fire per second (**Frequency**).

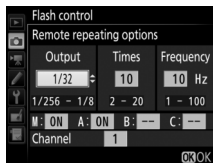

Enable or disable selected groups. Select **ON** to enable the selected group, -- to disable the selected group.

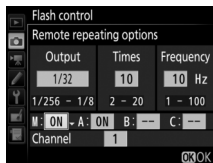

If **Optical AWL** is selected for **Flash control** > **Wireless flash options** in the photo shooting menu (☰ 292), choose a channel for the master flash. If the remote flash units include an SB-500, you must choose channel 3, but otherwise you can choose any channel between 1 and 4.

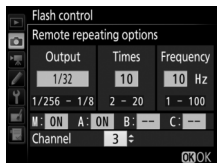

3 : Set the channel (optical AWL only).

Set the remote flash units to the channel selected in Step 2.

4 : Group the remote flash units.

Optical AWL

Choose a group (A, B, or C) for each remote flash unit. Although there is no limit on the number of remote flash units that may be used, the practical maximum is three per group. With more than this number, the light emitted by the remote flash units will interfere with performance.

Radio AWL

Choose a group (A–F) for each of the remote flash units. The master flash can control up to 18 flash units in any combination.

5 : Compose the shot.

Compose the shot and arrange the flash units. See the documentation provided with the flash units for more information. After arranging the units, take a test shot to confirm that all flash units are functioning. You can also test-fire radio-controlled flash units by pressing the **i** button in the flash info display (☰ 216) and selecting **Test flash**.

6 : Frame the photograph, focus, and shoot.



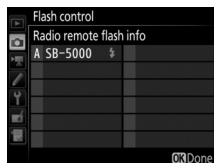

In radio AWL, the flash-ready indicator will light in the camera viewfinder ( 10) or flash information display when all flash units are ready. The status of radio-controlled units can also be viewed by selecting **Flash control** > **Radio remote flash info** in the photo shooting menu.



Optical AWL

Position the sensor windows on the remote flash units to pick up the light from the master flash (particular care is required if the camera is not mounted on a tripod). Be sure that direct light or strong reflections from the remote flash units do not enter the camera lens (in TTL mode) or the photocells on the remote flash units ( A mode), as this may interfere with exposure. To prevent low-intensity flashes emitted by the master flash from appearing in photographs taken at short range, choose low ISO sensitivities or small apertures (high f-numbers) or rotate the flash head on the master flash to point upwards. After positioning the remote flash units, take a test shot and view the results in the camera monitor.

Flash Compensation

The flash compensation value selected with the  () button and sub-command dial is added to the flash compensation values selected in the wireless flash options menu.  icons blink in the top control panel and viewfinder when a flash compensation value other than ± 0 is selected for the master or remote flash units in TTL or  A mode.



Viewing Flash Info

The camera can display flash info for SB-5000, SB-500, SB-400, and SB-300 flash units mounted on the camera accessory shoe and for remote flash units controlled via radio AWL using a WR-R10. To view flash info, press the **Info** button in the information display (p 220). The information displayed varies with the flash control mode.

TTL

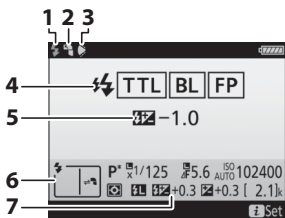

- 1 Flash-ready indicator.....194
- 2 Bounce icon (displayed if flash head is tilted)
- 3 Flash angle warning (displayed if angle of illumination is sub-optimal)
- 4 Flash control mode 197
FP indicator305
- 5 Flash compensation (TTL) ... 197, 200
- 6 Flash mode..... 198
- 7 Flash compensation.....200

Auto External Flash

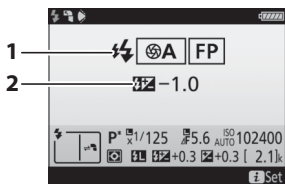

- 1 Flash control mode 197
FP indicator305
- 2 Flash compensation (auto aperture).....197, 200

Distance-Priority Manual

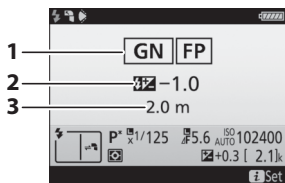

- | | | |
|---|---|----------|
| 1 | Flash control mode..... | 197 |
| | FP indicator | 305 |
| 2 | Flash compensation (distance-priority manual) | 197, 200 |
| 3 | Distance | 197 |

Manual

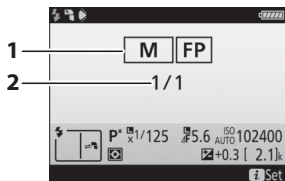

- | | | |
|---|-------------------------|----------|
| 1 | Flash control mode..... | 197 |
| | FP indicator | 305 |
| 2 | Flash level | 197, 200 |

Repeating Flash

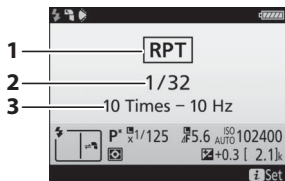

- | | | |
|---|------------------------------|-----|
| 1 | Flash control mode..... | 197 |
| 2 | Flash level (output) | 197 |
| 3 | Number emitted (times) | 197 |
| | Frequency..... | 197 |

Flash Info and Camera Settings

The flash information display shows selected camera settings, including exposure mode, shutter speed, aperture, and ISO sensitivity.



Group Flash

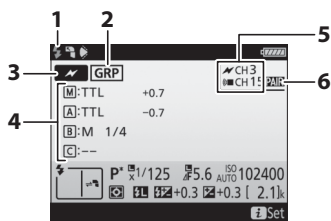

1	Flash-ready indicator ¹	210
2	Remote flash control	209
3	Remote flash control mode ²	204
4	Group flash control mode ^{2,3}	209
	Group flash mode	209
	Flash level/ flash compensation	209
5	Channel ²	206, 207, 209
6	Link mode	206

Quick Wireless Control

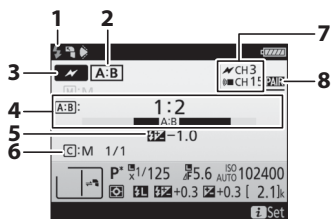



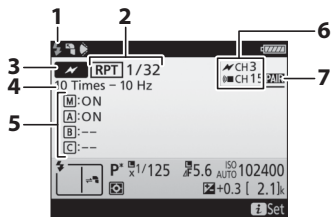

1	Flash-ready indicator ¹	213
2	Remote flash control	209
3	Remote flash control mode ²	204
4	A : B ratio	211
5	Flash compensation	200, 211
6	Group C flash control mode and flash level	211
7	Channel ²	206, 207, 212
8	Link mode	206

Remote Repeating



1	Flash-ready indicator ¹	215
2	Remote flash control	209
	Flash level (output)	213
3	Remote flash control mode ²	204
4	Number emitted (times)	213
	Frequency	213
5	Group status (enabled/disabled)	213
6	Channel ²	206, 207, 214
7	Link mode	206

- 1 Displayed in radio AWL when all flash units are ready.
- 2 Optical AWL is indicated by , radio AWL by , joint optical and radio AWL by  and . Optical AWL channel for joint optical and radio AWL is displayed only when SB-500 is used as master flash.
- 3 Icons are displayed for each group when joint optical and radio AWL is used.



Changing Flash Settings

Flash settings can be changed by pressing the  button in the flash info display. The options available vary with the flash unit and the settings selected. You can also test-fire the flash.

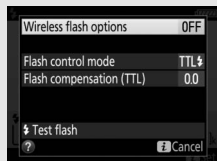

Other Shooting Options

The **info** Button

Pressing the **info** button during viewfinder photography displays shooting information in the monitor including shutter speed, aperture, number of exposures remaining, and AF-area mode.

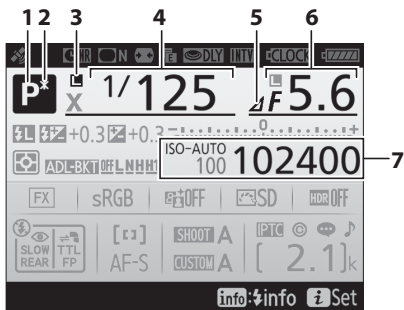

- | | | | | | |
|---|---|----------|---|---|----------|
| 1 | Exposure mode | 131 | 6 | Aperture (f-number) | 135, 136 |
| 2 | Flexible program indicator | 133 | | Aperture
(number of stops) | 135, 326 |
| 3 | Shutter-speed lock icon | 140 | | Bracketing increment | 148, 152 |
| 4 | Shutter speed | 134, 136 | | Number of shots
in ADL bracketing sequence | 155 |
| | Number of shots
and flash bracketing sequence | 147 | | Maximum aperture
(non-CPU lenses) | 244 |
| | Number of shots
in WB bracketing sequence | 151 | 7 | ISO sensitivity indicator | 124 |
| | Focal length (non-CPU lenses) | 244 | | ISO sensitivity | 124 |
| 5 | Aperture stop indicator | 135, 326 | | Auto ISO sensitivity indicator | 128 |

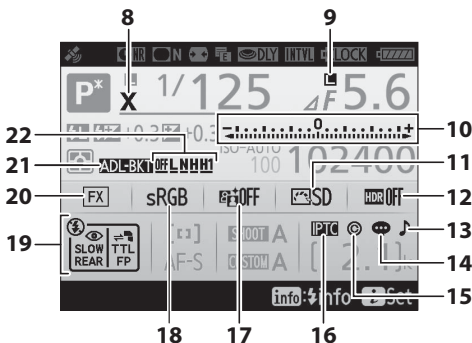

8	Flash sync indicator.....	305	14	Image comment indicator.....	311
9	Aperture lock icon	140	15	Copyright information indicator.....	311
10	Exposure indicator	137	16	ITPC indicator.....	311
	Exposure compensation display	143	17	Active D-Lighting indicator	188
	Bracketing progress indicator: Exposure and flash bracketing.....	147	18	Color space	294
	WB bracketing	151	19	Flash mode.....	198
11	Picture Control indicator.....	180	20	Image area indicator	87
12	HDR indicator	190	21	Exposure and flash bracketing indicator.....	147
	HDR exposure differential	193		WB bracketing indicator	151
	Multiple exposure indicator.....	230		ADL bracketing indicator.....	155
	Number of exposures (multiple exposure).....	231	22	Position of current frame in bracketing sequence	149, 153
13	“Beep” indicator.....	312		ADL bracketing amount	156

Turning the Monitor Off

To clear shooting or flash information from the monitor, press the **info** button or press the shutter-release button halfway. The monitor will turn off automatically if no operations are performed for about 10 seconds.

The Information Display (Continued)

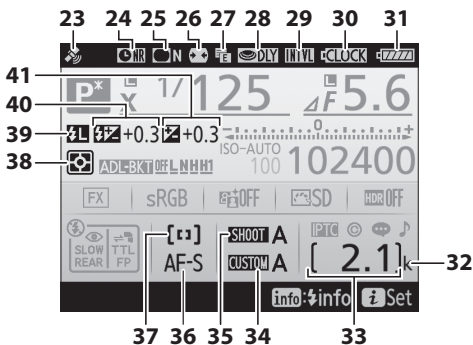

23 Satellite signal indicator246	33 Number of exposures remaining 38, 385
24 Long exposure noise reduction indicator294	Manual lens number244
25 Vignette control indicator294	34 Custom settings bank299
26 Auto distortion control294	35 Photo shooting menu bank.....291
27 Electronic front-curtain shutter...304	36 Autofocus mode 101
28 Exposure delay mode304	37 AF-area mode..... 104, 106
29 Interval timer indicator239	38 Metering 129
Time-lapse indicator..... 79	39 FV lock indicator203
30 Clock battery indicator 29, 351	40 Flash compensation indicator...200
31 Battery indicator..... 37	Flash compensation value200
32 "k" (appears when memory remains for over 1000 exposures)..... 38	41 Exposure compensation indicator 143
	Exposure compensation value..... 143

Note: Display shown with all indicators lit for illustrative purposes.



See Also

For information on choosing how long the monitor stays on, see Custom Setting c4 (**Monitor off delay**, 303). The color of the lettering in the information display can be changed using the **Information display** option in the setup menu (310).

The *i* button

To access the options below, press the *i* button during viewfinder photography. Highlight items using the multi selector and press \odot to view options for the highlighted item. To return to shooting mode, press the shutter-release button halfway.

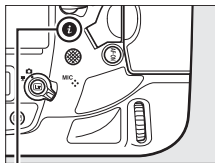

i button

Option	
Photo shooting menu bank	291
Custom settings bank	299
Custom control assignment	307
Active D-Lighting	188
Color space	294
Connect to network	281
Long exposure NR	294
High ISO NR	294

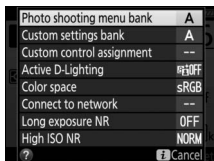

Two-Button Reset: Restoring Default Settings

The camera settings listed below can be restored to default values by holding the  and **WB** buttons down together for more than two seconds (these buttons are marked by a green dot). The control panels turn off briefly while settings are reset.

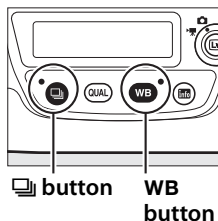

■ Settings Accessible from the Photo Shooting Menu ¹

Option	Default	Option	Default
Extended photo menu banks	Off	Picture Control settings ²	Unmodified
Image quality	JPEG normal	Flicker reduction	
Image size		Flicker reduction setting	Disable
JPEG/TIFF	Large	Flicker reduction indicator	On
NEF (RAW)	Large	Multiple exposure	Off ³
ISO sensitivity settings		HDR (high dynamic range)	Off ⁴
ISO sensitivity	100	Interval timer shooting	Off ⁵
Auto ISO sensitivity control	Off	Silent live view photography	Off
White balance			
	Auto > AUTO0 Keep white (reduce warm colors)		
Fine-tuning	A-B: 0, G-M: 0		

- 1 With the exception of multiple exposure and interval timer settings, only settings in the bank currently selected using the **Photo shooting menu bank** option will be reset (☐ 291). Settings in the remaining banks are unaffected.
- 2 Current Picture Control only.
- 3 If multiple exposure is currently in progress, shooting will end and multiple exposure will be created from exposures recorded to that point. Overlay mode and number of shots are not reset.
- 4 Exposure differential and smoothing are not reset.
- 5 If interval timer shooting is currently in progress, shooting will end. Starting time, shooting interval, number of intervals and shots, and exposure smoothing are not reset.



■ Settings Accessible from the Movie Shooting Menu

Option	Default
Movie ISO sensitivity settings	
ISO sensitivity (mode M)	100
Auto ISO control (mode M)	Off
Maximum sensitivity	102400

Option	Default
White balance	Same as photo settings
Electronic VR	Off

■ Other Settings

Option	Default
Focus point ¹	Center
Preset focus point	Center
Exposure mode	Programmed auto
Flexible program	Off
Exposure compensation	Off
AE lock hold	Off
Shutter speed lock	Off
Aperture lock	Off
Autofocus mode	AF-S
AF-area mode	
Viewfinder	Single-point AF
Live view	Normal-area AF

Option	Default
Photo live view display WB	None
Highlight display	Off
Headphone volume	15
Metering	Matrix metering
Bracketing	Off ²
Flash mode	Front-curtain sync
Flash compensation	Off
FV lock	Off
Exposure delay mode	Off ³

- 1 Focus point not displayed if auto-area AF is selected for AF-area mode.
- 2 Number of shots is reset to zero. Bracketing increment is reset to 1EV (exposure/flash bracketing) or 1 (white balance bracketing).  A **Auto** is selected for the second shot of two-shot ADL bracketing programs.
- 3 Only settings in the bank currently selected using the **Custom settings bank** option will be reset (□ 299). Settings in the remaining banks are unaffected.

See Also

See page 289 for a list of default settings.

Flicker Reduction

The camera offers two **Flicker reduction** options for reducing the effects of flicker due to fluorescent or mercury-vapor lighting. The first is located in the photo shooting menu and is used to reduce flicker in photos taken during viewfinder photography, while the second is in the movie shooting menu and is used to reduce flicker in live view and movie mode.

■ Viewfinder Photography

Choose from the following options:

- **Flicker reduction setting:** When **Enable** is selected, the camera will time photographs to reduce the effects of flicker (📖 295).

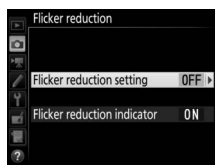

- **Flicker reduction indicator:** When **On** is selected, a flicker detection indicator (F L) will be displayed in the viewfinder if flicker is detected when the shutter-release button is pressed halfway. If flicker is detected when **Disable** is selected for **Flicker reduction setting**, the indicator will flash; to enable flicker reduction, select **Enable** for **Flicker reduction setting**.



■ Live View and Movie Mode

The **Flicker reduction** option in the movie shooting menu can be used to reduce flicker and banding during live view (📖 44) and movie recording (📖 59).

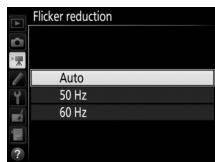

Flicker Reduction in the Photo Shooting Menu

Take a test shot and view the results before taking additional photographs. Flicker reduction can detect flicker at 100 and 120 Hz (associated respectively with AC power supplies of 50 and 60 Hz). Flicker may not be detected or the desired results may not be achieved with dark backgrounds, bright light sources, or decorative lighting displays and other non-standard lighting. Depending on the light source, there may be a slight delay before the shutter is released. During burst shooting, the frame rate may slow or become erratic; in addition, the desired results may not be achieved if the frequency of the power supply changes during shooting.

Flicker detection will not take effect at shutter speeds slower than $\frac{1}{100}$ s (including Bulb (**b** **u** **l** **b**) and Time (- -)) or when **MUP** or **14 fps (mirror up)** is selected for release mode or exposure delay mode is on. Flicker detection is available during flash photography but can not be used with remote wireless flash units.



Multiple Exposure

Follow the steps below to record a series of two to ten exposures in a single photograph.

■ Creating a Multiple Exposure

Multiple exposures can not be recorded in live view. Exit live view before proceeding.

Extended Recording Times

If the monitor turns off during playback or menu operations and no operations are performed for about 30 s, shooting will end and a multiple exposure will be created from the exposures that have been recorded to that point. The time available to record the next exposure can be extended by choosing longer times for Custom Setting c2 (**Standby timer**,  303).

- 1 Select Multiple exposure.**
Highlight **Multiple exposure** in the photo shooting menu and press .

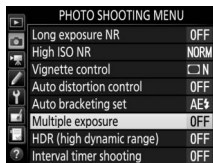

2 Select a mode.

Highlight **Multiple exposure mode** and press .

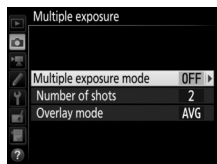

Highlight one of the following and press :

- **To take a series of multiple exposures**, select  **On (series)**. Multiple exposure shooting will continue until you select **Off** for **Multiple exposure mode**.
- **To take one multiple exposure**, select **On (single photo)**. Normal shooting will resume automatically after you have created a single multiple exposure.
- **To exit without creating additional multiple exposures**, select **Off**.

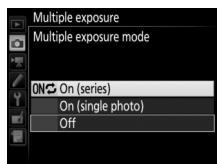

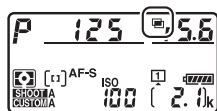

If **On (series)** or **On (single photo)** is selected, a  icon will be displayed in the top control panel.





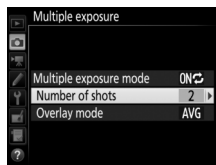

3 Choose the number of shots.

Highlight **Number of shots** and press .

Press  or  to choose the number of exposures that will be combined to form a single photograph and press .



The BKT Button

If **Multiple exposure** is selected for Custom Setting f1 (**Custom control assignment**) > **BKT button** +  (book 307), you can select the multiple exposure mode by pressing the **BKT** button and rotating the main command dial and the number of shots by pressing the **BKT** button and rotating the sub-command dial. The mode and number of shots are shown in the top control panel: the icons representing the mode are  **FF** for **Off**,  **i** for **On (single photo)**, and  **L** for **On (series)**.

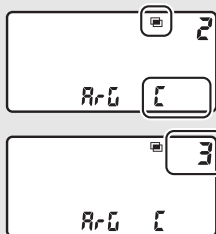

4 Choose the overlay mode.

Highlight **Overlay mode** and press .

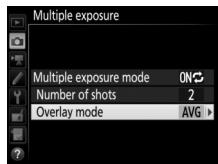

The following options will be displayed.

Highlight an option and press .

- **Add:** The exposures are overlaid without modification; gain is not adjusted.
- **Average:** Before the exposures are overlaid, the gain for each is divided by the total number of exposures taken (gain for each exposure is set to $1/2$ for 2 exposures, $1/3$ for 3 exposures, etc).
- **Lighten:** The camera compares the pixels in each exposure and uses only the brightest.

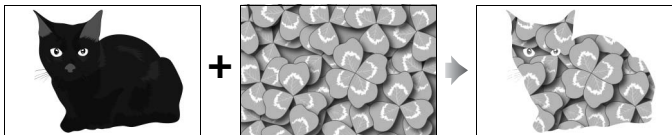
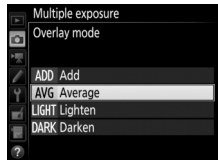

- **Darken:** The camera compares the pixels in each exposure and uses only the darkest.

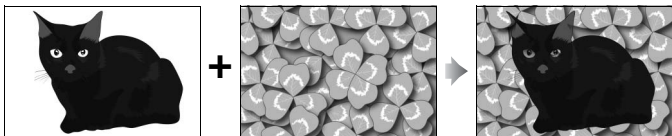

5 Frame a photograph, focus, and shoot.

In continuous release modes (☞ 116), the camera records all exposures in a single burst. If **On (series)** is selected, the camera will continue to record multiple exposures while the shutter-release button is pressed; if **On (single photo)** is selected, multiple exposure shooting will end after the first photograph. In self-timer mode, the camera will automatically record the number of exposures selected in Step 3 on page 231, regardless of the option selected for Custom Setting c3 (**Self-timer**) > **Number of shots** (☞ 303); the interval between shots is however controlled by Custom Setting c3 (**Self-timer**) > **Interval between shots**. In other release modes, one photograph will be taken each time the shutter-release button is pressed; continue shooting until all exposures have been recorded (for information on interrupting a multiple exposure before all photographs are recorded, see page 234).



The  icon will flash until shooting ends.

If **On (series)** is selected, multiple exposure shooting will only end when **Off** is selected for multiple exposure

mode; if **On (single photo)** is selected, multiple exposure shooting ends automatically when the multiple exposure is complete. The  icon clears from the display when multiple exposure shooting ends.

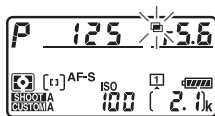

■ ■ **Ending Multiple Exposures**

To end a multiple exposure before the specified number of exposures have been taken, select **Off** for multiple exposure mode.

If shooting ends before the specified number of exposures have been taken, a multiple exposure will be created from the exposures that have been recorded to that point. If **Average** is selected for **Overlay mode**, gain will be adjusted to reflect the number of exposures actually recorded. Note that shooting will end automatically if:

- A two-button reset is performed (📖 224)
- The camera is turned off
- The battery is exhausted
- Pictures are deleted

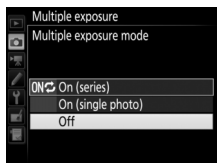

Multiple Exposure

Multiple exposures may be affected by noise (randomly-spaced bright pixels, fog, or lines).

Do not remove or replace the memory card while recording a multiple exposure.

Live view is not available while shooting is in progress. Selecting live view resets **Multiple exposure mode** to **Off**.

The shooting information listed in the playback photo information display (including metering, exposure, exposure mode, focal length, date of recording and camera orientation) is for the first shot in the multiple exposure.

Voice Memos

Voice recording is disabled while multiple exposures are being shot, but a memo can be recorded when shooting finishes (📖 272).

Interval Timer Photography

If interval timer photography is activated before the first exposure is taken, the camera will record exposures at the selected interval until the number of exposures specified in the multiple exposure menu have been taken (the number of shots listed in the interval timer shooting menu is ignored). These exposures will then be recorded as a single photograph and interval timer shooting will end (if **On (single photo)** is selected for multiple exposure mode, multiple exposure shooting will also end automatically).

Other Settings

While a multiple exposure is being shot, memory cards can not be formatted and some menu items are grayed out and can not be changed.



Interval Timer Photography

The camera is equipped to take photographs automatically at preset intervals.

✓ Before Shooting

Select a release mode other than self-timer (☺) when using the interval timer. Before beginning interval timer photography, take a test shot at current settings and view the results in the monitor. Once settings have been adjusted to your satisfaction, close the viewfinder eyepiece shutter to prevent light entering via the viewfinder interfering with photographs and exposure (📖 120).

Before choosing a starting time, select **Time zone and date** in the setup menu and make sure that the camera clock is set to the correct time and date (📖 28).

Use of a tripod is recommended. Mount the camera on a tripod before shooting begins. To ensure that shooting is not interrupted, be sure the camera battery is fully charged. If in doubt, charge the battery before use or use an AC adapter and power connector (available separately).

1 Select Interval timer shooting.

Highlight **Interval timer shooting** in the photo shooting menu and press  to display interval timer settings.

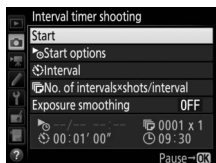
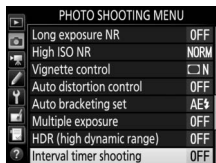

2 Adjust interval timer settings.

Choose a start option, interval, number of shots per interval, and exposure smoothing option.

- To choose a start option:

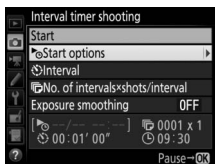

Highlight **Start options** and press .

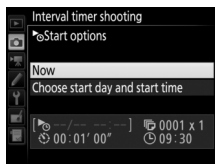

Highlight an option and press .

To start shooting immediately, select **Now**. To start shooting at a chosen date and time, select **Choose start day and start time**, then choose the date and time and press .

- To choose the interval between shots:

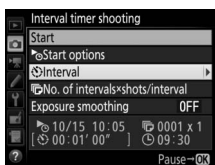

Highlight **Interval** and press .

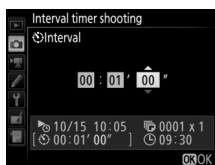

Choose an interval (hours, minutes, and seconds) and press .



- To choose the number of shots per interval:

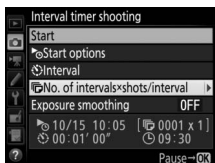

Highlight **No. of intervals x shots/interval** and press \rightarrow .

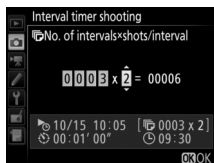

Choose the number of intervals and the number of shots per interval and press \rightarrow .

In **S** (single frame) mode, the photographs for each interval will be taken at the rate chosen for Custom Setting d1 (**Continuous shooting speed**) > **Continuous low-speed** (□ 303).

- To enable or disable exposure smoothing:

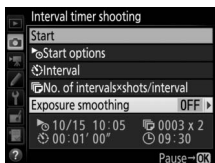

Highlight **Exposure smoothing** and press \rightarrow .

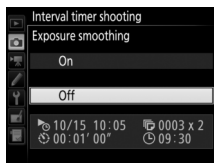

Highlight an option and press \rightarrow .

Selecting **On** allows the camera to adjust exposure to match previous shot in modes other than **M** (note that exposure smoothing only takes effect in mode **M** if auto ISO sensitivity control is on).



3 Start shooting.

Highlight **Start** and press **OK**. The first series of shots will be taken at the specified starting time, or after about 3 s if **Now** was selected for **Start options** in Step 2. Shooting will continue at the selected interval until all shots have been taken.

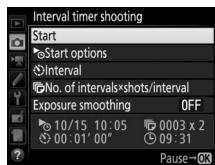

During Shooting

During interval timer photography, the **INTVL** icon will flash in the top control panel. Immediately before the next shooting interval begins, the shutter speed display will show the number of intervals remaining, and the aperture display will show the number of shots remaining in the current interval. At other times, the number of intervals remaining and the number of shots in each interval can be viewed by pressing the shutter-release button halfway (once the button is released, the shutter speed and aperture will be displayed until the standby timer expires).

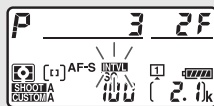

Settings can be adjusted, the menus used, and pictures played back while interval timer photography is in progress. The monitor will turn off automatically about four seconds before each interval. Note that changing camera settings while the interval timer is active may cause shooting to end.

Release Mode

Regardless of the release mode selected, the camera will take the specified number of shots at each interval.



■ Pausing Interval Timer Photography

Interval timer photography can be paused between intervals by pressing **OK** or selecting **Pause** in the interval timer menu.

■ Resuming Interval Timer Shooting

To resume shooting:

• Starting Now

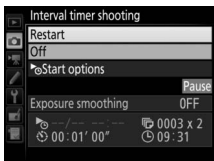

Highlight **Restart** and press **OK**.

• Starting at a Specified Time

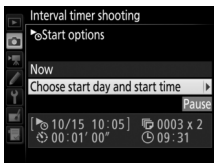

For **Start options**, highlight **Choose start day and start time** and press **OK**.

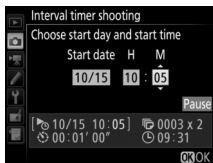

Choose a starting date and time and press **OK**.

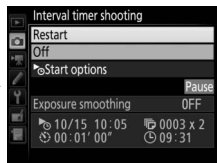

Highlight **Restart** and press **OK**.

■ Ending Interval Timer Shooting

To end interval timer photography before all the photos are taken, select **Off** in the interval timer menu.

■ ■ **No Photograph**

The camera will skip the current interval if any of the following situations persist for eight seconds or more after the interval was due to start: the photograph or photographs for the previous interval have yet to be taken, the memory card is full, or the camera is unable to focus in **AF-S** (note that the camera focuses again before each shot). Shooting will resume with the next interval.

✓ **Out of Memory**

If the memory card is full, the interval timer will remain active but no pictures will be taken. Resume shooting (📖 240) after deleting some pictures or turning the camera off and inserting another memory card.

✎ **Photo Shooting Menu Banks**

Changes to interval timer settings apply to all photo shooting menu banks (📖 291), meaning that interval timer shooting will continue even if you switch menu banks. If photo shooting menu settings are reset using the **Photo shooting menu bank** item in the photo shooting menu, interval timer shooting will end and interval timer settings will be reset as follows:

- Start options: Now
- Interval: 00:01:00"
- Number of intervals: 1
- Number of shots: 1
- Exposure smoothing: Off





✎ **Bracketing**

Adjust bracketing settings before starting interval timer photography. If exposure, flash, or ADL bracketing is active while interval timer photography is in effect, the camera will take the number of shots in the bracketing program at each interval, regardless of the number of shots specified in the interval timer menu. If white balance bracketing is active while interval timer photography is in effect, the camera will take one shot at each interval and process it to create the number of copies specified in the bracketing program.



Interval Timer Photography

Choose an interval longer than the time needed to take the selected number of shots and, if you are using a flash, the time needed for the flash to charge. If the interval is too short, the number of photos taken may be less than the total listed in Step 2 (the number of intervals multiplied by the number of shots per interval) or the flash may fire at less than the power needed for full exposure. Flash output may also fall below the desired level if more than one shot is taken per interval.

Interval timer photography can not be combined with long time-exposures (bulb or time photography,  138) or time-lapse movies ( 74) and is not available in live view ( 44, 59) or when **Record movies** is selected for Custom Setting g1 (**Custom control assignment**) > **Shutter-release button** ( 309). Note that because the shutter speed, frame rate, and time needed to record images may vary from one interval to the next, the time between the end of one interval and the beginning of the next may vary. If shooting can not proceed at current settings (for example, if a shutter speed of **b**  **b** or - - is currently selected in manual exposure mode, the interval is zero, or the start time is in less than a minute), a warning will be displayed in the monitor.

Interval timer shooting will pause when  (self-timer) is selected or if the camera is turned off and then on again (when the camera is off, batteries and memory cards can be replaced without ending interval timer photography). Pausing shooting does not affect interval timer settings.



Non-CPU Lenses

Non-CPU lenses can be used in exposure modes **A** and **M**, with aperture set using the lens aperture ring. By specifying lens data (lens focal length and maximum aperture), the user can gain access to the following CPU lens functions.

If the focal length of the lens is known:

- Power zoom can be used with optional flash units
- Lens focal length is listed (with an asterisk) in the playback photo info display

If the maximum aperture of the lens is known:

- The aperture value is displayed in the top control panel and viewfinder
- Flash level is adjusted for changes in aperture if the flash unit supports ⓈA (auto aperture) mode
- Aperture is listed (with an asterisk) in the playback photo info display

Specifying both the focal length and maximum aperture of the lens:

- Enables color matrix metering (note that it may be necessary to use center-weighted or spot metering to achieve accurate results with some lenses, including Reflex-NIKKOR lenses)
- Improves the precision of center-weighted and spot metering and i-TTL balanced fill-flash for digital SLR





To enter or edit data for a non-CPU lens:

1 Select Non-CPU lens data.

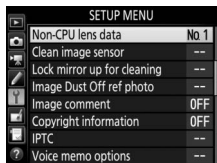
Highlight **Non-CPU lens data** in the setup menu and press .



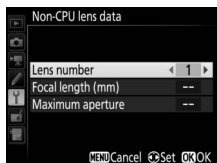

2 Select a lens number.

Highlight **Lens number** and press  or  to choose a lens number.



3 Enter the focal length and aperture.

Highlight **Focal length (mm)** or **Maximum aperture** and press  or  to edit the highlighted item.

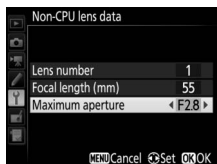

4 Save settings and exit.

Press . The specified focal length and aperture will be stored under the chosen lens number.



To recall lens data when using a non-CPU lens:

1 Assign non-CPU lens number selection to a camera control.

Assign **Choose non-CPU lens number** to a control using Custom Setting f1 (**Custom control assignment**, [p 307](#)).

2 Use the selected control to choose a lens number.

Press the selected control and rotate the main or sub-command dial until the desired lens number is displayed in the top control panel.

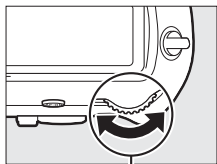

Main command dial

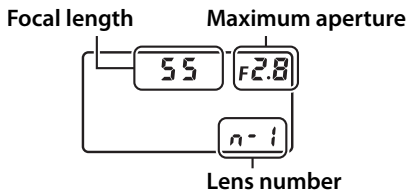

Focal Length Not Listed

If the correct focal length is not listed, choose the closest value greater than the actual focal length of the lens.

Teleconverters and Zoom Lenses

The maximum aperture for teleconverters is the combined maximum aperture of the teleconverter and the lens. Note that lens data are not adjusted when non-CPU lenses are zoomed in or out. The data for different focal lengths can be entered as separate lens numbers, or the data for the lens can be edited to reflect the new values for lens focal length and maximum aperture each time zoom is adjusted.



Location Data

A GPS unit can be connected to the ten-pin remote terminal, allowing the current latitude, longitude, altitude, Coordinated Universal Time (UTC), and heading to be recorded with each photograph taken. The camera can be used with optional GP-1 and GP-1A GPS units (see below; note that these units do not provide the compass heading), or with compatible third-party units connected via an optional MC-35 GPS adapter cord (☐ 340).

■ GP-1/GP-1A GPS Units

These optional GPS units are designed for use with Nikon digital cameras. For information on connecting the unit, see the manual provided with the device.

✍ The 📶 Icon

Connection status is shown by the 📶 icon in the information display:

- 📶 (static): Location data acquired.
- 📶 (flashing): The GPS device is searching for a signal. Pictures taken while the icon is flashing do not include location data.
- No icon: No new location data have been received from the GPS device for at least two seconds. Pictures taken when the 📶 icon is not displayed do not include location data.



✍ Heading

The heading is only recorded if the GPS device is equipped with a digital compass (note that the GP-1 and GP-1A are not equipped with a compass). Keep the GPS device pointing in the same direction as the lens and at least 20 cm (8 in.) from the camera.

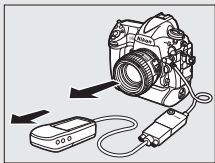

✍ Coordinated Universal Time (UTC)

UTC data is provided by the GPS device and is independent of the camera clock.

■ ■ Setup Menu Options

The **Location data** item in the setup menu contains the options listed below.

- **Standby timer:** Choose whether or not the standby timer is enabled when a GPS unit is attached.

Option	Description
Enable	Standby timer enabled. The timer expires automatically if no operations are performed for the period specified in Custom Setting c2 (Standby timer , □□ 303), reducing the drain on the battery. If a GP-1 or GP-1A unit is connected, the unit will remain active for a set period after the timer expires; to allow the camera time to acquire location data, the delay is extended by up to one minute after exposure meters are activated or the camera is turned on.
Disable	Standby timer disabled, ensuring uninterrupted recording of location data.

- **Position:** This item is only available if the GPS device is connected, when it displays the current latitude, longitude, altitude, Coordinated Universal Time (UTC), and heading (if supported) as reported by the GPS device.
- **Set clock from satellite:** Select **Yes** to synchronize the camera clock with the time reported by the GPS device.





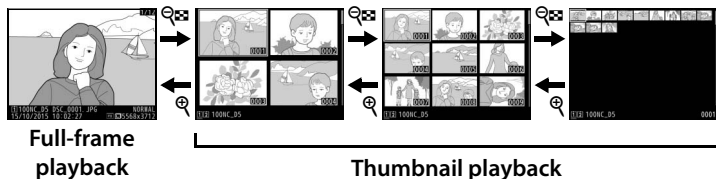

More About Playback

Viewing Images





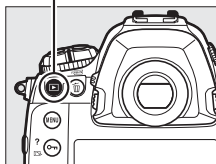

Full-Frame Playback

To play photographs back, press the  button. The most recent photograph will be displayed in the monitor. Additional pictures can be displayed by flicking left or right or pressing  or ; to view additional information on the current photograph, press  or  (□ 254).



 button

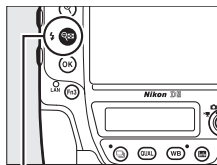

Thumbnail Playback

To view multiple images, press the  () button when a picture is displayed full frame. The number of images displayed increases from 4 to 9 to 72 each time the  () button is pressed, and decreases with each press of the  button. Slide a finger over the touch screen to scroll up or down or use the multi selector to highlight images.



 () button

Playback Controls

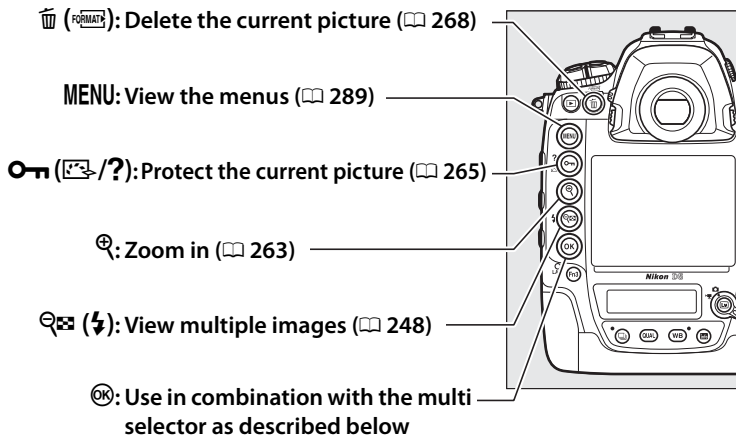

+	Display slot/folder selection dialog. To choose card and folder from which pictures are played back, highlight slot and press to display list of folders, then highlight folder and press .
+	Create retouched copy of current photograph or create edited copy of current movie (book 82).
+	View the IPTC presets stored on the camera (book 311). To embed IPTC preset in current photo, highlight preset and press (any preset already embedded in current photo will be replaced).
+	Upload photographs over a wireless or Ethernet network (book 281).

Two Memory Cards

If two memory cards are inserted, you can select a memory card for playback by pressing the button when 72 thumbnails are displayed.

Rotate Tall

To display “tall” (portrait-orientation) photographs in tall orientation, select **On** for the **Rotate tall** option in the playback menu (📖 290).



Image Review

When **On** is selected for **Image review** in the playback menu (📖 290), photographs are automatically displayed in the monitor after shooting (because the camera is already in the correct orientation, images are not rotated automatically during image review). In continuous release mode, display begins when shooting ends, with the first photograph in the current series displayed.

The Multi Selector

The multi selector can be used to highlight pictures in the thumbnail display and in displays like that shown at right.





See Also

For information on choosing how long the monitor will remain on when no operations are performed, see Custom Setting c4 (**Monitor off delay**, 📖 303). For information on choosing the role played by the center of the multi selector, see Custom Setting f2 (**Multi selector center button**, 📖 308). For information on using the command dials for image or menu navigation, see Custom Setting f4 (**Customize command dials**) > **Menus and playback** (📖 308).

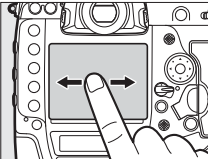
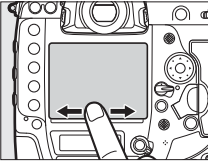

Using the Touch Screen

During playback, the touch-sensitive monitor can be used to:

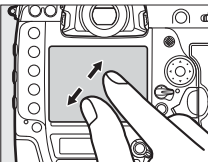
View other images	Flick left or right to view other images.	
Scroll rapidly to other images	In full frame view, you can touch the bottom of the display to display a frame advance bar, then slide your finger left or right to scroll rapidly to other images.	  Frame advance bar
Zoom in (photos only)	Use stretch and pinch gestures to zoom in and out and slide to scroll (📖 263). You can also give the display two quick taps to zoom in from full-frame playback or cancel zoom.	



View thumbnails

To “zoom out” to a thumbnail view (📖 248), use a pinch gesture in full-frame playback. Use pinch and stretch to choose the number of images displayed from 4, 9, and 72 frames.

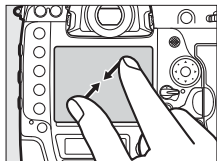

View movies

Tap the on-screen guide to start movie playback (movies are indicated by a 🎬 icon). Tap the display to pause or resume, or tap ⏮ to exit to full-frame playback (note that some of the icons in the movie playback display do not respond to touch-screen operations).





Guide



The *i* Button

Pressing the *i* button during full-frame or thumbnail playback displays the options listed below.

- **Rating:** Rate the current picture (📖 267).
- **Select/deselect for transfer:** Select or deselect photos for upload to a computer or ftp server (📖 281). Selected photos are marked with an upload icon and will be uploaded when the camera is connected via Ethernet or wireless LAN.
- **IPTC:** Embed an IPTC preset in the current image (📖 311).
- **Record voice memo:** Record a voice memo and append it to the current image (📖 272).
- **Play voice memo:** Play a voice memo (📖 276).
- **Retouch (photographs only):** Use the options in the retouch menu (📖 314) to create a retouched copy of the current photograph.
- **Edit movie (movies only):** Edit movies using the options in the edit movie menu (📖 82). Movies can also be edited by pressing the *i* button when movie playback is paused.
- **Choose slot and folder:** Choose a folder for playback. Highlight a slot and press  to list the folders on the selected card, then highlight a folder and press  to view the pictures in the highlighted folder.

To exit the *i*-button menu and return to playback, press the *i* button again.

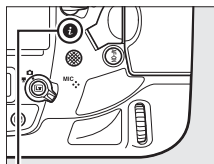

i button

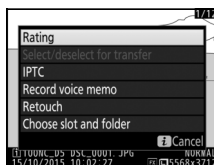
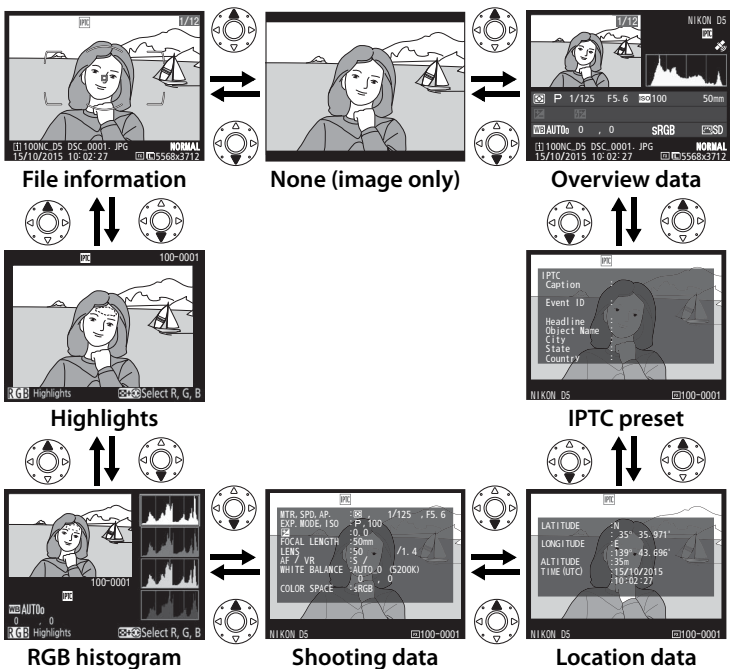
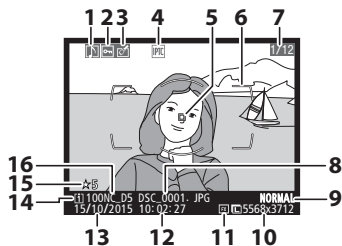

Photo Information

Photo information is superimposed on images displayed in full-frame playback. Press or to cycle through photo information as shown below. Note that “image only”, shooting data, RGB histograms, and highlights are only displayed if corresponding option is selected for **Playback display options** (📖 289). Location data are only displayed if a GPS device was used when the photo was taken (📖 246), while IPTC presets are displayed only if embedded in the photo (📖 311).



■ ■ File Information



1	Voice memo icon	272
2	Protect status.....	265
3	Retouch indicator	314
4	IPTC preset indicator	249, 311
5	Focus point ^{1,2}	108
6	AF area brackets ¹	35
7	Frame number/total number of frames	
8	File name	291
9	Image quality.....	92
10	Image size.....	95
11	Image area.....	87
12	Time of recording	28, 310
13	Date of recording.....	28, 310
14	Current card slot	97
15	Rating	267
16	Folder name	



- 1 Displayed only if **Focus point** is selected for **Playback display options** (□ 289) and selected photograph was taken using viewfinder.
- 2 If photograph was taken using manual focus or single-point, dynamic-area, or group-area AF, display shows focus point selected by user or, if photograph was taken using group-area AF (HL) or group-area AF (VL), row or column of focus points selected by user. If photograph was taken using 3D-tracking or auto-area AF, display shows focus point selected by camera.



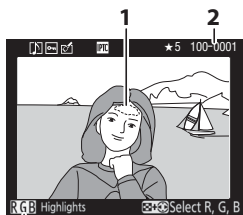

■ Highlights

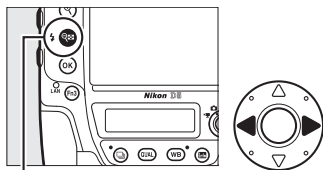

- 1 Image highlights *
- 2 Folder number–frame number
- 3 Current channel *

* Flashing areas indicate highlights (areas that may be overexposed) for current channel. Hold  (⚡) button and press  or  to cycle through channels as follows:



 (⚡) button

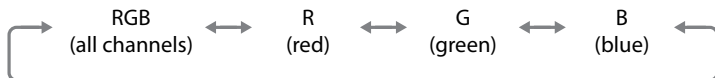

RGB Histogram

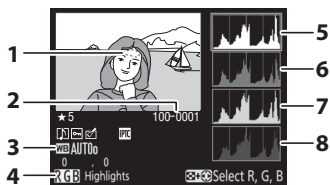

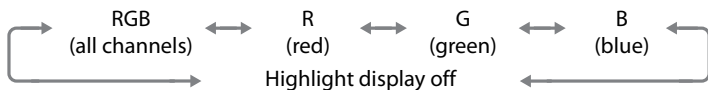
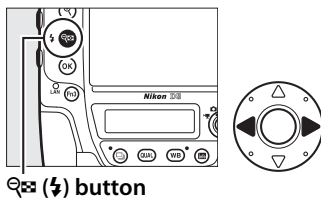

- 1 Image highlights *
- 2 Folder number–frame number
- 3 White balance 159
Color temperature 165
White balance fine-tuning 162
Preset manual 168
- 4 Current channel *
- 5 Histogram (RGB channel). In all histograms, horizontal axis gives pixel brightness, vertical axis number of pixels.
- 6 Histogram (red channel)
- 7 Histogram (green channel)
- 8 Histogram (blue channel)

* Flashing areas indicate highlights (areas that may be overexposed) for current channel. Hold () button and press or to cycle through channels as follows:



Playback Zoom

To zoom in on the photograph when the histogram is displayed, press . Use the  and  buttons to zoom in and out and scroll the image with the multi selector. The histogram will be updated to show only the data for the portion of the image visible in the monitor.



Histograms

Camera histograms are intended as a guide only and may differ from those displayed in imaging applications. Some sample histograms are shown below:

If the image contains objects with a wide range of brightnesses, the distribution of tones will be relatively even.



If the image is dark, tone distribution will be shifted to the left.



If the image is bright, tone distribution will be shifted to the right.



Increasing exposure compensation shifts the distribution of tones to the right, while decreasing exposure compensation shifts the distribution to the left. Histograms can provide a rough idea of overall exposure when bright ambient lighting makes it difficult to see photographs in the monitor.



Shooting Data

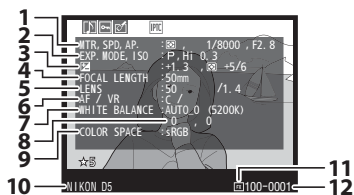

1	Metering	129
	Shutter speed	134, 136
	Aperture.....	135, 136
2	Exposure mode	131
	ISO sensitivity ¹	124
3	Exposure compensation	143
	Optimal exposure tuning ²	302
4	Focal length	243, 328
5	Lens data.....	243
6	Focus mode.....	48, 98
	Lens VR (vibration reduction) ³	
7	White balance ⁴	159
8	White balance fine-tuning	162
9	Color space	294
10	Camera name	
11	Image area.....	87
12	Folder number–frame number	

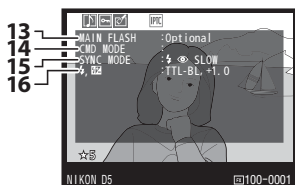

13	Flash type ⁵	
14	Remote flash control ⁵	204
15	Flash mode ⁵	198
16	Flash settings ⁵	197, 209
	Flash compensation ⁵	200

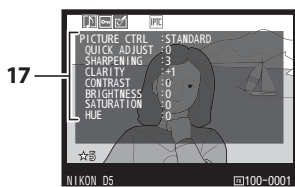

17	Picture Control ⁶	179
----	------------------------------------	-----



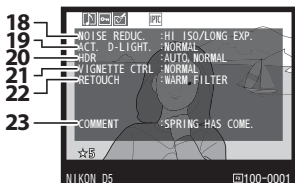

18	High ISO noise reduction	294
	Long exposure noise reduction	294
19	Active D-Lighting	187
20	HDR exposure differential	191
	HDR smoothing	191
21	Vignette control	294
22	Retouch history	314
23	Image comment	311

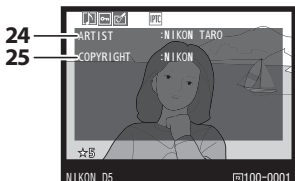

24	Name of photographer ⁷	311
25	Copyright holder ⁷	311

- 1 Displayed in red if photo was taken with auto ISO sensitivity control on.
- 2 Displayed if Custom Setting b7 (**Fine-tune optimal exposure**, □ 302) has been set to a value other than zero for any metering method.
- 3 Displayed only if VR lens is attached.
- 4 Also includes color temperature of photos taken using auto white balance.
- 5 Displayed only if optional flash unit (□ 194) is used.
- 6 The items displayed vary with the Picture Control selected when the picture was taken.
- 7 Copyright information is only displayed if recorded with the photograph using the **Copyright information** option in the setup menu.



Location Data ¹ (📖 246)

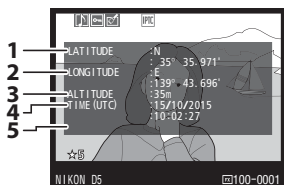

- 1 Latitude
- 2 Longitude
- 3 Altitude
- 4 Coordinated Universal Time (UTC)
- 5 Heading ²

- 1 Data for movies are for start of recording.
- 2 Displayed only if GPS device is equipped with electronic compass.

IPTC Preset (📖 311)

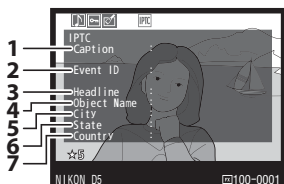

- 1 Caption
- 2 Event ID
- 3 Headline
- 4 Object Name
- 5 City
- 6 State
- 7 Country

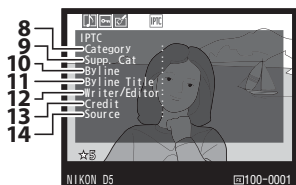

- 8 Category
- 9 Supplemental Categories (Supp. Cat.)
- 10 Byline
- 11 Byline Title
- 12 Writer/Editor
- 13 Credit
- 14 Source



Overview Data

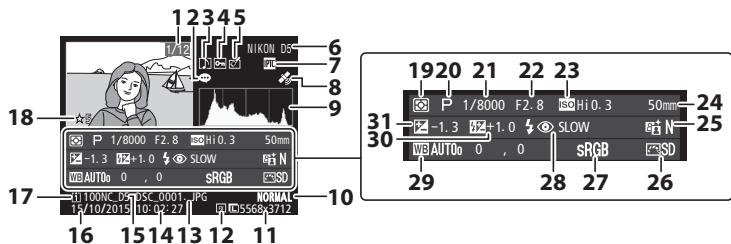

1	Frame number/total number of frames	17	Current card slot	97
2	Image comment indicator	18	Rating	267
3	Voice memo icon	19	Metering	129
4	Protect status	20	Exposure mode	131
5	Retouch indicator	21	Shutter speed	134, 136
6	Camera name	22	Aperture	135, 136
7	IPTC preset indicator	23	ISO sensitivity ¹	124
8	Location data indicator	24	Focal length	243, 328
9	Histogram showing the distribution of tones in the image (□ 258).	25	Active D-Lighting	187
10	Image quality	26	Picture Control	179
11	Image size	27	Color space	294
12	Image area	28	Flash mode ²	198
13	File name	29	White balance	159
14	Time of recording		Color temperature	165
15	Folder name		White balance fine-tuning	162
16	Date of recording		Preset manual	168
		30	Flash compensation ²	200
			Commander mode ²	
		31	Exposure compensation	143

1 Displayed in red if photo was taken with auto ISO sensitivity control on.







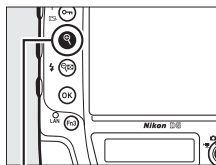

2 Displayed only if photo was taken with optional flash unit (□ 194).

Taking a Closer Look: Playback Zoom







To zoom in on an image displayed in full-frame playback, press the  button or the center of the multi selector or give the display two quick taps. The following operations can be performed while zoom is in effect:

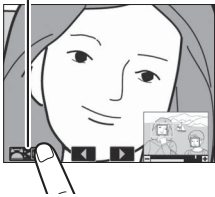

 button

To	Use	Description	
Zoom in or out	 /  (⚡) /  / 	Press  or use stretch gestures to zoom 36×24 (3 : 2) format images in to maximum of approximately 21 × (large images), 16 × (medium images) or 10 × (small images). Press  (⚡) or use pinch gestures to zoom out. While photo is zoomed in, use multi selector or slide finger over screen to view areas of image not visible in monitor. Keep multi selector pressed to scroll rapidly to other areas of frame. Navigation window is displayed when zoom ratio is altered; area currently visible in monitor is indicated by yellow border. Bar under navigation window shows zoom ratio; turns green at ratio of 1 : 1.	
View other areas of image	 / 		



To	Use	Description
Select faces		Faces (up to 35) detected during zoom are indicated by white borders in navigation window. Rotate sub-command dial or tap on-screen On-screen guide to view other faces. 
View other images		Rotate main command dial or tap ◀ or ▶ icons at bottom of display to view same location in other photos at current zoom ratio. Playback zoom is cancelled when a movie is displayed.
Change protect status	 ( / ?)	See page 265 for more information.
Return to shooting mode	 / 	Press the shutter-release button halfway or press the  button to exit to shooting mode.
Display menus	MENU	See page 289 for more information.



Protecting Photographs from Deletion

In full-frame, zoom, and thumbnail playback, the **Protect** (🔒/?) button can be used to protect photographs from accidental deletion. Protected files can not be deleted using the **Delete** (🗑️) button or the **Delete** option in the playback menu. Note that protected images *will* be deleted when the memory card is formatted (📖 33, 310).

To protect a photograph:

1 Select an image.

Display the image in full-frame playback or playback zoom or highlight it in the thumbnail list.

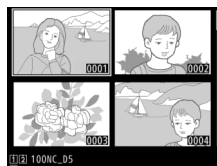

2 Press the **Protect** (🔒/?) button.

The photograph will be marked with a **Protect** (🔒) icon. To remove protection from the photograph so that it can be deleted, display the photograph or highlight it in the thumbnail list and then press the **Protect** (🔒/?) button.

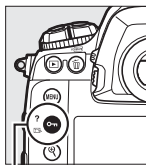



Protect (🔒/?) button



Voice Memos

Changes to the protect status of images also apply to any voice memos that may have been recorded with the images. Voice memo overwrite status can not be set separately.

Removing Protection from All Images

To remove protection from all images in the folder or folders currently selected in the **Playback folder** menu, press the  (▶) and  (FORMAT) buttons together for about two seconds during playback.



Rating Pictures

Rate pictures or mark them as candidates for later deletion. Ratings can also be viewed in ViewNX-i and Capture NX-D. Rating is not available with protected images.

1 Select an image.

Display the image or highlight it in the thumbnail list in thumbnail playback.

2 Display playback options.

Press the **i** button to display playback options.

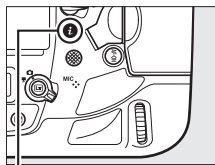

i button

3 Select Rating.

Highlight **Rating** and press **↵**.

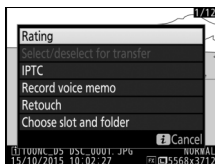

4 Choose a rating.

Press **←** or **→** to choose a rating of from zero to five stars, or select **✖** to mark the picture as a candidate for later deletion. Press **OK** to complete the operation.



Rating Pictures with the Fn3 Button

If **Rating** is selected for Custom Setting f1 (**Custom control assignment**) > **Fn3 button**, pictures can be rated by keeping the **Fn3** button pressed and pressing **←** or **→** (□ 307).

Deleting Photographs

To delete all photographs in the current folder or the photograph displayed in full-frame playback or highlighted in the thumbnail list, press the  (FORMAT) button. To delete multiple selected photographs, use the **Delete** option in the playback menu. Once deleted, photographs can not be recovered. Note that pictures that are protected or hidden can not be deleted.



Full-Frame and Thumbnail Playback

Press the  (FORMAT) button to delete the current photograph.

1 Select an image.



Display the image or highlight it in the thumbnail list.

2 Press the (FORMAT) button. (FORMAT) button

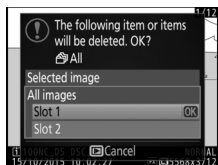
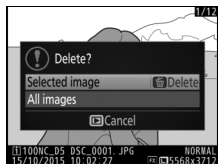
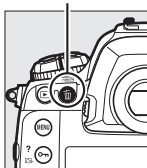
The menu shown at right will be displayed; highlight **Selected image** (to delete all pictures in the folder currently selected for playback— 289—press  and choose a slot).



3 Delete the photograph(s).

To delete the photograph or photographs, press the  (FORMAT) button (**Selected image**) or  button (**All images**). To exit without deleting the photograph or photographs, press the  button.



See Also

The **After delete** option in the playback menu determines whether the next image or the previous image is displayed after an image is deleted ( 290).

The Playback Menu

Select **Delete** in the playback menu to delete pictures and their associated voice memos. Note that depending on the number of images, some time may be required for deletion.

Option	Description
 Selected	Delete selected pictures.
ALL All	Delete all pictures in the folder currently selected for playback (📁 289). If two cards are inserted, you can select the card from which pictures will be deleted.

■ Selected: Deleting Selected Photographs

1 Choose **Delete** > **Selected**.

Select **Delete** in the playback menu.
Highlight **Selected** and press .

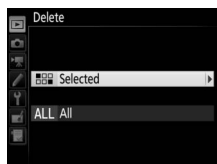

2 Highlight a picture.

Use the multi selector to highlight a picture (to view the highlighted picture full screen, press and hold the  button).



 button

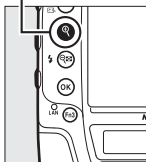

3 Select the highlighted picture.

Press the center of the multi selector to select the highlighted picture. Selected pictures are marked by a  icon.



Repeat steps 2 and 3 to select additional pictures; to deselect a picture, highlight it and press the center of the multi selector.

4 Press to complete the operation.

A confirmation dialog will be displayed; highlight **Yes** and press .

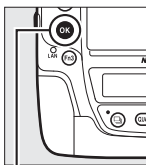

 button



Voice Memos

Recording Voice Memos

Voice memos up to 60 seconds long can be added to photographs during playback or recording.

During Playback



To add a voice memo to an existing photograph:

1 Select the photograph.

Display the photograph full-frame or highlight it in the thumbnail list. Only one voice memo can be recorded per image; additional voice memos can not be recorded for images already marked with a  icon.



2 Start recording.

To start recording, press the **i** button, highlight **Record voice memo**, and press . A  icon is displayed while recording is in progress.

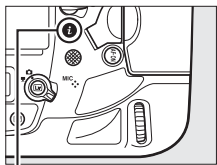

i button

3 End recording.

Press the center of the multi selector to end recording.



The Fn3 button

If **Voice memo** is selected for Custom Setting f1 (**Custom control assignment**) > **Fn3 button** (☞ 307), you can press and hold the **Fn3** button to record a voice memo for the current image (note that no memo will be recorded if the button is not held down for at least one second).

During Shooting

Voice memos can be recorded automatically with every photo taken or by manually pressing a button to record a voice memo for the most recent photograph.

■ *Automatic Recording*

To record voice memos automatically, select **On (Auto and manual)** for **Voice memo options** > **Voice memo** in the setup menu (☞ 312) and choose the recording time.

Recording will begin when you lift your finger from the shutter-release button after shooting.

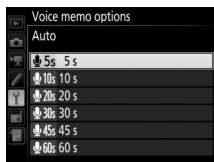
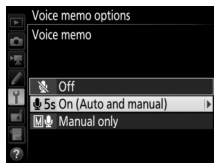

Automatic Recording

Voice memos will not be recorded automatically during live view (☞ 44), while a time-lapse movie is being recorded (☞ 74), or when **On** is selected for the **Image review** option (☞ 290) in the playback menu.



Manual Recording

To enable manual voice memo recording, select **Voice memo** for Custom Setting f1 (**Custom control assignment**) > **Fn3 button** (307) and choose **Manual only** for **Voice memo options** > **Voice memo** in the setup menu (312). You can then press and hold the **Fn3** button at any time to record a voice memo and add it to the most recent photograph (note that no memo will be recorded if the button is not held down for at least one second).

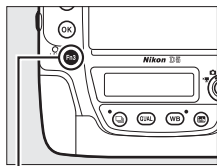
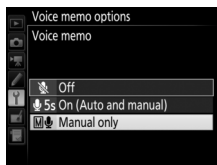

Fn3 button

Voice Memo

The option selected for **Voice memo** is indicated by an icon in the rear control panel.

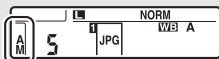

On (Auto and manual)

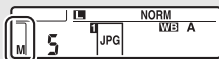

Manual only

During Recording

During recording, the  icon in the rear control panel will flash. A countdown timer in the rear control panel shows the length of the voice memo that can be recorded (in seconds).



Rear control panel

Slot 2

If two memory cards are inserted and **Backup** or **RAW Slot 1 - JPEG Slot 2** is selected for the **Role played by card in Slot 2** option (☞ 97) in the photo shooting menu, voice memos will be associated with the images recorded to the memory card in the Slot 1.

Interrupting Recording

Pressing the shutter-release button or operating other camera controls may end recording. During interval timer photography, recording ends automatically about two seconds before the next photograph is taken. Recording also ends automatically when the camera is turned off.

After Recording

If a voice memo has been recorded for the most recent photograph, a  icon will be displayed in the rear control panel.

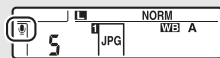

Rear control panel

If a voice memo exists for the photograph currently selected in playback mode, a  icon will be displayed in the monitor.



Voice Memo File Names

Voice memos are stored as WAV files with names of the form "xxxxnnnn.WAV," where "xxxxnnnn" is a file name copied from the image with which the voice memo is associated. For example, the voice memo for the image "DSC_0002.JPG" would have the file name "DSC_0002.WAV." Voice memo file names can be viewed on a computer.

See Also

The **Voice memo options** > **Voice memo overwrite** item in the setup menu controls whether the memo for the most recent photograph can be overwritten in shooting mode (☞ 312). The **Voice memo options** > **Voice memo control** item provides options for manual recording.



Playing Voice Memos



To play voice memos, press **i** and select **Play voice memo** when viewing photographs marked with  icons (📖 248).





The Fn3 button

If **Voice memo** is selected for Custom Setting f1 (**Custom control assignment**) > **Fn3 button** (📖 307), you can press the **Fn3** button to start and stop voice memo playback.

Deleting Voice Memos

To delete voice memos from an image, display the image full-frame or select it in the thumbnail display and press the  (FORMAT) button, then highlight **Selected image** and press  (FORMAT) again to display the following options:

- **Image/sound**: Select this option and press the  (FORMAT) button to delete both photo and voice memo.
- **Sound only**: Select this option and press the  (FORMAT) button to delete only the voice memo.

To exit without deleting either voice memo or photo, press .

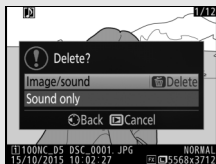

Interrupting Playback

Pressing the shutter-release button or operating other camera controls may end playback. Playback ends automatically when another image is selected or the camera is turned off.

See Also

The **Voice memo options** > **Audio output** option in the setup menu can be used to choose a device for voice memo playback (📖 312).





Connections

Installing ViewNX-i

To fine-tune photos and upload and view pictures, download the latest version of the ViewNX-i installer from the following website and follow the on-screen instructions to complete installation. An Internet connection is required. For system requirements and other information, see the Nikon website for your region.

<http://downloadcenter.nikonimglib.com/>

Capture NX-D

Use Nikon's Capture NX-D software to fine-tune photos or to change settings for NEF (RAW) pictures and save them in other formats.

Capture NX-D is available for download from:

<http://downloadcenter.nikonimglib.com/>



Copying Pictures to the Computer

Before proceeding, be sure you have installed ViewNX-i (☞ 277).

1 Connect the USB cable.

After turning the camera off and ensuring that a memory card is inserted, connect the supplied USB cable as shown and then turn the camera on.

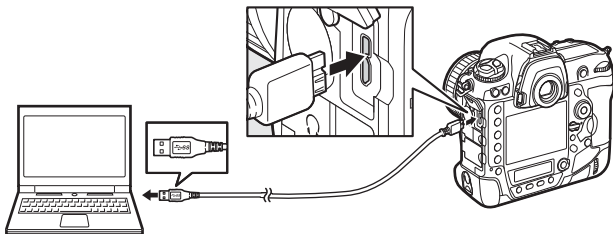

✓ The USB Cable Clip

To prevent cable from being disconnected, attach the supplied clip as shown.

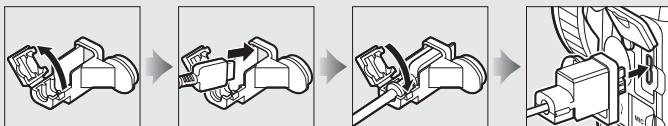

✓ USB Hubs

Connect the camera directly to the computer; do not connect the cable via a USB hub or keyboard.

✎ Use a Reliable Power Source

To ensure that data transfer is not interrupted, be sure the camera battery is fully charged.

✎ Connecting Cables

Be sure the camera is off when connecting or disconnecting interface cables. Do not use force or attempt to insert the connectors at an angle.

2 Start Nikon Transfer 2 component of ViewNX-i.

If a message is displayed prompting you to choose a program, select Nikon Transfer 2.

✓ **During Transfer**

Do not turn the camera off or disconnect the USB cable while transfer is in progress.

✍ **Windows 7**

If the following dialog is displayed, select Nikon Transfer 2 as described below.

1 Under **Import pictures and videos**, click **Change program**. A program selection dialog will be displayed; select Nikon Transfer 2 and click **OK**.



2 Double-click .

✍ **Windows 10 and Windows 8.1**

Windows 10 and Windows 8.1 may display an AutoPlay prompt when the camera is connected. Tap or click the dialog and then tap or click **Import File/Nikon Transfer 2** to select Nikon Transfer 2.

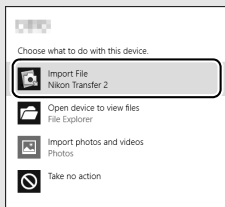
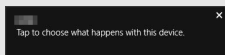

✍ **OS X**

If Nikon Transfer 2 does not start automatically, confirm that the camera is connected and then launch Image Capture (an application that comes with OS X) and select Nikon Transfer 2 as the application that opens when the camera is detected.



3 Click Start Transfer.

Pictures on the memory card will be copied to the computer.



Start Transfer

4 Terminate the connection.

When transfer is complete, turn the camera off and disconnect the USB cable.



For More Information

Consult online help for more information on using ViewNX-i.

Ethernet and Wireless Networks

The camera can be connected to Ethernet or wireless networks using the built-in Ethernet port or an optional WT-6 or WT-5 wireless transmitter (📖 337). Note that an Ethernet cable (available separately from commercial sources) is required for an Ethernet connection.

■ ■ Mode Selection

The following modes are available when the camera is connected to a network using the built-in Ethernet port or an optional WT-6 or WT-5 wireless transmitter:

Mode	Function
FTP upload	Upload existing photos and movies to a computer or ftp server, or upload new photos as they are taken.
Image transfer	
Camera control	Control the camera using optional Camera Control Pro 2 software and save new photos and movies directly to the computer.
HTTP server	View and take pictures remotely using a browser-equipped computer or smart device.
Synchronized release (wireless only)	Synchronize the shutter releases for multiple remote cameras with a master camera.

For more information, see the *Network Guide*, available for download free of charge from the following website:

<http://downloadcenter.imglib.com>

For information on using optional wireless transmitters, refer to the manuals provided with the device. Be sure to update all related software to the latest versions.



During Transfer

Movies can not be recorded or played back in image transfer mode (“image transfer mode” applies when images are being transferred via an Ethernet or wireless network and when images remain to be sent). Live view photography is not available during transfer if **On** is selected for **Silent live view photography** in the photo shooting menu.

Movies

Movies can be uploaded in transfer mode if the camera is connected to an Ethernet or a wireless network and **Auto send** or **Send folder** is not selected for **Network > Options**.

HTTP Server Mode

The camera can not be used to record or view movies in http server mode, while live view photography is not available if **On** is selected for **Silent live view photography** in the photo shooting menu.

Wireless Transmitters

The principal differences between the WT-6 and WT-6A/B/C and the WT-5 and WT-5A/B/C/D are in the number of channels supported; unless otherwise stated, all references to the WT-6 also apply to the WT-6A/B/C, while all references to the WT-5 also apply to the WT-5A/B/C/D.



Printing Photographs

Selected JPEG images can be printed on a PictBridge printer (☞ 382) connected directly to the camera.

Connecting the Printer

Connect the camera using the supplied USB cable. Do not use force or attempt to insert the connectors at an angle.

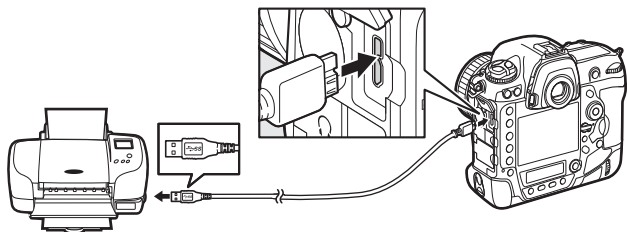

When the camera and printer are turned on, a welcome screen will be displayed in the monitor, followed by a PictBridge playback display.

Selecting Photographs for Printing

Images created at image quality settings of NEF (RAW) or TIFF (RGB) (☞ 92) can not be selected for printing. JPEG copies of NEF (RAW) images can be created using the **NEF (RAW) processing** option in the retouch menu (☞ 314).

Printing Via Direct USB Connection

Be sure the battery is fully charged or use an optional AC adapter and power connector. When taking photographs to be printed via direct USB connection, set **Color space** to **sRGB** (☞ 294).

See Also

See page 369 for information on what to do if an error occurs during printing.



Printing Pictures One at a Time

1 Display the desired picture.

Press or to view additional pictures. Press the button to zoom in on the current frame (263, press to exit zoom). To view six pictures at a time, press the (). Use the multi selector to highlight pictures, or press the button to display the highlighted picture full frame. To view images in other locations, press () when thumbnails are displayed and select the desired card and folder as described on page 249.

2 Adjust printing options.

Press to display the following items, then press or to highlight an item and press to view options (only options supported by the current printer are listed; to use the default option, select **Printer default**). After selecting an option, press to return to the printer settings menu.

Option	Description
Page size	Choose a page size.
No. of copies	This option is listed only when pictures are printed one at a time. Press or to choose number of copies (maximum 99).
Border	Choose whether to frame photos in white borders.
Print date	Choose whether to print the times and dates of recordings on photos.
Cropping	This option is listed only when pictures are printed one at a time. To exit without cropping, highlight No cropping and press . To crop the current picture, highlight Crop and press . A crop selection dialog will be displayed; press to increase the size of the crop, () to decrease, and use the multi selector to position the crop. Note that print quality may drop if small crops are printed at large sizes.



3 Start printing.

Select **Start printing** and press **OK** to start printing. To cancel before all copies have been printed, press **OK**.

Printing Multiple Pictures

1 Display the PictBridge menu.

Press the **MENU** button in the PictBridge playback display.

2 Choose an option.

Highlight one of the following options and press **▶**.

- **Print select:** Select pictures for printing. Use the multi selector to highlight pictures (to view images in other locations, press **Q** (↻) and select the desired card and folder as described on page 249; to display the current picture full screen, press and hold the **Q** button) and, keeping the **OK** (⏏/?) button pressed, press **▲** or **▼** to choose the number of prints (maximum 99). To deselect a picture, set the number of prints to zero.
- **Index print:** To create an index print of all JPEG pictures on the memory card, proceed to Step 3. Note that if the memory card contains more than 256 pictures, only the first 256 images will be printed. A warning will be displayed if the page size selected in Step 3 is too small for an index print.

3 Adjust printing options.

Adjust printer settings as described in Step 2 on page 284.

4 Start printing.

Select **Start printing** and press **OK** to start printing. To cancel before all copies have been printed, press **OK**.



Viewing Photographs on TV

The optional High-Definition Multimedia Interface (HDMI) cable (☞ 339) or a type C HDMI cable (available separately from third-party suppliers) can be used to connect the camera to high-definition video devices. Always turn the camera off before connecting or disconnecting an HDMI cable.

Connect to high-definition device (choose cable with connector for HDMI device)

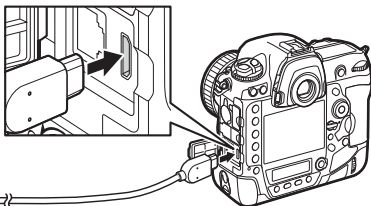

Connect to camera

Tune the device to the HDMI channel, then turn the camera on and press the  button. During playback, images will be displayed on the television screen. Volume can be adjusted using television controls; the camera controls can not be used.

The HDMI Cable Clip

When using the optional Nikon HDMI cable, attach the supplied clip as shown to prevent accidental disconnection. Do not use cable clips with non-Nikon cables.

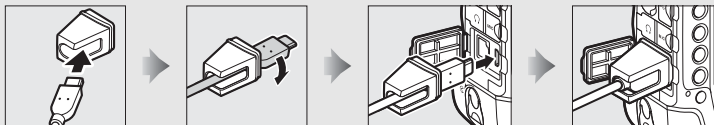

HDMI Options

The **HDMI** option in the setup menu (☰ 312) controls output resolution and other advanced HDMI options.

■ ■ Output Resolution

Choose the format for images output to the HDMI device. If **Auto** is selected, the camera will automatically select the appropriate format.

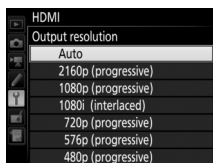

■ ■ Advanced

Option	Description
Output range	<p>Auto is recommended in most situations. If the camera is unable to determine the correct RGB video signal output range for the HDMI device, you can choose from the following options:</p> <ul style="list-style-type: none">• Limited range: For devices with an RGB video signal input range of 16 to 235. Choose this option if you notice loss of detail in shadows.• Full range: For devices with an RGB video signal input range of 0 to 255. Choose this option if shadows are “washed out” or too bright.
Output display size	Choose horizontal and vertical frame coverage for HDMI output from 95% or 100%.
Live view on-screen display	If Off is selected when the camera is connected to an HDMI device, shooting information will not be displayed in the monitor during live view photography.
Dual monitor	Choose On to mirror the HDMI display on the camera monitor, Off to turn the camera monitor off to save power. Dual monitor turns on automatically when Live view on-screen display is Off .



Television Playback

Use of an AC adapter and power connector (available separately) is recommended for extended playback. If the edges of photographs are not visible in the television display, select **95%** for **HDMI > Advanced > Output display size** (📖 287).

Voice Memo Options > Audio Output (📖 312)

Set **HDMI** to play back voice memos on the HDMI device.

Slide Shows

The **Slide show** option in the playback menu can be used for automated playback (📖 290).

HDMI and Live View

When the camera is connected via an HDMI cable, HDMI displays can be used for live view photography and movie recording (📖 55, 68).

Using Third-Party Recording Devices

The following settings are recommended when using third-party recorders:

- **HDMI > Advanced > Output display size: 100%**
- **HDMI > Advanced > Live view on-screen display: Off**





Menu List

This section lists the options available in the camera menus. For more information, see the *Menu Guide*.

The Playback Menu: *Managing Images*

Delete

Selected	Delete multiple images (📄 270).
All	

Playback folder (defaults to **All**)

(Folder name)	Choose a folder for playback.
All	
Current	

Hide image

Select/set	Hide or reveal images. Hidden images are displayed only in the “Hide image” menu and cannot be played back.
Deselect all	

Playback display options

Basic photo info	Choose the information available in the playback photo information display (📄 254).
Focus point	
Additional photo info	
None (image only)	
Highlights	
RGB histogram	
Shooting data	
Overview	

Copy image(s)	
Select source	Copy pictures from one memory card to another. This option is only available when two memory cards are inserted in the camera.
Select image(s)	
Select destination folder	
Copy image(s)?	
Image review (defaults to Off)	
On	Choose whether pictures are automatically displayed in the monitor immediately after shooting (□ 42).
Off	
After delete (defaults to Show next)	
Show next	Choose the picture displayed after an image is deleted.
Show previous	
Continue as before	
After burst, show (defaults to Last image in burst)	
First image in burst	Choose whether the camera displays the first or the last photo in the burst after photos are taken in continuous release mode.
Last image in burst	
Auto image rotation (defaults to On)	
On	Choose whether to record camera orientation when taking photographs.
Off	
Rotate tall (defaults to On)	
On	Choose whether to rotate "tall" (portrait-orientation) pictures for display during playback (□ 250).
Off	
Slide show	
Start	View a slide show of the pictures in the current playback folder.
Image type	
Frame interval	
Audio playback	

The Photo Shooting Menu: *Shooting Options*

Photo shooting menu bank	
A	Recall photo shooting menu settings
B	previously stored in a photo shooting
C	menu bank. Changes to settings are
D	stored in the current bank.
Extended photo menu banks (defaults to Off)	
On	Choose whether photo shooting menu
Off	banks store exposure mode, shutter
	speed (exposure modes S and M),
	aperture (modes A and M), and flash
	mode.
Storage folder	
Rename	Select the folder in which subsequent
Select folder by number	images will be stored.
Select folder from list	
File naming	
File naming	Choose the three-letter prefix used in
	naming the image files in which
	photographs are stored. The default
	prefix is "DSC".
Role played by card in Slot 2 (defaults to Overflow)	
Overflow	Choose the role played by the card in
Backup	Slot 2 when two memory cards are
RAW Slot 1 - JPEG Slot 2	inserted in the camera ( 97).



Flash control

Flash control mode	Choose the flash control mode for optional flash units mounted on the camera accessory shoe or adjust settings for wireless flash photography.
Wireless flash options	
Remote flash control	
Radio remote flash info	

Image area

Choose image area	Choose the image area (□ 87).
Auto DX crop	

Image quality (defaults to JPEG normal)

NEF (RAW) + JPEG fine★	Choose a file format and compression ratio (image quality, □ 92). The compression for options indicated by a star ("★") prioritizes quality, while that for images without a star gives priority to reducing file size.
NEF (RAW) + JPEG fine	
NEF (RAW) + JPEG normal★	
NEF (RAW) + JPEG normal	
NEF (RAW) + JPEG basic★	
NEF (RAW) + JPEG basic	
NEF (RAW)	
JPEG fine★	
JPEG fine	
JPEG normal★	
JPEG normal	
JPEG basic★	
JPEG basic	
TIFF (RGB)	

Image size

JPEG/TIFF	Choose the image size, in pixels (□ 95).
NEF (RAW)	Separate options are available for JPEG/TIFF and for NEF (RAW) images.

NEF (RAW) recording

NEF (RAW) compression	Choose the type of compression and the bit depth for NEF (RAW) images (📖 94).
NEF (RAW) bit depth	

ISO sensitivity settings

ISO sensitivity	Adjust ISO sensitivity settings for photographs (📖 124, 126).
Auto ISO sensitivity control	

White balance (defaults to **Auto**)

Auto	Match white balance to the light source (📖 159).
Incandescent	
Fluorescent	
Direct sunlight	
Flash	
Cloudy	
Shade	
Choose color temp.	
Preset manual	

Set Picture Control (defaults to **Standard**)

Standard	Choose how new photos will be processed. Select according to the type of scene or your creative intent (📖 179).
Neutral	
Vivid	
Monochrome	
Portrait	
Landscape	
Flat	

Manage Picture Control

Save/edit	Create custom Picture Controls (📖 184).
Rename	
Delete	
Load/save	



Color space	(defaults to sRGB)
sRGB	Choose a color space for photographs.
Adobe RGB	
Active D-Lighting	(defaults to Off)
Auto	Preserve details in highlights and shadows, creating photographs with natural contrast (□ 187).
Extra high 2	
Extra high 1	
High	
Normal	
Low	
Off	
Long exposure NR	(defaults to Off)
On	Reduce “noise” (bright spots or fog) in photos taken at slow shutter speeds.
Off	
High ISO NR	(defaults to Normal)
High	Reduce “noise” (randomly-spaced bright pixels) in photos taken at high ISO sensitivities.
Normal	
Low	
Off	
Vignette control	(defaults to Normal)
High	Reduce the drop in brightness at the edges of photographs when using type G, E, and D lenses (PC lenses excluded).
Normal	
Low	
Off	The effect is most noticeable at maximum aperture.
Auto distortion control	(defaults to Off)
On	Reduce barrel distortion when shooting with wide-angle lenses and to reduce pin-cushion distortion when shooting with long lenses.
Off	



Flicker reduction

Flicker reduction setting	This option takes effect during viewfinder photography (☐ 227). Select Enable for Flicker reduction setting to adjust shot timing to reduce the effects of flicker under fluorescent or mercury vapor lighting. The Flicker reduction indicator item controls whether a flicker detection indicator (FL ) is displayed in the viewfinder when flicker is detected.
Flicker reduction indicator	

Auto bracketing set

(defaults to **AE & flash**)

AE & flash	Choose the setting or settings bracketed when auto bracketing is in effect (☐ 146).
AE only	
Flash only	
WB bracketing	
ADL bracketing	

Multiple exposure

Multiple exposure mode	Record from two to ten NEF (RAW) exposures as a single photograph (☐ 229).
Number of shots	
Overlay mode	

HDR (high dynamic range)

HDR mode	Preserve details in highlights and shadows when photographing high-contrast scenes (☐ 189).
Exposure differential	
Smoothing	

Interval timer shooting

Start	Take photographs at the selected interval until the specified number of shots has been recorded (☐ 236).
Start options	
Interval	
No. of intervals×shots/interval	
Exposure smoothing	

Silent live view photography

(defaults to **Off**)

On	Mute shutter sounds when photographing in live view.
Off	



The Movie Shooting Menu:

Movie Shooting Options

Reset movie shooting menu

Yes	Select Yes to restore movie shooting menu options to their default values.
No	

File naming

Choose the three-letter prefix used in naming the image files in which movies are stored. The default prefix is "DSC".

Destination (defaults to **Slot 1**)

Slot 1	Choose the slot to which movies are recorded.
Slot 2	

Image area

Choose image area	Choose the image area (□ 69).
Auto DX crop	

Frame size/frame rate (defaults to **1920×1080; 60p**)

3840×2160; 30p	Choose movie frame size (in pixels) and frame rate (□ 67).
3840×2160; 25p	
3840×2160; 24p	
1920×1080; 60p	
1920×1080; 50p	
1920×1080; 30p	
1920×1080; 25p	
1920×1080; 24p	
1280× 720; 60p	
1280× 720; 50p	
1920×1080; 60p crop	
1920×1080; 50p crop	
1920×1080; 30p crop	
1920×1080; 25p crop	
1920×1080; 24p crop	



Movie quality	(defaults to High quality)
High quality	Choose movie quality (☞ 67).
Normal	
Movie ISO sensitivity settings	
ISO sensitivity (mode M)	Adjust ISO sensitivity settings for movies.
Auto ISO control (mode M)	
Maximum sensitivity	
White balance	(defaults to Same as photo settings)
Same as photo settings	Choose the white balance for movies
Auto	(☞ 159). Select Same as photo settings
Incandescent	to use the option currently selected for
Fluorescent	photos.
Direct sunlight	
Cloudy	
Shade	
Choose color temp.	
Preset manual	
Set Picture Control	(defaults to Same as photo settings)
Same as photo settings	Choose a Picture Control for movies
Standard	(☞ 179). Select Same as photo settings
Neutral	to use the option currently selected for
Vivid	photos.
Monochrome	
Portrait	
Landscape	
Flat	
Manage Picture Control	
Save/edit	Create custom Picture Controls (☞ 184).
Rename	
Delete	
Load/save	



Microphone sensitivity (defaults to Auto sensitivity)	
Auto sensitivity	Adjust microphone sensitivity.
Manual sensitivity	
Microphone off	
Frequency response (defaults to Wide range)	
Wide range	Choose microphone frequency response.
Vocal range	
Wind noise reduction (defaults to Off)	
On	Choose whether to enable the built-in microphone's low-cut filter to reduce wind noise.
Off	
High ISO NR (defaults to Normal)	
High	Reduce "noise" (randomly-spaced bright pixels) in movies recorded at high ISO sensitivities.
Normal	
Low	
Off	
Time-lapse movie	
Start	The camera automatically takes photos at selected intervals to create a silent time-lapse movie (☐ 74). Available with viewfinder photography only.
Interval	
Shooting time	
Exposure smoothing	
Flicker reduction (defaults to Auto)	
Auto	Reduce flicker and banding when shooting under fluorescent or mercury-vapor lighting during live view.
50 Hz	
60 Hz	
Electronic VR (defaults to Off)	
On	Choose whether to enable electronic vibration reduction in movie mode.
Off	

Custom Settings:

Fine-Tuning Camera Settings

Custom settings bank

A	Recall Custom Settings previously stored
B	in a Custom Settings menu bank.
C	Changes to settings are stored in the
D	current bank.

a Autofocus

a1 AF-C priority selection (defaults to **Release**)

Release	When AF-C is selected for viewfinder
Focus + release	photography, this option controls
Release + focus	whether photographs can be taken
Focus	whenever the shutter-release button is
	pressed (<i>release priority</i>) or only when
	the camera is in focus (<i>focus priority</i>).

a2 AF-S priority selection (defaults to **Focus**)

Release	When AF-S is selected for viewfinder
Focus	photography, this option controls
	whether photographs can be taken only
	when the camera is in focus (<i>focus</i>
	<i>priority</i>) or whenever the shutter-release
	button is pressed (<i>release priority</i>).

a3 Focus tracking with lock-on

Blocked shot AF response	Control how autofocus adjusts to
Subject motion	changes in the distance to the subject
	when AF-C is selected for viewfinder
	photography.



a4 3D-tracking face-detection (defaults to Off)	
On	Choose whether the camera detects and focuses on faces when 3D-tracking is selected for AF-area mode (☞ 104).
Off	
a5 3D-tracking watch area (defaults to Normal)	
Wide	Choose the area monitored by pressing the shutter-release button halfway when 3D-tracking is selected for AF-area mode (☞ 104).
Normal	
a6 Number of focus points (defaults to 55 points)	
55 points	Choose the number of focus points available for manual focus-point selection in the viewfinder.
15 points	
a7 Store by orientation (defaults to Off)	
Focus point	Choose whether the viewfinder stores the focus points and AF-area mode for vertical and horizontal orientations separately.
Focus point and AF-area mode	
Off	
a8 AF activation (defaults to Shutter/AF-ON)	
Shutter/AF-ON	Choose whether the camera focuses when the shutter-release button is pressed halfway. If AF-ON only is selected, the camera will not focus when the shutter-release button is pressed halfway.
AF-ON only	
a9 Limit AF-area mode selection	
Single-point AF	Choose the AF-area modes that can be selected using the AF-mode button and sub-command dial in viewfinder photography (☞ 104).
Dynamic-area AF (9 points)	
Dynamic-area AF (25 points)	
Dynamic-area AF (72 points)	
Dynamic-area AF (153 points)	
3D-tracking	
Group-area AF	
Group-area AF (HL)	
Group-area AF (VL)	
Auto-area AF	



a10 Autofocus mode restrictions (defaults to No restrictions)	
AF-S	Choose the autofocus modes available in viewfinder photography (📖 101).
AF-C	
No restrictions	
a11 Focus point wrap-around (defaults to No wrap)	
Wrap	Choose whether viewfinder focus-point selection “wraps around” from one edge of the display to another.
No wrap	
a12 Focus point options	
Manual focus mode	Adjust settings for the focus-point display in the viewfinder.
Focus point brightness	
Dynamic-area AF assist	
b Metering/exposure	
b1 ISO sensitivity step value (defaults to 1/3 step)	
1/3 step	Select the increments used when making adjustments to ISO sensitivity.
1/2 step	
1 step	
b2 EV steps for exposure ctrl (defaults to 1/3 step)	
1/3 step	Select the increments used when making adjustments to shutter speed, aperture, and bracketing.
1/2 step	
1 step	
b3 Exp./flash comp. step value (defaults to 1/3 step)	
1/3 step	Select the increments used when making adjustments to exposure and flash compensation.
1/2 step	
1 step	



b4 Easy exposure compensation (defaults to **Off**)

On (Auto reset)	Choose whether exposure compensation can be adjusted solely by rotating a command dial, without pressing the  button.
On	
Off	

b5 Matrix metering (defaults to **Face detection on**)

Face detection on	Choose Face detection on to enable face detection when shooting portraits with matrix metering during viewfinder photography ( 129).
Face detection off	

b6 Center-weighted area (defaults to ϕ **12 mm**)

ϕ 8 mm	Choose the size of the area given the most weight when center-weighted metering is used in viewfinder photography. If a non-CPU lens is attached, the size of the area is fixed at 12 mm.
ϕ 12 mm	
ϕ 15 mm	
ϕ 20 mm	
Average	

b7 Fine-tune optimal exposure

Matrix metering	Fine-tune exposure for each metering method. Higher values produce brighter exposures, lower values darker exposures.
Center-weighted metering	
Spot metering	
Highlight-weighted metering	

c Timers/AE lock**c1 Shutter-release button AE-L** (defaults to **Off**)



On (half press)	Choose whether exposure locks when the shutter-release button is pressed.
On (burst mode)	
Off	



c2 Standby timer (defaults to 6 s)	
4 s	Choose how long the camera continues to meter exposure when no operations are performed (📖 41).
6 s	
10 s	
30 s	
1 min	
5 min	
10 min	
30 min	
No limit	
c3 Self-timer	
Self-timer delay	Choose the length of the shutter release delay, the number of shots taken, and the interval between shots in self-timer mode.
Number of shots	
Interval between shots	
c4 Monitor off delay	
Playback	Choose how long the monitor remains on when no operations are performed.
Menus	
Information display	
Image review	
Live view	
d Shooting/display	
d1 Continuous shooting speed	
Continuous high-speed	Choose the frame advance rate for CH (continuous high-speed) and CL (continuous low-speed) modes.
Continuous low-speed	
d2 Max. continuous release (defaults to 200)	
1–200	Choose the maximum number of shots that can be taken in a single burst in continuous release mode.



d3 Limit release mode selection

Single frame	Choose the release modes that can be selected by pressing the  button and rotating the main command dial
Continuous L	
Continuous H	
Quiet shutter release	( 119).
Self-timer	
Mirror up	

d4 Sync. release mode options (defaults to **Sync**)

Sync	Choose whether the shutter releases on remote cameras synchronize with the shutter release on the master camera.
No sync	

d5 Exposure delay mode (defaults to **Off**)

3 s	In situations where the slightest camera movement can blur pictures, select 1 s , 2 s , or 3 s to delay shutter release until approximately one, two, or three seconds after the mirror is raised.
2 s	
1 s	
Off	

d6 Electronic front-curtain shutter (defaults to **Disable**)

Enable	Enable or disable the electronic front-curtain shutter in MUP mode, eliminating blur caused by shutter motion.
Disable	

d7 File number sequence (defaults to **On**)

On	Choose how the camera assigns file numbers.
Off	
Reset	

d8 Viewfinder grid display (defaults to **Off**)

On	Choose whether to display a framing grid in the viewfinder.
Off	

d9 LCD illumination (defaults to **Off**)

On	Choose whether the control panel and button backlights are illuminated while the standby timer is active.
Off	



e Bracketing/flash

e1 Flash sync speed

(defaults to 1/250 s)

1/250 s (Auto FP)

Choose a flash sync speed.

1/250 s

1/200 s

1/160 s

1/125 s

1/100 s

1/80 s

1/60 s

Fixing Shutter Speed at the Flash Sync Speed Limit

To fix shutter speed at the sync speed limit in shutter-priority auto or manual exposure modes, select the next shutter speed after the slowest possible shutter speed (30 s or - -). An X (flash sync indicator) will be displayed in the viewfinder and top control panel.

Auto FP High-Speed Sync

Auto FP high-speed sync allows the flash to be used at the highest shutter speed supported by the camera, making it possible to choose the maximum aperture for reduced depth of field even when the subject is backlit in bright sunlight. The information display flash mode indicator shows “FP” when auto FP high-speed sync is active.



e2 Flash shutter speed		(defaults to 1/60 s)
1/60 s	Choose the slowest shutter available when the flash is used in modes P and A .	
1/30 s		
1/15 s		
1/8 s		
1/4 s		
1/2 s		
1 s		
2 s		
4 s		
8 s		
15 s		
30 s		
e3 Exposure comp. for flash		(defaults to Entire frame)
Entire frame	Choose how the camera adjusts flash level when exposure compensation is used.	
Background only		
e4 Auto ↓ ISO sensitivity control		(defaults to Subject and background)
Subject and background	Choose whether auto ISO sensitivity control for flash photography is adjusted to correctly expose both the subject and background or the main subject only.	
Subject only		
e5 Modeling flash		(defaults to On)
On	Choose whether optional CLS-compatible flash units (□ 330) emit a modeling flash when the camera Pv button is pressed during viewfinder photography.	
Off		









e6 Auto bracketing (mode M) (defaults to **Flash/speed**)

Flash/speed	Choose the settings affected when exposure/flash bracketing is enabled in exposure mode M .
Flash/speed/aperture	
Flash/aperture	
Flash only	

e7 Bracketing order (defaults to **MTR > under > over**)

MTR > under > over	Choose the bracketing order for exposure, flash, and white balance bracketing.
Under > MTR > over	

f Controls**f1 Custom control assignment**

Preview button	Choose the roles assigned to camera controls, either alone or in combination with the command dials.
Preview button + 	
Fn1 button	
Fn1 button + 	
Fn2 button	
Fn2 button + 	
Fn button for vertical shooting	
Fn button for vertical shooting + 	
Fn3 button	
AF-ON button	
Sub-selector	
Sub-selector center	
Sub-selector center + 	
AF-ON button for vertical shooting	
Multi selector for vertical shooting	
BKT button + 	
Movie record button + 	
Lens focus function buttons	



f2 Multi selector center button

Shooting mode	Choose the role played by the center of the multi selector.
Playback mode	
Live view	

f3 Shutter spd & aperture lock

Shutter speed lock	Lock shutter speed at the value currently selected in mode S or M , or aperture at the value currently selected in mode A or M .
Aperture lock	

f4 Customize command dials

Reverse rotation	Choose the roles played by the main and sub-command dials.
Change main/sub	
Aperture setting	
Menus and playback	
Sub-dial frame advance	















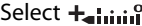

f5 Multi selector (defaults to **Do nothing**)

Restart standby timer	Choose whether using the multi selector activates the standby timer (☐ 41).
Do nothing	

f6 Release button to use dial (defaults to **No**)

Yes	Selecting Yes allows adjustments that are normally made by holding a button and rotating a command dial to be made by rotating the command dial after the button is released. Setting ends when the button is pressed again, the shutter-release button is pressed halfway, or the standby timer expires.
No	



f7 Reverse indicators		(defaults to )
		If  (-0+) is selected, the exposure indicators in the top control panel and information display are displayed with negative values on the left and positive values on the right. Select  (+0-) to display positive values on the left and negative values on the right.
f8 Live view button options		(defaults to Enable)
Enable	The  button can be disabled to prevent live view starting accidentally.	
Enable (standby timer active)		
Disable		
f9  switch		(defaults to LCD backlight ())
LCD backlight ()	Choose displays illuminated by rotating the power switch to  .	
 and information display		
g Movie		
g1 Custom control assignment		
Preview button	Choose the roles assigned to camera controls, either alone or in combination with the command dials, when the live view selector is rotated to  in live view.	
Preview button + 		
Fn1 button	Note that if Record movies is selected for Shutter-release button , the shutter-release button can not be used for any operation other than recording movies.	
Fn1 button + 		
Fn2 button		
Fn2 button + 		
Fn3 button		
Sub-selector center		
Sub-selector center + 		
Shutter-release button		



🔑 The Setup Menu: *Camera Setup*

Format memory card

Slot 1	To begin formatting, choose a memory card slot and select Yes . <i>Note that formatting permanently deletes all pictures and other data on the card in the selected slot.</i> Before formatting, be sure to make backup copies as required.
Slot 2	

Language

Choose a language for camera menus and messages.

Time zone and date

Time zone	Change time zones, set the camera clock, choose the date display order, and turn daylight saving time on or off.
Date and time	
Date format	
Daylight saving time	

Monitor brightness

Menus/playback	Adjust the brightness of the menu, playback, and live view displays.
Live view	

Monitor color balance

Adjust monitor color balance.

Virtual horizon

View a virtual horizon based on information from the camera tilt sensor.

Information display (defaults to **Auto**)

Auto	Adjust the information display for different viewing conditions.
Manual	

AF fine-tune

AF fine-tune (On/Off)	Fine-tune focus for different lens types. AF tuning is not recommended in most situations and may interfere with normal focus; use only when required.
Saved value	
Default	
List saved values	



Non-CPU lens data	
Lens number	Record the focal length and maximum aperture of non-CPU lenses, allowing them to be used with functions normally reserved for CPU lenses (☞ 243).
Focal length (mm)	
Maximum aperture	
Clean image sensor	
Clean now	Vibrate the low-pass filter to remove dust (☞ 345).
Clean at startup/shutdown	
Lock mirror up for cleaning	
	Lock the mirror up so that dust can be removed from the low-pass filter with a blower (☞ 347). Not available when the battery is low (🔋 or lower) or when Enable is selected for Network > Network connection in the setup menu.
Image Dust Off ref photo	
Start	Acquire reference data for the Image Dust Off option in Capture NX-D (☞ ii).
Clean sensor and then start	
Image comment	
Attach comment	Add a comment to new photographs as they are taken. Comments can be viewed as metadata in ViewNX-i or Capture NX-D (☞ ii).
Input comment	
Copyright information	
Attach copyright information	Add copyright information to new photographs as they are taken. Copyright information can be viewed as metadata in ViewNX-i or Capture NX-D (☞ ii).
Artist	
Copyright	
IPTC	
Edit/save	Create or modify IPTC presets and choose whether to embed them in new photos.
Delete	
Auto embed during shooting	
Load/save	



Voice memo options

Voice memo	Adjust voice memo settings (☞ 272).
Voice memo overwrite	
Voice memo control	
Audio output	

Beep

Volume	Choose the pitch and volume of the beep.
Pitch	

Touch controls

Enable/disable touch controls	Adjust touch control settings (☞ 12).
Full-frame playback flicks	

HDMI

Output resolution	Adjust settings for connection to HDMI devices (☞ 287).
Advanced	

Location data

Standby timer	Adjust settings for connection to GPS devices (☞ 247).
Position	
Set clock from satellite	

Wireless remote (WR) options

LED lamp	Adjust LED lamp and link mode settings for optional WR-R10 wireless remote controllers.
Link mode	

Assign remote (WR) Fn button (defaults to **None**)

Preview	Choose the role played by the Fn button on optional wireless remote controllers.
FV lock	
AE/AF lock	
AE lock only	
AE lock (Reset on release)	
AF lock only	
AF-ON	
↕Disable/enable	
+ NEF (RAW)	
Live view	
None	



Network	
Choose hardware	Adjust ftp and network settings for Ethernet and wireless LANs.
Network connection	
Network settings	
Options	
Slot empty release lock (defaults to Enable release)	
Release locked	Choose whether the shutter can be released when no memory card is inserted.
Enable release	
Battery info	
	View information on the battery currently inserted in the camera.
Save/load settings	
Save settings	Save camera settings to or load camera settings from a memory card. Settings files can be shared with other D5 cameras.
Load settings	
Reset all settings	
Reset	Reset all settings apart from the options selected for Language and Time zone and date in the setup menu.
Do not reset	
Firmware version	
	View the current camera firmware version.

Reset All Settings

Copyright information, IPTC presets, and other user-generated entries are also reset. We recommend that you save settings using the **Save/load settings** option in the setup menu before performing a reset.



The Retouch Menu: *Creating Retouched Copies*

NEF (RAW) processing

Create JPEG copies of NEF (RAW) photographs (☐ 317).

Trim

Create a cropped copy of the selected photograph (☐ 319).

Resize

Select image

Create small copies of selected photographs.

Choose destination

Choose size

D-Lighting

Brighten shadows. Choose for dark or backlit photographs.

Red-eye correction

Correct “red-eye” in photos taken with a flash.

Straighten

Create straightened copies. Copies can be straightened by up to 5° in increments of approximately 0.25°.

Distortion control

Auto

Manual

Create copies with reduced peripheral distortion. Use to reduce barrel distortion in photos taken with wide-angle lenses or pin-cushion distortion in photos taken with telephoto lenses. Select **Auto** to let the camera correct distortion automatically.



Perspective control

Create copies that reduce the effects of perspective taken from the base of a tall object.

Filter effects

Skylight

Create the effects of the following filters:

Warm filter

- **Skylight:** A skylight filter effect
- **Warm filter:** A warm tone filter effect

Monochrome

Black-and-white

Copy photographs in **Black-and-white**, **Sepia**, or **Cyanotype** (blue and white monochrome).

Sepia

Cyanotype

Image overlay

Image overlay combines two existing NEF (RAW) photographs to create a single picture that is saved separately from the originals (📖 320). **Image overlay** can only be selected by pressing **MENU** and selecting  tab.



Edit movie

Choose start/end point

Trim footage to create edited copies of movies or save selected frames as JPEG stills (📖 82).

Save selected frame

Side-by-side comparison

Compare retouched copies to the original photographs. **Side-by-side comparison** is only available if the retouch menu is displayed by pressing  while pressing and holding the  button or by pressing  and selecting **Retouch** in full-frame playback when a retouched image or original is displayed.



My Menu / Recent Settings

Add items

PLAYBACK MENU	Create a custom menu of up to 20 items selected from the playback, photo shooting, movie shooting, Custom Setting, setup, and retouch menus.
PHOTO SHOOTING MENU	
MOVIE SHOOTING MENU	
CUSTOM SETTING MENU	
SETUP MENU	
RETOUCH MENU	

Remove items

Delete items from My Menu.

Rank items

Rank items in My Menu.

Choose tab

(defaults to **MY MENU**)

MY MENU	Choose the menu displayed in the “My Menu/Recent Settings” tab. Select RECENT SETTINGS to display a menu listing the 20 most recently-used settings.
RECENT SETTINGS	



Retouch Menu Options

NEF (RAW) Processing

Create JPEG copies of NEF (RAW) photographs.

1 Select NEF (RAW) processing.

Highlight **NEF (RAW) processing** in the retouch menu and press **▶** to display a picture selection dialog listing only NEF (RAW) images created with this camera.

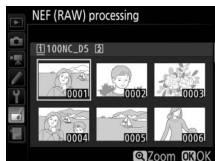

2 Select a photograph.

Use the multi selector to highlight a photograph (to view the highlighted photograph full frame, press and hold the **⊕** button). Press **⊙** to select the highlighted photograph and proceed to the next step.

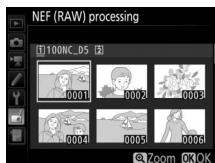

3 Choose settings for the JPEG copy.

Adjust the settings listed below. Note that white balance and vignette control are not available with multiple exposures or pictures created with image overlay and that exposure compensation can only be set to values between -2 and $+2$ EV.

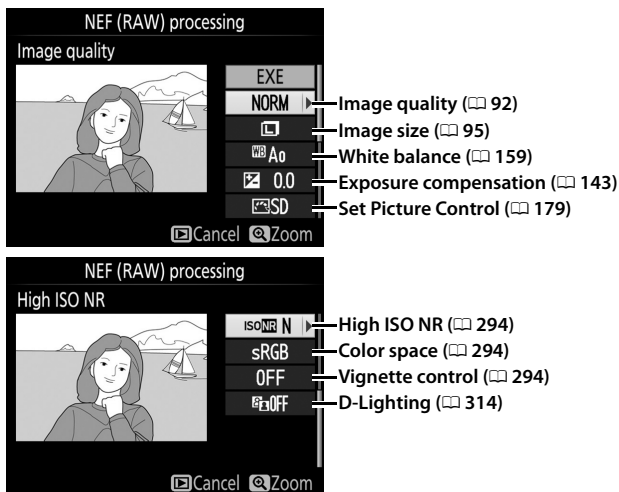









4 Copy the photograph.

Highlight **EXE** and press **OK** to create a JPEG copy of the selected photograph. To exit without copying the photograph, press the **MENU** button.



Trim

Create a cropped copy of the selected photograph. The selected photograph is displayed with the selected crop shown in yellow; create a cropped copy as described in the following table.

To	Use	Description
Reduce size of crop		Press  to reduce the size of the crop.
Increase size of crop		Press  to increase the size of the crop.
Change crop aspect ratio		Rotate the main command dial to choose the aspect ratio.
Position crop		Use multi selector to position the crop. Press and hold to move the crop rapidly to the desired position.
Preview crop		Press center of multi selector to preview cropped image.
Create copy		Save the current crop as a separate file.

Trim: Image Quality and Size

Copies created from NEF (RAW), NEF (RAW) + JPEG, or TIFF (RGB) photos have an image quality (□ 92) of JPEG fine★; cropped copies created from JPEG photos have the same image quality as the original. The size of the copy varies with crop size and aspect ratio and appears at upper left in the crop display.



Viewing Cropped Copies

Playback zoom may not be available when cropped copies are displayed.



Image Overlay

Image overlay combines two existing NEF (RAW) photographs to create a single picture that is saved separately from the originals; the results, which make use of RAW data from the camera image sensor, are noticeably better than photographs combined in an imaging application. The new picture is saved at current image quality and size settings; before creating an overlay, set image quality and size (☐ 92, 95; all options are available). To create a NEF (RAW) copy, choose an image quality of **NEF (RAW)** and an image size of **Large** (the overlay will be saved as a large NEF/RAW image even if **Small** or **Medium** is selected).

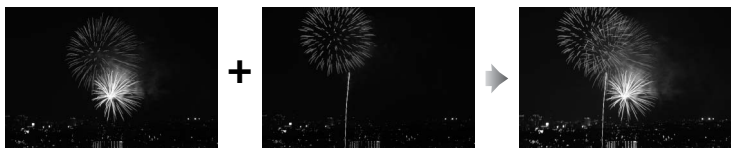



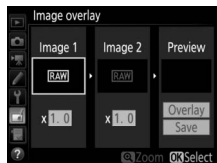

1 Select Image overlay.

Highlight **Image overlay** in the retouch menu and press . The dialog shown at right will be displayed, with **Image 1** highlighted; press to display a picture selection dialog listing only large NEF (RAW) images created with this camera (small and medium NEF/RAW images can not be selected).



2 Select the first image.



Use the multi selector to highlight the first photograph in the overlay. To view the highlighted photograph full frame, press and hold the  button. To view images in other locations, press  () and select the desired card and folder as described on page 249. Press  to select the highlighted photograph and return to the preview display.



3 Select the second image.

The selected image will appear as **Image 1**. Highlight **Image 2** and press , then select the second photo as described in Step 2.

4 Adjust gain.

Highlight **Image 1** or **Image 2** and optimize exposure for the overlay by pressing  or  to select the gain from values between 0.1 and 2.0. Repeat for the second image. The default value is 1.0; select 0.5 to halve gain or 2.0 to double it. The effects of gain are visible in the **Preview** column.

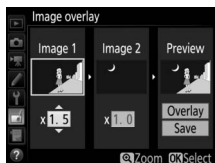

5 Preview the overlay.

To preview the composition as shown at right, press \leftarrow or \rightarrow to place the cursor in the **Preview** column, then press \uparrow or \downarrow to highlight **Overlay** and press \odot (note that colors and brightness in the preview may differ from the final image). To save the overlay without displaying a preview, select **Save**. To return to Step 4 and select new photos or adjust gain, press Q (\downarrow).

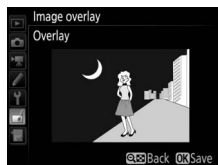

6 Save the overlay.

Press \odot while the preview is displayed to save the overlay. After an overlay is created, the resulting image will be displayed full-frame in the monitor.



Image Overlay

Only large NEF (RAW) photographs with the same image area and bit-depth can be combined.





The overlay has the same photo info (including date of recording, metering, shutter speed, aperture, exposure mode, exposure compensation, focal length, and image orientation) and values for white balance and Picture Control as the photograph selected for **Image 1**. The current image comment is appended to the overlay when it is saved; copyright information, however, are not copied. Overlays saved in NEF (RAW) format use the compression selected for **NEF (RAW) compression** in the **NEF (RAW) recording** menu and have the same bit depth as the original images.



Technical Notes





Read this chapter for information on compatible accessories, cleaning and storing the camera, and what to do if an error message is displayed or you encounter problems using the camera.

Compatible Lenses

Camera setting Lens/accessory	Focus mode		Exposure mode		Metering system			
	AF	M (with electronic rangefinder) ¹	P S	A M	 ²		 ³  ⁴	 ⁵
					3D	Color		
Type G, E, or D ⁷ ; AF-S, AF-P, AF-I	✓	✓	✓	✓	✓	—	✓ ⁸	✓
PC NIKKOR 19mm f/4E ED ⁹	—	✓ ¹⁰	✓ ¹⁰	✓ ¹⁰	✓ ¹⁰	—	✓ ^{8,10}	✓ ¹⁰
PC-E NIKKOR series ⁹	—	✓ ¹⁰	✓ ¹⁰	✓ ¹⁰	✓ ¹⁰	—	✓ ^{8,10}	✓ ¹⁰
PC Micro 85mm f/2.8D ^{9,11,12}	—	✓ ¹⁰	—	✓ ¹²	✓ ¹⁰	—	✓ ^{8,10}	✓ ¹⁰
AF-S / AF-I Teleconverter ¹³	✓	✓	✓	✓	✓	—	✓ ⁸	✓
Other AF NIKKOR (except lenses for F3AF)	✓ ¹⁴	✓ ¹⁴	✓	✓	—	✓	✓ ⁸	—
AI-P NIKKOR	—	✓ ¹⁵	✓	✓	—	✓	✓ ⁸	—

CPULenses⁶



Lens/accessory	Camera setting	Focus mode		Exposure mode		Metering system			
	AF	M (with electronic rangefinder) ¹	P S	A M	 ²		 ³	 ⁴	 ⁵
					3D	Color			
Non-CPU lenses ¹⁶	AI-, AI-modified NIKKOR or Nikon Series E lenses ¹⁷	—	✓ ¹⁵	—	✓ ¹⁸	—	✓ ¹⁹	✓ ²⁰	—
	Medical-NIKKOR 120mm f/4	—	✓	—	✓ ²¹	—	—	—	—
	Reflex-NIKKOR	—	—	—	✓ ¹⁸	—	—	✓ ²⁰	—
	PC-NIKKOR	—	✓ ⁹	—	✓ ²²	—	—	✓	—
	AI-type Teleconverter ²³	—	✓ ²⁴	—	✓ ¹⁸	—	✓ ¹⁹	✓ ²⁰	—
	PB-6 Bellows Focusing Attachment ²⁵	—	✓ ²⁴	—	✓ ²⁶	—	—	✓	—
	Auto extension rings (PK-series 11A, 12, or 13; PN-11)	—	✓ ²⁴	—	✓ ¹⁸	—	—	✓	—

- 1 Manual focus available with all lenses.
- 2 Matrix.
- 3 Center-weighted.
- 4 Spot.
- 5 Highlight-weighted.
- 6 IX-NIKKOR lenses can not be used.
- 7 Vibration Reduction (VR) supported with VR lenses.
- 8 Spot metering meters selected focus point (□ 129).
- 9 Fog, lines, and other image artifacts (“noise”) may appear in photos taken with the electronic front-curtain shutter. This can be prevented by selecting **Disable** for Custom Setting d6 (**Electronic front-curtain shutter**, □ 304).
- 10 Can not be used with shifting or tilting.
- 11 The camera's exposure metering and flash control systems do not work properly when shifting and/or tilting the lens, or when an aperture other than the maximum aperture is used.
- 12 Manual exposure mode only.
- 13 For information on the focus points available for autofocus and electronic rangefinding, see page 100.

- 14 When focusing at minimum focus distance with AF 80–200mm f/2.8, AF 35–70mm f/2.8, AF 28–85mm f/3.5–4.5 <New>, or AF 28–85mm f/3.5–4.5 lens at maximum zoom, in-focus indicator may be displayed when image on matte screen in viewfinder is not in focus. Adjust focus manually until image in viewfinder is in focus.
- 15 With maximum aperture of f/5.6 or faster.
- 16 Some lenses can not be used (see page 327).
- 17 Range of rotation for AI 80–200mm f/2.8 ED tripod mount is limited by camera body. Filters can not be exchanged while AI 200–400mm f/4 ED is mounted on camera.
- 18 If maximum aperture is specified using **Non-CPU lens data** (□ 243), aperture value will be displayed in viewfinder and top control panel.
- 19 Can be used only if lens focal length and maximum aperture are specified using **Non-CPU lens data** (□ 243). Use spot or center-weighted metering if desired results are not achieved.
- 20 For improved precision, specify lens focal length and maximum aperture using **Non-CPU lens data** (□ 243).
- 21 Can be used in manual exposure mode at shutter speeds slower than flash sync speed by one step or more.
- 22 Exposure determined by presetting lens aperture. In aperture-priority auto exposure mode, preset aperture using lens aperture ring before performing AE lock and shifting lens. In manual exposure mode, preset aperture using lens aperture ring and determine exposure before shifting lens.
- 23 Exposure compensation required when used with AI 28–85mm f/3.5–4.5, AI 35–105mm f/3.5–4.5, AI 35–135mm f/3.5–4.5, or AF-S 80–200mm f/2.8D.
- 24 With maximum effective aperture of f/5.6 or faster.
- 25 Requires PK-12 or PK-13 auto extension ring. PB-6D may be required depending on camera orientation.
- 26 Use preset aperture. In aperture-priority auto exposure mode, set aperture using focusing attachment before determining exposure and taking photograph.
 - PF-4 Reprocopy Outfit requires PA-4 Camera Holder.
 - Noise in the form of lines may appear during autofocus at high ISO sensitivities. Use manual focus or focus lock. Lines may also appear at high ISO sensitivities when aperture is adjusted during movie recording or live view photography.

✎ Recognizing CPU and Type G, E, and D Lenses

CPU lenses (particularly types G, E, and D) are recommended, but note that IX-NIKKOR lenses can not be used. CPU lenses can be identified by the presence of CPU contacts, type G, E, and D lenses by a letter on the lens barrel. Type G and E lenses are not equipped with a lens aperture ring.

CPU contacts

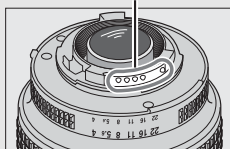

CPU lens

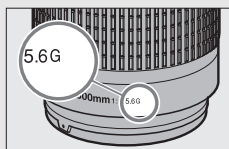

Type G/E lens

Aperture ring

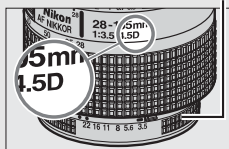

Type D lens

✎ Lens f-number

The f-number given in lens names is the maximum aperture of the lens.

✎ Compatible Non-CPU Lenses

Non-CPU lens data (📖 243) can be used to enable many of the features available with CPU lenses, including color matrix metering; if no data are provided, center-weighted metering will be used in place of color matrix metering, while if the maximum aperture is not provided, the camera aperture display will show the number of stops from maximum aperture and the actual aperture value must be read off the lens aperture ring.

Incompatible Accessories and Non-CPU Lenses

The following can NOT be used with the D5:

- TC-16A AF teleconverter
- Non-AI lenses
- Lenses that require the AU-1 focusing unit (400mm f/4.5, 600mm f/5.6, 800mm f/8, 1200mm f/11)
- Fisheye (6mm f/5.6, 7.5mm f/5.6, 8mm f/8, OP 10mm f/5.6)
- 2.1cm f/4
- Extension Ring K2
- 180–600mm f/8 ED (serial numbers 174041–174180)
- 360–1200mm f/11 ED (serial numbers 174031–174127)
- 200–600mm f/9.5 (serial numbers 280001–300490)
- AF lenses for the F3AF (AF 80mm f/2.8, AF 200mm f/3.5 ED, AF Teleconverter TC-16)
- PC 28mm f/4 (serial number 180900 or earlier)
- PC 35mm f/2.8 (serial numbers 851001–906200)
- PC 35mm f/3.5 (old type)
- Reflex 1000mm f/6.3 (old type)
- Reflex 1000mm f/11 (serial numbers 142361–143000)
- Reflex 2000mm f/11 (serial numbers 200111–200310)

VR Lenses

The lenses listed below are not recommended for long exposures or photographs taken at high ISO sensitivities, as due to the design of the vibration reduction (VR) control system the resulting photos may be marred by fog. We recommend turning vibration reduction off when using other VR lenses.

- AF-S VR Zoom-Nikkor 24–120mm f/3.5–5.6G IF-ED
- AF-S VR Zoom-Nikkor 70–200mm f/2.8G IF-ED
- AF-S VR Zoom-Nikkor 70–300mm f/4.5–5.6G IF-ED
- AF-S VR Nikkor 200mm f/2G IF-ED
- AF-S VR Nikkor 300mm f/2.8G IF-ED
- AF-S NIKKOR 16–35mm f/4G ED VR
- AF-S NIKKOR 24–120mm f/4G ED VR
- AF-S NIKKOR 28–300mm f/3.5–5.6G ED VR
- AF-S NIKKOR 400mm f/2.8G ED VR
- AF-S NIKKOR 500mm f/4G ED VR
- AF-S DX VR Zoom-Nikkor 18–200mm f/3.5–5.6G IF-ED
- AF-S DX NIKKOR 16–85mm f/3.5–5.6G ED VR
- AF-S DX NIKKOR 18–200mm f/3.5–5.6G ED VR II
- AF-S DX Micro NIKKOR 85mm f/3.5G ED VR
- AF-S DX NIKKOR 55–300mm f/4.5–5.6G ED VR

Calculating Angle of View

The camera can be used with Nikon lenses for 35 mm (135) format cameras. If a 35 mm format lens is attached, the angle of view will be the same as a frame of 35 mm film (35.9×23.9 mm).

If desired, the **Image area** option in the photo shooting menu can be used to choose an angle of view different from that of the current lens. If a 35 mm format lens is attached, you can reduce the angle of view by $1.5\times$ or $1.2\times$ by selecting **DX (24×16)** or **1.2× (30×20)** to expose a smaller area, or change the aspect ratio by selecting **5 : 4 (30×24)**. The sizes of the areas exposed by different **Image area** options are shown below.

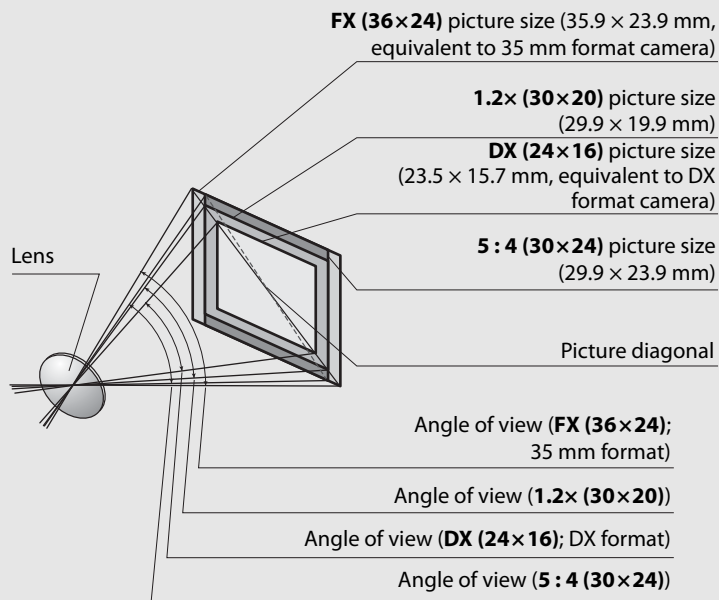

Calculating Angle of View (Continued)

The **DX (24×16)** angle of view is about 1.5 times smaller than the 35 mm format angle of view, while the **1.2× (30×20)** angle of view is about 1.2 times smaller and the **5 : 4 (30×24)** angle of view is about 1.1 times smaller. To calculate the focal length of lenses in 35 mm format when **DX (24×16)** is selected, multiply the focal length of the lens by about 1.5, by about 1.2 when **1.2× (30×20)** is selected, or by about 1.1 when **5 : 4 (30×24)** is selected (for example, the effective focal length of a 50mm lens in 35 mm format would be approximately 75 mm when **DX (24×16)** is selected, 60 mm when **1.2× (30×20)** is selected, or 55 mm when **5 : 4 (30×24)** is selected).

The Nikon Creative Lighting System (CLS)



Nikon's advanced Creative Lighting System (CLS) offers improved communication between the camera and compatible flash units for improved flash photography.

■ CLS-Compatible Flash Units

The camera can be used with the following CLS-compatible flash units:

- **The SB-5000, SB-910, SB-900, SB-800, SB-700, SB-600, SB-500, SB-400, SB-300, and SB-R200:**

	SB-5000 ^{1,2}	SB-910, SB-900 ¹	SB-800	SB-700 ¹	SB-600	SB-500 ³	SB-400 ⁴	SB-300 ⁴	SB-R200 ⁵
Guide No. (ISO 100) ⁶	34.5/113	34/111	38/125	28/92	30/98	24/78	21/69	18/59	10/33

- 1 If a color filter is attached to the SB-5000, SB-910, SB-900, or SB-700 when **AUTO** or  (flash) is selected for white balance, the camera will automatically detect the filter and adjust white balance appropriately.
- 2 Radio AWL available with optional WR-R10 wireless remote controller (□ 337).
- 3 Users of the LED light can set camera white balance to **AUTO** or  for optimal results.
- 4 Wireless flash control is not available.
- 5 Controlled remotely using optional SB-5000, SB-910, SB-900, SB-800, SB-700, or SB-500 flash unit or SU-800 wireless Speedlight commander.
- 6 m/ft, SB-5000, SB-910, SB-900, SB-800, SB-700, and SB-600 at 35 mm zoom head position; SB-5000, SB-910, SB-900, and SB-700 with standard illumination.

Guide Number

To calculate the range of the flash at full power, divide the Guide Number by the aperture. If, for example, the flash unit has a Guide Number of 34 m or 111 ft (ISO 100); its range at an aperture of f/5.6 is $34 \div 5.6$ or about 6.1 meters (or in feet, $111 \div 5.6 =$ approximately 19 ft 10 in.). For each twofold increase in ISO sensitivity, multiply the Guide Number by the square root of two (approximately 1.4).

The following features are available with CLS-compatible flash units:

		SB-5000	SB-910, SB-900, SB-800	SB-700	SB-600	SB-500	SU-800	SB-R200	SB-400	SB-300		
Single flash	i-TTL	i-TTL balanced fill-flash for digital SLR ¹	✓	✓	✓	✓	✓	—	—	✓	✓	
		Standard i-TTL fill-flash for digital SLR	✓ ²	✓ ²	✓	✓ ²	✓	—	—	✓	✓	
	 A	Auto aperture	✓	✓ ³	—	—	—	—	—	—	—	
	A	Non-TTL auto	— ⁴	✓ ³	—	—	—	—	—	—	—	
	GN	Distance-priority manual	✓	✓	✓	—	—	—	—	—		
	M	Manual	✓	✓	✓	✓	✓ ⁵	—	—	✓ ⁵	✓ ⁵	
	RPT	Repeating flash	✓	✓	—	—	—	—	—	—	—	
Optical Advanced Wireless Lighting	Master	Remote flash control	✓	✓	✓	—	✓ ⁵	✓	—	—	—	
		i-TTL	i-TTL	✓	✓	✓	—	✓ ⁵	—	—	—	
		[A:B]	Quick wireless flash control	✓	—	✓	—	—	✓ ⁶	—	—	—
		 A	Auto aperture	✓	✓	—	—	—	—	—	—	
		A	Non-TTL auto	—	— ⁷	—	—	—	—	—	—	
	Remote	M	Manual	✓	✓	✓	—	✓ ⁵	—	—	—	
		RPT	Repeating flash	✓	✓	—	—	—	—	—	—	
		i-TTL	i-TTL	✓	✓	✓	✓	✓	—	✓	—	
		[A:B]	Quick wireless flash control	✓	✓	✓	✓	✓	—	✓	—	
		 A/ A	Auto aperture/ Non-TTL auto	✓ ⁸	✓ ⁸	—	—	—	—	—	—	
	M	Manual	✓	✓	✓	✓	—	✓	—	—		
	RPT	Repeating flash	✓	✓	✓	✓	—	—	—	—		
Radio-controlled Advanced Wireless Lighting		✓ ⁹	—	—	—	—	—	—	—	—		
Color Information Communication (flash)		✓	✓	✓	✓	✓	—	—	✓	✓		
Color Information Communication (LED light)		—	—	—	—	✓	—	—	—	—		

	SB-5000	SB-910, SB-900, SB-800	SB-700	SB-600	SB-500	SU-800	SB-R200	SB-400	SB-300
Auto FP High-Speed Sync ¹⁰	✓	✓	✓	✓	✓	✓	✓	—	—
FV lock ¹¹	✓	✓	✓	✓	✓	✓	✓	✓	✓
AF-assist for multi-area AF	✓	✓	✓	✓	—	✓ ¹²	—	—	—
Red-eye reduction	✓	✓	✓	✓	✓	—	—	✓	—
Camera modeling illumination	✓	✓	✓	✓	✓	✓	✓	—	—
Unified flash control	✓	—	—	—	✓	—	—	✓	✓
Camera flash unit firmware update	✓	✓ ¹³	✓	—	✓	—	—	—	✓

1 Not available with spot metering.

2 Can also be selected with flash unit.

3  A/A mode selection performed on flash unit using custom settings. Unless lens data have been provided using the **Non-CPU lens data** option in the setup menu, "A" will be selected when a non-CPU lens is used.

4 Unless lens data have been provided using the **Non-CPU lens data** option in the setup menu, non-TTL auto will be selected when a non-CPU lens is used.

5 Can only be selected with camera.

6 Available only during close-up photography.

7 Unless lens data have been provided using the **Non-CPU lens data** option in the setup menu, non-TTL auto (A) is used with non-CPU lenses, regardless of mode selected with flash unit.

8 Choice of  A and A depends on the option selected with master flash.

9 Supports the same features as remote flash units with optical AWL.

10 Available only in i-TTL,  A, A, GN, and M flash-control modes.

11 Available only in i-TTL flash control mode or when flash is set to emit monitor pre-flashes in  A or A flash control mode.

12 Available only in commander mode.

13 Firmware updates for the SB-910 and SB-900 can be performed from the camera.

- **SU-800 Wireless Speedlight Commander:** When mounted on a CLS-compatible camera, the SU-800 can be used as a commander for SB-5000, SB-910, SB-900, SB-800, SB-700, SB-600, SB-500, or SB-R200 flash units in up to three groups. The SU-800 itself is not equipped with a flash.



Modeling Illumination

CLS-compatible flash units emit a modeling flash when the camera **Pv** button is pressed. This feature can be used with Advanced Wireless Lighting to preview the total lighting effect achieved with multiple flash units. Modeling illumination can be turned off using Custom Setting e5 (**Modeling flash**;  306).

Other Flash Units

The following flash units can be used in non-TTL auto and manual modes.

Flash unit		SB-80DX, SB-28DX, SB-28, SB-26, SB-25, SB-24	SB-50DX	SB-30, SB-27 ¹ , SB-22S, SB-22, SB-20, SB-16B, SB-15	SB-23, SB-29 ² , SB-21B ² , SB-29S ²
A	Non-TTL auto	✓	—	✓	—
M	Manual	✓	✓	✓	✓
	Repeating flash	✓	—	—	—
REAR	Rear-curtain sync ³	✓	✓	✓	✓

- 1 Flash mode is automatically set to TTL and shutter-release is disabled. Set flash unit to **A** (non-TTL auto flash).
- 2 Autofocus is available with AF-S VR Micro-Nikkor 105mm f/2.8G IF-ED and AF-S Micro NIKKOR 60mm f/2.8G ED lenses only.
- 3 Available when camera is used to select flash mode.

Notes on Optional Flash Units

Refer to the flash unit manual for detailed instructions. If the unit supports CLS, refer to the section on CLS-compatible digital SLR cameras. The D5 is not included in the “digital SLR” category in the SB-80DX, SB-28DX, and SB-50DX manuals.

i-TTL flash control can be used at ISO sensitivities between 100 and 12800. At values over 12800, the desired results may not be achieved at some ranges or aperture settings. If the flash-ready indicator (⚡) flashes for about three seconds after a photograph is taken in i-TTL or non-TTL auto mode, the flash has fired at full power and the photograph may be underexposed (CLS-compatible flash units only).

When an SC-series 17, 28, or 29 sync cable is used for off-camera flash photography, correct exposure may not be achieved in i-TTL mode. We recommend that you select standard i-TTL fill-flash. Take a test shot and view the results in the monitor.

In i-TTL, use the flash panel or bounce adapter provided with the flash unit. Do not use other panels such as diffusion panels, as this may produce incorrect exposure.

In exposure mode **P**, the maximum aperture (minimum f-number) is limited according to ISO sensitivity, as shown below:

Maximum aperture at ISO equivalent of:							
100	200	400	800	1600	3200	6400	12800
4	5	5.6	7.1	8	10	11	13



If the maximum aperture of the lens is smaller than given above, the maximum value for aperture will be the maximum aperture of the lens.

Noise in the form of lines may appear in flash photographs taken with an SD-9 or SD-8A power pack attached directly to the camera. Reduce ISO sensitivity or increase the distance between the camera and the power pack.



✓ Notes on Optional Flash Units (Continued)

The SB-5000, SB-910, SB-900, SB-800, SB-700, SB-600, SB-500, and SB-400 provide red-eye reduction, while the SB-5000, SB-910, SB-900, SB-800, SB-700, SB-600, and SU-800 provide AF-assist illumination with the following restrictions:



- **SB-5000:** AF-assist illumination is available when 24–135 mm AF lenses are used with the focus points shown below.

24–49 mm	50–84 mm	85–135 mm
		

- **SB-910 and SB-900:** AF-assist illumination is available when 17–135 mm AF lenses are used with the focus points shown below.

17–19 mm	20–135 mm
	

- **SB-800, SB-600, and SU-800:** AF-assist illumination is available when 24–105 mm AF lenses are used with the focus points shown below.

24–34 mm	35–49 mm	50–105 mm
		

- **SB-700:** AF-assist illumination is available when 24–135 mm AF lenses are used with the focus points shown below.

24–27 mm	28–135 mm
	

Depending on the lens used and scene recorded, the in-focus indicator (●) may be displayed when the subject is not in focus, or the camera may be unable to focus and the shutter release will be disabled.



Other Accessories

At the time of writing, the following accessories were available for the D5.

Power sources	<ul style="list-style-type: none">• Rechargeable Li-ion Battery EN-EL18c (□ 19, 22): EN-EL18b, EN-EL18a, and EN-EL18 batteries can also be used. Additional EN-EL18c batteries are available from local retailers and Nikon service representatives.• Battery Charger MH-26a (□ 19, 380): The MH-26a can be used to recharge and calibrate EN-EL18c, EN-EL18b, EN-EL18a, and EN-EL18 batteries.• Power Connector EP-6, AC Adapter EH-6b: These accessories can be used to power the camera for extended periods (EH-6a and EH-6 AC adapters can also be used). The EP-6 is required to connect the EH-6b to the camera; see page 342 for details.
Filters	<ul style="list-style-type: none">• Filters intended for special-effects photography may interfere with autofocus or the electronic rangefinder.• The D5 can not be used with linear polarizing filters. Use the C-PL or C-PLII circular polarizing filter instead.• Use Neutral Color (NC) filters to protect the lens.• To prevent ghosting, use of a filter is not recommended when the subject is framed against a bright light, or when a bright light source is in the frame.• Center-weighted metering is recommended with filters with exposure factors (filter factors) over 1× (Y44, Y48, Y52, O56, R60, X0, X1, C-PL, ND2S, ND4, ND4S, ND8, ND8S, ND400, A2, A12, B2, B8, B12). See the filter manual for details.



**Wireless LAN
adapters**
(📖 281)

- **Wireless Transmitter WT-6/WT-5:** Connect the WT-6 or WT-5 to the camera's peripheral connector to upload pictures over a wireless network, to control the camera from a computer running Camera Control Pro 2 (available separately), or to take and browse pictures remotely from a computer or smart device.

Note: A wireless network and some basic network knowledge is required when using a wireless transmitter. Be sure to update the wireless transmitter software to the latest version.

**Wireless
remote
controllers**

- **Wireless Remote Controller WR-R10/WR-T10:** When a WR-R10 wireless remote controller is attached to ten-pin remote terminal using a WR-A10 adapter, the camera can be controlled wirelessly using a WR-T10 wireless remote controller. The WR-R10 can also be used to control radio-controlled flash units.
- **Wireless Remote Controller WR-1:** WR-1 units are used with WR-R10 or WR-T10 wireless remote controllers or with other WR-1 remote controllers, with the WR-1 units functioning as either transmitters or receivers. For example, a WR-1 can be attached to the ten-pin remote terminal and used as a receiver, allowing the shutter to be released remotely by another WR-1 acting as a transmitter.

Note: Be sure the firmware for the WR-R10 and WR-1 has been updated to the latest version. For information on firmware updates, see the Nikon website for your area.



Viewfinder eyepiece accessories

- **Rubber Eyecup DK-19:** The DK-19 makes the image in the viewfinder easier to see, preventing eye fatigue.
- **Dioptr-Adjustment Viewfinder Lens DK-17C:** To accommodate individual differences in vision, viewfinder lenses are available with diopters of -3 , -2 , 0 , $+1$, and $+2 \text{ m}^{-1}$. Use diopter adjustment lenses only if the desired focus can not be achieved with the built-in diopter adjustment control (-3 to $+1 \text{ m}^{-1}$). Test diopter adjustment lenses before purchase to ensure that the desired focus can be achieved.
- **Magnifying Eyepiece DK-17M:** The DK-17M magnifies the view through the viewfinder by approximately $1.2 \times$ for greater precision when framing.
- **Eyepiece Magnifier DG-2:** The DG-2 magnifies the scene at the center of the viewfinder for more accurate focus. DK-18 eyepiece adapter (available separately) required.
- **Eyepiece Adapter DK-18:** The DK-18 is used when attaching the DG-2 magnifier or DR-3 right-angle viewing attachment to the D5.
- **Eyepiece Adapter DK-27:** A DK-27 is supplied with the camera.
- **Antifog Finder Eyepiece DK-14/Antifog Finder Eyepiece DK-17A:** These viewfinder eyepieces prevent fogging in humid or cold conditions.
- **Fluorine-Coated Finder Eyepiece DK-17F:** A DK-17F is supplied with the camera. The protective glass features an easy-to-clean fluorine coating on both surfaces.
- **Right-Angle Viewing Attachment DR-5/Right-Angle Viewing Attachment DR-4:** The DR-5 and DR-4 attach to the viewfinder eyepiece at a right angle, allowing the image in the viewfinder to be viewed from above when the camera is in the horizontal shooting position. The DR-5 supports diopter adjustment and can also magnify the view through the viewfinder by $2 \times$ for greater precision when framing (note that the edges of the frame will not be visible when the view is magnified).

HDMI cables (☞ 286)	HDMI Cable HC-E1: An HDMI cable with a type C connector for connection to the camera and a type A connector for connection to HDMI devices.
Software	<ul style="list-style-type: none"> • Camera Control Pro 2: Control the camera remotely from a computer and save photographs directly to the computer hard disk. When Camera Control Pro 2 is used to capture photographs directly to the computer, a PC connection indicator (P E) will appear in the top control panel. <p>Note: Use the latest versions of Nikon software; see the websites listed on page xix for the latest information on supported operating systems. At default settings, Nikon Message Center 2 will periodically check for updates to Nikon software and firmware while you are logged in to an account on the computer and the computer is connected to the Internet. A message is automatically displayed when an update is found.</p>
Body caps	Body Cap BF-1B/Body Cap BF-1A: The body cap keeps the mirror, viewfinder screen, and low-pass filter free of dust when a lens is not in place.
Remote terminal accessories	<p>The D5 is equipped with a ten-pin remote terminal (☞ 2) for remote control and automatic photography. The terminal is provided with a cap, which protects the contacts when the terminal is not in use. The following accessories can be used (all lengths are approximate):</p> <ul style="list-style-type: none"> • Remote Cord MC-22/MC-22A: Remote shutter release with blue, yellow, and black terminals for connection to a remote shutter-triggering device, allowing control via sound or electronic signals (length 1 m/3 ft 3 in.). • Remote Cord MC-30/MC-30A: Remote shutter release; can be used to reduce camera shake (length 80 cm/2 ft 7 in.). • Remote Cord MC-36/MC-36A: Remote shutter release; can be used for interval timer photography or to reduce camera shake or keep the shutter open during a time exposure (length 85 cm/2 ft 9 in.).

Remote
terminal
accessories

- **Extension Cord MC-21/MC-21A:** Can be connected to ML-3 or MC-series 20, 22, 22A, 23, 23A, 25, 25A, 30, 30A, 36, or 36A. Only one MC-21 or MC-21A can be used at a time (length 3 m/9 ft 10 in.).
- **Connecting Cord MC-23/MC-23A:** Connects two cameras with ten-pin remote terminals for simultaneous operation (length 40 cm/1 ft 4 in.).
- **Adapter Cord MC-25/MC-25A:** Ten-pin to two-pin adapter cord for connection to devices with two-pin terminals, including the MW-2 radio control set, MT-2 intervalometer, and ML-2 modulite control set (length 20 cm/8 in.).
- **WR Adapter WR-A10:** An adapter used to connect WR-R10 wireless remote controllers to cameras with ten-pin remote terminals.
- **GPS Unit GP-1/GP-1A** (☐ 246): Record latitude, longitude, altitude, and UTC time with pictures.
- **GPS Adapter Cord MC-35** (☐ 246): This 35 cm (1 ft 2 in.) cable connects the camera to older GARMIN eTrex- and geko-series GPS units that conform to version 2.01 or 3.01 of the National Marine Electronics Association NMEA0183 data format. Only models that support PC interface cable connections are supported; the MC-35 can not be used to connect GPS units via USB. The units connect to the MC-35 using a cable with a D-sub 9-pin connector provided by the manufacturer of the GPS device; see the MC-35 instruction manual for details. Before turning the camera on, set the GPS device to NMEA mode (4800 baud); for more information, see the documentation provided with the GPS device.
- **Modulite Remote Control Set ML-3:** Allows infrared remote control at ranges of up to 8 m (26 ft 3 in.).

Microphones	<ul style="list-style-type: none"> • Stereo Microphone ME-1: Connect the ME-1 to the camera microphone jack to record stereo sound and reduce the chance of picking up equipment noise (such as the sounds produced by the lens during autofocus; □ 64). • Wireless Microphone ME-W1: Use this wireless Bluetooth microphone for off-camera recording.
Connector cover	Connector Cover for Stereo Mini-Plug Cables UF-6: Prevents accidental disconnection of mini-plug cables for optional ME-1 stereo microphones.

Availability may vary with country or region. See our website or brochures for the latest information.

Removing the Eyepiece Adapter

Press and lift the latches on either side (①) and remove the adapter as shown (②).

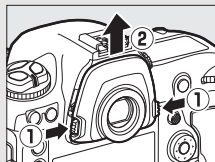

Connector Covers for Stereo Mini-Plug Cables

The cover attaches as shown.

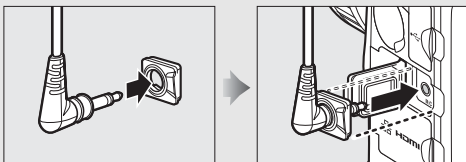

Attaching a Power Connector and AC Adapter

Adapter

Turn the camera off before attaching an optional power connector and AC adapter.

1 Remove the battery-chamber cover.

Lift the battery-chamber cover latch, turn it to the open (⊞) position (①), and remove the BL-6 battery-chamber cover (②).

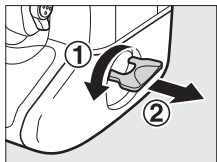

2 Connect the AC adapter.

Pass the DC cable over the power connector cable guide (①) and slide it down until it is at the bottom of the slot, and then insert the DC plug into the DC IN connector (②).

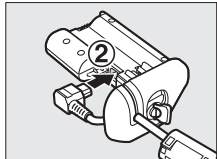
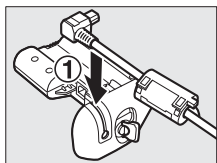

3 Insert the power connector.

Fully insert the power connector into the battery chamber as shown.

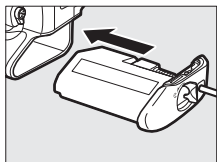

4 Latch the power connector.

Rotate the latch to the closed position (①) and fold it down as shown (②). To prevent the power connector being dislodged during operation, be sure that it is securely latched.

The battery level is not displayed in the top control panel while the camera is powered by the AC adapter and power connector.

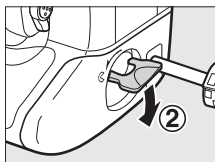
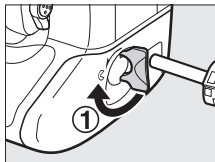

Caring for the Camera

Storage

When the camera will not be used for an extended period, remove the battery and store it in a cool, dry area with the terminal cover in place. To prevent mold or mildew, store the camera in a dry, well-ventilated area. Do not store your camera with naphtha or camphor moth balls or in locations that:

- are poorly ventilated or subject to humidities of over 60%
- are next to equipment that produces strong electromagnetic fields, such as televisions or radios
- are exposed to temperatures above 50 °C (122 °F) or below -10 °C (14 °F)

Cleaning

Camera body	Use a blower to remove dust and lint, then wipe gently with a soft, dry cloth. After using the camera at the beach or seaside, wipe off sand or salt with a cloth lightly dampened in distilled water and dry thoroughly. Important: <i>Dust or other foreign matter inside the camera may cause damage not covered under warranty.</i>
Lens, mirror, and viewfinder	These glass elements are easily damaged. Remove dust and lint with a blower. If using an aerosol blower, keep the can vertical to prevent the discharge of liquid. To remove fingerprints and other stains, apply a small amount of lens cleaner to a soft cloth and clean with care.
Monitor	Remove dust and lint with a blower. When removing fingerprints and other stains, wipe the surface lightly with a soft cloth or chamois leather. Do not apply pressure, as this could result in damage or malfunction.

Do not use alcohol, thinner, or other volatile chemicals.

The Low-Pass Filter

The image sensor that acts as the camera's picture element is fitted with a low-pass filter to prevent moiré. If you suspect that dirt or dust on the filter is appearing in photographs, you can clean the filter using the **Clean image sensor** option in the setup menu. The filter can be cleaned at any time using the **Clean now** option, or cleaning can be performed automatically when the camera is turned on or off.

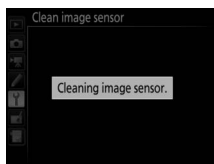
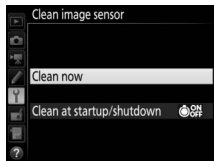
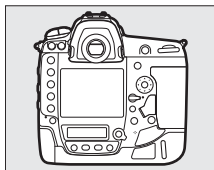

■ ■ "Clean Now"

Holding the camera base down, select **Clean image sensor** in the setup menu, then highlight **Clean now** and press **OK**. The camera will check the image sensor and then begin cleaning. **b u 5 Y** flashes in the top control panel and other operations can not be performed while cleaning is in progress. Do not remove or disconnect the power source until cleaning ends and the setup menu is displayed.



■ “Clean at Startup/Shutdown”

Choose from the following options:

Option	Description
 Clean at startup	The image sensor is automatically cleaned each time the camera is turned on.
 Clean at shutdown	The image sensor is automatically cleaned during shutdown each time the camera is turned off.
 Clean at startup & shutdown	The image sensor is cleaned automatically at startup and at shutdown.
Cleaning off	Automatic image sensor cleaning off.

1 Select Clean at startup/shutdown.

Display the **Clean image sensor** menu as described on page 345. Highlight **Clean at startup/shutdown** and press .

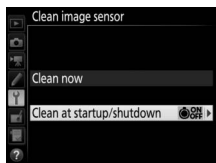

2 Select an option.

Highlight an option and press .

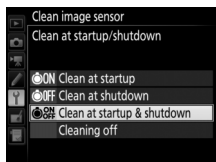

✔ Image Sensor Cleaning

Using camera controls during startup interrupts image sensor cleaning.

Cleaning is performed by vibrating the low-pass filter. If dust can not be fully removed using the options in the **Clean image sensor** menu, clean the image sensor manually or consult a Nikon-authorized service representative.

If image sensor cleaning is performed several times in succession, image sensor cleaning may be temporarily disabled to protect the camera's internal circuitry. Cleaning can be performed again after a short wait.



Manual Cleaning

If foreign matter can not be removed from the low-pass filter using the **Clean image sensor** (☐ 345) option in the setup menu, the filter can be cleaned manually as described below. Note, however, that the filter is extremely delicate and easily damaged. Nikon recommends that the filter be cleaned only by Nikon-authorized service personnel.

1 Charge the battery or connect an AC adapter.

A reliable power source is required when inspecting or cleaning the low-pass filter. Turn the camera off and insert a fully-charged battery or connect an optional AC adapter and power connector. The **Lock mirror up for cleaning** option is only available in the setup menu at battery levels over .

2 Remove the lens.

Turn the camera off and remove the lens.

3 Select **Lock mirror up for cleaning**.

Turn the camera on and highlight **Lock mirror up for cleaning** in the setup menu and press . Note that **Lock mirror up for cleaning** is not available when **Enable** is selected for **Network > Network connection** in the setup menu.



4 Press .

The message shown at right will be displayed in the monitor and a row of dashes will appear in the top control panel and viewfinder. To restore normal operation without inspecting the low-pass filter, turn the camera off.

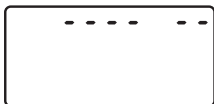
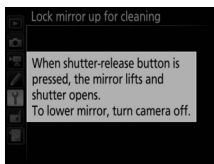

5 Raise the mirror.

Press the shutter-release button all the way down. The mirror will be raised and the shutter curtain will open, revealing the low-pass filter. The display in the viewfinder and rear control panel will turn off and the row of dashes in the top control panel will flash.

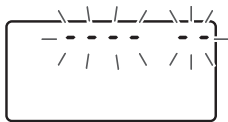

6 Examine the low-pass filter.

Holding the camera so that light falls on the low-pass filter, examine the filter for dust or lint. If no foreign objects are present, proceed to Step 8.

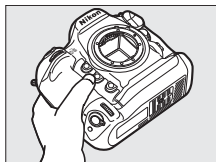

7 Clean the filter.

Remove any dust and lint from the filter with a blower. Do not use a blower-brush, as the bristles could damage the filter.

Dirt that can not be removed with a blower can only be removed by Nikon-authorized service personnel. Under no circumstances should you touch or wipe the filter.



8 Turn the camera off.

The mirror will return to the down position and the shutter curtain will close. Replace the lens or body cap.

Use a Reliable Power Source

The shutter curtain is delicate and easily damaged. If the camera powers off while the mirror is raised, the curtain will close automatically. To prevent damage to the curtain, observe the following precautions:

- Do not turn the camera off or remove or disconnect the power source while the mirror is raised.
- If the battery runs low while the mirror is raised, a beep will sound and the self-timer lamp will flash to warn that the shutter curtain will close and the mirror will be lowered after about two minutes. End cleaning or inspection immediately.



Foreign Matter on the Low-Pass Filter



Foreign matter entering the camera when lenses or body caps are removed or exchanged (or in rare circumstances lubricant or fine particles from the camera itself) may adhere to the low-pass filter, where it may appear in photographs taken under certain conditions. To protect the camera when no lens is in place, be sure to replace the body cap provided with the camera, being careful to first remove all dust and other foreign matter that may be adhering to the camera mount, lens mount, and body cap. Avoid attaching the body cap or exchanging lenses in dusty environments.

Should foreign matter find its way onto the low-pass filter, use the low-pass filter cleaning option as described on page 345. If the problem persists, clean the filter manually (📖 347) or have the filter cleaned by authorized Nikon service personnel. Photographs affected by the presence of foreign matter on the filter can be retouched using the clean image options available in some imaging applications.

Servicing the Camera and Accessories

The camera is a precision device and requires regular servicing. Nikon recommends that the camera be inspected by the original retailer or a Nikon-authorized service representative once every one to two years, and that it be serviced once every three to five years (note that fees apply to these services). Frequent inspection and servicing are particularly recommended if the camera is used professionally. Any accessories regularly used with the camera, such as lenses or optional flash units, should be included when the camera is inspected or serviced.

Replacing the Clock Battery

The camera clock is powered by a CR1616 lithium battery with a life of about two years. If the  icon is displayed in the top control panel while the standby timer is on, the battery is running low and needs to be replaced. When the battery is exhausted, the  icon will flash while the standby timer is on. Photographs can still be taken but will not be stamped with the correct time and date. Replace the battery as described below.

1 Remove the main battery.

The clock battery chamber is located on the roof of the main battery chamber. Turn the camera off and remove the EN-EL18c battery.

2 Open the clock battery chamber.

Slide the clock battery chamber cover toward the front of the main battery chamber.

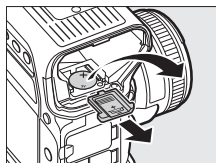

3 Remove the clock battery.

4 Insert the replacement battery.

Insert a new CR1616 lithium battery so that the positive side (the side marked with "+" and the battery name) is visible.

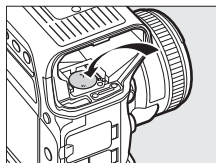

5 Close the clock battery chamber.

Slide the clock battery chamber cover towards the back of the main battery chamber until it clicks into place.

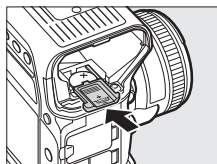

6 Replace the main battery.

Reinsert the EN-EL18c.

7 Set the camera clock.

Set the camera to the current date and time (🗓 28). Until the date and time have been set, the **CLOCK** icon will flash in the top control panel.

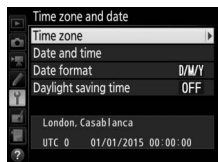

CAUTION

Use only CR1616 lithium batteries. Using another type of battery could cause an explosion. Dispose of used batteries as directed.

Inserting the Clock Battery

Insert the clock battery in the correct orientation. Inserting the battery incorrectly could not only prevent the clock from functioning but could damage the camera.



Caring for the Camera and Battery: Cautions

Do not drop: The product may malfunction if subjected to strong shocks or vibration.

Keep dry: This product is not waterproof, and may malfunction if immersed in water or exposed to high levels of humidity. Rusting of the internal mechanism can cause irreparable damage.

Avoid sudden changes in temperature: Sudden changes in temperature, such as those that occur when entering or leaving a heated building on a cold day, can cause condensation inside the device. To prevent condensation, place the device in a carrying case or plastic bag before exposing it to sudden changes in temperature.

Keep away from strong magnetic fields: Do not use or store this device in the vicinity of equipment that generates strong electromagnetic radiation or magnetic fields. Strong static charges or the magnetic fields produced by equipment such as radio transmitters could interfere with the monitor, damage data stored on the memory card, or affect the product's internal circuitry.

Do not leave the lens pointed at the sun: Do not leave the lens pointed at the sun or other strong light source for an extended period. Intense light may cause the image sensor to deteriorate or produce a white blur effect in photographs.



Cleaning: When cleaning the camera body, use a blower to gently remove dust and lint, then wipe gently with a soft, dry cloth. After using the camera at the beach or seaside, wipe off any sand or salt using a cloth lightly dampened in pure water and then dry the camera thoroughly. In rare instances, static electricity may cause the LCD displays to light up or go dark. This does not indicate a malfunction, and the display will soon return to normal.

The lens and mirror are easily damaged. Dust and lint should be gently removed with a blower. When using an aerosol blower, keep the can vertical to prevent discharge of liquid. To remove fingerprints and other stains from the lens, apply a small amount of lens cleaner to a soft cloth and wipe the lens carefully.

See “The Low-Pass Filter” (□ 345) for information on cleaning the low-pass filter.

Lens contacts: Keep the lens contacts clean.

Do not touch the shutter curtain: The shutter curtain is extremely thin and easily damaged. Under no circumstances should you exert pressure on the curtain, poke it with cleaning tools, or subject it to powerful air currents from a blower. These actions could scratch, deform, or tear the curtain.

The shutter curtain may appear to be unevenly colored, but this has no affect on pictures and does not indicate a malfunction.

Storage: To prevent mold or mildew, store the camera in a dry, well-ventilated area. If you are using an AC adapter, unplug the adapter to prevent fire. If the product will not be used for an extended period, remove the battery to prevent leakage and store the camera in a plastic bag containing a desiccant. Do not, however, store the camera case in a plastic bag, as this may cause the material to deteriorate. Note that desiccant gradually loses its capacity to absorb moisture and should be replaced at regular intervals.

To prevent mold or mildew, take the camera out of storage at least once a month. Turn the camera on and release the shutter a few times before putting it away.

Store the battery in a cool, dry place. Replace the terminal cover before putting the battery away.



Turn the product off before removing or disconnecting the power source: Do not unplug the product or remove the battery while the product is on or while images are being recorded or deleted. Forcibly cutting power in these circumstances could result in loss of data or in damage to product memory or internal circuitry. To prevent an accidental interruption of power, avoid carrying the product from one location to another while the AC adapter is connected.

Dry the accessory shoe cover: If the camera is used in the rain, water may penetrate the supplied accessory shoe cover. Remove and dry the accessory shoe cover after using the camera in the rain.

Notes on the monitor: The monitor is constructed with extremely high precision; at least 99.99% of pixels are effective, with no more than 0.01% being missing or defective. Hence while these displays may contain pixels that are always lit (white, red, blue, or green) or always off (black), this is not a malfunction and has no effect on images recorded with the device.

Images in the monitor may be difficult to see in a bright light.

Do not apply pressure to the monitor, as this could cause damage or malfunction. Dust or lint on the monitor can be removed with a blower. Stains can be removed by wiping lightly with a soft cloth or chamois leather. Should the monitor break, care should be taken to avoid injury from broken glass and to prevent liquid crystal from the monitor touching the skin or entering the eyes and mouth.

Batteries: Batteries may leak or explode if improperly handled. Observe the following precautions when handling batteries:

- Use only batteries approved for use in this equipment.
- Do not expose the battery to flame or excessive heat.
- Keep the battery terminals clean.
- Turn the product off before replacing the battery.
- Remove the battery from the camera or charger when not in use and replace the terminal cover. These devices draw minute amounts of charge even when off and could draw the battery down to the point that it will no longer function. If the battery will not be used for some time, insert it in the camera and run it flat before removing it from the camera for storage. The battery should be stored in a cool location with an ambient temperature of 15 °C to 25 °C (59 °F to 77 °F; avoid hot or extremely cold locations). Repeat this process at least once every six months.

- Turning the camera on or off repeatedly when the battery is fully discharged will shorten battery life. Batteries that have been fully discharged must be charged before use.
- The internal temperature of the battery may rise while the battery is in use. Attempting to charge the battery while the internal temperature is elevated will impair battery performance, and the battery may not charge or charge only partially. Wait for the battery to cool before charging.
- Continuing to charge the battery after it is fully charged can impair battery performance.
- A marked drop in the time a fully charged battery retains its charge when used at room temperature indicates that it requires replacement. Purchase a new battery.
- Charge the battery before use. When taking photographs on important occasions, ready a spare battery and keep it fully charged. Depending on your location, it may be difficult to purchase replacement batteries on short notice. Note that on cold days, the capacity of batteries tends to decrease. Be sure the battery is fully charged before taking photographs outside in cold weather. Keep a spare battery in a warm place and exchange the two as necessary. Once warmed, a cold battery may recover some of its charge.
- Used batteries are a valuable resource; recycle in accord with local regulations.



Exposure Program

The exposure program for programmed auto (☐ 133) is shown in the following graph:

— ISO 100; lens with maximum aperture of f/1.4 and minimum aperture of f/16 (e.g., AF-S NIKKOR 50mm f/1.4G)

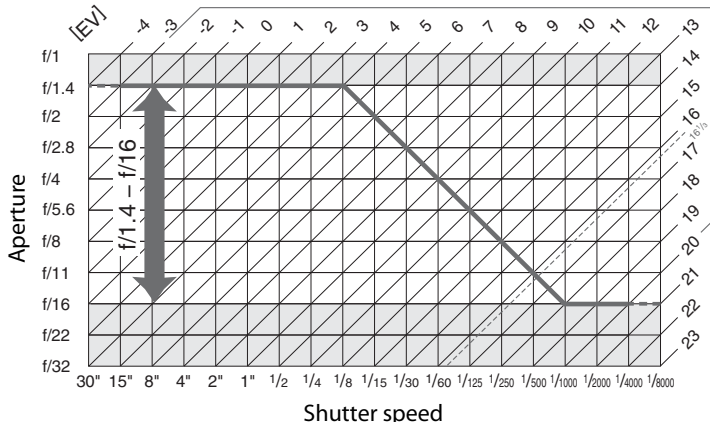

The maximum and minimum values for EV vary with ISO sensitivity; the above graph assumes an ISO sensitivity of ISO 100 equivalent. When matrix metering is used, values over $16 \frac{1}{3}$ EV are reduced to $16 \frac{1}{3}$ EV.



Troubleshooting

If the camera fails to function as expected, check the list of common problems below before consulting your retailer or Nikon-authorized service representative.

Battery/Display

The camera is on but does not respond: Wait for recording to end. If the problem persists, turn the camera off. If the camera does not turn off, remove and reinsert the battery or, if you are using an AC adapter, disconnect and reconnect the AC adapter. Note that although any data currently being recorded will be lost, data that have already been recorded will not be affected by removing or disconnecting the power source.

Viewfinder is out of focus: Adjust viewfinder focus (☐ 35). If necessary, viewfinder focus can be further adjusted using optional corrective lenses (☐ 338).

Viewfinder is dark: Insert a fully-charged battery (☐ 19, 37).

Displays turn off without warning: Choose longer delays for Custom Setting c2 (**Standby timer**) or c4 (**Monitor off delay**) (☐ 303).

Displays in control panels or viewfinder are unresponsive and dim: The response times and brightness of these displays vary with temperature.

Shooting

Camera takes time to turn on: Delete files or folders.

Shutter-release disabled:



- Memory card is full (☐ 30, 38).
 - **Release locked** is selected for **Slot empty release lock** in the setup menu (☐ 313) and no memory card is inserted (☐ 30).
 - Aperture ring for CPU lens not locked at highest f-number (does not apply to type G and E lenses). If **fE E** is displayed in the top control panel, select **Aperture ring** for Custom Setting f4 (**Customize command dials**) > **Aperture setting** to use lens aperture ring to adjust aperture (☐ 308).
 - Exposure mode **S** selected with **b u l b** or **- -** selected for shutter speed (☐ 365).
-





Camera is slow to respond to shutter-release button: Select **Off** for Custom Setting d5 (**Exposure delay mode**;  304).

Only one shot taken each time shutter-release button is pressed in continuous release mode: Turn HDR off ( 189).





Photos are out of focus:

- Rotate focus-mode selector to **AF** ( 98).
 - Camera unable to focus using autofocus: use manual focus or focus lock ( 111, 114).
-

Full range of shutter speeds not available: Flash in use. Flash sync speed can be selected using Custom Setting e1 (**Flash sync speed**); when using compatible flash units, choose **1/250 s (Auto FP)** for full range of shutter speeds ( 305).

Focus does not lock when shutter-release button is pressed halfway: Camera is in focus mode **AF-C**: use the center of the sub-selector to lock focus ( 111).

Can not select focus point:

- Unlock focus selector lock ( 108).
 - Auto-area AF selected for AF-area mode or face-priority AF selected in live view; choose another mode ( 49, 104).
 - Camera is in playback mode ( 248).
 - Menus are in use ( 289).
 - Press shutter-release button halfway to start standby timer ( 41).
-

Can not select AF mode: Select **No restrictions** for Custom Setting a10 (**Autofocus mode restrictions**,  301).

Camera is slow to record photos: Turn long exposure noise reduction off ( 294).

Noise (bright spots, randomly-spaced bright pixels, fog, or lines) appear in photos:

- Bright spots, randomly-spaced bright pixels, fog, and lines can be reduced by lowering ISO sensitivity.
- Use the **Long exposure NR** option in the photo shooting menu to limit the occurrence of bright spots or fog in photos taken at shutter speeds slower than 1 s (☞ 294).
- Fog and bright spots may indicate that the camera's internal temperature has become elevated due to high ambient temperatures, long exposures, or similar causes: turn the camera off and wait for it to cool before resuming shooting.
- At high ISO sensitivities, lines may appear in photos taken with some optional flash units; if this occurs, choose a lower value.
- At high ISO sensitivities, including high values selected with auto ISO sensitivity control, randomly-spaced bright pixels can be reduced by selecting **High, Normal, or Low** for **High ISO NR** in the photo or movie shooting menu (☞ 294, 298).
- At high ISO sensitivities, bright spots, randomly-spaced bright pixels, fog, or lines may be more noticeable in long exposures, multiple exposures, and photos taken at high ambient temperatures or with Active D-Lighting enabled, **Flat** selected for **Set Picture Control** (☞ 179) or extreme values selected for Picture Control parameters (☞ 182).

Flicker or banding appears during movie recording: Choose an option for **Flicker reduction** that matches the frequency of the local AC power supply (☞ 298).

Bright regions or bands appear in live view: A flashing sign, flash, or other light source with brief duration was used during live view.

Smudges appear in photographs: Clean front and rear lens elements. If problem persists, perform image sensor cleaning (☞ 345).

Live view ends unexpectedly or does not start: Live view may end automatically to prevent damage to the camera's internal circuits if:

- The ambient temperature is high
- The camera has been used for extended periods in live view or to record movies
- The camera has been used in continuous release modes for extended periods





If live view does not start when you press the  button, wait for the internal circuits to cool and then try again. Note that the camera may feel warm to the touch, but this does not indicate a malfunction.

Image artifacts appear during live view: "Noise" (randomly-spaced bright pixels, fog, or lines) and unexpected colors may appear if you zoom in on the view through the lens ( 47) during live view; in movies, the amount and distribution of randomly-spaced bright pixels, fog, and bright spots are affected by frame size and rate ( 67). Randomly-spaced bright pixels, fog, or bright spots may also arise as a result of increases in the temperature of the camera's internal circuits during live view; exit live view when the camera is not in use.

Can not measure white balance: Subject is too dark or too bright ( 169).

Image can not be selected as source for preset white balance: Image was not created with D5 ( 176).

White balance bracketing unavailable:

- NEF (RAW) or NEF+JPEG image quality option selected for image quality ( 92).
- Multiple exposure mode is in effect ( 229).

Photographs and movies do not appear to have the same exposure as the preview shown in the monitor during live view: Changes to monitor brightness during live view have no effect on images recorded with the camera ( 51).

Effects of Picture Control differ from image to image: A (auto) is selected for sharpening, clarity, contrast, or saturation. For consistent results over a series of photographs, choose another setting ( 183).

Metering can not be changed: Autoexposure lock is in effect (☞ 142).

Exposure compensation can not be used: Choose exposure mode **P**, **S**, or **A** (☞ 131, 145).

Noise (reddish areas or other artifacts) appears in long time-exposures: Enable long exposure noise reduction (☞ 294).

Sound is not recorded with movies: **Microphone off** is selected for **Microphone sensitivity** in the movie shooting menu (☞ 298).

Playback

NEF (RAW) image is not played back: Photo was taken at image quality of NEF + JPEG (☞ 93).

Can not view pictures recorded with other cameras: Pictures recorded with other makes of camera may not be displayed correctly.

Some photos are not displayed during playback: Select **All** for **Playback folder** (☞ 289).

“Tall” (portrait) orientation photos are displayed in “wide” (landscape) orientation:

- Photo was taken with **Off** selected for **Auto image rotation** (☞ 290).
- Select **On** for **Rotate tall** (☞ 290).
- Photo is displayed in image review (☞ 290).
- Camera was pointed up or down when photo was taken.

Can not delete photo: Picture is protected. Remove protection (☞ 265).

Can not retouch picture: Photo can not be further edited with this camera (☞ 368).

The camera displays a message stating that the folder contains no images: Select **All** for **Playback folder** (☞ 289).

Can not print photos: NEF (RAW) and TIFF photos can not be printed by direct USB connection. Transfer photos to computer and print using Capture NX-D (☞ 277). NEF (RAW) photos can be saved in JPEG format using **NEF (RAW) processing** (☞ 314).

Photo is not displayed on high-definition video device: Confirm that HDMI cable (available separately) is connected (☞ 286).

Image Dust Off option in Capture NX-D does not have desired effect: Image sensor cleaning changes the position of dust on the low-pass filter. Dust off reference data recorded before image sensor cleaning is performed can not be used with photographs taken after image sensor cleaning is performed. Dust off reference data recorded after image sensor cleaning is performed can not be used with photographs taken before image sensor cleaning is performed (☞ 311).

Computer displays NEF (RAW) images differently from camera: Third-party software does not display effects of Picture Controls, Active D-Lighting, or vignette control. Use Capture NX-D (☞ 277).

Can not transfer photos to computer: OS not compatible with camera or transfer software. Use card reader to copy photos to computer.





Miscellaneous

Date of recording is not correct: Set camera clock (☞ 28).



Menu item can not be selected: Some options are not available at certain combinations of settings or when no memory card is inserted. Note that **Battery info** option is not available when camera is powered by an optional power connector and AC adapter (☞ 313).

Error Messages

This section lists the indicators and error messages that appear in the viewfinder, top control panel, and monitor.

Indicator		Problem	Solution	📖
Control panel	Viewfinder			
fE E (flashes)		Lens aperture ring is not set to minimum aperture.	Set ring to minimum aperture (highest f-number).	26
		Low battery.	Ready a fully-charged spare battery.	37
 (flashes)	 (flashes)	<ul style="list-style-type: none"> Battery exhausted. Battery can not be used. An extremely exhausted rechargeable Li-ion battery or a third-party battery is inserted in the camera. High battery temperature. 	<ul style="list-style-type: none"> Recharge or replace battery. Contact Nikon-authorized service representative. Replace the battery, or recharge the battery if the rechargeable Li-ion battery is exhausted. Remove battery and wait for it to cool. 	xviii, 19, 22, 336 —
 (flashes)	—	Camera clock is not set.	Set camera clock.	28
ΔF		No lens attached, or non-CPU lens attached without specifying maximum aperture. Aperture shown in stops from maximum aperture.	Aperture value will be displayed if maximum aperture is specified.	243

Indicator		Problem	Solution	📖
Control panel	View-finder			
—	▶ ◀ (flashes)	Camera unable to focus using autofocus.	Change composition or focus manually.	40, 114
(Exposure indicators and shutter speed or aperture display flash)		Subject too bright; photo will be overexposed.	<ul style="list-style-type: none"> • Use a lower ISO sensitivity. • Use optional ND filter. In exposure mode: S Increase shutter speed A Choose a smaller aperture (higher f-number)	124 336 134 135
		Subject too dark; photo will be underexposed.	<ul style="list-style-type: none"> • Use a higher ISO sensitivity. • Use optional flash. In exposure mode: S Lower shutter speed A Choose a larger aperture (lower f-number)	124 194 134 135
b u l b (flashes)		b u l b selected in exposure mode S .	Change shutter speed or select manual exposure mode.	134, 136
- - (flashes)		- - selected in exposure mode S .	Change shutter speed or select manual exposure mode.	134, 136
b u s y (flashes)	b s y (flashes)	Processing in progress.	Wait until processing is complete.	—
—	⚡ (flashes)	If indicator flashes for 3s after flash fires, photo may be underexposed.	Check photo in monitor; if underexposed, adjust settings and try again.	334

Indicator		Problem	Solution	
Control panel	View-finder			
 (flashes)	—	Flash unit that does not support red-eye reduction attached and flash sync mode set to red-eye reduction.	Change flash sync mode or use flash unit that supports red-eye reduction.	199, 332
FuLL (flashes)	Ful (flashes)	Memory insufficient to record further photos at current settings, or camera has run out of file or folder numbers.	<ul style="list-style-type: none"> • Reduce quality or size. • Delete photographs after copying important images to computer or other device. • Insert new memory card. 	92, 95 268, 278 30
Err (flashes)		Camera malfunction.	Release shutter. If error persists or appears frequently, consult Nikon-authorized service representative.	—

Indicator		Problem	Solution	
Monitor	Control panel			
No memory card.	[- E -]	Camera cannot detect memory card.	Turn camera off and confirm that card is correctly inserted.	30
Cannot access this memory card. Insert another card.	[Err], [Err] (flashes)	<ul style="list-style-type: none"> • Error accessing memory card. • Unable to create new folder. 	<ul style="list-style-type: none"> • Use Nikon-approved card. • Check that contacts are clean. If card is damaged, contact retailer or Nikon-authorized service representative. • Delete files or insert new memory card after copying important images to computer or other device. 	383 — 30, 268, 278
This card is not formatted. Format the card.	[For] (flashes)	Memory card has not been formatted for use in camera.	Format memory card or insert new memory card.	30, 33
Unable to start live view. Please wait.	—	The internal temperature of the camera is high.	Wait for the internal circuits to cool before resuming live view photography or movie recording.	361



Indicator		Problem	Solution	
Monitor	Control panel			
Folder contains no images.	—	No images on memory card or in folder(s) selected for playback.	Select folder containing images from Playback folder menu or insert memory card containing images.	30, 289
All images are hidden.	—	All photos in current folder are hidden.	No images can be played back until another folder has been selected or Hide image used to allow at least one image to be displayed.	289
Cannot display this file.	—	File has been created or modified using a computer or different make of camera, or file is corrupt.	File can not be played back on camera.	—
Cannot select this file.	—	Selected image can not be retouched.	Images created with other devices can not be retouched.	—
This movie cannot be edited.	—	The selected movie can not be edited.	<ul style="list-style-type: none"> • Movies created with other devices can not be edited. • Movies must be at least two seconds long. 	85

Indicator		Problem	Solution	
Monitor	Control panel			
Check printer.	—	Printer error.	Check printer. To resume, select Continue (if available).	283 *
Check paper.	—	Paper in printer is not of selected size.	Insert paper of correct size and select Continue.	283 *
Paper jam.	—	Paper is jammed in printer.	Clear jam and select Continue.	283 *
Out of paper.	—	Printer is out of paper.	Insert paper of selected size and select Continue.	283 *
Check ink supply.	—	Ink error.	Check ink. To resume, select Continue.	283 *
Out of ink.	—	Printer is out of ink.	Replace ink and select Continue.	283 *

* See printer manual for more information.

Specifications

■ Nikon D5 Digital Camera

Type	
Type	Single-lens reflex digital camera
Lens mount	Nikon F mount (with AF coupling and AF contacts)
Effective angle of view	Nikon FX format
Effective pixels	
Effective pixels	20.8 million
Image sensor	
Image sensor	35.9 × 23.9 mm CMOS sensor
Total pixels	21.33 million
Dust-reduction System	Image sensor cleaning, Image Dust Off reference data (Capture NX-D software required)
Storage	
Image size (pixels)	<ul style="list-style-type: none">• FX (36×24) image area 5568 × 3712 (L) 4176 × 2784 (M) 2784 × 1856 (S)• 1.2× (30×20) image area 4640 × 3088 (L) 3472 × 2312 (M) 2320 × 1544 (S)• DX (24×16) image area 3648 × 2432 (L) 2736 × 1824 (M) 1824 × 1216 (S)• 5 : 4 (30×24) image area 4640 × 3712 (L) 3472 × 2784 (M) 2320 × 1856 (S)• Photographs taken during movie recording at a frame size of 3840 × 2160: 3840 × 2160• FX-format photographs taken during movie recording at a frame size of 1920 × 1080 or 1280 × 720 5568 × 3128 (L) 4176 × 2344 (M) 2784 × 1560 (S)• DX-format photographs taken during movie recording at a frame size of 1920 × 1080 or 1280 × 720 3648 × 2048 (L) 2736 × 1536 (M) 1824 × 1024 (S)• Photographs taken during movie recording at a frame size of 1920 × 1080 crop: 1920 × 1080



Storage	
File format	<ul style="list-style-type: none"> • NEF (RAW): 12 or 14 bit (lossless compressed, compressed, or uncompressed); large, medium, and small available (medium and small images are recorded at a bit depth of 12 bits using lossless compression) • TIFF (RGB) • JPEG: JPEG-Baseline compliant with fine (approx. 1 : 4), normal (approx. 1 : 8), or basic (approx. 1 : 16) compression; optimal quality compression available • NEF (RAW)+JPEG: Single photograph recorded in both NEF (RAW) and JPEG formats
Picture Control System	Standard, Neutral, Vivid, Monochrome, Portrait, Landscape, Flat; selected Picture Control can be modified; storage for custom Picture Controls
Media	<ul style="list-style-type: none"> • Models for use with XQD cards: XQD cards • Models for use with CompactFlash cards: Type I CompactFlash memory cards (UDMA7 compliant)
Double card slots	Slot 2 can be used for overflow or backup storage or for separate storage of copies created using NEF+JPEG; pictures can be copied between cards.
File system	DCF 2.0, Exif 2.3, PictBridge
Viewfinder	
Viewfinder	Eye-level pentaprism single-lens reflex viewfinder
Frame coverage	<ul style="list-style-type: none"> • FX (36×24): Approx. 100% horizontal and 100% vertical • 1.2× (30×20): Approx. 97% horizontal and 97% vertical • DX (24×16): Approx. 97% horizontal and 97% vertical • 5:4 (30×24): Approx. 97% horizontal and 100% vertical
Magnification	Approx. $0.72 \times$ (50 mm f/1.4 lens at infinity, -1.0 m^{-1})
Eyepoint	17 mm (-1.0 m^{-1}); from center surface of viewfinder eyepiece lens)
Diopter adjustment	-3 – $+1 \text{ m}^{-1}$
Focusing screen	Type B BriteView Clear Matte Mark IX screen with AF area brackets (framing grid can be displayed)
Reflex mirror	Quick return





Viewfinder	
Depth-of-field preview	Pressing Pv button stops lens aperture down to value selected by user (A and M modes) or by camera (P and S modes)
Lens aperture	Instant return, electronically controlled
Lens	
Compatible lenses	<p>Compatible with AF NIKKOR lenses, including type G, E, and D lenses (some restrictions apply to PC lenses) and DX lenses (using DX 24 × 16 1.5× image area), AI-P NIKKOR lenses, and non-CPU AI lenses (exposure modes A and M only). IX NIKKOR lenses, lenses for the F3AF, and non-AI lenses can not be used.</p> <p>The electronic rangefinder can be used with lenses that have a maximum aperture of f/5.6 or faster (the electronic rangefinder supports 15 focus points with lenses that have a maximum aperture of f/8 or faster, of which 9 points are available for selection).</p>
Shutter	
Type	Electronically-controlled vertical-travel focal-plane mechanical shutter; electronic front-curtain shutter available in mirror up release mode
Speed	$1/8000$ – 30 s in steps of $1/3$, $1/2$, or 1 EV, bulb, time, X250
Flash sync speed	$X=1/250$ s; synchronizes with shutter at $1/250$ s or slower
Release	
Release mode	S (single frame), CL (continuous low speed), CH (continuous high speed), Q (quiet shutter-release), ☺ (self-timer), MUP (mirror up)
Approximate frame advance rate	Up to 10 fps (CL); 10–12 fps, or 14 fps with mirror up (CH); or 3 fps (quiet continuous mode)
Self-timer	2 s, 5 s, 10 s, 20 s; 1–9 exposures at intervals of 0.5, 1, 2, or 3 s

Exposure	
Metering	TTL exposure metering using RGB sensor with approximately 180K (180,000) pixels
Metering method	<ul style="list-style-type: none"> • Matrix: 3D color matrix metering III (type G, E, and D lenses); color matrix metering III (other CPU lenses); color matrix metering available with non-CPU lenses if user provides lens data • Center-weighted: Weight of 75% given to 12 mm circle in center of frame. Diameter of circle can be changed to 8, 15, or 20 mm, or weighting can be based on average of entire frame (non-CPU lenses use 12-mm circle) • Spot: Meters 4 mm circle (about 1.5% of frame) centered on selected focus point (on center focus point when non-CPU lens is used) • Highlight-weighted: Available with type G, E, and D lenses
Range (ISO 100, f/1.4 lens, 20 °C/68 °F)	<ul style="list-style-type: none"> • Matrix or center-weighted metering: -3 – +20 EV • Spot metering: 2 – 20 EV • Highlight-weighted metering: 0 – 20 EV
Exposure meter coupling	Combined CPU and AI
Exposure mode	Programmed auto with flexible program (P); shutter-priority auto (S); aperture-priority auto (A); manual (M)
Exposure compensation	-5 – +5 EV in increments of $\frac{1}{3}$, $\frac{1}{2}$, or 1 EV
Exposure lock	Luminosity locked at detected value
ISO sensitivity (Recommended Exposure Index)	ISO 100 – 102400 in steps of $\frac{1}{3}$, $\frac{1}{2}$, or 1 EV. Can also be set to approx. 0.3, 0.5, 0.7, or 1 EV (ISO 50 equivalent) below ISO 100 or to approx. 0.3, 0.5, 0.7, 1, 2, 3, 4, or 5 EV (ISO 3280000 equivalent) above ISO 102400; auto ISO sensitivity control available
Active D-Lighting	Can be selected from Auto , Extra high +2/+1, High , Normal , Low , or Off

Focus	
Autofocus	Multi-CAM 20K autofocus sensor module with TTL phase detection, fine-tuning, and 153 focus points (including 99 cross-type sensors and 15 sensors that support f/8), of which 55 (35 cross-type sensors and 9 f/8 sensors) are available for selection
Detection range	-4 – +20 EV (ISO 100, 20 °C/68 °F)
Lens servo	<ul style="list-style-type: none"> • Autofocus (AF): Single-servo AF (AF-S); continuous-servo AF (AF-C); predictive focus tracking automatically activated according to subject status • Manual focus (M): Electronic rangefinder can be used
Focus point	153 focus points, of which 55 or 15 are available for selection
AF-area mode	Single-point AF, 9-, 25-, 72-, or 153- point dynamic-area AF, 3D-tracking, group-area AF, group-area AF (HL), group-area AF (VL), auto-area AF
Focus lock	Focus can be locked by pressing shutter-release button halfway (single-servo AF) or by pressing the center of the sub-selector

Flash	
Flash control	TTL: i-TTL flash control using RGB sensor with approximately 180K (180,000) pixels; i-TTL balanced fill-flash for digital SLR is used with matrix, center-weighted, and highlight-weighted metering, standard i-TTL fill-flash for digital SLR with spot metering
Flash mode	Front-curtain sync, slow sync, rear-curtain sync, red-eye reduction, red-eye reduction with slow sync, slow rear-curtain sync, off, Auto FP High-Speed Sync supported
Flash compensation	-3 – +1 EV in increments of $\frac{1}{3}$, $\frac{1}{2}$, or 1 EV
Flash-ready indicator	Lights when optional flash unit is fully charged; flashes after flash is fired at full output
Accessory shoe	ISO 518 hot-shoe with sync and data contacts and safety lock
Nikon Creative Lighting System (CLS)	Supported
Radio-controlled Advanced Wireless Lighting	Supported

Flash	
Unified flash control	Supported
Sync terminal	ISO 519 sync terminal with locking thread
White balance	
White balance	Auto (3 types), incandescent, fluorescent (7 types), direct sunlight, flash, cloudy, shade, preset manual (up to 6 values can be stored, spot white balance measurement available during live view), choose color temperature (2500 K–10,000 K), all with fine-tuning.
Bracketing	
Bracketing types	Exposure, flash, white balance, and ADL
Live view	
Modes	 (photo live view) with available silent mode,  (movie live view)
Lens servo	<ul style="list-style-type: none"> • Autofocus (AF): Single-servo AF (AF-S); full-time-servo AF (AF-F) • Manual focus (M)
AF-area mode	Face-priority AF, wide-area AF, normal-area AF, subject-tracking AF
Autofocus	Contrast-detect AF anywhere in frame (camera selects focus point automatically when face-priority AF or subject-tracking AF is selected)
Movie	
Metering	TTL exposure metering using main image sensor
Metering method	Matrix, center-weighted, or highlight-weighted
Frame size (pixels) and frame rate	<ul style="list-style-type: none"> • 3840 × 2160 (4K UHD); 30p (progressive), 25p, 24p • 1920 × 1080; 60p, 50p, 30p, 25p, 24p • 1920 × 1080 crop; 60p, 50p, 30p, 25p, 24p • 1280 × 720; 60p, 50p <p>Actual frame rates for 60p, 50p, 30p, 25p, and 24p are 59.94, 50, 29.97, 25, and 23.976 fps respectively; ★ high quality available at all frame sizes, normal quality available at all sizes except 3840 × 2160</p>
File format	MOV



Movie	
Video compression	H.264/MPEG-4 Advanced Video Coding
Audio recording format	Linear PCM
Audio recording device	Built-in stereo or external microphone; sensitivity adjustable
ISO sensitivity	<ul style="list-style-type: none"> • Exposure modes P, S, and A: Auto ISO sensitivity control (ISO 100 to Hi 5) with selectable upper limit • Exposure mode M: Auto ISO sensitivity control (ISO 100 to Hi 5) available with selectable upper limit; manual selection (ISO 100 to 102400 in steps of $\frac{1}{3}$, $\frac{1}{2}$, or 1 EV) with additional options available equivalent to approximately 0.3, 0.5, 0.7, 1, 2, 3, 4, or 5 EV (ISO 3280000 equivalent) above ISO 102400
Other options	Index marking, time-lapse movies, electronic vibration reduction

Monitor	
Monitor	8-cm/3.2-in., approx. 2359k-dot (XGA) TFT touch-sensitive LCD with 170 ° viewing angle, approximately 100% frame coverage, and manual monitor brightness control

Playback	
Playback	Full-frame and thumbnail (4, 9, or 72 images) playback with playback zoom, movie playback, photo and/or movie slide shows, histogram display, highlights, photo information, location data display, auto image rotation, picture rating, voice memo input and playback, and IPTC information embedding and display

Interface	
USB	SuperSpeed USB (USB 3.0 Micro-B connector); connection to built-in USB port is recommended
HDMI output	Type C HDMI connector
Audio input	Stereo mini-pin jack (3.5 mm diameter; plug-in power supported)
Audio output	Stereo mini-pin jack (3.5 mm diameter)



Interface	
Ten-pin remote terminal	Can be used to connect optional remote control, WR-R10 (requires WR-A10 adapter) or WR-1 wireless remote controller, GP-1/GP-1A GPS unit, or GPS device compliant with NMEA0183 version 2.01 or 3.01 (requires optional MC-35 GPS adapter cord and cable with D-sub 9-pin connector)
Ethernet	RJ-45 connector <ul style="list-style-type: none"> • Standards: IEEE 802.3ab (1000BASE-T)/IEEE 802.3u (100BASE-TX)/IEEE 802.3 (10BASE-T) • Data rates: 10/100/1000 Mbps with auto detect (maximum logical data rates according to IEEE standard; actual rates may differ) • Port: 1000BASE-T/100BASE-TX/10BASE-T (AUTO-MDIX)
Peripheral connector	For WT-6, WT-5
Supported languages	
Supported languages	Arabic, Bengali, Bulgarian, Chinese (Simplified and Traditional), Czech, Danish, Dutch, English, Finnish, French, German, Greek, Hindi, Hungarian, Indonesian, Italian, Japanese, Korean, Marathi, Norwegian, Persian, Polish, Portuguese (Portugal and Brazil), Romanian, Russian, Serbian, Spanish, Swedish, Tamil, Telugu, Thai, Turkish, Ukrainian, Vietnamese
Power source	
Battery	One rechargeable Li-ion EN-EL18c battery; EN-EL18b, EN-EL18a, and EN-EL18 batteries can also be used, but note that fewer pictures can be taken on a single charge with an EN-EL18 than with an EN-EL18c/EN-EL18b/EN-EL18a (□ 388)
AC adapter	EH-6b AC adapter; requires EP-6 power connector (available separately)
Tripod socket	
Tripod socket	1/4 in. (ISO 1222)

Dimensions/weight

Dimensions (W × H × D)	Approx. 160 × 158.5 × 92 mm (6.3 × 6.3 × 3.7 in.)
Weight	<ul style="list-style-type: none">• Models for use with XQD cards: Approx. 1405 g (3 lb. 1.6 oz.) with battery and two XQD memory cards but without body cap and accessory shoe cover; approx. 1235 g/2 lb. 11.6 oz. (camera body only)• Models for use with CompactFlash cards: Approx. 1415 g (3 lb. 1.9 oz.) with battery and two CompactFlash memory cards but without body cap and accessory shoe cover; approx. 1240 g/2 lb. 11.8 oz. (camera body only)

Operating environment

Temperature	0 °C–40 °C (+32 °F–104 °F)
Humidity	85% or less (no condensation)

- Unless otherwise stated, all measurements are performed in conformity with Camera and Imaging Products Association (CIPA) standards or guidelines.
- All figures are for a camera with a fully-charged battery.
- Nikon reserves the right to change the appearance and specifications of the hardware and software described in this manual at any time and without prior notice. Nikon will not be held liable for damages that may result from any mistakes that this manual may contain.

MH-26a battery charger	
Rated input	AC 100 to 240 V, 50/60 Hz
Charging output	DC 12.6 V/1.2 A
Applicable batteries	Nikon EN-EL18c/EN-EL18b/EN-EL18a/EN-EL18 rechargeable Li-ion batteries
Charging time per battery	Approx. 2 hours and 35 minutes at ambient temperature of 25 °C (77 °F) when no charge remains
Operating temperature	0 °C–40 °C (+32 °F–104 °F)
Dimensions (W × H × D)	Approx. 160 × 85 × 50.5 mm (6.3 × 3.3 × 2 in.)
Length of power cable	Approx. 1.8 m/6 ft (U.S.A. and Canada) or 1.5 m/4.9 ft (other countries)
Weight	<ul style="list-style-type: none"> • Approx. 285 g (10.1 oz), including two contact protectors but excluding power cable • Approx. 265 g (9.3 oz), excluding contact protectors and power cable

The symbols on this product represent the following:

~ AC, = DC, □ Class II equipment (The construction of the product is double-insulated.)

EN-EL18c rechargeable Li-ion battery	
Type	Rechargeable lithium-ion battery
Rated capacity	10.8 V/2500 mAh
Operating temperature	0 °C–40 °C (+32 °F–104 °F)
Dimensions (W × H × D)	Approx. 56.5 × 27 × 82.5 mm (2.2 × 1.1 × 3.2 in.)
Weight	Approx. 160 g (5.6 oz), excluding terminal cover

Calibrating Batteries

The MH-26a battery charger is equipped with a battery calibration feature. Calibrate the battery as required to ensure the accuracy of the camera and charger battery level displays.

If the calibration lamp for the current battery chamber flashes when a battery is inserted, the battery needs to be calibrated. To begin calibration, press the calibration button for the current chamber for about a second. The time needed to calibrate the battery is shown by the charge and calibration lamps:

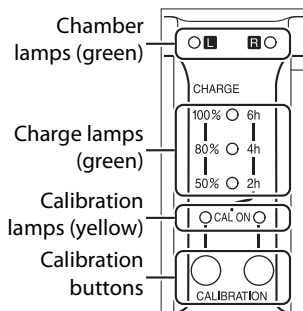

Approximate time needed to recalibrate battery	Calibration lamp	Charge lamps		
		2 h	4 h	6 h
Over 6 hours	○ (glows)	○ (glows)	○ (glows)	○ (glows)
4 – 6 hours	○ (glows)	○ (glows)	○ (glows)	● (off)
2 – 4 hours	○ (glows)	○ (glows)	● (off)	● (off)
Under 2 hours	○ (glows)	● (off)	● (off)	● (off)

When calibration is complete, the calibration and charge lamps will turn off and charging will begin immediately.

Although calibration is recommended for accurate measurement of battery charge state, calibration need not be performed when the calibration lamp flashes. Once begun, calibration can be interrupted as desired.

- If the calibration button is not pressed while the calibration lamp is flashing, normal charging will begin after about ten seconds.
- To interrupt calibration, press the calibration button again. Calibration will end and charging will begin.

Battery Warning

If the chamber and calibration lamps flash on and off in sequence when no battery is inserted, there is a problem with the charger. If the chamber and calibration lamps flash on and off in sequence when a battery is inserted, a problem has occurred with the battery or charger during charging. Remove the battery, unplug the charger, and take the battery and charger to a Nikon-authorized service representative for inspection.

Charging and Calibrating Two Batteries

The MH-26a charges only one battery at a time. If batteries are inserted in both chambers, they will be charged in the order inserted. If the calibration button for the first battery is pressed, the second battery can not be calibrated or charged until calibration and charging of the first battery are complete.

FreeType License (FreeType2)

Portions of this software are copyright © 2012 The FreeType Project (<http://www.freetype.org>). All rights reserved.

MIT License (HarfBuzz)

Portions of this software are copyright © 2016 The HarfBuzz Project (<http://www.freedesktop.org/wiki/Software/HarfBuzz>). All rights reserved.

Trademark Information

IOS is a trademark or registered trademark of Cisco Systems, Inc., in the United States and/or other countries and is used under license. Mac and OS X are registered trademarks of Apple Inc. in the United States and/or other countries. Windows is either a registered trademark or a trademark of Microsoft Corporation in the United States and/or other countries. PictBridge is a trademark. XQD is a trademark of Sony Corporation. CompactFlash is a trademark of SanDisk Corporation. HDMI, the HDMI logo and High-Definition Multimedia Interface are trademarks or registered trademarks of HDMI Licensing, LLC.

HDMI

All other trade names mentioned in this manual or the other documentation provided with your Nikon product are trademarks or registered trademarks of their respective holders.

Supported Standards

- **DCF Version 2.0:** The Design Rule for Camera File System (DCF) is a standard widely used in the digital camera industry to ensure compatibility among different makes of camera.
- **Exif version 2.3:** The camera supports Exif (Exchangeable Image File Format for Digital Still Cameras) version 2.3, a standard in which information stored with photographs is used for optimal color reproduction when the images are output on Exif-compliant printers.
- **PictBridge:** A standard developed through cooperation with the digital camera and printer industries, allowing photographs to be output directly to a printer without first transferring them to a computer.
- **HDMI: High-Definition Multimedia Interface** is a standard for multimedia interfaces used in consumer electronics and AV devices capable of transmitting audiovisual data and control signals to HDMI-compliant devices via a single cable connection.

Approved Memory Cards

■ ■ *Models for Use with XQD Memory Cards*

The camera can be used with XQD memory cards. Cards with write speeds of 45 MB/s (300×) or better are recommended for movie recording; slower speeds may interrupt recording or cause jerky, uneven playback. For information on compatibility and operation, contact the manufacturer.

■■ *Models for Use with CompactFlash Memory Cards*

The camera can be used with Type I CompactFlash memory cards. Type II cards and microdrives cannot be used. Cards with write speeds of 45 MB/s (300×) or better are recommended for movie recording; slower speeds may interrupt recording or cause jerky, uneven playback. For information on compatibility and operation, contact the manufacturer.

Memory Card Capacity

The following table shows the approximate number of pictures that can be stored on a Lexar Professional 2933x XQD 2.0 or 1066x UDMA 7 CompactFlash 64 GB card at different image quality, image size, and image area settings (as of March 2016).

■ FX (36×24) Image Area

Image quality	Image size	File size ¹	No. of images ¹	Buffer capacity ²	
				XQD	CompactFlash
NEF (RAW), Lossless compressed, 12-bit	Large	19.3 MB	1700	200	119
	Medium	13.9 MB	2400	200	172
	Small	10.5 MB	3100	200	200
NEF (RAW), Lossless compressed, 14-bit	Large	24.2 MB	1300	200	82
NEF (RAW), Compressed, 12-bit	Large	16.8 MB	2300	200	153
NEF (RAW), Compressed, 14-bit	Large	20.8 MB	1900	200	103
NEF (RAW), Uncompressed, 12-bit	Large	33.2 MB	1700	197	92
NEF (RAW), Uncompressed, 14-bit	Large	43.1 MB	1300	102	65
TIFF (RGB)	Large	62.5 MB	952	92	67
	Medium	35.6 MB	1600	119	87
	Small	16.4 MB	3500	126	125
JPEG fine ³	Large	10.5 MB	4300	200	200
	Medium	6.4 MB	7100	200	200
	Small	3.4 MB	13,300	200	200
JPEG normal ³	Large	5.3 MB	8400	200	200
	Medium	3.3 MB	13,800	200	200
	Small	1.8 MB	25,300	200	200
JPEG basic ³	Large	2.8 MB	16,200	200	200
	Medium	1.8 MB	26,000	200	200
	Small	1.0 MB	45,400	200	200



■ DX (24 × 16) Image Area

Image quality	Image size	File size ¹	No. of images ¹	Buffer capacity ²	
				XQD	CompactFlash
NEF (RAW), Lossless compressed, 12-bit	Large	9.1 MB	3800	200	200
	Medium	6.7 MB	5100	200	200
	Small	5.2 MB	6500	200	200
NEF (RAW), Lossless compressed, 14-bit	Large	11.2 MB	3000	200	200
NEF (RAW), Compressed, 12-bit	Large	8.0 MB	5000	200	200
NEF (RAW), Compressed, 14-bit	Large	9.7 MB	4200	200	200
NEF (RAW), Uncompressed, 12-bit	Large	14.9 MB	3800	200	200
NEF (RAW), Uncompressed, 14-bit	Large	19.1 MB	3000	200	133
TIFF (RGB)	Large	27.4 MB	2100	200	107
	Medium	15.9 MB	3600	200	200
	Small	7.6 MB	7200	200	200
JPEG fine ³	Large	5.2 MB	8800	200	200
	Medium	3.4 MB	13,600	200	200
	Small	2.1 MB	22,100	200	200
JPEG normal ³	Large	2.7 MB	17,100	200	200
	Medium	1.8 MB	25,700	200	200
	Small	1.1 MB	40,600	200	200
JPEG basic ³	Large	1.4 MB	31,500	200	200
	Medium	1.0 MB	46,500	200	200
	Small	0.7 MB	67,300	200	200

1 All figures are approximate. File size varies with scene recorded.

2 Maximum number of exposures that can be stored in memory buffer at ISO 100. Drops at image qualities marked with a star ("★") or if auto distortion control is on.

3 Figures assume size-priority JPEG compression. Selecting an image-quality option marked with a star ("★"; optimal compression) increases the file size of JPEG images; number of images and buffer capacity drop accordingly.

 **d2—Max. Continuous Release** (📖 303)

The maximum number of photographs that can be taken in a single burst can be set to any amount between 1 and 200.

Battery Life

The movie footage or number of shots that can be recorded with fully-charged batteries varies with the condition of the battery, temperature, the interval between shots, and the length of time menus are displayed. Sample figures for EN-EL18c (2500 mAh) batteries are given below.

- **Photographs, single-frame release mode (CIPA standard¹):** Approximately 3780 shots
- **Photographs, continuous release mode (Nikon standard²):** Approximately 8160 shots

- **Movies:** Approximately 110 minutes at 1080/60p³

- 1 Measured at 23 °C/73.4 °F (±2 °C/3.6 °F) with an AF-S NIKKOR 24–70mm f/2.8E ED VR lens under the following test conditions: lens cycled from infinity to minimum range and one photograph taken at default settings once every 30 s. Live view not used.
- 2 Measured at 23 °C/73.4 °F with an AF-S VR ED 70–200mm f/2.8G lens under the following test conditions: vibration reduction off, image quality set to JPEG normal, image size set to **L** (large), shutter speed $\frac{1}{250}$ s, focus cycled from infinity to minimum range three times after shutter-release button has been pressed halfway for 3 s; six shots are then taken in succession and monitor turned on for 5 s and then turned off; cycle repeated once standby timer has expired.
- 3 Measured at 23 °C/73.4 °F (±2 °C/3.6 °F) with the camera at default settings and an AF-S NIKKOR 24–70mm f/2.8E ED VR lens under conditions specified by the Camera and Imaging Products Association (CIPA). Individual movies are composed of one or more files, each up to 4 GB in size, and can total up to 29 minutes 59 seconds in length; recording may end before these limits are reached if the camera temperature rises.

EN-EL18b, EN-EL18a and EN-EL18 batteries can be used in place of the EN-EL18c, but note that fewer pictures can be taken on a single charge with an EN-EL18 than with an EN-EL18c/ EN-EL18b/ EN-EL18a.



Actions such as the following can reduce battery life:

- Using the monitor
- Keeping the shutter-release button pressed halfway
- Repeated autofocus operations
- Taking NEF (RAW) or TIFF (RGB) photographs
- Slow shutter speeds
- Connecting to Ethernet networks
- Using the camera with optional accessories connected
- Using VR (vibration reduction) mode with VR lenses
- Repeatedly zooming in and out with an AF-P lens

To ensure that you get the most from rechargeable Nikon EN-EL18c batteries:

- Keep the battery contacts clean. Soiled contacts can reduce battery performance.
- Use batteries immediately after charging. Batteries will lose their charge if left unused.
- Check the condition of the battery regularly using the **Battery info** option in the setup menu (📖 313). If 🔧CAL is displayed for **Calibration**, calibrate the battery using the MH-26a battery charger (if the battery has not been used for more than six months, recharge the battery when calibration is complete).

Index

Symbols

P (Programmed auto).....	131, 133
S (Shutter-priority auto)	131, 134
A (Aperture-priority auto).....	131, 135
M (Manual)	131, 136
S	116
CL	116, 117, 303
CH	116, 117, 303
Q.....	116
⌚ (Self-timer)	117, 120
MUP.....	117, 122
⏏ (Quick release-mode selection) 117,	119
⏏	304
[AF] (Single-point AF)	104
[AF] (Dynamic-area AF)	104
[AF] (3D-tracking).....	104
[AF] (Group-area AF)	105
[AF] (Auto-area AF)	105
[AF] (Face-priority AF).....	49
[AF] (Wide-area AF)	49
[AF] (Normal-area AF)	49
[AF] (Subject-tracking AF).....	49
[AF] (Matrix).....	129
[AF] (Center-weighted)	129
[AF] (Spot)	129
[AF]* (Highlight-weighted)	129
⏏ button	116, 117, 119
Info (Info) button	57, 68, 220
Lv (Live view)	44, 59, 173, 309
? (Help)	16
⏏ (Memory buffer)	40, 385
i button.....	51, 63, 253
: switch	9, 309
● (Focus indicator).....	40, 111, 115
PRE (Preset manual).....	160, 168

Numerics

1.2× (30 × 20).....	88
12-bit	94

14 fps (mirror up)	117
14-bit	94
3D color matrix metering III	129
3D-tracking	104, 107, 300
3D-tracking face-detection.....	300
3D-tracking watch area	300
5 : 4 (30 × 24)	88

A

AC adapter.....	336, 342
Accessories.....	336
Accessory shoe	14, 194
Active D-Lighting.....	155, 187, 294
Add items (My Menu).....	316
ADL bracketing (Auto bracketing set)....	146, 155
Adobe RGB	294
Advanced Wireless Lighting	204
AE & flash (Auto bracketing set)	146, 147
AE only (Auto bracketing set)..	146, 147
AF	48–50, 98–113, 299–301
AF activation.....	300
AF area brackets	10, 35
AF fine-tune	310
AF-area mode.....	49, 104, 300
AF-C	101, 299
AF-F	48
AF-ON button	102, 300, 307
AF-ON button for vertical shooting .	102, 307
AF-S.....	48, 101, 299
After burst, show	290
After delete	290
Angle of view.....	87, 328, 329
Aperture	135, 136, 140, 308
Aperture lock.....	140, 308
Aperture-priority auto	135
Aspect ratio	69, 88, 319
Attaching the lens	25
Audio	61, 290, 312

- Audio output 312, 376
 - Audio playback (Slide show)..... 290
 - Auto (White balance)..... 159, 160
 - Auto bracketing 146, 307
 - Auto bracketing (mode M) 307
 - Auto bracketing set 295
 - Auto distortion control 294
 - Auto DX crop 88
 - Auto external flash 197, 216
 - Auto FP high-speed sync..... 305
 - Auto image rotation..... 290
 - Auto ISO sensitivity control 126, 297
 - Auto $\frac{1}{2}$ ISO sensitivity control 306
 - Auto-area AF 105, 106
 - Autofocus..... 48–50, 98–113, 299–301
 - Autofocus mode..... 48, 101, 301
 - Autofocus mode restrictions 301
- B**
-
- Backlight..... 9
 - Backup (Role played by card in Slot 2) ... 97
 - Battery..... 19–24, 37, 313, 351, 379, 380
 - Battery info..... 313
 - Beep 312
 - BKT** button 147, 148, 151, 152, 155, 156, 193, 231, 307
 - Black-and-white (Monochrome)..... 315
 - Blocked shot AF response..... 299
 - Body cap..... 25, 339
 - Border..... 284
 - Bracketing..... 146, 307
 - Bracketing order..... 307
 - Bulb..... 138
 - Burst..... 117, 290, 303
 - Button backlights..... 9, 304
- C**
-
- Calibration 380
 - Camera Control Pro 2..... 339
 - Capture NX-D..... ii, 277
 - Center-weighted metering..... 129, 302
 - CF card 30, 384
 - Charging the battery 19–21
 - Choose color temp. (White balance) 160, 165
 - Choose start/end point 82
 - Choose tab 316
 - Clean image sensor..... 311
 - Clock..... 28, 310
 - Clock battery 29, 351
 - Cloudy (White balance)..... 160
 - CLS 330
 - Color space..... 294
 - Color temperature.... 159, 160, 161, 165
 - CompactFlash 30, 384
 - Compatible lenses..... 323
 - Compressed (NEF (RAW) compression). 94
 - Computer 277, 278
 - Connector for external microphone.. 2, 341
 - Continuous high speed 116, 117, 303
 - Continuous low speed 116, 117, 303
 - Continuous release mode 116, 117, 303
 - Continuous shooting speed 303
 - Continuous-servo AF 101, 299
 - Control panel..... 6–8
 - Copy image(s) 290
 - Copyright information 311
 - CPU contacts 326
 - CPU lens 26, 323, 326
 - Creative Lighting System..... 330
 - Crop 67, 69
 - Cropping (PictBridge [Setup] menu) 284
 - Custom control assignment..... 307
 - Custom Settings..... 299
 - Custom settings bank 299
 - Customize command dials..... 308
 - Cyanotype (Monochrome)..... 315
- D**
-
- Date and time 28, 310
 - Date format..... 29, 310
 - Daylight saving time..... 28, 310
 - DCF..... 382
 - Default settings 224, 296, 313

Delete 43, 268, 276
Delete all images 268, 270
Delete current image 43, 268
Depth of field 132
Destination 296
Diopter 35, 338
Direct sunlight (White balance) 160
Distance-priority manual 197, 217, 331
Distortion control 314
D-Lighting 314
Dual monitor 287
DX (24 × 16) 1.5 × 88, 90, 91
DX format 87, 88, 89
DX-based movie format 70
Dynamic-area AF 104, 106, 301

E

Easy exposure compensation 302
Edit movie 82, 85, 315
Electronic front-curtain shutter 304
Electronic rangefinder 115
Electronic VR 298
Ethernet 281
EV steps for exposure cntrl 301
Exif 382
Exp./flash comp. step value 301
Exposure 129, 131, 141, 143, 301
Exposure bracketing 146, 147, 307
Exposure comp. for flash 306
Exposure compensation 143, 302
Exposure delay mode 304
Exposure differential 191
Exposure indicator 137
Exposure lock 141
Exposure meters 41, 303
Exposure mode 131
Exposure preview 46
Exposure program 357
Exposure smoothing 76, 238
Extended photo menu banks 291
External microphone 64, 341

F

Face detection 300, 302

Face-priority AF 49
File information 255
File naming 291, 296
File number sequence 304
Filter effects 183, 315
Fine-tune optimal exposure 302
Firmware version 313
Flash 194, 198, 200, 202, 305, 330
Flash (White balance) 160
Flash bracketing 146, 147, 307
Flash compensation 200
Flash control 196, 197, 204, 209, 292
Flash info 216
Flash mode 198, 199
Flash only (Auto bracketing set) 146
Flash range 330
Flash shutter speed 306
Flash sync speed 305
Flash sync terminal 195
Flash-ready indicator 11, 194, 203, 334, 374
Flat (Set Picture Control) 179
Flexible program 133
Flicker 12, 312
Flicker reduction 298
Fluorescent (White balance) 159
Fn1 button 307, 309
Fn2 button 307, 309
Fn3 button 273, 276, 307, 309
f-number 135, 326
Focal length 245, 328, 329
Focal plane mark 115
Focus 48–50, 98–115, 299–301
Focus indicator 40, 111, 115
Focus lock 111
Focus mode 48, 98, 114
Focus point 49, 104, 108, 300, 301
Focus point options 301
Focus point wrap-around 301
Focus tracking 103, 299
Focus tracking with lock-on 299
Focusing screen 371
Focus-mode selector 48, 98, 114
Focus-mode switch 26, 114



Format.....	33, 310
Format memory card.....	310
Frame interval (Slide show).....	290
Frame rate.....	67
Frame size/frame rate.....	67, 296
Frequency response.....	298
Front-curtain sync.....	198
Full-frame playback.....	248
Full-frame playback flicks.....	312
Full-time-servo AF.....	48
FV lock.....	202
FX (36 × 24) 1.0 ×.....	88
FX format.....	87, 88
FX-based movie format.....	70
G	
GPS.....	246, 247, 261
GPS unit.....	246, 340
Group flash.....	209, 218
Group-area AF.....	105, 106
H	
H.264.....	376
HDMI.....	286, 312, 382
HDR (high dynamic range).....	189
Headphone volume.....	64
Headphones.....	64
Help.....	16
Hi.....	125
Hide image.....	289
High definition.....	286, 382
High Dynamic Range (HDR).....	189, 295
High ISO NR.....	294, 298
Highlight display.....	64
Highlights.....	256
Highlight-weighted metering.....	129
Histogram.....	257, 258
HTTP server.....	281
I	
Image area 26, 51, 63, 70, 87, 88, 90, 95, 292, 296	
Image comment.....	311
Image Dust Off ref photo.....	311
Image overlay.....	315, 320
Image quality.....	92, 292
Image review.....	250, 290
Image size.....	95, 292
Incandescent (White balance).....	159
Index marking.....	63
Index print.....	285
In-focus indicator.....	40, 111, 115
Information display.....	57, 68, 216, 220, 310
Interval timer shooting.....	236, 295
IPTC.....	261, 311
ISO sensitivity.....	124, 126, 297
ISO sensitivity settings.....	293, 297
ISO sensitivity step value.....	301
i-TTL.....	196, 197, 209, 216, 331
J	
JPEG.....	92, 96, 314, 317
JPEG basic.....	92
JPEG fine.....	92
JPEG normal.....	92
L	
L (large).....	72, 95
LAN.....	337
Landscape (Set Picture Control).....	179
Language.....	27, 310
LCD.....	9, 304
LCD illumination.....	9, 304
LED lamp.....	312
Lens.....	25, 26, 243, 310, 323
Lens cap.....	25
Lens focus ring.....	25, 50, 114
Lens mount.....	3, 26, 115
Lens mounting mark.....	3, 25, 26
Limit AF-area mode selection.....	300
Limit release mode selection.....	304
LINK mode.....	206, 312
Live view.....	44, 59
Live view button options.....	309
Live view photography.....	44–58
Live view selector.....	44, 59
Lo.....	125
Location data.....	246, 261

Lock mirror up for cleaning	311, 347
Long exposure NR.....	294
Lossless compressed (NEF (RAW) compression)	94

M

M (Manual focus).....	50, 114
M (medium).....	72, 95
Manage Picture Control...	184, 293, 297
Manual (Exposure mode)	136
Manual (Flash control).....	197, 209, 217
Manual focus.....	50, 114
Matrix metering	129, 302
Max. continuous release.....	303
Maximum aperture.....	50, 243, 326, 334
Maximum sensitivity	127, 297
Memory buffer	40, 118
Memory card.....	30, 33, 97, 310, 383
Memory card capacity.....	385
Metering	129
Microphone.....	2, 5, 64, 272, 341
Microphone sensitivity.....	298
Minimum aperture	26, 132
Minimum shutter speed.....	127
Mired.....	164
Mirror	122, 347
Mirror up mode.....	117, 122
Modeling flash.....	132, 306
Monitor	12, 44, 248, 303, 310
Monitor brightness.....	51, 64, 310
Monitor color balance	310
Monitor off delay	303
Monochrome.....	179, 315
Movie ISO sensitivity settings.....	297
Movie mode	59, 296, 309
Movie quality	67, 297
Movie shooting menu	296
Movie-record button	61, 307
Multi selector	16, 308
Multiple exposure	229, 295
Multi-selector center button.....	308
My Menu	316

N

NEF (RAW).....	92, 94, 96, 314, 317
NEF (RAW) bit depth	94
NEF (RAW) compression.....	94
NEF (RAW) processing.....	314, 317
NEF (RAW) recording	94, 293
Network.....	281, 313
Neutral (Set Picture Control).....	179
Nikon Transfer 2.....	279
No. of copies (PictBridge [Setup] menu)	284
Non-CPU lens	243, 324, 326
Non-CPU lens data	243, 244, 311
Normal-area AF.....	49
Number of focus points.....	300

O

Optical AWL	204, 205
Optical/radio AWL	204, 208
Overflow (Role played by card in Slot 2)	97
Overlay mode.....	232
Overview data.....	262

P

Page size.....	284
Pairing	206
Peripheral connector	2, 337
Perspective control	315
Photo information	254, 289
Photo live view display WB.....	52
Photo shooting menu	291
Photo shooting menu bank.....	291
PictBridge	283, 382
Picture Controls.....	179
PIN	206
Playback	42, 80, 248, 286
Playback display options.....	289
Playback folder	289
Playback information	254, 289
Playback menu	289
Playback zoom	263
Portrait (Set Picture Control).....	179
Power connector	336, 342



Predictive focus tracking 103
Preset manual (White balance) 160, 168
Print date 284
Print options (PictBridge [Setup] menu) 284
Print select 285
Printing 283
Programmed auto 133
Protecting photographs 265
Pv button 50, 132, 306, 307, 309

Q

Quick release-mode selection. 117, 119
Quick wireless control 211, 218
Quiet shutter-release 116

R

Radio AWL 204, 206
Radio remote flash info 208
Rank items (My Menu) 316
Rating 267
RAW Slot 1 - JPEG Slot 2 (Role played by card in Slot 2) 97
Rear control panel 8
Rear-curtain sync 198
Recent settings 316
Rechargeable Li-ion battery ii, 19, 37, 379, 380
Red-eye correction 314
Red-eye reduction 198
Release button to use dial 308
Release mode 116
Remote cord 73, 138, 339
Remote flash control 209
Remote flash photography 204
Remote repeating 213, 218
Remove items (My Menu) 316
Removing the lens from the camera. 26
Repeating flash 197, 217
Reset 224, 296, 313
Reset all settings 313
Reset movie shooting menu 296
Resize 314

Restoring default settings 224, 296, 313
Retouch menu 314
Reverse indicators 309
RGB 92, 257, 294
RGB Histogram 257
Role played by card in Slot 2 97, 291
Rotate tall 290

S

S (small) 72, 95
Save selected frame 82, 85
Save/load settings 313
Self-timer 117, 120, 303
Sensitivity 124, 126, 297
Set clock from satellite 247
Set Picture Control 179, 293, 297
Setup menu 310
Shade (White balance) 160
Shooting data 259
Shutter speed 134, 136, 140
Shutter speed lock 140, 308
Shutter-priority auto 134
Shutter-release button 40, 111, 141, 309
Shutter-release button AE-L 302
Side-by-side comparison 315
Silent live view photography 54, 295
Silent photography 54
Single frame 116
Single-point AF 104, 106
Single-servo AF 48, 101, 299
Size 72, 95, 314, 319
Skylight 315
Slide show 290
Slot 30, 97, 249, 296
Slot empty release lock 313
Slot selection 97, 249
Slow sync 198
Smoothing 191
Speaker 276
Speedlights 194, 330
Split-screen display zoom 52, 53
Spot 129
Spot white balance 173

sRGB 294
Standard (Set Picture Control) 179
Standard i-TTL fill-flash for digital SLR...
196, 331
Standby timer 41, 247, 303
Start printing 285
Storage folder 291
Store by orientation 300
Straighten 314
Sub-dial frame advance 308
Subject motion 299
Sub-selector 109, 111, 141, 307, 309
Synchronized release 304

T

Television 286
Ten-pin remote terminal 2, 246, 339,
340
Thumbnail 248
TIFF (RGB) 92, 96
Time 28, 310
Time zone 28, 310
Time zone and date 28, 310
Time-lapse movie 74, 298
Timer 120, 236
Toning (Set Picture Control) 183
Top control panel 6, 7
Touch controls 12, 185, 251, 312
Touch screen 12, 185, 251
Trim 314, 319
Two-button reset 224
Type D lens 323, 326
Type E lens 323, 326
Type G lens 323, 326

U

Uncompressed (NEF (RAW)
compression) 94
USB cable ii, 278, 283
UTC 28, 246, 261

V

Vertical shooting 39, 102, 109, 307
Vibration reduction 298
Viewfinder 10, 35, 371

Viewfinder eyepiece 36, 120
Viewfinder focus 35, 36, 338
Viewfinder grid display 304
ViewNX-i ii, 277
Vignette control 294
Virtual horizon 57, 68, 310
Vivid (Set Picture Control) 179
Voice memo 272–276, 312
Voice memo control 312
Voice memo options 312
Voice memo overwrite 312

W

Warm filter 315
WB 151, 159, 297
WB bracketing (Auto bracketing set)
146, 151
White balance 151, 159, 293, 297
White balance bracketing 146, 151
Wide-area AF 49
Wind noise reduction 298
Wireless flash options 204
Wireless network 281, 337
Wireless remote (WR) options 312
Wireless remote controller 73, 204, 206,
312, 337
Wireless transmitter 281, 337

X

XQD card 30, 383



No reproduction in any form of this manual, in whole or in part (except for brief quotation in critical articles or reviews), may be made without written authorization from NIKON CORPORATION.

NIKON CORPORATION

© 2016 Nikon Corporation

Printed in Japan



SB9A06(11)
6MB29011-06