

● **12mm 1:2.0 NCS CS**
(Canon M, Fujifilm X, Samsung NX, Sony E, MFT)

Instruction Manual

Thank you for purchasing our lens.
 We believe that this new 12mm 1:2.0 NCS CS Canon M, Fujifilm X, Samsung NX and Sony E, MFT lens will give you a special photographic experience.

With an optical design optimized for mirrorless cameras, such as the Canon M, Fujifilm X, Samsung NX and Sony E, MFT the 12mm 1:2.0 NCS CS lens is compact and very portable, producing both close-up and distant images.

- Features of the 12mm 1:2.0 NCS CS lens
1. Optical design specially designed for the Mirrorless APS-C (1:1.5x) image format
 2. It compensates aberrations using 3 low dispersion lenses and 2 complex aspherical lenses and, in the fully open position, produces high resolution and high contrast at the center of the lens as well as around the periphery.
 3. The detachable petal type hood and UMC (Ultra Multi Coating) design suppresses flaring and ghost images.
 4. NCS (Nano-coating system) of the ultra-low reflection coating for the best picture quality.

The 12mm 1:2.0 NCS CS lens Canon M, Fujifilm X, Samsung NX and Sony E, MFT is designed with its own mount. You can mount the lens directly onto the camera without using an adaptor.

- ※ Please read this instruction manual carefully and use the product accordingly.
- ※ Please read the 'Safety Precautions' at the back of this instruction manual prior to use.

● **Please read this instruction manual prior to use.** ●

1. Component Names

[Figure]

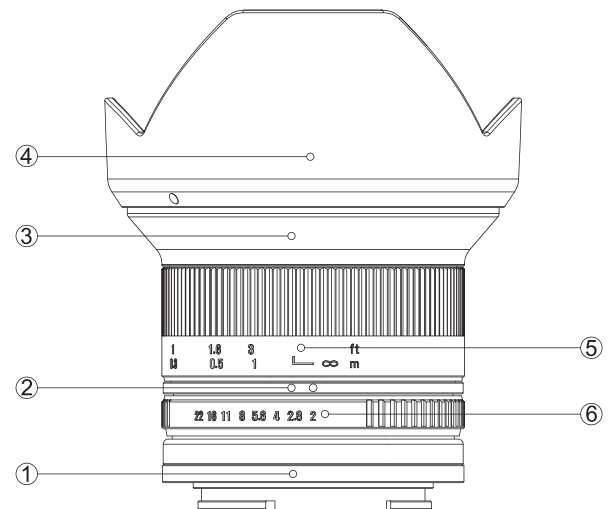

- ① Mount
- ② Reference point
- ③ Hood locking tube
- ④ Hood
- ⑤ Focusing ring (Distance scale)
- ⑥ Aperture adjustment ring

2. Attaching to and Detaching from the Camera

The 12mm 1:2.0 NCS CS lens mount is uniquely designed for the Canon M, Fujifilm X, Samsung NX and Sony E, MFT Cameras.

[Attaching]

Gently hold the lens hood, align the camera mount attachment point with the camera locking reference point on the lens, push the lens into the camera and turn the lens gently until it makes a clicking sound, and the depth of field scale is positioned at the top of the camera.

[Detaching]

Gently hold the lens hood, press the lens release button on the camera, and turn the lens in the opposite direction to detach the lens.

3. Focus Adjustment

When using the 12mm 1:2.0 NCS CS lens, you can set the focus of a subject by turning the focusing ring, since it is an MF (Manual Focus) adjustment lens.

[Canon M, Fujifilm X, Samsung NX, Sony E, MFT Mount]

- ① To change the focus from a subject that is far away to a subject that is close turn the focusing ring clockwise (from ∞ to 0.2) and focus on the clearest subject, using the indicator signal on the camera or by checking on the LCD.
- ② To change the focus from a subject that is close to a subject that is far away turn the focusing ring counterclockwise (from 0.2 to ∞) and focus on the clearest subject, using the indicator signal on the camera or by checking on the LCD.

4. Brightness Control

The 12mm 1:2.0 NCS CS lens mount is uniquely designed for the Canon M, Fujifilm X, Samsung NX and Sony E, MFT Cameras.

[Aperture adjustment ring mark]

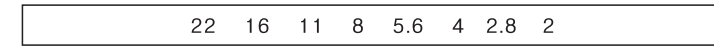

Each number between 4~22 is 1 stop (1 EV) away from the next number. Brightness can be set more precisely by using the stop setting in between, such as the 0.5 stop between 2.8 and 4.

5.6 and 8 are 1 stop (1 EV) away from each other.

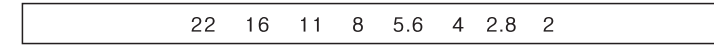

Set a brightness between 5.6 and 8, which is 0.5 of a stop (0.5 EV) between the two

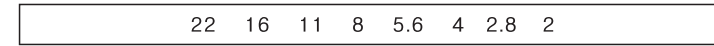

5. Mounting the Hood

The hood has a bayonet system which guarantees speedy, efficient, safe and precise installation, and enables you to enjoy shooting that is free from ghosting or flaring.

[Figure]

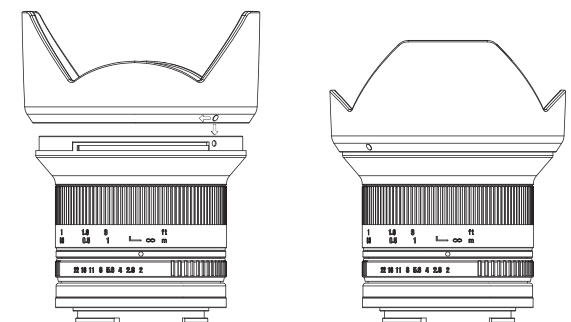

Align the attachment reference point on the hood with the reference point for a hood on the lens, push the hood onto the lens and turn the hood clockwise until it makes a clicking sound.

6. Camera settings

The aperture of the 12mm 1:2.0 NCS CS lens for Canon M, Fujifilm X, Samsung NX and Sony E, MFT is not geared to the Cameras.

If the brightness value is set to above 8, the user may have difficulty in setting the correct focus when viewing a subject through the camera viewfinder, therefore focus on the subject by fully opening the aperture when attaching this lens to the camera, and then set the depth of focus and brightness you want to express prior to shooting.

[Canon M, Mount]

- 1) Set the exposure to manual exposure (M) and change the focus mode to MF.

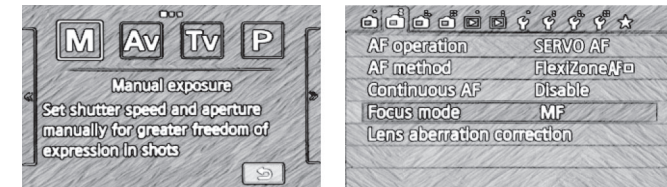

(The procedures above are for the Canon M. The settings for the camera or the menu may vary based on the camera model or due to a functional upgrade. Refer to the camera instruction manual or contact the camera manufacturer for detailed information.)

[Fujifilm X Mount]

- 1) Turn the camera power on, and set the focus mode selector on the camera to M. Focusing will be easier with partial expansion using the command dial.

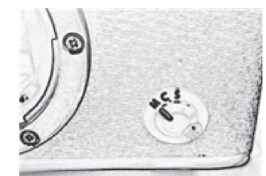

- 2) Press the MENU/OK button, and select ON for 'Shooting without lens' in the shooting menu. When the shooting mode is for video recording, you need to change the mode to still image.

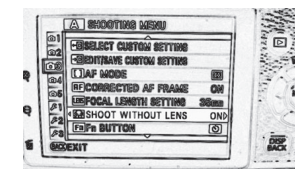

(The above procedure is given based on the X-Pro1. The camera settings may be different depending on the model or due to a menu upgrade. Therefore refer to the camera manual or contact the camera manufacturer for more detailed information.)

[Samsung NX Mount]

- 1) Set the camera mode dial to M.
- 2) Adjust the shutter speed by turning the dial to achieve the appropriate exposure for the brightness.

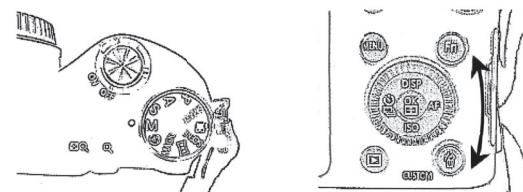

※ For some Samsung NX cameras, if you set the camera mode dial to A and set the brightness by turning the aperture adjustment ring on the lens, the camera automatically^{is} changes the shutter speed, so you don't have to adjust the shutter speed as well, which required in M mode.

(The above procedure is given based on the NX200. The camera settings may be different depending on the model or due to a menu upgrade. Therefore refer to the camera manual or contact the camera manufacturer for more detailed information.)

【Sony E Mount】

- 1) Set the camera mode dial to M.
- 2) Adjust the shutter speed by turning the dial to achieve the appropriate exposure for the brightness.

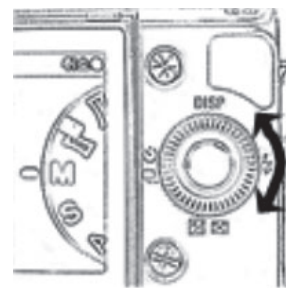

※ For some Sony E cameras, if you set the camera mode dial to A and set the brightness by turning the aperture adjustment ring on the lens, the camera automatically changes the shutter speed, so you don't have to adjust the shutter speed as well, which is required in M mode.

(The above procedure is given based on the NE-5. The camera settings may be different depending on the model or due to a menu upgrade. Therefore refer to the camera manual or contact the camera manufacturer for more detailed information.)

【Micro Four Thirds Mount】

- 1) Set the camera mode dial to M.

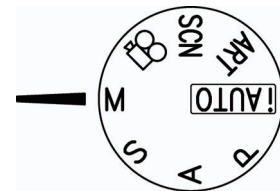

- 2) Adjust the shutter speed by turning the dial to achieve the appropriate exposure for the brightness.

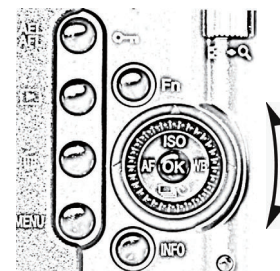

※ For some Olympus (MFT) and Panasonic (MFT) cameras, if you set the camera mode dial to A and set the brightness by turning the aperture adjustment ring on the lens, the camera automatically changes the shutter speed. Therefore you don't need to adjust the shutter speed as well, which is required in M mode.

(The procedures above are for the E-P2. The settings for the camera or the menu may vary based on the camera model or due to a functional upgrade. Refer to the camera manual or contact the camera manufacturer for detailed information.)

7. SPEC

Focal length	12 mm				
Aperture range	F2.0~22				
Image sensor size	23.3 X 15.5 mm				
Focusing range	∞ to 0.2 m				
Optical Construction	12 elements in 10 groups (2 Aspherical lenses)				
Filter Size	Ø 67 mm				
Maximum Diameter	Ø 72.5 mm				
Mount	Canon M	Fujifilm X	Samsung NX	Sony E	Micro Four- Thirds
Angle of View	APS-C	98.9°	98.9°	98.9°	98.9°
	Four Thirds				83.0°
Length	59.0 mm	59.4 mm	51.6 mm	59.1 mm	57.9 mm
Weight	245 g	260 g	235 g	245 g	255 g

8. Troubleshooting

Symptom	Cause	Action
The lens cannot be attached to the camera.	The reference point on the lens is not aligned with the lens attachment reference point on the camera.	Align the reference point on the lens with the lens attachment reference point on the camera.
The lens cannot be detached from the camera.	Incorrect rotation direction for detaching the lens. If you turn the lens while holding the camera, it may cause damage to the lens.	Press the lens release button on the camera, and lightly turn the lens to the lens attaching/detaching reference points, in the direction as marked on the camera, and then pull the lens forward.
Dark image.	Incorrect focusing. Insufficient shutter speed, or camera shake.	Turn the focusing ring while checking the subject using the indicator in the camera or checking visually to set the focus until the subject is clear and distinct, and then press the shutter. After selecting a shutter speed of 1/125 sec or faster, steady the camera and take a photograph.
Automatic focusing does not work properly.	This is a manual focus lens and does not have an automatic function.	Turn the focusing ring to focus on a subject.
The pictures are too dark or too bright.	The exposure is incorrect.	Set the aperture adjustment ring of the lens and the camera shutter speed appropriately.
The edges of the picture periphery gets dark when using a manual camera or a digital camera with a 1:1 image sensor.	As this lens is optimized for APS-C size images, the edges of the picture look dark when using a digital camera with 1:1 sized images.	Use a camera with for APS-C sized images.
The camera flash is not synchronized to the camera.	A manual control lens may not be compatible depending on the camera.	See the camera manual.
There is no camera finder indication or display.	This lens does not have electronic contacts, so there is no communication with the camera.	This does not indicate that there is a problem with shooting.
Zoom failure.	This lens is a short focus lens.	
The lens hood cannot be detached.	This lens hood is of the fixed type, so it cannot be detached.	
The lens cannot be mounted on other cameras.	This lens is designed a specific mount type.	Please buy the required camera to use this lens.
I want to attach your 2X or 1.4X converter lens.	Our converter is designed for the T (M42 SCREW) mount only, thus it cannot be used with this product.	Use each company's own mount converter. However, be aware that auto focusing will not be available.

9. Safety Precautions

The following precautions are divided into two types according to the level of danger.

⚠ WARNING
If this instruction is not followed, it may cause death or severe injury to the user.

⚠ CAUTION
If this instruction is not followed, it may cause death or severe injury to the user.

The following pictograms are used in the below precautions:

⚠ Requires caution. Inside the pictogram it shows contents of precautions. (It shows outbreak of fire in the pictogram on the left.)
🚫 Shows prohibition. Inside the pictogram it shows contents of prohibition. (It shows prohibition of dismantling in the pictogram on the left.)
ℹ Shows instruction. Inside the pictogram it shows contents of instructions. (It shows instruction of precaution in the pictogram on the left.)

⚠ WARNING

⚠ Don't look at the sun through the lens. It may cause blindness.

⚠ Don't leave the lens within reach of babies, as it may cause injury to the baby if the lens falls or is dropped.

⚠ CAUTION

⚠ Attach the lens to the camera correctly and ensure the lens is held in place properly, otherwise the lens may not be removable, or may become loose and cause an accident.

⚠ Don't attempt to modify or alter the lens. It may lead to failure of the camera. Modified or altered lenses may not be repaired.

⚠ Don't put excessive pressure on the lens attached to the camera; otherwise it may cause damage to the lens or to the camera mount. Be sure to hold the lens when operating or moving.

⚠ Don't leave the lens in direct sunlight. It may cause a fire, depending on lenses that concentrate light on a close object.

⚠ Ensure that the camera operates properly by checking the lens beforehand or by test shooting for important events such as a wedding ceremony and an overseas trip.

⚠ Don't look at the sun directly through a camera with a lens attached. It may cause damage to one's eyesight.

⚠ WARNING!

Do not allow this product to get wet, or expose it to a moist environment. It may cause a fire or electric shock.

⚠ CAUTION!

- Do not use this product or store it close to devices that generate heat i.e., heaters, thermal regulators, stoves, stereo amplifiers.
- Do not expose the lens to drastic temperature changes.
- Do not touch the surface of the lens with your hand, or let it come into contact with sharp objects.
- Do not drop the lens.
- Do not soak the lens in water, and avoid water splashing onto the lens.
- If there are foreign bodies on the lens, use a lens cleaning kit only.
- If the hood is removed, the surface of the lens will be exposed and may become scratched, or break.

MEMO