

# RICOH

SLR Digital Camera

# PENTAX *K-3*

## Operating Manual

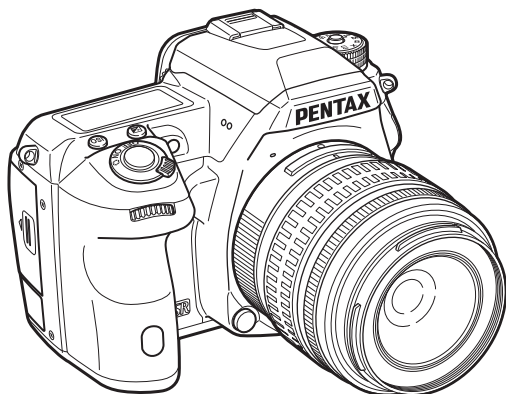

**Introduction** **1**

**Getting Started** **2**

**Shooting** **3**

**Playback** **4**

**Settings** **5**

**Appendix** **6**

To ensure the best performance from your camera, please read the Operating Manual before using the camera.

# Checking the Contents of the Package



Hot shoe cover Fk  
(Installed on camera)



Eyecup Fs  
(Installed on camera)



ME viewfinder cap



Sync socket 2P cap  
(Installed on camera)

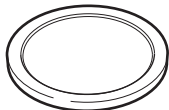

Body mount cover  
(Installed on camera)



Triangular ring and protective cover  
(Installed on camera)



Battery grip terminal cover  
(Installed on camera)



Rechargeable Lithium-ion  
Battery D-LI90

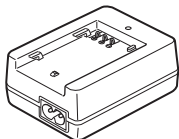

Battery charger  
D-BC90



AC plug cord

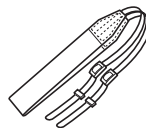

Strap  
O-ST132

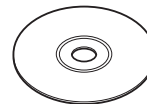

Software (CD-ROM)  
S-SW140



Operating Manual (this manual)

## Lenses you can use

Lenses that can be used with this camera are DA, DA L, D FA and FA J lenses and lenses that have an **A** (Auto) position on the aperture ring. To use any other lens or accessory, see p.81.

**Introducing the K-3**

**1**

**Getting Started**

**2**

**Taking Pictures**

**3**

**Playback Functions**

**4**

**Changing the Settings**

**5**

**Appendix**

**6**

# How to Use This Manual

## 1

### **Introducing the K-3** ..... p.7

Gives you an overview of the K-3.  
Read this and get to know your K-3!

- Names and Functions of the Working Parts** ..... p.7
- How to Change Function Settings** ..... p.16
- Menu List** ..... p.18

## 2

### **Getting Started** ..... p.25

Explains how to get your K-3 ready for shooting as well as basic operations.

- Attaching the Strap** ..... p.25
- Attaching a Lens** ..... p.25
- Using the Battery and Charger** ..... p.26
- Inserting a Memory Card** ..... p.28
- Initial Settings** ..... p.29
- Basic Shooting Operation** ..... p.31
- Reviewing Images** ..... p.34

## 3

### **Taking Pictures** ..... p.35

Once you've confirmed that the camera works properly, try out the camera and take lots of pictures!

- Configuring the Capture Settings** ..... p.35
- Taking Still Pictures** ..... p.36
- Recording Movies** ..... p.38
- Setting the Exposure** ..... p.39
- Using the Built-in Flash** ..... p.41
- Setting the Focus Method** ..... p.42
- Setting the Drive Mode** ..... p.47
- Setting the White Balance** ..... p.52
- Controlling the Image Finishing Touch** ..... p.54
- Correcting Images** ..... p.57

## 4

### **Playback Functions**.....p.59

Explains various operations for playing back and editing images.

- Playback Mode Palette Items** .....p.59
- Changing the Playback Method** .....p.60
- Connecting the Camera to a Computer** .....p.64
- Editing and Processing Images** .....p.65

## 5

### **Changing the Settings** .....p.71

Explains how to change other settings.

- Camera Settings** .....p.71
- File Management Settings** .....p.75

## 6

### **Appendix** .....p.80

Provides various resources.

- Restrictions on the Combinations of Special Functions** .....p.80
- Functions Available with Various Lenses** .....p.81
- Functions when Using an External Flash** .....p.84
- Using the GPS Unit** .....p.85
- Troubleshooting** .....p.86
- Main Specifications** .....p.90
- Index** .....p.96
- For Using Your Camera Safely** .....p.100
- Care to be Taken During Handling** .....p.101
- WARRANTY POLICY** .....p.104

There is a possibility that the illustrations and the display screen of the monitor in this manual are different from the actual ones.

# Contents

|                                     |          |
|-------------------------------------|----------|
| <b>How to Use This Manual .....</b> | <b>2</b> |
|-------------------------------------|----------|

|                                  |          |
|----------------------------------|----------|
| <b>Introducing the K-3 .....</b> | <b>7</b> |
|----------------------------------|----------|

|   |          |
|---|----------|
| <b>Names and Functions of the Working Parts .....</b> | <b>7</b> |
|---|----------|

|                         |   |
|-------------------------|---|
| Buttons and Dials ..... | 8 |
|-------------------------|---|

|                       |   |
|-----------------------|---|
| Monitor Display ..... | 9 |
|-----------------------|---|

|                  |    |
|------------------|----|
| Viewfinder ..... | 14 |
|------------------|----|

|                 |    |
|-----------------|----|
| LCD Panel ..... | 15 |
|-----------------|----|

|                        |    |
|------------------------|----|
| Electronic Level ..... | 15 |
|------------------------|----|

|  |           |
|--|-----------|
| <b>How to Change Function Settings .....</b> | <b>16</b> |
|--|-----------|

|                             |    |
|-----------------------------|----|
| Using the Direct Keys ..... | 16 |
|-----------------------------|----|

|                               |    |
|-------------------------------|----|
| Using the Control Panel ..... | 16 |
|-------------------------------|----|

|                       |    |
|-----------------------|----|
| Using the Menus ..... | 17 |
|-----------------------|----|

|                        |           |
|------------------------|-----------|
| <b>Menu List .....</b> | <b>18</b> |
|------------------------|-----------|

|                      |    |
|----------------------|----|
| Rec. Mode Menu ..... | 18 |
|----------------------|----|

|                  |    |
|------------------|----|
| Movie Menu ..... | 21 |
|------------------|----|

|                     |    |
|---------------------|----|
| Playback Menu ..... | 21 |
|---------------------|----|

|                   |    |
|-------------------|----|
| Set-up Menu ..... | 22 |
|-------------------|----|

|                           |    |
|---------------------------|----|
| Custom Setting Menu ..... | 23 |
|---------------------------|----|

|                              |           |
|------------------------------|-----------|
| <b>Getting Started .....</b> | <b>25</b> |
|------------------------------|-----------|

|                                  |           |
|----------------------------------|-----------|
| <b>Attaching the Strap .....</b> | <b>25</b> |
|----------------------------------|-----------|

|                               |           |
|-------------------------------|-----------|
| <b>Attaching a Lens .....</b> | <b>25</b> |
|-------------------------------|-----------|

|  |           |
|--|-----------|
| <b>Using the Battery and Charger .....</b> | <b>26</b> |
|--|-----------|

|                            |    |
|----------------------------|----|
| Charging the Battery ..... | 26 |
|----------------------------|----|

|                                      |    |
|--------------------------------------|----|
| Inserting/Removing the Battery ..... | 27 |
|--------------------------------------|----|

|                            |    |
|----------------------------|----|
| Using the AC Adapter ..... | 28 |
|----------------------------|----|

|                                      |           |
|--------------------------------------|-----------|
| <b>Inserting a Memory Card .....</b> | <b>28</b> |
|--------------------------------------|-----------|

|                               |           |
|-------------------------------|-----------|
| <b>Initial Settings .....</b> | <b>29</b> |
|-------------------------------|-----------|

|                             |    |
|-----------------------------|----|
| Turning the Camera On ..... | 29 |
|-----------------------------|----|

|                                    |    |
|------------------------------------|----|
| Setting the Display Language ..... | 29 |
|------------------------------------|----|

|                                 |    |
|---------------------------------|----|
| Setting the Date and Time ..... | 30 |
|---------------------------------|----|

|                                |    |
|--------------------------------|----|
| Formatting a Memory Card ..... | 31 |
|--------------------------------|----|

|                                       |           |
|---------------------------------------|-----------|
| <b>Basic Shooting Operation .....</b> | <b>31</b> |
|---------------------------------------|-----------|

|                               |    |
|-------------------------------|----|
| Shooting with Live View ..... | 33 |
|-------------------------------|----|

|                               |           |
|-------------------------------|-----------|
| <b>Reviewing Images .....</b> | <b>34</b> |
|-------------------------------|-----------|

|                              |           |
|------------------------------|-----------|
| <b>Taking Pictures .....</b> | <b>35</b> |
|------------------------------|-----------|

|   |           |
|---|-----------|
| <b>Configuring the Capture Settings .....</b> | <b>35</b> |
|---|-----------|

|                            |    |
|----------------------------|----|
| Memory Card Settings ..... | 35 |
|----------------------------|----|

|                              |    |
|------------------------------|----|
| Image Capture Settings ..... | 35 |
|------------------------------|----|

|                              |    |
|------------------------------|----|
| Movie Capture Settings ..... | 35 |
|------------------------------|----|

|                                    |           |
|------------------------------------|-----------|
| <b>Taking Still Pictures .....</b> | <b>36</b> |
|------------------------------------|-----------|

|                       |    |
|-----------------------|----|
| EV Compensation ..... | 37 |
|-----------------------|----|

|                               |           |
|-------------------------------|-----------|
| <b>Recording Movies .....</b> | <b>38</b> |
|-------------------------------|-----------|

|                           |    |
|---------------------------|----|
| Playing Back Movies ..... | 39 |
|---------------------------|----|

|                                   |           |
|-----------------------------------|-----------|
| <b>Setting the Exposure .....</b> | <b>39</b> |
|-----------------------------------|-----------|

|                   |    |
|-------------------|----|
| Sensitivity ..... | 39 |
|-------------------|----|

|                   |    |
|-------------------|----|
| AE Metering ..... | 40 |
|-------------------|----|

|                                       |           |
|---------------------------------------|-----------|
| <b>Using the Built-in Flash .....</b> | <b>41</b> |
|---------------------------------------|-----------|

|                                       |           |
|---------------------------------------|-----------|
| <b>Setting the Focus Method .....</b> | <b>42</b> |
|---------------------------------------|-----------|

|  |  |
|--|--|
| Setting the AF Mode when Shooting with the |  |
|--|--|

|                  |    |
|------------------|----|
| Viewfinder ..... | 43 |
|------------------|----|

|  |    |
|--|----|
| Setting the AF Mode during Live View ..... | 44 |
|--|----|

|                          |    |
|--------------------------|----|
| AF Fine Adjustment ..... | 45 |
|--------------------------|----|

|   |    |
|---|----|
| Checking the Depth of Field (Preview) ..... | 46 |
|---|----|

|                                     |           |
|-------------------------------------|-----------|
| <b>Setting the Drive Mode .....</b> | <b>47</b> |
|-------------------------------------|-----------|

|                           |    |
|---------------------------|----|
| Continuous Shooting ..... | 48 |
|---------------------------|----|

|                  |    |
|------------------|----|
| Self-timer ..... | 48 |
|------------------|----|

|                      |    |
|----------------------|----|
| Remote Control ..... | 49 |
|----------------------|----|

|                           |    |
|---------------------------|----|
| Exposure Bracketing ..... | 49 |
|---------------------------|----|

|                               |    |
|-------------------------------|----|
| Mirror Lock-up Shooting ..... | 50 |
|-------------------------------|----|

|                      |    |
|----------------------|----|
| Multi-exposure ..... | 50 |
|----------------------|----|

|                         |    |
|-------------------------|----|
| Interval Shooting ..... | 51 |
|-------------------------|----|

|                          |    |
|--------------------------|----|
| Interval Composite ..... | 51 |
|--------------------------|----|

|                             |    |
|-----------------------------|----|
| Interval Movie Record ..... | 52 |
|-----------------------------|----|

|  |           |  |            |
|--|-----------|--|------------|
| <b>Setting the White Balance</b> .....                         | <b>52</b> | Selecting Settings to Save in the Camera .....                       | 75         |
| Adjusting the White Balance Manually .....                     | 53        | <b>File Management Settings</b> .....                                | <b>75</b>  |
| Adjusting the White Balance with Color .....                   |           | Protecting Images from Deletion (Protect) .....                      | 75         |
| Temperature .....  | 54        | Selecting the Folder/File Settings .....                             | 76         |
| <b>Controlling the Image Finishing Touch</b> .....             | <b>54</b> | Setting the Copyright Information .....                              | 78         |
| Custom Image .....   | 54        | Using a Wireless Memory Card .....                                   | 78         |
| Digital Filter .....   | 56        | <b>Appendix</b> .....  | <b>80</b>  |
| <b>Correcting Images</b> .....                                 | <b>57</b> | <b>Restrictions on the Combinations of Special Functions</b> .....   | <b>80</b>  |
| Brightness Adjustment .....                                    | 57        | <b>Functions Available with Various Lenses</b> .....                 | <b>81</b>  |
| Lens Correction .....  | 57        | Setting the Focal Length .....                                       | 82         |
| Composition Adjustment .....                                   | 58        | Using the Aperture Ring .....  | 83         |
| Anti-Aliasing Filter Simulator .....                           | 58        | <b>Functions when Using an External Flash</b> .....                  | <b>84</b>  |
| <b>Playback Functions</b> .....                                | <b>59</b> | <b>Using the GPS Unit</b> .....                                      | <b>85</b>  |
| <b>Playback Mode Palette Items</b> .....                       | <b>59</b> | Shooting Celestial Bodies (ASTROTRACER) .....                        | 85         |
| <b>Changing the Playback Method</b> .....                      | <b>60</b> | <b>Troubleshooting</b> .....   | <b>86</b>  |
| Displaying Multiple Images .....                               | 60        | Sensor Cleaning .....  | 87         |
| Displaying Images by Folder .....                              | 61        | Error Messages .....   | 88         |
| Displaying Images by Shooting Date .....                       | 61        | <b>Main Specifications</b> .....                                     | <b>90</b>  |
| Playing Back Images Continuously (Slideshow) .....             | 62        | Operating Environment for USB Connection and Provided Software ..... | 94         |
| Displaying Rotated Images .....                                | 62        | <b>Index</b> .....   | <b>96</b>  |
| Connecting the Camera to an AV Device .....                    | 63        | <b>For Using Your Camera Safely</b> .....                            | <b>100</b> |
| <b>Connecting the Camera to a Computer</b> .....               | <b>64</b> | <b>Care to be Taken During Handling</b> .....                        | <b>101</b> |
| <b>Editing and Processing Images</b> .....                     | <b>65</b> | <b>WARRANTY POLICY</b> .....   | <b>104</b> |
| Copying an Image .....   | 65        |  |            |
| Changing the Image Size .....                                  | 65        |  |            |
| Correcting Color Moiré .....                                   | 66        |  |            |
| Processing Images with Digital Filters .....                   | 66        |  |            |
| Creating a Composite Image (Index) .....                       | 68        |  |            |
| Editing Movies .....   | 68        |  |            |
| RAW Development .....  | 69        |  |            |
| <b>Changing the Settings</b> .....                             | <b>71</b> |  |            |
| <b>Camera Settings</b> .....                                   | <b>71</b> |  |            |
| Customizing the Button/E-dial Functions .....                  | 71        |  |            |
| Saving Frequently Used Settings .....                          | 73        |  |            |
| Displaying the Local Date and Time of the Specified City ..... | 74        |  |            |

### Regarding copyrights

Images taken with this camera that are for anything other than personal enjoyment cannot be used without permission according to the rights as specified in the Copyright Act. Please take care, as there are cases where limitations are placed on taking pictures even for personal enjoyment during demonstrations, performances or of items on display. Images taken with the purpose of obtaining copyrights also cannot be used outside the scope of use of the copyright as laid out in the Copyright Act, and care should be taken here also.

### To users of this camera

- Do not use or store this camera in the vicinity of equipment that generates strong electromagnetic radiation or magnetic fields. Strong static charges or the magnetic fields produced by equipment such as radio transmitters could interfere with the monitor, damage the stored data, or affect the camera's internal circuitry and cause camera misoperation.
- The liquid crystal panel used for the monitor is manufactured using extremely high precision technology. Although the level of functioning pixels is 99.99% or better, you should be aware that 0.01% or fewer of the pixels may not illuminate or may illuminate when they should not. However, this has no effect on the recorded image.
- In this manual, the generic term "computer(s)" refers to either a Windows PC or a Macintosh.
- In this manual, the term "battery(ies)" refers to any type of batteries used for this camera and its accessories.



# Names and Functions of the Working Parts

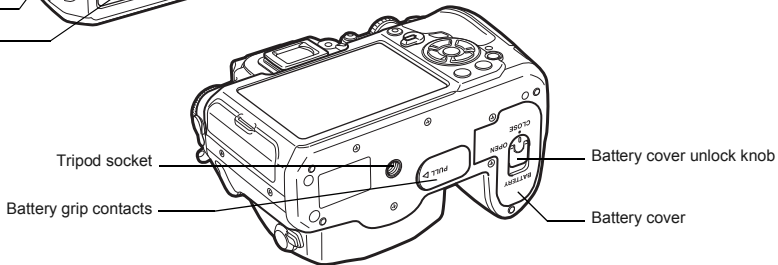
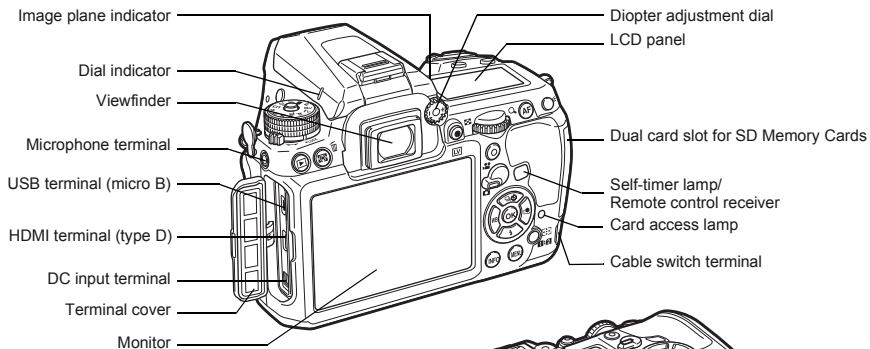
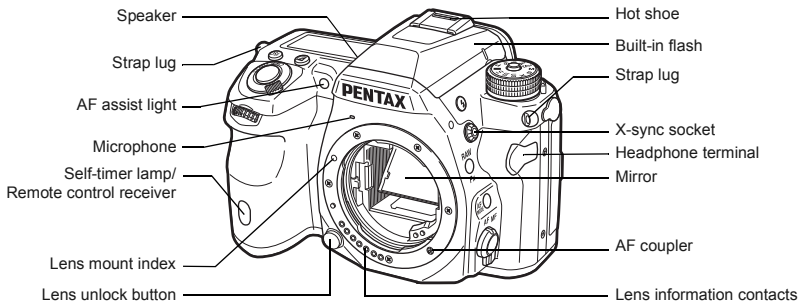

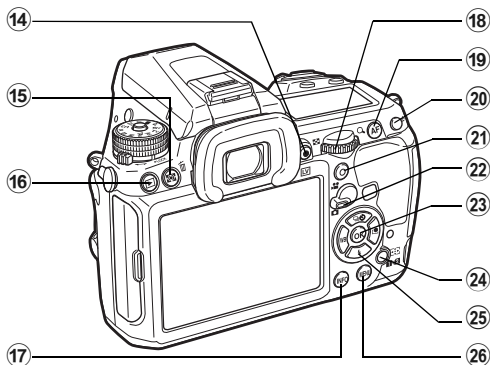
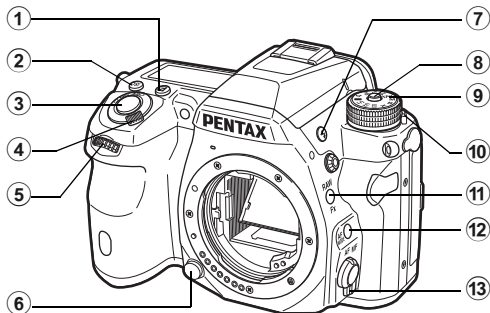

## Buttons and Dials





- ① **EV Compensation button** (☒)  
Press to change the exposure compensation value. (p.37)
- ② **ISO button** (ISO)  
Press to change the ISO sensitivity. (p.39)



- ③ **Shutter release button**  
Press to capture images. (p.32)  
In playback mode, press halfway to switch to capture mode.
- ④ **Main switch**  
Move to turn the power on/off or to preview. (p.29, p.46)
- ⑤ **Front e-dial** (☀)  
Changes the value for camera settings such as exposure. (p.36)  
You can change the menu category when a menu screen is displayed. (p.17)  
In playback mode, use this to select a different image.
- ⑥ **Lens unlock button**  
Press to detach a lens. (p.25)
- ⑦ **Flash pop-up button** (☂)  
Press to pop up the built-in flash. (p.41)
- ⑧ **Mode dial lock button**  
Press to allow the mode dial to be turned. (p.32)
- ⑨ **Mode dial**  
Changes the exposure mode. (p.32)
- ⑩ **Mode dial lock release lever**  
Use this lever to release mode dial lock to operate the mode dial without pressing the mode dial lock button. (p.32)
- ⑪ **RAW/Fx button** (RAW/Fx)  
You can assign a function to this button. (p.71)
- ⑫ **AF Mode button** (AF MODE)  
Press to change the AF Mode or AF point. (p.43)
- ⑬ **Focus mode switch**  
Press to change the focus mode. (p.42)
- ⑭ **Live View/REC button** (LV/REC)  
Displays the Live View image. (p.33)  
Starts/stops recording a movie in mode. (p.38)
- ⑮ **AE Metering/Delete button** (AE/DELETE)  
Press to change the metering method. (p.40)  
In playback mode, press to delete images. (p.34)
- ⑯ **Playback button** (▶)  
Switches to playback mode. (p.34) Press the button again to switch to capture mode.
- ⑰ **INFO button** (INFO)  
Changes the style of the display on the monitor. (p.9, p.12)

- 18 Rear e-dial** (  )  
Changes the value for camera settings such as exposure. (p.36)  
You can change the menu tabs when a menu screen is displayed. (p.17)  
You can change the settings when the control panel is displayed. (p.16)  
In playback mode, use this to magnify an image or display multiple images at the same time. (p.34, p.60)



- 19 AF button** (  )  
Available for adjusting focus, instead of pressing the shutter release button halfway. (p.42)



- 20 AE Lock button** (  )  
Locks the exposure value before shooting.  
In playback mode, the JPEG image that was just taken can also be saved in RAW format. (p.34)

- 21 Green button** (  )  
Resets the values being adjusted.  
Switches to ISO AUTO when adjusting the sensitivity.

- 22 Stills/Movies switch**  
Switches between  (Still capture) mode and  (Movie recording) mode. (p.31)

- 23 OK button** (  )  
When a menu or the control panel is displayed, press this button to confirm the selected item.

- 24 Change AF Point/Card slot switch button** (  /  )  
In capture mode, press this button to enable changing the AF point. (p.44)  
In playback mode, press this button to switch between the memory cards inserted in the two slots, SD1 and SD2. (p.34)

- 25 Four-way controller** (  )  
Displays the Drive Mode/Flash Mode/White Balance/Custom Image setup menu. (p.16)  
When a menu or the control panel is displayed, use this to move the cursor or change the item to set.  
Press  in single image display of playback mode to display the playback mode palette. (p.59)  
When selecting the area of an image to magnify or to use as a focusing area, you can move the area diagonally by pressing two keys at the same time.

- 26 MENU button** (  )  
Displays a menu. Press this button while the menu is displayed to return to the previous screen. (p.17)

## Monitor Display

### Capture Mode

With this camera, you can take pictures while looking through the viewfinder or while viewing the image on the monitor. When using the viewfinder, you can take pictures while checking the status screen displayed on the monitor and the viewfinder. When not using the viewfinder, you can take pictures while viewing the Live View image displayed on the monitor.

The camera is in “standby mode” when it is ready to shoot, such as when the status screen or Live View image is displayed. Press **INFO** in standby mode to display the “control panel” and change settings. (p.16) You can change the type of information displayed in standby mode by pressing **INFO** while the control panel is displayed. (p.12)

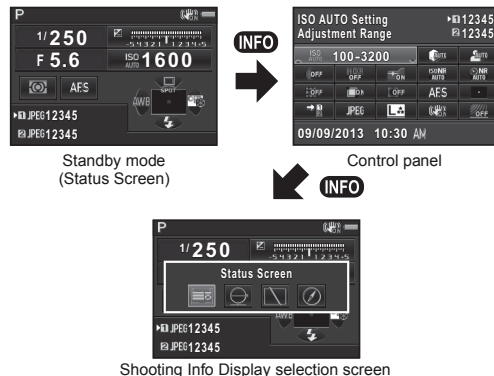

## Status Screen

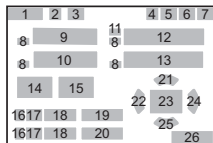

- |  |  |
|--|--|
| 1 Exposure Mode (p.36)                               | 14 AE Metering (p.40)  |
| 2 AE Lock  | 15 Focus Method (p.42)   |
| 3 Digital Filter (p.56)/HDR Capture (p.57)           | 16 Card slot number (p.35)   |
| 4 Wireless LAN status (p.78)                         | 17 File Format (p.35)  |
| 5 GPS positioning status (p.85)                      | 18 Image storage capacity  |
| 6 Shake Reduction/ Horizon Correction                | 19 Flash Exposure Compensation (p.41)  |
| 7 Battery level                                      | 20 White Balance fine-tuning (p.53)  |
| 8 E-dial guide                                       | 21 Drive Mode (p.47)   |
| 9 Shutter speed                                      | 22 White Balance (p.52)  |
| 10 Aperture value                                    | 23 AF point (p.44)   |
| 11 EV Compensation (p.37)/Exposure Bracketing (p.49) | 24 Custom Image (p.54)   |
| 12 EV bar scale                                      | 25 Flash Mode (p.41)   |
| 13 Sensitivity (p.39)                                | 26 Operation guide, and number of shots during Multi-exposure, Interval Shooting or Interval Composite |

## Live View

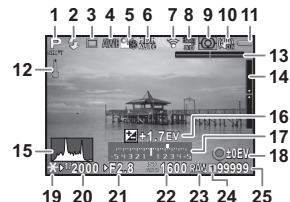

- |  |  |
|--|--|
| 1 Exposure Mode (p.36)                           | 14 Electronic Level (vertical tilt) (p.15)                                     |
| 2 Flash Mode (p.41)                              | 15 Histogram   |
| 3 Drive Mode (p.47)                              | 16 EV Compensation (p.37)  |
| 4 White Balance (p.52)                           | 17 EV bar scale  |
| 5 Custom Image (p.54)                            | 18 Operation guide   |
| 6 Digital Filter (p.56)/HDR Capture (p.57)       | 19 AE Lock   |
| 7 Wireless LAN status (p.78)                     | 20 Shutter speed   |
| 8 GPS positioning status (p.85)                  | 21 Aperture value  |
| 9 AE Metering (p.40)                             | 22 Sensitivity (p.39)  |
| 10 Shake Reduction/ Horizon Correction/ Movie SR | 23 File Format   |
| 11 Battery level                                 | 24 Card slot number in use (p.35)  |
| 12 Temperature warning                           | 25 Image storage capacity  |
| 13 Electronic Level (horizontal tilt) (p.15)     | 26 Face detection frame (when [Contrast AF] is set to [Face Detection]) (p.44) |

## Memo

- In [Live View] of the menu, you can change the settings of the items displayed on the monitor during Live View. (p.19)



## Shooting Info Display

You can change the type of information displayed in standby mode by pressing **INFO** while the control panel is displayed. Use **◀▶** to select the type and press **OK**.

### When shooting with the viewfinder

|                           |  |   |
|---------------------------|--|---|
| <b>Status Screen</b>      | Displays the settings for shooting with the viewfinder. (p.10)   |   |
| <b>Electronic Level</b>   | <p>Displays the camera angle.</p> <p>A bar scale indicating the horizontal camera angle appears at the bottom of the screen, and a bar scale indicating the vertical camera angle appears on the right side. If the camera angle cannot be detected, both ends and the center of the bar scales flash red.</p> |  <p>Example:<br/>Tilted 1.5° to the left (yellow)<br/>Vertically level (green)</p> |
| <b>Display Off</b>        | Nothing is displayed on the monitor.   |   |
| <b>Electronic Compass</b> | The current latitude, longitude, altitude, direction, and Coordinated Universal Time (UTC) are displayed. Turn the camera off and on again to return to the status screen. Available only when the optional GPS unit is attached to the camera and is operating. (p.85)  |   |

### When shooting with Live View

|                                     |  |
|-------------------------------------|--|
| <b>Standard Information Display</b> | The Live View image and the settings for shooting with Live View are displayed. (p.10) |
| <b>No Information Display</b>       | Certain icons, such as those for the Exposure Mode and Drive Mode, are not displayed.  |

### When the camera is held vertically

When the camera is rotated to the vertical position, the status screen and control panel are displayed in a vertical position. To not display images in the vertical position, set [Auto Screen Rotation] to [Off] in [LCD Display] of the **1** menu. (p.22)



### Playback Mode

The captured image and shooting information are displayed in single image display of the playback mode. Press **INFO** to change the type of information displayed in single image display. Use **◀▶** to select the type and press **OK**.



Single image display  
(Standard Information Display)



Playback Info Display  
selection screen

|                                     |  |
|-------------------------------------|--|
| <b>Standard Information Display</b> | Captured image, file format, exposure value, and operation guide indicators are displayed.         |
| <b>Detailed Information Display</b> | Detailed information on how and when the image was taken is displayed (p.13).                      |
| <b>Histogram Display</b>            | Captured image and brightness histogram are displayed (p.13). Not available during movie playback. |
| <b>RGB Histogram Display</b>        | Captured image and RGB histogram are displayed (p.13). Not available during movie playback.        |
| <b>No Information Display</b>       | Only the captured image is displayed.  |

### Memo

- The display selected in Playback Info Display selection screen appears in playback mode when the camera is turned off and on again. If [Playback Info Display] is set to [Off] in [Memory] of the **4** menu, the [Standard Information Display] always appears first when the camera is turned on. (p.75)

## Detailed Information Display

### Still pictures

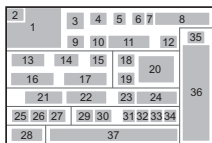

### Movies

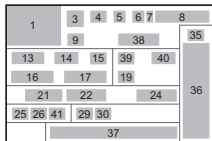

### Page 2

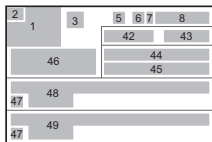
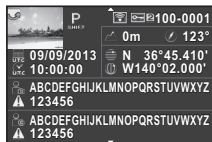

- 1 Captured image
- 2 Rotation information (p.62)
- 3 Exposure Mode (p.36)
- 4 Digital Filter (p.56)/HDR Capture (p.57)
- 5 Transferred via Wireless LAN (p.78)
- 6 Protect setting (p.75)
- 7 Card slot number in use
- 8 Folder number-File number (p.76)
- 9 Drive Mode (p.47)
- 10 Flash Mode (p.41)
- 11 Flash Exposure Compensation (p.41)
- 12 Color Moiré Correction (p.66)
- 13 Shutter speed
- 14 Aperture value
- 15 Shake Reduction/ Horizon Correction/ Movie SR
- 16 Sensitivity (p.39)
- 17 EV Compensation (p.37)
- 18 Focus Method (p.42)

- 19 AE Metering (p.40)
- 20 AF point (p.44)
- 21 White Balance (p.52)
- 22 White Balance fine-tuning (p.53)
- 23 AA Filter Simulator (p.58)
- 24 Lens focal length
- 25 File Format (p.35)
- 26 JPEG Recorded Pixels (p.35)/movie recorded pixels (p.35)
- 27 JPEG Quality (p.35)
- 28 Color Space (p.24)
- 29 Highlight Correction (p.57)
- 30 Shadow Correction (p.57)
- 31 Distortion Correction (p.57)
- 32 Lateral Chromatic Aberration Adjustment (p.57)
- 33 Peripheral Illumination Correction (p.57)
- 34 Color Fringe Correction (p.69)
- 35 Custom Image setting (p.54)
- 36 Custom Image parameters
- 37 Shooting date and time
- 38 Length of time of the recorded movie
- 39 Volume
- 40 Sound
- 41 Framerate (p.35)
- 42 Altitude (p.85)
- 43 Lens direction (p.85)
- 44 Latitude (p.85)
- 45 Longitude (p.85)
- 46 Universal Coordinated Time
- 47 Information tampering warning
- 48 Photographer (p.78)
- 49 Copyright Holder (p.78)

## Histogram Display/RGB Histogram Display

Use ▲ ▼ to switch between the Histogram Display and RGB Histogram Display.

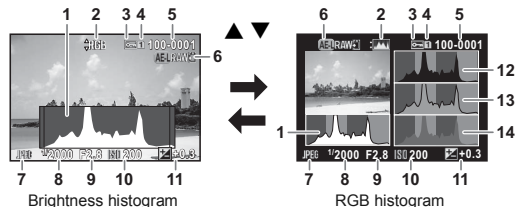

- 1 Histogram (Brightness)
- 2 Switch RGB histogram/ Brightness histogram
- 3 Protect setting
- 4 Card slot number in use
- 5 Folder number-File number
- 6 Save RAW Data
- 7 File Format
- 8 Shutter speed

- |                    |                  |
|--------------------|------------------|
| 9 Aperture value   | 12 Histogram (R) |
| 10 Sensitivity     | 13 Histogram (G) |
| 11 EV Compensation | 14 Histogram (B) |

## Viewfinder

When shooting with the viewfinder, the following information appears in the viewfinder.

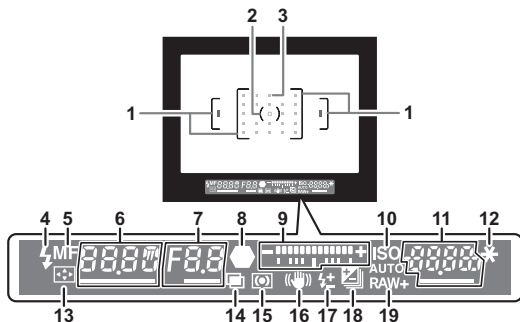

- |   |  |
|---|--|
| 1 AF frame (p.32)                         | 11 Sensitivity (p.39)/<br>Exposure compensation<br>value   |
| 2 Spot metering frame<br>(p.40)           | 12 AE Lock   |
| 3 AF point (p.44)                         | 13 Change AF Point (p.44)                                  |
| 4 Flash indicator (p.41)                  | 14 Multi-exposure (p.50)                                   |
| 5 Focus Method (p.42)                     | 15 AE Metering (p.40)                                      |
| 6 Shutter speed                           | 16 Shake Reduction   |
| 7 Aperture value                          | 17 Flash Exposure<br>Compensation (p.41)                   |
| 8 Focus indicator                         | 18 EV Compensation<br>(p.37)/Exposure<br>Bracketing (p.49) |
| 9 EV bar scale/Electronic<br>Level (p.15) | 19 File Format (p.35)                                      |
| 10 ISO/ISO AUTO                           |  |

## Memo

- The information is displayed in the viewfinder when the shutter release button is pressed halfway, or during the meter operating time (default setting: 10 sec.).
- The AF point in use for autofocus appears in red (Superimpose AF Area) when the shutter release button is pressed halfway. You can set it to [Off] in [14. Superimpose AF Area] of the **C2** menu.
- You can adjust the diopter in the viewfinder using the diopter adjustment dial. Adjust the dial until the AF frame in the viewfinder is focused.

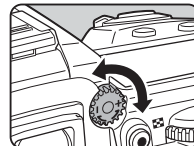



## LCD Panel

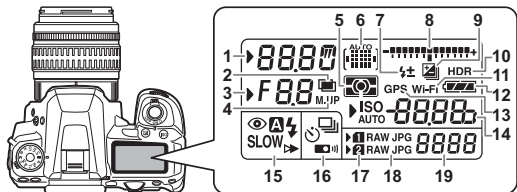

- |   |   |
|---|---|
| 1 Shutter speed                                     | 12 Battery level  |
| 2 Multi-exposure (p.50)                             | 13 GPS unit connected (p.85)  |
| 3 Aperture value                                    | 14 Sensitivity (p.39)/EV Compensation (p.37)  |
| 4 Mirror Lock-up Shooting (p.50)                    | 15 Flash Mode (p.41)  |
| 5 AE Metering (p.40)                                | 16 Drive Mode (p.47)  |
| 6 AF point (p.44)                                   | 17 Card slot number (p.35)  |
| 7 Flash Exposure Compensation (p.41)                | 18 File Format (p.35)   |
| 8 EV bar scale/Electronic Level (p.15)              | 19 Remaining image storage capacity/USB Connection mode (p.64)/ External flash channel (p.84)/Sensor cleaning in progress |
| 9 EV Compensation (p.37)/Exposure Bracketing (p.49) |   |
| 10 HDR Capture (p.57)                               |   |
| 11 Wireless LAN connection (p.78)                   |   |

### Memo

- You can change the LCD panel backlight setting in [22. LCD Panel Illumination] of the **C4** menu. (p.24) You can also set the camera so that the LCD panel illumination turns on or off when **RAW** is pressed. (p.71)

## Electronic Level

You can check whether the camera is tilted horizontally by displaying the electronic level. The electronic level can be displayed in the EV bar scale in the viewfinder and/or LCD panel, or on the Live View screen. Select whether to display the electronic level in [Electronic Level] of the **C3** menu. (p.19)

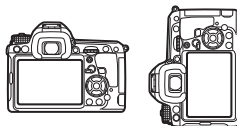

When level (at 0°)



When tilted 5° to the left



When held vertically and tilted 3° to the right

## How to Change Function Settings

The camera functions and their settings can be selected and changed by using the following ways.

|                      |  |
|----------------------|--|
| <b>Direct keys</b>   | Press ▲▼▶◀ in standby mode.  |
| <b>Control panel</b> | Press <b>INFO</b> in standby mode.<br>(indicated with the  mark in this manual) |
| <b>Menus</b>         | Press <b>MENU</b> .  |

### Using the Direct Keys



|   |               |      |
|---|---------------|------|
| ▲ | Drive Mode    | p.47 |
| ▼ | Flash Mode    | p.41 |
| ◀ | White Balance | p.52 |
| ▶ | Custom Image  | p.54 |

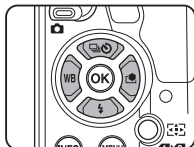

## Using the Control Panel

You can set frequently used shooting functions. Press **INFO** in standby mode.

Use ▲▼▶◀ to select an item.

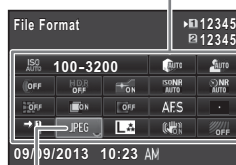

Use  to change settings.

Press **OK** to make detailed settings.



Press **MENU** to cancel setting operation.

Press **OK** to confirm the selected item and return to the control panel.

Most functions are set from the menus. Functions that can be set on the control panel can also be set from the menus.

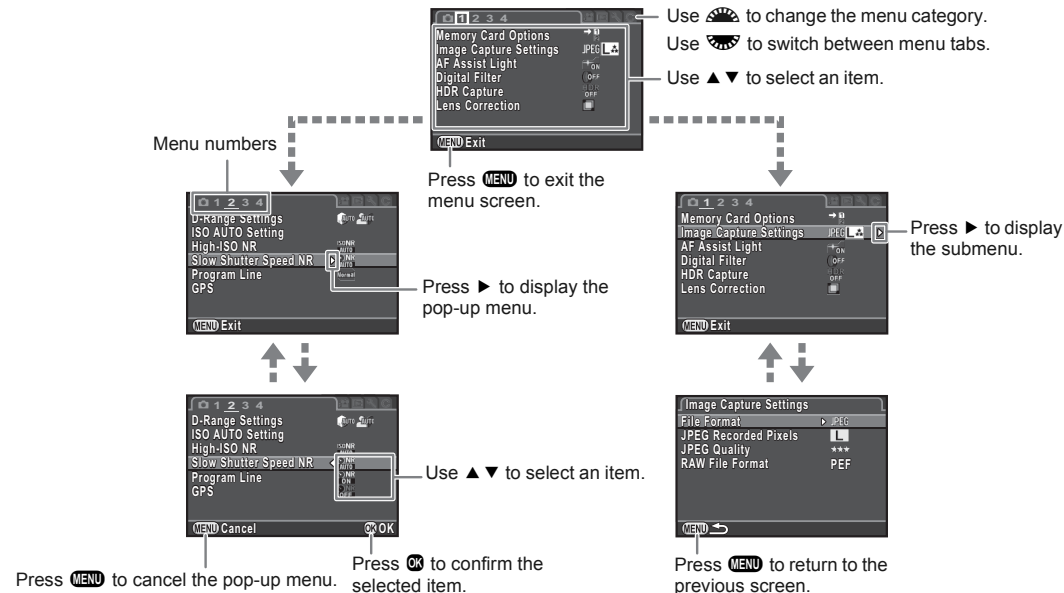

## Memo













- For the Custom Setting menu (C1-4), you can show the setting screen of the next item in order of the menu on the monitor by turning while the submenu of the currently selected item is displayed.
- Press to display the first tab of the menu that is appropriate to the current conditions. To display the menu tab last selected first, set in [24. Save Menu Location] of the C4 menu.
- Settings are returned to their default values with [Reset] of the menu. To reset all the settings in the Custom Setting menu to the defaults, use [Reset Custom Functions] of the C4 menu. (Some settings do not apply.)

# Menu List

## Rec. Mode Menu

| Menu | Item                   | Function  | Default Setting   | Page                     |      |
|------|------------------------|---|---|--------------------------|------|
| ☑1   | Exposure Modes *1      | Temporarily changes the exposure mode when the mode dial is set to <b>U1</b> , <b>U2</b> or <b>U3</b> . | <b>P</b>  | p.74                     |      |
|      | Memory Card Options *2 | Sets the recording method for when two memory cards are inserted.                                       | →   | p.35                     |      |
|      | Image Capture Settings | File Format *2  | Sets the file format of images.   | JPEG                     | p.35 |
|      |                        | JPEG Recorded Pixels *2   | Sets the recording size of images saved in JPEG format.                 | <input type="checkbox"/> |      |
|      |                        | JPEG Quality *2   | Sets the quality of images saved in JPEG format.                        | ★★★                      |      |
|      |                        | RAW File Format   | Sets the RAW file format.   | PEF                      |      |
|      | AF Assist Light *2     | Sets whether to use the assist light when autofocusing in dark locations.                               | On  | p.43                     |      |
|      | Digital Filter *2      | Specifies a digital filter effect when taking pictures.   | No Filter   | p.56                     |      |
|      | HDR Capture            | HDR Capture *2  | Sets the type of high dynamic range shooting.                           | Off                      | p.57 |
|      |                        | Exposure Bracket Value *2   | Sets the range in which to change the exposure.                         | ±2EV                     |      |
|      |                        | Auto Align  | Sets whether to automatically adjust the composition.                   | On                       |      |
|      | Lens Correction        | Distortion Correction *2  | Reduces distortions occurring due to lens properties.                   | Off                      | p.57 |
|      |                        | Lat-Chromatic-Ab Adj *2   | Reduces lateral chromatic aberrations occurring due to lens properties. | On                       |      |
|      |                        | Peripheral Illumin. Corr. *2  | Reduces peripheral light fall-off occurring due to lens properties.     | Off                      |      |
| ☑2   | D-Range Settings *2    | Expands the dynamic range and prevents bright and dark areas from occurring.                            | Auto/Auto   | p.57                     |      |
|      | ISO AUTO Setting *2    | Sets the range of automatic correction in ISO AUTO and AUTO ISO Parameters.                             | ISO 100 to ISO 3200/Standard  | p.39                     |      |
|      | High-ISO NR *2         | Sets the Noise Reduction setting when shooting with a high ISO sensitivity.                             | Auto  | p.40                     |      |





| Menu                      | Item                            | Function  | Default Setting   | Page           |      |
|---------------------------|---------------------------------|---|---|----------------|------|
| 📷2                        | <b>Slow Shutter Speed NR</b> *2 | Sets the Noise Reduction setting when shooting with a slow shutter speed.                     | Auto  | –              |      |
|                           | <b>Program Line</b>             | Selects Program Line.   | Normal  | p.37           |      |
|                           | <b>GPS</b>                      | Sets the camera action for when the optional GPS unit is used.                                | –   | p.85           |      |
| 📷3                        | <b>Live View</b>                | <b>Contrast AF</b> *2   | Sets the AF Mode for shooting with Live View.   | Face Detection | p.44 |
|                           |                                 | <b>Focus Peaking</b> *2   | Emphasizes the outline of the subject in focus and makes it easier to check the focus.  | Off            | p.45 |
|                           |                                 | <b>Grid Display</b>   | Displays the grid during Live View.   | Off            | p.10 |
|                           |                                 | <b>Histogram Display</b>  | Displays the histogram during Live View.  | Off            |      |
|                           |                                 | <b>Highlight Alert</b>  | Bright (overexposed) areas blink red during Live View.                                  | Off            |      |
|                           |                                 | <b>Composition Adjust.</b>  | Allows you to adjust the composition of your image using the Shake Reduction mechanism. | Off            | p.58 |
|                           | <b>Electronic Level</b>         | <b>Viewfinder</b>   | Displays the electronic level in the EV bar scale in the viewfinder and/or LCD panel.   | Off            | p.15 |
|                           |                                 | <b>Live View</b>  | Displays the electronic level during Live View.   | On             | p.10 |
|                           | <b>Horizon Correction</b>       |   | Corrects horizontal tilt of the camera.   | Off            | –    |
|                           | <b>AA Filter Simulator</b> *2   |   | Applies low-pass filter effects using the Shake Reduction mechanism.                    | Off            | p.58 |
|                           | <b>Shake Reduction</b> *2       |   | Activates the Shake Reduction function.   | On             | –    |
| <b>Input Focal Length</b> |                                 | Sets the focal length when using a lens of which focal length information cannot be obtained. | 35mm  | p.82           |      |
| 📷4                        | <b>Instant Review</b>           | <b>Display Time</b>   | Sets the Instant Review display time.   | 1sec.          | p.32 |
|                           |                                 | <b>Zoom Instant Review</b>  | Sets whether to display a magnified image during Instant Review.                        | On             |      |
|                           |                                 | <b>Save RAW Data</b>  | Sets whether to save the RAW image during Instant Review.                               | On             |      |
|                           |                                 | <b>Delete</b>   | Sets whether to delete the image during Instant Review.                                 | On             |      |
|                           |                                 | <b>Histogram Display</b>  | Displays the histogram during Instant Review.   | Off            |      |
|                           |                                 | <b>Highlight Alert</b>  | Bright (overexposed) areas blink red during Instant Review.                             | Off            |      |

| Menu           | Item  | Function  | Default Setting  | Page                 |      |
|----------------|---|---|--|----------------------|------|
| 4              | Digital Preview   | Zoom Instant Review   | Sets whether to display a magnified image during Digital Preview.  | On                   | p.46 |
|                |   | Save Preview Image  | Sets whether to enable saving an image displayed in Digital Preview.   | On                   |      |
|                |   | Histogram Display   | Displays the histogram during Digital Preview.   | Off                  |      |
|                |   | Highlight Alert   | Bright (overexposed) areas blink red during Digital Preview.   | Off                  |      |
|                | E-Dial Programming  | P   | Sets the  /  /  operation for each exposure mode. | Tv, Av, <b>➔P</b>    | p.71 |
|                |   | Sv  |  | -, ISO, -            |      |
|                |   | Tv  |  | Tv, -, -             |      |
|                |   | Av  |  | -, Av, -             |      |
|                |   | TAv   |  | Tv, Av, PLINE        |      |
|                |   | M   |  | Tv, Av, PLINE        |      |
|                |   | B   |  | -, Av, -             |      |
|                |   | X   |  | -, Av, -             |      |
|                |   |    |  | -, -, -              |      |
|                |   |    |  | -, Av, PLINE         |      |
|                |   |    |  | Tv, Av, PLINE        |      |
|                |  | Tv, Av, PLINE   |  |                      |      |
|                | Rotation Direction  | Reverses the effect obtained when  or  is turned. | Rotate Right   |                      |      |
|                | Button Customization  | RAW/Fx Button   | Sets the  operation.  | One Push File Format | p.71 |
|                |   | AF Button   | Sets the  operation.  | Enable AF1           |      |
|                |   | Preview Dial  | Sets the camera action for when the main switch is turned to the  position.   | Optical Preview      |      |
| Memory         |   | Determines which settings to save when the power is turned off.   | On for settings other than Digital Filter and HDR Capture  | p.75                 |      |
| Save USER Mode |   | You can save frequently used capture settings to <b>U1</b> , <b>U2</b> or <b>U3</b> of the mode dial.   | -  | p.73                 |      |

\*1 Appears only when the mode dial is set to **U1**, **U2**, or **U3**.



\*2 Can also be set from the control panel.

## Movie Menu

| Menu   | Item                             | Function   | Default Setting   | Page |
|--|----------------------------------|--|---|------|
|  1 | <b>Exposure Setting</b> *1       | Sets the exposure mode for  mode. |      | p.38 |
|  | <b>Memory Card Options</b> *1    | Selects one of memory cards inserted in SD1 and SD2 slots for recording movies.                                    | SD1   | p.35 |
|  | <b>Movie Capture Settings</b> *1 | Sets the number of recorded pixels and framerate.  |  /30p | p.35 |
|  | <b>Recording Sound Level</b> *1  | Sets the Recording Sound Level and the volume level for recording.   | Auto  | –    |
|  | <b>Digital Filter</b> *1         | Sets a digital filter effect when taking pictures.   | No Filter   | p.56 |
|  | <b>HDR Capture</b> *1            | Sets the type of high dynamic range shooting when the drive mode is set to [Interval Movie Record].                | Off   | p.57 |
|  | <b>Movie SR</b> *1               | Activates the Movie Shake Reduction function.  | On  | –    |

\*1 Can also be set from the control panel.

## Playback Menu

| Menu   | Item                       | Function  | Default Setting | Page |
|--|----------------------------|---|-----------------|------|
|  1 | <b>Display Duration</b>    | Sets an image display interval.   | 3sec.           | p.62 |
|  | <b>Screen Effect</b>       | Sets a transition effect when the next image is displayed.  | Off             |      |
|  | <b>Repeat Playback</b>     | Starts the slideshow again from the beginning after the last image is displayed.  | Off             |      |
|  | <b>Auto Movie Playback</b> | Plays back movies during the slideshow.   | On              |      |
|  1 | <b>Quick Zoom</b>          | Sets the initial magnification when magnifying images.  | Off             | –    |
|  | <b>Highlight Alert</b>     | Bright (overexposed) portions blink red in Standard Information Display or Histogram Display in playback mode.                                      | Off             | –    |
|  | <b>Auto Image Rotation</b> | Images are rotated when playing back images captured with the camera held vertically or images for which the rotation information has been changed. | On              | p.62 |
|  | <b>Protect All Images</b>  | Protects all images stored in the memory card at once.  | –               | –    |
|  | <b>Delete All Images</b>   | Deletes all images stored in the memory card at once.   | –               | –    |





## Set-up Menu

1

Introduction

| Menu                         | Item                     | Function  | Default Setting  | Page |      |
|------------------------------|--------------------------|---|--|------|------|
| 1                            | <b>Language/言語</b>       | Changes the display language.   | English  | p.29 |      |
|                              | <b>Date Adjustment</b>   | Sets the date and time or display format.   | 01/01/2013   | p.30 |      |
|                              | <b>World Time</b>        | Switches between the date and time display of your hometown city and that of a specified city.  | Hometown   | p.74 |      |
|                              | <b>Text Size</b>         | Sets whether to magnify the text size when selecting a menu.  | Standard   | p.30 |      |
|                              | <b>Sound Effects</b>     | Switches the operation sound on/off and changes the volume for In-focus, AE-L, Self-timer, Remote Control, Mirror Up, Change AF Point, and the <b>RAW</b> button operation. | Volume 3/<br>All On  | –    |      |
|                              | <b>LCD Display</b>       | <b>Guide Display</b>  | Sets whether to display the operation guides when the exposure mode is changed.                          | On   | p.32 |
|                              |                          | <b>Auto Screen Rotation</b>   | Sets whether to display the status screen and control panel vertically if the camera is held vertically. | On   | p.12 |
| <b>Display Color</b>         |                          | Sets the display color of the status screen, menu cursor, and control panel.  | 1  | p.11 |      |
| <b>LCD Display Settings</b>  |                          | Adjusts the brightness, saturation and the color of the monitor.  | 0  | –    |      |
| 2                            | <b>USB Connection</b>    | Sets the USB connection mode when connecting to a computer.   | MSC  | p.64 |      |
|                              | <b>HDMI Out</b>          | Sets the output format when connecting to an AV device with an HDMI input terminal.   | Auto   | p.63 |      |
|                              | <b>Folder Name</b>       | Sets the folder name in which images are stored.  | Date   | p.76 |      |
|                              | <b>Create New Folder</b> | Creates a new folder on the memory card.  | –  | p.76 |      |
|                              | <b>File Name</b>         | Sets the file name assigned to the image.   | IMGP/_IMG  | p.77 |      |
|                              | <b>File No.</b>          | <b>Sequential Numbering</b>   | Sets whether to continue the sequential numbering for the file name when a new folder is created.        | On   | p.77 |
|                              |                          | <b>Reset File Number</b>  | Resets the file number setting, and returns to 0001 each time a new folder is created.                   | –    |      |
| <b>Copyright Information</b> |                          | Sets the photographer and copyright information embedded in Exif.   | Off  | p.78 |      |
| 3                            | <b>Flicker Reduction</b> | Cuts down on screen flicker by setting the power frequency.   | 50Hz   | –    |      |
|                              | <b>Auto Power Off</b>    | Sets the time until the camera turns off automatically if no operations are made for a certain period of time.  | 1 min.   | p.29 |      |
|                              | <b>Select Battery</b>    | Sets the camera action for when the optional battery grip is attached to the camera.  | Auto Select/<br>Auto-detect  | p.27 |      |



| Menu | Item                         | Function  | Default Setting | Page |
|------|------------------------------|---|-----------------|------|
| ↖3   | <b>Wireless Memory Card</b>  | Sets the camera action for when an Eye-Fi card or a Flucard is used.  | –               | p.78 |
|      | <b>Reset</b>                 | Resets the settings of the direct keys and for the items of the  menu,  menu,  menu,  menu, control panel, and playback mode palette. | –               | –    |
| ↖4   | <b>Pixel Mapping</b>         | Maps out and corrects any defective pixels on the CMOS sensor.  | –               | p.86 |
|      | <b>Dust Alert</b>            | Detects dust adhering to the CMOS sensor and visually displays the location of the dust on the monitor.   | –               | p.87 |
|      | <b>Dust Removal</b>          | Cleans the CMOS sensor by shaking it.   | –               | p.86 |
|      | <b>Sensor Cleaning</b>       | Locks the mirror in the up position for cleaning the CMOS sensor with a blower.   | –               | p.87 |
|      | <b>Format</b>                | Formats a memory card.  | –               | p.31 |
|      | <b>Firmware Info/Options</b> | Displays the camera's firmware version.   | –               | –    |

## Custom Setting Menu

| Menu | Item                            | Function  | Default Setting    | Page |
|------|---------------------------------|---|--------------------|------|
| C1   | <b>1. EV Steps</b>              | Sets the adjustment steps for exposure.   | 1/3 EV Steps       | p.37 |
|      | <b>2. Sensitivity Steps</b>     | Sets the adjustment steps for ISO sensitivity.  | 1 EV Step          | p.39 |
|      | <b>3. Meter Operating Time</b>  | Sets the meter operating time.  | 10sec.             | –    |
|      | <b>4. AE-L with AF Locked</b>   | Sets whether to lock the exposure value when the focus is locked.   | Off                | –    |
|      | <b>5. Link AE and AF Point</b>  | Sets whether to link the exposure and AF point in the focusing area.  | Off                | p.40 |
|      | <b>6. Auto EV Compensation</b>  | Sets whether to automatically compensate when the proper exposure cannot be determined.                                     | Off                | –    |
|      | <b>7. Bulb (B) Mode Options</b> | Sets the camera operation when pressing the shutter release button in <b>B</b> mode.  | Mode1              | –    |
| C2   | <b>8. Bracketing Order</b>      | Sets the order for Exposure Bracketing shooting.  | 0 - +              | p.49 |
|      | <b>9. One-Push Bracketing</b>   | Sets whether to shoot all frames with one release when using Exposure Bracketing.   | Off                | p.49 |
|      | <b>10. WB Adjustable Range</b>  | Sets whether to automatically fine-tune the white balance when the light source is specified for the white balance setting. | Fixed              | p.53 |
|      | <b>11. WB When Using Flash</b>  | Sets the white balance setting for when using flash.  | Auto White Balance | p.53 |

| Menu | Item                          | Function  | Default Setting     | Page |
|------|-------------------------------|---|---------------------|------|
| C2   | 12. AWB in Tungsten Light     | Sets the tungsten light color tone for when the white balance is set to <b>AWB</b> (Auto White Balance).  | Subtle Correction   | p.53 |
|      | 13. Color Temperature Steps   | Sets the adjustment steps for color temperature.  | Kelvin              | p.54 |
|      | 14. Superimpose AF Area       | Sets whether to display the active AF point in red in the viewfinder.   | On                  | p.14 |
| C3   | 15. AF.S Setting              | Sets the action priority for when the focus mode is set to <b>AF.S</b> and the shutter release button is fully pressed.   | Focus-priority      | p.43 |
|      | 16. 1st Frame Action in AF.C  | Sets the action priority for the first frame when the focus mode is set to <b>AF.C</b> and the shutter release button is fully pressed.                           | Release-priority    | p.43 |
|      | 17. Action in AF.C Continuous | Sets the action priority during continuous shooting when the focus mode is set to <b>AF.C</b> .   | Focus-priority      | p.43 |
|      | 18. Hold AF Status            | Sets whether to maintain the focus for a certain amount of time when the subject happens to move out of the selected focusing area after being focused.           | Off                 | p.43 |
|      | 19. AF with Remote Control    | Sets whether to use autofocus when shooting with a remote control unit.   | Off                 | p.49 |
|      | 20. Release While Charging    | Sets whether to release the shutter while the built-in flash is being charged.  | Off                 | p.41 |
|      | 21. Color Space               | Sets the color space to use.  | sRGB                | –    |
| C4   | 22. LCD Panel Illumination    | Sets the illumination for the LCD panel.  | High                | p.15 |
|      | 23. Save Rotation Info        | Sets whether to save rotation information when shooting.  | On                  | p.62 |
|      | 24. Save Menu Location        | The last menu tab displayed on the monitor is saved, and it is displayed again the next time <b>MENU</b> is pressed.  | Reset Menu Location | p.17 |
|      | 25. Catch-in Focus            | Sets whether to enable Catch-in Focus shooting when a manual focus lens is attached, and the shutter is released automatically when the subject comes into focus. | Off                 | –    |
|      | 26. AF Fine Adjustment        | Allows you to precisely fine tune your lenses with the camera's autofocus system.   | Off                 | p.45 |
|      | 27. Using Aperture Ring       | Sets whether to enable shutter release when the lens aperture ring is set to a position other than <b>A</b> .   | Disable             | p.83 |
|      | Reset Custom Functions        | Resets all the settings of the Custom Setting menu to the defaults.   | –                   | –    |

## Attaching the Strap

- 1 Pass the end of the strap through the protective cover and triangular ring.

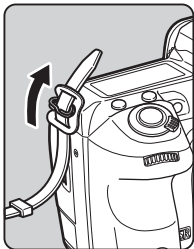

- 2 Secure the end of the strap on the inside of the clasp.

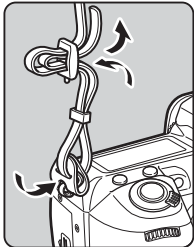

## Attaching a Lens

- 1 Make sure that the camera is turned off.
- 2 Remove the body mount cover (1) and lens mount cover (2).

After removing the cover, be sure to put the lens down with the lens mount side facing upward.

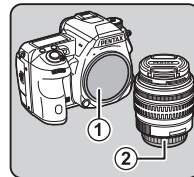

- 3 Align the lens mount index (red dots: 3) on the camera and the lens, and secure by turning the lens clockwise until it clicks.

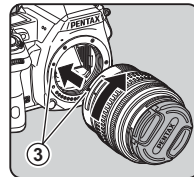

### To remove the lens

Attach the lens cap → turn the lens counterclockwise while pressing the lens unlock button (4).

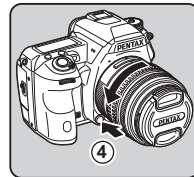

**Caution**

- When attaching or removing the lens, choose an environment that is relatively free of dirt and dust.
- Keep the body mount cover on the camera when a lens is not attached.
- Be sure to attach the lens mount cover and lens cap to the lens after removing it from the camera.
- Do not insert your fingers inside the lens mount of the camera or touch the mirror.
- The camera body and lens mount incorporate lens information contacts. Dirt, dust, or corrosion may damage the electrical system. Please contact your nearest service center for professional cleaning.
- We assume no responsibility nor liability for accidents, damages and malfunctions resulting from the use of lenses made by other manufacturers.

**Memo**

- Refer to "Functions Available with Various Lenses" (p.81) for details on the functions of each lens.

**Using the Battery and Charger**

Use the battery D-LI90 and battery charger D-BC90 exclusively developed for this camera.

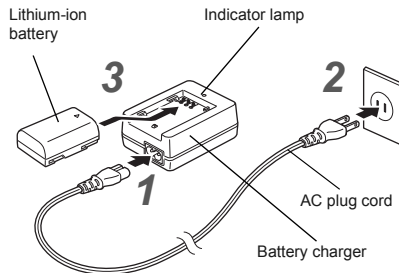
**Charging the Battery****1 Connect the AC plug cord to the battery charger.****2 Plug the AC plug cord into the power outlet.****3 Face the ▲ mark on the battery up, and insert it into the battery charger.**

The indicator lamp is lit while charging and turns off when the battery is fully charged.

**Caution**

- Do not use the battery charger D-BC90 to charge batteries other than D-LI90. Charging other batteries may cause damage or heating.
- Replace the battery with a new one in the following cases:
  - If the indicator lamp blinks or does not light after the battery is inserted correctly
  - If the battery starts to run down more quickly even after being charged (the battery may have reached the end of its service life)

## Memo

- The maximum charging time is approximately 390 minutes (it depends on temperature and remaining battery power). Charge in a location where the temperature is between 0°C and 40°C (32°F and 104°F).

## Inserting/Removing the Battery

### Caution

- Insert the battery correctly. If the battery is inserted incorrectly, it may not be removed.
- Wipe the electrodes of the battery with a soft dry cloth before inserting.
- Do not open the battery cover or remove the battery while the power is on.
- Be careful as the camera or battery may become hot when the camera is used continuously for a long period of time.
- Remove the battery when you will not use the camera for a long time. The battery may leak and damage the camera if left installed during prolonged periods of non-use. If the removed battery will not be used for six months or longer, charge the battery for about 30 minutes before storing it, and after that, recharge the battery every six to twelve months.
- Store the battery in a location where the temperature will remain at or below room temperature. Avoid locations with high temperatures.
- The date and time may be reset if you leave the battery out of the camera for long periods of time. If this happens, set the current date and time.

## 1 Open the battery cover.

Lift the battery cover unlock knob, turn it towards OPEN to unlock, and then pull the cover open.



## 2 Face the ▲ mark on the battery towards outside of the camera, and insert the battery until it locks into place.

To remove the battery, push the battery lock lever in the direction of ③.

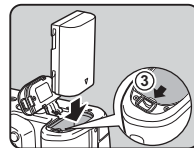

## 3 Close the battery cover.

Turn the battery cover unlock knob towards CLOSE to lock.



## Memo

- The battery level may not be displayed properly if the camera is used at low temperatures or when performing continuous shooting for a long time.
- Battery performance temporarily decreases as the temperature decreases. When using the camera in cold climates, have extra batteries at hand and keep them warm in your pocket. Battery performance will return to normal when returned to room temperature.
- Have extra batteries ready when traveling overseas, or taking a lot of pictures.
- When the optional Battery Grip D-BG5 is used, the following settings can be made in [Select Battery] of the 3 menu.
  - Priority of battery use
  - Type of AA batteries used

## Using the AC Adapter

We recommend the use of the optional AC adapter kit K-AC132 when using the monitor for a long time or when connecting the camera to a computer or AV device.

- 1 Make sure that the camera is turned off, and open the terminal cover.

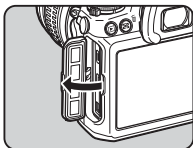

- 2 Align the ▲ marks on the DC terminal of the AC adapter and DC input terminal of the camera, and connect.

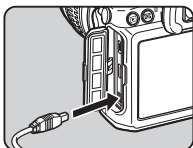

- 3 Connect the AC adapter to the AC plug cord, and plug the cord into the power outlet.

### Caution

- Make sure the camera is turned off before connecting or disconnecting the AC adapter.
- Make sure connections are secure between the terminals. The memory card or data may be corrupted if the connection to the power supply is lost while the card is being accessed.
- Be sure to read the manual of the AC adapter kit before using the AC adapter.

## Inserting a Memory Card

The following memory cards can be used with this camera.

- SD Memory Card, SDHC Memory Card, and SDXC Memory Card
- Eye-Fi card
- Flucard compatible with this camera

In this manual, they are referred to as memory cards.

- 1 Make sure that the camera is turned off.

- 2 Slide the card cover in the direction of ①.

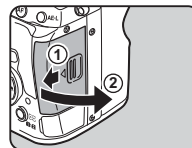

- 3 Insert the card all the way into the memory card slot with the memory card label facing toward the monitor.

Insert the card in the SD2 slot to use an Eye-Fi card or a Flucard.

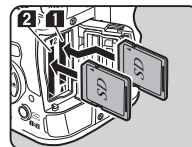

Push the memory card in once to remove.

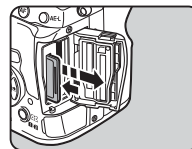

- 4** Close the card cover, and slide it in the direction of ④.

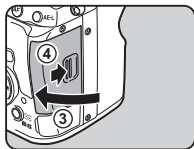

**⚠ Caution**

- Do not remove the memory card while the card access lamp is lit.
- If the card cover is opened while the power is on, the camera will turn off. Do not open the cover while the camera is in use.
- Use this camera to format (initialize) a memory card that is unused or has been previously used on other devices. (p.31)
- Use a high-speed memory card when recording movies. If a write speed cannot keep up with a recording speed, the writing may stop during recording.

**📄 Memo**

- For details on how the data is recorded when two memory cards are inserted, refer to “Memory Card Settings” (p.35).
- When using an Eye-Fi card or a Flucard, refer to “Using a Wireless Memory Card” (p.78).

## Initial Settings

Turn the camera on and make the initial settings

### Turning the Camera On

- 1** Turn the main switch to **[ON]**.

The first time the camera is turned on after purchasing, the [Language/言語] screen appears.

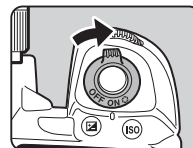

**📄 Memo**

- The power will automatically turn off when you do not perform any operations within a set period of time. (Default setting: 1min.) You can change the setting in [Auto Power Off] of the 3 menu.

### Setting the Display Language

- 1** Use **▲▼◀▶** to select the desired language and press **OK**.

The [Initial Setting] screen appears in the selected language.

Proceed to Step 6 if **🏠** (Hometown) does not need to be changed.

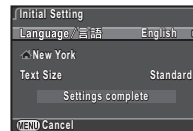

- 2** Press **▼** to move the frame to **🏠** and press **▶**.  
The [**🏠** Hometown] screen appears.

- 3 Use ◀▶ to select a city.**  
Use  to change the region. Refer to “List of World Time Cities” (p.94) for cities that can be selected as a hometown.

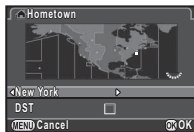

- 4 Press ▼ to select [DST] (daylight saving time), and use ◀▶ to select  or .**

- 5 Press OK.**  
The camera returns to the [Initial Setting] screen.

- 6 Press ▼ to select [Text Size] and press ▶.**

- 7 Use ▲▼ to select [Standard] or [Large], and press OK.**

Selecting [Large] increases the text size of the selected menu items.

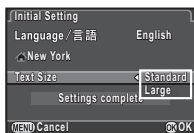

- 8 Press ▼ to select [Settings complete] and press OK.**

The [Date Adjustment] screen appears.



## Setting the Date and Time

- 1 Press ▶, and use ▲▼ to select the date format.**

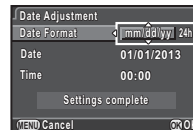

- 2 Press ▶, and use ▲▼ to select 24h or 12h.**

- 3 Press OK.**  
The frame returns to [Date Format].

- 4 Press ▼, and then press ▶.**  
The frame moves to the month if the date format is set to [mm/dd/yy].

- 5 Use ▲▼ to set the month.**  
Set the day, year and time in the same manner.

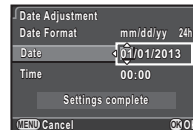

- 6 Press ▼ to select [Settings complete] and press OK.**

The camera switches to capture mode and is ready to take a picture.

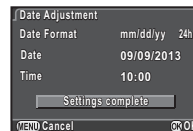



### Memo

- You can change the language, text size, and date and time settings from the  1 menu. (p.22)



## Formatting a Memory Card



- 1 Press **MENU**.**  
The **1** menu appears.
- 2 Use  or  to display **4** menu.**
- 3 Use **▲▼** to select [Format] and press **▶**.**  
The [Format] screen appears.
- 4 Use **▲▼** to select the memory card slot in which the memory card to format is inserted and press **▶**.**

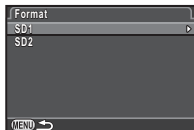

- 5 Press **▲** to select [Format] and press **OK**.**  
Formatting starts. When formatting is completed, the **4** menu reappears.

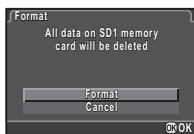

### **Caution**

- Do not remove the memory card while formatting, or the card may be damaged.
- Formatting deletes all data, both protected and unprotected.

### **Memo**

- When a memory card is formatted, the volume label assigned to the card is "K-3". When this camera is connected to a computer, the memory card is recognized as a removable disk with the name "K-3".

## Basic Shooting Operation

Take pictures in **1** mode in which the camera automatically sets the optimal exposure.

- 1 Remove the front lens cap by pushing the top and bottom portions as indicated in the illustration.**

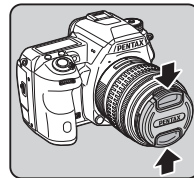

- 2 Turn the camera on.**
- 3 Turn the Stills/Movie switch to .**

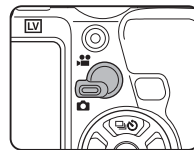

- 4 Set the focus mode switch to **AF**.**

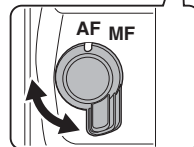
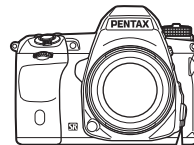
**2****Getting Started**

- 5** Set the mode dial to **■** while pressing the mode dial lock button.

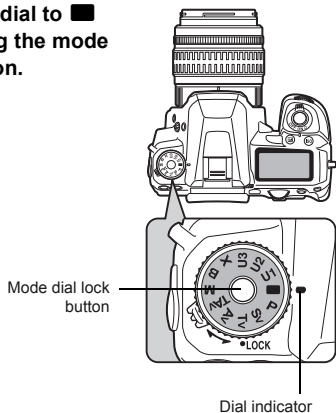

The selected exposure mode is displayed on the monitor (Guide Display).

- Guide Display settings (p.22)



- 6** Look through the viewfinder to view the subject.

When using a zoom lens, turn the zoom ring to the right or left to change the angle of view.

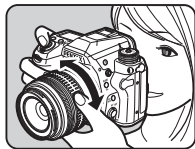

- 7** Position the subject inside the AF frame and press the shutter release button halfway.

● appears and you will hear a beep when the subject comes into focus.



Focus indicator

- Setting the Sound Effects (p.22)

- 8** Press the shutter release button fully.

The captured image is displayed on the monitor (Instant Review).

#### Available operations during Instant Review

- |  |                      |
|--|----------------------|
|  | Deletes the image.   |
|  | Magnifies the image. |
|  | Saves the RAW image. |

#### Easy operation of the mode dial

Release the mode dial lock using the mode dial lock release lever to easily operate the mode dial without having to press the mode dial lock button.

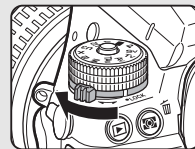

## Shooting with Live View

### 1 Press **[LV]** in Step 6 on p.32.

The Live View image is displayed on the monitor.

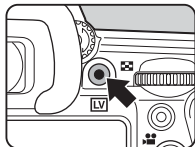





### 2 Position the subject inside the AF frame on the monitor and press the shutter release button halfway.

The AF frame turns green and you will hear a beep when the subject comes into focus.



AF frame

#### Available operations during Live View

- 
- [OK]** Magnifies the image.  
Use  to change the magnification (up to 10x).  
Use   to change the display area.  
Press  to return the display area to the center.  
Press **[OK]** to return to the actual size.

- 
- [LV]** Exits the Live View shooting.
- 

Subsequent steps are the same as shooting with the viewfinder.

#### Memo

- You can use **[AF]** to focus on the subject. (p.42)
- You can preview the image on the monitor and check the depth of field before shooting. (p.46)
- You can set the operation and display settings during Instant Review in [Instant Review] of the **[4]** menu (p.19). When [Display Time] is set to [Hold], Instant Review will be displayed until the next operation.

#### Caution

- Some functions are not available in  mode. If you attempt to use the functions that are not available, such as the direct key operation, the message [This function is not available in the current mode] appears.

## Reviewing Images

Review the captured image on the monitor.

1 Press .

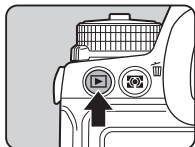













The camera enters playback mode and the most recently captured image is displayed (single image display).



2 Review the captured image.

### Available operations

|  |   |
|--|---|
|  to the left  | Displays the previous image.  |
|  to the right | Displays the next image.  |
|               | Deletes the image.  |
|  to the right | Magnifies the image (up to 16×).<br>Use     to change the display area.<br>Press  to return the display area to the center.<br>Press  to return the display area to the entire image. |
|  to the left  | Switches to the thumbnail display (p.60).   |
|               | Switches between the SD1 card and SD2 card.   |
|               | Saves the RAW image (only when the data is available).  |

INFO

Changes the type of information displayed (p.12).

### Memo

- When  is displayed on the monitor, the JPEG image that was just taken can also be saved in RAW format (Save RAW Data).

# Configuring the Capture Settings

## Memory Card Settings



The recording method for when two memory cards are inserted can be set in [Memory Card Options] of the 1 menu or the control panel.

|                          |  |
|--------------------------|--|
| <b>Sequential Use</b>    | When the memory card in SD1 slot becomes full, data is saved to the card in SD2. |
| <b>Save to Both</b>      | Saves the same data to the memory cards in SD1 and SD2.                          |
| <b>Separate RAW/JPEG</b> | Saves the RAW data to the memory card in SD1, and JPEG data to the card in SD2.  |

### Memo

- When in mode, data is saved to the card in either SD1 or SD2. Set in [Memory Card Options] of the 1 menu.

## Image Capture Settings



Set the file format for still pictures in [Image Capture Settings] of the 1 menu or from the control panel.

|                             |   |
|-----------------------------|---|
| <b>File Format</b>          | JPEG (default setting), RAW, RAW+   |
| <b>JPEG Recorded Pixels</b> | <input type="checkbox"/> (default setting), <input type="checkbox"/> M, <input type="checkbox"/> S, <input type="checkbox"/> XS |
| <b>JPEG Quality</b>         | ★★★ (default setting), ★★, ★  |
| <b>RAW File Format</b>      | PEF (default setting), DNG  |

### Caution

- When [Memory Card Options] is set to [Separate RAW/JPEG], [File Format] is fixed to [RAW+].

### Memo

- When [File Format] is set to [RAW+], a JPEG image and a RAW image with the same file number are saved at the same time.
- You can take pictures with a different file format setting only when is pressed. (p.72)
- [PEF] of [RAW File Format] is a PENTAX original RAW file format.

## Movie Capture Settings



Set the file format for movies in [Movie Capture Settings] of the 1 menu or from the control panel.

| Recorded Pixels   | Framerate                                 |
|-------------------|---|
| (default setting) | 60i, 50i, 30p (default setting), 25p, 24p |
|                   | 60p, 50p, 30p, 25p, 24p                   |

# Taking Still Pictures

Select the exposure mode that suits the subject and shooting conditions.

The following exposure modes are available on this camera.

✓: Available #: Restricted ✕: Not available

| Mode   | Change Shutter Speed | Change Aperture Value | Change Sensitivity | EV Compensation |
|--|----------------------|-----------------------|--------------------|-----------------|
| <b>P</b><br>Program Automatic Exposure                       | # *1                 | # *1                  | ✓                  | ✓               |
| <b>Sv</b><br>Sensitivity Priority Automatic Exposure         | ✕                    | ✕                     | ✓ *2               | ✓               |
| <b>Tv</b><br>Shutter Priority Automatic Exposure             | ✓                    | ✕                     | ✓                  | ✓               |
| <b>Av</b><br>Aperture Priority Automatic Exposure            | ✕                    | ✓                     | ✓                  | ✓               |
| <b>TAv</b><br>Shutter & Aperture Priority Automatic Exposure | ✓                    | ✓                     | ✓ *3               | ✓               |
| <b>M</b><br>Manual Exposure                                  | ✓                    | ✓                     | ✓ *2               | ✓               |
| <b>B</b><br>Bulb Exposure                                    | ✕                    | ✓                     | ✓ *2               | ✕               |
| <b>X</b><br>Flash X-sync Speed                               | ✕ *4                 | ✓                     | ✓ *2               | ✓               |



\*1 You can set the value to be changed in [E-Dial Programming] of the 4 menu. (p.71)

\*2 [ISO AUTO] is not available.

\*3 Fixed to [ISO AUTO].

\*4 Fixed to 1/180 seconds.

## 1 Turn the mode dial to select the desired exposure mode.

 or  appears on the status screen for the value that can be changed.

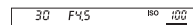

The value that can be changed is underlined in the viewfinder.

▶ appears on the LCD panel for the value that can be changed.

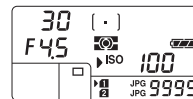

During Live View, ▶ appears for the value that can be changed.



## 2 Turn .

The aperture value is changed in **Av**, **TAv**, **M**, **B**, or **X** mode.

The sensitivity is changed in **Sv** mode.

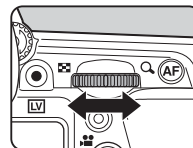

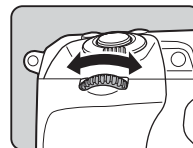

## 3 Turn .

The shutter speed is changed in **Tv**, **TAv**, or **M** mode.









## Memo

- The settings for exposure can be specified in increments of 1/3 EV steps. In [1. EV Steps] of the **C1** menu, you can change the adjustment steps to 1/2 EV steps.
- A proper exposure may not be obtained with the selected shutter speed and aperture value when the sensitivity is set to the fixed value.
- In **M** or **X** mode, the difference from the proper exposure is displayed in the EV bar scale while the exposure is adjusted.
- In **B** mode, the drive mode cannot be set to Continuous Shooting, Exposure Bracketing, Multi-exposure+Continuous, Interval Shooting, or Interval Composite.
- For each exposure mode, you can set the camera operation for when  or  is turned or **O** is pressed. Set in [E-Dial Programming] of the **4** menu. (p.71)

## Program Line

In [Program Line] of the **2** menu, you can specify how exposure is controlled when [**PLINE**] is selected for the **O** button operation.

|   |  |
|---|--|
|  <b>Auto</b>                   | The camera determines the appropriate settings.  |
|  <b>Normal</b>                 | Basic Program Automatic Exposure (default setting)   |
|  <b>Hi-speed priority</b>      | Prioritizes high shutter speeds.   |
|  <b>DOF priority (deep)</b>    | Closes the aperture for a deep depth of field.   |
|  <b>DOF priority (shallow)</b> | Opens the aperture for a shallow depth of field.   |
|  <b>MTF priority</b>           | Prioritizes the best aperture setting of the attached lens when a DA, DA L, D FA, FA J or FA lens is used. |

## EV Compensation

The compensation value can be set between -5 and +5 EV (-2 and +2 EV in  mode).

### 1 Press , and then turn .

 and the compensation value are displayed on the status screen, Live View screen, LCD panel and in the viewfinder during adjustment.

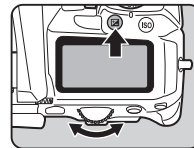

### Available operations

-  Starts/ends adjusting the compensation value.
- O** Resets the adjustment value to the default setting.

## Memo

- Exposure Bracketing shooting enables you to take pictures while automatically changing exposure. (p.49)

## Recording Movies

### 1 Turn the Stills/Movie switch to .

Live View is displayed.

Sound



Recordable Time

### 2 Focus on the subject.

In **AF** mode, press the shutter release button halfway.

### 3 Press .

Movie recording starts.

In the upper left area of the monitor, "REC" blinks and the size of the file being recorded is displayed.

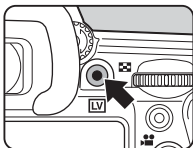

### 4 Press again.

Movie recording stops.

### Caution

- When recording a movie with sound, the camera operation sounds are also recorded.
- When recording a movie with an image processing function such as Digital Filter applied, the movie file may be saved with some frames omitted.
- If the internal temperature of the camera becomes high during recording, the recording may be terminated.

### Memo

- Recording can be started or stopped by pressing the shutter release button fully.
- You can change the movie settings in the  1 menu or from the control panel. (p.21) When [Exposure Setting] is set to **Av**, **TAv** or **M**, you can set the exposure before shooting.
- When [Recording Sound Level] is set to [MANUAL], a bar graph indicating the microphone volume level appears on the left edge (both edges when a stereo microphone is connected) of the monitor.
- You can record a movie continuously up to 4 GB or 25 minutes. When the memory card is full, recording stops.

### Using a Microphone or Headphones

You can record stereo sound by connecting a commercially available stereo microphone to the microphone terminal on the camera. Using an external microphone can also help to reduce the possibility of recording camera operation sounds.

The following specifications are recommended for external microphones.

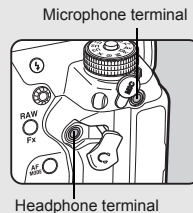

|                  |  |
|------------------|--|
| <b>Plug</b>      | Stereo mini plug (ø3.5 mm)                                 |
| <b>Format</b>    | Stereo electret condenser                                  |
| <b>Power</b>     | Plug-in Power Method (operating voltage of 2.0 V or lower) |
| <b>Impedance</b> | 2.2 kΩ   |

If the external microphone is disconnected during recording, no sound will be recorded.

You can record and play back movies while listening to the sound by connecting commercially available headphones to the headphone terminal.



## Playing Back Movies



### Available operations

|                  |   |
|------------------|---|
| ▲                | Plays back/pauses a movie.                              |
| ▶                | Forwards a frame (when paused).                         |
| Press and hold ▶ | Fast-forwards playback.                                 |
| ◀                | Reverses a frame (when paused).                         |
| Press and hold ◀ | Fast-reverses playback.                                 |
| ▼                | Stops playback.   |
|                  | Adjusts the volume (21 levels).                         |
| <b>AE-L</b>      | Saves the displayed frame as a JPEG file (when paused). |

### Memo

- In [Movie Edit] of the playback mode palette, movies can be divided or selected frames can be deleted. (p.68)

## Setting the Exposure

### Sensitivity

#### 1 Press **ISO**, and then turn

The sensitivity displayed on the status screen, Live View screen, LCD panel and in the viewfinder changes.

Press to set the sensitivity to [ISO AUTO].

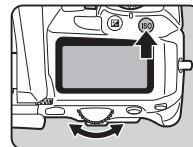

#### Memo

- The adjustment steps for ISO sensitivity is 1 EV step. To adjust the sensitivity in accordance with the EV step setting for exposure, set from [2.Sensitivity Steps] of the **C1** menu.

### Setting the Range of ISO AUTO



You can set the range in which the sensitivity is automatically adjusted when the sensitivity is set to ISO AUTO. Set in [ISO AUTO Setting] of the **C2** menu. (Default setting: ISO 100 to ISO 3200)



The manner in which the sensitivity is increased can be specified in [AUTO ISO Parameters].

|                                     |                 |  |
|-------------------------------------|-----------------|--|
|                                     | <b>Slow</b>     | Increases the sensitivity as little as possible. |
| <input checked="" type="checkbox"/> | <b>Standard</b> | (Default setting)                                |
|                                     | <b>Fast</b>     | Actively increases the sensitivity.              |

#### Caution

- When [HDR Capture] is set and [Auto Align] is set to on, [AUTO ISO Parameters] is fixed to .

## Noise Reduction when Shooting with a High ISO Sensitivity



You can set the Noise Reduction setting when shooting with a high ISO sensitivity in [High-ISO NR] of the menu.

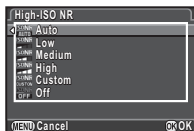

|                                  |  |
|----------------------------------|--|
| <b>Auto</b>                      | Applies Noise Reduction at optimally calculated levels throughout ISO range. (Default setting) |
| <b>Low/<br/>Medium/<br/>High</b> | Applies Noise Reduction at constant chosen level throughout ISO range.                         |
| <b>Custom</b>                    | Applies Noise Reduction at user-defined levels for each ISO setting.                           |
| <b>Off</b>                       | Does not apply Noise Reduction at any ISO setting.   |

When [Custom] is selected, select [Setting] and set the noise reduction level according to the ISO sensitivity.

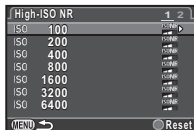

## AE Metering

Choose the part of the sensor to use for measuring brightness and determining exposure.

1 Turn while pressing .

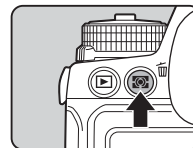

|                        |   |
|------------------------|---|
| <b>Multi-segment</b>   | The sensor meters the brightness in multiple different zones. (Default setting)<br>In backlit locations, this mode automatically adjusts exposure.                |
| <b>Center-weighted</b> | Metering is weighted at the center of the sensor.<br>The sensitivity increases at the center and no automatic adjustment is performed even during backlit scenes. |
| <b>Spot</b>            | The brightness is measured only within a limited area at the center of the sensor.<br>Useful when the subject is small.   |

### Memo

- In [5. Link AE and AF Point] of the **C1** menu, you can set the camera to adjust the exposure automatically according to the position of the focusing point.

# Using the Built-in Flash



1 Press **▼** in standby mode.

2 Select a flash mode.



|                                     |  |
|-------------------------------------|--|
| <b>Auto Flash Discharge</b>         | Automatically measures the ambient light and determines whether to use the flash.  |
| <b>Auto Flash+Red-eye Reduction</b> | Discharges a pre-flash for red-eye reduction before an automatic flash.  |
| <b>Flash On</b>                     | Discharges a flash for each picture.   |
| <b>Flash On+Red-eye Reduction</b>   | Discharges a pre-flash for red-eye reduction before the main flash.  |
| <b>Slow-speed Sync</b>              | Sets to a slow shutter speed. Use this when shooting a portrait with the sunset in the background.   |
| <b>Slow-speed Sync+Red-eye</b>      | Discharges a pre-flash for red-eye reduction before the main flash is discharged with Slow-speed Sync.   |
| <b>Trailing Curtain Sync</b>        | Discharges a flash immediately before closing the shutter. Sets to a slow shutter speed. Captures moving objects as if they are leaving a light trail behind them. |
| <b>Manual Flash Discharge</b>       | Sets the amount of flash discharge between FULL and 1/128.   |
| <b>Wireless</b>                     | Synchronizes the dedicated external flash without using a sync cord. (p.83) Select [Wireless (Master)] or [Wireless (Controller)].                                 |

3 To compensate the flash output or when is selected, press **▼** and then use to adjust the value.

Press **○** to reset the value to 0.0. For [Wireless], first press **▼**, then use to select or .



4 Press **OK**.

The camera returns to standby mode.

5 Press .

The built-in flash is popped up.

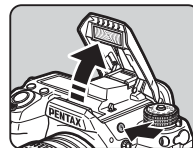

## Memo

- The flash modes that can be selected vary depending on the exposure mode.

| Exposure Modes        | Selectable Flash Mode      |
|-----------------------|----------------------------|
|                       | ,  (No flash compensation) |
| <b>P, Sv, Av</b>      | , , , , , ,                |
| <b>Tv, TvAv, M, B</b> | , , , , ,                  |
| <b>X</b>              | , , , ,                    |

- You cannot take pictures while the flash is being charged. If you want to take pictures while the flash is being charged, set [20. Release While Charging] in the **C3** menu.
- Depending on the lens being used, the use of the built-in flash may be limited. (p.82)
- When the built-in flash is used in **Av** mode, the shutter speed automatically changes over a range from 1/180 seconds to a slow shutter speed depending on the lens being used. The shutter speed is locked at 1/180 seconds when a lens other than a DA, DA L, D FA, FA J, FA or F lens is used.

- When the built-in flash is used in **Tv**, **TAv** or **M** mode, any desired shutter speed of 1/180 seconds or slower can be set.
- The built-in flash is optimum for a subject at a distance from approx. 0.7 m to 5 m. Vignetting may occur when used at a distance closer than 0.7 m (this distance varies slightly depending on the lens being used and the sensitivity setting).

| Sensitivity | Guide Number | Sensitivity | Guide Number |
|-------------|--------------|-------------|--------------|
| ISO 100     | Approx. 13   | ISO 3200    | Approx. 73.5 |
| ISO 200     | Approx. 18.4 | ISO 6400    | Approx. 104  |
| ISO 400     | Approx. 26   | ISO 12800   | Approx. 147  |
| ISO 800     | Approx. 36.8 | ISO 25600   | Approx. 208  |
| ISO 1600    | Approx. 52   | ISO 51200   | Approx. 294  |

- For details on using an external flash, refer to “Functions when Using an External Flash” (p.84).

## Setting the Focus Method

Set the focus mode switch to **AF** or **MF**.

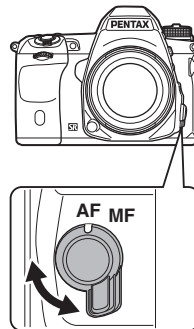

The autofocus methods for shooting with the viewfinder differ from those for shooting with Live View.

|                                     |   |
|-------------------------------------|---|
| <b>Shooting with the viewfinder</b> | TTL phase-matching autofocus<br>Select from <b>A.F.S.</b> , <b>A.F.C.</b> , or <b>A.F.A.</b> mode which enables automatically switching between <b>A.F.S.</b> and <b>A.F.C.</b><br>Set the focusing point in [AF Point]. (p.44)<br>Faster autofocus performance than “contrast detection AF” is possible. |
| <b>Shooting with Live View</b>      | Contrast detection AF<br>Face Detection and Tracking are available. (p.44)  |

### Memo

- You can use **AF** to focus on the subject. The **AF** button operation can be set in [Button Customization] of the 4 menu. (p.71)

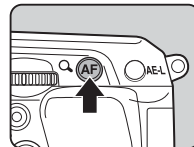

## Setting the AF Mode when Shooting with the Viewfinder



### 1 Turn while pressing

**AF MODE**

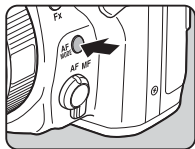

|                                  |  |
|----------------------------------|--|
| <b>AF.S<br/>Single mode</b>      | When the shutter release button is pressed halfway and the subject comes into focus, the focus is locked at that position. (Default setting)<br>The AF assist light turns on as necessary.   |
| <b>AF.C<br/>Continuous mode</b>  | The subject is kept in focus by continuous adjustment while the shutter release button is pressed halfway.<br>● appears in the viewfinder when the subject comes into focus.<br>The shutter can be released even if the subject is not in focus. |
| <b>AF.A<br/>Auto-select mode</b> | Switches automatically between <b>AF.S</b> and <b>AF.C</b> modes according to the subject.   |

### Memo

- The following settings pertaining to AF operations can be set in the **C3** menu.

|                                      |  |
|--------------------------------------|--|
| <b>15. AF.S Setting</b>              | Focus-priority (default setting), Release-priority       |
| <b>16. 1st Frame Action in AF.C</b>  | Release-priority (default setting), Auto, Focus-priority |
| <b>17. Action in AF.C Continuous</b> | Focus-priority (default setting), Auto, FPS-priority     |
| <b>18. Hold AF Status</b>            | Off (default setting), Low, Medium, High                 |

- In [18. Hold AF Status], you can set whether to immediately reactivate AF or to maintain the focus for a certain amount of time before activating AF when the subject happens to move out of the selected focusing area after being focused. The default setting is to immediately activate AF when focusing is unsuccessful.

## Selecting the Focusing Area (AF Point)



### 1 Turn while pressing .

|                             |   |
|-----------------------------|---|
| <b>Auto (27 AF Points)</b>  | Out of the 27 AF points, the camera automatically selects the optimum focusing point. (Default setting)   |
| <b>Zone Select</b>          | Out of the selected 9 AF points, the camera automatically selects the optimum focusing point.   |
| <b>Select</b>               | Sets the focusing point to the user selected point from 27 points.  |
| <b>Expanded Area AF (S)</b> | Sets the focusing point to the user selected point from 27 points. When the subject happens to move out of the selected focusing area after being focused, 8 peripheral points are used as back-up points. Not available in <b>AFS</b> mode.  |
| <b>Expanded Area AF (M)</b> | Sets the focusing point to the user selected point from 27 points. When the subject happens to move out of the selected focusing area after being focused, 24 peripheral points are used as back-up points. Not available in <b>AFS</b> mode. |
| <b>Expanded Area AF (L)</b> | Sets the focusing point to the user selected point from 27 points. When the subject happens to move out of the selected focusing area after being focused, 26 peripheral points are used as back-up points. Not available in <b>AFS</b> mode. |
| <b>Spot</b>                 | Sets the focusing point to the center of the 27 points.   |

Proceed to Step 2 when a mode other than or is selected.

### 2 Select the desired AF point.

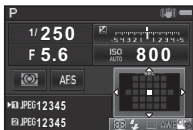

## Available operations

|  |  |
|--|--|
|  | Changes the AF point.  |
|  | Returns the AF point to the center.  |
|  | Switches the function of  to that for Change AF Point or the direct key operation. |

## Setting the AF Mode during Live View



You can select an autofocus mode when shooting with Live View in [Live View] of the menu, or in [Contrast AF] of the control panel. The autofocus mode can also be changed by turning while pressing during Live View.

|                           |  |
|---------------------------|--|
| <b>Face Detection</b>     | Detects and tracks faces of people. (Default setting)<br>The main face detection frame for AF and AE is displayed in yellow.   |
| <b>Tracking</b>           | Tracks the subject in focus. The shutter can be released even if the subject is not in focus.  |
| <b>Multiple AF Points</b> | Sets the focusing area to the desired area. The sensor is divided into 45 areas (9 horizontal by 5 vertical), and you can select a wider or narrower focusing area by using 1, 9, 15, or 21 of those 45 available areas. |
| <b>Select</b>             | Sets the focusing area by the number of pixels.  |
| <b>Spot</b>               | Sets the focusing area to a limited area at the center.  |

### Caution

- When is selected, the focus lock operation (composition adjustment with the half press of the shutter release button) does not work.

## Selecting the Desired Focusing Area

You can set the position and range of the autofocus area (AF area).

**1** Set [AF Mode] to  or .





**2** Press .

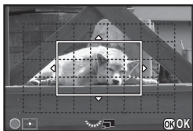

**3** Select the AF area.

Use the frame that appears on the monitor to change the position and size of the AF area.



### Available operations

    Changes the position of the AF area.

 Increases/reduces the size of the AF area (when  is selected).

 Returns the AF area to the center.

**4** Press .

The AF area is set.

### Memo

- When [Focus Peaking] is set to [ON] in [Live View] of the  3 menu, the outline of the subject in focus is emphasized and makes it easier to check the focus. This function works in both **AF** and **MF** modes.

## AF Fine Adjustment

C4

You can precisely fine tune your lenses with the camera's autofocus system.

**1** Select [26. AF Fine Adjustment] in C4 menu and press .

The [26. AF Fine Adjustment] screen appears.



**2** Select [Apply All] or [Apply One] and press .

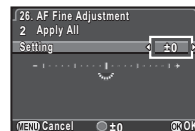

|           |  |
|-----------|--|
| Apply All | Applies the same adjustment value to all lenses.                     |
| Apply One | Saves an adjustment value for the lens being used. (Up to 20 values) |

**3** Select [Setting] and adjust the value.



### Available operations

  to the right Adjusts the focus to a closer position.

  to the left Adjusts the focus to a farther position.

 Resets the adjustment value to the default setting.

**4** Press .

The adjustment value is saved.

**5** Press  twice.

The camera returns to standby mode.

### Memo

- Check focus accuracy by magnifying the image during Live View (p.33) or Digital Preview (p.46).

3

Shooting

## Checking the Depth of Field (Preview)

Turn the main switch to to use the preview function.

There are two preview methods.

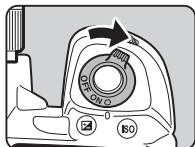

|                        |   |
|------------------------|---|
| <b>Optical Preview</b> | For checking the depth of field with the viewfinder. (Default setting)  |
| <b>Digital Preview</b> | For checking the composition, exposure and focus on the monitor. (The maximum display time: 60 seconds)<br>You can magnify the image or save the preview image. |

### Setting the Preview Method



- 1 Select [Button Customization] in 4 menu and press .**  
The [Button Customization] screen appears.
- 2 Select [Preview Dial] and press .**  
The [Preview Dial] screen appears.
- 3 Select [Optical Preview] or [Digital Preview] and press .**
- 4 Press three times.**  
The camera returns to standby mode.

### Memo

- Optical Preview is always used when the drive mode is set to [Mirror Lock-up Shooting], [Multi-exposure], [Interval Shooting] or [Interval Composite], or when ASTROTRACER is activated.
- The display settings and camera operation during Digital Preview can be changed in [Digital Preview] of the 4 menu. (p.20)
- The preview function can also be assigned to . (p.71)  
You can easily switch between Optical Preview and Digital Preview after assigning different kinds of preview methods to the two controls, of the main switch and .



## Setting the Drive Mode



You can choose from the following drive modes.

|  |   |
|--|---|
| <b>Single Frame Shooting</b> (□)           | Normal capture mode   |
| <b>Continuous Shooting</b> (📷/📷/📷)         | Continuously takes pictures while the shutter release button is kept pressed. The number of pictures that can be taken continuously varies according to the shutter speed.  |
| <b>Self-timer</b> (🕒/🕒)                    | Releases the shutter about 12 seconds or 2 seconds after the shutter release button is pressed.   |
| <b>Remote Control</b> (📷/📷/📷)              | Enables shooting with remote control. Select from [Remote Control], [Remote Control (3 sec. delay)] or [Remote Continuous Shooting].  |
| <b>Exposure Bracketing</b> (📷/📷/📷)         | Takes consecutive images at different exposure levels. Select from [Exposure Bracketing], [Self-timer+Exposure Bracketing] or [Exposure Bracket+Remote Ctrl].   |
| <b>Mirror Lock-up Shooting (MUP)</b> (📷/📷) | Takes images with the mirror raised. Select from [Mirror Lock-up Shooting] or [Remote Control+Mirror Lock-up].  |
| <b>Multi-exposure</b> (📷/📷/📷)              | Creates a composite picture by taking multiple exposures and merging them into a single image. Select from [Multi-exposure], [Multi-exposure+Continuous], [Self-timer+Multi-exposure] or [Remote Control+Multi-exposure]. |
| <b>Interval Shooting</b> (🕒)               | Takes pictures at a set interval from a set time.   |

### Interval Composite (🕒)

Takes still pictures at a set interval and merges them into a single image. Star and moon trails can be captured in one image.

### Interval Movie Record (🕒)

Takes still pictures at a set interval from a set time and saves them as a single movie file. Available only in 📷 mode.

### ⚠ Caution

- There are restrictions on some drive modes when used in combination with some other functions. (p.80)

### 📌 Memo

- Only 📷, 📷 or 📷 can be selected in 📷 mode.
- The Drive Mode setting is saved even after the power is turned off. If [Drive Mode] is set to [Off] in [Memory] of the 📷 4 menu, the setting returns to Single Frame Shooting when the power is turned off. (p.75)
- The Shake Reduction function is automatically turned off when Self-timer, Remote Control, or Mirror Lock-up Shooting is selected.
- When the drive mode that employs the self-timer or remote control is selected, the exposure may be affected if light enters the viewfinder. In such a case, use the AE Lock function or attach the optional ME viewfinder cap.

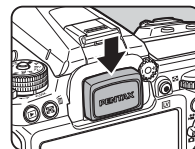





Remove the eyecup before attaching the ME viewfinder cap.

## Continuous Shooting

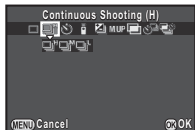
- 1 Press **▲** in standby mode.  
The Drive Mode screen appears.

- 2 Select  and press **▼**.



- 3 Select , , or  and press **OK**.  
The camera returns to standby mode.

### ⚠ Caution

- You cannot take pictures while the flash is being charged. If you want to take pictures while the flash is being charged, set [20. Release While Charging] in the **C3** menu.

### 📌 Memo



- In **A.F.S** mode, the focus position is locked in the first frame.

## Self-timer

- 1 Press **▲** in standby mode.  
The Drive Mode screen appears.

- 2 Select  and press **▼**.



- 3 Select  or  and press **OK**.  
The camera returns to standby mode.

- 4 Press the shutter release button halfway, then fully.

The self-timer lamp blinks.

The shutter will be released about 12 seconds or 2 seconds.

## Remote Control

- 1 Press **▲** in standby mode.  
The Drive Mode screen appears.

- 2 Select **⏏** and press **▼**.



- 3 Select **⏏**, **⏏**, or **⏏** and press **OK**.  
The camera returns to standby mode.  
The self-timer lamp blinks.

- 4 Press the shutter release button halfway.

- 5 Point the remote control unit towards the remote control receiver on the front or back of the camera, and press the shutter release button on the remote control unit.

### ● Memo

- The maximum operating distance of the remote control unit is approx. 4 m from the front of the camera and approx. 2 m from the back of the camera.
- To adjust focus with remote control, set in [19. AF with Remote Control] of the **C3** menu.
- When using the Remote Control Waterproof O-RC1, the autofocus system can be operated with the  $\frac{1}{4}$  button. The **Fn** button cannot be used.

## Exposure Bracketing

- 1 Press **▲** in standby mode.  
The Drive Mode screen appears.

- 2 Select **⏏** and press **▼**.

- 3 Select **⏏**, **⏏**, or **⏏** and press **▼**.

- 4 Use **☀** to select the number of shots.  
Select from 2 images (Standard/+), 2 images (Standard/-), 3 images or 5 images.

- 5 Set the bracket value.



### Available operations

|  |   |
|--|---|
|  | Changes the bracket value (up to $\pm 2$ EV).       |
|  | Adjusts the exposure compensation value.            |
|  | Resets the adjustment value to the default setting. |

- 6 Press **OK**.  
The camera returns to standby mode.

### ● Memo

- You can set the bracketing order in [8. Bracketing Order] of the **C2** menu.
- The bracket value can be set in increments of 1/3 EV steps or 1/2 EV steps according to the [1. EV Steps] setting made in the **C1** menu.
- Set [9. One-Push Bracketing] to [On] in the **C2** menu to shoot the specified number of images with one press of the shutter release button.

## Mirror Lock-up Shooting

- 1 Press **▲** in standby mode.  
The Drive Mode screen appears.
- 2 Select **MUP** and press **▼**.



- 3 Select **MUP** or **MUP** and press **OK**.  
The camera returns to standby mode.
- 4 Press the shutter release button halfway, then fully.  
The mirror pops up and the AE Lock function is activated.
- 5 Press the shutter release button fully again.  
The mirror returns to its original position after the image is taken.

### Memo

- The mirror automatically returns to its original position if 1 minute elapses after the mirror pops up.

### Caution

- Mirror Lock-up Shooting cannot be selected when shooting with Live View.

## Multi-exposure

- 1 Press **▲** in standby mode.  
The Drive Mode screen appears.
- 2 Select **☰** and press **▼**.
- 3 Select **☰**, **☰**, **☰** or **☰**, and press **▼**.
- 4 Select **[Composite Mode]**.

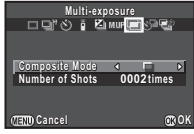

|  |                 |   |
|--|-----------------|---|
|  | <b>Average</b>  | Creates a composite image with the average exposure.            |
|  | <b>Additive</b> | Creates a composite image with the cumulatively added exposure. |
|  | <b>Bright</b>   | Creates a composite image that combines only bright parts.      |

- 5 Specify **[Number of Shots]**.  
Select from 2 to 2000 shots.
- 6 Press **OK**.  
The camera returns to standby mode.
- 7 Shoot.  
Instant Review is displayed.

### Available operations during Instant Review

|  |   |
|--|---|
|  | Discards pictures taken up to that point and takes pictures again from the first picture. |
|  | Saves pictures taken up to that point and displays the <b>☰</b> menu.                     |

After the set number of pictures are taken, the camera returns to normal capture mode.

## Interval Shooting

- 1 Press **▲** in standby mode.  
The Drive Mode screen appears.
- 2 Select **Interval Shooting** and press **▼**.
- 3 Set the shooting conditions.

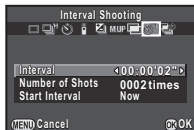

|                        |   |
|------------------------|---|
| <b>Interval</b>        | Select from 2 seconds to 24 hours.  |
| <b>Number of Shots</b> | Select from 2 to 2000 shots.  |
| <b>Start Interval</b>  | Select whether to take the first picture now or at a set time.<br>When [Set Time] is selected, set the time at which to start shooting in [Start Time]. |

- 4 Press **OK** to finish the setting.  
The camera returns to standby mode.
- 5 **Shoot.**

When [Start Interval] is set to [Now], the first picture is taken. When set to [Set Time], shooting starts at the set time.

To cancel shooting, press **MENU** in standby mode.  
After the set number of pictures are taken, the camera returns to normal capture mode.

### **Memo**

- A new folder is created when Interval Shooting is performed, and the captured images are saved there. When shooting in a different drive mode after performing Interval Shooting, a new folder will be created.
- The shortest interval time that can be set for [Interval] is 10 seconds for [Digital Filter] and 20 seconds for [HDR Capture].

## Interval Composite

- 1 Press **▲** in standby mode.  
The Drive Mode screen appears.
- 2 Select **Interval Composite** and press **▼**.
- 3 Set the shooting conditions.

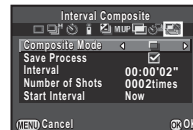

|                        |   |
|------------------------|---|
| <b>Composite Mode</b>  | Select from [Average], [Additive] or [Bright]. (Refer to “Multi-exposure” (p.50).)  |
| <b>Save Process</b>    | Select <input checked="" type="checkbox"/> to save images in the middle of processing.  |
| <b>Interval</b>        | Select from 2 seconds to 24 hours.  |
| <b>Number of Shots</b> | Select from 2 to 2000 shots.  |
| <b>Start Interval</b>  | Select whether to take the first picture now or at a set time.<br>When [Set Time] is selected, set the time at which to start shooting in [Start Time]. |





- 4 Press **OK** to finish the setting.  
The camera returns to standby mode.
- 5 **Shoot.**  
When [Start Interval] is set to [Now], the first picture is taken. When set to [Set Time], shooting starts at the set time.  
To cancel shooting, press **MENU** in standby mode.  
After the set number of pictures are taken, the camera returns to normal capture mode.

### **Memo**



- When [Save Process] is set to , a new folder is created and the composite image is saved there. When shooting in another different drive mode after performing Interval Composite, another new folder will be created.
- Mount the camera on a tripod during Interval Composite.

## Interval Movie Record

In  mode, you can use [Interval Movie Record] to take still pictures at a set interval from a set time and save them as a single movie file (Motion JPEG, file extension: .AVI).

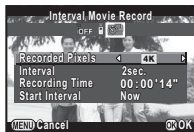
- 1 Turn the Stills/Movie switch to  and press . The Drive Mode screen appears.
- 2 Select  and press .
- 3 Set the shooting conditions.



|                        |  |
|------------------------|--|
| <b>Recorded Pixels</b> | Select from  ,  , or  . |
| <b>Interval</b>        | Select from 2 sec., 5 sec., 10 sec., 20 sec., 30 sec., 1 min., 5 min., 10 min., 30 min., or 1 hour.  |
| <b>Recording Time</b>  | Set the time from the start to the end of recording. Select from 14 seconds to 99 hours. The time that can be set varies depending on the [Interval] setting.  |
| <b>Start Interval</b>  | Select whether to take the first picture now or at a set time. When [Set Time] is selected, set the time at which to start shooting in [Start Time].   |

- 4 Press  to finish the setting. The camera returns to standby mode.
- 5 Press the shutter release button to start shooting. When [Start Interval] is set to [Now], the first picture is taken. Instant Review is displayed, and then the monitor turns off. After the set number of pictures are taken, the camera returns to standby mode.

### Memo











- The shortest interval time that can be set for [Interval] is 10 seconds for [Digital Filter] and 20 seconds for [HDR Capture].

## Setting the White Balance





- 1 Press  in standby mode. The White Balance setting screen appears.
- 2 Select the White Balance.



|   |                                      |
|---|--------------------------------------|
| <b>AWB</b>  | <b>AWB Auto White Balance</b>        |
|  | <b>Multi Auto White Balance</b>      |
|  | <b>Daylight</b>                      |
|  | <b>Shade</b>                         |
|  | <b>Cloudy</b>                        |
|  | <b>Fluorescent - Daylight Color</b>  |
|  | <b>Fluorescent - Daylight White</b>  |
|  | <b>Fluorescent - Cool White</b>      |
|  | <b>Fluorescent - Warm White</b>      |
|  | <b>Tungsten</b>                      |
|  | <b>Flash</b>                         |
| <b>CTE</b>  | <b>Color Temperature Enhancement</b> |
|  | <b>Manual White Balance 1 to 3</b>   |
| <b>K</b>  | <b>Color Temperature 1 to 3</b>      |

### Available operations when shooting with the viewfinder

|  |   |
|--|---|
| Main switch to  | Uses Digital Preview to preview the background image with the white balance effect applied. |
|                 | Saves the preview image (only when the data is available).                                  |

Proceed to Step 5 if you do not need to change the parameters.

### 3 Press **INFO**.

The fine-tuning screen appears.



#### Available operations

- |    |   |
|----|---|
| ▲▼ | Adjust: Green-Magenta                               |
| ◀▶ | Adjust: Blue-Amber                                  |
| ○  | Resets the adjustment value to the default setting. |

### 4 Press **OK**.

The screen of Step 2 reappears.

### 5 Press **OK**.

The camera returns to standby mode.

#### ● Memo

- When **WB** is set, even if various light sources are present at the shooting location, the camera automatically adjusts the white balance according to the light source of each area.
- The following settings pertaining to the white balance can be set in the **C2** menu.

|                             |  |
|-----------------------------|--|
| 10. WB Adjustable Range     | Fixed (default setting), Auto Adjustment   |
| 11. WB When Using Flash     | Auto White Balance (default setting), Multi Auto White Balance, Flash, Unchanged |
| 12. AWB in Tungsten Light   | Subtle Correction (default setting), Strong Correction                           |
| 13. Color Temperature Steps | Kelvin (default setting), Mired  |

## Adjusting the White Balance Manually

Measure the white balance of a given scene.

### 1 Select **WB** in Step 2 on p.52 and press ▼.

### 2 Select from **1** to **3**.



### 3 Under the light you wish to measure the white balance of, select a white area as the subject, and press the shutter release button fully.

The captured image is displayed.

[The operation could not be completed correctly] appears when measuring is unsuccessful. Press **OK** to remeasure the white balance.

### 4 Use ▲▼◀▶ to specify the measuring range.

### 5 Press **OK**.

The White Balance setting screen reappears.

#### ● Memo

- You can copy the white balance settings of a captured image and save them as **1** to **3** in [Save as Manual WB] of the playback mode palette. (p.59)

## Adjusting the White Balance with Color Temperature

Specify the white balance with the color temperature.

- 1 Select **K** in Step 2 on p.52, and press **▼**.
- 2 Select from **K1** to **K3**.
- 3 Press **INFO**.
- 4 Adjust the color temperature.

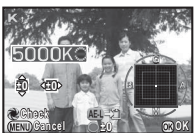

Set the color temperature value within the range from 2500K to 10000K.

### Available operations

|             |                                   |
|-------------|-----------------------------------|
|             | 100 Kelvin units                  |
|             | 1000 Kelvin units                 |
| <b>▲▼◀▶</b> | Fine-tunes the color temperature. |

- 5 Press **OK**.  
The White Balance setting screen reappears.

### Memo

- Select [Mired] in [13. Color Temperature Steps] of the **C2** menu to set the color temperature in mired units. The color temperature can be changed in 20 mired units with , and 100 mired units with . However, figures are converted to and displayed in Kelvin.

## Controlling the Image Finishing Touch

When you want to take pictures with a slightly different style, you can set the desired picture style before shooting. Try out the various settings, and find your best picture style.

### Custom Image

- 1 Press **▶** in standby mode.  
The Custom Image setting screen appears.

- 2 Select an image finishing touch.

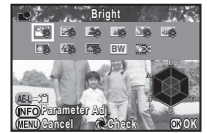

|                                 |                         |
|---------------------------------|-------------------------|
| <b>Bright</b> (default setting) | <b>Muted</b>            |
| <b>Natural</b>                  | <b>Bleach Bypass</b>    |
| <b>Portrait</b>                 | <b>Reversal Film</b>    |
| <b>Landscape</b>                | <b>Monochrome</b>       |
| <b>Vibrant</b>                  | <b>Cross Processing</b> |
| <b>Radiant</b>                  |                         |

### Available operations when shooting with the viewfinder

|                |   |
|----------------|---|
| Main switch to | Uses Digital Preview to preview the background image with the selected setting applied. |
| <b>AE-L</b>    | Saves the preview image (only when the data is available).                              |

Proceed to Step 6 if you do not need to change the parameters.



### 3 Press **INFO**.

The parameter setting screen appears.

### 4 Set the parameters.

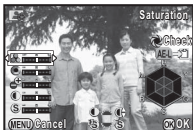

#### Available operations

|  |   |
|--|---|
|  | Selects a parameter.  |
|  | Adjusts the value.  |
|  | Switches between [Contrast], [Contrast Highlight Adjustment] and [Contrast Shadow Adjustment].  |
|  | Switches between [Sharpness], [Fine Sharpness] and [Extra Sharpness]. (Not available in  mode). |
|  | Resets the adjustment value to the default setting.   |

### 5 Press **OK**.

The screen of Step 2 reappears.

### 6 Press **OK**.

The camera returns to standby mode.

## Saving the Cross Processing Settings of a Captured Image

The outcome of Cross Processing varies each time a picture is taken. If you take a cross processed image that you like, you can save the Cross Processing settings used in that image so that you can repeatedly use the same settings.

### 1 Press in single image display of playback mode.

The playback mode palette appears.

### 2 Select and press **OK**.

The camera will search for cross processed images starting from the most recent image taken.

[No cross processed image] appears if there are no cross processed images.

### 3 Use to select a cross processed image.



### 4 Select a number and press **OK**.

The settings of the selected image are saved to Favorite 1 to 3.

#### Memo

- The saved Cross Processing settings can be loaded by selecting [Cross Processing] in Step 2 of "Custom Image" (p.54), and selecting [Favorite 1 - 3] for the parameter.

## Digital Filter



- 1** Select **[Digital Filter]** in **☰1** menu and press **▶**.  
The Digital Filter setting screen appears.

- 2** Select a filter.  
Select **[No Filter]** to not shoot with a digital filter.



|               |                 |
|---------------|-----------------|
| Extract Color | Shading         |
| Toy Camera    | Invert Color    |
| Retro         | Unicolor Bold   |
| High Contrast | Bold Monochrome |

#### Available operations when shooting with the viewfinder

Main switch to Uses Digital Preview to preview the background image with the filter effect applied.

**AE-L** Saves the preview image (only when the data is available).

Proceed to Step 6 if you do not need to change the parameters.

- 3** Press **INFO**.  
The parameter setting screen appears.

- 4** Set the parameters.



#### Available operations

**▲ ▼** Selects a parameter.

**◀ ▶** Adjusts the value.

- 5** Press **OK**.  
The screen of Step 2 reappears.

- 6** Press **OK**.

- 7** Press **MENU**.  
The camera returns to standby mode.

#### ⚠ Caution

- This function cannot be used in combination with some other functions. (p.80)
- Depending on the filter used, it may take longer to save images.

#### 📄 Memo

- Images can also be processed with digital filters in playback mode. (p.66)

# Correcting Images

## Brightness Adjustment

### Highlight Correction/ Shadow Correction



Expands the dynamic range and enables a wider range of tones by the CMOS sensor and reduces the occurrence of overexposed/underexposed areas.

Set the correction functions from [D-Range Settings] of the menu or the control panel.

#### Caution

- When the sensitivity is set to less than ISO 200, [Highlight Correction] cannot be set to [On].

### HDR Capture



Takes three consecutive images at three different exposure levels to create a single composite picture with them.

**1** Select [HDR Capture] in 1 menu and press **▶**.  
The [HDR Capture] screen appears.

**2** Select [HDR AUTO], [HDR 1], [HDR 2] or [HDR 3], and press **OK**.

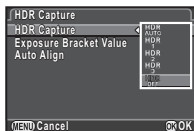

**3** Set the range in which to change the exposure in [Exposure Bracket Value].

Select from  $\pm 1$ ,  $\pm 2$  or  $\pm 3$ .

**4** Set whether to use Auto Align or not.

|                                     |                                    |
|-------------------------------------|------------------------------------|
| <input checked="" type="checkbox"/> | Uses Auto Align. (Default setting) |
| <input type="checkbox"/>            | Does not use Auto Align.           |

**5** Press **MENU** twice.

The camera returns to standby mode.

#### Caution

- HDR Capture is not available in **B** or **X** mode.
- This function cannot be used in combination with some other functions. (p.80)
- When the drive mode is set to [Interval Shooting], [Auto Align] is fixed to [Off].
- In mode, HDR Capture is available only when the drive mode is set to [Interval Movie Record].
- For HDR Capture, multiple images are combined together to create a single image, so it will take time to save the image.

### Lens Correction



The following features can be set from [Lens Correction] of the 1 menu or the control panel.

|                                  |   |
|----------------------------------|---|
| <b>Distortion Correction</b>     | Reduces distortions occurring due to lens properties.                   |
| <b>Lat-Chromatic-Ab Adj</b>      | Reduces lateral chromatic aberrations occurring due to lens properties. |
| <b>Peripheral Illumin. Corr.</b> | Reduces peripheral light fall-off occurring due to lens properties.     |

#### Memo

- Corrections can only be made when a compatible lens is attached. (p.81) The features are disabled when using an accessory such as a rear converter that is attached between the camera and the lens.
- When the file format is set to [RAW] or [RAW+], the correction information is saved as a RAW file parameter and you can select [ON] or [OFF] when developing the RAW images. For the RAW Development function, [Color Fringe Correction] can also be set. (p.69)

## Composition Adjustment



It allows you to adjust the composition of your image using the Shake Reduction mechanism. Use this when you want to adjust the composition, such as when using a tripod during Live View shooting.

### 1 Select [Live View] in menu and press .

The [Live View] screen appears.

### 2 Select [Composition Adjust.] and set to .

### 3 Press twice.

The camera returns to standby mode.

### 4 Press .

Live View is displayed and the message [Adjust the composition of the image] appears.

### 5 Adjust the composition.

The amount of adjustment (the number of steps) is displayed at the top right of the screen.



#### Available operations

Moves the composition (up to 24 steps).

Adjusts the level of the composition (up to 8 steps. Not available when the amount of adjustment is 17 steps or more).

Resets the adjustment value to the default setting.

### 6 Press .

The camera returns to standby mode in Live View.

#### Caution

- This function cannot be used in the following situations.
  - When the drive mode is set to [Interval Shooting], [Interval Composite] or [Interval Movie Record]
  - While shooting with ASTROTRACER

#### Memo

- The adjusted composition is saved even if Live View is ended or the camera is turned off. To reset the saved adjustment value when Live View is ended, set [Composition Adjust.] to [Off] in [Memory] of the menu. (p.75)

## Anti-Aliasing Filter Simulator



By shaking the Shake Reduction unit, moiré reduction effect simulating that of a low-pass filter can be achieved.

### 1 Select [AA Filter Simulator] in menu and press .

### 2 Select [TYPE1] or [TYPE2] and press .

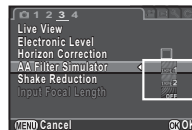

#### Caution











- This function cannot be used in the following situations.
  - When [HDR Capture] is set
  - In mode
- When the shutter speed is faster than 1/1000 seconds, the full effect of this function cannot be achieved.





## Playback Mode Palette Items

Playback functions can be set in the playback mode palette as well as the  1 menu (p.21).

Press  in single image display of the playback mode to display the playback mode palette.



| Item   | Function  | Page |
|--|---|------|
|  <b>Image Rotation</b> *1            | Changes the rotation information of images.   | p.62 |
|  <b>Digital Filter</b> *1            | Processes images with digital filters.  | p.66 |
|  <b>Color Moiré Correction</b> *1 *2 | Reduces color moiré in images.  | p.66 |
|  <b>Resize</b> *1 *2                 | Changes the number of recorded pixels or size of the image.   | p.65 |
|  <b>Cropping</b> *1                  | Crops out only the desired area of an image.  | p.65 |
|  <b>Index</b>                        | Joins a number of images together and creates an index image with them.   | p.68 |
|  <b>Protect</b>                      | Protects images from being accidentally erased.   | p.75 |
|  <b>Slideshow</b>                    | Plays back images one after another.  | p.62 |
|  <b>Save as Manual WB</b> *1         | Saves the white balance settings of the captured image as Manual White Balance.                                     | p.53 |
|  <b>Save Cross Processing</b>        | Saves the settings used for an image captured in Cross Processing mode of Custom Image as your "Favorite" settings. | p.55 |

| Item   | Function  | Page |
|--|---|------|
|  <b>RAW Development</b> *3            | Develops RAW images into JPEG images and saves them as a new file.  | p.69 |
|  <b>Movie Edit</b> *4               | Divides a movie or deletes unwanted segments.                       | p.68 |
|  <b>Image Copy</b>                  | Copies images between cards in SD1 and SD2 slots.                   | p.65 |
|  <b>Eye-Fi Image Transfer</b> *1 *5 | Transfers selected images wirelessly using an optional Eye-Fi card. | p.78 |

\*1 Not available when a movie is displayed.



\*2 Not available when a RAW image is displayed.

\*3 Available only when a RAW image is saved.

\*4 Available only when a movie is displayed.

\*5 Available only when an Eye-Fi card is inserted in the SD2 slot.

### Memo

- The functions of the  1 menu and playback mode palette can be used only for the images saved on the memory card that is currently being played back. To use the functions for the images saved on the other memory card, switch to the other memory card slot with  during single image display, then display the  1 menu or playback mode palette.

# Changing the Playback Method

## Displaying Multiple Images



You can display 6, 12, 20, 35 or 80 thumbnail images at the same time. (Default setting: 12 Thumbnail Display)

### 1 Turn to the left in playback mode.

The multi-image display screen appears.



#### Available operations

- |   |   |
|---|---|
|  | Moves the selection frame.                  |
|  | Shows the next/previous page.               |
|  | Switches between the SD1 card and SD2 card. |

- |   |   |
|---|---|
|  | Shows the display style selection screen. |
|---|---|



- |   |                              |
|---|------------------------------|
|  | Deletes the selected images. |
|---|------------------------------|

### 2 Press .

The selected image appears in single image display.





## Deleting Selected Images

### 1 Press in Step 1 of “Displaying Multiple Images”.

### 2 Select the images to delete.



#### Available operations

- |   |   |
|---|---|
|  | Moves the selection frame.  |
|  | Confirms/cancels the selection of the image to delete.  |
|  | Selects the range of images to delete.  |
|  | Shows the selected image in single image display.<br>Use  to select a different image. |

In the upper left area of the monitor, the number of selected images is displayed.

### 3 Press .

The delete confirmation screen appears.

### 4 Select [Select & Delete] and press .

#### Memo

- You can select up to 500 images at a time.
- Protected images cannot be selected.
- You can select one image at a time or a range of images.
- Use the same steps to select multiple images for the following functions.
  - Image Copy (p.65)
  - Index (p.68)
  - RAW Development (p.69)
  - Protect (p.75)
  - Eye-Fi Image Transfer (p.78)

## Displaying Images by Folder

- 1 Turn  to the left in Step 1 of “Displaying Multiple Images”.

The folder display screen appears.



### Available operations

▲▼◀▶ Moves the selection frame.

 Deletes the selected folder.

- 2 Press **OK**.

The images in the selected folder are displayed.

## Deleting a Folder

- 1 Select a folder to delete in Step 1 of “Displaying Images by Folder”, and press .

The delete confirmation screen appears.

- 2 Select **[Delete]** and press **OK**.

The selected folder and all images in it are deleted. When there are protected images in the folder, select **[Delete all]** or **[Leave all]**.

## Displaying Images by Shooting Date

Images will be grouped and displayed by shooting date.

- 1 Select **INFO** in Step 1 of “Displaying Multiple Images”.

The display style selection screen appears.

- 2 Select **[Calendar Filmstrip Display]**.

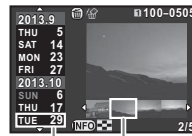

Shooting date  
Thumbnail date

### Available operations

▲▼ Selects a shooting date.

◀▶ Selects an image taken on the selected shooting date.

 to the right Shows the selected image in single image display.

 Deletes the selected image.

- 3 Press **OK**.





The selected image appears in single image display.

## Playing Back Images Continuously (Slideshow)

### 1 Select in the playback mode palette.

Slideshow starts.

#### Available operations

|   |                                  |
|---|----------------------------------|
|  | Pauses/resumes playback.         |
|  | Displays the previous image.     |
|  | Displays the next image.         |
|  | Stops playback.                  |
|  | Adjusts the volume of the movie. |

After all images are played back, the camera returns to single image display.

#### Memo

- You can change the [Display Duration], [Screen Effect], [Repeat Playback] and [Auto Movie Playback] settings for slideshow in [Slideshow] of the  1 menu. Slideshow can be started from the Slideshow setting screen.

## Displaying Rotated Images

When you take pictures with the camera held vertically, image rotation information is saved when shooting. When [Auto Image Rotation] in the  1 menu is set to [On], the image is automatically rotated based on the rotation information during playback (default setting).

The rotation information of an image can be changed by following the procedure below.

### 1 Display the image to edit in single image display.

### 2 Select in the playback mode palette.

The selected image is rotated in 90° increments and the four thumbnail images are displayed.

### 3 Use to select the desired rotation direction and press .

The image rotation information is saved.



#### Caution

- When [23. Save Rotation Info] is set to [Off] in the **C4** menu, image rotation information is not saved when shooting.
- You cannot change the rotation information in the following cases.
  - Protected images
  - Images without a rotation information tag
  - When [Auto Image Rotation] is set to [Off] in the  1 menu
- Movie files cannot be rotated.



## Connecting the Camera to an AV Device

Connect to an AV device, such as a TV, equipped with an HDMI terminal to display Live View images while shooting or to play back images in playback mode.

Make sure to have a commercially available HDMI cable equipped with an HDMI terminal (type D).

**1 Turn the AV device and camera off.**

**2 Open the terminal cover of the camera, and connect the cable to the HDMI terminal.**

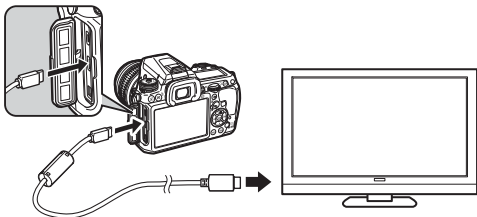

**3 Connect the other end of the cable to the input terminal on the AV device.**

**4 Turn the AV device and camera on.**

The camera turns on in HDMI mode, and the camera information is displayed on the screen of the connected AV device.

### Caution

- While the camera is connected to an AV device, nothing is displayed on the camera monitor. Also, you cannot adjust the volume on the camera. Adjust the volume on the AV device.

### Memo

- Check the operating manual of the AV device and select a suitable input terminal for connecting the camera.
- If you intend to use the camera continuously for a long period, use of the optional AC adapter kit is recommended.
- By default, the maximum resolution corresponding to the AV device and camera is automatically selected. If it fails to play back images properly, change the setting in [HDMI Out] of the  menu.

## Connecting the Camera to a Computer

Connect the camera to a computer using a USB cable. Make sure to have a commercially available USB cable equipped with a micro B terminal.

- 1 Turn the computer on.
- 2 Turn the camera off.
- 3 Open the terminal cover of the camera, and connect the USB cable to the USB terminal.

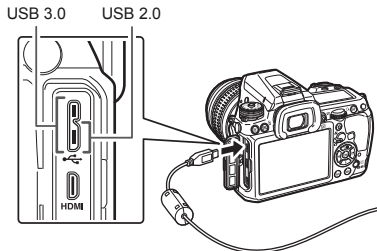

- 4 Connect the USB cable to the USB port of the computer.
- 5 Turn the camera on.  
The camera is recognized as a removable disk.  
If the "K-3" dialog appears, select [Open folder to view files using Windows Explorer] and click the OK button.
- 6 Save the captured images to the computer.
- 7 Disconnect the camera from the computer.

### ⚠ Caution

- The camera cannot be operated while it is connected to a computer. To operate the camera, terminate the USB connection on the computer, then turn off the camera and remove the USB cable.

### 📌 Memo

- Refer to "Operating Environment for USB Connection and Provided Software" (p.94) for system requirements to connect the camera to a computer or to use the software.
- The USB connection mode when connecting the camera to a computer can be set in [USB Connection] of the 1 menu. Normally, you do not need to change the default setting ([MSC]).

### USB terminal

The micro B terminal supports both USB 3.0 cables and USB 2.0 cables. Both types can be used with this camera. If the host controller of the device to be connected to the camera supports USB 3.0, the data transfer speed is faster when a USB 3.0 cable is used.

## Editing and Processing Images

### Copying an Image

Copies images between memory cards in SD1 and SD2 slots.

- 1 Select an image saved on the memory card from which the images have to be copied, and display it in single image display.
- 2 Select **[▶▶]** in the playback mode palette.
- 3 Select **[Select image(s)]** or **[Select a folder]** and press **[OK]**.
- 4 Select the image(s) or folder to copy.  
Refer to Step 2 of “Deleting Selected Images” (p.60) for how to select image(s) or a folder.
- 5 Press **[INFO]**.  
The save confirmation screen appears.
- 6 Select the location to save the image(s) or folder and press **[OK]**.

### Changing the Image Size

#### ⚠ Caution

- Only JPEG images captured with this camera can be resized or cropped.
- Images already resized or cropped to the minimum file size cannot be processed.

### Changing the Number of Recorded Pixels (Resize)

Changes the number of recorded pixels, and saves the image as a new file.

- 1 Display the image to edit in single image display.
- 2 Select **[⏏]** in the playback mode palette.  
The screen to select the number of recorded pixels appears.
- 3 Use **[◀▶]** to select the number of recorded pixels and press **[OK]**.  
You can select an image size smaller than that of the original image.  
The save confirmation screen appears.
- 4 Select **[Save to SD1]** or **[Save to SD2]** and press **[OK]**.



### Cropping Out Part of the Image (Cropping)

Crops out only the desired area of the selected image and saves it as a new image.

- 1 Display the image to edit in single image display.
- 2 Select **[⏏]** in the playback mode palette.  
The cropping frame to specify the size and position of the area to crop appears on the screen.

- 3** Specify the size and position of the area to crop by using the cropping frame.



#### Available operations

|  |   |
|--|---|
|  | Changes the size of the cropping frame.             |
|  | Moves the cropping frame.                           |
|  | Changes the aspect ratio or Image Rotation setting. |
|  | Rotates the cropping frame (only when possible).    |

- 4** Press **OK**.

The save confirmation screen appears.

- 5** Select **[Save to SD1]** or **[Save to SD2]** and press **OK**.

### Correcting Color Moiré

Reduces color moiré in images.

- 1** Display the image to edit in single image display.

- 2** Select in the playback mode palette.

If the image cannot be edited, [This image cannot be processed] appears.

- 3** Use **◀▶** to select the level and press **OK**.

The save confirmation screen appears.



- 4** Select **[Save to SD1]** or **[Save to SD2]** and press **OK**.

**Caution**

- The Color Moiré Correction function can be used only for the JPEG images captured with this camera.

### Processing Images with Digital Filters

- 1** Display the image to edit in single image display.

- 2** Select in the playback mode palette.

The screen to select a filter appears.

- 3** Select a filter.

Use to select a different image.



|                    |               |
|--------------------|---------------|
| Base Parameter Adj | Sketch        |
| Extract Color      | Water Color   |
| Toy Camera         | Pastel        |
| Retro              | Posterization |
| High Contrast      | Miniature     |
| Shading            | Soft          |
| Invert Color       | Starburst     |
| Unicolor Bold      | Fish-eye      |
| Bold Monochrome    | Slim          |
| Tone Expansion     |               |

Proceed to Step 6 if you do not need to change the parameters.

- 4** Press **INFO**.

The parameter setting screen appears.

## 5 Set the parameters.



### Available operations

- 
- ▲▼ Selects a parameter.
- 
- ◀▶ Adjusts the value.
- 

## 6 Press **OK**.

The save confirmation screen appears.

## 7 Select **[Apply additional filter(s)]**, **[Save to SD1]** or **[Save to SD2]**, and press **OK**.

Select **[Apply additional filter(s)]** when you want to apply additional filters to the same image. The screen of Step 3 reappears.

### ⚠ Caution

- Only JPEG and RAW images captured with this camera can be edited with the digital filters.

### 📝 Memo

- Up to 20 filters, including the digital filter used during shooting (p.56), can be applied to the same image.

## Recreating Filter Effects

Retrieves the filter effects of the selected image and applies the same filter effects to other images.

### 1 Display a filter-processed image in single image display.

### 2 Select **0** in the playback mode palette.

### 3 Select **[Recreating filter effects]** and press **OK**.

The filter effects used for the selected image appear.



### 4 To check the parameter details, press **INFO**.

Press **INFO** again to return to the previous screen.

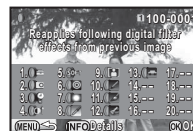

### 5 Press **OK**.

The image selection screen appears.

### 6 Use **☀** to select an image for applying the same filter effects, and press **OK**.

You can only select an image saved in the same memory card that has not been processed with a filter.

The save confirmation screen appears.



### 7 Select **[Save to SD1]** or **[Save to SD2]** and press **OK**.

### 📝 Memo

- If **[Searching for the original image]** is selected in Step 3, the original image prior to digital filter application can be retrieved.







## Creating a Composite Image (Index)

Joins a number of images together and creates a new image with them.

### 1 Select in the playback mode palette.

The Index setting screen appears.

### 2 Select [Layout].

Select from  (Thumbnail),  (Square),  (Random1),  (Random2),  (Random3) or  (Bubble).

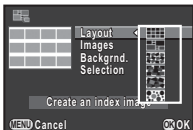





### 3 Select the number of images from 12, 24 or 36 in [Images].

When the number of saved images is smaller than the number selected, empty spaces will appear when [Layout] is set to  and some images may be duplicated for other layouts.

### 4 Select the background color from white or black in [Backgrnd.].

### 5 Select a type of image selection in [Selection].

|  |   |
|--|---|
|  <b>Auto select</b>     | Picks images automatically from all of the images saved.  |
|  <b>Select image(s)</b> | Lets you select images that you want to include in the index image.<br>If  is selected, [Select image(s)] appears and leads you to the image selection screen. |
|  <b>Select a folder</b> | Picks images automatically from the folder selected.<br>If  is selected, [Select a folder] appears and leads you to the folder selection screen.               |

### 6 Select [Create an index image] and press **OK**.

The index image appears.

### 7 Select [Save to SD1], [Save to SD2] or [Reshuffle], and press **OK**.

When [Reshuffle] is selected, you can reselect the images to be included in the index and display a new index image.

## Memo

- The file name format for index image is "INDXxxxx.JPG".

## Editing Movies

### 1 Display the movie to edit in single image display.

### 2 Select in the playback mode palette.





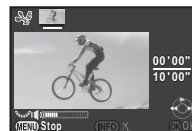

The movie editing screen appears.

### 3 Select the point where you want to divide the movie.

The frame at the dividing point is displayed at the top of the screen. Up to four points can be selected to divide the original movie into five segments.



#### Available operations

|  |                                    |
|--|------------------------------------|
|                 | Plays back/pauses a movie.         |
|                 | Forwards a frame (when paused).    |
| Press and hold  | Fast-forwards playback.            |
|                 | Reverses a frame (when paused).    |
| Press and hold  | Fast-reverses playback.            |
|                 | Adjusts the volume.                |
| <b>INFO</b>  | Confirms/cancels a dividing point. |

Proceed to Step 7 if you do not delete any segment.

### 4 Press **OK**.

The screen to select segments to delete is displayed.

### 5 Use to move the selection frame and press **OK**.

The segments to delete are specified. (Multiple segments can be deleted at once.)  
Press **OK** again to cancel the selection.



## 6 Press **MENU**.

The screen of Step 3 reappears.

## 7 Press **OK**.

The save confirmation screen appears.

## 8 Select **[Save to SD1]** or **[Save to SD2]** and press **OK**.

### Memo

- Select dividing points in chronological order from the beginning of the movie. When canceling the selected dividing points, cancel each of them in reverse order (from the end of the movie to the beginning). In an order other than specified, you can neither select frames as a dividing point nor cancel the selections of the dividing points.

## RAW Development

You can develop RAW images into JPEG images, and save them as a new file.

## 1 Select **RAW** in the playback mode palette.

The screen for selecting a RAW image processing option appears.

## 2 Select the desired option and press **OK**.

|                               |  |
|-------------------------------|--|
| <b>Select single image</b>    | Develops an image.   |
| <b>Select multiple images</b> | Develops up to 500 images with the same settings.                        |
| <b>Select a folder</b>        | Develops up to 500 images in the selected folder with the same settings. |

When [Select single image] is selected, proceed to Step 6. The image/folder selection screen appears.

## 3 Select the image(s) or a folder.

Refer to Step 2 of "Deleting Selected Images" (p.60) for how to select the image(s) or a folder.

## 4 Press **INFO**.

The screen for selecting the parameter setting method appears.

## 5 Select the parameter setting method and press **OK**.



|  |   |
|--|---|
| <b>Develop images as shot</b>                | Allows you to change Image Capture Settings (File Format, JPEG Recorded Pixels, and JPEG Quality).  |
| <b>Develop images with modified settings</b> | Allows you to change Image Capture Settings (File Format, Aspect Ratio, JPEG Recorded Pixels, JPEG Quality, Color Space), Lens Correction (Distortion Correction, Lat-Chromatic-Ab Adj, Peripheral Illumin. Corr., Color Fringe Correction), White Balance, Custom Image, Digital Filter, HDR, Sensitivity, High-ISO NR, and Shadow Correction. |

## 6 Set the parameters.



### Available operations

|            |   |
|------------|---|
| <b>▲ ▼</b> | Selects a parameter.                                      |
| <b>◀ ▶</b> | Changes the value.  |
| <b>☀</b>   | Selects a different image (when in single image display). |

For Image Capture Settings and Lens Correction, press **▶** and use **▲ ▼** to select an item.

For White Balance, Custom Image and Digital Filter, press **▶** to display the setting screen.

## 7 Press **OK**.

The save confirmation screen appears.

## 8 Select [Save to SD1] or [Save to SD2] and press .

When [Select single image] is selected, select [Continue] or [Exit], and press .

### Caution

- Only RAW images captured with this camera can be developed.

### Memo



- When [Select multiple images] or [Select a folder] is selected in Step 2, a folder with a new number is created, and the JPEG images are stored in the new folder.
- With the provided software “Digital Camera Utility 5”, you can develop RAW files on a computer,



# Camera Settings

## Customizing the Button/E-dial Functions

### Setting the //ⓘ Operation

For each exposure mode, you can select the parameters for when  and  are turned and ⓘ is pressed.

- 1 Select [E-Dial Programming] in  menu and press .



The [E-Dial Programming] screen appears.

- 2 Select an exposure mode and press .

The screen for the selected exposure mode appears.

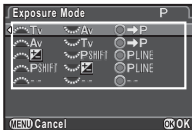
- 3 Select the desired setting for each exposure mode and press .





|   |                       |
|---|-----------------------|
| Tv  | Change Shutter Speed  |
| Av  | Change Aperture Value |
| ISO   | Change Sensitivity    |
|  | EV Compensation       |
|  | Return to P Mode      |
| P SHIFT   | Program Shift         |
| P LINE  | Program Line          |
| --  | Not available         |

- 4 Press .



The [E-Dial Programming] screen reappears.  
Repeat Steps 2 to 4.

- 5 Press  twice.

### Memo

- If you select [Rotation Direction] in Step 2, you can reverse the effect obtained by turning  or .

## Setting the Button Operation

You can set the functions for when  or  is pressed, or when the main switch is turned to .

- 1 Select [Button Customization] in  menu and press .

The [Button Customization] screen appears.

- 2 Select [RAW/Fx Button], [AF Button] or [Preview Dial] and press .

The screen to set the function for the selected item is displayed.

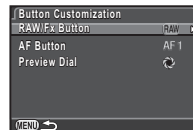

- 3 Select a function and press .

The following functions can be assigned to each button.

|                      | Setting                | Function   | Page |
|----------------------|------------------------|--|------|
| RAW/<br>Fx<br>Button | One Push File Format   | Temporarily changes the file format. (Default setting) | p.72 |
|                      | Exposure Bracketing    | Sets the Exposure Bracketing.                          | p.49 |
|                      | Optical Preview        | Activates the Optical Preview.                         | p.46 |
|                      | Digital Preview        | Activates the Digital Preview.                         |      |
|                      | Shake Reduction        | Turns the Shake Reduction function on/off.             | —    |
|                      | LCD Panel Illumination | Turns the LCD panel illumination on/off.               | p.15 |

|              | Setting         | Function  | Page |
|--------------|-----------------|---|------|
| AF Button    | Enable AF1      | Autofocus is performed when <b>AF</b> is pressed.   | p.42 |
|              | Enable AF2      | Autofocus is performed when <b>AF</b> is pressed and not when the shutter release button is pressed halfway.    |      |
|              | Cancel AF       | While <b>AF</b> is pressed, autofocus is not performed even when the shutter release button is pressed halfway. |      |
| Preview Dial | Optical Preview | Activates the Optical Preview.  | p.46 |
|              | Digital Preview | Activates the Digital Preview.  |      |

#### 4 Press **MENU**.

The [Button Customization] screen reappears.  
Repeat Steps 2 to 4.

#### 5 Press **MENU** twice.

##### ⚠ Caution

- [LCD Panel Illumination] in [RAW/Fx Button] cannot be selected when [22. LCD Panel Illumination] is set to [Off] in the **C4** menu.

### Setting the One Push File Format

#### 1 Set [RAW/Fx Button] to [One Push File Format] in Step 3 of “Setting the Button Operation” (p.71).

#### 2 Select or for [Cancel after 1 shot].

|                                     |   |
|-------------------------------------|---|
| <input checked="" type="checkbox"/> | The recording format returns to the [File Format] setting of [Image Capture Settings] in the <b>1</b> menu after a picture is taken. (Default setting)  |
| <input type="checkbox"/>            | The setting is retained until any of the following operations is performed: <ul style="list-style-type: none"> <li>When <b>RAW/Fx</b> is pressed again</li> <li>When <b>▶</b>, <b>MENU</b> or <b>INFO</b> is pressed, or when the mode dial or main switch is turned</li> </ul> |

#### 3 Select the file format when **RAW/Fx** is pressed.

The left side is the [File Format] setting and the right side is the file format when **RAW/Fx** is pressed.

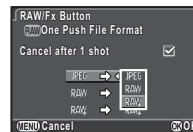

##### ⚠ Caution



- The One Push File Format function cannot be used when [Memory Card Options] is set to [Separate RAW/JPEG] in the **1** menu. (p.35)

## Saving Frequently Used Settings



Camera settings can be saved to **U1**, **U2**, and **U3** of the mode dial and used repeatedly.

The following settings can be saved.

|   |   |
|---|---|
| Exposure Mode (except for  /  ) | Drive Mode  |
| Sensitivity   | White Balance   |
| EV Compensation   | Custom Image  |
| AE Metering   |  1-4 menu settings (with exceptions) |
| AF point  | C1-4 menu settings  |
| Flash Mode  |   |

## Saving the Settings

**1** Set all of the settings to save on the camera.

**2** Select [Save USER Mode] in  4 menu and press .

The [Save USER Mode] screen appears.

**3** Select [Save Settings] and press .

The [Save Settings] screen appears.

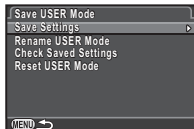

**4** Select [USER1], [USER2] or [USER3], and press .

**5** Select [Save] and press .

The screen of Step 3 reappears.

### Caution

- [Save USER Mode] cannot be selected when the mode dial is set to .

### Memo

- The settings saved as USER mode can be displayed on the monitor when you select [Check Saved Settings] in Step 3.
- To reset the settings to the default values, select [Reset USER Mode] in Step 3.

## Editing a Setting Name

You can change the name of the USER mode in which you saved settings.

**1** Select [Rename USER Mode] in Step 3 of “Saving the Settings” and press .

The [Rename USER Mode] screen appears.

**2** Select [USER1], [USER2] or [USER3], and press .

The text-entry screen appears.

**3** Change the text.





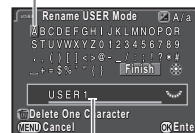

Up to 18 single-byte alphanumeric characters and symbols can be entered.

Text selection cursor



Text input cursor

### Available operations

|   |  |
|---|--|
|   | Moves the text selection cursor.   |
|    | Moves the text input cursor.   |
|    | Switches between upper and lower case letters.   |
|    | Enters a character selected with the text selection cursor at the position of the text input cursor. |
|    | Deletes a character at the position of the text input cursor.  |

- 4** After entering the text, move the text selection cursor to [Finish], and press **OK**.

The [Rename USER Mode] screen reappears.

### Using the Saved USER Mode

- 1** Set the mode dial to **U1, U2, or U3**.

The USER mode guide is displayed for 30 seconds.

Use **▲▼** to check the saved settings.



- 2** Change the settings as necessary.

The exposure mode can be changed in [Exposure Mode] of the **1** menu.

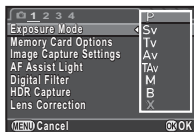

### **Memo**

- The settings changed in Step 2 are not saved as USER mode settings. When the camera is turned off, the camera returns to the originally saved settings. To change the original settings, save the USER mode settings again.

## Displaying the Local Date and Time of the Specified City

1

The date and time set in Initial Setting (p.29) serve as the date and time of your present location and are reflected in the shooting date and time for images.

Setting the destination to a location other than your present location enables you to display the local date and time on the monitor when traveling abroad and also save images time-stamped with the local date and time.

- 1** Select **[World Time]** in **1** menu.

- 2** Select the time you wish to display in **[Time Setting]**.

Select **🏠** (Hometown) or **➔** (Destination).

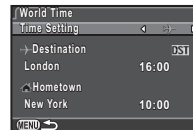

- 3** Select **[➔ Destination]** and press **▶**.

The [➔ Destination] screen appears.

- 4** Use **◀▶** to select a city.

Use **☀️** to change the region.

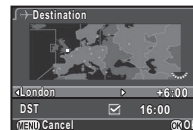



- 5** Select **[DST] (daylight saving time)**, and use **◀▶** to select  or .

- 6** Press **OK**.

The [World Time] screen reappears.

## Memo

- Refer to “List of World Time Cities” (p.94) for cities that can be selected as a hometown or destination.
- Select [ Hometown] in Step 3 to change the city and DST settings for the hometown.
-  appears in the control panel when [Time Setting] is set to .

## Selecting Settings to Save in the Camera



Most of the functions set on this camera are saved even if the camera is turned off. For the following function settings, you can select whether to save the settings () or to return the settings to their default values () when the camera is turned off. The default settings are  for Digital Filter and HDR Capture, and  for other functions.

Set in [Memory] of the 4 menu.

|                 |                             |
|-----------------|-----------------------------|
| Flash Mode      | Flash Exposure Compensation |
| Drive Mode      | Digital Filter              |
| White Balance   | HDR Capture                 |
| Custom Image    | Composition Adjust.         |
| Sensitivity     | Playback Info Display       |
| EV Compensation |                             |

## Memo

- When [Reset] of the 3 menu is performed, all Memory settings return to the default values.

## File Management Settings

### Protecting Images from Deletion (Protect)

You can protect images from being accidentally deleted.

#### Caution

- Even protected images are deleted if the inserted memory card is formatted.

#### 1 Select in the playback mode palette.

The screen for selecting the unit for processing appears.

#### 2 Select [Select image(s)] or [Select a folder] and press .



#### 3 Select the image(s) or folder to protect.

Refer to Step 2 of “Deleting Selected Images” (p.60) for how to select the image(s) or a folder.

Proceed to Step 5 if [Select a folder] is selected.

#### 4 Press .

The confirmation screen appears.

#### 5 Select [Protect] and press .

#### Memo

- To protect all images stored in the memory card, select [Protect All Images] of the 1 menu.

## Selecting the Folder/File Settings



### Folder Name

When images are captured with this camera, a folder is automatically created and the captured images are stored in the new folder. Each folder name consists of a sequential number from 100 to 999 and a string of 5 characters.

You can change the folder name in [Folder Name] of the 2 menu.

#### 1 Select [Folder Name] in 2 menu and press .

The [Folder Name] screen appears.

#### 2 Select a folder name and press .

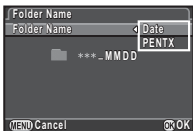

|              |  |
|--------------|--|
| <b>Date</b>  | The two digits of the month and day on which the picture was taken are assigned after the folder number. (Default setting)<br>[MMDD] appears according to the date format set in [Date Adjustment].<br>Example) 101_0125: for images taken on January 25th |
| <b>PENTX</b> | The character string "PENTX" is assigned after the folder number.<br>Example) 101PENTX   |

Proceed to Step 5 if you do not need to change the folder name.

#### 3 Press , and then press .

The text-entry screen appears.

#### 4 Change the text.

Enter 5 single-byte alphanumeric characters.

Refer to Steps 3 and 4 of "Editing a Setting Name" (p.73) for how to enter text.

#### 5 Press twice.

##### Memo

- A folder with a new number is created when the folder name is changed.
- A maximum of 500 images (100 images for Eye-Fi card) can be stored in a single folder. When the number of captured images exceeds 500, a new folder is created with the number following the number of the folder currently being used. In Exposure Bracketing shooting, images will be stored in the same folder until shooting is completed.
- When [Create New Folder] is selected in the 2 menu, a folder is created with a new number when the next image is saved. When a memory card is inserted in both SD1 and SD2, a new folder is created on both memory cards.
- When [Select multiple images] or [Select a folder] of [RAW Development] is performed, a folder with a new number is created, and the JPEG images are stored in the new folder. (p.69)

##### Caution

- The maximum folder number is 999. After the folder number reaches 999, you cannot capture new images if you attempt to change the folder name or create a new folder, or when the file name number reaches 9999.

## File Name

One of the following string of characters is used as the file name prefix depending on the [21. Color Space] setting of the **C3** menu.

| Color Space | File Name    |
|-------------|--------------|
| sRGB        | IMGFxxxx.JPG |
| AdobeRGB    | _IMGxxxx.JPG |

The first four characters can be changed to a character string of your choice.

### 1 Select [File Name] in **↖2** menu and press **▶**.

The [File Name] screen appears.

### 2 Select **📷** or **🎥** and press **▶**.

The text-entry screen appears.



### 3 Change the text.

Up to 4 single-byte alphanumeric characters can be entered.

Refer to Steps 3 and 4 of “Editing a Setting Name” (p.73) for how to enter text.

### 4 Press **MENU** twice.

#### **Memo**

- When [Color Space] is [AdobeRGB], the file name prefix is “\_” and first three characters of the specified character string becomes the file name.
- For movies, regardless of the [Color Space] setting, the file name is “IMGFxxxx.MOV” or a file name with the specified string of characters.

## File No.

Each file name consists of a string of 4 characters and a sequential number from 0001 to 9999. You can set whether to continue the sequential numbering for the file name even if a new folder is created in [Sequential Numbering] of [File No.] in the **↖2** menu.

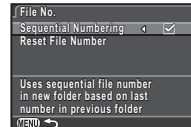

|                                     |   |
|-------------------------------------|---|
| <input checked="" type="checkbox"/> | Continues the sequential numbering for the file name even if a new folder is created. (Default setting) |
| <input type="checkbox"/>            | Returns the file number of the first image saved to a folder to 0001 each time a new folder is created. |

Select [Reset File Number] to reset the file number to its default value.

#### **Memo**

- When the file number reaches 9999, a new folder is created and the file number is reset.

## Setting the Copyright Information



Sets the photographer and copyright information embedded in Exif data.

### 1 Select [Copyright Information] in menu and press **▶**.

The [Copyright Information] screen appears.

### 2 Use **◀▶** to set [Embed Copyright Data].



|                                     |   |
|-------------------------------------|---|
| <input type="checkbox"/>            | Does not embed copyright information in the Exif. (Default setting) |
| <input checked="" type="checkbox"/> | Embeds copyright information in the Exif.                           |

### 3 Select [Photographer] or [Copyright Holder], and press **▶**.

The text-entry screen appears.

### 4 Change the text.

Up to 31 single-byte alphanumeric characters and symbols can be entered.

Refer to Steps 3 and 4 of “Editing a Setting Name” (p.73) for how to enter text.

### 5 Press **MENU** twice.

#### Memo

- The Exif information can be checked using the provided software “Digital Camera Utility 5”.

## Using a Wireless Memory Card



A memory card with a built-in wireless LAN “Eye-Fi card” (Wi-Fi transmission) or a “Flucard” compatible with this camera can be used. By using these cards, images can be transferred from the camera to a computer or other device via wireless LAN. Select the camera action when using an Eye-Fi card or a Flucard in [Wireless Memory Card] of the menu.

### 1 Select [Wireless Memory Card] in menu and press **▶**.

The [Wireless Memory Card] screen appears.

### 2 Select [Action Mode].

Items that can be set are displayed according to the type of card inserted.

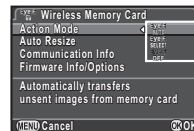

#### Eye-Fi card

|               |  |
|---------------|--|
| <b>AUTO</b>   | Transfers automatically when images are taken, new images are saved, or images are overwritten. (Default setting)<br>For movies, only files under 2 GB can be transferred. |
| <b>SELECT</b> | Transfers images or folders that are selected in [Eye-Fi Image Transfer] of the playback mode. Only JPEG and RAW images can be transferred.                                |
| <b>OFF</b>    | Stops the communication function.  |

#### Flucard

|            |   |
|------------|---|
| <b>ON</b>  | Enables wireless data transfer with Flucard.  |
| <b>OFF</b> | Disables wireless data transfer with Flucard. |

### 3 Specify [Auto Resize].

When set to , JPEG images are saved to the Eye-Fi card or Flucard at the size of .

### 4 Press **MENU** twice.



### Caution

- Be sure to insert an Eye-Fi card or a Flucard in the SD2 slot. If it is inserted in the SD1 slot, the wireless LAN function cannot be used. When an Eye-Fi card or a Flucard is not inserted in the SD2 slot, the [Wireless Memory Card] settings of the 3 menu cannot be set.
- Be sure to set up a wireless LAN access point on a computer for the card connection.
- For RAW images and movie files, the success of transfer depends on the specifications and settings of the Eye-Fi card in use.
- Images may not be transferred when the battery level is low.
- It may take time to transfer a large number of images. The camera may turn off if the internal temperature of the camera becomes high.
- For precautions on the Eye-Fi card, refer to “About Eye-Fi Cards” (p.102).

### Memo

- A smartphone can be used to operate this camera when a Flucard compatible with this camera is used. Refer to the Flucard manual for details on how to use the card.
- When an Eye-Fi card is used, 100 images can be stored in a single folder. For RAW+ images, two files are counted as one image.
- In Step 2, select [Communication Info] to check the Wireless LAN information, and [Firmware Info/Options] to check the firmware version of the cards.
- When [Reset Transfer Settings] is selected in Step 2, the [Action Mode] setting is returned to their default values.

# Restrictions on the Combinations of Special Functions

×: Not available

|                     |                         | Composition Adjust. | HDR Capture | Save RAW Data | Distortion Correction | Digital Filter |
|---------------------|-------------------------|---------------------|-------------|---------------|-----------------------|----------------|
| Flash               |                         |                     | ×           |               |                       |                |
| Drive Mode          | Continuous Shooting     |                     | ×           | ×             |                       |                |
|                     | Exposure Bracketing     |                     | ×           |               |                       |                |
|                     | Mirror Lock-up Shooting |                     | ×           |               |                       |                |
|                     | Multi-exposure          |                     | ×           |               | ×                     | ×              |
|                     | Interval Shooting       | ×                   |             |               |                       |                |
|                     | Interval Composite      | ×                   | ×           |               | ×                     | ×              |
|                     | Interval Movie Record   | ×                   |             | ×             |                       |                |
| HDR Capture         |                         |                     | /           |               |                       | ×              |
| AA Filter Simulator |                         |                     | ×           |               |                       |                |

## Functions Available with Various Lenses

All exposure modes are available when DA, DA L, or FA J lens is used, or when a lens with an **A** position is used with the aperture ring set to the **A** position.

When they are used in a position other than **A**, or other lenses are used, the following restrictions apply.

✓: Available #: Restricted x: Not available

| Function   | Lens<br>[Mount type] | DA<br>DA L<br>D FA        | FA J<br>FA <sup>*6</sup> | F <sup>*6</sup> | A               | M<br>P          |
|--|----------------------|---------------------------|--------------------------|-----------------|-----------------|-----------------|
|  |                      | [KAF]<br>[KAF2]<br>[KAF3] | [KAF]<br>[KAF2]          | [KAF]           | [KA]            | [K]             |
| Autofocus<br>(Lens only)<br>(With AF adapter 1.7x) <sup>*1</sup>           |                      | ✓<br>–                    | ✓<br>–                   | ✓<br>–          | –<br>#          | –<br>#          |
| Manual focus<br>(With focus indicator) <sup>*2</sup><br>(With matte field) |                      | ✓                         | ✓                        | ✓               | ✓               | ✓               |
| Quick-shift focus  |                      | # <sup>*4</sup>           | x                        | x               | x               | x               |
| Focus point selection mode<br>[Auto]                                       |                      | ✓                         | ✓                        | ✓               | # <sup>*8</sup> | x               |
| AE Metering [Multi-segment]  |                      | ✓                         | ✓                        | ✓               | ✓               | x               |
| <b>P/Sv/Tv/Av/TAv</b> mode   |                      | ✓                         | ✓                        | ✓               | ✓               | # <sup>*9</sup> |
| <b>M</b> mode  |                      | ✓                         | ✓                        | ✓               | ✓               | #               |
| P-TTL auto flash <sup>*3</sup>   |                      | ✓                         | ✓                        | ✓               | ✓               | x               |
| Power zoom   |                      | –                         | x                        | –               | –               | –               |
| Automatically obtaining the lens focal length information                  |                      | ✓                         | ✓                        | ✓               | x               | x               |
| Lens Correction  |                      | ✓ <sup>*5</sup>           | x <sup>*7</sup>          | x               | x               | x               |

<sup>\*1</sup> Lenses with a maximum aperture of F2.8 or faster. Only available at the **A** position.

<sup>\*2</sup> Lenses with a maximum aperture of F5.6 or faster.

<sup>\*3</sup> Available when using the built-in flash, AF540FGZ, AF540FGZ II, AF360FGZ, AF360FGZ II, AF200FG or AF160FC.

<sup>\*4</sup> Only available with compatible lenses.

<sup>\*5</sup> Distortion Correction and Peripheral Illumination Correction are disabled when a DA FISH-EYE 10-17mm lens is used.

<sup>\*6</sup> To use an FA SOFT 28mm F2.8 lens, FA SOFT 85mm F2.8 lens, or F SOFT 85mm F2.8 lens, set [27. Using Aperture Ring] to [Enable] in the **C4** menu. Pictures can be taken with the aperture you set, but only within a manual aperture range.

<sup>\*7</sup> Only available with an FA 31mm F1.8 Limited, FA 43mm F1.9 Limited, or FA 77mm F1.8 Limited lens.

<sup>\*8</sup> Fixed to [Spot].

<sup>\*9</sup> **Av** with the aperture open. (The aperture ring has no effect on the actual aperture value.)

### ⚠ Caution

- When the aperture ring is set to a position other than **A** or a lens without an **A** position or accessories such as an auto extension tube or auto bellows are used, the camera will not operate unless [27. Using Aperture Ring] is set to [Enable] in the **C4** menu. Refer to “Using the Aperture Ring” (p.83) for details.

### Lens names and mount names

DA lenses with a motor and FA zoom lenses with power zoom use the KAF2 mount. DA lenses with a motor and no AF coupler use the KAF3 mount.

FA single focal length lenses (non-zoom lenses), DA or DA L lenses without a motor, and D FA, FA J and F lenses use the KAF mount.

Refer to respective lens manuals for details.

## Compatibility with the Built-in Flash

Depending on the lens being used, the use of the built-in flash may be limited.

| Lens  | Restrictions when using the built-in flash   |
|---|--|
| DA FISH-EYE 10-17mm F3.5-4.5 ED (IF)/<br>DA 12-24mm F4 ED AL/<br>DA 14mm F2.8 ED (IF)/<br>FA★300mm F2.8 ED (IF)/<br>DA★560mm F5.6 ED AW/<br>FA★600mm F4 ED (IF)/<br>FA★250-600mm F5.6 ED (IF) | The built-in flash is not available due to vignetting.   |
| F FISH-EYE 17-28mm F3.5-4.5   | Vignetting may occur if the focal length is less than 20 mm.   |
| DA 16-45mm F4 ED AL   | When the focal length is less than 28 mm, or when the focal length is 28 mm and the shooting distance is 1 m or less, vignetting may occur.  |
| DA★16-50mm F2.8 ED AL (IF) SDM  | When the focal length is 20 mm or less or when the focal length is 35 mm and the shooting distance is less than 1.5 m, vignetting may occur. |
| DA 17-70mm F4 AL (IF) SDM   | When the focal length is less than 24 mm or when the focal length is 35 mm and the shooting distance is 1 m or less, vignetting may occur.   |
| DA 18-250mm F3.5-6.3 ED AL (IF)   | Vignetting may occur if the focal length is less than 35 mm.   |
| DA 18-270mm F3.5-6.3 ED SDM   | Vignetting may occur if the focal length is less than 24mm.  |

| Lens                                    | Restrictions when using the built-in flash  |
|---|---|
| FA★28-70mm F2.8 AL                      | Vignetting may occur if the focal length is 28 mm and the shooting distance is less than 1 m. |
| FA SOFT 28mm F2.8/<br>FA SOFT 85mm F2.8 | The built-in flash always discharges fully.   |

## Setting the Focal Length

The Shake Reduction function operates by obtaining the lens information such as focal length. Set the focal length when using a lens of which the focal length information cannot be automatically obtained.

- 1 Turn the camera off.
- 2 Attach a lens to the camera and turn the camera on.

The [Input Focal Length] screen appears.

- 3 Use **▲▼** to set the focal length.

Press **◀** to select a value from the list.

When using a zoom lens, select the actual focal length which the zoom is set to.



- 4 Press **OK**.

The camera returns to standby mode.

### Memo

- The focal length setting can be changed in [Input Focal Length] of the  menu.
- When using a lens without an **A** position or a lens with an **A** position with the aperture ring set to a position other than **A**, set [27. Using Aperture Ring] to [Enable] in the **C4** menu. (p.83)

## Using the Aperture Ring

C4

The shutter can be released even if the aperture ring of the D FA, FA, F or A lens is not set to the **A** position or a lens without an **A** position is attached.

Select [Enable] in [27. Using Aperture Ring] of the **C4** menu.

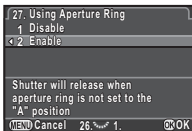

The following restrictions apply depending on the lens being used.

| Lens Used  | Exposure Mode | Restriction  |
|--|---------------|--|
| D FA, FA, F, A, M<br>(lens only or with automatic diaphragm accessories such as auto extension tube K) | <b>Av</b>     | The aperture remains open.<br>The shutter speed changes in relation to the open aperture but an exposure deviation may occur.      |
| D FA, FA, F, A, M, S<br>(with diaphragm accessories such as extension tube K)                          | <b>Av</b>     | Pictures can be taken with a set aperture value but an exposure deviation may occur.   |
| Manual diaphragm lens such as reflex lens (lens only)  | <b>Av</b>     |  |
| FA SOFT 28mm/<br>FA SOFT 85mm/<br>F SOFT 85mm<br>(lens only)   | <b>Av</b>     | Pictures can be taken with a set aperture value in the manual aperture range.<br>The exposure can be checked with Optical Preview. |
| All lenses   | <b>M</b>      | Pictures can be taken with a set aperture value and shutter speed.<br>The exposure can be checked with Optical Preview.            |

## Memo

- If the aperture ring is set to a position other than **A**, the camera operates in **Av** mode regardless of the mode dial setting except when set to **M**, **B** or **X** mode.
- [F--] appears for the aperture indicator in the status screen, Live View screen and viewfinder and on the LCD panel.

## Functions when Using an External Flash

Using an optional external flash AF540FGZ, AF540FGZ II, AF360FGZ, AF360FGZ II, AF200FG or AF160FC enables a variety of flash modes, such as P-TTL auto flash mode.

✓: Available #: Restricted #: Restricted x: Not available

| Camera Function \ Flash  | Built-in Flash  | AF540FGZ<br>AF540FGZ II<br>AF360FGZ<br>AF360FGZ II | AF200FG<br>AF160FC |
|--|-----------------|--|--------------------|
| Red-eye reduction flash  | ✓               | ✓  | ✓                  |
| Auto Flash Discharge   | ✓               | ✓  | ✓                  |
| Automatically switching to the flash sync speed                          | ✓               | ✓  | ✓                  |
| Aperture value is automatically set in <b>P</b> mode and <b>Tv</b> mode. | ✓               | ✓  | ✓                  |
| P-TTL auto flash   | ✓ <sup>*1</sup> | ✓ <sup>*1</sup>                                    | ✓ <sup>*1</sup>    |
| Slow-speed Sync  | ✓               | ✓  | ✓                  |
| Flash Exposure Compensation  | ✓               | ✓  | ✓                  |
| AF assist light of external flash  | x               | ✓  | x                  |
| Trailing Curtain Sync <sup>*2</sup>                                      | ✓               | ✓  | x                  |
| Contrast control sync flash mode   | # <sup>*3</sup> | ✓  | # <sup>*4</sup>    |
| Slave flash  | x               | ✓  | x                  |
| High-speed sync  | x               | ✓  | x                  |
| Wireless flash   | # <sup>*4</sup> | ✓ <sup>*5</sup>                                    | x                  |

<sup>\*1</sup> Available only when using a DA, DA L, D FA, FA J, FA, F or A lens.

<sup>\*2</sup> Shutter speed of 1/90 seconds or slower.

<sup>\*3</sup> When combined with the AF540FGZ, AF540FGZ II, AF360FGZ, or AF360FGZ II, 1/3 of the flash discharge can be output by the built-in flash and 2/3 can be output by the external flash.

- <sup>\*4</sup> Available only when combined with the AF540FGZ, AF540FGZ II, AF360FGZ, or AF360FGZ II.
- <sup>\*5</sup> Multiple AF540FGZ, AF540FGZ II, AF360FGZ, or AF360FGZ II units, or a combination of an AF540FGZ, AF540FGZ II, AF360FGZ, or AF360FGZ II unit and the built-in flash is required.

### ⚠ Caution

- Never press the **Q** button when any external flash unit is attached to the camera. The built-in flash will hit the external flash. If you want to use both at once, set the wireless mode or connect them using an extension cord.
- Flashes with the reversed polarity (the center contact on the hot shoe is minus) cannot be used due to the risk of damaging the camera and/or flash.
- Do not combine with accessories that have a different number of contacts, such as a Hot Shoe Grip, as a malfunction may occur.
- Combining with flashes from other manufacturers may cause equipment breakdown.

### 📝 Memo

- With the AF540FGZ, AF540FGZ II, AF360FGZ, or AF360FGZ II, you can use the high-speed sync flash to discharge the flash and take a picture at a shutter speed faster than 1/180 seconds. Select an exposure mode (such as **Tv**) which allows you to set the shutter speed.
- By using two external flashes (AF540FGZ, AF540FGZ II, AF360FGZ, or AF360FGZ II) or using the built-in flash with one or more external flashes, you can use the wireless mode to shoot in P-TTL flash mode without connecting the flash units with a cord. In this case, set the camera channel on the external flashes. The set channel can be checked on the status screen, Live View screen, LCD panel, and in the viewfinder.
- You can connect an external flash to the camera with a sync cord by using the X-sync socket. Remove the Sync socket 2P cap to connect a sync cord to the X-sync socket.

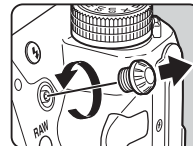

## Using the GPS Unit

The following functions are available when the optional GPS unit O-GPS1 is attached to this camera.

|                           |   |   |
|---------------------------|---|---|
| <b>Electronic Compass</b> | The current latitude, longitude, altitude, direction, and Coordinated Universal Time (UTC) are displayed.   |  |
| <b>ASTRO-TRACER</b>       | Tracks and captures celestial bodies. By matching the movement of the camera's built-in Shake Reduction unit with the movement of celestial bodies, celestial bodies can be captured as individual points even when shooting with a long exposure setting. (p.85) |   |
| <b>GPS Time Sync</b>      | Automatically adjusts the camera's date and time settings using information acquired from GPS satellites.   |   |

### Memo



- Refer to the manual of the GPS unit for details on how to attach the unit and information on the unit's functions.
- To display [Electronic Compass], refer to "Shooting Info Display" (p.12).

### Caution

- "Simple Navigation" cannot be used with this camera.

## Shooting Celestial Bodies (ASTROTRACER)



- 1 Set the mode dial to B.**
- 2 Select [GPS] in 2 menu and press .**  
The [GPS] screen appears.
- 3 Select [ASTROTRACER] and press .**  
The [ASTROTRACER] screen appears.

- 4 Set [Action in B Mode] to  and press .**



- 5 To set the desired exposure time, first set [Timed Exposure] to [ON].**

You can set the exposure time between 0'10" and 5'00" in [Exposure Time].

- 6 Press  three times.**

The camera returns to standby mode.

- 7 Press the shutter release button fully.**  
Shooting starts.

- 8 Press the shutter release button fully again.**

Shooting stops.

When [Timed Exposure] is enabled, shooting ends automatically after the set time has elapsed.





### Caution







- When ASTROTRACER is activated, the drive mode cannot be set to [Mirror Lock-up Shooting] and [Multi-exposure].

# Troubleshooting

## Memo

- In rare cases, the camera may not operate correctly due to static electricity. This can be remedied by taking the battery out and putting it back in again. If the camera operates correctly, it does not require any repairs.

| Problem                         | Cause  | Remedy   |
|---------------------------------|--|--|
| The camera does not turn on.    | Battery is not installed properly.   | Check the orientation of the battery.  |
|                                 | The battery power is low.  | Charge the battery.  |
| The shutter cannot be released. | The built-in flash is being charged.   | Wait until charging is finished.   |
|                                 | There is no available space on the memory card.  | Insert a memory card with available space or delete unwanted images.   |
|                                 | Data being processed.  | Wait until processing is finished.   |
|                                 | The lens aperture ring is set to a position other than <b>A</b>  | Set the lens aperture ring to the <b>A</b> position or select [Enable] in [27. Using Aperture Ring] of the <b>C4</b> menu. (p.83)  |
| Autofocus does not work.        | The subject is difficult to focus on.  | <b>AF</b> cannot work well for low-contrast objects (the sky, white walls, etc.), dark colors, intricate designs, rapidly-moving objects or scenery shot through a window or a net-like pattern.<br>Lock focus on another object located at the same distance as your subject, then aim at the target and take a picture.<br>Alternatively, use <b>MF</b> .                  |
|                                 | The subject is too close.  | Move away from the subject and take a picture.   |
| The focus cannot be locked.     | AF Mode of Live View is set to  . | Set [Contrast AF] to  ,  ,  or  . (p.44) |

| Problem  | Cause   | Remedy   |
|--|---|--|
| The built-in flash does not discharge.   | The flash mode is set to  or  . | When the flash mode is set to  or  , the flash will not discharge if the subject is bright.<br>Change the flash mode. (p.41) |
| The camera is not recognized when it is connected to a computer.                       | The USB connection mode is set to [PTP].  | Set [USB Connection] to [MSC] in the  2 menu.   |
| Dust or dirt particles appear in images.   | The CMOS sensor is dirty or dusty.  | Activate [Dust Removal] from the  4 menu. The Dust Removal function can be activated every time the camera is turned on and off.<br>Refer to "Sensor Cleaning" (p.87) if the problem persists.          |
| There are pixels in the monitor or captured images that do not light up or remain lit. | There are defective pixels in the CMOS sensor.  | Activate [Pixel Mapping] from the  4 menu.<br>It takes about 30 seconds to correct the defective pixels, so be sure to install a fully charged battery.   |



## Sensor Cleaning

### Detecting Dust on the CMOS Sensor (Dust Alert)

Dust Alert is the function that detects dust adhering to the CMOS sensor and visually displays the location of the dust. Make sure that the camera is in the following status.

- Attach a DA, DA L, FA J lens or a D FA, FA or F lens that has an **A** position, and set the aperture ring to the **A** position.
- Turn the Stills/Movie switch to .
- Set the focus mode switch to **AF**.

#### 1 Select [Dust Alert] in menu and press .

The [Dust Alert] screen appears.

#### 2 Fully display a white wall or other bright subject with no detail in the viewfinder and press the shutter release button fully.

After image processing is performed, the Dust Alert image appears.

If [The operation could not be completed correctly] appears, press  and take another picture.

#### 3 Check the sensor for dust.

Use  to display the Dust Alert image at full screen display.



#### 4 Press .

The Dust Alert image is saved and the  menu reappears.

#### Memo

- Only the latest Dust Alert image is saved to the SD1 slot memory card for approximately 30 minutes. If Sensor Cleaning is performed during this time, the Dust Alert image can be checked while cleaning the sensor. (If the SD1 slot is disabled, the image is not saved. You cannot check the image in playback mode.)

## Removing Dust with a Blower

Raise the mirror up and open the shutter when cleaning the CMOS sensor with a blower.

#### 1 Turn the camera off and remove the lens.

#### 2 Turn the camera on.

#### 3 Select [Sensor Cleaning] in menu and press .

The [Sensor Cleaning] screen appears.

#### 4 Select [Mirror Up] and press .

The mirror rises up.

If a Dust Alert image is saved, it appears.

#### 5 Clean the CMOS sensor with a blower.

#### 6 Turn the camera off.

The mirror automatically returns to its original position.

#### Caution

- Never use a spray blower or a blower with a brush. The CMOS sensor may be damaged. Do not wipe the CMOS sensor with a cloth.
- Do not put the tip of the blower inside the lens mount area. If the power is turned off, this may cause damage to the shutter, CMOS sensor and the mirror.
- When the battery level is low, the message [Not enough battery power remaining to clean sensor] is displayed on the monitor. Install a fully charged battery. If the battery capacity becomes low during cleaning, a warning beep will sound. In this case, stop cleaning immediately.

#### Memo

- Please contact your nearest service center for professional cleaning as the CMOS sensor is a precision part.
- You can use the optional Imagesensor Cleaning kit O-ICK1 when cleaning the CMOS sensor.

## Error Messages

| Error Messages                 | Description   |
|--------------------------------|---|
| Memory card full               | The memory card is full and no more images can be saved. Insert a new memory card or delete unwanted files.   |
| No image                       | There are no images that can be played back on the memory card.   |
| This image cannot be displayed | You are trying to play back an image in a format not supported by this camera. You may be able to play it back on a computer.   |
| No card in the camera          | There is no memory card inserted in the camera.   |
| Memory card error              | The memory card has a problem, and image capture and playback are impossible. You may be able to play it back on a computer.<br>Failed to initialize the Eye-Fi function when using the Eye-Fi card. Press <b>Q</b> . |
| Card is not formatted          | The memory card you have inserted is unformatted or has been previously used on another device and is not compatible with this camera. Use the card after formatting it with this camera.                             |
| Card is locked                 | The write-protect switch on the memory card you have inserted is locked. (p.102)  |
| This image cannot be magnified | You are trying to magnify an image that cannot be magnified.  |
| This image is protected        | You are trying to delete an image that is protected. Remove protection from the image. (p.75)   |

| Error Messages  | Description  |
|---|--|
| Not enough battery power remaining to activate Pixel Mapping                | Appears during Pixel Mapping, Sensor Cleaning, or when trying to update the firmware if the battery level is insufficient. Install a fully charged battery.  |
| Not enough battery power remaining to clean sensor                          |  |
| Not enough battery power remaining to update the firmware                   |  |
| Unable to update firmware. There is a problem with the firmware update file | Unable to update the firmware. The update file is damaged. Try downloading the update file again.  |
| Image folder cannot be created  | The maximum folder number (999) is being used, and no more images can be saved. Insert a new memory card or format the card.   |
| Unable to store image   | The image could not be saved because of a memory card error.   |
| The operation could not be completed correctly                              | The camera was unable to adjust the manual white balance. Try the operation again.   |
| No more images can be selected  | You are trying to select more than the maximum number of images for the following functions. <ul style="list-style-type: none"> <li>• Select &amp; Delete</li> <li>• Image Copy</li> <li>• Index</li> <li>• RAW Development</li> <li>• Protect</li> <li>• Eye-Fi Image Transfer</li> </ul> |
| No image can be processed   | There are no images that can be processed using the Digital Filter or RAW Development function.  |
| This image cannot be processed  | Appears when you try to perform Resize, Cropping, Digital Filter, Movie Edit, RAW Development, or Save as Manual WB for images captured with other cameras, or when you try to perform Resize or Cropping for minimum file size images.  |
| The camera failed to create an image  | The creation of an index print image failed.   |

| Error Messages  | Description  |
|---|--|
| This function is not available in the current mode          | You are trying to set a function that is not available for the exposure mode that is set.  |
| The camera will turn off to prevent damage from overheating | The camera will turn off because its internal temperature gets too hot. Leave the camera turned off until it has had time to cool down before turning on the camera again.                               |
| Set the Eye-Fi communication to "SELECT"                    | Images cannot be transferred when [Action Mode] is not set to [SELECT] in [Wireless Memory Card] of the  3 menu. (p.78) |
| Image not found   | There are no images that can be transferred when an Eye-Fi card is used.   |
| Cannot be selected  | This folder cannot be selected because the number of files exceeds the maximum number allowed.   |

# Main Specifications

## Model Description

|                 |  |
|-----------------|--|
| Type            | TTL autofocus, auto-exposure SLR digital camera with built-in retractable P-TTL flash          |
| Lens Mount      | PENTAX KAF2 bayonet mount (AF coupler, lens information contacts, K-mount with power contacts) |
| Compatible Lens | KAF3, KAF2 (power zoom compatible), KAF, KA mount lenses                                       |

## Image Capture Unit

|                               |  |
|-------------------------------|--|
| Image Sensor                  | Primary color filter, CMOS, Size: 23.5 × 15.6 (mm)                                     |
| Effective Pixels              | Approx. 24.35 megapixels   |
| Total Pixels                  | Approx. 24.71 megapixels   |
| Dust Removal                  | Image sensor cleaning using ultrasonic vibrations "DR II" with the Dust Alert function |
| Sensitivity (Standard Output) | ISO AUTO/100 to 51200 (EV steps can be set to 1 EV, 1/2 EV, or 1/3 EV)                 |
| Image Stabilizer              | Sensor-shift shake reduction (SR: Shake Reduction)                                     |
| AA Filter Simulator           | Moiré reduction using SR unit: Type1/Type2/OFF   |

## File Formats

|                   |   |
|-------------------|---|
| Recording Formats | RAW (PEF/DNG), JPEG (Exif 2.30), DCF 2.0 compliant  |
| Recorded Pixels   | JPEG:  (24M: 6016×4000),  (14M: 4608×3072),  (6M: 3072×2048),  (2M: 1920×1280)<br>RAW:  (24M: 6016×4000)      |
| Quality Level     | RAW (14bit): PEF, DNG<br>JPEG: ★★★ (Best), ★★ (Better), ★ (Good), RAW + JPEG simultaneous capturing available |
| Color Space       | sRGB, AdobeRGB  |
| Storage Media     | SD Memory Card, SDHC Memory Card, SDXC (UHS-I compatible) Memory Card, Eye-Fi card, Flucard                   |
| Dual Card Slots   | Sequential Use, Save to Both, Separate RAW/JPEG, Copying images between slots possible                        |
| Storage Folder    | Folder Name: Date (100_1018, 101_1019...) or a user-assigned name (default: PENTX)                            |
| Storage File      | File Name: user-assigned name (default: IMG#****)<br>File No.: Sequential Numbering, Reset                    |

## Viewfinder

|                    |  |
|--------------------|--|
| Type               | Pentaprism Finder  |
| Coverage (FOV)     | Approx. 100%   |
| Magnification      | Approx. 0.95× (50 mm F1.4 at infinity)   |
| Eye-Relief Length  | Approx. 20.5 mm (from the view window),<br>Approx. 22.3 mm (from the center of lens) |
| Diopter Adjustment | Approx. -2.5 to +1.5 m <sup>-1</sup>   |
| Focusing Screen    | Interchangeable Natural-Bright-Matte III focusing screen                             |

## Live View

|                    |   |
|--------------------|---|
| Type               | TTL method using CMOS image sensor  |
| Focusing Mechanism | Contrast detection (Face Detection, Tracking, Multiple AF Points, Select, Spot)<br>Focus Peaking: ON/OFF  |
| Display            | Field of view: approx. 100%, Magnified view (2×, 4×, 8×, 10×), Grid Display (4 × 4 Grid, Golden Section, Scale display), Histogram, Highlight Alert, Composition Adjustment |

## LCD Monitor

|            |   |
|------------|---|
| Type       | Wide viewing angle TFT color LCD with an AR coating and air gapless glass |
| Size       | 3.2 inches (aspect ratio 3:2)   |
| Dots       | Approx. 1037K dots  |
| Adjustment | Brightness, saturation and colors adjustable                              |

## White Balance

|                 |  |
|-----------------|--|
| Type            | Method using a combination of the CMOS image sensor and the light source detection sensor  |
| White Balance   | AUTO White Balance, Multi Auto White Balance, Daylight, Shade, Cloudy, Fluorescent Light (D: Daylight Color, N: Daylight White, W: Cool White, L: Warm White), Tungsten Light, Flash, <b>CTE</b> , Manual White Balance (up to 3 settings), Color Temperature (up to 3 settings), Copying the white balance settings of a captured image |
| Fine Adjustment | Adjustable ±7 steps on A-B axis and G-M axis   |

## Autofocus System

|                             |  |
|-----------------------------|--|
| Type                        | TTL: phase-matching autofocus  |
| Focus Sensor                | SAFOX 11, 27 points (25 cross type focus points in the center)   |
| Brightness Range            | EV -3 to 18 (ISO100, at normal temperature)  |
| AF Modes                    | Single AF ( <b>A.F.S.</b> ), Continuous AF ( <b>A.F.C.</b> ), Auto select AF ( <b>A.F.A.</b> )<br>Focus operation customizable |
| Focus Point Selection Modes | Spot, Select, Expanded Area AF (S, M, L), Zone Select, Auto (27 AF Points)   |
| AF Assist Light             | Dedicated LED AF assist light  |

## Exposure Control

|                 |   |
|-----------------|---|
| Type            | TTL open aperture metering using 86K pixel RGB sensor, Metering Modes: Multi-segment metering, Center-weighted metering, Spot metering                        |
| Metering Range  | EV -3 to 20 (ISO100 at 50mm F1.4)   |
| Exposure Modes  | Green, Program, Sensitivity Priority, Shutter Priority, Aperture Priority, Shutter & Aperture Priority, Manual, Bulb, Flash X-sync Speed, USER1, USER2, USER3 |
| EV Compensation | ±5 EV (1/2 EV steps or 1/3 EV steps can be selected)  |
| AE Lock         | Button type (timer-control: two times the meter operating time set in Custom Setting); long as the shutter button is halfway pressed.                         |

## Shutter

|               |   |
|---------------|---|
| Type          | Electronically controlled vertical-run focal plane shutter                                    |
| Shutter Speed | Auto: 1/8000 to 30 seconds, Manual: 1/8000 to 30 seconds (1/3 EV steps or 1/2 EV steps), Bulb |

## Drive Modes

|                |   |
|----------------|---|
| Mode Selection | Still image: Single frame, Continuous (H, M, L), Self-timer (12 sec., 2 sec.), Remote Control (immediately, 3 sec., continuous), Exposure Bracketing (2, 3, or 5 frames; available with Self-timer or Remote Control), Mirror Lock-up Shooting (available with Remote Control), Multi-exposure (available with Self-timer or Remote Control), Interval Shooting, Interval Composite<br>Movie: Remote Control, Interval Movie Record |
|----------------|---|

|                     |  |
|---------------------|--|
| Continuous Shooting | Max. approx. 8.3 fps, JPEG (L): ★★★ at Continuous H); up to approx. 60 frames, RAW: up to approx. 23 frames<br>Max. approx. 4.5 fps, JPEG (L): ★★★ at Continuous M); up to approx. 100 frames, RAW: up to approx. 32 frames<br>Max. approx. 3.0 fps, JPEG (L): ★★★ at Continuous L); up to approx. 200 frames, RAW: up to approx. 52 frames<br>*When the sensitivity is set to ISO100. |
| Multi-Exposure      | Composite Mode: Additive, Average, Bright<br>Number of Shots: 2 to 2000 images   |
| Interval Shooting   | Still image:<br>Interval: 2 sec. to 24 hr., Number of shots: 2 to 2000 images, Start Interval: Now, Set Time<br>Movie:<br>Recorded size:  /  /  , Interval: 2 sec. to 1 hr., Recording time: 14 sec. to 99 hr., Start Interval: Now, Set Time  |

## Built-in Flash



|                             |  |
|-----------------------------|--|
| Type                        | Built-in retractable P-TTL pop-up flash<br>Guide number: approx. 13 (ISO100/m)<br>Angle of view coverage: equivalent to 28mm lens in 35 mm format  |
| Flash Modes                 | Auto Flash Discharge (Green mode), Flash On, Red-eye Reduction, Slow-speed Sync, Trailing Curtain Sync., Manual Flash Discharge (FULL to 1/128)<br>High-speed sync and wireless sync are also available with a dedicated external flash. |
| Sync Speed                  | 1/180 seconds  |
| Flash Exposure Compensation | -2.0 to +1.0 EV  |

## Capture Functions

|                        |   |
|------------------------|---|
| Custom Image           | Bright, Natural, Portrait, Landscape, Vibrant, Radiant, Muted, Bleach Bypass, Reversal Film, Monochrome, Cross Processing |
| Cross Processing       | Random, Preset 1-3, Favorite 1-3  |
| Noise Reduction        | Slow Shutter Speed NR, High-ISO NR  |
| Dynamic Range Settings | Highlight Correction, Shadow Correction   |
| Lens Correction        | Distortion Correction, Lateral Chromatic Aberration Correction, Peripheral Illumination Correction                        |

|                        |   |
|------------------------|---|
| Digital Filter         | Extract Color, Toy Camera, Retro, High Contrast, Shading, Invert Color, Unicolor Bold, Bold Monochrome                                    |
| HDR Capture            | Auto, Type1, Type2, Type3<br>Exposure Bracket Value adjustable<br>Auto Align (automatic composition correction)                           |
| Horizon Correction     | SR On: corrects up to 1 degree, SR Off: corrects up to 2 degrees  |
| Composition Adjustment | Adjustment range of $\pm 1.5$ mm up, down, left or right ( $\pm 1$ mm when rotated); rotating range of $\pm 1$ degree                     |
| Electronic Level       | Displayed in viewfinder and LCD panel (horizontal direction only); displayed on LCD monitor (horizontal direction and vertical direction) |

### Movie



|  |   |
|--|---|
| File Formats   | MPEG-4 AVC/H.264 (MOV)<br>*Motion JPEG (AVI) for Interval Movie Record  |
| Recorded Pixels  |  (1920×1080, 60i/50i/30p/25p/24p)<br> (1280×720, 60p/50p/30p/25p/24p) |
| Sound  | Built-in monaural microphone, external microphone (stereo recording compatible)<br>Recording Sound Level adjustable   |
| Recording Time   | Up to 25 minutes; automatically stops recording if the internal temperature of the camera becomes high.   |
| Custom Image   | Bright, Natural, Portrait, Landscape, Vibrant, Radiant, Muted, Bleach Bypass, Reversal Film, Monochrome, Cross Processing   |
| Cross Processing   | Random, Preset 1-3, Favorite 1-3  |
| Digital Filter   | Extract Color, Toy Camera, Retro, High Contrast, Shading, Invert Color, Unicolor Bold, Bold Monochrome  |
| HDR Capture<br>*available only for Interval Movie Record | Auto, Type1, Type2, Type3,<br>Exposure Bracket Value adjustable   |

### Playback Functions

|               |  |
|---------------|--|
| Playback View | Single frame, multi-image display (6, 12, 20, 35, 80 thumbnails), display magnification (up to 16×, 100% display and quick zoom), image rotation, histogram (Y histogram, RGB histogram), highlight alert, auto image rotation, detailed information display, copyright information (photographer, copyright holder), folder display, calendar filmstrip display, slideshow, GPS (latitude, longitude, altitude, Coordinated Universal Time (UTC)) |
|---------------|--|

|                 |   |
|-----------------|---|
| Delete          | Single image, all images, select & delete, folder, instant review image   |
| Digital Filter  | Base Parameter Adj, Extract Color, Toy Camera, Retro, High Contrast, Shading, Invert Color, Unicolor Bold, Bold Monochrome, Tone Expansion, Sketch, Water Color, Pastel, Posterization, Miniature, Soft, Starburst, Fish-eye, Slim  |
| RAW Development | Development options: Select single image, Select multiple images, Select a folder<br>Development parameters: File Format (JPEG/TIFF), Aspect Ratio, JPEG Recorded Pixels, JPEG Quality, Color Space, Distortion Correction, Lat-Chromatic-Ab Adj, Peripheral Illumin. Corr., Color Fringe Correction, Digital Filter, HDR, White Balance, Custom Image, Sensitivity, High-ISO NR, Shadow Correction |
| Edit            | Color Moiré Correction, Resize, Cropping (aspect ratio can be changed and tilt correction is available), Index, Movie Edit (dividing a movie file and deleting unwanted segments), Capturing a JPEG still picture from a movie, Save RAW Data, Image Copy, Eye-Fi Image Transfer  |

### Customization

|   |  |
|---|--|
| USER Mode                                   | Up to 3 settings can be saved.   |
| Custom Functions                            | 27 items   |
| Mode Memory                                 | 11 items   |
| E-Dial Programming/<br>Button Communication |  button: One Push File Format, Exposure Bracketing, Optical Preview, Digital Preview, Shake Reduction, LCD Panel Illumination<br> button: Enable AF1, Enable AF2, Cancel AF<br>E-dials (front/rear): customizable to each exposure mode. |
| Text Size                                   | Standard, Large  |
| World Time                                  | World Time settings for 75 cities (28 time zones)  |
| Language                                    | (Depends on the country or region)   |
| AF Fine Adjustment                          | $\pm 10$ steps, adjustment for all lenses or individual lenses (up to 20 can be saved)   |
| Copyright Information                       | Names of "Photographer" and "Copyright Holder" are embedded to the image file.<br>Revision history can be checked using the provided software.   |

### Power Supply

|              |   |
|--------------|---|
| Battery Type | Rechargeable Lithium-ion Battery D-LI90 |
|--------------|---|

|              |   |
|--------------|---|
| AC Adapter   | AC Adapter Kit K-AC132 (optional)   |
| Battery Life | Number of recordable images:<br>(with 50% flash usage): approx. 560 images,<br>(without flash usage): approx. 720 images<br>Playback time: approx. 370 minutes<br>* Tested in compliance with CIPA standard using a fully charged lithium-ion battery under the temperature of 23°C.<br>Actual results may vary depending on the shooting conditions/circumstances. |

#### Interfaces

|                 |  |
|-----------------|--|
| Connection Port | USB 3.0 (micro B), external power supply terminal, cable switch terminal, X-sync socket, HDMI output terminal (type D), stereo microphone input terminal, headphone terminal |
| USB Connection  | MSC/PTP  |

#### Dimensions and Weight

|            |   |
|------------|---|
| Dimensions | Approx. 131.5 mm (W) × 100 mm (H) × 77.5 mm (D) (excluding protrusions)                   |
| Weight     | Approx. 800 g (Including dedicated battery and SD Memory Card), Approx. 715 g (body only) |

#### Accessories

|          |  |
|----------|--|
| Included | Strap O-ST132, ME Viewfinder Cap, Rechargeable Lithium-ion Battery D-LI90, Battery Charger D-BC90, AC plug cord, Software (CD-ROM) S-SW140 <Mounted to the camera> Eyecup Fs, Hot shoe cover Fx, Sync socket 2P cap, Body mount cover, Battery grip terminal cover |
| Software | Digital Camera Utility 5   |

#### Optional Accessories

|          |  |
|----------|--|
| GPS Unit | O-GPS1: GPS information (latitude, longitude, altitude, time (UTC)), Electronic Compass, ASTROTRACER |
| Flucard  | Remote capture, image browsing   |

## Approximate Image Storage Capacity and Playback Time

(When using the fully charged battery)

| Battery | Temperature | Normal Shooting | Flash Photography |          | Playback Time |
|---------|-------------|-----------------|-------------------|----------|---------------|
|         |             |                 | 50% Use           | 100% Use |               |
| D-LI90  | 23°C        | 720             | 560               | 460      | 370 minutes   |

- The image storage capacity (normal recording and flash use 50%) is based on measuring conditions in accordance with CIPA standards, while other data is based on our measuring conditions. Some deviation from the above figures may occur in actual use depending on the selected capture mode and shooting conditions.

## Approximate Image Storage Capacity by Size

(When using a 2 GB memory card)

| Recorded Pixels | JPEG Quality |      |      | RAW |
|-----------------|--------------|------|------|-----|
|                 | ★★★          | ★★   | ★    |     |
| 24M             | 111          | 252  | 495  | 37  |
| 14M             | 189          | 423  | 819  | –   |
| 6M              | 418          | 917  | 1707 | –   |
| 2M              | 1024         | 2119 | 3615 | –   |

- The number of storable images may vary depending on the subject, shooting conditions, selected capture mode and memory card, etc.

## List of World Time Cities

The following cities can be set as Hometown and Destination.

| Region                           | City  |
|----------------------------------|---|
| <b>North America</b>             | Honolulu, Anchorage, Vancouver, San Francisco, Los Angeles, Calgary, Denver, Chicago, Miami, Toronto, New York, Halifax                                 |
| <b>Central and South America</b> | Mexico City, Lima, Santiago, Caracas, Buenos Aires, Sao Paulo, Rio de Janeiro   |
| <b>Europe</b>                    | Lisbon, Madrid, London, Paris, Amsterdam, Milan, Rome, Copenhagen, Berlin, Prague, Stockholm, Budapest, Warsaw, Athens, Helsinki, Moscow                |
| <b>Africa/ West Asia</b>         | Dakar, Algiers, Johannesburg, Istanbul, Cairo, Jerusalem, Nairobi, Jeddah, Tehran, Dubai, Karachi, Kabul, Male, Delhi, Colombo, Kathmandu, Dacca        |
| <b>East Asia</b>                 | Yangon, Bangkok, Kuala Lumpur, Vientiane, Singapore, Phnom Penh, Ho chi Minh, Jakarta, Hong Kong, Beijing, Shanghai, Manila, Taipei, Seoul, Tokyo, Guam |
| <b>Oceania</b>                   | Perth, Adelaide, Sydney, Noumea, Wellington, Auckland, Pago Pago  |

## Operating Environment for USB Connection and Provided Software

With the provided software “Digital Camera Utility 5”, you can develop RAW files, make color adjustments, or check shooting information on a computer. Install the software from the provided CD-ROM (S-SW140).

We recommend the following system requirements to connect the camera to a computer or to use the software.

### Windows

|                |  |
|----------------|--|
| <b>OS</b>      | Windows 8 (32 bit/64 bit) / Windows 7 (32 bit/64 bit) / Windows Vista (32 bit/64 bit), Windows XP SP3 (32 bit)   |
| <b>CPU</b>     | Intel Core 2 Duo or higher   |
| <b>RAM</b>     | 2 GB or more   |
| <b>HDD</b>     | Program installation and start-up: 100 MB or more of available space<br>Image file saving: Approximately 10 MB per file (JPEG) / approximately 30 MB (RAW) |
| <b>Monitor</b> | 1280×1024 dots, 24 bit full-color or higher  |

### Macintosh







|                |   |
|----------------|---|
| <b>OS</b>      | Mac OS X 10.8 / 10.7 / 10.6   |
| <b>CPU</b>     | Intel Core 2 Duo or higher  |
| <b>RAM</b>     | 2 GB or more  |
| <b>HDD</b>     | Program installation and start-up: 100 MB or more of available space<br>Image file saving: Approximately 10 MB per file (JPEG) or approximately 30 MB (RAW) |
| <b>Monitor</b> | 1280×1024 dots, 24 bit full-color or higher   |



## Memo

- QuickTime is required to play back movies transferred to a computer. You can download it from the following site:  
<http://www.apple.com/quicktime/download/>

## Symbols

|   |    |
|---|----|
|  menu ..... | 18 |
|  menu ..... | 21 |
|  menu ..... | 21 |
|  menu ..... | 22 |
| <b>C</b> menu .....   | 23 |
|  mode ..... | 38 |
|  mode ..... | 31 |

## Numerics

|                                |    |
|--------------------------------|----|
| 1st Frame Action in AF.C ..... | 43 |
|--------------------------------|----|

## A

|  |        |
|--|--------|
| AA (Anti-Aliasing) Filter Simulator .....  | 58     |
| AC adapter .....                           | 28     |
| Action in AF.C Continuous .....            | 43     |
| AE Metering .....                          | 40     |
| AE-L with AF Locked .....                  | 23     |
| AF area .....                              | 45     |
| AF Assist Light .....                      | 7, 43  |
| AF Button .....                            | 71     |
| AF coupler .....                           | 7      |
| AF Fine Adjustment .....                   | 45     |
| AF frame .....                             | 32, 33 |
| AF Mode .....                              | 43, 44 |
| AF Point .....                             | 44     |
| AF with Remote Control ..                  | 49     |
| <b>AFA</b> .....                           | 43     |
| <b>AFC</b> .....                           | 43     |
| <b>AFS</b> .....                           | 43     |
| AF.S Setting .....                         | 43     |
| Aperture Priority Automatic Exposure ..... | 36     |
| Aperture value .....                       | 36     |

|                             |        |
|-----------------------------|--------|
| Aspect Ratio .....          | 66, 69 |
| ASTROTRACER .....           | 85     |
| Auto (AF point) .....       | 44     |
| Auto EV Compensation ...    | 23     |
| Auto Flash Discharge .....  | 41     |
| Auto Image Rotation .....   | 62     |
| AUTO ISO Parameters .....   | 39     |
| Auto mode (AF Mode) .....   | 43     |
| Auto Power Off .....        | 29     |
| Auto Resize .....           | 78     |
| Auto Screen Rotation .....  | 12     |
| Autofocus .....             | 44     |
| AV device .....             | 63     |
| <b>Av</b> mode .....        | 36     |
| AWB in Tungsten Light ..... | 53     |

## B

|   |        |
|---|--------|
| <b>B</b> mode .....                       | 36     |
| Base Parameter Adj (Digital Filter) ..... | 66     |
| Battery .....                             | 26     |
| Battery grip contacts .....               | 7      |
| Bleach Bypass (Custom Image) .....        | 54     |
| Bold Monochrome (Digital Filter) .....    | 56, 66 |
| Bracketing Order .....                    | 49     |
| Bright (Custom Image) .....               | 54     |
| Brightness adjustment .....               | 57     |
| Brightness histogram .....                | 13     |
| Built-in flash .....                      | 41     |
| Bulb (B) Mode Options ...                 | 23     |
| Bulb Exposure .....                       | 36     |
| Button Customization .....                | 71     |
| Buttons .....                             | 8      |

## C

|                                       |        |
|---------------------------------------|--------|
| Cable switch terminal .....           | 7      |
| Calendar Filmstrip Display .....      | 61     |
| Capture mode .....                    | 36     |
| Card access lamp .....                | 7      |
| Catch-in Focus .....                  | 24     |
| Center-weighted metering .....        | 40     |
| Changing the image size .....         | 65     |
| Charging the battery .....            | 26     |
| City names .....                      | 29, 94 |
| Color Fringe Correction ...           | 69     |
| Color Moiré Correction ...            | 66     |
| Color Space .....                     | 24, 77 |
| Color Temperature .....               | 54     |
| Color Temperature Steps .....         | 53     |
| Composition Adjustment .....          | 58     |
| Computer .....                        | 64     |
| Continuous mode (AF Mode) .....       | 43     |
| Continuous playback .....             | 62     |
| Continuous Shooting .....             | 48     |
| Contrast .....                        | 55     |
| Contrast AF .....                     | 44     |
| Contrast detection AF .....           | 42     |
| Control panel .....                   | 11, 16 |
| Copyright Holder .....                | 78     |
| Copyright Information .....           | 78     |
| Correcting images .....               | 57     |
| Create New Folder .....               | 76     |
| Cropping .....                        | 65     |
| Cross Processing (Custom Image) ..... | 54     |

## CTE

|                           |    |
|---------------------------|----|
| CTE .....                 | 52 |
| Custom Image .....        | 54 |
| Custom Setting menu ..... | 23 |
| Customization .....       | 71 |

## D

|                                      |        |
|--------------------------------------|--------|
| Date Adjustment .....                | 30     |
| DC input terminal .....              | 28     |
| Delete .....                         | 34     |
| Delete All Images .....              | 21     |
| Destination .....                    | 74     |
| Detailed Information Display .....   | 13     |
| Developing RAW images .....          | 69     |
| Dial indicator .....                 | 32     |
| Digital Camera Utility 5 ...         | 94     |
| Digital Filter .....                 | 56, 66 |
| Digital Preview .....                | 46     |
| Diopter adjustment dial ...          | 14     |
| Direct keys .....                    | 16     |
| Display Color .....                  | 22     |
| Display style selection screen ..... | 60     |
| Distortion Correction .....          | 57     |
| DNG .....                            | 35     |
| D-Range Settings .....               | 57     |
| Drive Mode .....                     | 47     |
| DST (daylight saving time) .....     | 30, 74 |
| Dust Alert .....                     | 87     |
| Dust Removal .....                   | 86     |
| Dynamic range .....                  | 57     |

## E

|                          |    |
|--------------------------|----|
| E-dial operation .....   | 71 |
| E-Dial Programming ..... | 71 |

|                                |        |
|--------------------------------|--------|
| Editing images .....           | 65     |
| Electronic Compass ..          | 12, 85 |
| Electronic Level .....         | 12, 15 |
| Error messages .....           | 88     |
| EV Compensation .....          | 37     |
| EV Steps .....                 | 37     |
| Expanded Area AF (AF point)    |        |
| .....                          | 44     |
| Exposure Bracketing .....      | 49     |
| Exposure Mode .....            | 36, 74 |
| Exposure Setting .....         | 38     |
| External flash .....           | 84     |
| Extract Color (Digital Filter) |        |
| .....                          | 56, 66 |
| Eye-Fi card .....              | 28, 78 |
| Eye-Fi Image Transfer.....     | 78     |
| <b>F</b>                       |        |
| Face Detection (Contrast AF)   |        |
| .....                          | 44     |
| File Format .....              | 35     |
| File Name .....                | 77     |
| File No. ....                  | 77     |
| Filter .....                   | 56, 66 |
| Firmware .....                 | 23     |
| Firmware Info/Options .....    | 23     |
| Fish-eye (Digital Filter) .... | 66     |
| Flash .....                    | 84     |
| Flash compensation .....       | 41     |
| Flash On .....                 | 41     |
| Flash X-sync Speed .....       | 36     |
| Flicker Reduction .....        | 22     |
| Flucard .....                  | 28, 78 |
| Focus indicator .....          | 32     |
| Focus Method .....             | 42     |
| Focus mode switch....          | 31, 42 |
| Focus Peaking .....            | 45     |
| Folder display .....           | 61     |
| Folder Name .....              | 76     |
| Format .....                   | 31     |
| Framerate .....                | 35     |

|                                |        |
|--------------------------------|--------|
| <b>G</b>                       |        |
| GPS Time Sync .....            | 85     |
| GPS unit .....                 | 85     |
| Green button operation ...     | 71     |
| Green mode .....               | 31     |
| Grid Display .....             | 19     |
| Guide Display .....            | 22, 32 |
| Guide number .....             | 42     |
| <b>H</b>                       |        |
| HDMI Out .....                 | 63     |
| HDR Capture .....              | 57     |
| Headphones .....               | 38     |
| High Contrast (Digital Filter) |        |
| .....                          | 56, 66 |
| High-ISO NR .....              | 40     |
| Highlight Alert .....          | 19, 21 |
| Highlight Correction .....     | 57     |
| Histogram Display ....         | 13, 19 |
| Hold AF Status .....           | 43     |
| Hometown .....                 | 29, 74 |
| Horizon Correction .....       | 19     |
| Hot shoe .....                 | 7      |
| <b>I</b>                       |        |
| Image Capture Settings... ..   | 35     |
| Image Copy .....               | 65     |
| Image finishing touch .....    | 54     |
| Image plane indicator .....    | 7      |
| Image storage capacity ...     | 93     |
| Index .....                    | 68     |
| Initial settings .....         | 29     |
| Initializing a memory card     |        |
| .....                          | 31     |
| Input Focal Length .....       | 82     |
| Instant Review .....           | 19, 32 |
| Interval Composite .....       | 51     |
| Interval Movie Record ....     | 52     |
| Interval Shooting .....        | 51     |
| Invert Color (Digital Filter)  |        |
| .....                          | 56, 66 |

|                              |            |
|------------------------------|------------|
| ISO AUTO Setting .....       | 39         |
| ISO sensitivity .....        | 39         |
| <b>J</b>                     |            |
| JPEG .....                   | 35         |
| <b>K</b>                     |            |
| Kelvin .....                 | 54         |
| <b>L</b>                     |            |
| Landscape (Custom Image)     |            |
| .....                        | 54         |
| Language setting .....       | 29         |
| Language/言語 .....            | 29         |
| Lat-Chromatic-Ab Adj .....   | 57         |
| LCD Display .....            | 22         |
| LCD Display Settings .....   | 22         |
| LCD Panel .....              | 15         |
| LCD Panel Illumination       |            |
| .....                        | 15, 71     |
| Lens .....                   | 25, 81     |
| Lens Correction .....        | 57         |
| Lens focal length .....      | 82         |
| Lens information contacts    |            |
| .....                        | 7          |
| Lens mount index .....       | 7, 25      |
| Lens unlock button .....     | 25         |
| Lens with aperture ring .... | 83         |
| Link AE and AF Point .....   | 40         |
| Live View .....              | 10, 19, 33 |
| <b>M</b>                     |            |
| M mode .....                 | 36         |
| Macintosh .....              | 94         |
| Magnify .....                | 36         |
| Manual Exposure .....        | 34         |
| Manual Flash Discharge..     | 41         |
| Manual White Balance ....    | 53         |
| ME viewfinder cap .....      | 47         |
| Memory .....                 | 75         |
| Memory card .....            | 28         |

|                               |       |
|-------------------------------|-------|
| Memory Card Options .....     | 35    |
| Menus .....                   | 17    |
| Meter Operating Time.....     | 23    |
| Microphone .....              | 7, 38 |
| Miniature (Digital Filter) .. | 66    |
| Mired .....                   | 54    |
| Mirror .....                  | 7     |
| Mirror Lock-up Shooting ..    | 50    |
| Mode dial .....               | 32    |
| Mode dial lock button.....    | 32    |
| Mode dial lock release lever  |       |
| .....                         | 32    |
| Monitor .....                 | 9     |
| Monochrome (Custom            |       |
| Image) .....                  | 54    |
| Motion JPEG .....             | 52    |
| Movie Capture Settings ...    | 35    |
| Movie Edit .....              | 68    |
| Movie menu .....              | 21    |
| Movie mode .....              | 38    |
| Movie SR .....                | 21    |
| MSC .....                     | 86    |
| Multi-exposure .....          | 50    |
| Multi-image display .....     | 60    |
| Multiple AF Points (Contrast  |       |
| AF) .....                     | 44    |
| Multi-segment metering ...    | 40    |
| Muted (Custom Image)....      | 54    |
| <b>N</b>                      |       |
| Natural (Custom Image) ..     | 54    |
| Noise Reduction .....         | 40    |
| <b>O</b>                      |       |
| One Push File Format .....    | 72    |
| One-Push Bracketing .....     | 49    |
| Operating environment .....   | 94    |
| Optical Preview .....         | 46    |
| <b>P</b>                      |       |
| P mode .....                  | 36    |

|  |        |   |        |  |        |                                       |        |
|--|--------|---|--------|--|--------|---------------------------------------|--------|
| Pastel (Digital Filter) .....                | 66     | Recording Sound Level .....                   | 21, 38 | Sharpness .....                                      | 55     | Tone Expansion (Digital Filter) ..... | 66     |
| PEF .....                                    | 35     | Red-eye Reduction.....                        | 41     | Shooting .....                                       | 31     | Toy Camera (Digital Filter) .....     | 56, 66 |
| Peripheral Illumination Correction .....     | 57     | Release While Charging .....                  | 41, 48 | Shooting Info Display selection screen .....         | 12     | Tracking (Contrast AF) ....           | 44     |
| Photographer.....                            | 78     | Remote control receiver ....                  | 7      | Shutter & Aperture Priority Automatic Exposure ..... | 36     | Trailing Curtain Sync .....           | 41     |
| Pixel Mapping.....                           | 86     | Remote Control shooting .....                 | 49     | Shutter Priority Automatic Exposure .....            | 36     | TTL phase-matching autofocus .....    | 42     |
| Playback Info Display selection screen ..... | 12     | Reset .....                                   | 23, 24 | Shutter speed .....                                  | 36     | <b>Tv</b> mode .....                  | 36     |
| Playback menu .....                          | 21     | Resize .....                                  | 65     | Single image display .....                           | 12, 34 |                                       |        |
| Playback mode .....                          | 34     | Retro (Digital Filter) ...                    | 56, 66 | Single mode (AF Mode) ..                             | 43     | <b>U</b>                              |        |
| Playback mode palette ....                   | 59     | Reversal Film (Custom Image) .....            | 54     | Sketch (Digital Filter) .....                        | 66     | Unicolor Bold (Digital Filter) .....  | 56, 66 |
| Portrait (Custom Image) ..                   | 54     | RGB Histogram Display ..                      | 13     | Slideshow .....                                      | 62     | Updating firmware .....               | 23     |
| Posterization (Digital Filter) .....         | 66     | Rotating images .....                         | 62     | Slim (Digital Filter) .....                          | 66     | USB Connection .....                  | 86, 94 |
| Power .....                                  | 29     | Rotation Direction .....                      | 71     | Slow Shutter Speed NR ..                             | 19     | USB terminal .....                    | 64     |
| Preview .....                                | 46     |   |        | Slow-speed Sync .....                                | 41     | USER mode.....                        | 73     |
| Preview Dial .....                           | 46, 71 | <b>S</b>                                      |        | Soft (Digital Filter).....                           | 66     | Using aperture ring.....              | 83     |
| Processing images .....                      | 65     | Save as Manual WB .....                       | 53     | Sound .....  | 38     |                                       |        |
| Program Automatic Exposure .....             | 36     | Save Cross Processing ...                     | 55     | Sound Effects .....                                  | 22     | <b>V</b>                              |        |
| Program Line .....                           | 37     | Save Menu Location .....                      | 17     | Speaker .....  | 7      | Vertical position .....               | 12     |
| Protect .....                                | 75     | Save RAW Data .....                           | 19, 34 | Specifications .....                                 | 90     | Vibrant (Custom Image) ..             | 54     |
| Protect All Images .....                     | 21     | Save Rotation Info .....                      | 62     | Spot (AF point) .....                                | 44     | Viewfinder.....                       | 14, 32 |
| Provided software.....                       | 94     | SD Memory Card.....                           | 28     | Spot (Contrast AF) .....                             | 44     | Volume label.....                     | 31     |
| PTP .....                                    | 86     | Select (AF point).....                        | 44     | Spot metering .....                                  | 40     |                                       |        |
|  |        | Select (Contrast AF).....                     | 44     | Standby mode .....                                   | 9      | <b>W</b>                              |        |
| <b>Q</b>                                     |        | Select & Delete.....                          | 60     | Starburst (Digital Filter)...                        | 66     | WARRANTY POLICY....                   | 104    |
| Quality .....                                | 35     | Select Battery .....                          | 27     | Status Screen .....                                  | 10     | Water Color (Digital Filter) .....    | 66     |
| Quick Zoom .....                             | 21     | Self-timer lamp .....                         | 7      | Stills/Movie switch .....                            | 31     | WB Adjustable Range ....              | 53     |
| QuickTime .....                              | 95     | Self-timer shooting .....                     | 48     | Strap .....  | 25     | WB When Using Flash ....              | 53     |
|  |        | Sensitivity .....                             | 39, 69 | Superimpose AF Area ....                             | 14     | White Balance .....                   | 52     |
|  |        | Sensitivity Priority Automatic Exposure ..... | 36     | <b>Sv</b> mode .....                                 | 36     | Wi-Fi transmission .....              | 78     |
| <b>R</b>                                     |        | Sensitivity Steps .....                       | 39     |  |        | Windows .....                         | 94     |
| Radiant (Custom Image) .....                 | 54     | Sensor Cleaning .....                         | 87     | <b>T</b>   |        | Wireless (Flash).....                 | 41     |
| RAW .....                                    | 35     | Sequential Numbering.....                     | 77     | <b>TAv</b> mode.....                                 | 36     | Wireless LAN.....                     | 78     |
| RAW Development.....                         | 69     | Set-up menus .....                            | 22     | Text input.....                                      | 73     | Wireless Memory Card ....             | 78     |
| RAW/Fx Button.....                           | 71     | Shading (Digital Filter) .....                | 56, 66 | Text Size .....                                      | 30     | World Time .....                      | 74     |
| Rec. Mode menu .....                         | 18     | Shadow Correction.....                        | 57     | Thumbnail display ....                               | 34, 60 |                                       |        |
| Recordable time .....                        | 38     | Shake Reduction .....                         | 19     | Time Setting .....                                   | 74     | <b>X</b>                              |        |
| Recorded Pixels .....                        | 35     |   |        |  |        | <b>X</b> mode.....                    | 36     |

X-sync socket ..... 84

## **Z**

Zone Select (AF point) .... 44

## For Using Your Camera Safely

We have paid close attention to the safety of this camera. When using this camera, we request your special attention regarding items marked with the following symbols.



### Warning

This symbol indicates that ignoring this item could cause serious personal injuries.



### Caution

This symbol indicates that ignoring this item could cause minor or medium personal injuries, or loss of property.



### Warning

- Do not disassemble or modify the camera. High voltage areas are present inside the camera, with the risk of electric shock.
- If the camera interior is exposed due to dropping or otherwise damaging the camera, never touch the exposed portion. There is a risk of electric shock.
- Do not aim the camera at the sun or other strong light sources when taking pictures or leave the camera sitting in direct sunlight with the lens cap off. Doing so may cause the camera to malfunction or cause a fire.
- Do not look at the sun or other strong light sources through the lens. Doing so may lead to a loss of eyesight or cause vision to be impaired.
- If any irregularities occur during use, such as smoke or a strange odor, stop use immediately, remove the battery or the AC adapter, and contact your nearest service center. Continued use can cause a fire or electrical shock.



### Caution

- Do not place your finger over the flash when discharging the flash. You may burn yourself.
- Do not cover the flash with clothing when discharging the flash. Discoloration may occur.
- Some portions of the camera heat up during use. There is a risk of low temperature burns when holding such portions for long periods.
- Should the monitor be damaged, be careful of glass fragments. Also, be careful not to allow the liquid crystal to get on your skin or in your eyes or mouth.
- Depending on your individual factors or physical condition, the use of the camera may cause itching, rashes or blisters. In case of any abnormality, stop using the camera and get medical attention immediately.

## About the Battery Charger and AC Adapter



### Warning

- Always use the battery charger and AC adapter exclusively developed for this camera, with the specified power and voltage. Using a battery charger or AC adapter not exclusive to this camera, or using the exclusive battery charger or AC adapter with an unspecified power or voltage can cause a fire, electric shock, or camera breakdown. The specified voltage is 100 - 240V AC.
- Do not disassemble or modify the product. This can cause a fire or electrical shock.
- If the generation of smoke or strange odor from the product or other abnormality occurs, immediately discontinue using and consult your nearest service center. Continued use can cause a fire or electrical shock.
- If water should happen to get inside the product, consult your nearest service center. Continued use can cause a fire or electrical shock.
- If you see a lightning flash or hear thunder during use of the battery charger or AC adapter, unplug the power plug and discontinue use. Continued use can cause damage to the product, fire or electrical shock.
- Wipe off the power plug if it should become covered with dust. Accumulated dust may cause a fire.
- To reduce the risk of hazards, use only CSA/UL certified power supply cord set, cord is Type SPT-2 or heavier, minimum NO.18 AWG copper, one end with a molded-on male attachment plug cap (with a specified NEMA configuration), and the other is provided with a molded-on female connector body (with a specified IEC nonindustrial type configuration) or the equivalent.



### Caution

- Do not place or drop heavy objects on or forcefully bend the AC plug cord. Doing so may damage the cord. Should the AC plug cord be damaged, consult your nearest service center.
- Do not touch or short-circuit the terminal area of the AC plug cord while the cord is plugged in.
- Do not handle the power plug with wet hands. This can cause an electric shock.
- Do not drop the product, or subject it to violent impact. This can cause the product to breakdown.
- Do not use the battery charger D-BC90 to charge batteries other than the rechargeable lithium-ion battery D-L190. Attempting to charge other types of batteries may cause an explosion or heating, or may damage the battery charger.

## About the Rechargeable Lithium-ion Battery

### Warning

- If any leakage from the battery should come in contact with your eyes, do not rub them. Flush your eyes with clean water and get medical attention immediately.

### Caution

- Only use the specified battery with this camera. Use of other batteries may cause an explosion or fire.
- Do not disassemble the battery. Disassembling the battery may cause an explosion or leakage.
- Remove the battery from the camera immediately if it becomes hot or begins to smoke. Be careful not to burn yourself during removal.
- Keep wires, hairpins, and other metal objects away from the + and - contacts of the battery.
- Do not short the battery or dispose of the battery in fire. This can cause an explosion or fire.
- If any leakage from the battery should come in contact with skin or clothing, it may cause irritation to the skin.
- Wash the affected areas thoroughly with water.

Precautions for D-LI90 Battery Usage:

USE SPECIFIED CHARGER ONLY.

- RISK OF FIRE AND BURNS.

- DO NOT INCINERATE.

- DO NOT DISASSEMBLE.

- DO NOT SHORT CIRCUIT.

- DO NOT EXPOSE TO HIGH TEMP. (140°F / 60°C)

- SEE MANUAL.

## Keep the Camera and its Accessories out of the Reach of Small Children

### Warning

- Do not place the camera and its accessories within the reach of small children.
  1. If the product falls or is operated accidentally, it may cause serious personal injuries.
  2. Wrapping the strap around a neck may cause suffocation.
  3. To avoid the risk of a small accessory such as the battery or memory cards from being swallowed by mistake, keep them out of the reach of small children. Seek medical attention immediately if an accessory is accidentally swallowed.

## Care to be Taken During Handling

### Before Using Your Camera

- When traveling, take the Worldwide Service Network listing that is included in the package. This will be useful if you experience problems abroad.
- When the camera has not been used for a long time, confirm that it is still working properly, particularly prior to taking important pictures (such as at a wedding or when traveling). Contents of the recording cannot be guaranteed if recording, playback or transferring your data to a computer, etc. is not possible due to a malfunction of your camera or recording media (memory cards), etc.

### About the Battery and Charger

- To keep the battery in optimum condition, avoid storing it in a fully charged state or in high temperatures.
- If the battery is left inserted and the camera is not used for a long time, the battery will over-discharge and shorten the battery's life.
- Charging the battery a day before use or on the day of use is recommended.
- The AC plug cord provided with this camera is developed exclusively for the battery charger D-BC90. Do not use it with other devices.

### Precautions on Carrying and Using Your Camera

- Do not subject the camera to high temperatures or high humidity. Do not leave the camera in a vehicle, as the temperature can get very high.
- Do not subject the camera to strong vibrations, shocks, or pressure. Use a cushion to protect the camera from vibrations of motorcycles, automobiles, or ships.
- The temperature range for camera use is -10°C to 40°C (14°F to 104°F).
- The monitor may appear black at high temperatures, but will return to normal at normal temperatures.
- The monitor may respond more slowly at low temperatures. This is due to liquid crystal properties, and is not a malfunction.
- Sudden temperature changes will cause condensation on the inside and outside of the camera. Place the camera in your bag or a plastic bag, and remove it after temperatures of the camera and surroundings are equalized.
- Avoid contact with garbage, mud, sand, dust, water, toxic gases, or salt. These could cause the camera to breakdown. Wipe the camera to dry off any rain or water drops.
- Do not press the monitor with excessive force. This could cause it to break or malfunction.

- Be careful not to overtighten the screw in the tripod socket when using a tripod.

## Cleaning Your Camera

- Do not clean the camera with organic solvents such as thinner, alcohol, and benzene.
- Use a lens brush to remove dust accumulated on the lens. Never use a spray blower for cleaning as it may damage the lens.
- Please contact your nearest service center for professional cleaning of the CMOS sensor. (This will involve a fee.)
- Periodic inspections are recommended every one to two years to maintain high performance.

## Storing Your Camera

- Do not store the camera with preservatives or chemicals. Storage in high temperatures and high humidity can cause mold to grow on the camera. Remove the camera from its case and store it in a dry and well-ventilated place.
- Avoid using or storing the camera where it may be exposed to static electricity or electrical interference.
- Avoid using or storing the camera in direct sunlight or in locations where it may be exposed to rapid changes in temperature or to condensation.

## About SD Memory Cards

- The SD Memory Card is equipped with a write-protect switch. Setting the switch to LOCK prevents new data from being recorded on the card, the stored data from being deleted, and the card from being formatted by the camera or computer.
- The SD Memory Card may be hot when removing the card immediately after using the camera.
- Do not remove the SD Memory Card or turn off the power while the card is being accessed. This may cause the data to be lost or the card to be damaged.
- Do not bend the SD Memory Card or subject it to violent impact. Keep it away from water and store away from high temperatures.
- Do not remove the SD Memory Card while formatting. The card may be damaged and become unusable.
- Data on the SD Memory Card may be deleted in the following circumstances. We do not accept any liability for data that is deleted if
  1. the SD Memory Card is mishandled by the user.

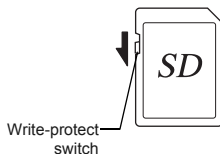

2. the SD Memory Card is exposed to static electricity or electrical interference.
  3. the SD Memory Card has not been used for a long time.
  4. the SD Memory Card or the battery is removed while the card is being accessed.
- If the SD Memory Card is not used for a long time, the data on the card may become unreadable. Be sure to regularly make a backup of important data on a computer.
  - Format new SD Memory Cards. Also format SD Memory Cards previously used with other cameras.
  - Please note that deleting data stored on an SD Memory Card, or formatting an SD Memory Card does not completely erase the original data. Deleted files can sometimes be recovered using commercially available software. If you are going to discard, give away or sell your SD Memory Card, you should ensure that the data on the card is completely deleted or the card itself is destroyed if it contains any personal or sensitive information.
  - The data on your SD Memory Card should be managed at your own risk.

## About Eye-Fi Cards

- An SD Memory Card with a built-in wireless LAN ("Eye-Fi card") can be used with this camera.
- Use of an access point and an Internet connection are required for transferring images via wireless LAN. For details, refer to the Eye-Fi website. (<http://www.eye.fi>)
- Use Eye-Fi cards which have been updated to the newest firmware.
- Set [Action Mode] of [Wireless Memory Card] to [OFF], or do not use an Eye-Fi card in a location where the use of wireless LAN devices is restricted or prohibited, such as airplanes.
- Eye-Fi cards can be used only in the country in which the card was purchased. Please observe all local laws governing Eye-Fi card usage.
- This camera features a function to enable/disable the communication function of the Eye-Fi card, however, we do not guarantee the operability of all Eye-Fi card functions.
- Refer to the Eye-Fi card manual for details on how to use the card.
- Please contact the Eye-Fi card manufacturer regarding any malfunctions or problems concerning Eye-Fi cards.



## Trademarks

Windows and Windows Vista are registered trademarks of Microsoft Corporation in the United States of America and other countries.

Macintosh, Mac OS, and QuickTime are trademarks of Apple Inc., registered in the U.S. and other countries.

Intel, Intel Core, and Pentium are trademarks of Intel Corporation in the U.S. and/or other countries.

SDXC Logo is a trademark of SD-3C, LLC.

Eye-Fi, the Eye-Fi logo and Eye-Fi *connected* are trademarks of Eye-Fi, Inc.

This product includes DNG technology under license by Adobe Systems Incorporated.

The DNG logo is either a registered trademark or trademark of Adobe Systems Incorporated in the United States and/or other countries.

HDMI, the HDMI logo and High-Definition Multimedia Interface are trademarks or registered trademarks of HDMI Licensing, LLC in the United States and/or other countries.

All other trademarks are the property of their respective owners.

This product supports PRINT Image Matching III. PRINT Image Matching enabled digital still cameras, printers and software help photographers to produce images more faithful to their intentions. Some functions are not available on printers that are not PRINT Image Matching III compliant. Copyright 2001 Seiko Epson Corporation. All Rights Reserved. PRINT Image Matching is a trademark of Seiko Epson Corporation. The PRINT Image Matching logo is a trademark of Seiko Epson Corporation.



## AVC Patent Portfolio License

This product is licensed under the AVC Patent Portfolio License for the personal use of a consumer or other uses in which it does not receive remuneration to (i) encode video in compliance with the AVC standard ("AVC video") and/or (ii) decode AVC video that was encoded by a consumer engaged in a personal activity and/or was obtained from a video provider licensed to provide AVC video. No license is granted or shall be implied for any other use.

Additional information may be obtained from MPEG LA, L.L.C. See <http://www.mpegla.com>.

## WARRANTY POLICY

All our cameras purchased through authorized bona fide photographic distribution channels are guaranteed against defects of material or workmanship for a period of twelve months from the date of your purchase. Service will be rendered, and defective parts will be replaced without cost to you within that period, provided the camera does not show evidence of impact, sand or liquid damage, mishandling, tampering, battery or chemical corrosion, operation contrary to operating instructions, or modification by an unauthorized repair shop. The manufacturer or its authorized representatives shall not be liable for any repair or alterations except those made with its written consent and shall not be liable for damages from delay or loss of use or from other indirect or consequential damages of any kind, whether caused by defective material or workmanship or otherwise; and it is expressly agreed that the liability of the manufacturer or its representatives under all guarantees or warranties, whether expressed or implied, is strictly limited to the replacement of parts as hereinbefore provided. No refunds will be made on repairs by non-authorized service facilities.

### Procedure During 12-month Warranty Period

Any camera which proves defective during the 12-month warranty period should be returned to the dealer from whom you purchased the camera or to the manufacturer. If there are no representatives of the manufacturer in your country, send the camera to the manufacturer, with postage prepaid. In this case, it will take a considerable length of time before the camera can be returned to you owing to the complicated customs procedures required. If the camera is covered by warranty, repairs will be made and parts replaced free of charge, and the camera will be returned to you upon completion of servicing. If the camera is not covered by warranty, regular charges of the manufacturer or of its representatives will apply. Shipping charges are to be borne by the owner. If your camera was purchased outside of the country where you wish to have it serviced during the warranty period, regular handling and

servicing fees may be charged by the manufacturer's representatives in that country. Notwithstanding this, your camera returned to the manufacturer will be serviced free of charge according to this procedure and warranty policy. In any case, however, shipping charges and customs clearance fees to be borne by the sender. To prove the date of your purchase when required, please keep the receipt or bills covering the purchase of your camera for at least a year. Before sending your camera for servicing, please make sure that you are sending it to the manufacturer's authorized representatives or their approved repair shops, unless you are sending it directly to the manufacturer. Always obtain a quotation for the service charge, and only after you accept the quoted service charge, instruct the service station to proceed with the servicing.

- **This warranty policy does not affect the customer's statutory rights.**
- **The local warranty policies available from our distributors in some countries can supersede this warranty policy. Therefore, we recommend that you review the warranty card supplied with your product at the time of purchase, or contact our distributor in your country for more information and to receive a copy of the warranty policy.**

### About PENTAX K-3 Premium Silver Edition

Should your camera malfunction, it shall be repaired under the same policies as those for the standard K-3 model. However, please be aware that should any external parts of your camera need to be replaced, the color of the replacement parts may be the same as that for the standard K-3 model. When sending in your camera for repair, be sure to package it properly to avoid damaging the exterior and causing other issues during shipment.

## For customers in USA

### STATEMENT OF FCC COMPLIANCE

This device complies with Part 15 of the FCC Rules. Operation is subject to the following two conditions: (1) This device may not cause harmful interference, and (2) this device must accept any interference received, including interference that may cause undesired operation.

Changes or modifications not approved by the party responsible for compliance could void the user's authority to operate the equipment.

This equipment has been tested and found to comply with the limits for a Class B digital device, pursuant to part 15 of the FCC Rules.

These limits are designed to provide reasonable protection against harmful interference in a residential installation. This equipment generates, uses and can radiate radio frequency energy and, if not installed and used in accordance with the instructions, may cause harmful interference to radio communications. However, there is no guarantee that interference will not occur in a particular installation.

If this equipment does cause harmful interference to radio or television reception, which can be determined by turning the equipment off and on, the user is encouraged to try to correct the interference by one or more of the following measures:

- Reorient or relocate the receiving antenna.
  - Increase the separation between the equipment and receiver.
  - Connect the equipment into an outlet on a circuit different from that to which the receiver is connected.
- \* Consult the dealer or an experienced radio/TV technician for help.

## For customers in Canada

This Class B digital apparatus complies with Canadian ICES-003.

## Pour les utilisateurs au Canada

Cet appareil numérique de la classe B est conforme à la norme NMB-003 du Canada.

## FOR CALIFORNIA, U.S.A. ONLY

Perchlorate Material-special handling may apply.

The lithium battery used in this camera contains perchlorate material, which may require special handling.

See [www.dtsc.ca.gov/hazardouswaste/perchlorate](http://www.dtsc.ca.gov/hazardouswaste/perchlorate)

# Declaration of Conformity

According to 47CFR, Parts 2 and 15 for  
Class B Personal Computers and Peripherals

We: RICOH IMAGING AMERICAS CORPORATION

Located at: 633 17<sup>th</sup> Street, Suite 2600  
Denver, Colorado 80202 U.S.A.  
Phone: 800-877-0155  
FAX: 303-790-1131

Declare under sole responsibility that the product identified herein complies with 47CFR Parts 2 and 15 of the FCC rules as a Class B digital device. Each product marketed is identical to the representative unit tested and found to be compliant with the standards. Records maintained continue to reflect the equipment being produced can be expected to be within the variation accepted, due to quantity production and testing on the statistical basis as required by 47CFR §2.909. Operation is subject to the following two conditions: (1) This device may not cause harmful interference, and (2) This device must accept any interference received, including interference that may cause undesired operation. The above named party is responsible for ensuring that the equipment complies with the standards of 47CFR §15.101 to §15.109.

Product Name: Digital Camera  
Model Number: PENTAX K-3  
Contact person: Customer Service Manager  
Date and Place: September, 2013, Colorado

## Information for Users on Collection and Disposal of Old Equipment and Used Batteries



### 1. In the European Union

These symbols on the products, packaging and/or accompanying documents mean that used electrical and electronic equipment and batteries should not be mixed with general household waste.

Used electrical/electronic equipment and batteries must be treated separately and in accordance with legislation that requires proper treatment, recovery and recycling of these products.

By disposing of these products correctly you will help ensure that the waste undergoes the necessary treatment, recovery and recycling and thus prevent potential negative effects on the environment and human health which could otherwise arise due to inappropriate waste handling.



If a chemical symbol is added beneath the symbol shown above, in accordance with the Battery Directive, this indicates that a heavy metal (Hg = Mercury, Cd = Cadmium, Pb = Lead) is present in the battery at a concentration above an applicable threshold specified in the Battery Directive.

For more information about collection and recycling of used products, please contact your local authorities, your waste disposal service or the point of sale where you purchased the products.

### 2. In other countries outside the EU

These symbols are only valid in the European Union. If you wish to discard used products, please contact your local authorities or dealer and ask for the correct method of disposal.

For Switzerland: Used electrical/electronic equipment can be returned free of charge to the dealer, even when you don't purchase a new product. Further collection facilities are listed on the home page of [www.swico.ch](http://www.swico.ch) or [www.sens.ch](http://www.sens.ch).



The CE Mark is a Directive conformity mark of the European Union.

**Memo**

**Regarding User Registration**

In order to better serve you, we request that you complete the user registration, which can be found on the CD-ROM supplied with the camera or on our website.

Thank you for your cooperation.

**RICOH IMAGING COMPANY, LTD.**

2-35-7, Maeno-cho, Itabashi-ku, Tokyo 174-8639, JAPAN  
(<http://www.ricoh-imaging.co.jp>)

**RICOH IMAGING EUROPE  
S.A.S**

112 Quai de Bezons, B.P. 204, 95106 Argenteuil Cedex, FRANCE  
(<http://www.ricoh-imaging.fr>)

**RICOH IMAGING  
DEUTSCHLAND GmbH**

Am Kaiserkai 1, 20457 Hamburg, GERMANY  
(<http://www.ricoh-imaging.de>)

**RICOH IMAGING UK LTD.**

PENTAX House, Heron Drive, Langley, Slough, Berks SL3 8PN, U.K.  
(<http://www.ricoh-imaging.co.uk>)

**RICOH IMAGING AMERICAS  
CORPORATION**

633 17th Street, Suite 2600, Denver, Colorado 80202, U.S.A.  
(<http://www.us.ricoh-imaging.com>)

**RICOH IMAGING CANADA  
INC.**

1770 Argentia Road Mississauga, Ontario L5N 3S7, CANADA  
(<http://www.ricoh-imaging.ca>)

**RICOH IMAGING CHINA CO.,  
LTD.**

23D, Jun Yao International Plaza, 789 Zhaojiabang Road, Xu Hui District,  
Shanghai, 200032, CHINA  
(<http://www.ricoh-imaging.com.cn>)

<http://www.ricoh-imaging.co.jp/english>

- Specifications and external dimensions are subject to change without notice.