

— INSTRUCTIONS

Leica
BRONICA-S

FEATURES OF THE ZENZA BRONICA-S

HOW TO USE YOUR ZENZA BRONICA-S

Instant Return Automatic Mirror	4
Instant Reopen Automatic Diaphragm	5
Depth-of-field Preview Button	5
Interchangeable Filminder Back	6
New Exclusive Film Tension System.....	7
Nikkor Lenses.....	7
Removing the 'Filminder' Back	9
Loading the 'Filminder' Back	10—11
Removing the Exposed Film.....	11
Taking Photographs	
(1) Winding the Shutter and Advancing the Film	12
(2) Presetting the Diaphragm and Focusing the Lens... ..	12—13
(3) Using the Depth-of-field Preview Button	13
(4) Selecting the Shutter Speed	14
(5) Mirror Lock-Down Button	15
(6) Making the Exposure	15
(7) Making Double or Multiple Exposures	16
(8) Interchanging Lenses.....	16
(9) Using Flash	17
(10) Close-up Photography	17
Using the Bronica Neck Strap	18
Lens Specifications	18
Filters	19
Specifications	20

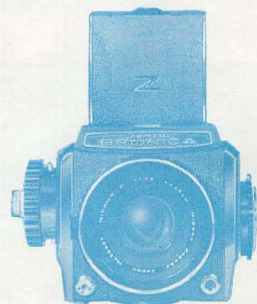

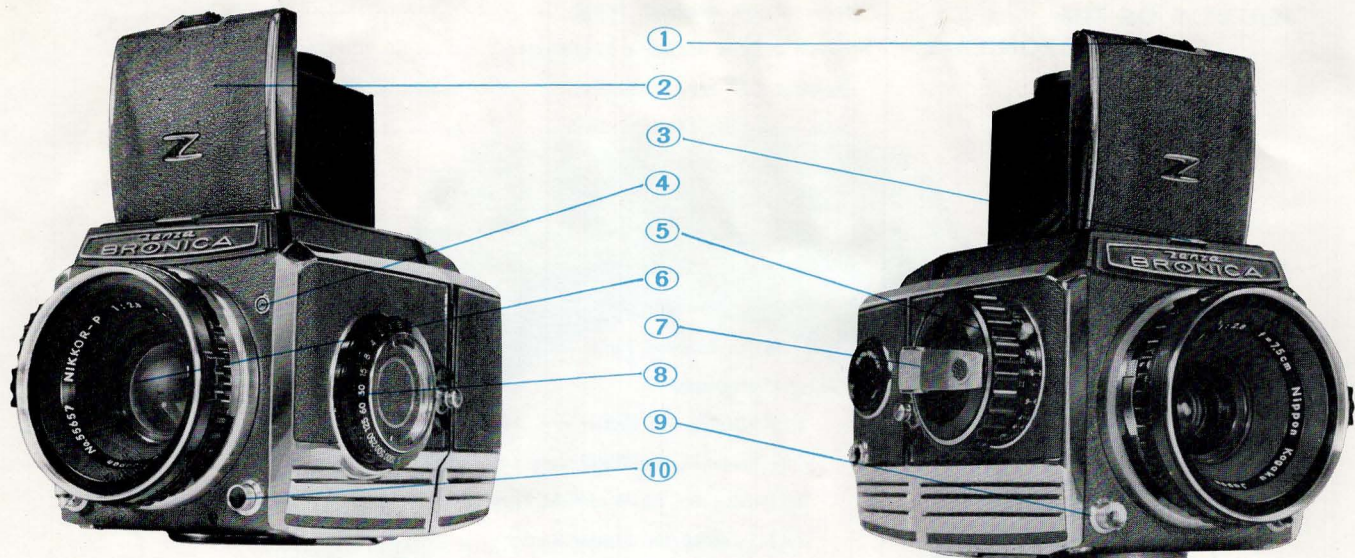

- ① Focusing Hood Lock
- ② Removable Focusing Hood
- ③ Focusing Hood Retaining Lock
- ④ Flash Terminal
- ⑤ Focusing Knob

- ⑥ Normal 75mm Nikkor Lens F:2.8
- ⑦ Winding Crank
- ⑧ Shutter Speed Dial
- ⑨ Body Release
- ⑩ Depth-of-field Preview Button

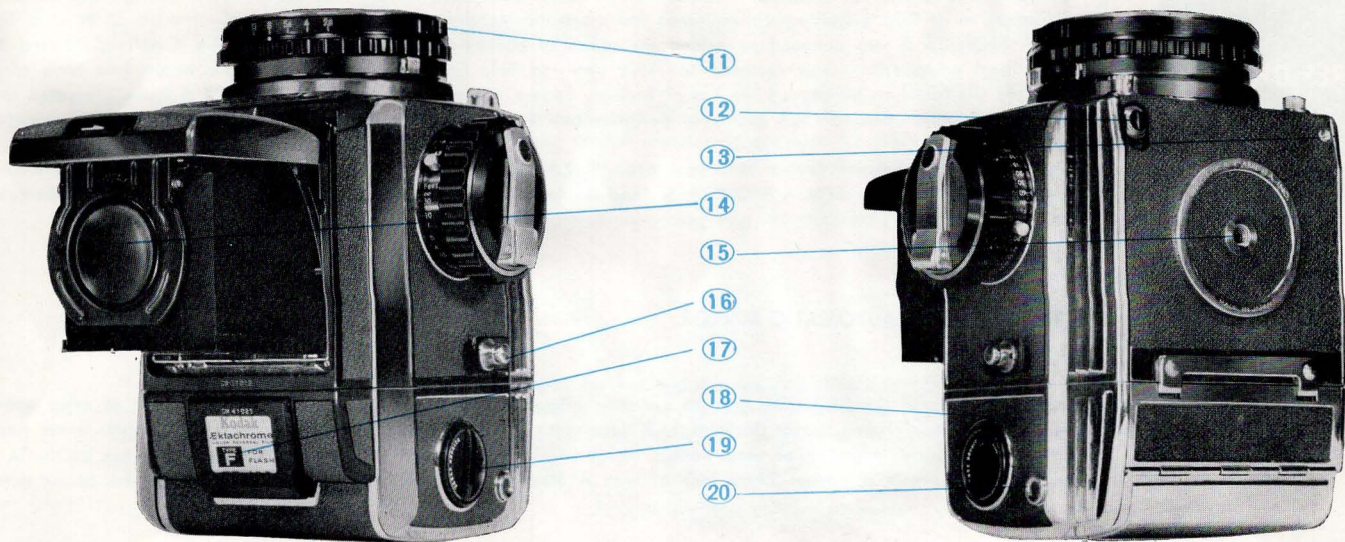

- ⑪ Diaphragm Preselector Ring
- ⑫ Mirror Lock-Down Button
- ⑬ Cable Release Socket
- ⑭ Magnifier
- ⑮ Tripod Socket

- ⑯ Strap Stud
- ⑰ Film Type Indicator Window
- ⑱ Filminder Back
- ⑲ Manual Film Winder
- ⑳ Exposure Counter Window

FEATURES OF THE ZENZA BRONICA-S

Your ZENZA BRONICA S is a precision instrument which has been designed with the utmost of human ingenuity and skill. It is unique in its field, possessing conveniences and automatic features not found in any other instrument of its type. The ZENZA BRONICA S was designed to extend the scope of photographic expression beyond the limitations imposed by conventional equipment. It was designed to serve you—to help you create the fine picture results you have often conceived yet found to be beyond the ken of ordinary camera equipment. The ZENZA BRONICA S is an integrated tool in which automatic operation and quality of performance combine to equip and assist you in achieving notably superior pictures.

It is best that you become familiar with your new ZENZA BRONICA S at the very beginning. Devote the extra minutes it will take to know your ZENZA BRONICA S. Read the instructions carefully. Your efforts will be rewarded by the pride you will have in the pictures it will give you.

INSTANT RETURN AUTOMATIC MIRROR

The reflex mirror of the BRONICA S is an exclusive original. It does not flip up for the exposure as in other single lens reflex cameras, but it moves forward and down with greater clearance provided for deep seated lenses permitting shorter focal length to be used without mirror interference. (Fig. 2) Using this exclusive method, the BRONICA S can be equipped with a normal 75mm lens or with a 50mm super wide angle. After an exposure, the mirror instantly automatically returns to viewing position. (Fig. 1)

Fig. 1



Fig. 2



INSTANT REOPEN AUTOMATIC DIAPHRAGM

Lenses for the BRONICA S have fully automatic diaphragms. Simply focus and view with the lenses wide open. (Fig. 3) When an exposure is made, the diaphragm automatically closes down to the preselected aperture for the correct exposure. (Fig. 4) Immediately after the exposure, the diaphragm automatically reopens to full aperture (Fig. 5) to provide a bright clear image on the focusing screen—ready for the next picture with no readjustment.

DEPTH-OF-FIELD PREVIEW BUTTON

The lens on the BRONICA S is always wide open for focusing and viewing. This provides maximum image-screen brightness for greater ease and accuracy. However it is often desirable to see the depth-of-field at 'taking' aperture. This is done by pressing the Depth-of-Field Preview Button. The diaphragm automatically stops down. (Fig. 4) Release the button and the diaphragm instantly returns to full aperture. (Fig. 5).

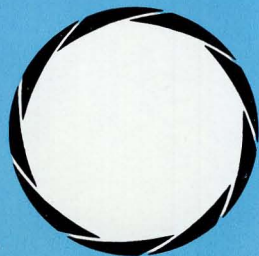

Fig. 3

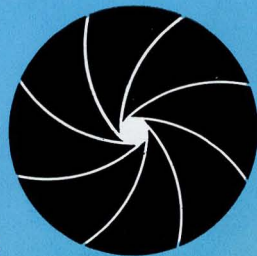

Fig. 4



Fig. 5

INTERCHANGEABLE 'FILMINDER' BACK

This convenient feature offers many advantages. It is possible to change film in the middle of a roll (black-and-white to color, color to black-and-white, indoor to daylight, etc.) without the loss of a single exposure. It permits you to preload several backs (Fig. 6) and shoot continuously without stopping for reloads.

The filminder back is fully automatic and foolproof. It is equipped with a metal dark slide to prevent the film from being exposed while the back is off the camera. The back cannot be removed until the dark slide is inserted and while the back is off the camera, the dark slide cannot be withdrawn. (Fig. 7)

When a filminder back is attached to the camera, no attention need be paid as to whether the film or the shutter has been previously wound.

The film advance crank, which normally winds the shutter and the film simultaneously, automatically performs only the required function. For example, if the shutter is wound and if the film in position has been exposed, turning the crank will only advance the film to a fresh unexposed section. Also, when the back is on the camera, the dark slide must be completely withdrawn before an exposure can be made.

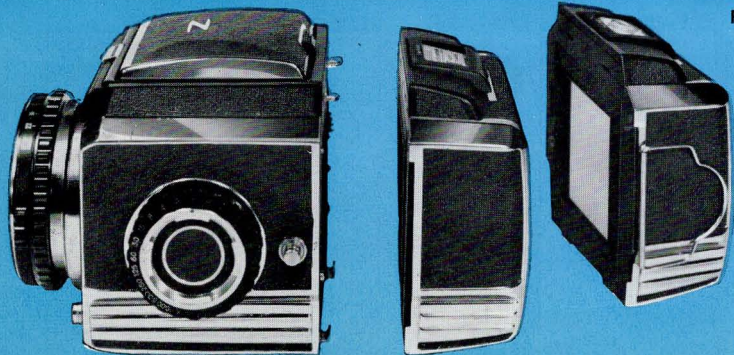

Fig. 6

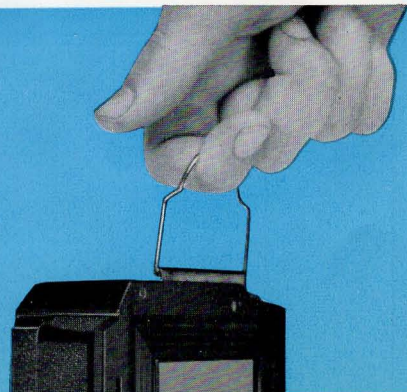

Fig. 7

NEW EXCLUSIVE FILM TENSION SYSTEM*

The BRONICA film tension system makes the film surface perfectly flat at the focal plane. All tension on the film is removed during the winding process. (Fig. 8) The instant the film is in place, tension is automatically applied. (Fig. 9)

The system not only adds much greater tension on the film during exposure to assure perfect film flatness but also eliminates dangerous film scratches which occur if the film is advanced while under tension.

Patent applied for

NIKKOR LENSES

Nikkor lenses are standard for the BRONICA S. (Fig. 10) Today, no finer optics are available. Nikkor lenses are the most compatible for the superb performance of the BRONICA S. They have proved to be the finest in the 35mm photography field in which optical quality means almost everything.

The available focal lengths range from 50mm super wide angle to 200mm telephoto. The 50, 75, 135, and 200mm lenses are equipped with instant reopen automatic diaphragms and are designated as Auto-Nikkors.

Fig. 8



Fig. 9

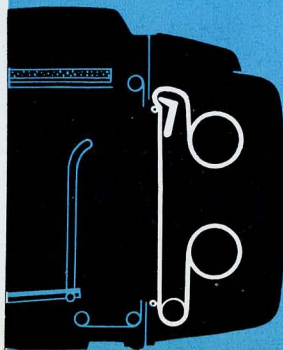
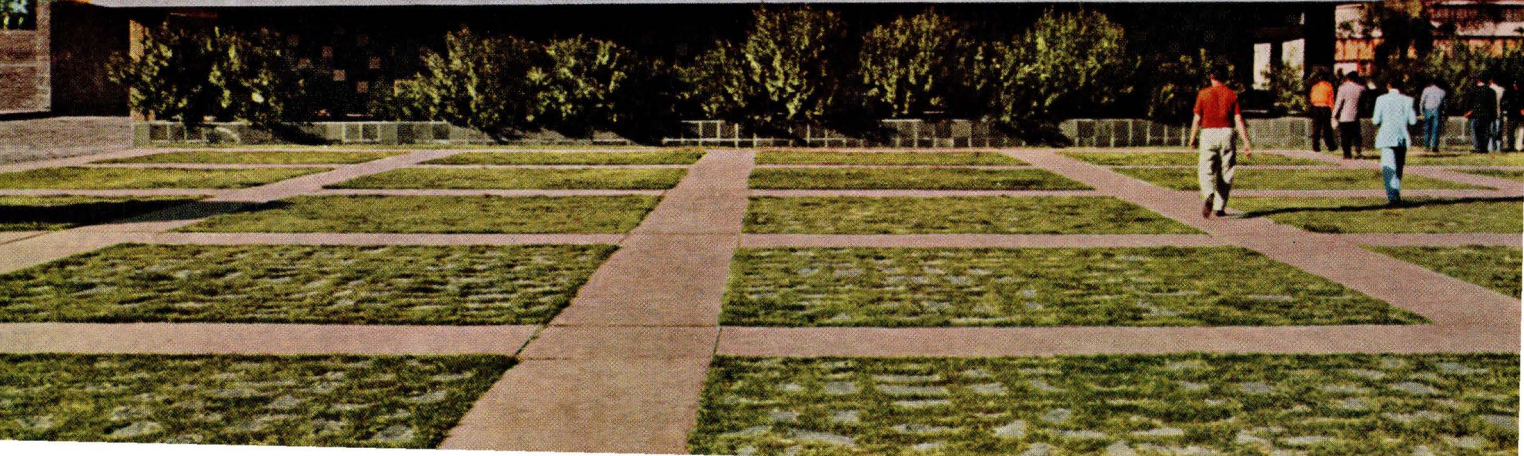
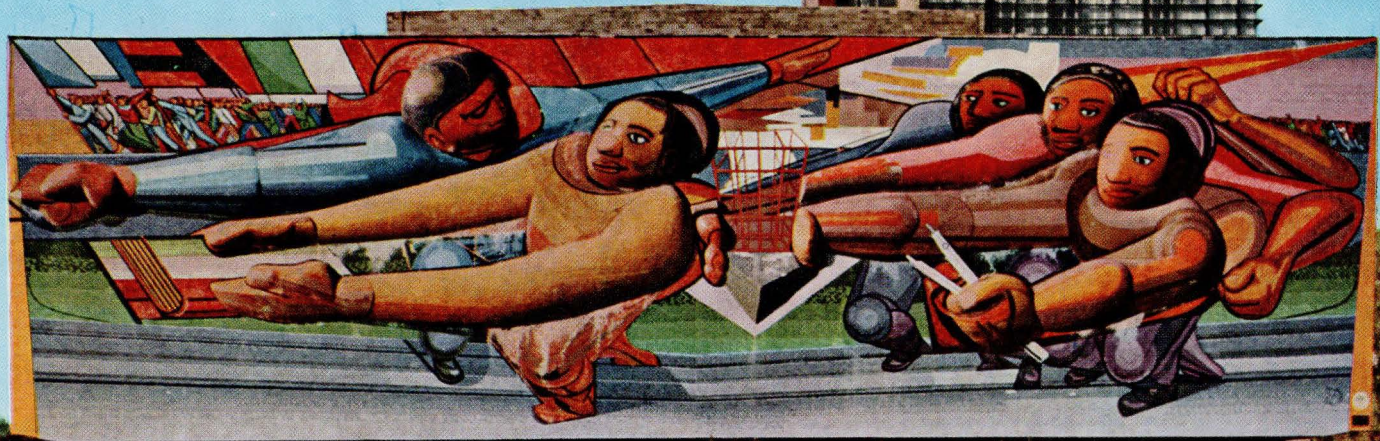

Fig. 10





**HOW TO USE
YOUR
ZENZA BRONICA-S**

REMOVING THE 'FILMINDER' BACK

Insert the dark slide into the filminder back. (Fig. 11) Hold the camera in the left hand. With the right hand, hold the filminder back with the thumb on the protruding edge of the dark slide. Press the dark slide inward with the thumb. This will release the filminder back from the camera. Remove the back by tilting and lifting it off the open hinge at the bottom. (Fig. 12)

Note: The dark slide is only necessary for removing the filminder back from the camera and should be withdrawn when the back is attached to the camera.

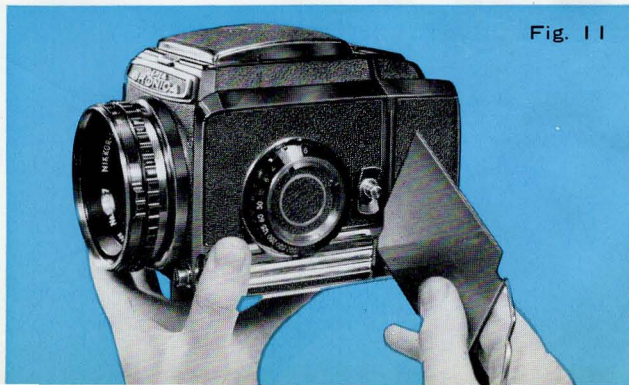

Fig. 11

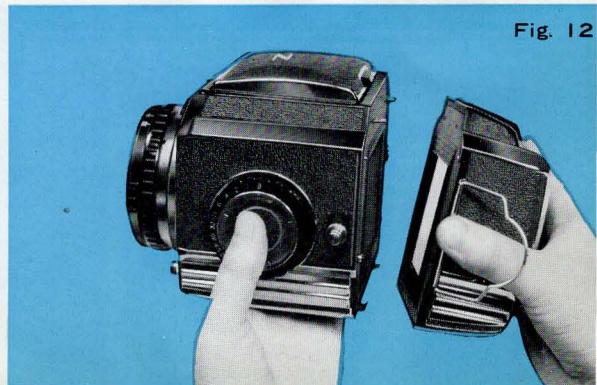

Fig. 12

LOADING THE 'FILMINDER' BACK

The BRONICA S uses 120 roll film and may be loaded with the filminder back either on or off the camera.

- Open the film type indicator window and slide the lock in the direction of the "0". (Fig. 13) The back cover will pop open.
- Remove the film holder from the filminder back.
- The film holder consists of two assemblies. (Fig. 14) The lower spindle assembly, which is marked with red arrows, holds the roll of unexposed film and the other assembly holds the take-up spool. Note that one end of both spindles is spring-loaded and can be pulled or pushed out for inserting the film rolls.
- The unexposed roll of film should be loaded onto the spindle marked with the red arrows. Push one end of the film onto the spring-loaded side of the spindle. (Fig. 14) The film roll will then slip into place. Make sure that the inside of the leader paper faces outward.
- Draw the leader paper across the film pressure plate and over the rollers. Insert the end of the leader paper into the wide slot of the take-up spool and secure it by manually turning the take-up spool until the film start mark is in line with the red arrows. (Fig. 15)
- Place the film holder into the open filminder back so that the gear on the holder and the gear in the back mesh together. To engage the two gears correctly, it may be necessary to turn the manual film winder and push down on the film holder.

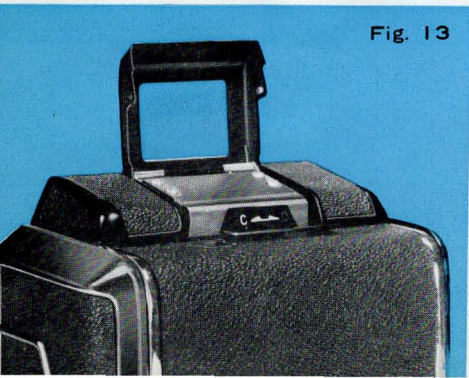

Fig. 13

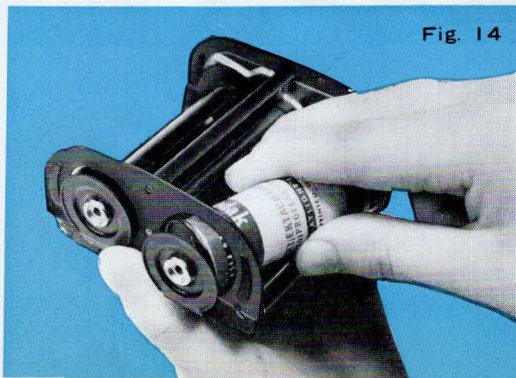

Fig. 14

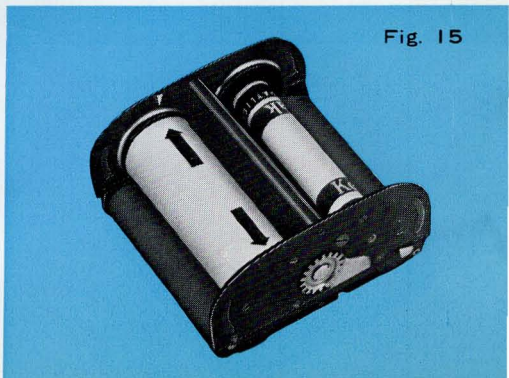

Fig. 15

- g. Close and lock the back cover by sliding the lock in the direction "C". If the back cover does not lock fully, check and make certain that the film holder is properly set in the filminder back.
- h. Place an end of the film carton box in the film type indicator window and snap closed. (Fig. 16) This exclusive film type indicator window is designed so that you can identify the name, the type and the speed of the film in each filminder back.
- i. To coordinate the loaded filminder back with the camera body, pull out the winding crank and wind the crank until it stops. (Fig. 17) The first exposure number (1) will appear in the exposure counter window.
- j. If the filminder back is not attached to the camera body, film can be wound by turning the manual film winder on the back. (Fig. 18)

Caution: Handle the filminder back carefully. Do not exert pressure in use and avoid hard shocks.

REMOVING THE EXPOSED FILM

After the 12 exposures are made, the winding crank will wind only the film. Wind until there is no resistance. Then open the back and remove the exposed film from the film holder.



TAKING PHOTOGRAPHS

(1) WINDING THE SHUTTER AND ADVANCING THE FILM

Pull out the winding crank in the focusing knob. Turn the crank in a forward direction to wind the shutter and advance the film. (Fig. 17) If the film has been previously wound, only the shutter will be wound or vice versa. After the shutter and film have been fully wound, the crank can be folded back into the focusing knob. Be sure to keep turning the crank until it stops to insure that the shutter and film are fully wound.

(2) PRESETTING THE DIAPHRAGM AND FOCUSING THE LENS

- a. Set the diaphragm for the selected exposure or 'taking' aperture by rotating the diaphragm preselector ring on the lens until the desired aperture opening number is in line with the white dot. (Fig. 19) The preselector ring may also be set for intermediate aperture openings (between numbers).
- b. Slide hood lock in the direction of the arrow. (Fig. 20) Hood will unfold and open.
- c. Look at the image on the focusing screen. Note how uniformly bright it is from corner to corner and how readily you can see the image in 'infocus' or 'out-of-focus'. The focusing scale is calibrated on the focusing knob. (Fig. 21) If the 75mm lens is used, read the green calibrations; the red is for the 50mm lens and the white scale is for the 135mm lens. To set the scale for the lens you are using, rack the focusing tube back to infinity. Using the raised pin in the focusing scale collar, set the correct color scale in position. The 'infinity' setting on the scale you are using must line up with the indicator mark on the side of the camera body.



Fig. 19

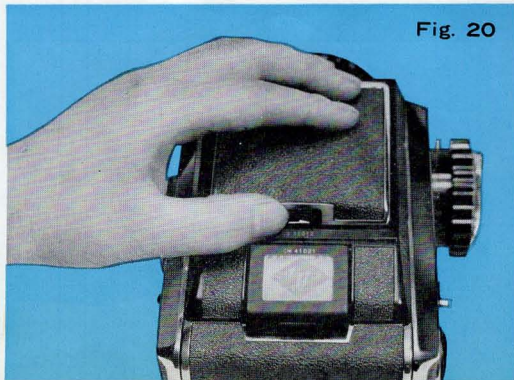

Fig. 20

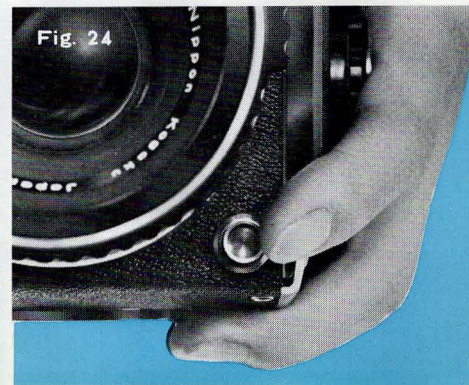
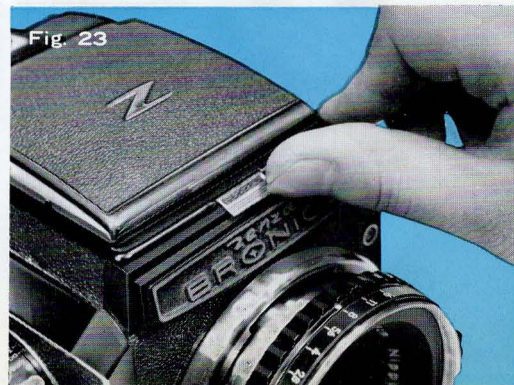
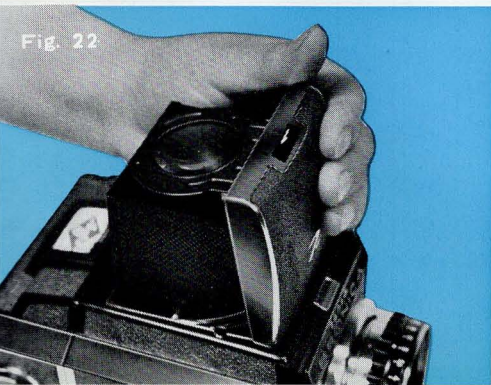

Fig. 21

- d. If a magnified image is desired, push back on the hood cover. (Fig. 22) This will release the magnifier into position. Keep the eye close to the magnifier for a clear vision of the entire field of the focusing screen.
- e. To replace the magnifier, press down on the metal frame of the magnifier until it locks against the under-side of the hood cover.
- f. To close the hood, fold in the sides, then the back and finally bring the front cover down until it locks.
- g. To remove the focusing hood for cleaning the screen or interchanging with sports or other finders, lift the hood retaining lock above the camera name plate. (Fig. 23) The hood will spring free.
- h. To replace the hood, slide it on so that the two metal tabs on the camera fit into the slots on the rear of the hood frame. Press hood down to lock.

(3) USING THE DEPTH-OF-FIELD PREVIEW BUTTON

In the BRONICA S, the lens is always wide open for viewing and focusing regardless of the aperture you have selected for the exposure. However, after having focused, you may want to see the depth-of-field at 'taking' aperture. While looking at the focusing screen, press the red button with the forefinger of your left hand. (Fig. 24) This will instantly close the diaphragm down to your preselected 'taking' aperture opening and the image on the screen will show the exact depth-of-field at that aperture. Release the red button and the diaphragm will instantly spring back to full aperture.



(4) SELECTING THE SHUTTER SPEED

A shutter speed may be selected either before or after the shutter is wound.

Rotate the speed selector dial until the desired shutter speed 'clicks' into position under the red dot indicator. (Fig. 25) The selector may also be set for intermediate shutter speeds (between markings). (Fig. 26)

The numerals represent shutter speeds of 1 second, 1/2, 1/4, 1/8, 1/15, 1/30, 1/60, 1/125, 1/250, 1/500 and 1/1000th. "X" represents 1/50th of a second and is the fastest shutter speed with which electronic flash units may be used. (see Using Flash) "B" is for bulb.

The shutter release button (Fig. 27) is equipped with a safety lock.

Turn the tip of the release button clockwise. When the red dot on the button is in the side position, the shutter is locked. When 'time' exposure is desired, set the dial at 'B'. Depress the shutter release button and turn the tip of the button counter-clockwise. This will lock the shutter open. To close the shutter, turn the tip of the button clockwise.

Fig. 25

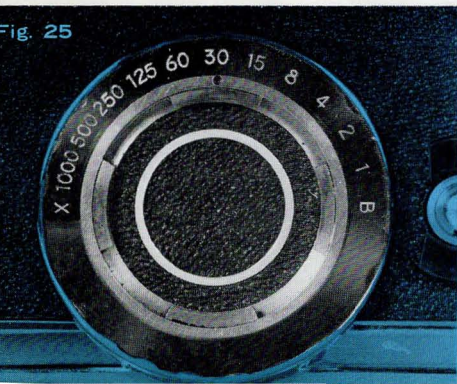

Fig. 26

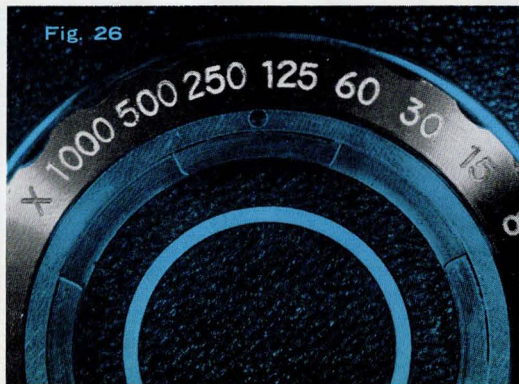
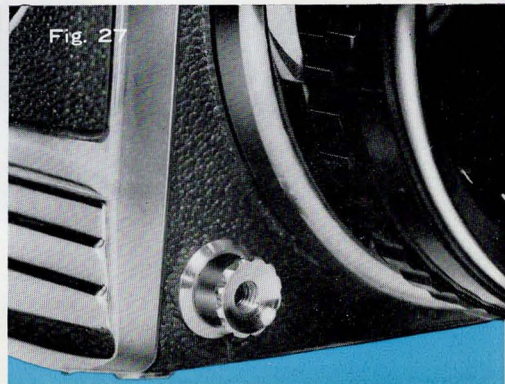

Fig. 27



(5) MIRROR LOCK-DOWN BUTTON

The mirror can be locked down in one action and the shutter tripped in a separate action. After the shutter is wound, push back on the mirror lock-down button. (Fig. 28) The mirror will move down and lock. Then depress the body release button to trip the shutter. This method will give you a steady and quiet exposure.

(6) MAKING THE EXPOSURE

After winding the film and shutter, selecting the aperture opening and shutter speed and focusing the lens, you are now ready to make an exposure.

a. If the dark metal slide has not been previously withdrawn, do so at this time. The BRONICA cannot be 'fired' with

the dark slide in the back. It must be completely removed. Simply pull the wire handle until the slide is withdrawn. The dark slide need not be reinserted after the exposure unless you intend to remove the filminder back.

b. To make the exposure, squeeze the body release button with the right or left forefinger. (Fig. 29) You will notice that the image returns to the viewing screen immediately after the exposure—bright and clear as before. This is the result of two automatic BRONICA features; the instant return automatic mirror and the instant reopen automatic diaphragm. It is desirable to use a cable release when slow shutter speeds are used. Cable release sockets are located in the body release button (Fig. 31) and below the depth-of-field preview button. (Fig. 30)

When shooting at speeds slower than 1/30th of a second, it is recommended that the BRONICA be mounted on a stable tripod or rested on a firm support.

Fig. 28

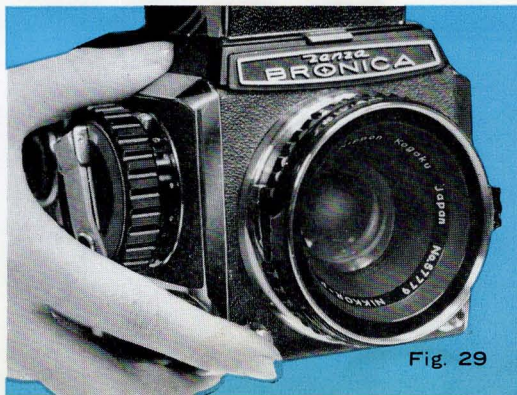
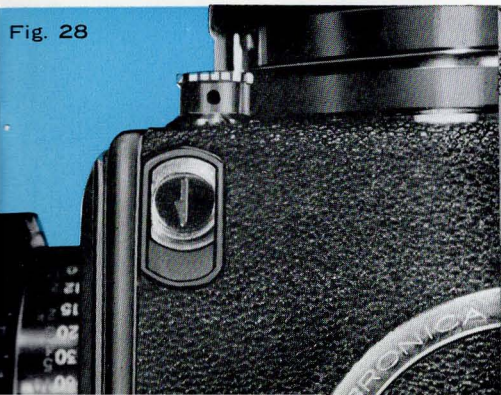

Fig. 29

Fig. 30

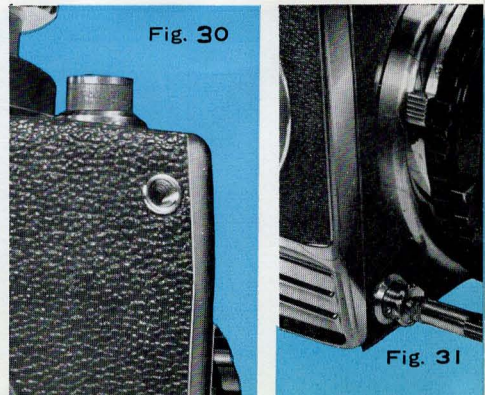

Fig. 31

(7) MAKING DOUBLE OR MULTIPLE EXPOSURES

As explained earlier, your BRONICA S has a built-in protection against inadvertent double exposures. However there are times when deliberate double exposures may be desired.

- a. After making one exposure, insert the dark slide and remove the filminder back. (Fig. 32)
- b. Turn the winding crank until the shutter is wound. Replace the filminder back on the camera body and withdraw the dark slide. You can now make a double exposure.

(8) INTERCHANGING LENSES

Lenses are quickly and easily interchangeable on the BRONICA S. The standard 75mm, the 50mm super wide angle, the 135mm and 200mm telephoto lenses are equipped with quick-change 1/6th turn bayonet mounts.

- a. To remove a bayonet-mounted lens, hold the lens front in the right hand with the thumb on the milled ridges of the lens bayonet lock. (Fig. 33)
- b. Press the bayonet lock with the thumb and simultaneously turn the lens to the left (counter-clockwise) 1/6th turn. Remove the lens. (Fig. 34)
- c. To mount the lens, insert the lens into the focusing tube lining up the red dots on the lens ring and the focusing tube. Turn the lens to the right (clockwise) until the bayonet lock snaps closed.
- d. Long telephoto lenses, with a focusing ring, should not be mounted on the focusing tube because of weight. Turn the focusing tube back to infinity and mount the lens on the outside bayonet on the camera body.

Note: The inside of the BRONICA focusing tube is threaded (57mm dia. \times 1mm pitch) to accept threaded lenses you now have. The distance from the foremost front edge of the focusing tube to the film emulsion is 102.0mm.

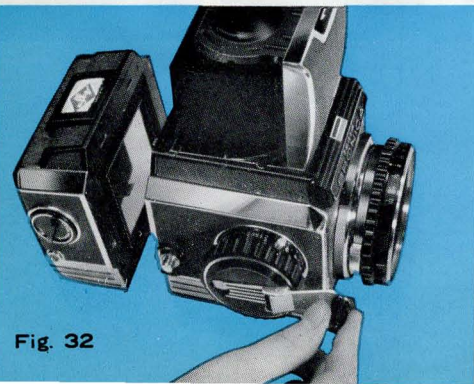

Fig. 32

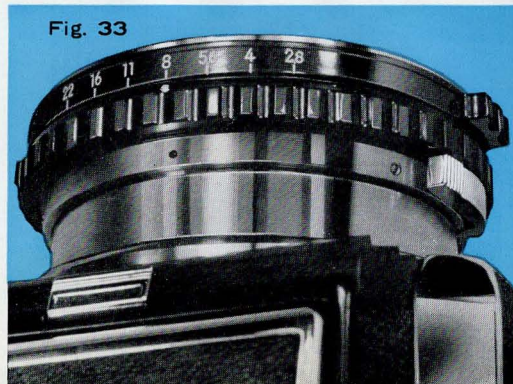

Fig. 33



Fig. 34

(9) USING FLASH

Your BRONICA S is in automatic switch-over synchronization which is coupled with the shutter speed.

The BRONICA flash terminal accepts a standard connecting cord (German Type). (Fig. 35)

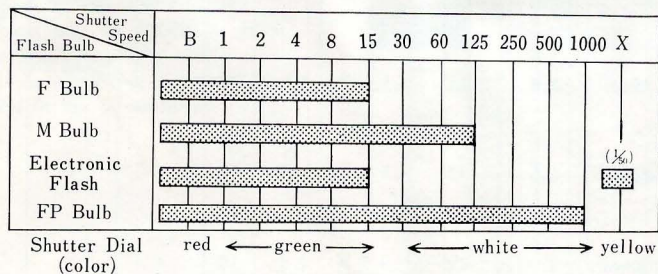
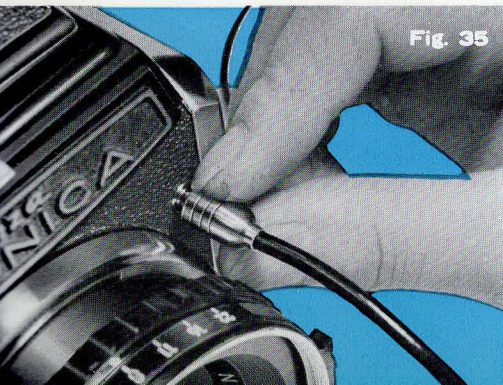

Fig. 35



(10) CLOSE-UP PHOTOGRAPHY

With the 75mm standard lens you can shoot as close as 50cm from the subject without using an attachment.

If you want to photograph the subject in closer than 50cm, use the BRONICA Extension Tube Set. (Fig. 36)

One set consists of a "A" ring, a "B" ring and two "C" rings.

No. of Tube \	Magnification Rate			Exposure Multiple Rate		
	75mm F2.8	50mm F3.5	135mm F3.5	75mm F2.8	50mm F3.5	135mm F3.5
"A"	0.22—0.45	0.35—0.69	0.15—0.26	1.4—2.0	1.82—2.85	1.32—1.56
"A"+"B"	0.45—0.67	0.69—1.03	0.26—0.38	2.0—2.77	2.85—4.12	1.56—1.90
"A"+"B"+"C"	0.67—0.88	1.03—1.47	0.38—0.57	2.77—3.53	4.12—6.10	1.90—2.46
"A"+"B"+"C"+"C"	0.88—1.10	1.47—1.70	0.57—0.63	3.53—4.41	6.10—7.29	2.46—2.65

Fig. 36

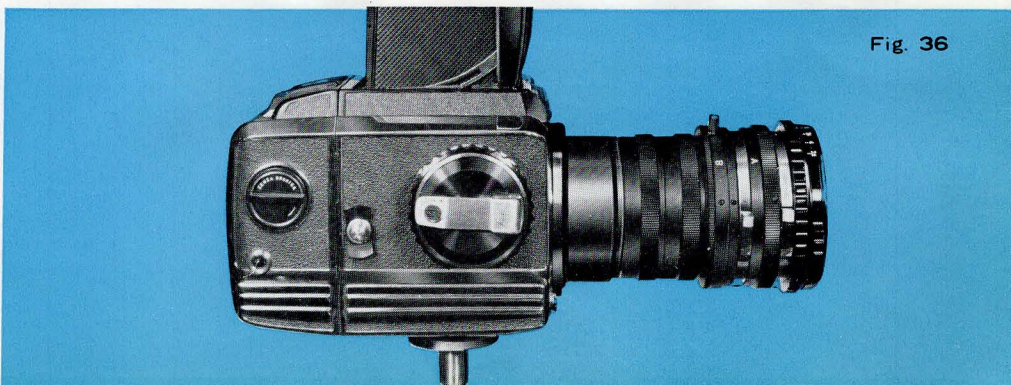

USING THE BRONICA NECK STRAP

The shoulder strap supplied with your BRONICAS serves two purposes. One, it provides a safe and convenient means for carrying the camera and two, it helps steady the camera during the exposure, especially when using long focus lenses. (Fig. 37)

- The shoulder strap is equipped with a coupling connector at each end. Place these coupling connectors over the camera strap studs on each side of the camera and press.
- To remove the strap, lift or raise the metal wings on each camera strap stud and simultaneously lift off the coupling connectors.
- As an aid to steadying the camera during exposure, first adjust the length of the strap so that the camera is at a comfortable distance for viewing and focusing. During the exposure, draw downward on the camera so that the strap is strained and taut. This will greatly minimize the effect of hand vibrations.

LENS SPECIFICATIONS

Type	Focal Length	Aperture Ratio	Angle of View	Magnification	Closest Distance		Aperture Dia- phragm	Filter Size	Focusing
Super Wide Angle	50mm	3.5	77°	0.67X	cm	in.	Auto Pre-set	82mm dia. Screw	Focusing Tube Back-Forth
					29	12			
Standard	75mm	2.8	55°	1 X	50	20	"	Series VIII	"
Telephoto	135mm	3.5	33°	1.8 X	m	ft.	"	"	"
Telephoto	200mm	4	32°	2.5 X	2.8	10	"	"	"

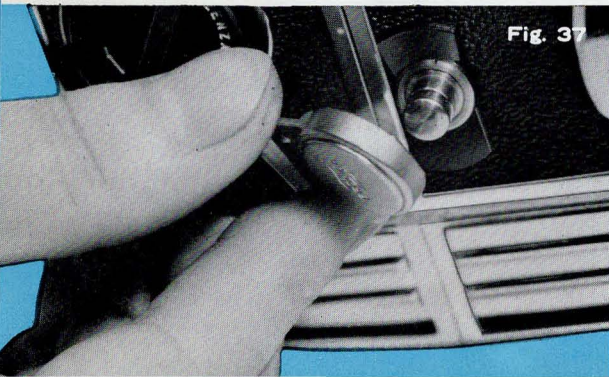
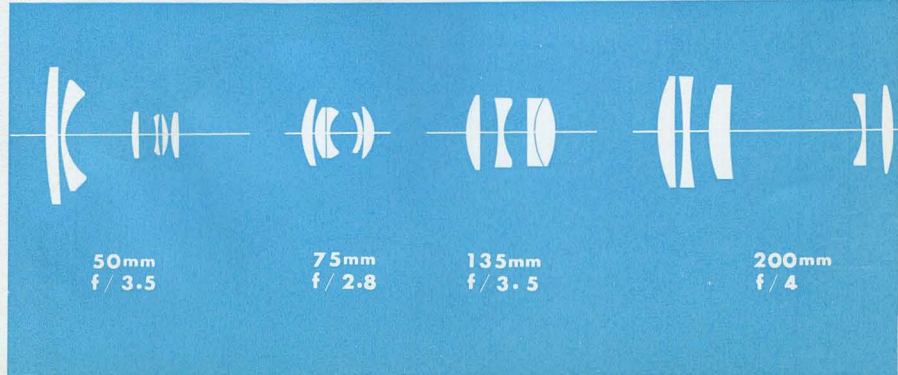

Fig. 37



50mm
f / 3.5

75mm
f / 2.8

135mm
f / 3.5

200mm
f / 4

FILTERS

Series VIII Filters attach to the 75mm, 135mm, and 200mm lenses with the BRONICA Filter Retaining Ring. (Fig. 38) Filters with 82mm diameter thread fit the 50mm lens.

FOR MONOCHROME	Color Number	Color	Exposure Magnification				Effect of Filters
			*B type panchromatic film		*C type panchromatic film		
			Daylight	Art. Light	Daylight	Art. Light	
SL-39	UV	Transparent	1	1	1	1	Absorbs ultra-violet rays which results in a clear image.
SY-44	Y1	Light Yellow	1.5	1.3	1.5	1.2	Gives a clear image of sky and background in natural contrast.
SY-48	Y2	Yellow	2.0	1.5	2.0	1.5	Shades down reds and yellows. Good contrast. For general use.
SO-56	YA3	Amber	4.0	3.0	4.0	2.0	Brings out cloud effect. Strong contrast.
SR-60	RI	Red	8.0	4.0	6.0	3.0	Gives greater contrast. For perfect infra-red photography with infra-red film.
G-55	POD	Yellowish Green	2.5	2.0	4.0	3.0	Gives natural contrast with panchromatic film.

*B type panchromatic films: Konipan S, SS, Neopan S, SS, Plus X, Double X and Veri-Chrome.

*C type panchromatic films: SSS class films and Tri-X.

FOR COLOR	Color	Conversion ratio for color temperature *Dekamired value	Exposure Magnification	Classification of color film	Effect of Filter
L-1A	Light Violet	0	1	Daylight type or Tungsten	Absorbs ultra-violet rays to prevent bluish appearance on background. Adjusts natural color balance. Used for lens protection.
O-85A	Orange	+12	2	Tungsten type	Conversion filter for tungsten type color film in daylight.
B-80A	Dark Blue	-12	2.5	Daylight type	Conversion filter for daylight type color film under artificial light.
B-82C	Blue	-4.0	1.5	Daylight type	Absorbs reddish color when photographs are taken before 9 A.M. or after 3 P.M. in daylight.
O-81B	Amber	+4.0	1.5	Daylight type	Absorbs bluish color when photographs are taken in cloudy or shadowy conditions.

* (+) Reduction of color temperature. (-) Increase of color temperature

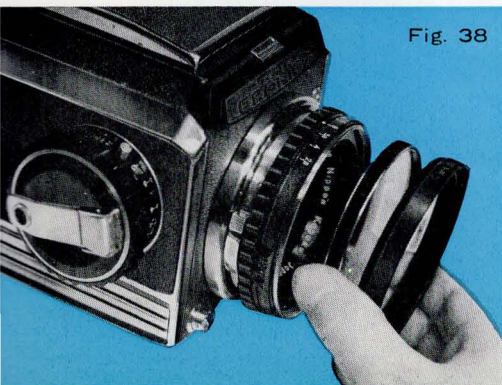
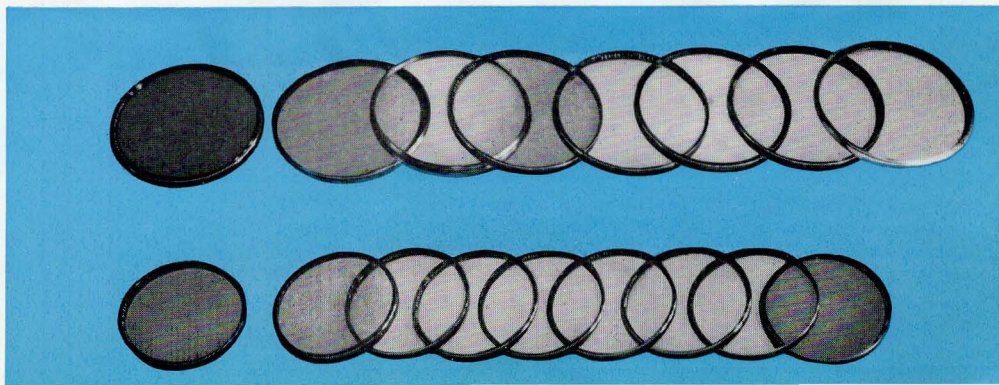

Fig. 38



SPECIFICATIONS

- Type : Daylight loading, interchangeable film back, 2 1/4" x 2 1/4" (6cm x 6cm) single lens reflex camera.
- Film : 120 roll film, 12 exposures.
- Standard Lens : Nikkor 75mm F:2.8 fully automatic preset diaphragm, 5 elements.
- Lens Mount : Bayonet type (BRONICA mounting), also equipped with screw mounting (57mm dia. x 1mm pitch), large bayonet mounting for long telephoto lenses.
- Finder : Fresnel lens and large magnifier.
- Viewfinder Hood : Interchangeable with pentaprism viewfinder, sports finder or magnifying hood.
- Focusing : Side knob type.
- Distance Scale : For 75mm, 50mm and 135mm lenses.
- Mirror : Flip down, instant return, automatic mirror system.
- Mirror Lock Down : Mirror can be locked down in a separate action.
- Diaphragm : Fully automatic diaphragm - 75mm, 50mm, 135mm and 200mm lenses.
- Depth-of-Field Preview : Depth-of-field can be checked by pressing preview button.
- Shutter : Vertically operating focal plane shutter, non-rotating single shutter dial, B, 1, 1/2, 1/4, 1/8, 1/15, 1/30, 1/60, 1/125, 1/250, 1/500, 1/1000 and "X" (1/50). "T" (Time) exposure by using shutter release lock device. Intermediate shutter speeds.
- Synchro : Automatic switch-over synchronization system:
FP class bulb : synchronized at all shutter speeds except "X".
M class bulb : B. 1-1/125.
F class bulb : B. 1-1/15.
Electronic Flash : "X". 1-1/15.
- Interchanging Films : Interchangeable film back fully coupled with camera body, dark slide with safety lock system, built-in light leak prevention curtain.
- Film Loading : Separate film holder, automatic film winding system by matching with film start mark.
- Film Winding : Winding crank.
- Film Counter : Automatically returns to "O".
- Exterior : Made of 18-8 Stainless Steel, bright polished finish.
- Camera Body Dimensions : 100mm x 100mm x 140mm.



Soft Leather Case

ZENZA BRONICA INDUSTRIES, INC.

25, 2-chome, Minami-Tokiwadai,
Itabashi-ku, Tokyo, Japan

Phone: 956—3101

