



E

OLYMPUS **OLYMPUS**
OM-1 **INSTRUCTIONS**



DESCRIPTION OF CONTROLS

Mirror Lock-up Lever

Rewind Release Lever

Shoulder Strap Eyelet

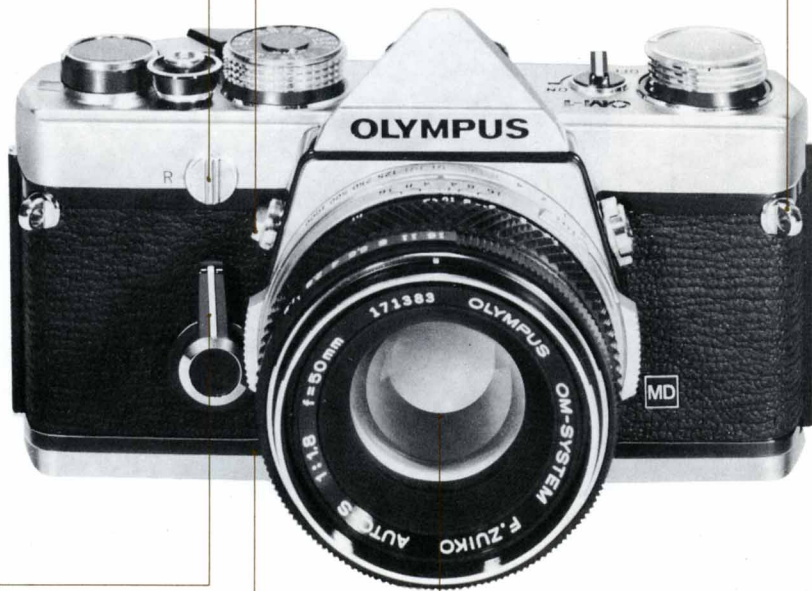

Self-Timer

Preview Button

Standard Lens

(The design of the OLYMPUS OM-1MD allows the photographer to view every camera control from the top.)

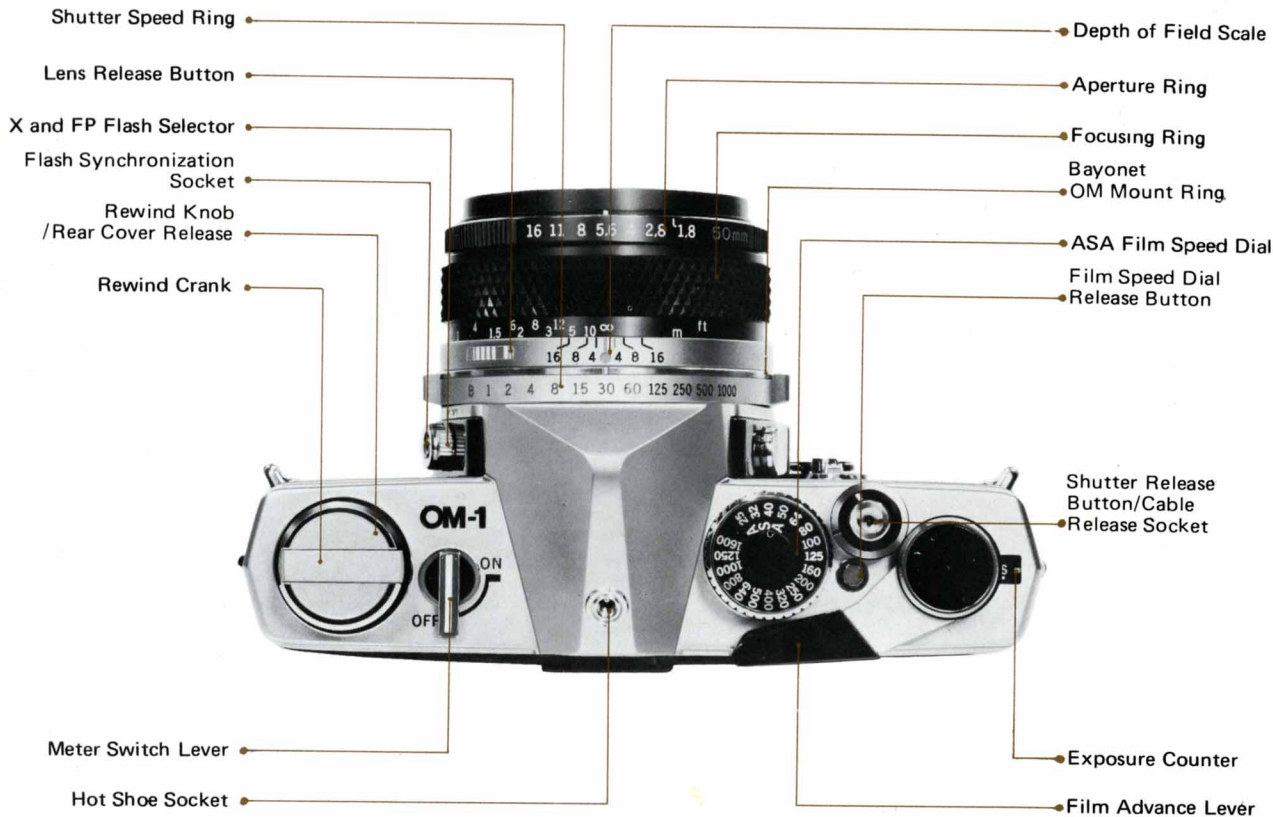

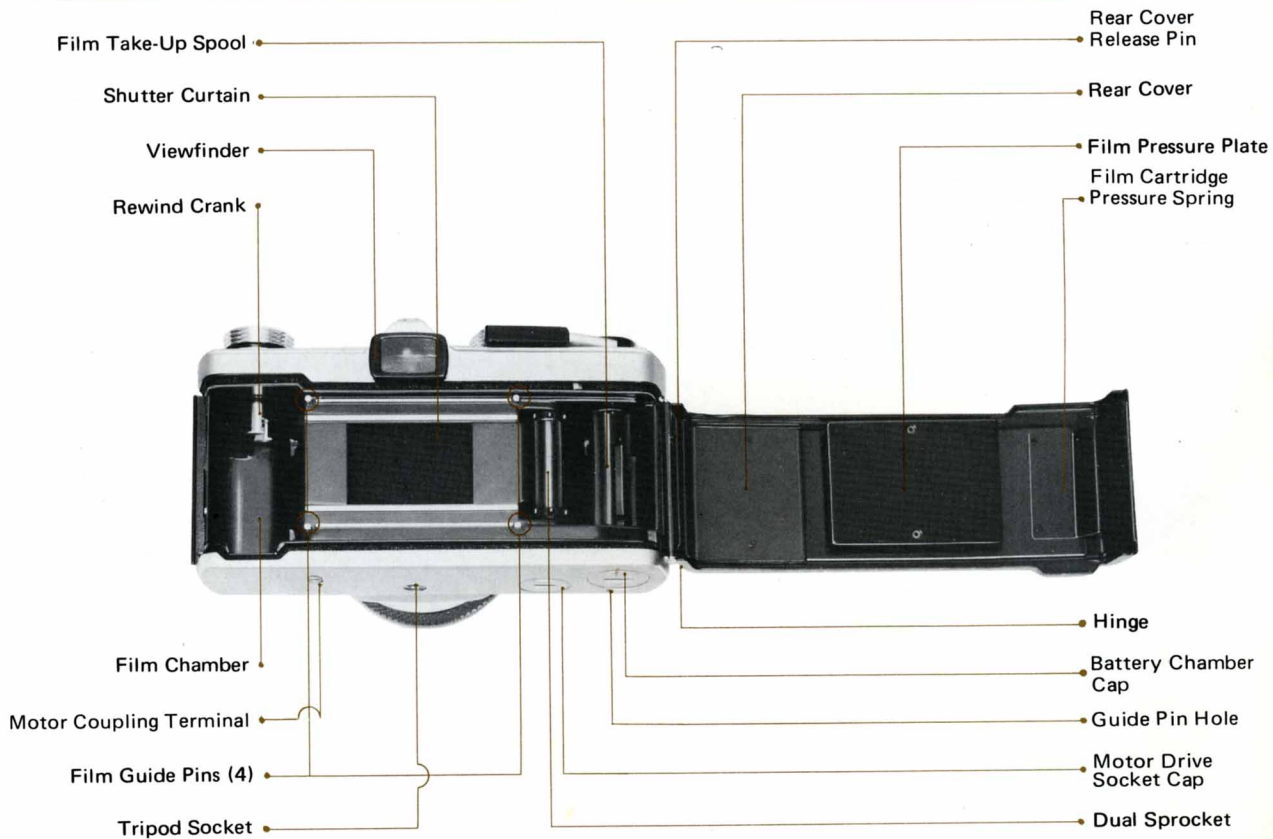

OLYMPUS OM-1MD

● Description of Controls	1	● Depth of Field Scale	17	● Close-Up Photography Group	39
● Specifications	5	● Preview Button	17	● Chart of Close-Up Photography Group	41
● Short Course of Instructions	6	● Depth of Field	18	● Close-Up Photography Units	42
● Inserting the Battery	7	● Motor Drive Photography	19	● Macrophotography Group	43
● Loading the Film	7	● Holding the Camera	23	● Chart of Macrophotography Group	44
● Front Lens Cap	7	● Setting the Self-Timer	24	● Macrophotography Units	45
● Operating the Film Advance Lever	9	● Locking up the Mirror	24	● Photomicrography Group	49
● The Exposure Counter	9	● Flash Photography	25	● Chart of Photomicrography Group	50
● Unloading the Film	10	● Flash Units	26	● Photomicrography Units	51
● Making Double Exposures	10	● Some Questions and Answers	27	● Chart of Close-Up Ranges	54
● Setting the Shutter Speed Ring	11	● Care and Storage	28	● Finder Group	55
● Setting the Aperture Ring	11	● Changing the Rear Cover	29	● Finder Group Units	56
● Setting the ASA Film Speed Dial	12	● Changing the Lens	30	● Other Units	57
● The Metering System	12	● Zuiko Interchangeable Lens Group	31		
● Setting the Exposure	13	● Table of Interchangeable Lenses	33		
● Focusing	15	● Motor Drive Group	35		
● Interchangeable Focusing Screens	16	● Chart of Motor Drive Group	37		
● Infrared Photography	17	● Motor Drive Units	38		

System:	OLYMPUS OM-SYSTEM.
Camera Type:	35mm Single Lens Reflex with focal plane shutter.
Film Size and Capacity:	35mm perforated film in 12, 20 or 36 exposure cartridges; removable hinged back accepts 250 exposure back and Recordata back (optional accessories).
Film Format:	24mm x 36mm.
Standard Lenses:	50mm F1.8 F Zuiko Auto-S 6 elements in 5 groups. 50mm F1.4 G Zuiko Auto-S 7 elements in 6 groups. 55mm F1.2 G Zuiko Auto-S 7 elements in 6 groups.
Lens Mount:	OLYMPUS OM Mount, bayonet type.
Minimum Focusing Distance:	45cm (17 3/4") with all standard lenses.
Lens Accessory Size:	49mm threaded for F1.8 and F1.4 lenses; 55mm threaded for F1.2 lens.
Shutter:	Focal plane shutter, dial mounted control, with speeds from 1 to 1/1000 second plus B.
Self-Timer:	4-12 second delay lever type; can be stopped after actuation.
Exposure Measurement:	Two highly-sensitive CdS cells located on either side of the eyepiece provide through-the-lens open aperture light measurement. Match needle setting visible in viewfinder. On/Off Switch located atop camera.
Exposure Range:	EV 2-17 (ASA 100 with F1.4 standard lens).
Battery:	1.3 volt mercury battery (Eveready E625, Mallory RM625-R, GE No. 625 or equivalent).
Film Speed Range:	ASA 25-1600.
Viewfinder:	Pentaprism type wide-vision finder shows 97% of actual picture field; interchangeable focusing screens; Visible exposure meter needle.
Viewfinder Magnification:	0.92X at infinity with standard 50mm lens.
Viewfinder Apparent Field View:	23° 30' & 35°.
Focusing Screens:	1-1 Micropism-matte type provided. Interchangeable with any of 11 additional screens.
Reflex Mirror:	Oversize, quick return type with mirror lock-up control.
Flash Contacts:	X and FP with switch.
Flash Synchronization:	With electronic flash (X) 1 to 1/60 sec. With Class "M" bulbs (X) 1 to 1/15 sec. With class "F" bulbs (X) 1 to 1/15 sec. With focal plane bulbs (FP) 1/60 to 1/1000 sec.
Hot Shoe Socket:	Built-in. Easy to attach OLYMPUS hot shoe available.
Film Advance: (Manual)	Ratchet type film advance. May be advanced in one stroke or several short strokes for a total of 150° rotation. Built-in prevention against double advance with double exposure override capability.
(Motor Drive)	When attached with motor drive units, single-frame and sequential filming of 5 frames per second in optimum conditions possible.
Exposure Counter:	Progressive type from "S" (Start) to 36 and "E" (End). Counter automatically resets to "S" when rear cover opened.
Film Rewinding:	Rewind crank with automatic resetting rewind release lever.
Rear Cover:	Removable hinge type. Interchangeable with Recordata Back and 250 Film Back.
Dimensions & Weights:	With F1.8 lens: 136mm x 83mm x 81mm (5-3/8" x 3-1/4" x 3-3/16") : 660 gr. (23.3 oz.) With F1.4 lens: 136mm x 83mm x 86mm (5-3/8" x 3-1/4" x 3-3/8") : 720 gr. (25.4 oz.) With F1.2 lens: 136mm x 83mm x 97mm (5-3/8" x 3-1/4" x 3-13/16") : 800 gr. (28.2 oz.) Body only: 136mm x 83mm x 50mm (5-3/8" x 3-1/4" x 2") : 490 gr. (17.3 oz.)

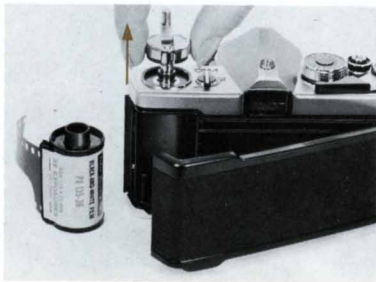

- 1** Load the camera (see page 7).
Make sure the battery has been properly inserted and that the rear cover is closed tightly.

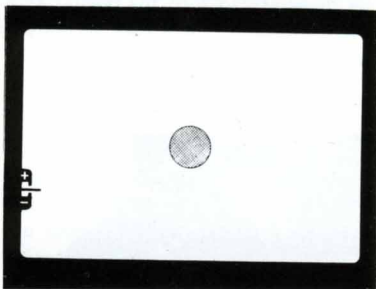

- 4** Look through the viewfinder.
Compose and focus. Set the proper exposure (see pages 13, 14, 15).

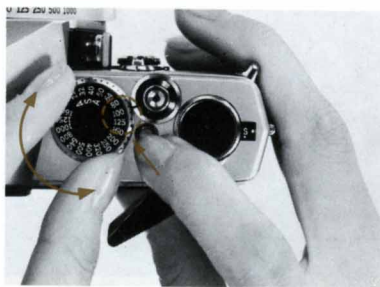

- 2** Set ASA Film Speed (see page 12).

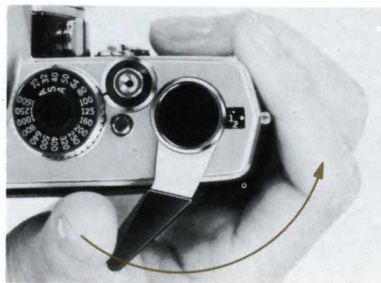

- 3** Advance the film until the figure "1" appears in the exposure counter window (see page 9).

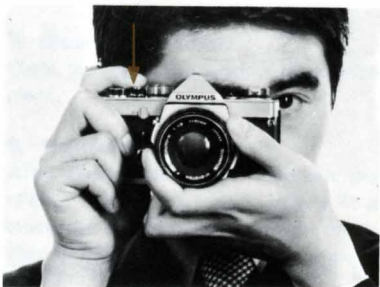

- 5** Take the picture (see page 23).
Hold the camera steady and release the shutter with a slow, steady pressure.

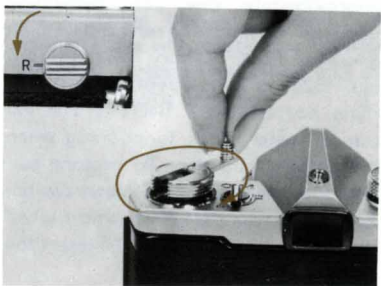

- 6** After the entire film has been exposed, rewind the film back into the cartridge (see page 10).

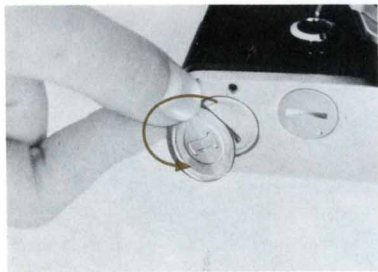

The OLYMPUS OM-1 MD is supplied with a 1.3V mercury battery especially designed to power its through-the-lens exposure metering system. It will last approximately one year depending upon use and must be replaced with an Eveready E625, Mallory RM-625R, GE No. 625 or equivalent. Substitutes must not be used. (NOTE: The exposure meter stops functioning when the battery runs out. To prolong battery life, make sure the Meter Switch Lever is in the "OFF" position when the camera is not in use.) To insert the battery:

1) Insert the edge of a coin into the cap of the battery chamber and turn counter-clockwise until the cap has been removed.

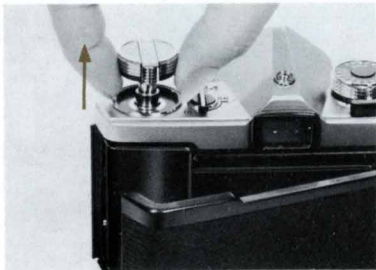

1. Open the rear cover.

Pull up on the rewind knob. A slight resistance may be felt before the rear cover snaps partially open.

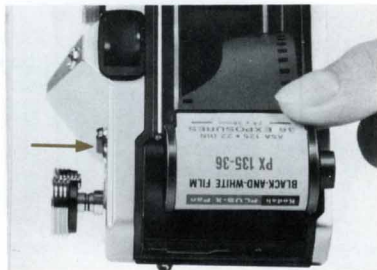

2. Load the camera.

Insert a film cartridge in the film chamber and push the rewind knob back into its original position. It may be necessary to turn the rewind knob slightly before it will lock securely in place.

2) Place the battery in the battery chamber making sure the positive side (+) is facing out. The exposure meter does not function if the battery is inserted incorrectly.

3) Replace the cap tightly.



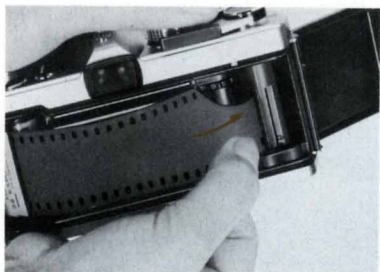

3. Attach the film end to the take-up spool.

Draw out the film leader and insert it into one of the slots in the film take-up spool. Make sure the film is evenly placed between the film guide pins.

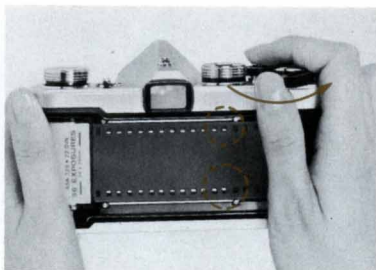

4. Advance the film.

Advance the film using the film advance lever. Make sure that the film perforations engage on the sprockets on both sides.

5. Close the rear cover.

Close the rear cover until it clicks into place.

6. Tighten the film.

After closing the cover, fold out the rewind crank and turn it slowly in a clockwise direction until a slight resistance is felt. This will take up any slack in the film.



7. Check the exposure counter window.

Advance the film and depress the shutter release button. Advance the film once more until "1" appears in the exposure counter window. The rewind knob will rotate in a counter-clockwise direction indicating that the film is advancing properly.

To attach or remove the front lens cap, press the spring-loaded lens cap retaining clips on either side of the cap. The cap then fits easily over the accessory thread of the lens.

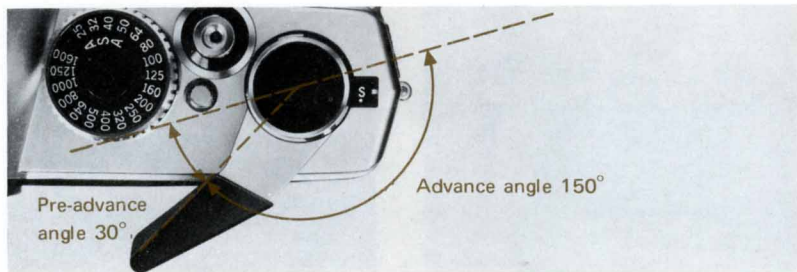

In one stroke the film advance lever:

- 1) advances the film one full frame,
- 2) advances the exposure counter, 3) cocks the shutter, 4) sets the instant return mirror, 5) activates the automatic diaphragm mechanism and 6) activates double advance and double exposure prevention mechanism.

To advance the film:

- 1) Gently pull the film advance lever away from the camera body.
- 2) Advance the lever to the right as far as it will go. **This can be accomplished in a single stroke or in multiple short strokes.**

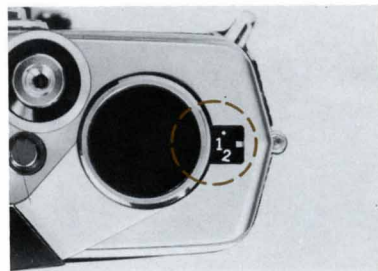

The exposure counter is designed to indicate the total number of frames exposed on the film. Each time the film is advanced by the film advance lever, the exposure counter automatically adds one frame to the total. The counter is indexed in even numbers up to 36 plus "S" (start) and "E" (end). For easy reference, "S", "E", and numbers 12, 20 and 36 are indicated in gold. Whenever the rear cover is opened, the exposure counter automatically returns to "S".

Refer to page 19 for Motor Drive Photography.

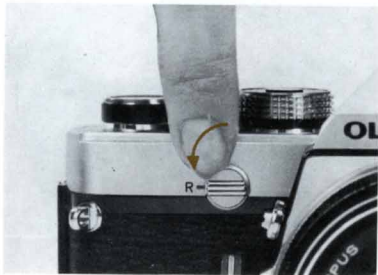

When the entire roll of film has been exposed (indicated by numbers 12, 20 or 36 on the exposure counter depending on film length), rewind the film.

1) Turn the rewind release lever counter-clockwise until the red line is opposite the "R".

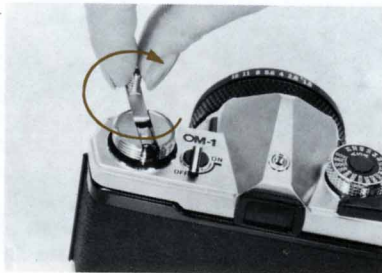

2) Fold out the rewind crank and wind it in the direction of the arrow. During the rewind procedure you will feel tension on the crank. When it turns free the film has been completely rewound back into the cartridge.

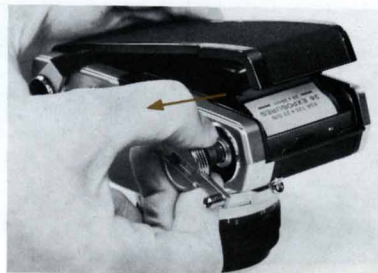

3) Open the rear cover by pulling up on the rewind crank and remove the film cartridge. Keep camera and film out of direct sunlight.

IMPORTANT: Do not force the film advance lever if the film has been fully exposed. If there is some resistance, rewind the film to prevent tearing.

■ MAKING DOUBLE EXPOSURES

Should you wish to make more than one exposure on the same frame,

1) After taking the first exposure, turn the rewind knob slowly in a clockwise direction until it stops to take off any slack in the film.

2) Turn the rewind release lever counter-clockwise until the red line is opposite the "R".

3) Hold both the rewind knob and rewind release lever firmly to prevent them from turning and advance the film advance lever. The shutter will then be cocked for the next exposure of the frame, without the film being advanced.

4) Depress the shutter release button with a slow, steady pressure.

5) After completing the multiple ex-

posure, cover the lens with a lens cap, advance the film and shoot a blank frame to avoid overlapping.

You can make as many multiple exposures as you like by repeating the above procedure. With each exposure on the same frame (the exposure counter adds one), the likelihood of slippage is increased. Practice is required in order to obtain good results.



The length of time that light is allowed to strike the film is controlled by the focal plane shutter. The shutter consists of two opaque "curtains" which travel across the opening and allow light to reach the film. The speed and coordinated movement of these curtains determine in fractions of a second the exposure time for your picture. For example, 1000 on the shutter speed ring indicates 1/1000 of a second and 60 indicates 1/60 of a second. The figure 1 indicates one full second. The B (Bulb) setting is used for longer time exposures. At this setting the shutter will remain open as long as the shutter release button is held down. For exposures less than 1/30 of a second, it is advisable to use a cable release, tripod or other steadying devices to avoid

camera movement which can result in blurred or fuzzy pictures. To set the shutter speed turn the shutter speed ring in either direction until the desired number clicks into place opposite the reference dot on the lens barrel. **Set the ring only at click-stop positions as no in-between settings can be used.** Shutter speeds may be set before or after advancing the film.

NOTE: Speeds from "B" to "60" are indicated on the ring in blue as an easy reference to "X" flash synchronization.

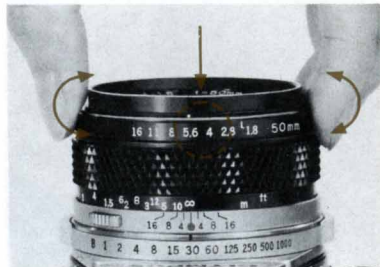

The amount of light allowed to strike the film is represented by "F" numbers or "F" stops engraved on the aperture ring. The higher the F number, the smaller the lens opening (less light); the lower the number, the larger the lens opening (more light). When setting the aperture ring you can use either the click-stop positions or any in-between settings to obtain precise exposure.

All lenses in the OLYMPUS OM-SYSTEM (other than specialized lenses) provide fully automatic diaphragm control allowing you to focus and compose your picture with the lens at maximum aperture or "wide open." The diaphragm will automatically stop down to the preselected F stop at the moment of exposure and immediately re-open when exposure is completed.

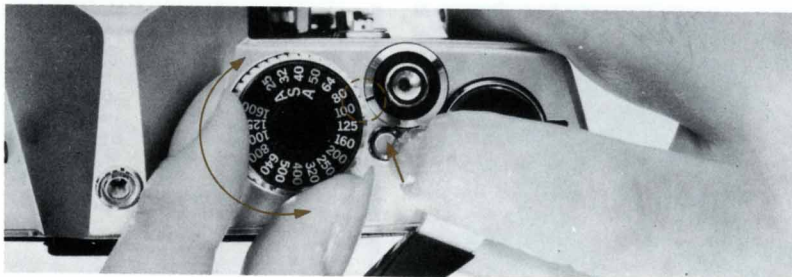

Setting the correct ASA film speed on the camera is one of the most important factors in determining exposure. In order to obtain properly exposed pictures, the correct ASA film speed must be set on the ASA film speed dial. To set the dial:

- 1) Pull the film advance lever slightly away from the camera body.
- 2) Press the film speed dial release button and turn the film speed dial until the ASA rating for the film being used is opposite the black line engraved on the outer ring of the shutter release button.
- 3) Release the button making sure that **the dial is securely in place and does not move.**

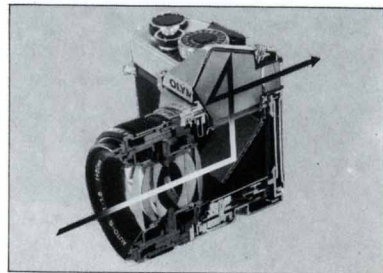

The OLYMPUS OM-1 MD incorporates a built-in, wide-open exposure metering system which uses two highly-sensitive CdS cells with one positioned on each side of the eyepiece. These cells measure the actual amount of light entering the lens, placing the greatest emphasis at the center of the picture area. Measurements are taken with the lens diaphragm at maximum aperture (wide open) allowing you to take full advantage of a brighter viewfinder when focusing and composing your picture. The OM-1 MD metering system operates as above with all OM-System camera lenses regardless of the focal length, filters, etc.

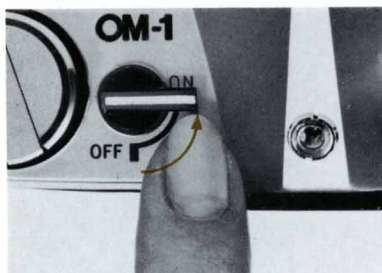

■ Activating the Meter

The OLYMPUS OM-1 MD metering system is directly coupled to the shutter speed ring, aperture ring and ASA film speed dial.

To activate the meter, move the meter switch lever at the top of the camera to the "ON" position. To prolong battery life, it's a good idea to return the lever to the "OFF" position when the camera is not in use.

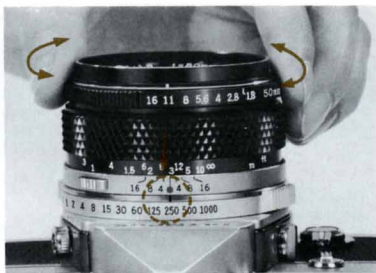

■ Preselecting the Shutter Speed

Should you wish to select a shutter speed to meet a specific photographic situation (for example, to stop fast action, eliminate camera shake, etc.):

- 1) Turn the shutter speed ring until the desired speed is opposite the red reference dot on the camera lens.
- 2) Look through the viewfinder and turn the aperture ring until the needle lines up in the center of the index. For fine exposure adjustment you can use any intermediate F stop position on the aperture ring.
- 3) If the needle will not align properly, select a new shutter speed. To correct over-exposure (+), try a faster speed; to correct under-exposure (-), try a slower speed.

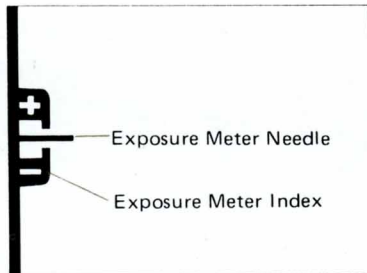

■ Preselecting the F Stop

Should you wish to preselect the F stop (for example, to control depth of field for greater creative impact):

- 1) Turn the aperture ring until the desired F stop is opposite the white index mark at the front of the lens barrel.
- 2) Look through the viewfinder and rotate the shutter speed ring until the needle lines up as close as possible to the center of the index. Make sure that shutter speed meets the other requirements of the situation.
- 3) Make the final exposure adjustment by turning the aperture ring slightly until the needle aligns exactly in the center of the index.

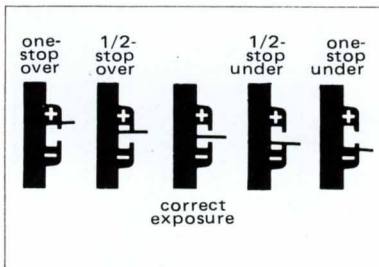

■ Making Intentional Over- or Under-exposures

You can make intentional over- or under-exposures to meet special lighting requirements (such as backlighting, sidelighting, etc.) by using the central index in the viewfinder as a guide. When the needle swings towards the (+) position, it indicates over-exposure. When it swings towards (-), it indicates under-exposure. The exact F stop-needle relationship is shown in the above diagrams.

■ Stop-down Exposure Readings

When using the OM-1 MD in conjunction with the extension tubes, bellows or the Zuiko Shift Lens it is necessary to take meter readings with the lens stopped-down. After setting the desired aperture on the aperture ring, stop the lens diaphragm down and look through the viewfinder. Rotate the shutter speed ring until the needle aligns within the center of the index. (See the instructions on Preselecting the F Stop, page 13.)

■ Special Exposure Techniques

1) Backlighting and Sidelighting

When the most important area of the picture is much darker than the general picture area (strong light hitting the main subject from behind or from the side) the meter will have a tendency to read the brightest part of the picture leaving the main subject under-exposed. To compensate for this, move in towards the subject until most of the subject image appears in the viewfinder and take your meter reading. After setting the exposure, return to your original position to take the picture. If this procedure cannot be followed, you can obtain approximately the same

results by simply opening your lens one full F stop over the indicated meter reading. (NOTE: With backlighting or sidelighting, it's always a good idea to use a lens hood to eliminate unwanted glare.)

2) Strong Frontlighting and Deep Shadows

When taking a picture of a bright subject against a dark background (spotlights, deep shadow areas, etc.) the meter has a tendency to read the darkest part of the picture leaving the main subject over-exposed. To compensate for this use the same procedure for setting exposure as outlined for backlighting. You can also approximate the proper exposure by holding your position and closing the lens down one full F stop from the indicated meter reading.



The OLYMPUS OM-1 MD comes equipped with a standard microprism-matte type focusing screen which is designed to make focusing quick and easy. To focus, look through the camera viewfinder and turn the focusing ring in either direction until your subject appears sharpest. The "shimmering effect" of the central spot in the focusing screen will disappear when critical focusing has been achieved.



▲ In focus



▲ Out of focus

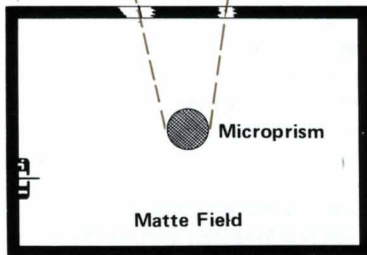

The OM-1 MD viewfinder takes in 97% of the actual picture area for added convenience when composing your pictures.



The OM-system interchangeable focusing screens provide you with the ultimate in focusing versatility. There are optional screens available to suit virtually every picture-taking situation. The optional focusing screens come with a special tool. To remove the focusing screen (for demounting the lens see page 30):

- Insert the tool into the camera and pull on the release catch. This allows the screen and screen frame to drop down.
- Using the tool, the screen can be made to drop completely down without touching it. Remove the screen by gripping the plastic tipped portion of the screen between the tool's jaws and with light but firm pressure remove the screen

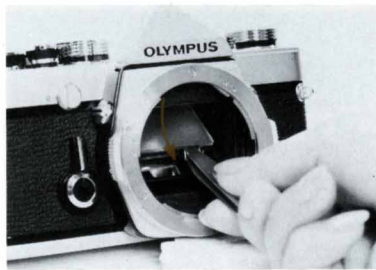

from the camera.













- For installing the screen — reverse the above procedure.

IMPORTANT:

Although the above procedure could be done with fingers, the use of a pair of tweezers is a must. Because **changing focusing screens is a procedure to be handled with great care.** Trying to change screens with your fingers can result in fingerprints and costly damage to the surface of the screen, the prism or the mirror. Should this occur, cleaning or repair **MUST** be handled by an authorized service center. Such damage is not covered by the product warranty.

See page 34 for the lens/screen combination table and page 55 for the features.

List of Optional Focusing Screens

1-1  Microprism-matte type (for most lenses)	1-7  Microprism-clear field type (for super telephoto lenses)
1-2  Microprism-matte type (for standard and telephoto lenses)	1-8  Under development
1-3  Split image-matte type (for most lenses)	1-9  Clear field type (for endoscopic photography)
1-4  All matte type (for most lenses)	1-10  Checker-matte type
1-5  Microprism-clear field type (for wide angle and standard lenses)	1-11  Cross Hairs-matte type (for close-up and macro-photography)
1-6  Microprism-clear field type (for standard and telephoto lenses)	1-12  Cross Hairs clear field type (for photomicrography and macrophotography greater than life size)

Specifications subject to change without notice.



The OM-1 MD provides an infrared index mark engraved in red on the depth of field scale to the right of the reference dot. When shooting with infrared film, focus normally on your subject and read the subject distance on the distance scales. Then, turn the focusing ring to the right until the distance reading is opposite the infrared index line. Your lens will then be in focus for average infrared photography. In the above picture the red index is set at infinity.

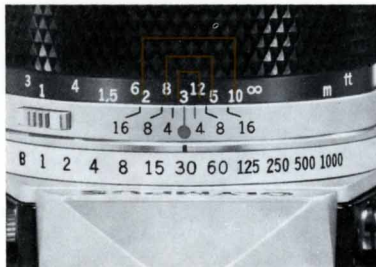

The double series of numbers engraved on the depth of field scale represents F stops: F4, F8 and F16. Once you have focused on your subject, all subjects within the distance range indicated on the lens distance scale between the marks for the F stop you have selected will have acceptable sharpness.

For example, in the above picture the camera-to-subject distance is 3m (10ft) and the lens is set at F16. If you read the distance scale at the points opposite the engraved "16" on both sides of the reference dot, you will find that the depth of field is from 1.9m (6ft) to 7m (23ft). The depth of field can be visually verified by pressing the depth of field preview button.



When you wish to see which objects fall within the acceptable zone of sharpness (depth of field), press the preview button on your lens. The diaphragm of the lens will stop down to the preset F stop enabling you to see the depth of field in the camera viewfinder.

* If you jerk the preview button while depressing the shutter button halfway down, the shutter might get released. Gently push and release the preview button to prevent such an accident.

Depth of field is the area of acceptable sharpness in front of and behind the subject in focus. This depth is determined by the F stop you have selected and the distance from the subject in focus to the film plane. As you get closer to your subject or as you open your lens (e.g. from F22 to F2.8) the depth of field becomes shallower. By stopping your lens down (e.g. from F2.8 to F22) or getting farther away from your subject this depth of field or zone of acceptable sharpness can be increased.

Another factor in determining depth of field is the focal length of your lens. As a rule the shorter the focal length, the greater the zone of acceptable sharpness. The longer the focal length, the shallower this zone becomes.

The table above shows that when the camera-to-subject distance is 3m (10ft), the depth of field at F16 ranges from 1.93m (6ft) to 6.93m (23ft).



F1.8 (1/1000 sec.) F16 (1/30 sec.)

Depth of Field Table (F1.8 & F1.4 Standard Lenses) Circle of least confusion 1/30 mm

F Stop	Camera-to-Subject Distance (m) . Figures with * are engraved on the distance scale.									
	*0.45	*0.5	*0.7	*1	*1.5	*2	*3	*5	*10	*∞
1.4	0.45 ~0.45	0.50 ~0.50	0.69 ~0.71	0.99 ~1.02	1.47 ~1.54	1.94 ~2.07	2.86 *3.16	4.61 ~5.46	8.55 ~12.05	57.78 ~∞
1.8	0.45 ~0.45	0.50 ~0.50	0.69 ~0.71	0.98 ~1.02	1.46 ~1.55	1.92 ~2.09	2.82 *3.20	4.52 ~5.60	8.21 ~12.79	45.05 ~∞
2	0.45 ~0.45	0.50 ~0.50	0.69 ~0.71	0.98 ~1.02	1.45 ~1.55	1.91 ~2.10	2.80 *3.23	4.47 ~5.68	8.05 ~13.20	40.57 ~∞
2.8	0.45 ~0.45	0.49 ~0.51	0.69 ~0.71	0.97 ~1.03	1.43 ~1.57	1.88 ~2.14	2.73 *3.33	4.28 ~6.01	7.47 ~15.15	29.02 ~∞
4	0.44 ~0.46	0.49 ~0.51	0.68 ~0.72	0.96 ~1.04	1.41 ~1.61	1.83 ~2.20	2.63 *3.49	4.04 ~6.57	6.74 ~19.44	20.35 ~∞
5.6	0.44 ~0.46	0.49 ~0.51	0.67 ~0.73	0.94 ~1.06	1.37 ~1.66	1.77 ~2.29	2.51 *3.74	3.75 ~7.52	5.96 ~31.31	14.55 ~∞
8	0.44 ~0.46	0.48 ~0.52	0.66 ~0.74	0.92 ~1.09	1.32 ~1.73	1.69 ~2.45	2.34 *4.18	3.39 ~9.61	5.09 378.10	10.21 ~∞
11	0.43 ~0.47	0.48 ~0.53	0.65 ~0.76	0.90 ~1.13	1.27 ~1.84	1.60 ~2.68	2.17 *4.91	3.02 ~14.74	4.30 ~∞	7.44 ~∞
16	0.43 ~0.48	0.47 ~0.54	0.63 ~0.79	0.86 ~1.20	1.19 ~2.05	1.47 ~3.17	1.93 *6.93	2.57 138.43	3.42 ~∞	5.13 ~∞

F Stop	Camera-to-Subject Distance (ft) . Figures with * are engraved on the distance scale.							
	*2	*3	*4	*6	*8	*12	30	*∞
1.4	1.98 ~2.02	2.96 ~3.04	3.93 ~4.08	5.83 ~6.18	7.69 ~8.33	11.31 ~12.78	25.97 ~35.51	187.12 ~∞
1.8	1.98 ~2.02	2.95 ~3.05	3.91 ~4.10	5.78 ~6.23	7.61 ~8.43	11.13 ~13.01	25.02 ~37.47	146.31 ~∞
2	1.98 ~2.02	2.94 ~3.06	3.90 ~4.11	5.76 ~6.26	7.57 ~8.48	11.05 ~13.14	24.57 ~38.54	131.88 ~∞
2.8	1.97 ~2.03	2.92 ~3.08	3.86 ~4.15	5.67 ~6.37	7.41 ~8.69	10.71 ~13.66	22.91 ~43.50	94.60 ~∞
4	1.96 ~2.05	2.89 ~3.12	3.80 ~4.22	5.54 ~6.54	7.19 ~9.02	10.23 ~14.51	20.81 ~53.91	66.45 ~∞
5.6	1.94 ~2.07	2.85 ~3.17	3.72 ~4.32	5.38 ~6.79	6.91 ~9.51	9.67 ~15.85	18.54 ~79.26	47.60 ~∞
8	1.91 ~2.10	2.79 ~3.25	3.62 ~4.48	5.15 ~7.20	6.53 ~10.35	8.93 ~18.38	15.95 ~270.28	33.41 ~∞
11	1.88 ~2.13	2.72 ~3.35	3.49 ~4.69	4.89 ~7.79	6.11 ~11.64	8.15 ~23.00	13.58 ~∞	23.36 ~∞
16	1.83 ~2.20	2.61 ~3.51	3.31 ~5.09	4.52 ~9.02	5.53 ~14.70	7.12 ~39.68	10.89 ~∞	16.80 ~∞

Motor Drive has many exciting recreational, professional and scientific applications including sports photography, action portraits, copying literature, wildlife photography and time-lapse photography.

By automatically advancing the film and cocking the shutter, the motor drive not only frees the photographer from the burden of manually advancing the film, but also allows him to shoot a series of pictures that might otherwise be lost through the time-consuming manual method. The Motor Drive package is specifically

tailored to the compact size of the Olympus OM-1 MD. Extremely small and lightweight, the Motor Drive 1 mounts directly to the camera base creating one of the most compact and maneuverable motor drive systems available. Although reduced in size and weight, the OM-System Motor Drive Group excels in performance. The basic Motor Drive package can provide operation up to 5 frames per second in optimum conditions*, has single release capability and offers motor drive sequence applications over a wide range of shutter speeds.

The following instructions are for the basic motor drive system consisting of the Olympus OM-1 MD, Motor Drive 1, M. 18V Control Grip 1 and M. 18V Battery Holder 1.

*Optimum conditions: Maximum framing rate varies with temperatures, types of films and batteries, etc. The word optimum implies such conditions in which sequence filming is made at normal temperatures at shutter speeds of 1/500 of a second and faster, using the M. 18V Control Grip 1 containing fresh superpower manganese batteries. Cartridges with smooth film moving must also be used.

Motor Drive 1 / M.18V Control Grip 1

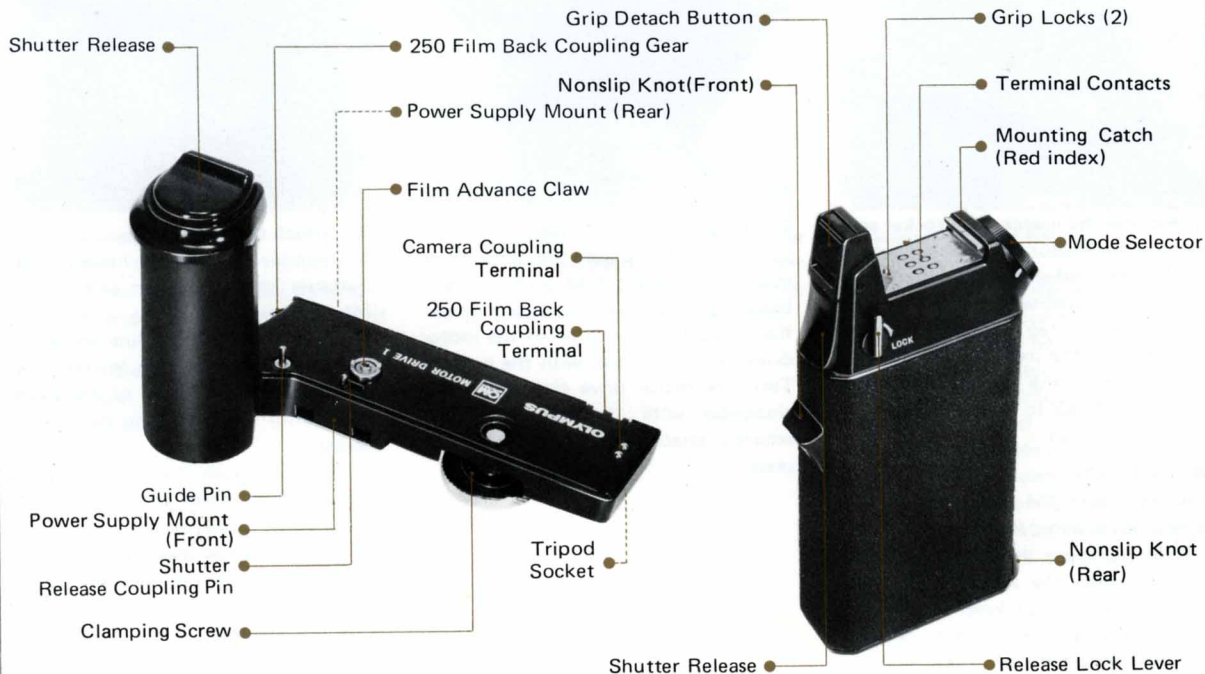

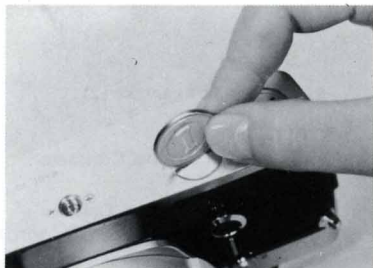

1. Remove the motor drive socket cap.

Remove the motor drive socket cap on the camera baseplate by rotating it counter-clockwise with a coin.

To replace the cap, align the index of the cap with the index of the camera, press and turn the cap 90° clockwise with your finger to hitch, then with a coin until it stops.

IMPORTANT:

* Always store the socket cap in the same place to avoid loss.

* After removing the motor drive be sure to replace the socket cap on the camera baseplate to keep the camera free of dust and dirt, and to prevent the possibility of stray light entering the socket and fogging the film.

* Do not remove the socket cap when you do not use the motor drive.

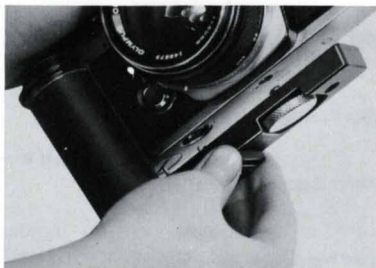

2. Attach the motor drive.

Insert the guide pin on the motor drive into the guide pin hole on the camera baseplate. To assure proper connection, adjust the position of the motor drive until it is flush with the camera. Turn the motor drive clamping screw clockwise until the motor drive is securely attached to the camera baseplate.



3. Attach the control grip.

1) Remove the battery holder, insert batteries into the holder and insert it into the control grip.

2) Align the red index line on the rear of the control grip with the red index line on the rear frame of the motor drive until the mounting catch is engaged.

3) Carefully push the control grip forward and up until it snaps into the front of the motor drive.

4) Shoot several blank exposures by pressing the shutter release on the control grip to make sure the units are attached properly.

5) To remove the control grip, push in and down on the grip detach button to disengage the grip locks, and then lift apart.

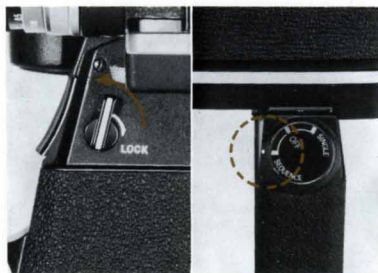

4. Take the pictures.

1) Unlock the shutter release lock lever on the control grip by moving it forward and up opposite the word "LOCK".

2) Turn the mode selector on the control grip to either "SINGLE" or "SEQUENCE".



3) To release the shutter, press either the shutter release on the control grip or atop the handgrip of the motor drive, whichever is more convenient.

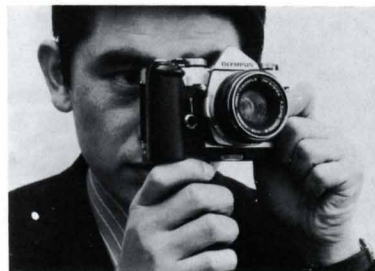

• Manual Shutter Release

Should you wish, you can use the camera's shutter release even with the motor drive and control grip attached. The film can then be advanced manually or with the motor.

• Loading and Unloading the Camera
Load and unload the camera in the normal manner (see page 7 & 10).

• Always try to load your camera **after** the motor drive has been attached. This eliminates even the remotest possibility of light leak through the motor drive socket.

Proper camera handling is important in assuring the sharpest possible pictures. Even slight camera movement can result in "blurred" photographs. To hold the camera properly, support the camera/lens combination with most of the weight resting in the palm of your left hand, while applying your right hand to the camera's side. Transport the film advance lever with your right thumb and squeeze the release button smoothly using the cushion, not the tip, of your index finger. The aperture ring, focusing ring and shutter speed ring are so arranged as to enable you one hand operation with left fingers right up to the moment the shutter is released. Hold your breath at the moment of shutter release.

※ When holding the camera horizontally, keep both elbows close to the body.

※ For vertical shooting, keep one elbow close to your body and press the camera tightly against your forehead.

※ Steady yourself against any nearby support (such as a tree, fence, or wall) whenever possible.

※ When hand-holding a telephoto lens, camera shake is magnified as the focal length increases. Always try to

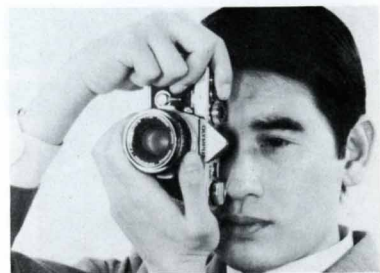
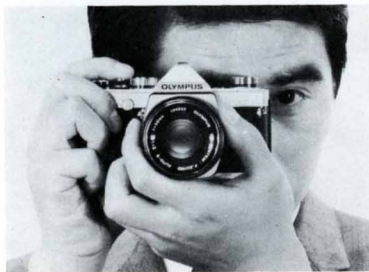

use the fastest possible shutter speed lighting conditions will allow.

※ When shooting under 1/30 of a second, using a stable platform or

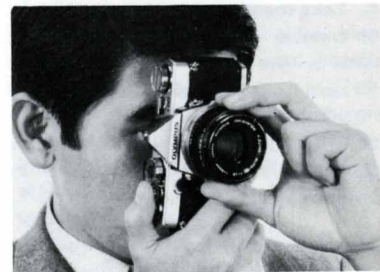

tripod is recommended. This eliminates the possibility of jarring the camera and is particularly important with telephoto lenses.

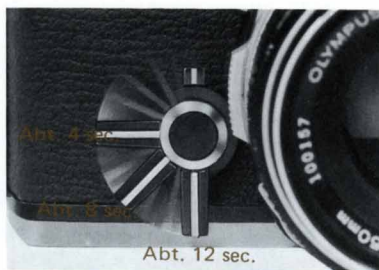
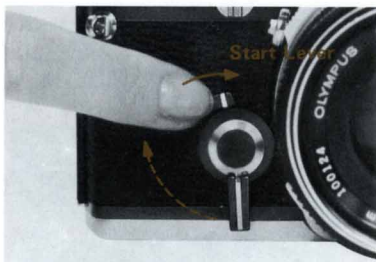

The self-timer provides a method of taking delayed action pictures allowing you to get into your own photographs. It is also ideal for macrophotography when a cable release is not available.

To set the self-timer:

- 1) Rotate the self-timer lever counter-clockwise until it stops (approximately 180°). Make sure the film has been advanced properly.
- 2) Turn the start lever clockwise to the vertical position to activate the self-timer lever. The shutter will then be released in approximately 12 seconds. You can adjust the delay time between four and twelve seconds by adjusting the lever as shown above.

If the film has not been advanced properly, the timer lever will stop halfway and the shutter will not fire. To re-activate the timer, move the start

lever counter-clockwise to stop the timer lever, return the timer lever to the starting position, and advance the film. Then, turn the start lever again. **NOTE:** If you do not reset the self-timer, the timer lever will begin moving immediately after advancing the film and the shutter will be released earlier than expected.

You may set the self-timer lever either before or after advancing the film. Even after setting the lever, you can release the shutter by pressing the shutter release button. To stop the self-timer during its operation, turn the start lever counter-clockwise.



To minimize camera vibration in close-ups, reproduction work, macrophotography and photomicrography, you can lock the instant return mirror in the up position to eliminate mirror shock. This is also handy in rapid sequence shooting. To lock up the mirror, compose and focus on your subject and then turn the mirror lock-up lever counter-clockwise until it stops (approximately 90°). After shooting, always return the lock-up lever to its original position.

NOTE: You can lock up the mirror at any photographing stage — before or after advancing the film. However, **do not** carry the camera in direct sunlight with the mirror locked up. This can result in damage to the shutter curtains.



1. First select the proper flash synchronization.

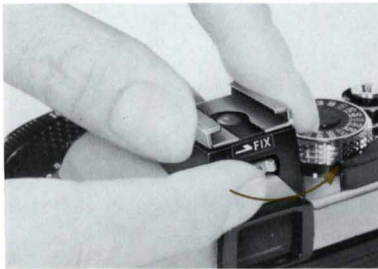

2. Attach the optional accessory shoe.

Pull off the black cover on the camera's hot shoe socket and mount the accessory shoe to the camera by turning the screw in the direction of the arrow ("FIX").

NOTE: Detach the accessory shoe and replace the black cover whenever a flash is not mounted on the camera or when using "L" bracket to support the flash unit.

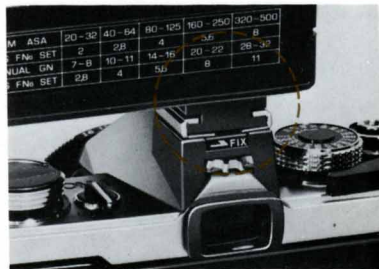

3. Attach the flash unit.

Insert the shoe of the flash unit into the accessory shoe and insert the PC tip of the flash into the synchronizing socket. If your flash unit has a built-in hot shoe, simply mount the unit directly to the accessory shoe. Your flash will then be fully synchronized to the camera through the contacts in the shoe.



The table indicates proper synchronization speeds for most flash equipment.

		500	250	125	60	30	15	8	4	2	1
FP	FP	○	○	○	○	※	※	※	※	※	※
X	MF					○	○	○	○	○	○
	M · FP						○	○	○	○	○

(○ recommended; ※ not recommended due to bulb quality)



4. Determine the exposure.

First determine the shutter speed that matches the type of flash you are using.

Once you have set the proper shutter speed, determine the F stop by using the calculator dial or exposure table attached to your flash unit. You can determine the F stop manually by using the following formula:

$$F \text{ stop} = \frac{\text{flash guide number}}{\text{flash-to-subject distance}}$$

Additional flash information can be found in the instructions which accompany your flash equipment or flashbulbs.



■ **OLYMPUS Flash CL**

This cordless contact microflash is extremely compact and uses standard AG-1, AG-3N and AG-1B type bulbs. Guide number (ASA 80)

- AG-1, AG-3N: 28 (90 in case of feet)
- AG-1B: 20 (65 in case of feet)

■ **Accessory Shoe 1**

When mounted on the OM-1MD, works as a direct contact shoe.



■ **OLYMPUS PS 200**

OLYMPUS PS 200 Electronic Flash (center contact) operates on 2 pcs. 1.5V penlight batteries and AC house current.

Guide number: 14 (45 in feet) at ASA 80. Color temperature: 5,800° Kelvin. 200 flashes from a set of fresh batteries. 31 x 55 x 64 mm, 75 gr. (1 1/4x2 1/8x2 1/2in., 2 3/8oz.).

In reference to the below exposure table, for example, when the distance scale reads 5m, set the aperture ring at F2.8 (ASA 80).

GN	GN			ft																			
ft	m	ASA	m	0.8	1.2	1.7	2.5	3.5	5	7	10	14	20	28	36	45	56	64	72	81	90	100	
90	28	360-400		22	16	11	8	5.6	4	2.8	2												
65	20	160-200		22	16	11	8	5.6	4	2.8	2												
45	14	80-100		16	11	8	5.6	4	2.8	2	1.4												
23	7	25-32		8	5.6	4	2.8	2	1.4														

Q: My camera is loaded with film but the rewind knob doesn't rotate when I advance the film advance lever. Why?

A: The film leader may not be inserted in the film take-up spool and the film is not advancing properly. See pages 7 & 8.

Q: The film is not advancing. Why?

A: The shutter may be cocked and ready to fire. Release the shutter release button. If this is not the case, your film may be fully exposed. Check the exposure counter. If you feel tension on the film advance lever, DO NOT FORCE IT. Rewind the film. See pages 9 & 10.

Q: The shutter release button will not move and I can't take the picture. Why?

A: The film advance lever may not have been fully advanced. See page 9.

Q: The rewind crank will not turn when I try to rewind the film. Why?

A: The rewind release lever may not be set properly. Make sure the lever is rotated until the red line is opposite the "R." See page 10.

Q: Why can't I turn the ASA film speed dial?

A: The film speed dial release button must be pressed before the dial can be turned. Once the dial had been set, release the button and make sure the dial has locked into place. See page 12.

Q: Why isn't the needle in the viewfinder moving?

A: First, make sure the meter switch lever is set to the "ON" position. If the meter is on, turn the camera towards a bright light source. If the needle still will not move, the battery may not be inserted, may be inserted improperly or may be drained. Replace the battery or insert it properly. See page 7.

Q: How do I take meter readings when a bellows or extension tubes are mounted to my camera?

A: Since lens extension devices disconnect the automatic diaphragm mechanism between camera and lens, readings must be taken with the lens stopped-down. Take an exposure reading using the procedure outlined on page 14.

Q: The microprism in the center of the viewfinder "shimmers" and gets dark. Is that normal?

A: Yes, this is a natural phenomenon that occurs when a lens with a maximum aperture smaller than F5 is mounted on the camera. It also happens with a standard lens when the depth of field preview button is pressed. The microprism is not faulty.

Q: The viewfinder is totally dark and I can't see anything. Why?

A: Make sure you have removed the lens cap. If the cap has been removed, the mirror lock-up lever may be in the up position. Return the mirror to its operational position. See page 24.

Q: When I touch the terminal socket of the accessory hot shoe I feel current. Why?

A: This is normal when the hot shoe is attached. If you are not using flash or are using a flash bracket, the shoe is not necessary and should be removed. See page 25.

Q: The self-timer lever stopped halfway and plays. Why?

A: The self-timer lever stopped halfway because the film advance lever has not been transported fully and hence the shutter cannot be released. Turn the

start lever counter-clockwise, reset the self-timer lever to the desired time, advance the film fully and turn the start lever clockwise to activate. The self-timer lever plays because you forgot to turn the start lever to release the shutter after you have set the self-timer lever. See page 24.

Q: Can I take the pictures with the motor drive socket cap being detached?

A: No, you must replace the cap whenever the motor drive is not attached to the camera's baseplate because dust and dirt may get into the socket causing malfunction and light may enter and fog the film. See page 21.

- When you will not use the camera for a long period of time, store it with the shutter uncocked and turn off the self-timer and exposure meter. Keep it free from dust and moisture, and remove it from the case.

- Do not drop the camera and avoid hitting it.

- When storing the camera for a long period of time, remove the battery. Wipe the battery surface with a dry cotton cloth before re-inserting it in the camera.

- Never store the camera where temperatures exceed 50°C (122°F). When you use the camera in temperatures under -20°C (-4°F), it may sometimes fail to operate properly. To avoid this, warm the camera before use. Protect against excess moisture by using silica gel or other desiccant.

- Never expose the camera to direct sunlight. Avoid areas exposed to salt water, salt air, radios, TV sets or magnets.

- Avoid touching the surface of the lens. Clean only with an air brush, anti-static brush, or wipe it lightly with a camel hair brush or lens tissue. In

EXTREME cases use a clean, soft cotton cloth moistened with denatured alcohol. **NEVER** rub the lens surface with your finger, clothing or any other abrasive material.

- If dust or fingerprints collect on the mirror, focusing screen or prism, take it to an authorized Olympus service center. It needs professional attention.

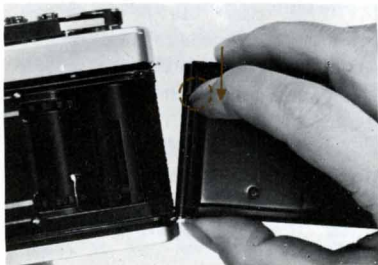

The rear cover of the OM-1 MD is fully interchangeable with the Recordata Back and 250 Film Back 1. To remove the rear cover, push down on the release pin as shown. Do not remove the cover unless necessary.

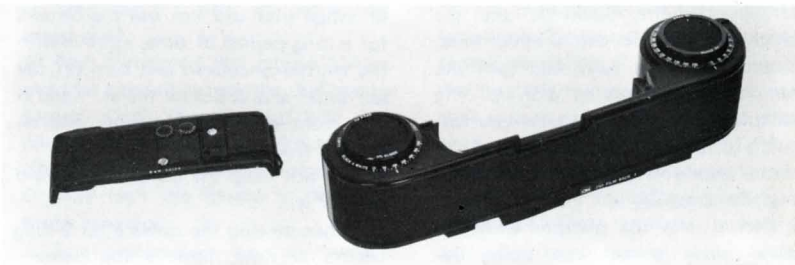

■ **Recordata Back**

Registers numbers directly on the picture.

■ **250 Film Back 1**

Designed for motor drive shooting, the magazine accepts bulk film for 250 exposures. (See P.38)





The bayonet mount of the OLYMPUS OM-1 MD allows you to change lenses quickly and easily.

To detach the lens, press down on the lens release button and turn the lens counter-clockwise. Grasp the lens firmly and remove it from the camera body.

Protect your lens and camera! Always attach the front and rear lens caps when the lens is removed from the camera to prevent any possibility of damage. Never leave the camera body in direct sunlight with the lens removed and, if you plan to store the camera without the lens, the use of a body cap is recommended.



To mount the lens, grasp the lens firmly and align the red dots on the lens flange and the camera mount ring. Turn the lens clockwise until it locks in place. The lens release button will spring up and you will hear a positive "click" when the lens has been fully engaged. **Do not apply pressure to the lens release button during the mounting procedure.** This will assure proper coupling between the lens and the meter.

One of many advantages of the single lens reflex type of camera is the large variety of interchangeable lenses available. The Zuiko Interchangeable Lens Group (designed and manufactured by Olympus) comprises 30 lenses including those now in the course of development. Zuiko lenses have always enjoyed a high reputation in photographic circles — new design technology has made possible a new series of innovative, high performance lenses. These lenses have a host of special features including a new construction that compensates for close focus aberrations, increased aperture ratio in the wide angle lenses, and reduction in telephoto lens size and weight. The OM-System adopts 49mm filters for most lenses from 21mm to 200mm. As part of the OM-System design all the lenses now offer higher performance in small configurations. Olympus has produced lenses for microscopes for many years and the new Zuiko lenses benefit from this scientific experience. See the "OM-System Zuiko Interchangeable Lenses" instructions for further information.































TYPE	INTERCHANGEABLE LENSES		ANGLE OF VIEW	OPTICAL CONSTRUCTION ELEMENT-GROUP	DIA-PHRAGM	F-STOP RANGE	MIN. FOCUS (ft.)	MIN. PHOTOGRAPHIC RANGE
FISHEYE	ZUIKO AUTO-FISHEYE	8mm F2.8	180° (circle)	11-7	AUTO.	2.8-22	0.2 m (0.7)	
	ZUIKO AUTO-FISHEYE	16mm F3.5	180°	11-8	AUTO.	3.5-22	0.2 m (0.7)	
SUPER WIDE	L ZUIKO AUTO-W	18mm F3.5	100°	12-10	AUTO.	3.5-16	0.2 m (0.7)	21×14cm
	G ZUIKO AUTO-W	21mm F3.5	92°	7-7	AUTO.	3.5-16	0.2 m (0.7)	21×14cm
	J ZUIKO AUTO-W	24mm F2	84°	10-8	AUTO.	2-16	0.25m (0.8)	23×15cm
	H ZUIKO AUTO-W	24mm F2.8	84°	8-7	AUTO.	2.8-16	0.25m (0.8)	23×15cm
WIDE	I ZUIKO AUTO-W	28mm F2	75°	9-8	AUTO.	2-16	0.3 m (1.0)	27×18cm
	G ZUIKO AUTO-W	28mm F3.5	75°	7-7	AUTO.	3.5-16	0.3 m (1.0)	27×18cm
	H ZUIKO AUTO-W	35mm F2	63°	8-7	AUTO.	2-16	0.3 m (1.0)	21×14cm
	G ZUIKO AUTO-W	35mm F2.8	63°	7-6	AUTO.	2.8-16	0.3 m (1.0)	21×14cm
STANDARD	G ZUIKO AUTO-S	55mm F1.2	43°	7-6	AUTO.	1.2-16	0.45m (1.5)	23×15cm
	G ZUIKO AUTO-S	50mm F1.4	47°	7-6	AUTO.	1.4-16	0.45m (1.5)	24×16cm
	F ZUIKO AUTO-S	50mm F1.8	47°	6-5	AUTO.	1.8-16	0.45m (1.5)	24×16cm
ZOOM	ZUIKO AUTO-ZOOM	75-150mm F4	32°-16°	15-11	AUTO.	4-22	1.6 m (5.2)	32×21cm 64×42cm
TELEPHOTO	F ZUIKO AUTO-T	85mm F2	29°	6-4	AUTO.	2-16	0.85m (2.8)	25×17cm
	E ZUIKO AUTO-T	100mm F2.8	24°	5-5	AUTO.	2.8-22	1 m (3.3)	29×19cm
	E ZUIKO AUTO-T	135mm F2.8	18°	5-5	AUTO.	2.8-22	1.5 m (4.9)	32×21cm
	E ZUIKO AUTO-T	135mm F3.5	18°	5-4	AUTO.	3.5-22	1.5 m (4.9)	32×21cm
	E ZUIKO AUTO-T	200mm F4	12°	5-4	AUTO.	4-32	2.5 m (8.2)	36×24cm
	F ZUIKO AUTO-T	200mm F5	12°	6-5	AUTO.	5-32	2.5 m (8.2)	36×24cm
SUPER TELEPHOTO	F ZUIKO AUTO-T	300mm F4.5	8°	6-4	AUTO.	4.5-32	3.5 m (11.5)	33×22cm
	E ZUIKO AUTO-T	400mm F6.3	6°	5-5	AUTO.	6.3-32	5 m (16.4)	36×24cm
	F ZUIKO AUTO-T	600mm F6.5	4°	6-4	AUTO.	6.5-32	11 m (36.1)	55×37cm
	E ZUIKO AUTO-T	1000mm F11	2.5°	5-5	AUTO.	11-45	30 m (98.4)	98×65cm
SPECIAL USE	ZUIKO SHIFT	35mm F2.8	63°-84°	8-7	MANUAL	2.8-22	0.3 m (1.0)	21×14cm
	ZUIKO AUTO-MACRO	50mm F3.5	47°	5-4	AUTO.	3.5-22	0.23m (0.8)	72×48mm
	ZUIKO MACRO	20mm F3.5	9° at highest mag.	4-3	MANUAL	3.5-16		max. 8×5mm min. 3×2mm
	ZUIKO MACRO	38mm F3.5	9° at highest mag.	5-4	MANUAL	3.5-16		max. 20×13mm min. 6×4mm
	ZUIKO 1:1 MACRO	80mm F4	9° at highest mag.	6-4	MANUAL	4-22		max. 72×48mm min. 18×12mm

Compatible: The meter needle indicates proper exposures. In the combination marked with *, microprism, split-prism and edges of the finder get dark.

 Compatible: The meter needle does not indicate proper exposures.

WEIGHT (oz.)	LENGTH	MAX. DIAMETER	HOOD	FILTER	1-1	1-2	1-3	1-4	1-5	1-6	1-7	1-9	1-11	1-12
					Micro-matte type	Micro-matte type	Split-matte type	All matte type	Micro-clear fied type	Micro-clear fied type	Micro-clear fied type	Clear fied type	Cross hairs-matte type	Cross hairs-matte type
690g (24.3)	72mm	102mm	—	Built-in		*								
180g (6.3)	31mm	59mm	—	Built-in		*								
250g (8.8)	42mm	75mm	72mm Screw-in	72mm		*								
180g (6.3)	31mm	59mm	49mm Screw-in	49mm		*								
270g (9.5)	48mm	60mm	55mm Screw-in	55mm		*								
180g (6.3)	31mm	59mm	49mm Screw-in	49mm		*								
240g (8.5)	43mm	60mm	49mm Screw-in	49mm		*								
180g (6.3)	31mm	59mm	49mm Screw-in	49mm		*								
230g (8.1)	42mm	60mm	55mm Screw-in	55mm										
170g (6.0)	33mm	59mm	51mm Slide-on	49mm										
310g (10.9)	47mm	65mm	57mm Slide-on	55mm										
230g (8.1)	36mm	60mm	51mm Slide-on	49mm										
170g (6.0)	31mm	59mm	51mm Slide-on	49mm										
430g (15.2)	115mm	63mm	Built-in	49mm										
270g (9.5)	46mm	60mm	49mm Screw-in	49mm										
230g (8.1)	48mm	60mm	49mm Screw-in	49mm										
360g (12.7)	80mm	61mm	Built-in	55mm										
280g (9.9)	73mm	60mm	Built-in	49mm										
490g (17.3)	127mm	67mm	Built-in	55mm										
370g (13.1)	105mm	62mm	Built-in	49mm	*									
1000g (35.3)	181mm	80mm	Built-in	72mm	*									
1300g (46.0)	255mm	80mm	Built-in	72mm	*		*							
2800g (98.8)	377mm	110mm	Built-in	100mm	*		*							
4000g (141.0)	662mm	110mm	Built-in	100mm	*	*	*							
350g (12.3)	57mm	70mm	49mm Screw-in	49mm	*	*	*							
200g (7.1)	40mm	60mm	—	49mm										
50g (1.8)	20mm	26mm	—	21mm Slide-on	*	*	*	*						
70g (2.5)	28mm	37mm	—	32mm Slide-on	*	*	*							
200g (7.1)	46mm	59mm	—	—	*	*	*							

FOR ENDOSCOPIC PHOTOGRAPHY

FOR MACROPHOTOGRAPHY & PHOTOMICROGRAPHY

Designed specifically to match the OM-1 MD, the Motor Drive Group has been reduced in size to enhance its maneuverability and ease of operation. Both the hadgrip type motor drive and the control grip provide a built-in shutter release button so that the photographer can even hand-hold a 300mm telephoto lens for shooting sports or other action subjects. A 250 exposure roll film back and other units attach to the OM-1 MD without cords. This motor drive group is also a convenient accessory when used with other groups for close-up macrophotography, photomicrography, etc. The Motor Drive Group consists of a number of units for sequential exposures in all types of photography. A remote control mechanism can be used for a series of exposures in short time period exposures taken intermittently in conjunction with the M. AC Control Box, or a series of exposures with bulk film.



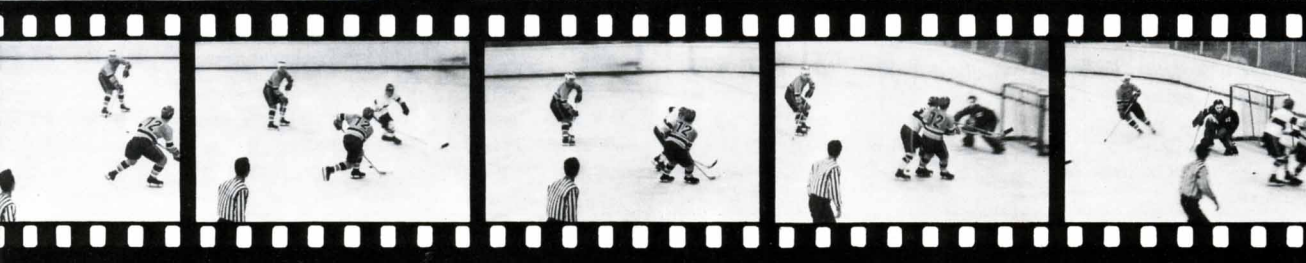

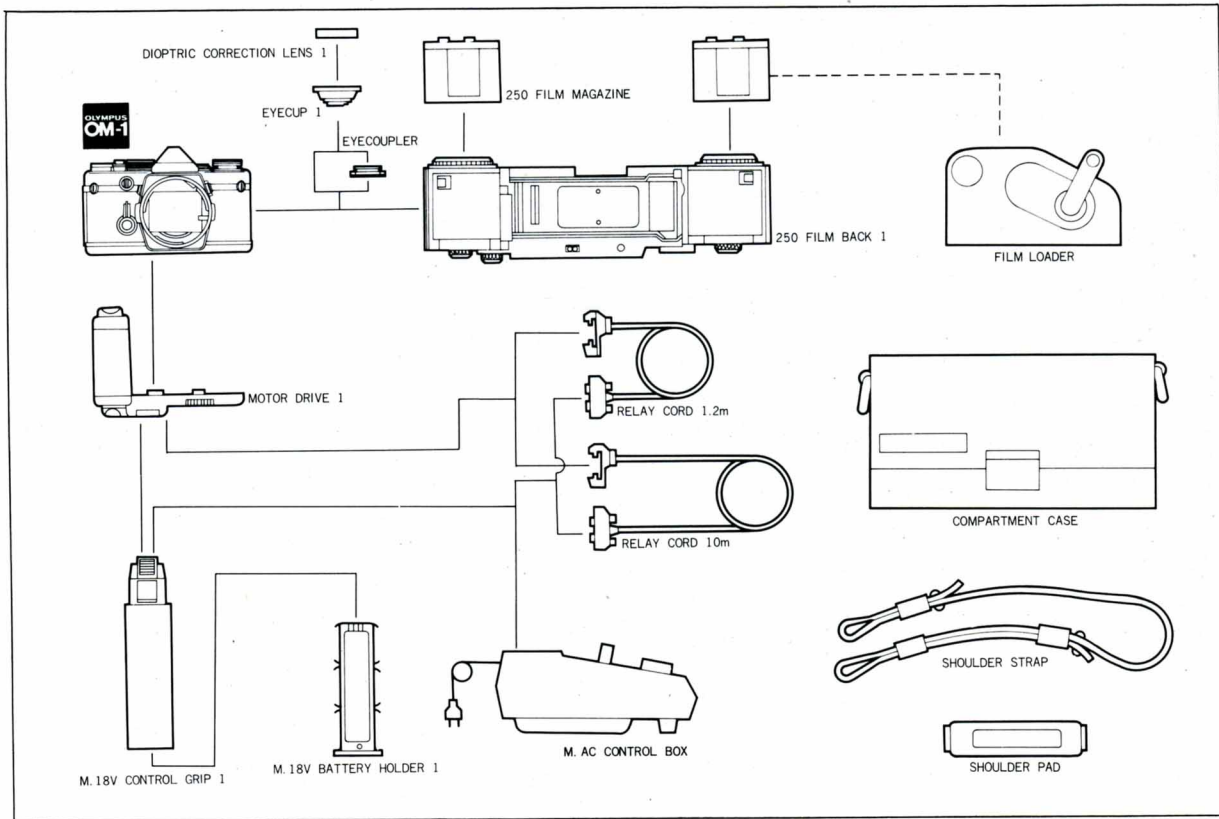



■ Motor Drive 1

Directly connects to the OM-1 MD using the tripod socket. Operating on various power sources, it is capable of single-frame shooting and sequential filming of 5 frames per second.



■ 250 Film Back 1

Can be quickly attached to the OM-1 MD in place of the standard rear cover, and used with the Motor Drive 1 and Control Grip 1 or M.AC Control Box for roll film up to 250 exposures (10m or 33 1/3 feet long).



■ 250 Film Magazine

Accommodates a 250-exposure film and is installed into the 250 Film Back 1. Two Magazines are necessary, one magazine holds the bulk film and a second magazine is used as a take-up spool.

■ 250 Film Loader



■ M.18V Control Grip 1 (M. 18V Battery Holder 1)

A power supply that accepts 12 AA Alkaline or NiCad batteries. Can be attached quickly to the Motor Drive 1. Complete with a built-in release button, single and sequence selector switch and release lock lever.



■ M.AC Control Box

AC transformer element for use with household current. Incorporates a selector switch between single-frame operation and sequential exposure operation, two terminals for the relay cord and a timer for time-lapse exposures.



■ Relay Cords

Extension cord for remote control; one is 1.2m (4') long, the other 10m (32'9 3/4'') long. The plugs incorporate a remote terminal and a DC terminal.

A single-lens reflex camera is probably the most convenient method of taking pictures at close range. You view the subject directly through the lens for accurate focusing and the ultimate in composing ease. With the standard lenses, the OM-1 MD lets you take pictures as close as 45cm (17¾") from the subject. Close-up accessories help you get even closer, enabling you to take life-size and even larger-than-life size pictures. The Close-up Photography Group includes close-up lenses, extension tubes, and macro lenses that enable you to focus even closer.

The convenient macrophoto stand facilitates your close-up photography. The portable copy stand holds light sources on arms that can move to any angle and direction.

The bellows further enables you to delve deeper into the world of close-ups with maximum ease and remarkable results. The copy stand is ideal for all types of close-up applications including copying or photographing documents, books, biological or medical specimens and small mechanical components.





CHART OF CLOSE-UP PHOTOGRAPHY GROUP

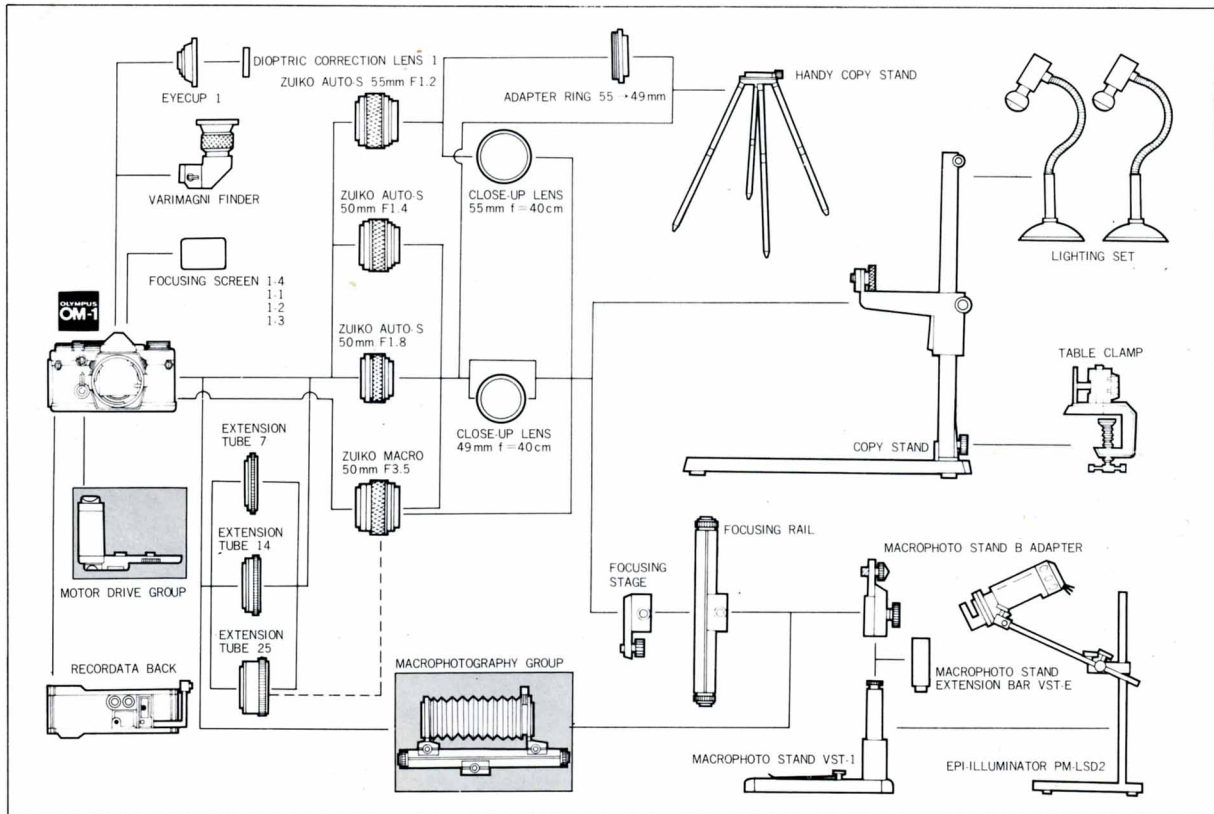



7



25



14

■ **Close-up Lens 49mm f=40cm**

■ **Close-up Lens 55mm f=40cm**

These attachment lenses provide the most economical method of taking close-ups. When used with the standard lenses, they enable the photographer to focus as close as 19cm (7 3/8").

■ **Extension Tubes 7, 14 and 25**

Designed to be used alone or in combination to achieve seven different extension possibilities. When used with the standard F1.8 lens, subject-to-lens distances can be continuously varied

from 39.1cm (15 1/4") to 6.8cm (2 5/8"). When used with the macro 50mm, the extension tube 25 provides an extended magnification range from 0.5X to life-size. In this range, however, the 1:1 macro 80mm is recommended for the best result.



■ **Adapter Ring 55→49mm**

Designed to adapt the 55mm F1.2 standard lens to the Handy Copy Stand.

■ **Handy Copy Stand**

A convenient portable copy stand which permits close-up photography with the OM-1 MD standard lenses. ↗



■ **Copy Stand**

A versatile reproduction stand for use in copy and duplication photography.

↗ Complete with a clamp for locking it in position, two adapters and 4 telescoping legs (calibrated in 3 steps).



■ **Lighting Set**

Complete with a pair of stable bases. The light arms attach to the bases or copy stand. Maximum light intensity is 500W, with adjustments to any angle or direction.

■ **Table Clamp**

Securely holds up the pillar of the copy stand on the table top without the baseboard for close-up or copying work with large subjects.

Extreme close-up and macrophotography overcomes the limitations of human vision. Tiny objects imperceptible to the human eye can be captured on film, revealing a miraculous new world of exciting shapes and colors.

The Macrophoto Group of the OM-System offers a complete range of convenient, high performance accessories designed for specialists in the various fields of macrophotography. Starting with 5 macro lenses, auto bellows and macrophoto stands and extending to a large variety of holders and frames, lighting equipment, etc., it is the world's most comprehensive and versatile system.

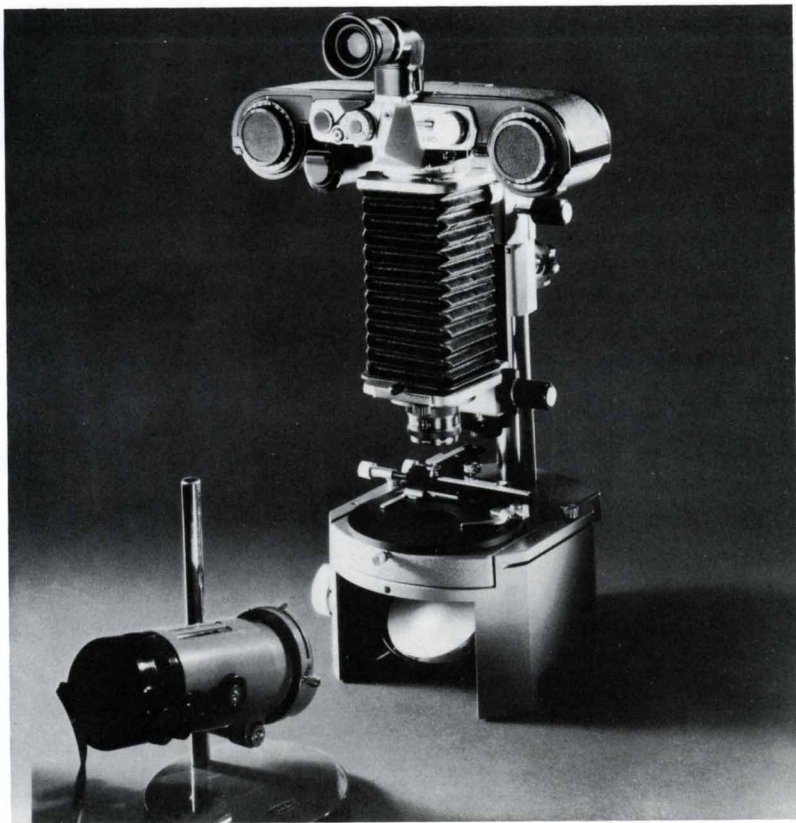
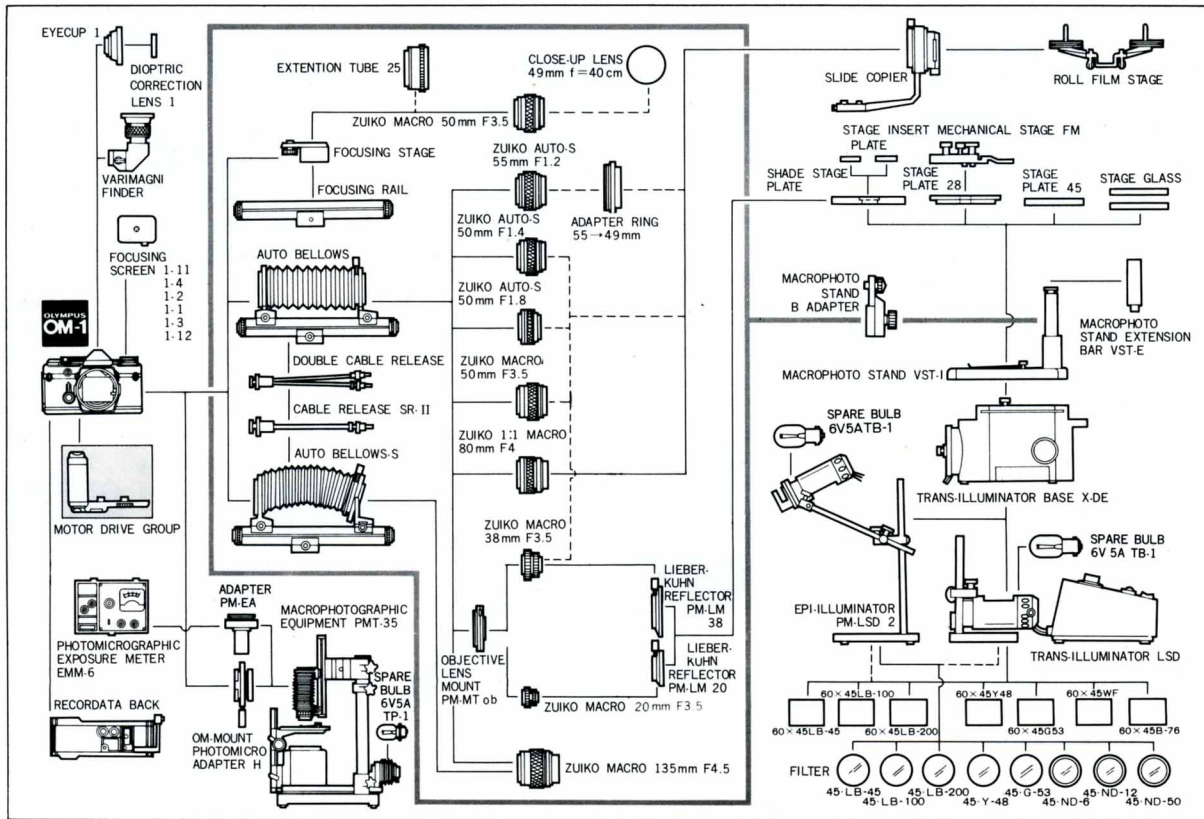
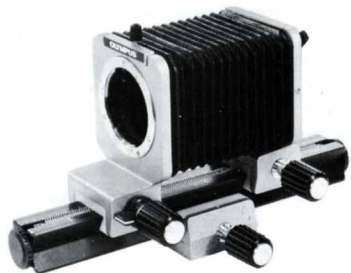

CHART OF MACROPHOTOGRAPHY GROUP





■ Auto Bellows

A versatile, precisely constructed bellows system including the bellows section, the focusing rail, and the focusing stage. Provides separate magnification and focus adjustments.



■ Double Cable Release

Designed to be used with the auto bellows for synchronized operation of the diaphragm and shutter release. Ring timer is provided for long-time exposure.

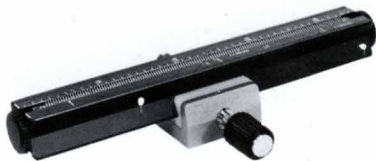

■ Focusing Rail

Specially designed for use with the focusing stage when mounted on the copy stand or microphoto stand B adapter. This unit is available together with the focusing rail.



■ Focusing Stage

The focusing stage allows you to mount the camera on the focusing rail. When used with the rail, the stage makes it easier to shift the camera in the back-and-forth and right-and-left directions.



■ Slide Copier

For use with the bellows to copy transparent subjects in color or black and white. A film slide or strip is placed behind the detachable diffusion glass on the copier.



■ Roll Film Stage

A convenient accessory when using the bellows and slide copier for duplicating roll film. Any long roll of film, ready to curl up, is easily handled without a fear of scratching the film surface.



■ Macrophoto Stand VST-1

Sturdy pillar stand for close-up and magnified photographs. Complete with a round frosted plate (black at back) for incident light and a pair of stage clips. When used with the trans-illuminator X-DE, transmitted light is directed from below for copying transparencies.



■ Macrophoto Stand B Adapter

Specially designed for use with the macrophoto stand. Clamped on the post of the stand, and supports the bellows or focusing rail.

■ Macrophoto Stand Extension Bar VST-E

When the post of the macrophoto stand does not reach a desired height, this extension bar can be easily attached to the post.

■ Cable Release SR-II

For use with the OM-1 MD, auto-bellows or PMT-35, to eliminate shutter vibration.

■ Adapter PM-EA for Photomicrographic Exposure Meter EMM-6

Accepts the photosensitive probe of the EMM-6 in conjunction with the auto-bellows or PMT-35. This adapter is specially convenient when the subject is so dark that the TTL exposure meter cannot be used, or measurement of color temperature is necessary. (See p. 52 for EMM-6.)

■ Trans-Illuminator Base X-DE

Indispensable for holding the macrophoto stand VST-1 for magnified photographs. Supplied with a built-in 100V 20W illuminator with a mirror, and a pair of wooden handrests for ease of operation. Can be used with various stage plates and filters.

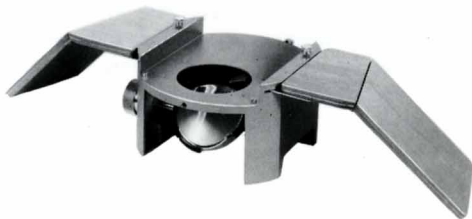



■ Trans-Illuminator LSD

The LSD is a universal type trans-illuminator for use with the X-DE trans-illuminator base for macrophotography. When the Lieberkühn reflector is added, vertical light is also available. A 6V, 30W bulb is built-in. The condenser travels 18mm by rack and pinion for converging, diverging and parallel adjustments of light. Complete with transformer and square filter 60x45C.



■ Epi-Illuminators PM-LSD 2

This pair of illuminators offer vertical illumination essential to macrophotography. The height of the illuminator is adjustable on the tall pillar, suitable to overstage or substage illumination. When used with the trans illuminator base X-DE, the illuminator supplies transmitted light. Focusing is adjustable by shifting the bulb filament. A 6V to 8V variable transformer is provided. Eight filters are available in various sizes, including color, black and white, neutral density, etc. for transparent or translucent subjects.

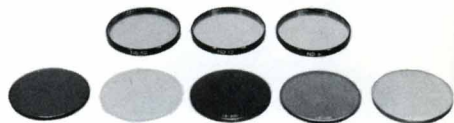

■ Filters

These filters are available for use with either the LSD or PM-LSD2 illuminator. The blue filters are recommended for color temperature compensation, yellow and green filters for monochromatic contrast and ND filters for light density adjustment.

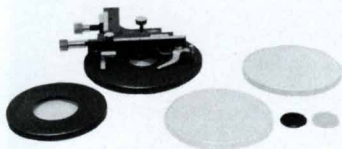

■ **Stage Glasses (clear and frosted-and-black)**

■ **Stage Plate 45 (metal disc, black finish)**

■ **Stage Plate 28 (metal disc, black finish)**

■ **Glass Shade Stage Plate**

Supplied with two stage insert plates and compatible with the Lieberkühn reflector. A 25mm diameter port in the center accepts the stage insert plate on which a subject is placed.

■ **Mechanical Stage FM**

This mechanical stage is used to mount subjects on the 28mm stage plate. The subject travels vertically and horizontally by fine adjustments with vernier.



■ **Lieberkühn Reflectors PM-LM20 and 38**

Two Lieberkühn reflectors are available for use with the 20mm and 38mm macro lenses. When used with the LSD trans-illuminator, they make it possible to take photographs with surprisingly good penetration and lack of shadows.



■ **Objective Lens Mount PM-MTob**

This objective mount enables you to mount the Zuiko macro 20mm and 38mm to the auto bellows.



■ **Macrophotographic Unit PMT-35**

The PMT-35 is a complete macrophotographic system for OM-1 MD photo work providing image magnification from 0.45x to 16.5x. A macro-photo mount adapter connects OM-1 MD to the supporting arm. The built-in shutter has shutter vibration prevention. Shutter speeds range from 1 second to 1/500 second with T and B, and M-X synchronizing contacts.

When photographing microscope images of more than 10x, it becomes increasingly difficult to take quality pictures. Photomicrography has spread not only into the scientific fields (used in medical, biological, chemical, botanical and zoological sciences for recording observations and illustrating scientific publications) but also is now used in the artistic fields of graphic design, commercial photography, displays, etc. In industries such as foods, textiles, metal and so forth, photomicrography is of great value. Higher magnification photography (over 10x power) requires extremely precise photomicrographic equipment and the OM-system offers an unusually wide range of photomicrographic units. The Photomicrography Group includes the photomicroscopic adapters, the 35mm SLR camera adapter, the exposure meter EMM-6, the automatic exposure control box PM-CBA, the supporting stand PM-PSS, eyepiece adapters, and magnifiers. All of these are specifically designed to produce photomicrographic results with maximum ease of operation. In addition to these units, the group also includes adapters for endoscope and stereoscopic operation microscope.

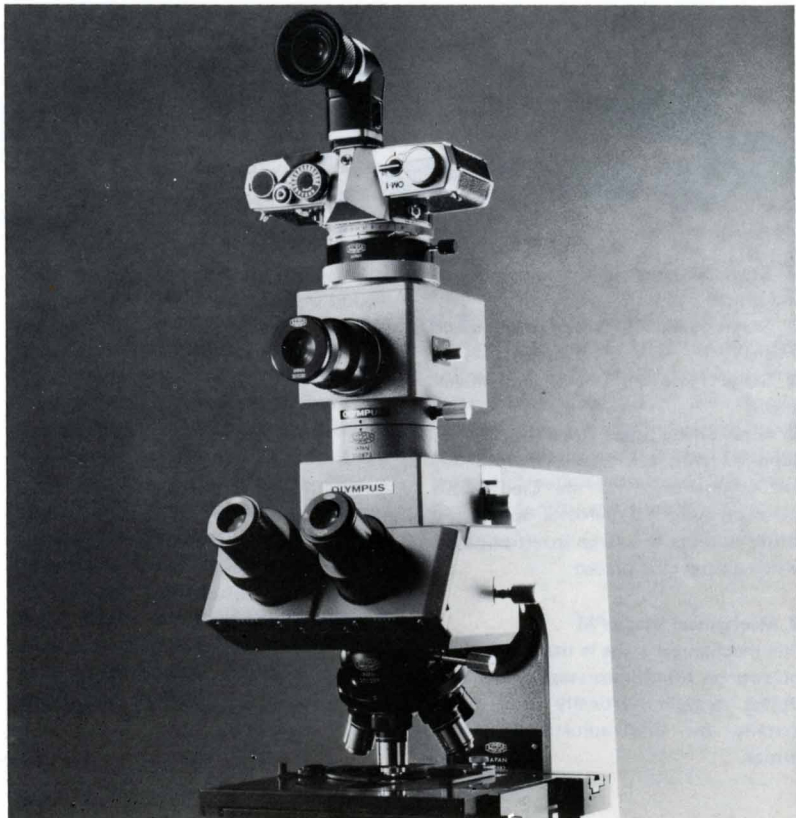

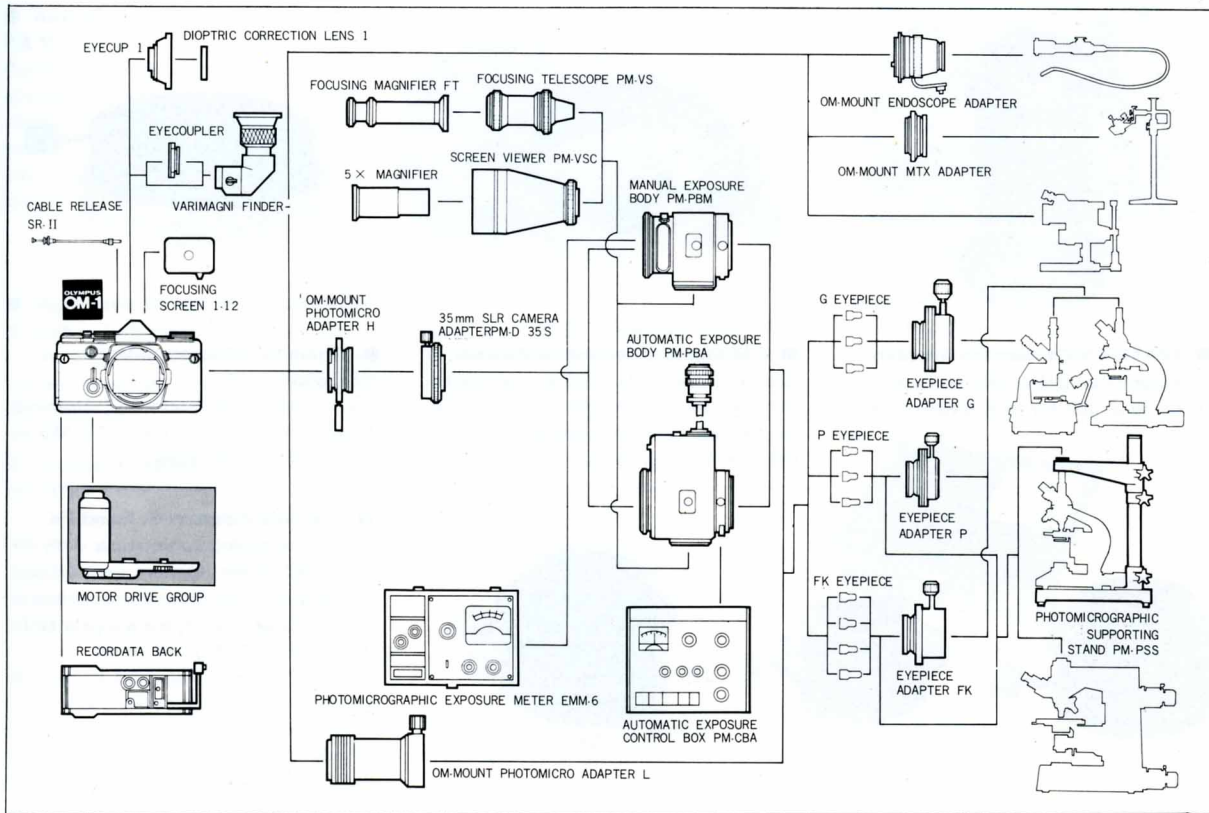



■ **OM-Mount Photomicro Adapter L**

Connects the OM-1 MD with the microscope ocular for low power magnification.

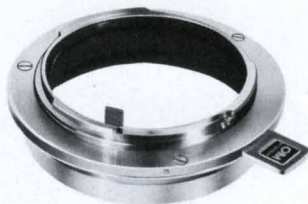

■ **OM-Mount Photomicro Adapter H**

Connects the OM-1 MD to the photomicrographic system PM-10, automatic or manual, or macrophotographic unit PMT-35 for high power magnification.



■ **35mm SLR Camera Adapter PM-D35S**

Used with OM-Mount Photomicro Adapter H to attach the OM-1 MD to the PM-PBA or PM-PBM.



■ **Eyepiece Adapters G, P and FK**

For photomicrographic work with the OM-1 MD, these adapters are used with the adapter L to mount an eyepiece to a microscope. Select the adapter to fit the eyepiece G, P or FK in use.

■ **Auto-Photomicrographic System
PM-10-A**

Consists of 17 units, including the automatic exposure body PM-PBA, control box PM-CBA, etc., to automatically determine correct exposure time and advance film after each exposure.

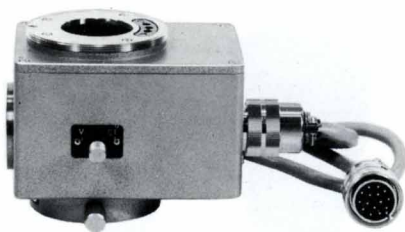

■ **Automatic Exposure Body PM-PBA**

A built-in CdS meter reads light directly through the eyepiece and selects correct exposure between 1/100 second and 32 minutes for color and

black and white films, automatically compensating for reciprocity failure. Used in combination with the PM-CBA.

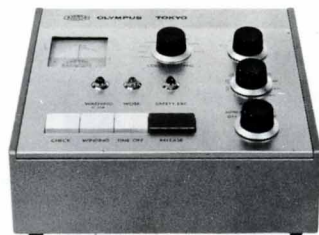

■ **Automatic Exposure Control Box
PM-CBA**

Used with the automatic exposure body PM-PBA, this meter permits light balancing to obtain correct color temperatures, compensating for reciprocity failure. Eight filters are included.

■ **Manual Photomicrographic System
PM-10-M**

This is a popular manual version of the PM-10, consisting of 8 units. It includes the manual exposure body PM-PBM, eyepiece adapters, focusing telescope, and magnifier, etc.

■ **Manual Exposure Body PM-PBM**

A shutter release button is integrated to eliminate shutter vibration. A light measuring port is provided for use with the EMM-6 exposure meter to obtain exact exposure time, if desired.



■ **Photomicrographic Exposure Meter
EMM-6**

The EMM-6 assures accurate control of both exposure and color temperature in photomicrography. Provided with exposure and color temperature probes, color-compensating filters.



■ **Focusing Telescope PM-VS**

Select a reticle compatible with your film size in use with the PM-PBA and PM-PBM.

■ **Focusing Magnifier FT**

A slide-in front lens assembly that can be moved laterally to permit focusing on the frame reticles of the focusing telescope.



■ **Screen Viewer PM-VSC**

Clamped to the automatic exposure body for use with 4x or lower objectives.

■ **5X Magnifier**

Front lens assembly can be moved in and out to focus on the cross line of the frosted glass screen viewer.



■ **OM-Mount Endoscope Adapter (for Olympus fiberscopes)**

■ **OM - Mount MTX Adapter (for Olympus Stereo Operating Microscope MTX)**



■ **Photomicrographic Supporting Stand PM-PSS**

The PM-PSS is a massive new photomicrographic stand to virtually end the major cause of lost photomicrographs...vibration. Supports the entire weight of the camera, isolating it from the microscope. Other bench vibrations are absorbed by the stand's rubber feet.

CHART OF CLOSE-UP RANGES

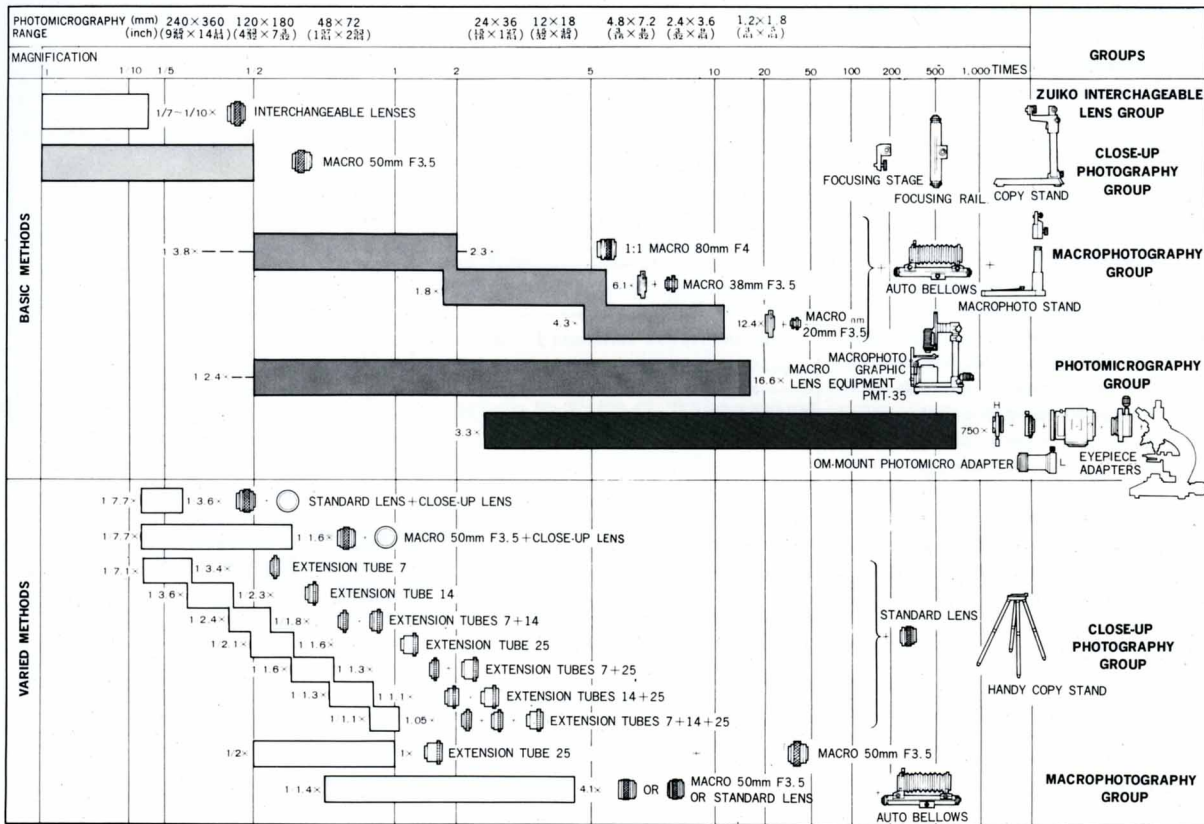

The viewfinder is one of the most important features of a single-lens reflex camera. Since every photographic subject is turned into a visual image by means of the finder, one that is dark or difficult to look through is an obstacle to good photography. An essential element contributing to the versatility of the SLR camera is a provision for interchangeable focusing screens. Unless the most suitable focusing screen for a given photographic purpose is available, the potentialities of a system camera cannot be utilized. The screens can easily be changed in seconds. For fast, accurate focusing, the OM-system offers Eyecup 1, Eyecoupler, Dioptic Correction Lenses and Varimagini Finder.

■ Focusing Screen 1

The feature of each focusing screen is as listed at right. The 1-3, suitable for general photography, is particularly advantageous when taking a subject with vertical lines. The 1-5 is ideal for the snap-shooters using a wide angle lens. The 1-4 and 1-7 are designed for super-telephoto lenses and 1-4, 1-11 and 1-12 are for close-ups, macro-photography and photomicrography.

TYPE	FEATURES	TYPE	FEATURES
1 - 1 Microprism-matte type (for most lenses)	Standard type, suitable for general photography. Fast and accurate focusing is done on the central microprism spot as well as on the surrounding matte area. When the lens diaphragm is closed down to smaller than F5, the microprism gets dark so that focusing must be made on the matte area. The meter needle indicates proper exposures.	1 - 6 Microprism-clear field type (for standard & telephoto lenses)	This screen provides an extremely bright finder. Focusing is done on the microprism spot. Being without matte surface, depth-of-field effects cannot be ascertained and the meter needle does not indicate proper exposures.
1 - 2 Microprism-matte type (for standard & telephoto lenses)	Suitable for general photography in conjunction with a standard or a telephoto lens. Focusing is done on the microprism spot as well as on the matte area. With the diaphragm smaller than F8 the microprism spot gets dark. The meter needle indicates proper exposures.	1 - 7 Microprism-clear field type (for super telephoto lenses)	Developed primarily for use with super telephoto lenses, this clear field screen provides an extremely bright finder. The microprism spot remains bright even when the diaphragm is closed down to F11. Without matte surface, depth-of-field effects cannot be ascertained; the meter needle does not indicate proper exposures.
1 - 3 Split image-matte type (for most lenses)	Suitable for general photography ensuring critical focusing, and ideal for photographers who prefer the split-field and coincidence type focusing. With the diaphragm smaller than F5.6, the split prism gets dark. The meter needle indicates proper exposures.	1 - 9 Clear field type (for endoscopic photography)	Designed for use with Olympus fiberoptic endoscopes. This condenser type screen without fresnel lens requires no focusing when a special adapter couples the camera with the fibroscope. Exposure is made automatically by the light supply.
1 - 4 All matte type (for most lenses)	Suitable for general photography and ideal for photographers who prefer a view field free from microprism or split prism and for those who are accustomed to focus using matte area. Also suitable for super-telephoto photography and close-up photography in conjunction with macro lenses and Auto Bellows. The meter needle indicates proper exposures.	1 - 11 Cross hairs-matte type (for close-up & macro-photography)	Highly advantageous for close-up and macro-photography with Auto Bellows and extension tubes. For focusing in low magnification close-up photography, use the matte area, and in macrophotography greater than life size, use the double cross hairs the same way as with the 1-12. The meter needle indicates proper exposures, but depending on specimen's conditions, reading must be compensated for.
1 - 5 Microprism-clear field type (for wide angle & standard lenses)	This transparent screen provides an exceptionally bright finder. Highly suitable for snapshots using wide angle lenses. Devoid of matte surface, depth-of-field effects cannot be ascertained. The meter needle does not indicate proper exposures, because the needle moving varies depending on the lenses used.	1 - 12 Cross hairs-clear field type (for photo microscopy & macrophotography greater than life size)	The transparent screen enables the photographer to focus in an unusually bright finder. To focus, first correct your diopter using a dioptic correction lens or Varimagini Finder so that each line of the double cross hairs can be seen clearly and separately. Then bring the specimen into focus. The meter needle indicates proper exposures, but depending on specimen's conditions, reading must be compensated for.



■ Eyecup 1

Designed to prevent glare and loss of contrast caused by stray light hitting the eyepiece. Made of rubber for soft touch on the forehead. A dioptic correction lens is fitted into a slot in the eyecup and held by a threaded retaining ring.



■ Dioptic Correction Lenses

An aid to easier focusing with far-sighted or near-sighted vision. These lenses snap into a slot provided in the eyecup. They are available in 8 different diopter strengths: +2, +1, 0 diopters for far-sighted; -1, -2, -3, -4 and -5 diopters for near-sighted.



■ Varimagni Finder

This unique and exclusive accessory for the OM-system combines the two functions of angle finder and magnifier, incorporating 9 lens elements and reflector. It fits on the camera's viewfinder, and can be adjusted for individual eyesight. Its eyepiece tube is rotatable through 360°, allowing the photographer to focus from any position, including waist-level or right angle viewing. The two-stage, one-touch switching system offers both a 1.2x magnification image covering the whole finder viewfield, and a 2.5x enlargement of the central portion for critical focusing. For photomicrographic use, insert the eyecoupler between the camera and Varimagni Finder.



■ Eyecoupler

The eyecoupler is used with the OM-1 MD and the varimagni finder for photomicrography. It attaches between the camera and Varimagni Finder, extending the finder away from the camera for more convenient viewing. For motor-driving shooting, the 250 film back 1 also requires the eyecoupler for mounting the eyecup 1.



■ Lens Hood

Lens hoods protect against extraneous light striking the lens and causing unwanted glare. Hoods for standard lenses are cover types and can be reversed to provide easy storage even when the camera is in the case.



- Front Lens Cap
- Rear Lens Cap
- Camera Body Cap

- Hard Case for Camera
- Soft Case for Camera
- Soft Case for Lens
- Compartment Case



■ OM Lens Mount Adapter for Pen F

Connects the OLYmpus Pen F, FT and FV with OM-system interchangeable lenses and other units. With this adapter, however, the automatic diaphragm of the lens does not couple with the camera's meter system.



■ Filters

In general photography and in many specialized fields, filters are essential to the effective rendition of photographic subjects. Whether in black and white or color, filters are necessary additions to most camera systems. In controlling contrast and eliminating unwanted haze in black and white photography, the use of the correct filter often means the difference between a good photograph and a great one. In color, where the balancing of the light with the film emulsion is absolutely necessary for correct color, conversion and light balancing filters are the only effective way of achieving the desired results. Olympus filters are made of the highest quality optical glass and are tested to the same high standards used in evaluation of Zuiko lenses. All extraneous lights and aberrations have been eliminated so as not to affect focusing quality of any lens with which the filter is used, and all Olympus filters are fully coated on both sides to minimize flare and reflection.

Name	Color	Descriptions
Y48 (Y2)	Yellow	Accentuates contrast, darkens blue skies. Very effective in daylight scenes where the sky is part of subject matter. Heightens the effect of white clouds. Useful in copying documents where line copy is blue or black on light background.
O56 (O2)	Orange	Absorbs a wider range of wavelengths from UV to dark green than the Y2. Makes a superb rendition of the texture of outdoors subjects, and indoors. It brings out detail in objects yellow, brown. Used with infrared film.
R60 (R1)	Red	Used as contrast filter to create darkened sky or in copying. Also used to penetrate haze in landscape photography for stronger contrast than an O2 filter. Used with infrared film.
Skylight (1A)	Colorless	Similar to UV filter. Eliminates ultraviolet rays. Reduces haze and bluish tones in daylight photography. Effective with color film only. May be used at all times to protect the lens.
L39 (UV)	Colorless	Eliminates undesirable ultra-violet rays which cause dull, flat pictures. Renders subject in clear, detailed brilliance. May be used at all times to protect the lens.
ND2 ND4	Grey Grey	Reduces the quantity of light entering the lens to 1/2 or 1/4 of the original intensity. For use in extremely bright conditions when you wish to maintain a wide aperture.
Polarizing filter POL	—	Enables you to take pictures through glass or water without reflections. Will darken the sky in black-and-white photographs without altering other color values in the picture, and renders blue skies darker when used with color film. Reflections are reduced to provide better texture surface detail.
A4 (81C)	Amber	For use when taking color pictures in cloudy or rainy weather. Reduces bluish tone.
B4 (82C)	Blue	Designed for use when taking color pictures in early morning or late evening hours when red rays are predominant.

OM
SYSTEM

OLYMPUS

OLYMPUS OPTICAL CO., LTD.

43-2 Hatagaya 2-chome, Shibuya-ku, Tokyo, Japan

<OM-1 MD Specification Change>

The film guide pins have been reduced from four (Photos., page 3 & 8) to two, which doesn't affect photographing in any way.

OLYMPUS