

***Nikon***

N6006

AF

INSTRUCTION MANUAL

# FOREWORD

Thank you for purchasing the Nikon N6006. We hope you enjoy the Nikon N6006, and we're sure it will make photography a bigger part of your life.

Get to know your N6006, but before using it, be sure to read this manual thoroughly, as well as the supplemental manual "FLASH PHOTOGRAPHY."

## CONTENTS

FOREWORD .....	2
NOMENCLATURE .....	4 - 8
<i>BASIC OPERATION</i> .....	9 - 22
MOUNTING THE LENS .....	10
INSTALLING BATTERY .....	11
CHECKING BATTERY POWER .....	12
LOADING FILM .....	13 - 15
BASIC SHOOTING .....	16 - 21
REWINDING FILM .....	21 - 22
<i>CONTROLS IN DETAIL/ PHOTOGRAPHIC TECHNIQUES</i> .....	23 - 80
FILM SPEED SETTING .....	24 - 27
USING AUTOMATIC FILM SPEED SETTING FOR DX-CODED FILMS .....	24 - 25
MANUAL FILM SPEED SETTING .....	25 - 26

FILM ADVANCE MODE SETTING .....	27
SINGLE-FRAME SHOOTING .....	27
CONTINUOUS SHOOTING .....	27
FOCUSING .....	28 - 38
AUTOFOCUS .....	28 - 35
FOCUS-PRIORITY SINGLE AUTOFOCUS .....	28 - 29
FOCUS-PRIORITY CONTINUOUS AUTOFOCUS .....	30 - 31
AUTOFOCUS WITH MAIN SUBJECT OFF CENTER - SETTING AF-L (AUTOFOCUS LOCK) FUNCTION .....	32 - 34
IN FOCUS-PRIORITY SINGLE AUTOFOCUS .....	33
IN FOCUS-PRIORITY CONTINUOUS AUTOFOCUS .....	34
SPECIAL FOCUSING SITUATIONS .....	35
MANUAL FOCUS .....	36 - 38
MANUAL FOCUS WITH ELECTRONIC RANGEFINDER .....	36 - 37
MANUAL FOCUS USING CLEAR MATTE FIELD .....	38
EXPOSURE .....	39 - 72
EXPOSURE METERING SYSTEMS .....	39 - 45
MATRIX METERING .....	39
CENTER-WEIGHTED METERING .....	40
SPOT METERING .....	40
METERING SYSTEM SETTING .....	41
METERING SYSTEM SELECTION - WHEN TO USE MATRIX OR CENTER-WEIGHTED METERING .....	42 - 45

EXPOSURE MODE .....	46 - 63
EXPOSURE MODE SETTING .....	47
PROGRAMMED (PM AND P) AUTO .....	48 - 50
FLEXIBLE PROGRAM .....	50
<b>SHUTTER-PRIORITY AUTO EXPOSURE</b>	
<b>MODE</b> .....	51 - 54
OPERATION IN SHUTTER-PRIORITY	
AUTO EXPOSURE MODE .....	52 - 54
<b>APERTURE-PRIORITY AUTO EXPOSURE</b>	
<b>MODE</b> .....	55 - 58
OPERATION IN APERTURE-PRIORITY	
AUTO EXPOSURE MODE .....	56 - 58
<b>MANUAL EXPOSURE MODE</b> .....	59 - 63
OPERATION IN MANUAL EXPOSURE MODE ..	59 - 61
TO OBTAIN EXPOSURE READING	
FOR A MAIN SUBJECT OFF CENTER	
OR TOO SMALL SUBJECT .....	62
BULB SETTING .....	63
EXPOSURE COMPENSATION .....	64 - 72
<b>AE (AUTO EXPOSURE) LOCK LEVER</b> .....	64 - 65
<b>EXPOSURE COMPENSATION BUTTON</b> .....	66 - 67
<b>AUTO EXPOSURE BRACKETING</b> .....	68 - 72
<b>SELF-TIMER OPERATION</b> .....	73 - 74
ONE-SHOT SELF-TIMER .....	73
TWO-SHOT SELF-TIMER .....	74
<b>BUILT-IN TTL FLASH</b> .....	75 - 80
USING BUILT-IN TTL FLASH .....	76 - 78
BUILT-IN TTL FLASH SPECIFICATIONS .....	78 - 80
<b>GUIDE NUMBER</b> .....	78
<b>ANGLE OF COVERAGE</b> .....	78

<b>USABLE LENSES</b> .....	79
<b>FLASH SHOOTING DISTANCE RANGE</b> .....	80
<b>CONTROLLED MAX. APERTURE IN</b>	
<b>PROGRAMMED AND SHUTTER-PRIORITY</b>	
<b>AUTO EXPOSURE MODE</b> .....	80
<i>ACCESSORIES</i> .....	81 - 90
<b>LENS COMPATIBILITY</b> .....	82 - 83
<b>ACCESSORIES</b> .....	84 - 90
OPTIONAL SPEEDLIGHTS .....	84
CLOSE-UP ACCESSORIES .....	85 - 87
VIEWING ACCESSORIES .....	87
OTHER ACCESSORIES .....	88 - 90
<i>MISCELLANEOUS</i> .....	91-106
<b>CAMERA CARE TIPS</b> .....	92 - 93
<b>NOTES ON BATTERIES</b> .....	94
<b>SPECIFICATIONS</b> .....	95 - 98
<b>GLOSSARY</b> .....	99-101
<b>WARNING INDICATIONS</b> .....	102-105

# NOMENCLATURE

**Film plane indicator:** Exact distance from lens mounting flange to film plane is 46.5mm.

**LCD panel:** See page 8.

**Power switch**

**Self-timer indicator LED:**  
See pages 73 to 74.

**Release terminal:** Accepts optional Nikon Cable Release AR-3 or Double Cable Release AR-7.

**Shutter release button**

**Accessory shoe:** Accepts Nikon dedicated Speedlights.

**Minimum aperture lock:** Lock for programmed auto or shutter-priority auto exposure mode.

**Aperture scale**

**Built-in TTL flash:** See pages 75 to 80.

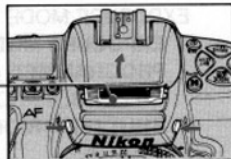

**Flash lock-release buttons:**  
To use the built-in TTL flash, push them.

**Lens mounting index**

**Lens release button**

**Focus mode selector:**

**S** for Focus-Priority Single auto-focus (see pages 28 to 29).

**CF** for Focus-Priority Continuous autofocus (see pages 30 to 31).

**M** for manual focus (see pages 36 to 38).

**Aperture ring**

**Focusing ring:** Used for manual focus

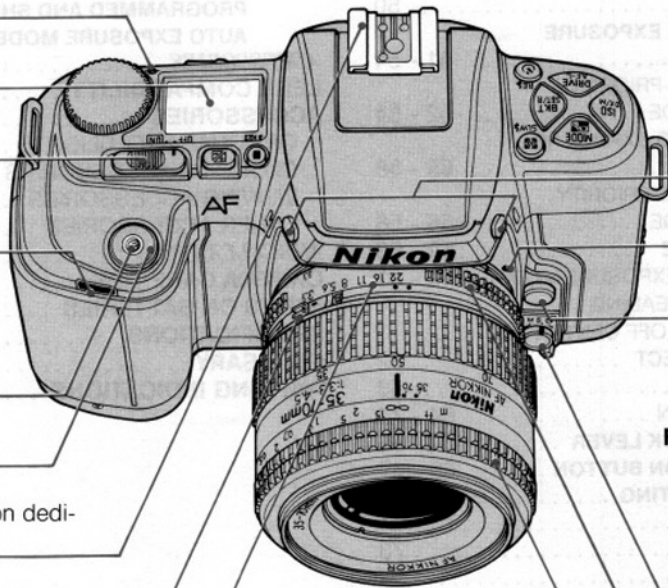

**Lens (AF Zoom-Nikkor  
35-70mm f/3.3-4.5)**



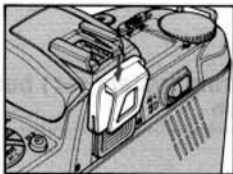

**Eyepiece cover DK-5 (provided):** Prevents stray light from entering viewfinder.

**Viewfinder eyepiece**

**Camera back**

**Film cartridge confirmation window**

**Camera strap eyelet**

**Camera back lock release:**  
Push down to open camera back.

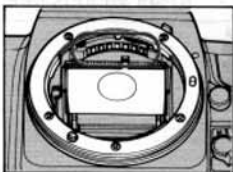

**CPU contacts:** Do not touch.

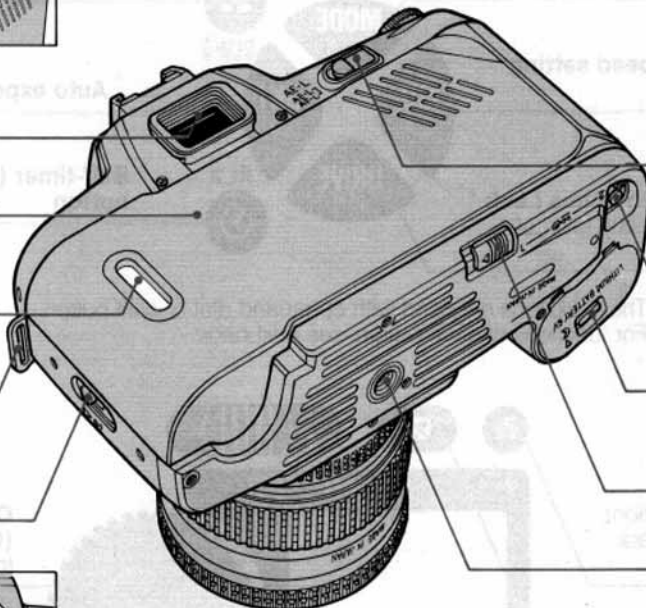

**AE-L (Auto Exposure Lock)/  
AF-L (Auto Focus Lock) lever:**  
See page 34 for autofocus lock  
or pages 64 to 65 for auto exposure  
lock.

**Film rewind button:** Press  
while sliding lever.

**Battery chamber cover lock  
release**

**Film rewind lever:** Slide in  
the direction of the arrow.

**Tripod socket**

Exposure mode (MODE) button/Automatic  
Balanced Fill-Flash (AF-L) button

Metering system (☉) button/Slow sync  
button

Film speed (ISO) button/Film speed setting  
mode (DX/M) button

Auto exposure bracketing (BKT) button

Film advance mode (DRIVE)/Auto Focus Lock  
function (AF-L) button: For autofocus lock func-  
tion, see pages 32 to 34.

Self-timer (⏸) button/Rear-Curtain sync  
button

These buttons are used with command dial or shift button.  
For functions of each button, see next page.

**Shift button:** Press to set the functions  
shown in matte gold ■ on the camera  
body. For details, see next page.

**Exposure compensation button**

**Command input control dial  
(Command dial):** Can be rotated  
to set various functions.

## Command dial/shift button functions

Combined with buttons listed below, the command dial and shift button provide various functions.

Button	With Command Dial	With Shift Button
Metering system (☉)/Slow sync button	To select metering system, rotate dial while pressing this button. (See page 41)	With shift button pressed, this button is used to set/cancel slow sync for flash photography.
Exposure mode (MODE)* / Automatic Balanced Fill-Flash (☂) button	To select exposure mode, rotate dial while pressing this button. (See page 47)	With shift button pressed, this button is used to set/cancel automatic balanced Fill-Flash for flash photography.
Film speed (ISO) button / Film speed setting mode (DX/M) button	To manually set film speed, rotate dial while pressing this button. (See pages 25 to 26)	With switch film speed setting mode (auto for DX-coded film or manual), push it while pressing shift button. (See page 24)
Film advance mode (DRIVE) / AF-L function button*	To set film advance mode, rotate dial while pressing this button. (See page 27)	With shift button pressed, this button is used to set/cancel autofocus lock function. (See pages 32 to 34)
Exposure compensation (☒) button	To make exposure compensation, rotate dial while pressing this button. (See pages 66 to 67)	—
Auto exposure bracketing (BKT) button	See pages 68 to 72.	
Self-timer (☺) / Rear-curtain sync button	Rotate it to set self-timer operation. (See pages 73 to 74)	With shift button pressed, this button is used to set/cancel rear-curtain sync for flash photography.
—	With shift button pressed, rotate command dial for flash output level compensation. For details, see pages 35 to 37 in "FLASH PHOTOGRAPHY", a separate instruction book.	

\*Pushing any two of MODE, ISO, DRIVE and BKT buttons simultaneously for more than one second sets N6006 for basic shooting.

In the following cases, command dial can be used by itself.

In Programmed auto exposure mode	Turn command dial for flexible program
In Shutter-Priority auto or Manual exposure mode	Turn command dial to set shutter speed

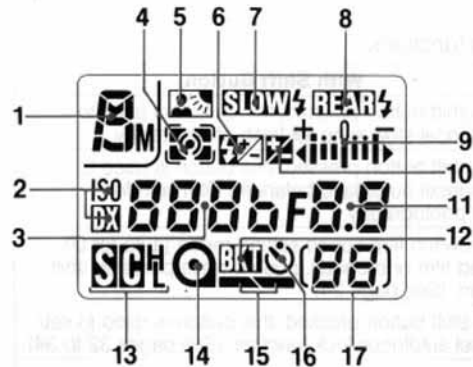

### LCD panel indications

1. Exposure mode
2. Film speed setting mode
3. Shutter speed/film speed (for manual film speed setting)/AF-L function/number of frames for auto exposure bracketing
4. Metering system
5. Automatic Balanced Fill-Flash
6. Flash output compensation
7. Slow flash sync
8. Rear-curtain sync
9. Electronic analog display
10. Exposure compensation
11. Aperture/exposure compensation value
12. Auto exposure bracketing
13. Film advance mode
14. Film loading
15. Film advance and rewind
16. Self-timer
17. Frame counter/number of remaining frames for auto exposure bracketing/self-timer duration

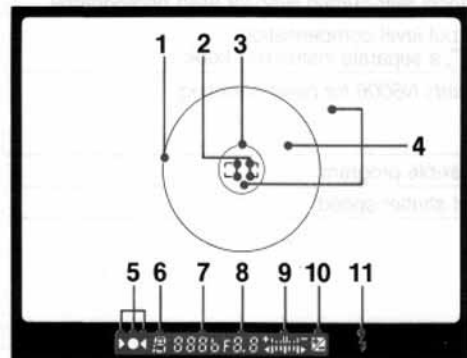

### Viewfinder indications

1. 12mm-dia. reference circle
2. Focus brackets
3. 5mm-dia. reference circle
4. Clear matte field
5. Focus indicators: ● indicates a stationary subject is in focus while ►●◀ shows focus tracking in autofocus operation (see pages 28 to 31); either focus-to-right arrow (►) or focus-to-left arrow (◄) appears for manual focus (see pages 36 to 37)
6. Exposure mode
7. Shutter speed/film speed (for manual film speed setting)/number of frames for auto exposure bracketing
8. Aperture/exposure compensation value
9. Electronic analog display
10. Exposure compensation
11. Ready-light LED

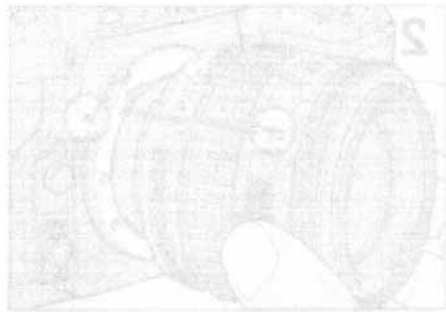
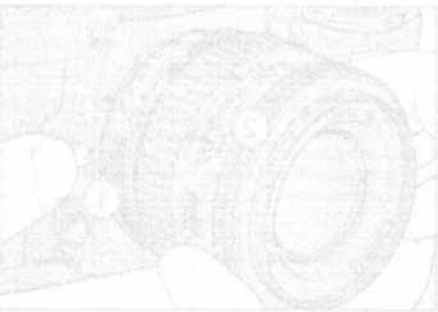

# ***BASIC OPERATION***



# MOUNTING THE LENS

1

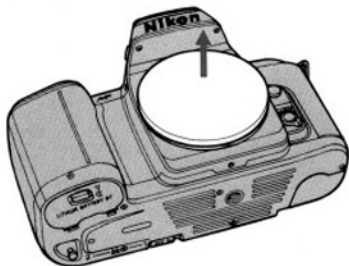

Remove camera body cap and front and rear lens caps.

2

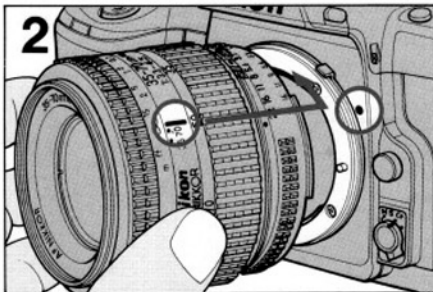

Aligning lens mounting index on the camera body with lens' aperture index, twist lens counterclockwise until it locks securely into place.

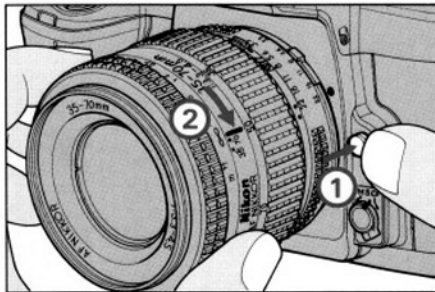

## To remove

Push lens release button and turn lens clockwise.

See page 82 for Nikon lens compatibility chart.

# INSTALLING BATTERY

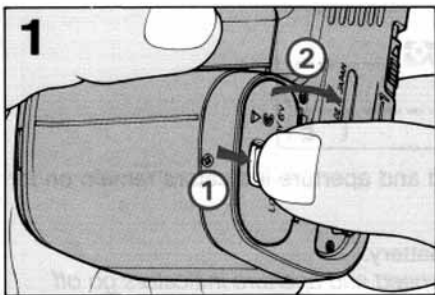

1  
Open battery chamber cover by sliding the lock release.

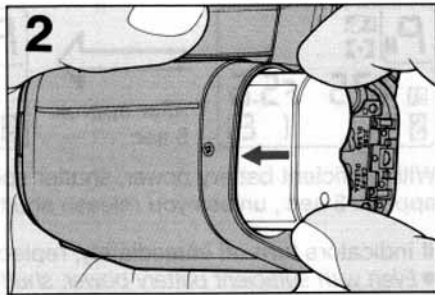

2  
Insert 6V lithium battery pack (Duracell DL 223A, Panasonic CR-P2 or equivalent) with "+" and "-" ends positioned as shown on the inside cover. Then push the battery pack down until it locks into place.

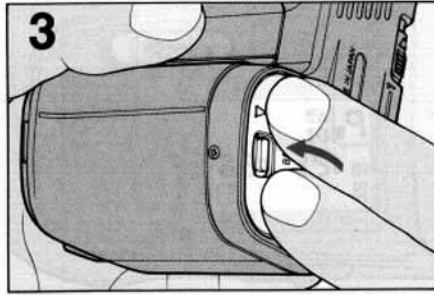

3  
Close the cover by pushing until it clicks.

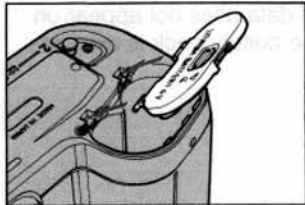

The battery chamber cover may be detached if pressure is applied. This prevents it from being broken. If the cover is accidentally detached, simply reattach it as illustrated, making sure to push it until it clicks into place.

See page 94 for "NOTES ON BATTERIES."



# CHECKING BATTERY POWER

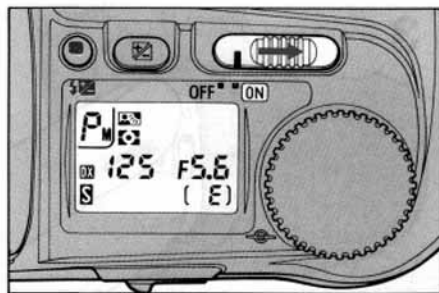

Slide power switch to ON and confirm indications on LCD panel.

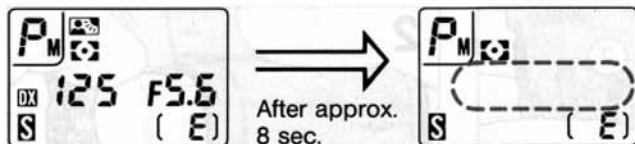

With sufficient battery power, shutter speed and aperture indicators remain on for approx. 8 sec., unless you release shutter.

If indicators turn off immediately, replace battery.

- Even with sufficient battery power, shutter speed and aperture indicators go off approx. 2 sec. after you remove your finger from button, following shutter release.
- Lightly pressing the shutter release button, after exposure meter automatically turns off, turns exposure meter on again. With sufficient battery power, meter stays on for approx. 8 sec. after you remove your finger from the shutter release button. With focus mode selector at S or CF, lightly pressing shutter release button also starts autofocus operation.

- When not using the camera, be sure to turn power switch off, to conserve battery power.
- The battery operates camera motor. When film-advance speed becomes noticeably slower, replace battery with fresh one.
- If all indicators on LCD panel blink when you lightly press shutter release button, battery should be replaced.
- If shutter does not operate and data does not appear on the LCD panel or viewfinder, the battery pack is exhausted or improperly loaded.

# LOADING FILM

To avoid fogging film (especially high-ISO film), do not load/unload film in direct sunlight.

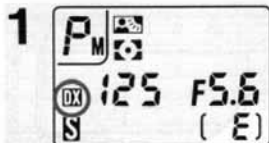

Confirm whether **DX** for auto setting is shown on the LCD panel.

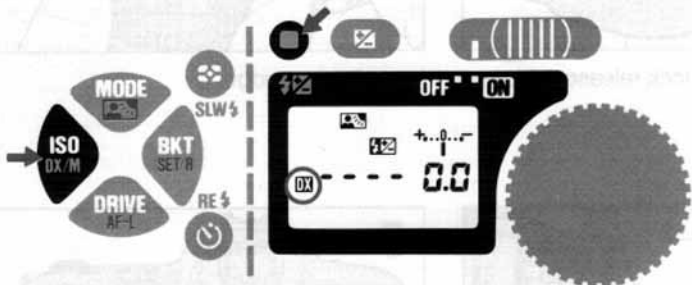

If not, press and hold shift button, then press ISO button so **DX** appears.

- Usable film speed range for DX-coded films is ISO 25 to 5000.
- For details about film-speed setting including manual film speed setting, see pages 24 to 26.

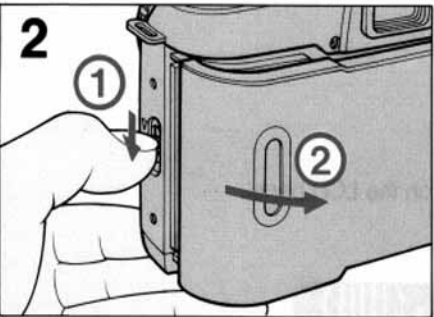

Slide camera back lock release to open camera back.

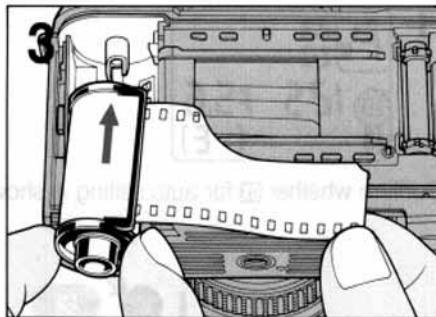

Insert film cartridge.



Do not touch shutter curtains with your finger or with film leader.

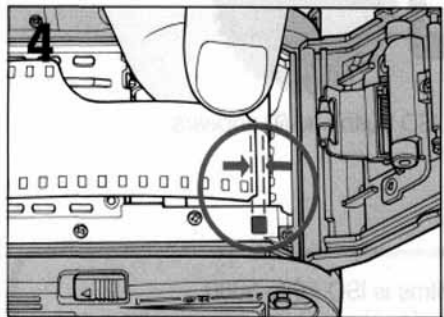

Pull film leader out to red index mark.

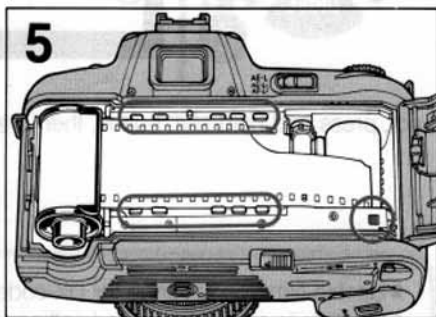

Check to ensure film is properly positioned with no slack. (See illustration)

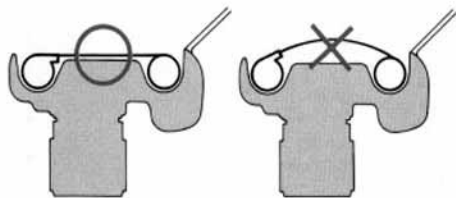

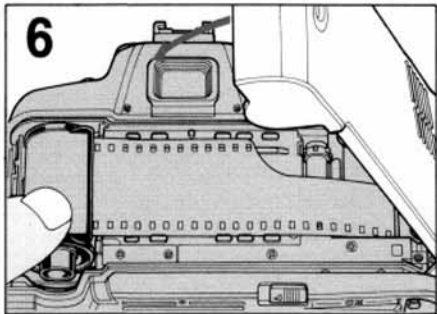

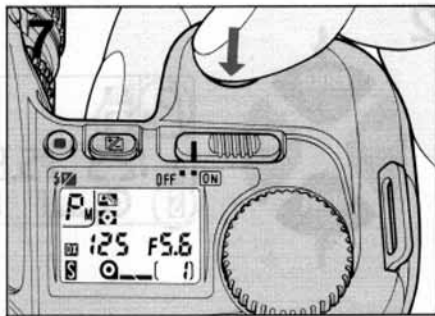

6 Close camera back until lock release snaps closed.

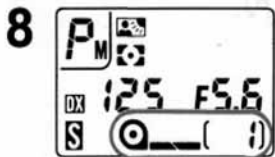

7 Fully depress shutter release button to automatically advance film to frame 1.



8 Confirm frame "1" and  symbol appear on LCD panel.



• If film is not correctly positioned, "E" remains, **Err** and  symbol blink and shutter locks. Open camera back and reload film.

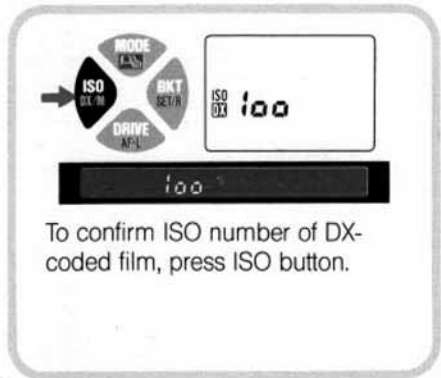

To confirm ISO number of DX-coded film, press ISO button.

# BASIC SHOOTING (Requires AF Nikkor lens)

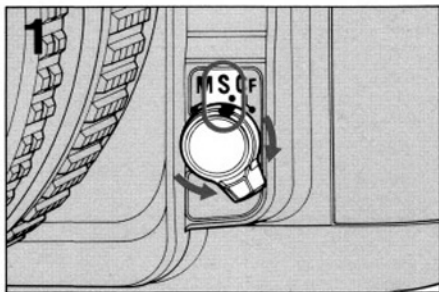

Set focus mode selector to **S** for Focus-Priority Single autofocus. If lens has an A-M switch, set the switch to **A**.

2

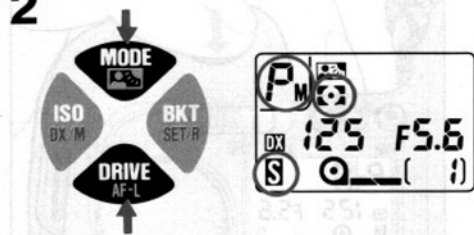

Push any two buttons (MODE, ISO, DRIVE and BKT) simultaneously for more than one second until **P**, **DX** and **S** appear in the LCD panel (while viewfinder LCD shows P), indicating that the camera settings are automatically reset for basic shooting as shown below:

Film advance  
Metering system  
Exposure control  
Flexible program setting  
Exposure compensation on camera  
Auto exposure bracketing

(For flash photography)

Flash sync  
Automatic Balanced Fill-Flash  
Manual flash light output compensation

Single frame (**S**)  
Matrix (**DX**)  
Multi-program (**P**)  
Cancel  
 $\pm 0$   
Not set

Normal — Slow sync and Rear-curtain sync cancelled  
Set  
 $\pm 0$

Shown here are basic settings for the easiest, most common picture-taking situations using AF Nikkor lenses with a CPU. With other than lenses AI-P Nikkor, Center-Weighted metering and Aperture-Priority auto exposure mode are automatically selected, and autofocus is not available (including AI-P Nikkor).

- |                                       |                               |
|---------------------------------------|-------------------------------|
| For film advance mode                 | See page 27                   |
| For metering system                   | See pages 39 to 45            |
| For exposure control                  | See pages 46 to 63            |
| For flexible program                  | See page 50                   |
| For exposure compensation with button | See pages 66 to 67            |
| For auto exposure bracketing          | See pages 68 to 72            |
| For flash photography                 | See separate instruction book |

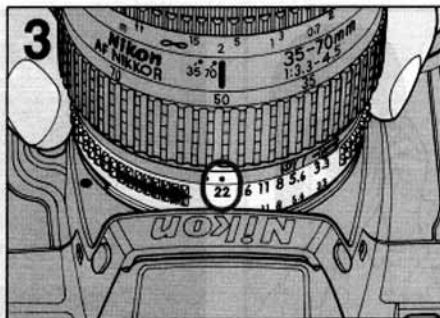

Set lens to its minimum aperture (highest f-number marked in orange on AF Nikkor lenses). Also lock lens aperture of AF Nikkor lens at its minimum setting (See lens instruction manual).

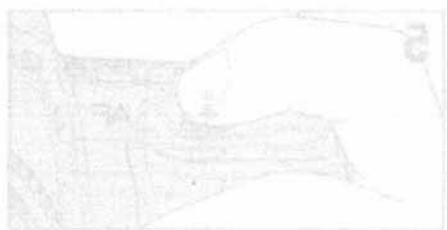

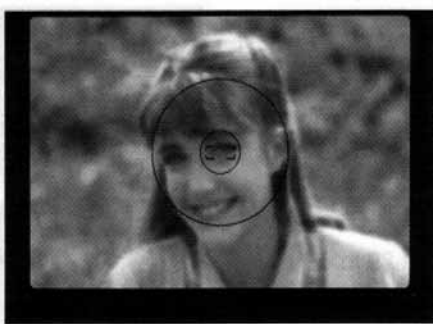
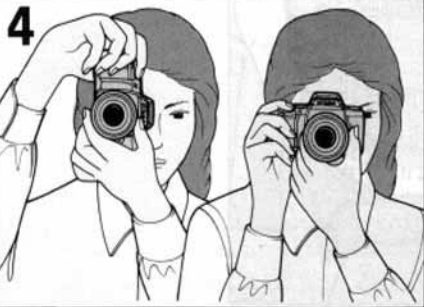

The N6006 viewfinder covers approx. 92% of the image area of the actual photograph so the actual picture comes out larger than the image in the viewfinder. Note that the picture comes out trimmed down in the case of mounted slides or service-size prints from negatives.

Look through the viewfinder and position focus brackets on the main subject.

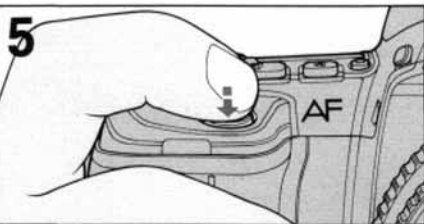

Lightly press shutter release button to start autofocus operation and turn the exposure meter on.

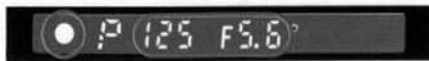
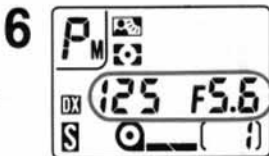

Confirm in-focus LCD indicator ● or ►●◀ is continuously visible in the viewfinder. Also check exposure by confirming shutter speed and aperture are shown. Exposure indications are also displayed in the LCD panel.

Shutter cannot be released until ● or ►●◀ appears indicating that subject is in focus.

- In-focus indication for a stationary subject
- ◀ Focus-tracking indication



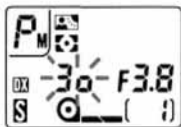

### If shutter speed indicator blinks – Picture blur alert:

If a selected shutter speed is 1/(focal length) or slower, picture blur may occur due to camera shake or subject movement. To avoid blur, hold camera very steady, use a tripod, or use accessory Nikon Speedlight.

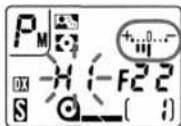

### If “HI” blinks in the shutter speed position with electronic analog display\* – Overexposure alert:

Overexposure may occur. Use a filter such as the Nikon ND filter.



### If “Lo” blinks in the shutter speed position with or without electronic analog display\* – Underexposure alert:

Underexposure may occur. Use built-in TTL flash or accessory Nikon Speedlight.

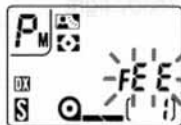

### If “FEE” blinks in the aperture position – Lens setting error alert:

Lens is not set to smallest aperture setting and shutter locks. Set lens to smallest aperture.



### If ready-light LED (⚡) blinks – Flash-photography suggestion:

If the subject brightness is insufficient, ready-light blinks. Use built-in TTL flash or accessory Nikon Speedlight.



\*Shows value difference from correct exposure.

## Flash shooting with built-in TTL flash

First, make sure that subject is within flash shooting distance range: With AF Zoom-Nikkor 35-70mm f/3.3-f/4.5 lens, the built-in TTL flash covers the following range:

Unit: m (ft.)

Zoom setting	Film speed (ISO)					
	25	50	100	200	400	800
35mm	0.6~2 (2.0~ 6.6)	0.7~2.8 (2.3~ 9.2)	1~3.9 (3.3~ 12.9)	1.3~5.5 (4.3~ 18.2)	1.6~6.5 (5.3~ 21.5)	1.9~7.7 (6.3~ 25.4)
70mm	0.6~1.4 (2.0~ 4.6)	0.6~2 (6.6)	0.7~2.9 (2.3~ 9.6)	1.0~4.1 (3.3~ 13.5)	1.4~5.8 (4.6~ 19.1)	1.9~7.7 (6.3~ 25.4)

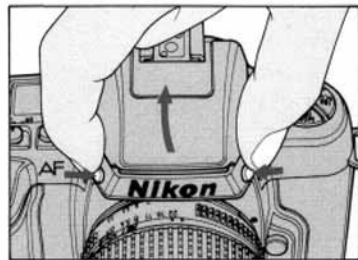

1. Push flash lock release buttons so that built-in TTL flash pops up.

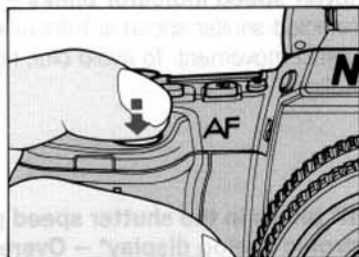

2. Lightly press the shutter release button.

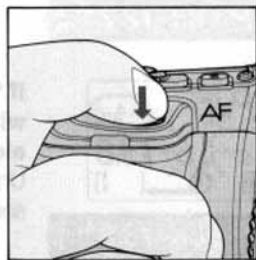

3. Wait a few seconds for ready-light to come on, then shoot. If subject is beyond flash's range, ready-light blinks for approx. 3 sec. after shooting.

For details, see pages 75 to 79.

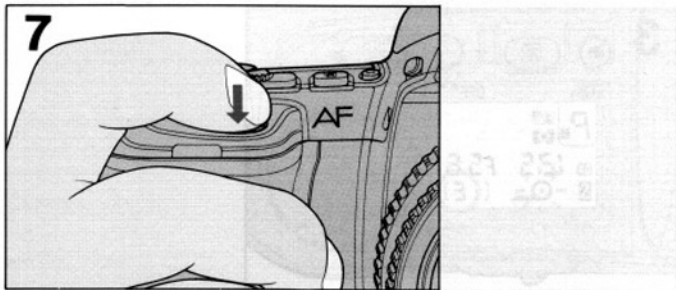

## REWINDING FILM

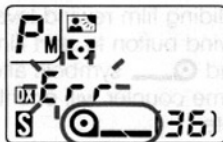
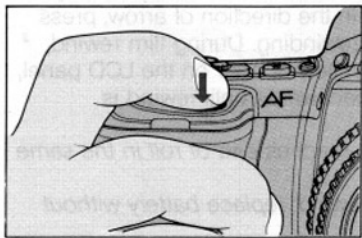
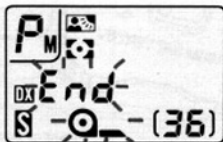
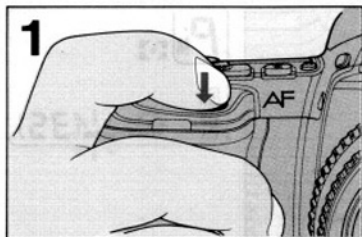

7 Fully depress shutter release button to take picture. Camera automatically advances film by one frame. And LCD panel's frame counter increases by one.





Shutter speed aperture indicators in LCD panel and inside viewfinder turn off approx. 2 sec. after you release shutter and remove your finger from shutter release button.

Film advance stops automatically at end of roll with blinking **End** and  symbol on the LCD panel. After exposure meter automatically turns off, each time you press shutter release button, **Err** blinks and  symbol appears instead, reminding you to rewind film.

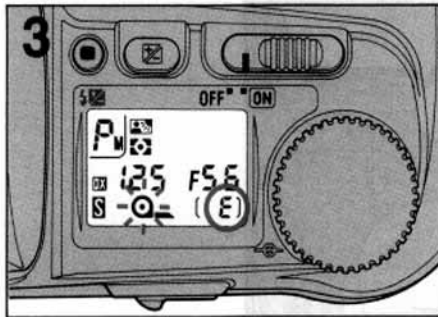
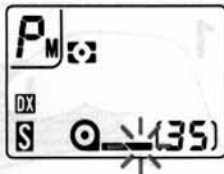
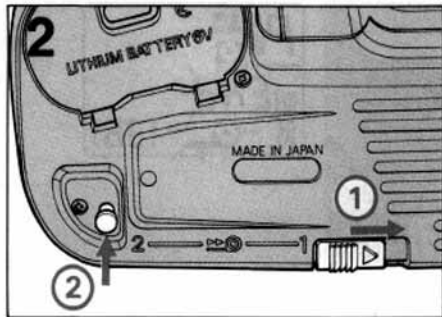
Open camera back and remove film cartridge.



While sliding film rewind lever in the direction of arrow, press film rewind button to start film rewinding. During film rewind,  and  symbols alternately appear on the LCD panel, and frame counter will count backwards until rewind is complete.

- You can rewind film before it reaches end of roll in the same manner.
- If camera stops during film rewind, replace battery without opening camera back. After installing battery, turn power switch on, and restart film rewind by the same method as before.

After rewind automatically stops, confirm frame counter shows **E**, and film installation symbol () blinks for a few seconds.

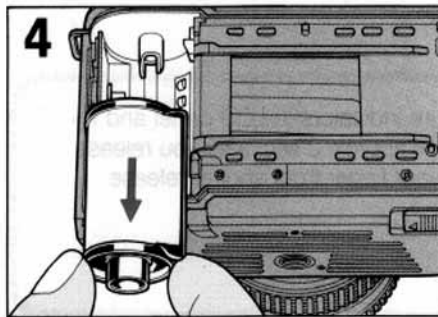

Open camera back and remove film cartridge.

# ***CONTROLS IN DETAIL/ PHOTOGRAPHIC TECHNIQUES***

# FILM SPEED SETTING

## USING AUTOMATIC FILM SPEED SETTING FOR DX-CODED FILMS



The N6006 offers two ways to set film speed — automatic film speed setting for DX-coded film and manual film speed setting. Each time you press the ISO button, while depressing the shift button, film speed setting changes from auto/DX to manual, or vice versa. The LCD panel shows **DX** for auto; there is no indication for manual.

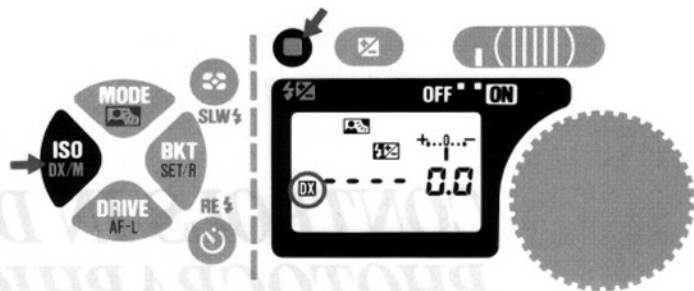

Usable film speed range for DX-coded film is ISO 25 to 5000.

1. Slide power switch to ON.
2. While depressing shift button, press film speed (ISO) button so **DX** is shown in LCD panel.

Camera automatically detects film speed (ISO 25 to 5000) of DX-coded film.



- After loading film, you can confirm speed by pressing ISO button. ISO number will appear in LCD panel and viewfinder.

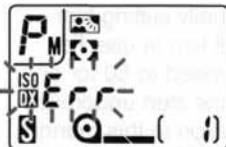

**If “Err,” ISO symbol and DX symbol are blinking:**

Non-DX-coded film or film with an unacceptable DX code is loaded. Set ISO manually.

## MANUAL FILM SPEED SETTING

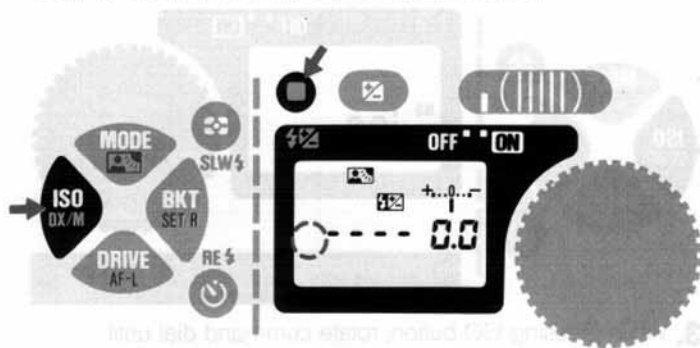

Usable range for manual film speed settings is ISO 6 to 6400.

1. Slide power switch to ON.
2. While depressing shift button, press film speed (ISO) button so that **DX** in the LCD panel disappears.



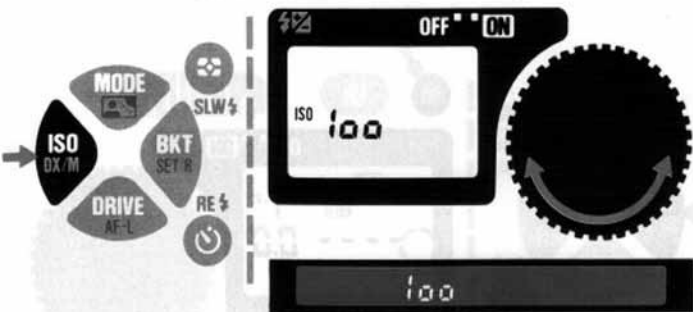

- 3.** While pressing ISO button, rotate command dial until desired number is shown.

Film speed setting display changes as follows:

6 - 8 - 10 - 12 - 16 - 20 - 25 - 32 - 40 - 50 - 64 - 80 - 100 -  
125 - 160 - 200 - 250 - 320 - 400 - 500 - 640 - 800 - 1000 -  
1250 - 1600 - 2000 - 2500 - 3200 - 4000 - 5000 - 6400

- *With or without film loaded, you can confirm film speed by pressing ISO button. Manually set ISO number will appear on the LCD panel and viewfinder.*
- *If DX-coded film is loaded, but manual film speed setting is selected, camera gives priority to the manually set ISO number.*

You can modify exposure by intentionally setting film speed to a value different from that of film in use. For example, with ISO 100 film, set film speed to 50 for one step overexposure or set to 200 for one step underexposure. After making exposure modification in this manner, make sure to reset film speed to correct value for film in use when you want the correct ISO exposure. For exposure compensation using other techniques, see pages 66 to 67.

# FILM ADVANCE MODE SETTING

## SINGLE-FRAME SHOOTING

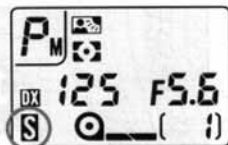

With film advance mode at **S**, fully depressing shutter release button takes one picture and automatically advances film by one frame.

## CONTINUOUS SHOOTING

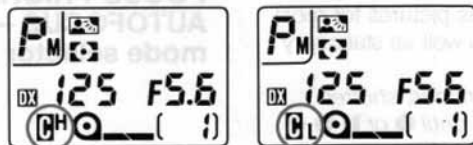

Shots are taken continuously as long as shutter release button is depressed. High- or low-speed continuous shooting can be selected.

Shooting speed is approx. 2 fps (frames per second) in **CH** mode or approx. 1.2 fps in **CL** mode — with a fresh battery pack at normal temperature and a shutter speed faster than 1/125 sec. The slower the shutter speed, the slower the motor speed.

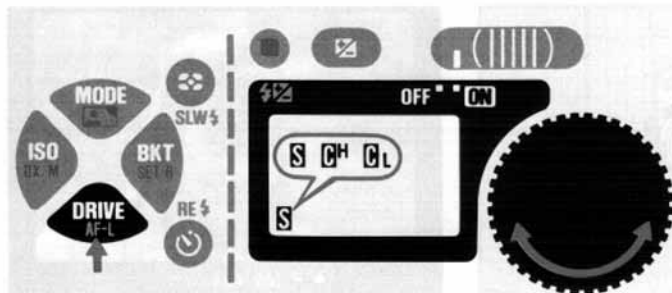

The Nikon N6006 has three automatic film-advance modes. To switch film-advance mode, press and hold DRIVE button and rotate command dial. **S** for single-frame shooting, **CL** for continuous low-speed shooting and **CH** for continuous high-speed shooting appear consecutively.

# FOCUSING

## AUTOFOCUS

The Nikon N6006 provides two autofocus modes, Focus-Priority Single autofocus and Focus-Priority Continuous autofocus. For both autofocus modes, and in any film advance mode, if subject is moving, focus tracking automatically works. The focus tracking system enables the camera to analyze the speed of the moving subject according to focus detection data, and drive the autofocus lens by anticipating the position at the exact moment of exposure. So, you can get correctly in-focus pictures for most moving subjects, as well as stationary subjects.

*In both autofocus modes, shutter cannot be released until ● or ►●◄ appears in the viewfinder.*

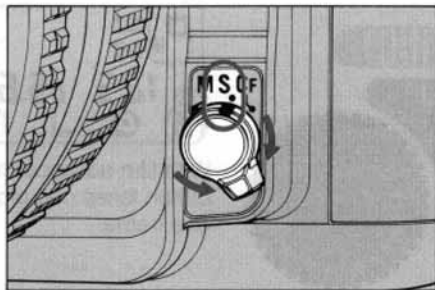

### FOCUS-PRIORITY SINGLE AUTOFOCUS – with focus mode selector at S



Stationary subject is in focus

**With a stationary subject:** When subject is in focus, autofocus stops and ● appears. Once subject is in focus in the Focus-Priority Single autofocus mode, focus is locked. If subject moves, remove your finger from shutter release button, then lightly press it again to start autofocus with focus tracking.



Focus tracking

**With a moving subject:** Focus tracking is automatically activated when you lightly press the shutter release button, as the lens is being driven. As soon as in-focus image is expected, ►●◄ appears, indicating that you can release shutter. If subject stops and ● appears without ► and ◄ arrows, focus is locked. If subject moves again, remove your finger from the shutter release button and lightly press it again to start autofocus with focus tracking.

- As focus is locked, Focus-Priority Single autofocus is convenient for off-center subjects. See pages 32 to 33.
- After shooting, you do not have to remove your finger from the shutter release button for the next shot. Slightly lift your finger off the button then fully depress it to release shutter again. In Focus Priority Single autofocus, focus remains locked even after shutter release unless you remove your finger from the shutter release button with film advance mode at S. Camera detects focus every time shutter is released with film advance mode at CH or CL.
- With a moving subject, depending on subject status and lens in use, slightly-out-of-focus pictures may result.

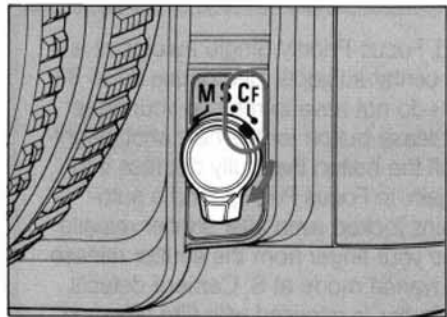

## FOCUS-PRIORITY CONTINUOUS AUTOFOCUS — with focus mode selector at CF

Autofocus continues as long as you keep lightly pressing the shutter release button.



Stationary subject is in focus

**With a stationary subject:** Autofocus starts when you lightly press the shutter release button. When subject is in focus, camera's motor stops driving the autofocus lens and ● lights up. Unless you remove your finger from the shutter release button, the motor will start driving the lens again to obtain an in-focus picture if the focus distance changes because either you or the subject moves.



Focus tracking

**With a moving subject:** Focus tracking is automatically activated when you lightly press the shutter release button, as the lens is being driven. As soon as an in-focus image is expected, ►●◀ appears, indicating that you can release shutter. Focus tracking stays activated as long as you keep lightly pressing the shutter release button while following the moving subject. When the subject stops, the motor stops driving the autofocus lens as soon as an in-focus image is obtained and ● appears.

- After shooting, you do not have to remove your finger from the shutter release button for the next shot. Slightly lift your finger off the button then fully depress it to release shutter again. In Focus Priority Continuous autofocus, camera detects focus every time shutter is released regardless of film advance mode.
- With a moving subject, depending on subject status and lens in use, slightly-out-of-focus pictures may result.

## AUTOFOCUS WITH MAIN SUBJECT OFF CENTER – SETTING AF-L (AUTOFOCUS LOCK) FUNCTION

The N6006's AF-L function lets you lock both focus and auto exposure. So it is recommended that you should set AF-L function on the camera.

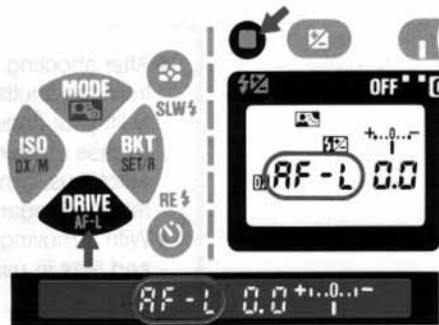

AF-L function is set

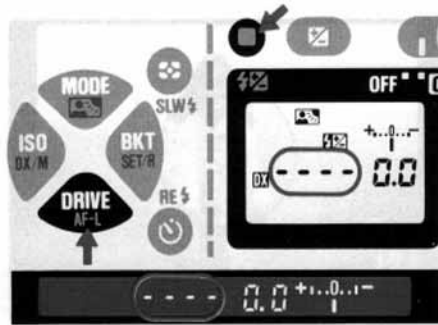

AF-L function is canceled

To set AF-L function, while pressing shift button, press AF-L function button so **AF-L** appears in the LCD panel. Each time you press AF-L button, while pressing shift button, AF-L function is set or canceled.

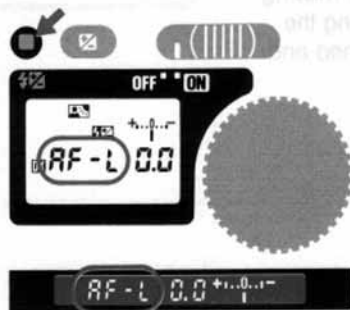

- If you remove your finger from shift button, AF-L function indication disappears. However, you can check whether AF-L function is set or canceled by pressing shift button again.



## IN FOCUS-PRIORITY SINGLE AUTOFOCUS

With AF-L function set, in auto exposure mode, exposure is simultaneously locked when focus is locked. Without AF-L function set, only focus is locked in Focus-Priority Single Autofocus.

With a moving subject, focus cannot be locked.

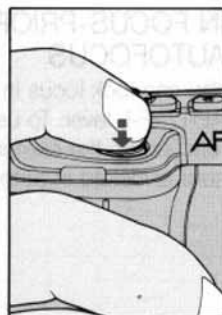

1. Position focus brackets on subject and lightly press the shutter release button.



2. Confirm in-focus indicator ● appears in the viewfinder.

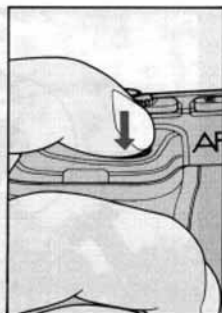
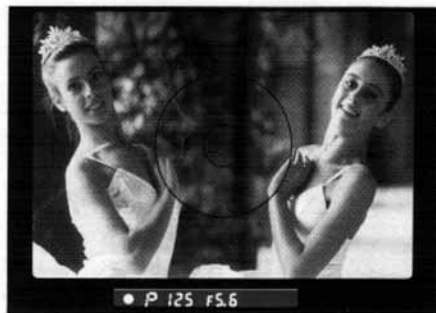

3. Keeping the shutter release button lightly pressed, recompose, then fully depress shutter release button.

## IN FOCUS-PRIORITY CONTINUOUS AUTOFOCUS

You can lock focus in Focus-Priority Continuous autofocus with AE-L/AF-L lever. To use the lever for focus lock, first set AF-L function on the camera. Without AF-L function set, only exposure is locked in auto exposure mode.

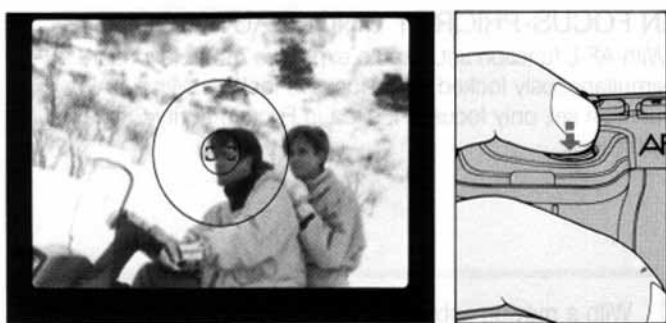

1. Position focus brackets on subject and lightly press the shutter release button to start autofocus operation.

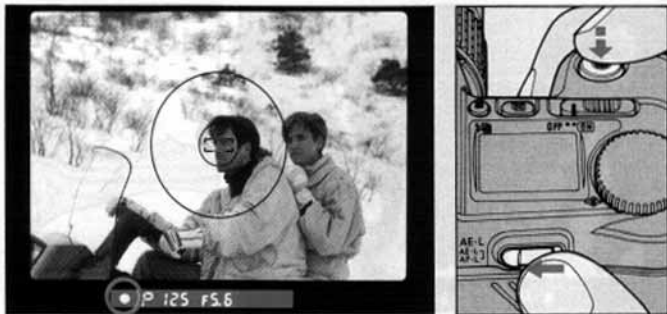

2. Keeping shutter release button lightly pressed, confirm in-focus indicator ● is visible, then slide AE-L/AF-L lever and hold in.

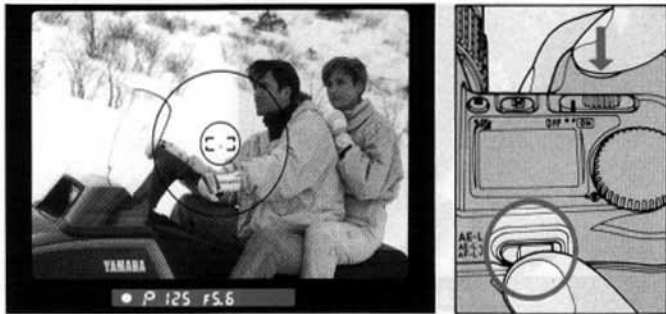

3. With AE-L/AF-L lever held in, recompose as desired and fully depress shutter release button to take picture.

## SPECIAL FOCUSING SITUATIONS

Autofocus operation depends on general lighting, subject contrast and detail, and other technical points. In those rare situations where autofocus is not possible, ● blinks telling you to ...



### A. Very dark subject

Focus manually with clear matte field, or for autofocus, focus on another, brighter subject located at same distance then use focus lock.

Or, use a Nikon autofocus Speedlight to perform autofocus with AF illuminator (See page 84).

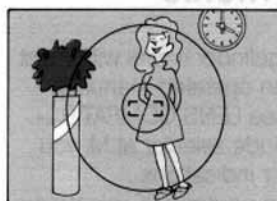

### B. Low-contrast subject

Focus manually with clear matte field, or for autofocus, focus on another subject at same distance but with more contrast, then use focus lock.



### C. Subject with no vertical lines

Focus manually with clear matte field, or for autofocus, turn the camera sideways. You can also perform autofocus on another subject at same distance but with vertical lines, using focus lock.

### D. Scene with subjects located at different distances

### E. Bright subjects with a shiny surface, such as silver or aluminum

### F. Strongly backlit subjects

### G. When using a linear polarizing filter, or special filter\* such as a soft-focus filter

} Focus manually with clear matte field.

\*Circular polarizing filter can be used for autofocus operation.

## MANUAL FOCUS

There are two ways to manually focus. Manual focus with electronic rangefinder and manual focus using viewfinder clear matte field.

### MANUAL FOCUS WITH ELECTRONIC RANGEFINDER

Manual focus using the electronic rangefinder works with most Nikon lenses, including AF Nikkor when operated manually. (For a complete list of usable lenses, see LENS COMPATIBILITY CHART on page 82). With focus mode selector at M, you can see focus status with the viewfinder indications.

- For special focusing situations shown on page 35, electronic rangefinder does not correctly work. Focus using clear matte field.
- When using lenses with a maximum aperture slower than  $f/5.6$ , ignore focus indications and use clear matte field for focusing.

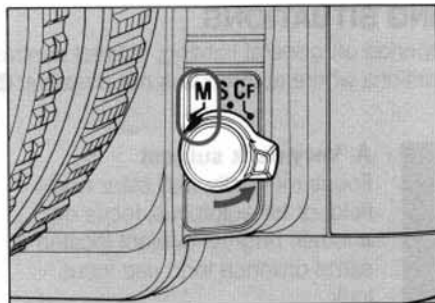

1. Set focus mode selector to M for manual focus.
  - If lens has an A-M switch, set to M.

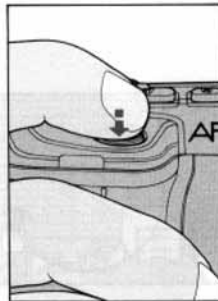

2. Look through viewfinder and position focus brackets on the main subject. Then lightly press the shutter release button.

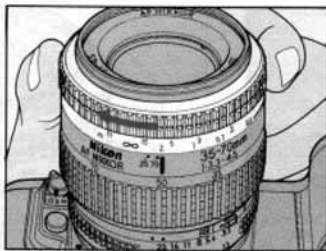
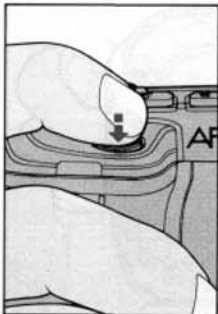

If focus-to-left arrow (◀) does not disappear when you turn focus ring counterclockwise to the limit, subject is closer than the lens' closest focused distance. Move back from the subject.

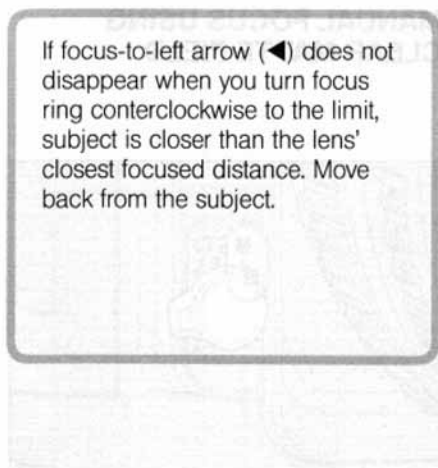

3. Keeping shutter release button lightly pressed, rotate lens focusing ring in the direction that focus-to-left arrow (◀) or focus-to-right arrow (▶) indicates, until the arrow disappears and in-focus indicator ● appears.

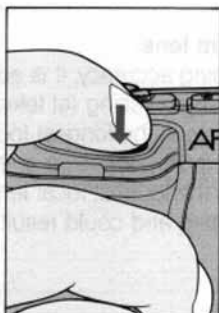

4. Confirm in-focus indicator ● appears, then fully depress shutter release button to take the picture.

## MANUAL FOCUS USING CLEAR MATTE FIELD

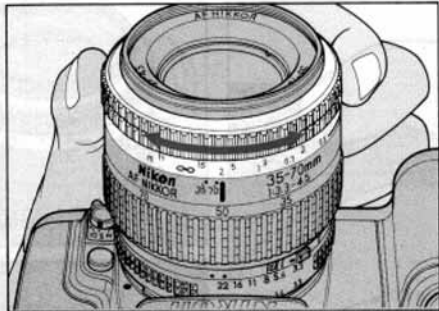
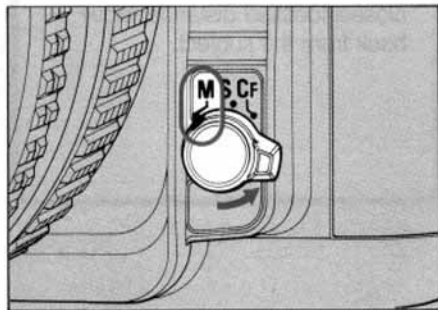

2. Look through the viewfinder and rotate lens focus ring until subject on clear matte field appears sharp.

1. Set to focus mode selector to M for manual focus.
  - If lens has an A-M switch, set to M.

### When using a zoom lens:

For maximum focusing accuracy, it is advised that you should focus at the lens' longest focal length setting (at telephoto side). The shallow depth of field and large image scale at the longest focal length setting, help to ensure pin-point focusing. Conversely, focusing at the shortest focal length setting and then zooming up to the longest focal length setting will magnify any slight imprecision in focusing and could result in unsharp pictures.

# EXPOSURE

## EXPOSURE METERING SYSTEMS

The Nikon N6006 provides three types of exposure metering systems — Matrix Metering, Center-Weighted Metering and Spot Metering.

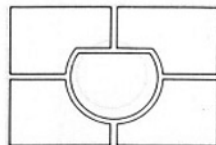

### MATRIX METERING

This system is ideally suited for quick operation and for the most dependable auto exposure control. It can also be used for manual metering and flash exposure control operation with any Nikon TTL Speedlight.

In Matrix Metering, the meter automatically provides the correct exposure of the main subject in virtually any lighting situation, without requiring manual exposure compensation. The Matrix Metering sensor determines scene brightness by dividing the scene into five areas, then analyzing each area for brightness and scene contrast.

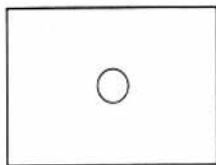
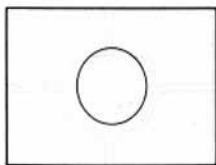

## CENTER-WEIGHTED METERING

Choose Center-Weighted Metering when you want to base exposure on either auto or manual exposure control for a centrally located subject. Selecting Center-Weighted Metering overrides Matrix Metering and concentrates 75% of the meter's sensitivity into the center of the viewfinder outlined by a 12mm circle.

## SPOT METERING

For selective metering of tiny subjects or for advanced manual metering techniques, use Spot Metering.

The area metered is represented by the approx. 3.5mm-diameter circle in the center of the viewfinder. This metering system is effective when precise measurement of a special portion of the subject is required.



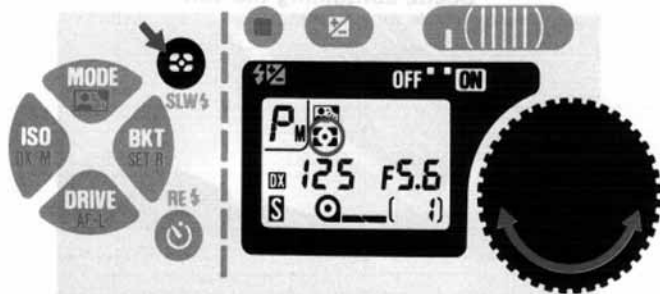

Matrix Metering

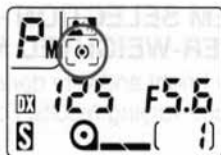

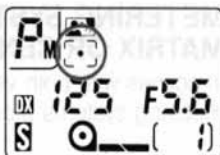

Center-Weighted  
Metering



Spot Metering

## METERING SYSTEM SETTING

1. Slide main switch to ON.
2. While pressing metering system button, rotate command dial until your desired symbol —  for Matrix Metering,  for Center-Weighted Metering or  for Spot Metering appears in the LCD panel.

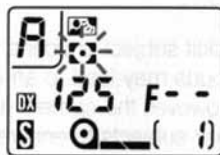

Matrix Metering is possible only with lenses that have a built-in CPU (such as AF Nikkor and AI-P lenses). When a lens without a built-in CPU or no lens is used, the metering system is automatically set to Center-Weighted. In either case, if you lightly press the shutter release button, the  symbol blinks.

## METERING SYSTEM SELECTION – WHEN TO USE MATRIX OR CENTER-WEIGHTED METERING

In scenes with both very bright and very dark areas, these two metering systems produce varying results. For example:

### A. Scene containing the sun or scenes with high reflectivity

If a scene contains strong highlights, such as the sun, snow or bright reflections, Center-Weighted Metering renders the main subject as a silhouette. With Matrix Metering, however, the light value of darker parts is evaluated, resulting in an overall well-balanced exposure.

### B. Outdoor backlit subject

With Center-Weighted Metering, a backlit subject or scene with people against a bright sky and/or clouds may lead to an underexposed shot. With Matrix Metering, however, the camera automatically gives more exposure to darker subjects to ensure a balanced overall exposure.

### C. Front-lit subject against dark background

If a brightly lit off-center subject is positioned against a dark background, Center-Weighted Metering places too much emphasis on the dark center of the picture. So although the background is correctly exposed, the main subject will be overexposed. Matrix Metering, however, automatically integrates a dark background with a bright subject to ensure the best overall exposure.

Scene containing the sun

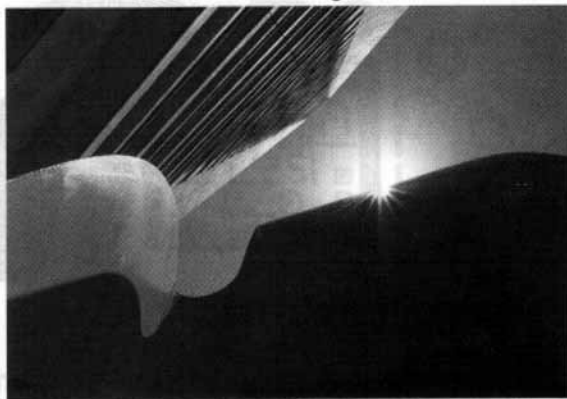

Matrix Metering



Center-Weighted Metering

Outdoor backlit subject



Matrix Metering



Center-Weighted Metering

Front-lit subject



Matrix Metering



Center-Weighted Metering

#### D. Small dark subjects against a bright background

A subject significantly smaller than any of the Matrix Metering sections may not be recognized and integrated into the automatic exposure evaluation. For such subjects, switch to Center-Weighted Metering and make exposure compensation with AE lock lever\* or exposure compensation button\*\* in Auto exposure mode, or obtain correct exposure meter reading on the main subject\*\*\* in Manual exposure mode.

\* See pp 64 - 65

\*\* See pp 66 - 67

\*\*\* See pp 62 - 63



Matrix Metering



Center-Weighted Metering (with AE Lock)



Center-Weighted Metering (without AE Lock)

## E. Sunset scenes

If you want to emphasize a dramatic sunset but don't want Matrix Metering to lighten the scene for a dark foreground subject, use Center-Weighted Metering with or without exposure compensation.



Matrix Metering



Center-Weighted Metering

## EXPOSURE MODE

Light reaching the film is controlled by the shutter and aperture. The proper combination of shutter and aperture settings results in the correct exposure. The necessary settings will be based upon the ISO speed set for the film in use and the operation of the camera's exposure control system.

The relationship between aperture and shutter is as follows: One change in shutter speed either doubles or halves the light transmitted. For example, 1/500 passes half the light as 1/250 and double the light of 1/1000. The aperture f/8 passes half the light of f/5.6 and double the light of f/11. If the correct exposure for a scene is 1/500 at f/8, then we can also select 1/250 at f/11 or 1/1000 at f/5.6 and achieve the same exposure results.

Selecting the exposure control mode means deciding if you want the shutter speed/aperture to be set automatically or manually.

The Nikon N6006 offers five modes: four automatic exposure control modes — Auto Multi-Program (**P**), Normal-Programmed (**P**), Shutter-Priority auto (**S**), and Aperture-Priority auto (**A**) — in addition to Manual (**M**) mode. Each exposure mode has its own advantages.

In Programmed auto exposure mode, as the optimum combination of shutter speed and aperture is automatically set by the N6006's microcomputer, you can concentrate completely on picture composition and have greater opportunities to shoot, without worrying about exposure.

In Shutter-Priority auto exposure mode, you can manually set shutter speed as desired. That is, you can freeze the action with sharp, clear images using a fast shutter speed, or create motion effects by choosing slower shutter speeds.

In Aperture-Priority auto exposure mode, you can control depth of field by varying the aperture. You can use a larger aperture (smaller f-number) for shallower depth of field to create softer, less distinct backgrounds, or choose a smaller aperture (larger f-number) for greater depth of field.

In Manual exposure mode, in addition to controlling both shutter speed and aperture, you can easily create intentionally over- or underexposed photos.

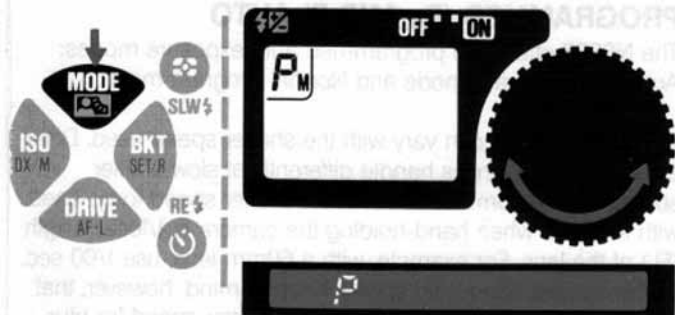

## EXPOSURE MODE SETTING

After turning power switch on, while pressing MODE button, rotate command dial. Exposure mode changes in the following sequence:

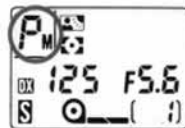

**P** 125 F5.6  
Auto Multi-Program

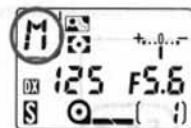

**M** 125 F5.6  
Manual

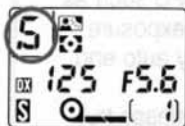

**S** 125 F5.6  
Shutter-Priority Auto

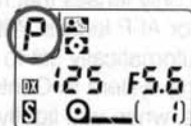

**P** 125 F5.6  
Normal Program

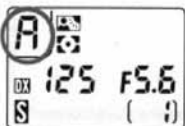

**A** 125 F5.6  
Aperture-Priority Auto

Correspondingly, P, S, A, M or P will appear on the LCD panel while P (for both Auto Multi-Program and Normal Program), S, A and M will appear inside viewfinder.

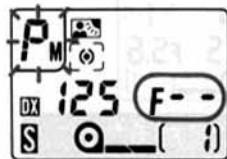

For Programmed auto or Shutter-Priority auto exposure mode, use only lenses that have a built-in CPU such as AF Nikkor or AI-P lenses. With other lenses, exposure mode is automatically set to Aperture-Priority auto and the metering system to Center-Weighted. In this case, when you lightly press shutter release button, exposure mode indicator blinks and **F--** appears on the LCD panel.

## PROGRAMMED (P<sub>M</sub> AND P) AUTO

The N6006 offers two programmed auto exposure modes: Auto Multi-Program mode and Normal Program mode.

Picture sharpness can vary with the shutter speed used. Different focal length lenses handle differently at slow shutter speeds. The recommended slowest shutter speed to be used with any lens when hand-holding the camera is 1/focal length (FL) of the lens. For example, with a 60mm lens, use 1/60 sec. as the slowest hand-held speed. Keep in mind, however, that 1/30 sec. is the lowest recommended shutter speed for blur-free hand-held shooting.

The N6006's Auto Multi-Program varies the exposure program lines according to the focal length and lens maximum aperture. The inclinations of lines in the chart are designed to reduce the possibility of picture blur by avoiding slower shutter speeds. With Normal Program, you get a standard combination of shutter speed and aperture.



## Program Charts

The EV (exposure value) charts demonstrate the difference between N6006 Auto Multi-Program and Normal Program. Follow either colored line to where it intersects a diagonal line. This shows the combination of aperture (vertical line) and shutter speed (horizontal line), which will automatically be selected at each EV brightness level.

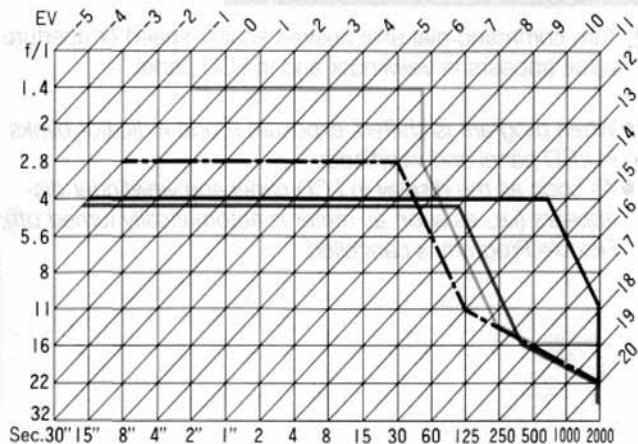

**Auto Multi-Program Chart (ISO 100)**

- With 50mm f/1.4
- · - · - With 28mm f/2.8
- With Zoom 35-135mm f/3.5-f/4.5 at 100mm (f/4.2) setting
- With 500mm f/4

## Operation in programmed auto exposure mode

Operation for Auto-Multi Program and Normal Program are performed in the same manner. See BASIC SHOOTING on pp 16 - 21.

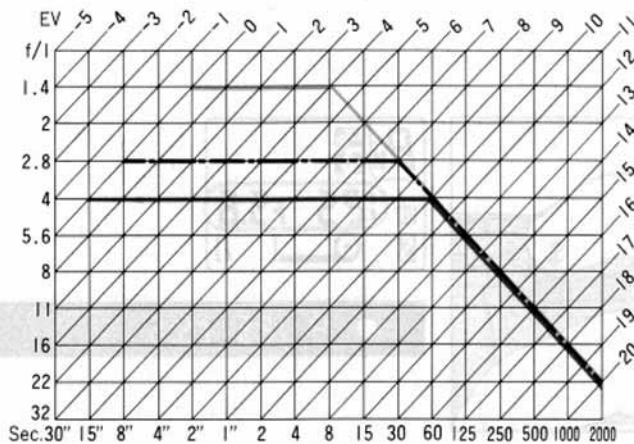

**Normal Program Chart (ISO 100)**

- With f/1.4 lens
- · - · - With f/2.8 lens
- With f/4 lens

## FLEXIBLE PROGRAM

When you want to use a specific shutter speed or aperture in Programmed auto exposure mode, use the Flexible Program function. Flexible Program enables you to temporarily change an automatically set shutter speed/aperture combination in 1 EV steps, while maintaining the correct exposure.

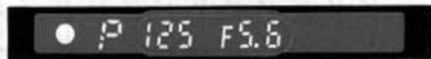
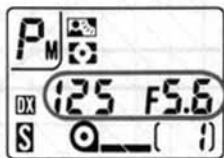
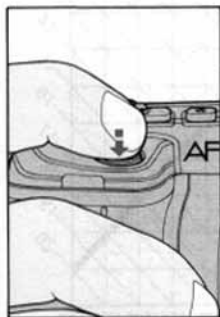

1. Lightly press shutter release button.

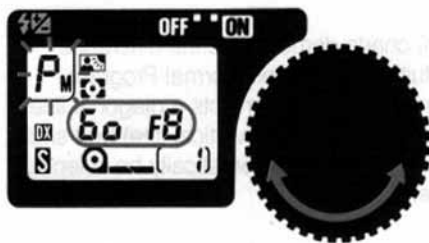

2. Turn command dial until desired shutter speed or aperture value appears in viewfinder and in LCD panel.

- When program is shifted, exposure mode indicator blinks in LCD panel and viewfinder.
- As soon as the display in LCD panel and viewfinder disappears (i.e., as soon as meter is automatically turned off), Flexible Program is cancelled.

## SHUTTER-PRIORITY AUTO EXPOSURE MODE

Subject movement and your ability to hold the camera steady will determine what shutter speed you should choose. Faster speeds will generally produce sharper images. For creative effects you may use slower speeds. Make your choice accordingly. The N6006's computer automatically selects the proper aperture to match the selected shutter speed for correct exposure. Shutter-Priority auto mode operates only with Nikon lenses that have a built-in CPU (AF Nikkor and AI-P Nikkor).



At a fast shutter speed



At a slow shutter speed

## OPERATION IN SHUTTER-PRIORITY AUTO EXPOSURE MODE

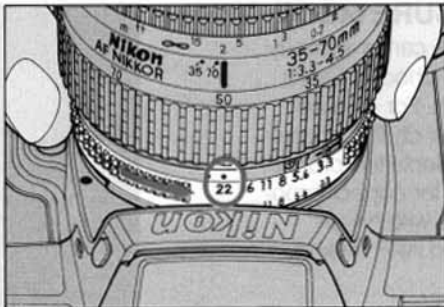

1. Set lens to its minimum aperture setting (highest f-number).  
With AF Nikkor and AI-P-Nikkor lenses, lock lens aperture at minimum setting.

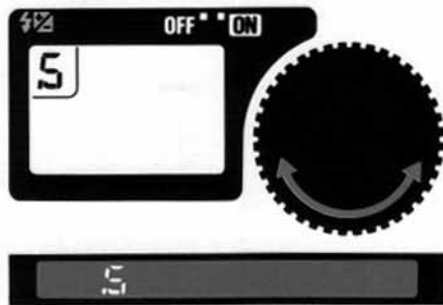

2. While pressing MODE button, rotate command dial until "S" appears on LCD panel and viewfinder.

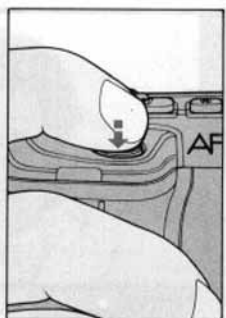

3. Remove finger from MODE button, and rotate command dial to select desired shutter speed.
  - Shutter speed indication changes one step at a time in the following sequence:  
30"-15"-8"-4"-2"-1"-2-4-8-15-30-60-125-250-500-1000-2000

If meter has automatically turned off and LCD indicators disappear, turn meter on again by lightly pressing shutter release button.

4. Look inside viewfinder, compose and lightly press shutter release button.

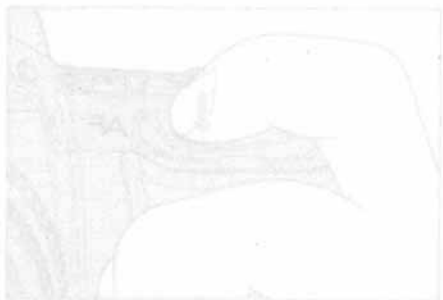



5. Confirm aperture value.  
Camera selects correct aperture for shutter speed selected.

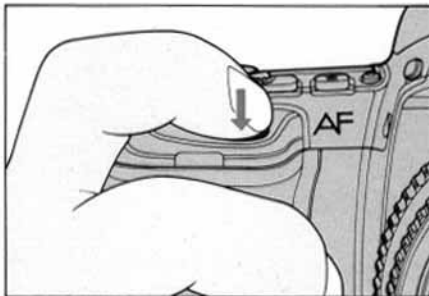

6. Fully depress shutter release button to take the picture.



If "HI" blinks in the aperture position with electronic analog display\* – Overexposure alert:

Overexposure may occur. Select higher shutter speed or use Nikon ND filter.

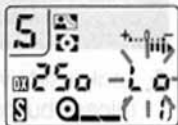

If "Lo" blinks in the aperture position with or without electronic analog display\* – Underexposure alert:

Underexposure may occur. Select slower shutter speed, or use built-in TTL flash or an accessory Nikon Speedlight.

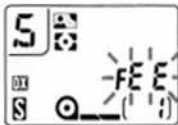

If "FEE" blinks in the aperture position – Lens setting error alert:

Lens is not set to smallest aperture setting and shutter locks. Set lens to smallest aperture.

\* Shows value difference from correct exposure.

## APERTURE-PRIORITY AUTO EXPOSURE MODE

Select the aperture based on how shallow or large you want depth of field to be. Smaller apertures will make the background and foreground sharper (good for scenic pictures) while larger apertures will produce a shallower depth of field (good for portraits). Your selected aperture will determine the shutter speed which is automatically set by the camera's computer. When using the smaller apertures with corresponding slower shutter speeds, remember as a rule of thumb that any speed below 1/30 sec. may require the use of a tripod to prevent picture blur due to camera shake. Also, the higher the corresponding shutter speed, the easier it is to stop action. Adjust the selected aperture if the speed is not appropriate for conditions or the specific effect you want.



At wide aperture



At small aperture

# OPERATION IN APERTURE-PRIORITY AUTO EXPOSURE MODE

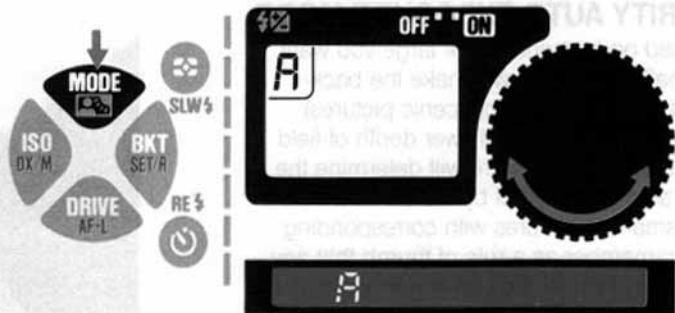

1. While pressing exposure MODE button, rotate command dial until "A" appears on the LCD panel and viewfinder.

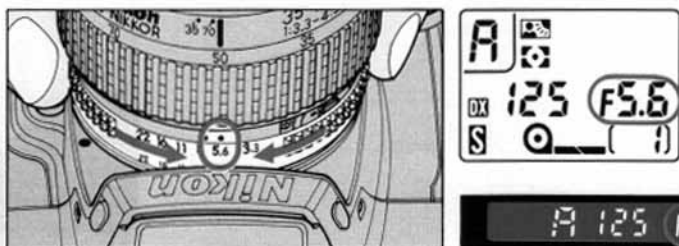

2. Remove finger from exposure mode setting button and set lens to desired f-number by rotating lens aperture ring. Aperture changes in the following sequence, as indicated in LCD panel and viewfinder.

F1-F1.4-F2-F2.8-F4-F5.6-F8-F11-F16-F22-F32-F45-F64

(Available apertures limited to those on lens in use.)



If meter is automatically turned off and LCD indicators disappear, turn meter on again by lightly pressing shutter release button.

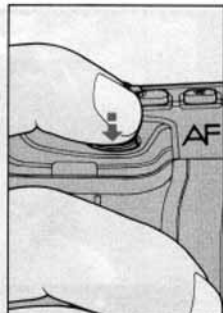

3. Look inside viewfinder, compose and lightly press shutter release button.

- An intermediate figure (e.g. F1.8, F3.3) displayed indicates a lens' maximum aperture. Also, with zoom lenses, the maximum aperture for different focal length settings appears in 1/6 EV steps.
- With lenses having no CPU, "F--" appears instead of aperture value on the LCD panel and viewfinder.
- With an AF Nikkor or AI-P lens, make sure to unlock aperture ring before rotating it.





• A 1/25 F5.6

4. Confirm shutter speed.  
Camera selects correct shutter speed to match your aperture setting.

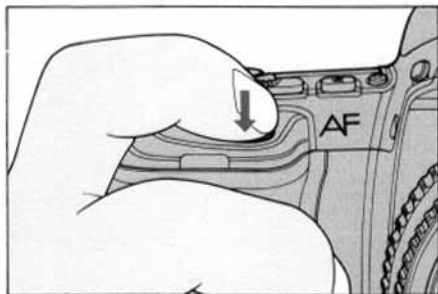

5. Fully depress shutter release button to take the picture.

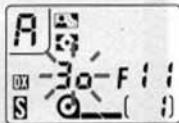

A 1/30 F11

**If shutter speed indicator blinks – Picture blur alert:**

A shutter speed of 1/FL is generally accepted as the minimum speed for hand-held photography, but since not everyone can hold a camera equally steady, this is just a guideline. The blinking shutter speed indication warns you that the exposure conditions call for a speed of 1/FL or slower. For example, with a 200mm lens, shutter speed indication blinks when automatically selected speed is 1/200 sec. or slower. Make adjustments to shutter/aperture if that speed is inappropriate for the picture conditions.

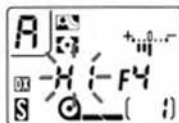

A HI F4

**If "HI" blinks in the shutter speed position with electronic analog display\* – Overexposure alert:**

Overexposure may occur. Select smaller aperture (larger f-number) or use ND filter.

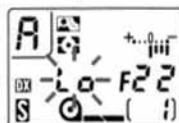

A Lo F2.2

**If "Lo" blinks in the shutter speed position with or without electronic analog display\* – Underexposure alert:**

Underexposure may occur. Select wider aperture (smaller f-number), or use a Nikon Speedlight.

\* Shows value difference from correct exposure.

## MANUAL EXPOSURE MODE

Manual exposure control allows you to make both aperture and shutter speed settings. You'll probably follow the recommendation of the camera's light meter for technically correct exposure, but you may choose otherwise and modify exposure settings for creative effects or special requirements.

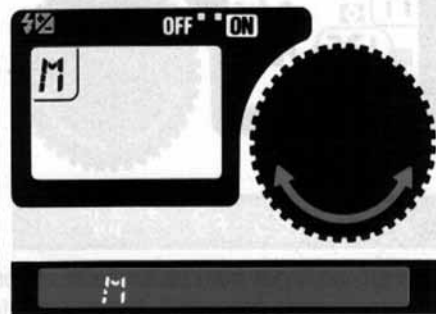
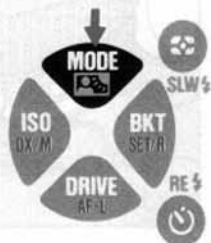

### OPERATION IN MANUAL EXPOSURE MODE

1. While pressing exposure mode button (MODE), rotate command dial until "M" appears on the LCD panel and viewfinder.

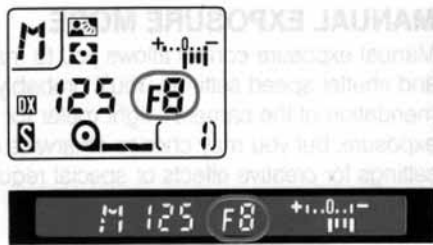
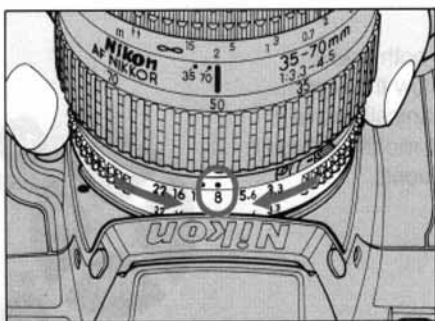
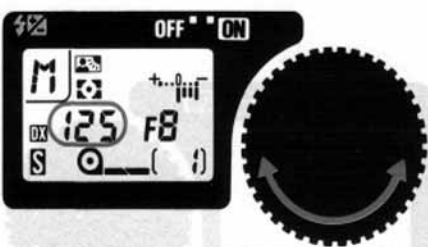

2. Remove finger from exposure mode button, set shutter speed using command dial, and aperture using lens aperture ring.

• With lenses that have no CPU, "F--" appears instead of aperture value on the LCD panel and viewfinder.

If meter is automatically turned off and LCD indicators disappear, turn meter on again by lightly pressing shutter release button.

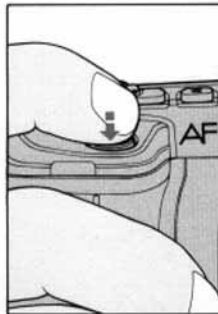

3. Look into the viewfinder, compose and lightly press shutter release button.

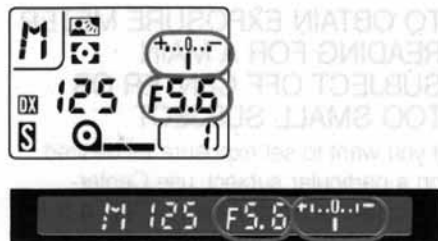
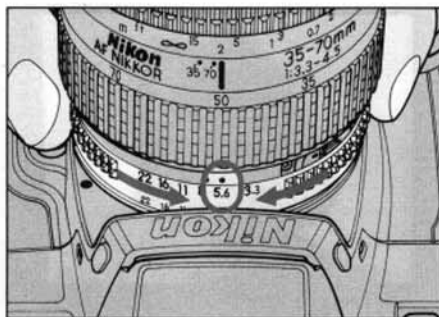
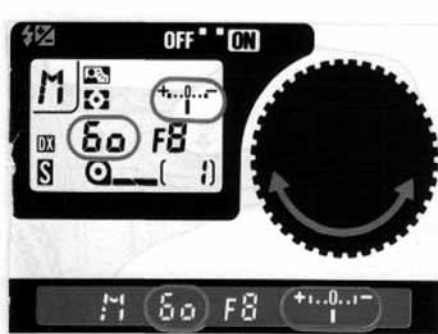

4. Adjust aperture and/or shutter speed until Electronic Analog Display indicates "0" or the desired exposure.
- With an AF Nikkor or AI-P lens, make sure to unlock aperture ring before rotating it.

The electronic analog display range is +1EV to -1EV, in increments of 1/3EV. ◀ and ▶ appear in the electronic analog display when exposure is beyond ±1EV.

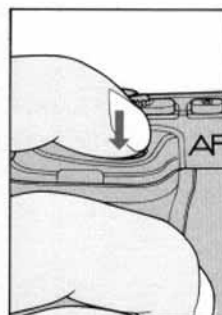
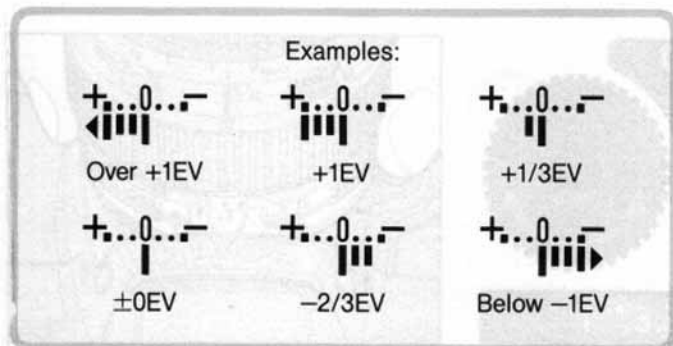

5. Fully depress shutter release button to take the picture.

## TO OBTAIN EXPOSURE METER READING FOR A MAIN SUBJECT OFF CENTER OR TOO SMALL SUBJECT

If you want to set exposure as desired on a particular subject, use Center-Weighted or Spot Metering. With a subject located off center in the viewfinder, when a subject is too small to cover the 12mm-diameter center circle, or when there is a substantial difference in brightness between the main subject and the background (e.g., a strongly backlit subject), use the following method.

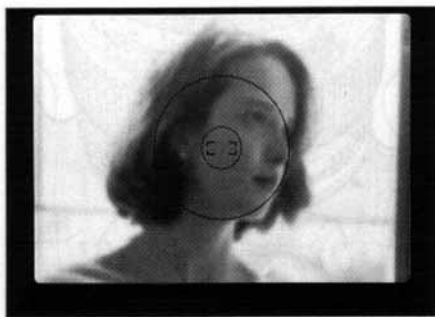

1. Center main subject inside viewfinder's 12mm circle and/or move in closer so the circle is covered by the subject.

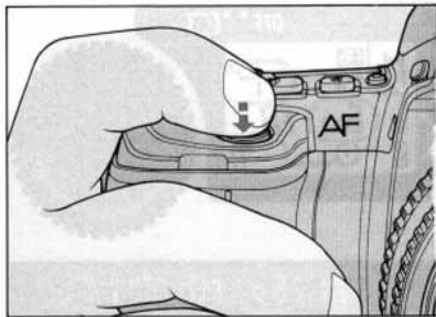

2. Lightly press shutter release button.

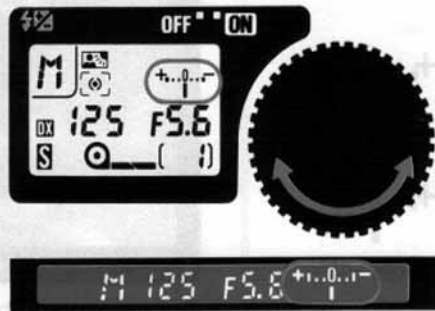

3. Adjust shutter speed and aperture until electronic analog display shows desired exposure.

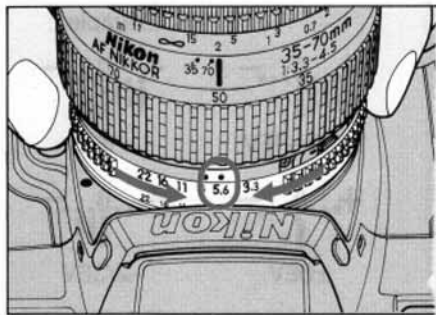

## BULB SETTING

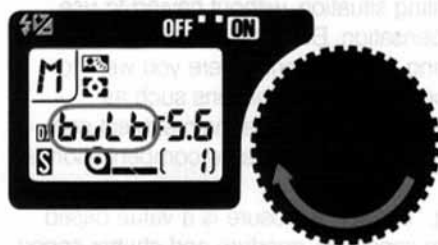

For long-time exposure, use B (bulb) setting. On bulb setting, shutter remains open as long as shutter release button remains depressed. This setting can only be used in Manual exposure mode. To select, rotate command dial clockwise until **"bulb"** appears.

- When using bulb setting, camera must be held very steady. Use a tripod and cable release.
- You can perform long-time exposure for approximately 7 hours with a fresh battery set.

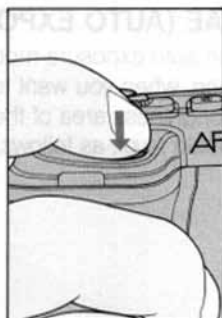

4. Recompose the picture, focus and shoot.

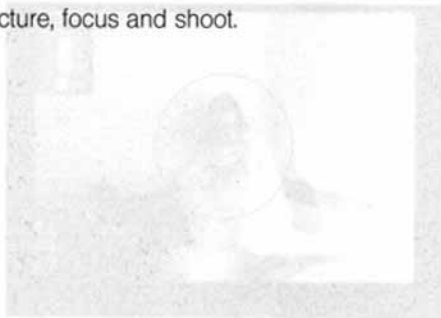

## EXPOSURE COMPENSATION

Matrix Metering provides the main subject with correct exposure in virtually any lighting situation, without having to use manual exposure compensation. But in Center-Weighted Metering or Spot Metering, for situations where you want to change compositions or for unusual situations such as snowscapes, backlit subjects or when the main subject contrasts sharply with the background, exposure compensation is recommended.

Also, in Matrix Metering, "correct" exposure is a value based on a combination of film sensitivity, aperture and shutter speed necessary to produce a "technically correct" exposure result. We often want to vary the exposure results to create different versions of the same picture or put creative emphasis on a specific part of the picture. This is accomplished by using exposure compensation.

Exposure compensation can be accomplished in either one or a combination of the following ways.

- AE (Auto Exposure) Lock Lever
- Exposure Compensation Button
- Auto Exposure Bracketing

As the results can vary depending on conditions, you may want to experiment with each method.

## AE (AUTO EXPOSURE) LOCK LEVER

In auto exposure mode with Center-Weighted or Spot Metering, when you want to control exposure based on a particular brightness area of the scene, use the AE-L (auto exposure lock) lever, as follows.



1. Center main subject inside viewfinder's 12mm circle for Center-Weighted Metering and/or move in closer so the circle is covered by the subject.



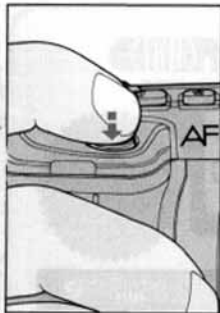

2. Lightly press shutter release button, and confirm shutter speed and aperture in viewfinder.

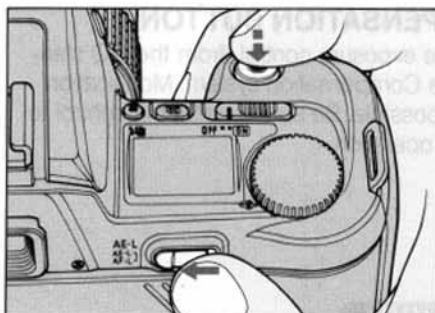

3. While lightly pressing shutter release button, slide AE-L lever and hold in.
- While AE-L lever is held in, shutter speed indication does not blink for picture-blur alert even if a slow shutter speed is selected.

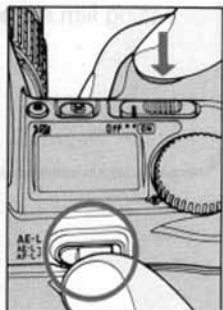

4. Recompose and shoot.

In Focus-Priority Single autofocus, both focus and exposure are locked when subject is in focus.

In Focus-Priority Continuous autofocus, when autofocus lock function is set, focus will be simultaneously locked while AE-L lever is held in. (See pages 64 to 65)

## EXPOSURE COMPENSATION BUTTON

If you wish to modify the exposure control (from the ISO standard), use the Exposure Compensation system. Modification from  $-5\text{EV}$  to  $+5\text{EV}$  is possible. Be sure to reset the control to zero to resume normal operation.



While pressing exposure compensation  button, rotate command dial to set desired compensation value. The following display appears on the LCD panel and viewfinder:

### symbol



### Electronic analog display with indications

**from  $-1$  to  $+1$  EV in  $1/3$  steps:** Confirm the direction of exposure ( $-$  or  $+$ ).

**Compensation value (from  $-5$  to  $+5$  EV in  $1/3$  steps):**

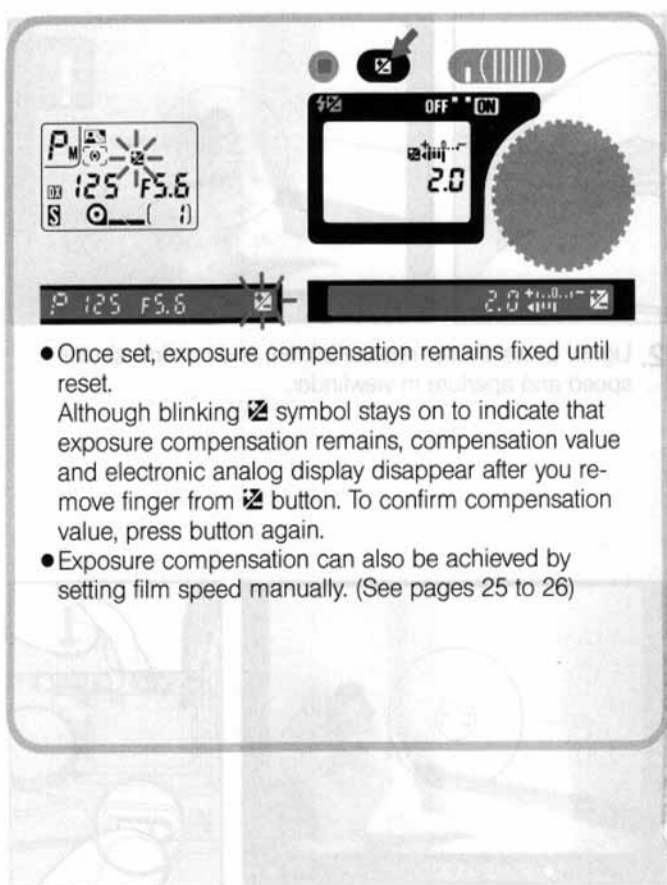
Confirm amount of exposure compensation.



- Once set, exposure compensation remains fixed until reset. Although blinking  symbol stays on to indicate that exposure compensation remains, compensation value and electronic analog display disappear after you remove finger from  button. To confirm compensation value, press button again.
- Exposure compensation can also be achieved by setting film speed manually. (See pages 25 to 26)



Without compensation



+2EV compensation

Examples:

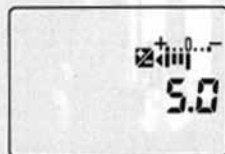

Over +1EV

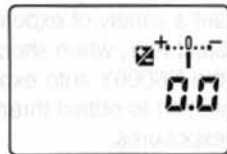

±0EV

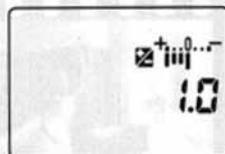

+1EV

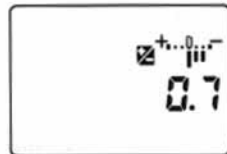

-2/3EV

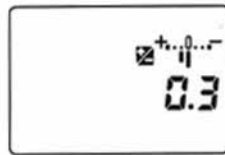

+1/3EV

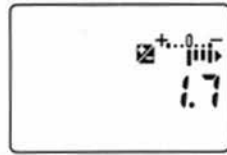

Below -1EV

## AUTO EXPOSURE BRACKETING

When you want a variety of exposures of the same subject (e.g., when shooting a sunset), use the N6006's auto exposure bracketing function to obtain three or five different exposures.

Auto exposure bracketing only operates in connection with any of the auto exposure control modes.



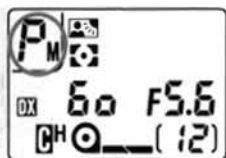

P P M S A

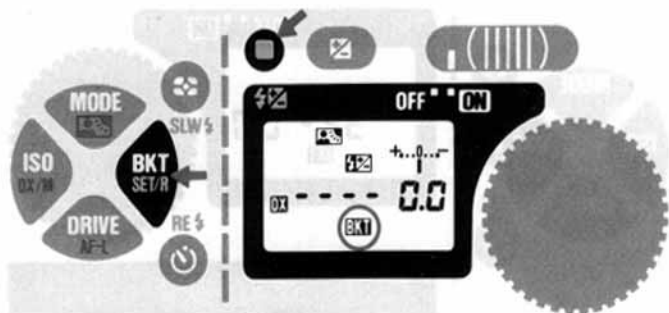

1. Set exposure mode to Programmed auto, Shutter-Priority auto or Aperture-Priority auto.  
In Programmed auto exposure mode, both shutter speed and aperture will be changed for your set compensation value in stepped sequence. Aperture will be changed in Shutter-Priority auto; shutter speed will be changed in Aperture-Priority auto.



2. While pressing shift button, push BKT button to set auto exposure bracketing. Blinking **BKT**\* and **☒** marks appear on the LCD panel. Inside viewfinder, **☒** symbol is blinking.  
*\* **BKT** symbol remains after meter is turned off, but stops blinking.*

With exposure mode set at Manual, no exposure compensation will be made but as many shots as number of frames set will be taken.



3. While pressing BKT button, rotate command dial until your desired combination of number of frames and compensation value appear on the LCD panel and viewfinder. For example, to shoot three frames with 0.7 degree compensation, set 3F-0.7.

Indication changes:

- 1F-00 (just after the BKT button is pressed)
- 3F-0.3
- 3F-0.7
- 3F-1.0
- 5F-0.3
- 5F-0.7
- 5F-1.0



4. Remove your finger from BKT button. On the LCD panel, the number of frames you set for auto exposure bracketing appears instead of normal frame counter and blinking **BKT** and **☀** marks remain to show auto exposure bracketing is set. Inside the viewfinder, **☀** symbol blinks. Now, exposure is compensated as you set in step 3. (Depending on compensation value you set, LCD panel and viewfinder may show exposure indication different from that shown before step 3.)

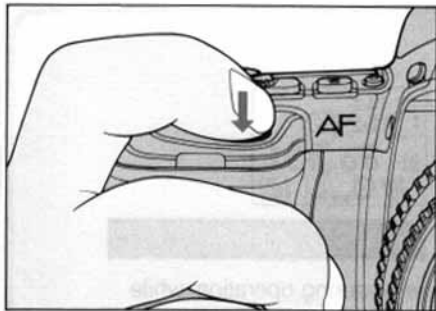

- 5.** Depress shutter release button to release shutter and start auto exposure bracketing operation. Number of frames for auto exposure bracketing decreases each time shot is taken.

For example, if you have set number of frames and compensation value as 3F-0.7, three shots — the first with  $-0.7$  underexposed, the second without compensation and the third with  $+0.7$  overexposed — will be taken.

**With film advance mode set at S:**

Camera takes three or five shots as set — one shot each time you depress shutter release button.

**With film advance mode set at CL or CH:**

Depressing shutter release button and holding it in triggers three or five shots as set. If you remove your finger from shutter release button before the set number of shots is taken, the operation stops. To take the remaining shots, depress and hold shutter release button again.

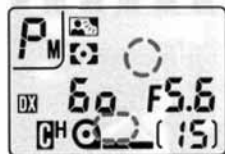

6. When all frames set are taken, **BKT** and **AE-L/AF-L** marks disappear showing auto exposure bracketing operation completed and automatically cancelled.

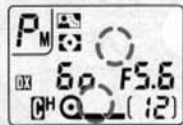
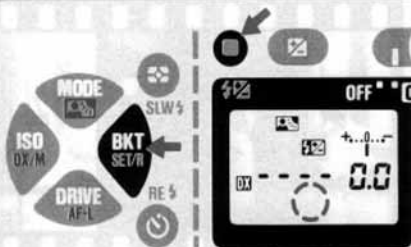



- To cancel auto exposure bracketing before or during operation, while pressing shift button, push BKT button. **BKT** and **AE-L/AF-L** marks disappear.
- If you set auto exposure bracketing with self-timer function, auto exposure bracketing is automatically canceled and normal self-timer operation will be performed.
- Auto exposure bracketing in flash photography compensates amount of flash output regardless of camera's exposure mode.
- If film reaches end of roll during shooting, auto exposure bracketing automatically stops. After loading a new film roll, push shutter release button to resume operation.
- If auto exposure bracketing is performed with another exposure compensation on camera or Speedlight, any compensation value can be added.

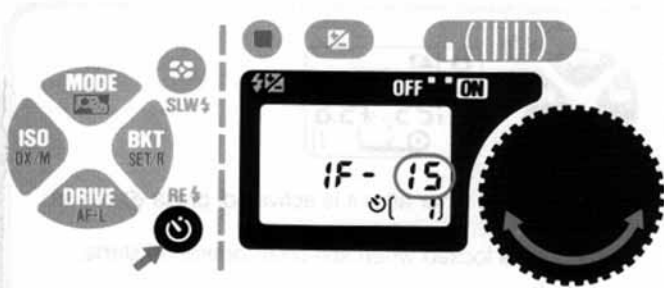

# SELF-TIMER OPERATION

## ONE-SHOT SELF-TIMER



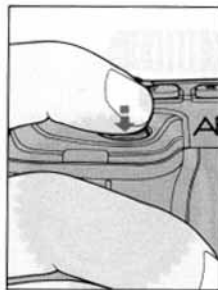

1. While pressing  button, rotate command dial until desired timer duration appears on the LCD panel. Timer duration can be selected between 2 to 30 seconds in one-second increments.
  - **2F-10** for two-shot self-timer appears next to **1F-30**. For two-shot self-timer operation, see next page.

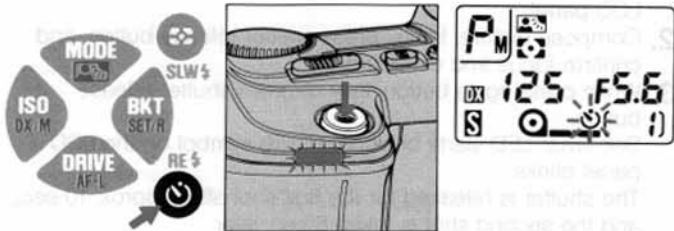

2. Compose picture, lightly press shutter release button, and confirm focus and exposure.



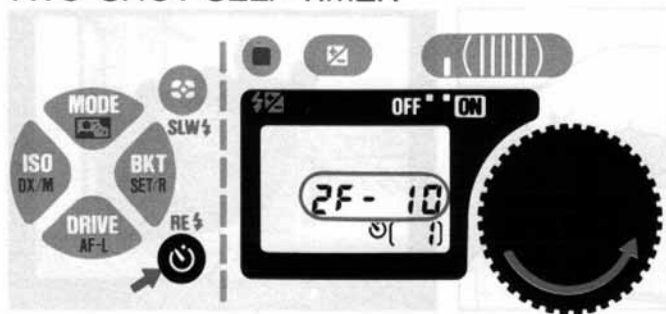

3. While pressing  button, fully depress shutter release button. Self-timer LED starts blinking and  symbol on the LCD panel blinks. For the final two seconds, the blinking LED speeds up, telling you to get ready.

## TWO-SHOT SELF-TIMER



It is possible to take two consecutive self-timer pictures.

1. While pressing self-timer  button, rotate command dial counterclockwise until 2F-10 (next to 1F-30) appears on the LCD panel.
2. Compose picture, lightly press shutter release button, and confirm focus and exposure.
3. While pressing  button, fully depress shutter release button.

Self-timer LED starts blinking and  symbol on the LCD panel blinks.

The shutter is released for the first shot after approx. 10 sec., and the second shot is taken 5 sec. later.

Two seconds before each shot, the blinking LED speeds up, telling you to get ready.



- To cancel self timer after it is activated, press  button again.
- Exposure is locked when self-timer operation starts.

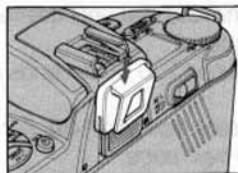

- When using any auto exposure mode, use eyepiece cover DK-5 (provided) before setting self-timer to prevent stray light from entering the viewfinder and affecting exposure.
- Regardless of film advance mode setting, continuous-frame shooting is not performed (except for two-shot self-timer operation).
- Bulb setting cannot be used for self-timer operation.

# BUILT-IN TTL FLASH

The built-in TTL flash provides the following functions:

## **Automatic Balanced Fill-Flash**

Performs fill-flash with an exposure automatically balanced for both subject and background.

## **Manual Flash Output Level Adjustment**

Lets you compensate exposure on subject by increasing or decreasing amount of flash output.

## **Slow Sync – Front-Curtain Slow Sync**

Enables you to use slower shutter speed for expanded exposure control of background brightness levels.

## **Rear-Curtain Sync – Rear-Curtain Slow Sync**

Lets you synchronize the flash to the instant before the rear curtain begins to close for slow sync, resulting in natural light flows.

**For Manual Flash Output Level Adjustment:** See pages 35 to 37 in "FLASH PHOTOGRAPHY".

**For Front-Curtain Slow Sync:** See pages 39 to 40 in "FLASH PHOTOGRAPHY."

**For Rear-Curtain Slow Sync:** See pages 41 to 43 in "FLASH PHOTOGRAPHY."

## USING BUILT-IN TTL FLASH

- Do not touch the flash when firing it: it may be hot due to normal operation.
- Never fire flash more than 20 times with a 5 sec. or shorter interval. Continuous firing over 20 times may deteriorate flash performance. After each major flash shooting, let the flash rest at least 10 minutes before firing again.
- When the built-in TTL flash is up, an accessory Speedlight will not fire. To make Speedlight work, store built-in TTL flash in down position.

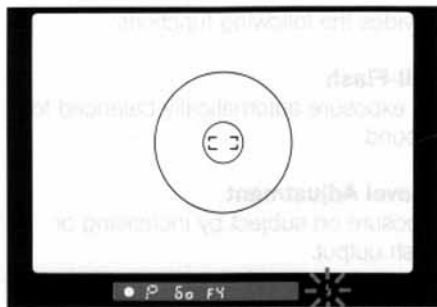

If the subject brightness is insufficient in auto exposure mode, viewfinder ready-light blinks, alerting you to use built-in TTL flash or accessory Nikon Speedlight.

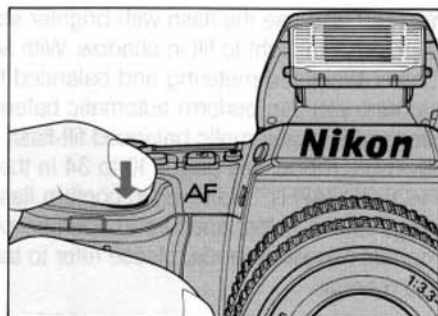
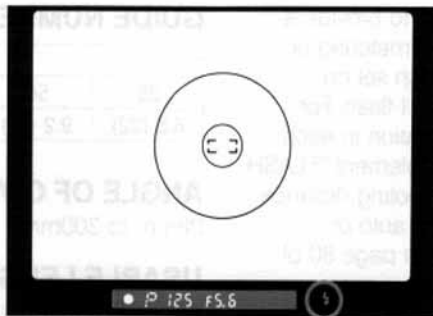
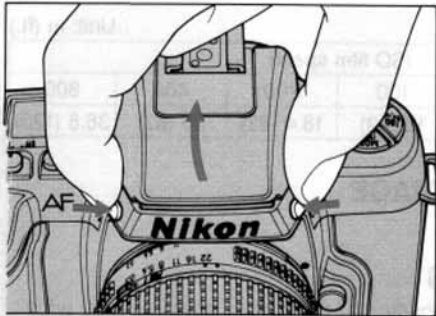

**To use built-in TTL flash:**

- 1.** Press both flash lock-release buttons. The built-in TTL flash will pop up and automatically turns on.
- 2.** Wait a few seconds for ready-light to come on.
- 3.** Fully depress shutter release button to take a shot with a flash.

You can also use the flash with brighter scenes to provide a supplemental light to fill in shadow. With Matrix metering or Center-Weighted metering and balanced fill-flash set on camera, you can perform automatic balanced fill-flash. For procedure of automatic balanced fill-flash operation in each exposure mode, see pages 10 to 34 in the supplement "FLASH PHOTOGRAPHY." However, to confirm flash shooting distance range and to select aperture in aperture-priority auto or manual exposure mode, please refer to table on page 80 of this manual.

## BUILT-IN TTL FLASH SPECIFICATIONS

### GUIDE NUMBER

Unit: m (ft.)

ISO film speed					
25	50	100	200	400	800
6.5 (22)	9.2 (31)	13 (43)	18.4 (62)	26 (87)	36.8 (123)

### ANGLE OF COVERAGE

28mm to 300mm

### USABLE LENSES

- Note that automatic balanced fill-flash is possible only with lenses having CPU contacts such as AF Nikkor and AI-P lenses.
- Do not use a lens hood; it could cause slight vignetting.

### Usable non-zoom lenses

- AF Nikkor lenses except AF Nikkor 300mm f/2.8
- AI-S Nikkor lenses except 200mm f/2, 300mm f/2 and 300mm f/2.8
- AI and AI-modified Nikkor lenses except 200mm f/2 and 300mm f/2.8

## Usable zoom lenses

● Zoom lenses cannot be used for macro focusing.

- AF 24-50mm f/3.3-f/4.5 <sup>[1]</sup>
- AF 28-85mm f/3.5-f/4.5 <sup>[2]</sup>
- AF 35-70mm f/2.8 <sup>[3]</sup>
- AF 35-70mm f/3.3-f/4.5
- AF 35-105mm f/3.5-f/4.5
- AF 35-135mm f/3.5-f/4.5 <sup>[4]</sup>
- AF 70-210mm f/4
- AF 70-210mm f/4-f/5.6
- AF 75-300mm f/4.5-f/5.6
- AF 80-200mm f/2.8 <sup>[5]</sup>
- 28-45mm f/4-f/4.5 <sup>[6]</sup>
- 28-50mm f/3.5
- 28-85mm f/3.5-f/4.5 <sup>[2]</sup>
- 35-70mm f/3.5 <sup>[3]</sup>
- 35-70mm f/3.3-f/4.5
- 35-105mm f/3.5-f/4.5
- 35-135mm f/3.5-f/4.5 <sup>[4]</sup>
- 35-200mm f/3.5-f/4.5 <sup>[3]</sup>
- 36-72mm f/3.5 <sup>[7]</sup>
- 43-86mm f/3.5
- 50-135mm f/3.5 <sup>[8]</sup>
- 70-210mm f/4
- 75-150mm f/3.5
- 10-200mm f/4
- 10-200mm f/4.5
- 00-300mm f/5.6

- <sup>[1]</sup> Cannot be used at a focal length shorter than 28mm, or when shooting a subject within 1m at 28mm focal length
- <sup>[2]</sup> Cannot be used at a focal length shorter than 35mm, or when shooting a subject within 2m at 35mm focal length
- <sup>[3]</sup> Cannot be used at a focal length shorter than 50mm
- <sup>[4]</sup> Cannot be used when shooting a subject within 2m at 35mm focal length
- <sup>[5]</sup> Cannot be used when shooting a subject within 2m at 80mm focal length
- <sup>[6]</sup> Cannot be used at a focal length shorter than 35mm or when shooting a subject within 1.5m
- <sup>[7]</sup> Cannot be used when shooting a subject within 1.5m at 36mm~50mm focal length
- <sup>[8]</sup> Cannot be used when shooting a subject within 1m at 50mm~70mm focal length

ISO film speed	Shutter-priority auto exposure mode					
	800	400	200	100	50	25
With f/1.4 lens	1/4	1/32	1/32	1/32	1/32	1/5
With f/1.8 lens	1/4	1/32	1/32	1/32	1/32	1/3
With f/2.8 lens	1/4	1/4	1/4	1/4	1/4	1/2

## FLASH SHOOTING DISTANCE RANGE:

Unit: m (ft.)

	ISO film speed						Flash shooting distance range
	25	50	100	200	400	800	
Aperture	—	—	—	—	2	2.8	3.2~13 (10.6~42.9)
	—	—	—	2	2.8	4	2.3~9.2 (7.6~30.4)
	—	1.4	2	2.8	4	5.6	1.6~6.5 (5.3~21.5)
	1.4	2	2.8	4	5.6	8	1.1~4.6 (3.6~15.2)
	2	2.8	4	5.6	8	11	0.8~3.3 (2.6~10.9)
	2.8	4	5.6	8	11	16	0.6~2.3 (2.0~7.6)
	4	5.6	8	11	16	22	0.6~1.6 (2.0~5.3)
	5.6	8	11	16	22	—	0.6~1.2 (2.0~4.0)

Flash shooting distance range depends on aperture. In programmed auto or shutter priority auto exposure mode, controlled aperture varies according to lens' maximum aperture and film speed in use. For reference, flash shooting distance ranges with AF Zoom-Nikkor 35-70mm f/3.3-f/4.5 lens, in programmed or shutter-priority auto, are shown on page 20.

## CONTROLLED MAX. APERTURE IN PROGRAMMED AND SHUTTER-PRIORITY AUTO EXPOSURE MODE:

ISO film speed	25	50	100	200	400	800
Lens in use						
With f/1.4 lens	f/2	f/2.38	f/2.8	f/3.36	f/4	f/4.76
With f/3.3 lens	f/3.3	f/3.3	f/3.3	f/3.36	f/4	f/4.76
With f/4.5 lens	f/4.5	f/4.5	f/4.5	f/4.5	f/4.5	f/4.76

The maximum shooting distance can be estimated by guide number:

Guide number = Maximum shooting distance  
full aperture

i.e., if f/2 lens is used at ISO 100:

$$\frac{13}{2} = 6.5\text{m or } \frac{43}{2} = 21.5\text{ ft.}$$



Metering system			Exposure mode				Focusing	
Spot Metering	Center-Weighted Metering	Matrix Metering	Matrix	Aperture Priority Auto	Shutter Priority Auto	Pro-grammed Auto	Manual with range finder	Autofocus
○	○	○	○	○	○	○	○	○
○	○	○	○	○	○	○	△	×
○	○	○	○	○	×	×	△	×
○	○	○	○	×	×	×	○	×
○	○	○	○	×	×	×	×	×
○	○	○	○	×	×	×	×	×
○	○	○	○	×	×	×	×	×
○	○	○	△	△	△	×	△	×
○	○	○	○	○	×	×	△	×

# ACCESSORIES

○ Compatible  
 △ With maximum effective aperture faster than 1/250 sec.  
 × Incompatible  
 △ With maximum effective aperture faster than 1/250 sec. but shutter speed is 1/500 sec. or slower.  
 △ Set camera to attach to AF Nikkor lens. The ring may damage CPU contacts. Use the AF Nikkor lens with the AE lock-throw switch of the camera.  
 △ Set camera to attach to AF Nikkor lens. The ring may damage CPU contacts. Use the AF Nikkor lens with the AE lock-throw switch of the camera.  
 △ Set camera to attach to AF Nikkor lens. The ring may damage CPU contacts. Use the AF Nikkor lens with the AE lock-throw switch of the camera.

- △ Set camera to attach to AF Nikkor lens. The ring may damage CPU contacts. Use the AF Nikkor lens with the AE lock-throw switch of the camera.
- △ Set camera to attach to AF Nikkor lens. The ring may damage CPU contacts. Use the AF Nikkor lens with the AE lock-throw switch of the camera.
- △ Set camera to attach to AF Nikkor lens. The ring may damage CPU contacts. Use the AF Nikkor lens with the AE lock-throw switch of the camera.
- △ Set camera to attach to AF Nikkor lens. The ring may damage CPU contacts. Use the AF Nikkor lens with the AE lock-throw switch of the camera.

# LENS COMPATIBILITY

## LENS COMPATIBILITY CHART

	Focusing		Exposure mode				Metering system		
	Autofocus	Manual with electronic range finder	Programmed Auto	Shutter-Priority Auto	Aperture-Priority Auto	Manual	Matrix Metering	Center-Weighted Metering	Spot Metering
AF Nikkor lenses (except AF Nikkor lenses for F3AF)	○	○	○	○	○	○	○	○	○
AI-P type Nikkor ED 500mm f/4 IF	×	▲ <sup>1</sup>	○	○	○	○	○	○	○
AI- or AI-S-type Nikkor lenses (including AI-modified Nikkor lenses)	×	▲ <sup>1</sup>	×	×	○	○	×	○	○
Medical-Nikkor 120mm f/4 IF	×	○	×	×	×	○ <sup>3</sup>	×	○	○
Reflex Nikkor lenses	×	×	×	×	○	○	×	○	○
PC-Nikkor lenses	×	×	×	×	○ <sup>4</sup>	○ <sup>5</sup>	×	○	○
AI- or AI-S-type Teleconverters	×	▲ <sup>2</sup>	×	×	○	○	×	○	○
Bellows Focusing Attachment PB-6	×	▲ <sup>2</sup>	×	×	▲ <sup>6</sup>	▲ <sup>6</sup>	×	○	○
K Ring Set (K1, K3, K4, and K5)*	×	▲ <sup>2</sup>	×	×	▲ <sup>7</sup>	▲ <sup>7</sup>	×	○	○
Auto Extension Rings (PK-11, 11A, 12, 13 and PN-11)**	×	▲ <sup>2</sup>	×	×	○	○	×	○	○

\* K1 ring cannot be attached to AF Nikkor lenses. The ring may damage CPU contacts. Use PK-11A or BR-6 instead.

\*\* PK-1, PK-2, PK-3 and PN-1 rings cannot be attached to the N6006. PK-11 ring cannot be attached to AF Nikkor lenses.

Those rings may damage CPU contacts. Use PK-11A for AF Nikkor lenses instead of PK-11.

○ Compatible

×

▲<sup>1</sup> With maximum aperture faster than f/5.6.

▲<sup>2</sup> With maximum effective aperture faster than f/5.6.

▲<sup>3</sup> Set shutter speed to 1/60 sec. or slower.

▲<sup>4</sup> Set preset ring, then use AE-lock lever before shifting.

▲<sup>5</sup> Set preset ring, then determine exposure before shifting.

▲<sup>6</sup> Shutter should be released after exposure is measured by stopping down PB-6.

▲<sup>7</sup> Stop-down exposure measurement will be performed.

● **The following Nikkor lenses cannot be attached to the N6006. (Camera body or lens may be damaged).**

- Non-AI lenses
- Fisheye 6mm f/5.6
- Fisheye OP 10mm f/5.6
- 200-600mm f/9.5 (No. 280001 to 301922)
- ED 180-600mm f/8 (No. 174041 to 174180)
- ED 360-1200mm f/11 (No. 174031 to 174127)
- 400mm f/5.6 and 600mm f/5.6 with Focusing Unit AU-1
- PC 28mm f/4 (No. 180900 or smaller)
- PC 35mm f/2.8 (No. 851001 to 906200)
- Reflex 1000mm f/11 (No. 142361 to 143000)
- Reflex 2000mm f/11 (No. 200111 to 200310)

● **The following teleconverter/lenses cannot be used with the N6006. (Correct exposure may not be obtained using these accessories).**

- AF Teleconverter TC-16/TC-16A
- AF Nikkor 80mm f/2.8
- AF Nikkor 200mm f/3.5 IF

# ACCESSORIES

## OPTIONAL SPEEDLIGHTS

### Nikon Speedlights SB-24/SB-23/SB-22/SB-20

With these Speedlights, the N6006 provides automatic balanced fill-flash. You can brighten shadows and balance subject and background illumination levels without complex calculations. In addition, manual flash output level adjustment, front-curtain/rear-curtain slow sync are also possible. In addition, AF illuminator of these Speedlights enables auto-focus operation in dim light.



SB-24



SB-23



SB-22



SB-20

## CLOSE-UP ACCESSORIES

For nature lovers, scientists, even general use, close-up photography provides the means to see the world in all its smaller details. The following are available for making your close-up photography even closer than the distance index engraved on your lens:

### Close-Up Attachment Lenses — No. 0, 1, 2, 3T, 4T, 5T and 6T

These convenient, easy-to-use close-up attachment lenses screw directly into the front thread of the lens and magnify the image.

Numbers 0, 1 and 2 are recommended for lenses with a focal length up to 60mm. 3T and 4T work best with lenses from 85mm to 200mm; 5T and 6T with lenses from 70mm to 210mm. Numbers 5T and 6T have a front attachment size of 62mm while the rest are designed for 52mm.

For close-up attachment lenses, the higher the lens number, the closer you can focus. For the prime lens, the longer the focal length, the greater the reproduction ratio you can obtain.

### Auto Extension Rings

Compact and lightweight, Nikon Auto Extension Rings offer a wide range of reproduction ratios. Models include the PK-11A, PK-12, PK-13 and PN-11. Because information on the lens aperture is relayed via the PK ring to the camera, the exposure mode to use is Aperture-Priority auto or Manual.

#### Caution:

- PK-11, BR-4, and K1 rings cannot be used with AF-Nikkor lenses. Use PK-11A and BR-6 instead.
- K2 ring and non-AI rings (such as PK-1, PK-2, PK-3 and PN-1) cannot be used with N6006.

- PK rings do not use lens' electronic contacts. All functions related to those contacts are inoperable when using these rings.



Close-Up Attachment Lenses



Auto Extension Rings

## Nikon Bellows Attachment PB-6

Mounts between the N6006 and lens for close-up and macro photography. You can vary lens extension, producing reproduction ratios from 1:1.1 up to 4:1 with a 50mm lens mounted normally. The lens can also be mounted in reverse to maintain aberration correction in the extreme close-up range.

The PB-6 has a stop-down lever so you can use stop-down metering. Usable exposure modes are Aperture-Priority auto and Manual.

- When attaching the PB-6 to the N6006, set PB-6 in vertical position.
- Use of Double Cable Release AR-7 is recommended when using PB-6 with the N6006.
- PB-6 does not use the lens' electronic contacts. All functions related to those contacts are inoperable when using the PB-6.



PB-6

## Micro-Nikkor Lenses – AF Micro-Nikkor 60mm f/2.8, AF Micro-Nikkor 105mm f/2.8, Micro-Nikkor 55mm f/2.8, Micro-Nikkor 105mm f/2.8 and Micro-Nikkor 200mm f/4 IF

These specially designed lenses offer continuous focusing from infinity down to 1:1 (life size) with AF Micro-Nikkor lenses or down to 1/2x lifesize with other Micro-Nikkor lenses. The closest focusing distances are:

AF Micro-Nikkor 60mm f/2.8	0.219m (0.72 ft.)
AF Micro-Nikkor 105mm f/2.8	0.314m (1.0 ft.)
Micro-Nikkor 55mm f/2.8	0.25m (0.83 ft.)
Micro-Nikkor 105mm f/2.8	0.41m (1.34 ft.)
Micro-Nikkor 200mm f/4 IF	0.71m (2.84 ft.)



Micro-Nikkor Lenses

### Note on Close-Up Photography

- In close-up photography, depth of field is generally shallow. Thus, you must stop lens aperture down as much as possible to get the greatest area of sharp focus.
- Image magnification is so high that even the slightest movement during shooting will cause a blurred image. To avoid this, use tripod with a cable release to activate the shutter.

## VIEWING ACCESSORIES

### Eyepiece correction lenses

To correct both near- and farsightedness, nine lenses are available from  $-5$  to  $+3$  diopter values. These values are derived from the dioptry of both the finder and the correction lens.

### Eyepiece Magnifier DG-2

Provides 2x magnification of the central portion of the finder image with Eyepiece Adapter. Eyesight adjustment provided. Useful for critical focusing in close-up photography.

### Nikon Eyepiece Adapter

Lets you attach the DG-2 to the eyepiece.



Eyepiece Correction Lenses



DG-2



Eyepiece Adapter

# OTHER ACCESSORIES

## Lens Hoods

These are recommended to prevent stray light from entering the lens and causing ghost images and flare. Four types are available to match various Nikon/Nikkor lenses: snap-on, screw-in, telescopic (already incorporated into the lens), and slip-on.



Lens Hood

## Filters

Nikon offers a wide selection of filters of various sizes and types to meet the needs of color and black-and-white photography. These filters work best with Nikon/Nikkor lenses. They are also useful for protecting the front of the lens, and their optical quality compliments any Nikkor optic.



Filters



# Nikon Filters

Type		Filter designation	Filter factor		Screw-in type (mm)								Drop-in type (Series IX)	Bayonet-mount type				
			Daylight	Tungsten light	39	52	62	72	77	82	95	122			160			
For Both Color and Black-and-White Film	Skylight	L1BC	1		●	●	●	●								●		
	Ultraviolet	L37C	1		●	●	●	●	●	●	●	●						
	Ultraviolet	L39	1			●										●		
For Black-and-White Film	Yellow	Light	Y44	1.5 (1/2)	1											●		
		Medium	Y48	1.7 (2/3)	1.2 (1/3)	●	●	●	●		●	●				●	●	
		Deep	Y52	2 (1)	1.4 (1/2)	●	●									●		
	Orange	O56	3.5 (1-5/6)	2 (1)	●	●	●	●							●	●		
	Red	R60	8 (3)	5 (2-1/3)	●	●	●	●			●	●			●	●		
	Green	Light	X0	2 (1)	1.7 (2/3)		●											
		Deep	X1	5 (2-1/3)	3.5 (1-5/6)		●											
For Both Color and Black-and-White Film	Soft filters		No. 1	1		●	●	●										
			No. 2	1		●	●	●										
	Circular Polarizing		C-PL	2~4 (1~2)		●	●											
	Neutral Density		ND2X	2 (1)		●												
			ND4X	4 (2)		●	●		●									
			ND8X	8 (3)		●	●											
ND400X			400 (8.6)			●												
For Color Film	Amber	Light	A2	1.2 (1/3)		●	●	●	●								●	
		Deep	A12	2 (1)		●	●	●										
	Blue	Light	B2	1.2 (1/3)		●	●	●	●									●
		Medium	B8	1.6 (2/3)		●	●											
		Deep	B12	2.2 (1-1/6)		●	●	●										

( ) indicates increase in f/stop.

- For lens protection the L37C is recommended.
- Do not use more than one filter at a time, or vignetting may occur. Be especially careful when using filters together with short focal-length lenses.
- When shooting a backlit subject or if there is a bright source in the frame, a ghost image is likely to result when using a filter. In this case, remove filter.

- When using a filter requiring exposure compensation such as the O56, R60, ND filter, etc., Matrix Meter performance is altered by the filter's affect on contrast; to get correct exposure, use Center-Weighted metering.
- When using R60 under tungsten light, increase the exposure value by one f/stop more than that indicated by the exposure meter.

## Semi-Soft Camera Cases

Two types are available: the CF-45 for use with AF Zoom-Nikkor 35-70mm f/3.3-f/4.5 or smaller lens, and the CF-46 for AF Zoom-Nikkor 35-135mm f/3.5-f/4.5 or smaller lens.

## Neckstraps

Webbed nylon neckstraps AN-4Y (yellow), AN-4B (black), and wider webbed nylon neckstraps AN-6Y (yellow), AN-6W (brown) are available.



AN-4Y



AN-6Y

- When using a filter requiring exposure compensation such as the C56, F60, ND filter, etc., Meter Matrix performance is altered by the filter's effect on contrast. To get correct exposure, use Center-Weighted metering.
- When using F60 under tungsten light, increase the exposure value by one stop more than that indicated by the exposure meter.

A protection filter (L37C) is recommended use more than one filter at a time or视距 may be especially careful when using filters together with color-length lenses.

hooking a backlit subject or if there is a bright source, a ghost image is likely to result when using a filter. In this case, remove filter.



1. Blow lens with blower or blower screen. Remove dust with a blower brush.



2. Blow lens with blower brush.



3. Never touch DX contacts. Keep clean with blower brush.

## MISCELLANEOUS



7. Clean viewfinder eyepiece and LCD panel with a soft, clean cloth. Do not use liquid cleaners.

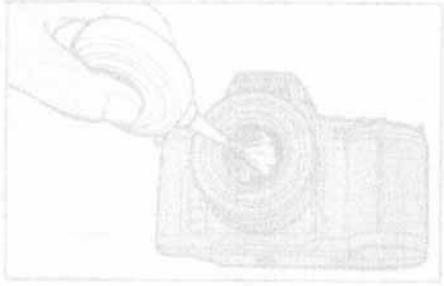

8. Clean glass surfaces such as the lens with a blower brush, avoid using lens tissue as much as possible. To

from center to periphery being careful not to leave marks.  
 Caution:  
 Be very careful when using a spray can-type blower. If the can comes into contact with the camera or lens, it could seriously damage the equipment. The can should be placed on a table and the lens should be cleaned through the air filter. Use about 30cm (12") at an angle from the air nozzle. Never invert spray or move the can when using it.

# CAMERA CARE TIPS

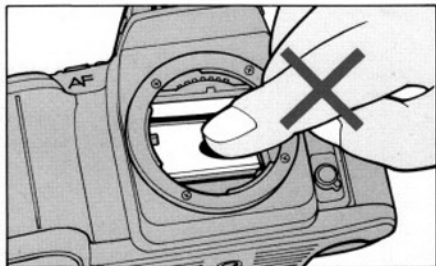

1. Never touch reflex mirror or focusing screen. Remove dust with a blower brush.

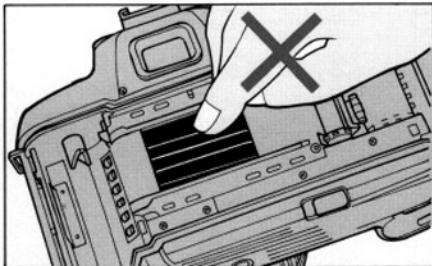

2. Never touch shutter curtains.

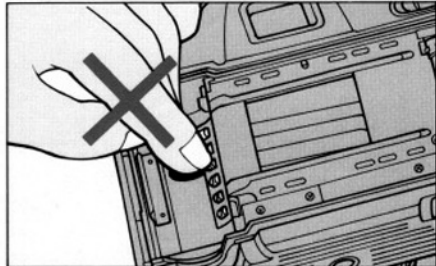

3. Never touch DX contacts. Keep clean with blower brush.

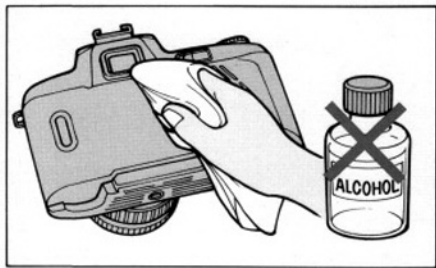

7. Clean viewfinder eyepiece and LCD panel with a soft, clean cloth. Do not use liquid cleaners.

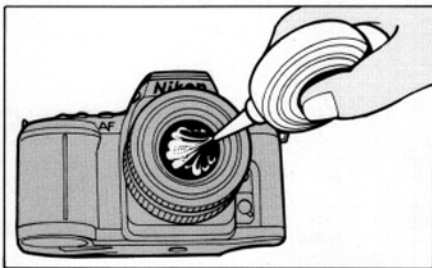

8. Clean glass surfaces such as the lens with a blower brush; avoid using lens tissue as much as possible. To remove dirt and smudges, use soft lens tissue slightly moistened with lens cleaner. Wipe in a spiral motion

from center to periphery being careful not to leave traces.

### Caution!

Be very careful when using a spray can-type blower. If the can comes into contact with the camera or lens, it could seriously damage the equipment. The can should be placed on a table and the lens should be passed through the air jet no closer than about 30cm (20 inches) from the air nozzle. *Never invert, shake or move the can when using it.*

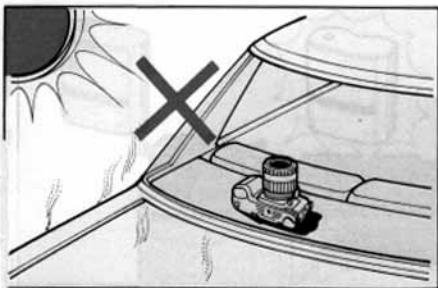

**4.** Do not leave camera in a hot place.



**5.** Keep camera away from water or moisture. When using camera near water, guard against splashes, especially salt water spray.



**6.** If camera malfunctions, take it immediately to an authorized Nikon dealer or service center.

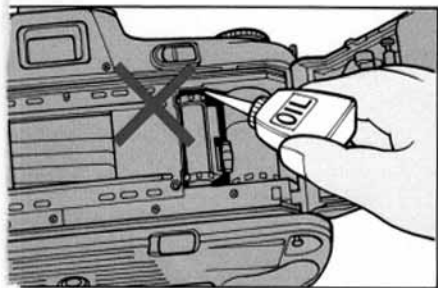

Do not lubricate the camera.



**10.** Store camera in a cool, dry place away from naphthalene or camphor (moth repellents). In a humid environment, store camera inside a vinyl bag with a desiccant to keep out dust, moisture and salt.



Note, however, that storing the leather case in a vinyl bag may cause leather to deteriorate.

# NOTES ON BATTERIES

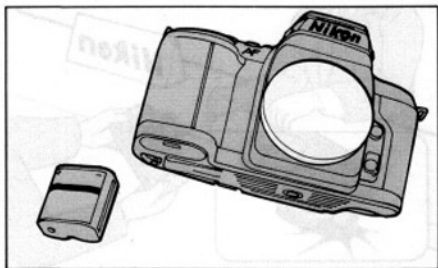

- 1.** When not using camera for a long period, remove battery.



- 2.** Battery power drains off in extremely low temperatures — make sure battery is new and keep camera body wrapped in something warm.

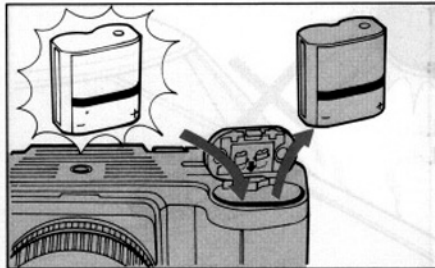

- 3.** When replacing battery, be sure to use fresh battery.

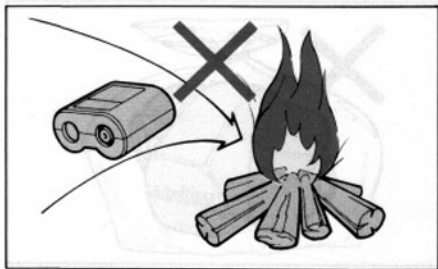

- 4.** Do not throw used batteries into a fire.

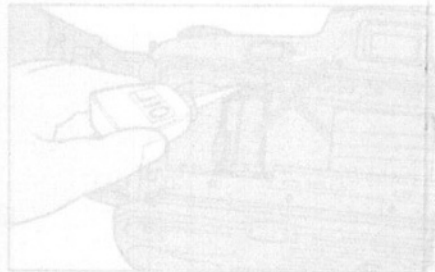
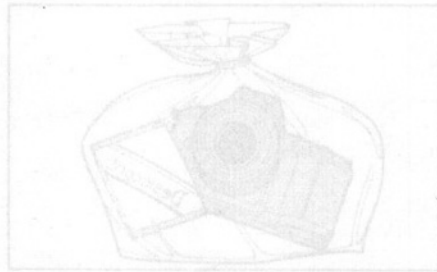

# SPECIFICATIONS

<b>Type of camera</b>	Integral-motor autofocus 35mm single-lens reflex	<b>Exposure metering</b>	Three types of exposure metering systems — Matrix metering, Center-Weighted metering and Spot metering
<b>Picture format</b>	24mm x 36mm (standard 35mm film format)	<b>Metering range</b>	EV 0 to EV 19 (at ISO 100 with f/1.4 lens) for Matrix and Center-Weighted metering; EV 4 to EV 19 (at ISO 100) for Spot metering
<b>Lens mount</b>	Nikon F mount	<b>Exposure meter</b>	Activated by lightly pressing shutter release button; stays on for approx. 8 sec. after lifting finger from button
<b>Lens</b>	Nikkor lenses having CPU contacts, AI-S-type Nikkor lenses*, AI-Nikkor lenses* and AI-modified Nikkor lenses* <i>*With limitation. See chart on page 82.</i>	<b>Exposure modes</b>	Programmed auto (P <sub>M</sub> , P), Shutter-Priority auto (S), Aperture-Priority auto (A) and Manual (M) modes
<b>Focus modes</b>	Autofocus, and manual focus with electronic rangefinder	<b>Programmed auto exposure control</b>	Both shutter speed and aperture are set automatically; Flexible Program in one EV step increments possible
<b>Autofocus mode</b>	Focus-Priority Single autofocus and Focus-Priority Continuous autofocus	<b>Shutter-priority auto exposure control</b>	Aperture automatically selected to match manually set shutter speed
<b>Autofocus detection system</b>	TTL phase detection system using Nikon advanced AM200 autofocus module	<b>Aperture-priority auto exposure control</b>	Shutter speed automatically selected to match manually selected aperture
<b>Autofocus detection range</b>	Approx. EV minus 1 to EV 19 (at ISO 100)	<b>Manual exposure control</b>	Both aperture and shutter speed are set manually
<b>Autofocus lock</b>	Possible once a stationary subject is in focus in Focus-Priority Single autofocus; in Focus-Priority Continuous autofocus, focus can be locked by using AE-L/AF-L lever when AF-L function is set	<b>Exposure compensation</b>	Possible using exposure compensation button within $\pm 5EV$ range in 1/3EV steps
<b>Electronic Rangefinder</b>	Available in manual focus mode with AF Nikkor and other AI-type Nikkor lenses with a maximum aperture of f/5.6 or faster	<b>Auto exposure lock</b>	Available by sliding the AE lock lever while the meter is on

<b>Auto exposure bracketing</b>	3 or 5 frames can be taken of the same subject using a variety of exposures (with compensation degree of 0.3, 0.7 or 1 EV between each frame)	<b>Self-timer</b>	Electronically controlled; timer duration can be selected between 2 to 30 sec. in one sec. increments; blinking LED indicates self-timer operation; two-shot self-timer is possible; can cancel at any time
<b>Shutter</b>	Electromagnetically controlled vertical-travel focal-plane shutter	<b>Reflex mirror</b>	Automatic, instant-return type
<b>Shutter release</b>	Electromagnetic type	<b>Flash sync control</b>	Normal sync, slow sync and rear-curtain sync provided
<b>Shutter speeds</b>	Lithium niobate oscillator-controlled speeds from 1/2000 to 30 sec.; stepless in Programmed auto and Aperture-Priority auto exposure modes; one EV steps in Shutter-Priority auto and Manual exposure modes; Electronically controlled long exposure at B setting	<b>Built-in TTL flash</b>	Guide number: 13 (at ISO 100, 20°C and meters); angle of coverage: 28mm lens or longer; TTL auto flash including automatic balanced Fill-Flash is possible
<b>Viewfinder</b>	Fixed eyelevel pentaprism high-eyepoint type; 0.75X magnification with 50mm lens at infinity; 92% frame coverage	<b>Flash synchronization</b>	In Programmed auto or Aperture-Priority auto shutter operates 1/125 to 1/60 sec. {or 1/(focal length) in use at lens focal length less than 60mm} in normal sync or 1/125 to 30 sec. in slow sync; in Shutter-Priority auto or Manual exposure mode, shutter fires at speed set, and when set from 1/250 to 1/2000 sec., shutter is automatically set to 1/125 sec.
<b>Eyepoint</b>	Approx. 18mm	<b>Automatic</b>	Possible with built-in TTL flash or Nikon dedicated Speedlights such as SB-24, SB-23, SB-22, SB-20, SB-18 and SB-16B
<b>Eyepiece cover</b>	Model DK-5 (provided) prevents stray light from entering viewfinder	<b>Balanced Fill-Flash</b>	
<b>Focusing screen</b>	Fixed Nikon advanced B-type BriteView screen with central focus brackets for autofocus operation		
<b>Film speed range</b>	ISO 25 to ISO 5000 for DX-coded film; ISO 6 to ISO 6400 for manual setting		
<b>Film speed setting</b>	Auto for DX-coded films and manual setting available		



**Manual flash light output compensation**  
**Flash ready-light**

Can be controlled from +1EV to -3EV in 1/3 step increments

Without flash: Blinks when using flash is recommended (with scene brightness darker than EV10 at ISO 100 or scene brightness of EV10 or higher at ISO 100 where the center portion is darker than other areas by more than 1EV)

With flash: Lights up when built-in TTL flash or Nikon dedicated Speedlight is ready to fire or blinks to warn of insufficient light for correct exposure  
Standard ISO-type hot-shoe contact; ready-light contact, TTL flash contact, monitor contact

**Accessory shoe**

**Film loading**

Film automatically advances to first frame when shutter release button is depressed once

**Film advance**

In S (Single-frame) shooting mode, film automatically advances one frame when shutter is released; in C<sub>H</sub> (Continuous High) or C<sub>L</sub> (Continuous Low) shooting mode, shots are taken as long as shutter release button is depressed; in C<sub>H</sub> mode, shooting speed is approx. 2.0fps, and in C<sub>L</sub>, approx. 1.2fps

**Frame counter**

Additive type; counts back while film is rewinding

**Number of 36-exposure film rolls per fresh battery\***

	at 20°C (68°F)	at -10°C (14°F)
Without flash	approx. 75	approx. 22
With 50% flash	approx. 16	approx. 3

\* For autofocus operation with AF Zoom-Nikkor 35-70mm f/3.3-f/4.5 lens covering the full range from infinity (∞) to the closest distance and back to infinity (∞) before each shot, at 1/125 sec. or faster shutter speed.

**Film rewind**

Automatically rewinds by sliding film rewind lever while pressing film rewind button; approx. 26 sec. per 36-exposure film roll or 19 sec. per 24-exposure film roll; stops automatically when film is rewound

**Camera back**  
**Power source**

Hinged back; unchangeable  
6V lithium battery pack (Duracell DL-223A/Panasonic CR-P2 or equivalent)

**Checking battery power**

Battery power is sufficient if shutter speed and aperture indications appear on the LCD panel and viewfinder by turning camera on or by lightly pressing shutter release button, and remain on for approx. 8 sec. after finger is removed from the button; battery power is insufficient if these indications turn off immediately after finger is removed from the button; if LCD blinks and shutter does not operate, batteries are exhausted or improperly loaded

**Dimensions (WxHxD)** 154.5 x 100 x 66.5mm or 6.1 x 4.0 x 2.6 in.

**Weight** Approx. 650g or 23.0 oz. (without battery pack)

*All specifications apply when using fresh lithium battery pack at normal temperature (20°C or 68°F). Specifications and design are subject to change without notice.*

Exhausted or improperly loaded  
shutter does not operate, battery  
from the button, LCD blink and  
off immediately after finger is removed  
is sufficient if these indicators turn  
moved from the button, battery power  
on for approx. 8 sec. after finger is re-  
ling shutter release button, and remain  
turning camera on or by lightly press-  
on the LCD panel and viewfinder by  
speed and aperture indicators appear  
Battery power is sufficient if shutter  
228/Panasonic CR-P2 (or equivalent)  
BY Nikon battery pack (ENELCP1)  
Hinged back and/or cassette  
When film is rewound  
and film roll stops automatically  
and film roll or 48 sec. for S4-expo-  
button, approx. 55 sec. for S8-expo-  
rewind lever while winding film toward  
Automatically rewound by setting film

**Checking battery power**

**Camera back Power source**

**Film rewind**

rewinding  
Additive type; counts back while film is  
1 Stop  
is approx. 2.0/pt. and in C<sub>1</sub> approx.  
pressed; in C<sub>1</sub> mode, shooting speed  
long as shutter release button is de-  
shooting mode, shots are taken as  
linear light or C<sub>1</sub> (Continuous low)  
when shutter is released; in C<sub>1</sub> (or-  
film automatically advances one frame  
in S (single-frame) shooting mode,  
depressed once  
time when shutter release button is  
Firm automatically advances to first  
monitor contact  
ready-light contact, TTL flash contact,  
Standard ISO-type hot-shoe contact;  
contact light for direct exposure  
ready to fire or blink to warn of inst-  
flash or Nikon dedicated Speedlight is  
With flash: lights up when bulb in TTL  
LEV

flash; blink when using flash  
is recommended with speedlight-  
ness table from EV10 to S2 100 x  
aperture brightness of EV10 or higher for  
ISO 100 where the center portion is  
table; then other areas by more than

Without flash: Blink when using flash  
is recommended with speedlight-  
ness table from EV10 to S2 100 x  
aperture brightness of EV10 or higher for  
ISO 100 where the center portion is  
table; then other areas by more than

Control controlled from +7EV to -3EV  
in 1/3 stop increments

the counter

advance

loading

ready shoe

ready-light  
compensation  
light  
ul flash light

## **AF illuminator**

When existing light is below a certain level and the camera is set for autofocus mode, the SB-24/SB-23/SB-22/SB-20's AF illuminator turns on automatically and provides enough subject contrast to enable for the N6006's autofocus system to function as though it were daytime.

## **Balanced fill-flash operation**

A method of flash photography which keeps flash brightness in balance with the ambient light. The N6006 provides automatic balanced fill-flash operation with Nikon-dedicated TTL controlled Speedlights.

## **Center-Weighted metering**

An SLR light meter, invented by Nikon, which concentrates its sensitivity on the center portion of the camera's viewing areas.

## **CPU**

Central Processing Unit. The electronic component which controls equipment functions.

AF Nikkor and AI-P-Nikkor lenses have a built-in CPU.

## **Depth of field**

The zone of acceptable sharpness in front of and behind the subject on which the lens is focused.

## **DX code**

Film information code printed on the film cartridge. The N6006, set at auto film speed setting mode, automatically senses the film speed (ISO 25 to 5000) of DX-coded film the instant it is loaded.

## **EV**

Exposure Value. A number representing the available combinations of shutter speed and aperture that give the same exposure effect when the scene brightness and ISO remain the same.

At ISO 100, the combination of a one-second shutter speed and an aperture of f/1.4 is defined as EV1.

The camera's meter may be used only within EV range of the exposure meter. For example, with the N6006, exposure metering range is from EV0-EV19 at ISO 100 with f/1.4 lens.

## **Exposure compensation**

Exposure compensation for available light is performed by changing shutter speed and/or aperture via auto exposure lock lever, exposure compensation button or auto exposure bracketing.

In flash photography with a Nikon dedicated TTL Speedlight, exposure compensation is also performed by varying the amount of flash light output.

Exposure compensation made on camera affects both foreground subject and background while varying flash output amount affects only foreground.

## **Exposure control**

Programmed auto: Camera controls both shutter speed and aperture for correct exposure.

Shutter-priority auto: User selects shutter speed and camera chooses aperture for correct exposure.

**Aperture-priority auto:** User selects aperture and camera chooses shutter speed for correct exposure.

**Manual:** User select both shutter speed and aperture with the meter's recommendations for correct exposure.

### **Fill-flash**

A method of flash photography which combines flash illumination and ambient light, but does not necessarily attempt to balance the two types of illumination.

### **Flash synchronization**

The flash is timed to fire coincident with the operation of the camera's shutter. There are two types of synchronization: Normal Sync which fires the flash at the start of the exposure, and Rear Sync which fires the flash at the end of the exposure.

### **f-number**

Number which indicates brightness of film plane image. Increasing/decreasing f-number is opening/stopping down lens aperture. The f-number series is equivalent to 1.4, 2, 2.8, 4, 5.6, 8, 11, 16, 22, 32, etc. Changing one step to the next larger number (i.e., from f/11 to f/16) decreases image brightness by 1/2; moving to nearest lower number doubles the brightness.

### **Guide number**

The number given to a flash bulb or electronic flash unit to indicate its power. A guide number may be quoted in meters or feet, and depends on the speed of the film being used. Guide numbers quoted assuming a relatively efficient reflector surrounds the flash source, e.g., an average-sized room.

### **ISO film speed**

The international standard for representing film sensitivity (speed with which it reacts to light). The higher the number, the greater the sensitivity, and vice versa. A film speed of ISO 200 is twice as fast as ISO 100, and half the speed of ISO 400 film.

### **LCD**

Liquid Crystal Display. For the N6006, used on the panel on top of camera body and inside viewfinder.

### **Manual flash**

Flash output is fixed in manual flash mode, while flash output power varies according to selected aperture in auto flash mode. Some Speedlights including SB-20 and SB-24 provide selectable manual output (full, 1/2, 1/4, 1/8, 1/16, etc.) and some provide full output only.

### **Matrix metering system**

An advanced camera light metering system using a multi-segment sensor and computer; available in Nikon SLR models F-601/N6006, F-601M/N6000, F4 and F-801/N8008. A basic version is used with the Nikon F401/N4004 and F401s/N4004s models. Matrix metering is an exclusive Nikon feature.

### **Non-TTL auto flash**

A sensor measures illumination without viewing through camera's lens.

## SLR

Single-Lens Reflex. A type of camera in which you look through the camera's lens as you view through the camera finder. Other camera functions, such as light metering and flash control, also operate through the camera's lens.

## Spot metering

Sensitivity is concentrated on the approx. 3.5mm-diameter circle in the center of the camera's viewing area. Effective when precise measurement of a special portion of the subject is required.





## TTL

Through-The-Lens. Most SLR cameras have built-in meters which measure light after it has passed through the lens, a feature that enables exposure readings to be taken from the actual image about to be recorded on film, whatever the lens' angle of view and regardless of whether a filter is used.

## TTL auto flash

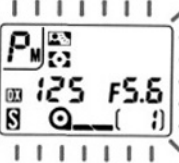
The camera's light sensor measures flash light, as reflected by the subject on the film and shuts off the flash when measurement indicates correct exposure. Because the sensor that controls the flash receives light through the lens, TTL auto flash can be used for bounce photography, fill-in flash, multiple flash photography, etc. An additional advantage of TTL auto flash is that you can use a wide range of aperture settings, while ensuring correct exposure.

# WARNING INDICATIONS

LCD panel/Viewfinder	Shutter	Cause and remedy
 <p>All indicators shown blink</p>	Locks	Battery power is insufficient. Replace with a fresh battery pack.
 <p>Err, ISO and DX marks blink</p>	Locks	Non-DX-coded film or film with an unacceptable DX code is loaded. Set manually to the correct setting.
 <p>Err and ISO blink</p>	Locks	Film is not correctly positioned. Reload film.
 <p>Err blinks during film advance</p>	Locks	Camera detects a malfunction. Slide power switch to OFF, and set to ON again, then fully depress the shutter release button and confirm that <b>Err</b> disappears.

## LCD panel/Viewfinder

## Shutter

## Cause and remedy

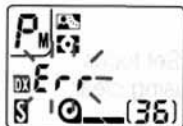

**Err** blinks when you press film rewind button to rewind film

Locks

Camera detects a malfunction. Remove your finger from the button, then try to rewind film again.



**Err** blinks when built-in TTL flash is up.

Locks

Battery power may be insufficient. Check battery power, and if necessary, replace battery with a new one.

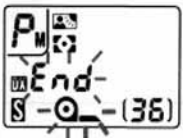

**End** and  blink

Locks

Film reaches end of roll. Rewind film.

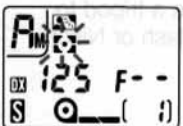

 blinks

Can be released

You set Matrix metering though a lens without CPU is attached. Metering system is automatically set to Center-Weighted metering.

## LCD panel/Viewfinder

## Shutter

## Cause and remedy



● blinks

Depends on focus mode selector. Locks at S/CF or can be released at M.

Autofocus is impossible with the subject. Set focus mode selector to M and focus manually using clear matte field.

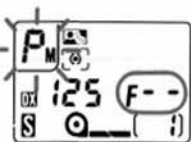

**P**, **P** or **S** blink and **F--** appears

Can be released

You set programmed auto or shutter-priority auto exposure mode though a lens without CPU is attached. Exposure mode is automatically set to aperture-priority auto.

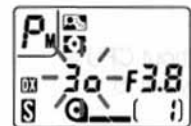

Shutter speed indicator blinks in programmed auto or aperture-priority auto exposure mode

Can be released

Automatically selected shutter speed is 1/(focal length) or slower and picture blur may occur. Use a tripod to avoid camera shake, or use built-in TTL flash or Nikon Speedlight.



## LCD panel/Viewfinder

## Shutter

## Cause and remedy'

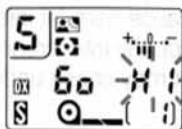
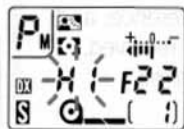

**HI** blinks in auto exposure mode

Can be released

Overexposure may occur.

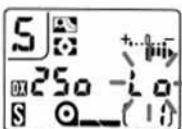
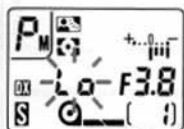

**Lo** blinks in auto exposure mode

Can be released

Underexposure may occur.



**FEE** blinks in programmed auto or shutter-priority auto exposure mode

Locks

Lens is not set to smallest aperture setting.  
Set lens to smallest aperture.



Ready-light blinks.

Can be released

Use built-in TTL flash.

In certain cases, due to static electricity or poorly loaded battery, the N6006's microcomputer may turn the camera off, even with fresh, properly installed battery. For the same reason, film may not advance properly. In each of these cases, to resume operation, simply turn the power OFF and turn ON again, or remove battery and install again.

Nikon cannot be held responsible for any malfunction resulting from the use of the camera other than as specified in this manual.

This device complies with Part 15 of the FCC Rules. Operation is subject to the following two conditions:  
(1) This device may not cause harmful interference, and  
(2) this device must accept any interference received, including interference that may cause undesired operation.

This equipment has been tested and found to comply with the limits for a Class B digital device in accordance with the specifications set forth in Part 15 of the FCC Rules. If this equipment does cause interference to radio or television reception which can be determined by turning the equipment on and off, use the equipment in another location and/or utilize an electrical outlet different from that used by the receiver.