

Nikon N55

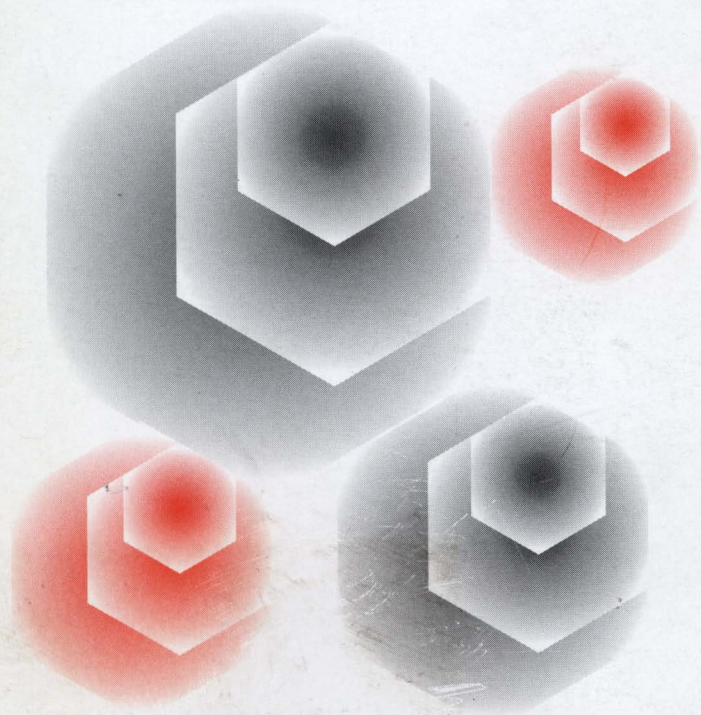

INSTRUCTION MANUAL

E

Introduction

- Thank you for purchasing the Nikon N55—a camera that is sure to make photography a bigger part of your life. Get to know your N55 camera, and be sure to read this manual thoroughly before using it. We recommend that you keep this manual handy.

Supplied accessories



Body cap (P. 19)

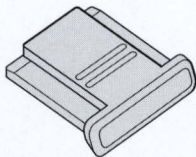

Accessory shoe cover

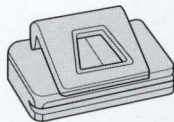

Eyepiece cap DK-5 (P. 73)

** Remove this cover when attaching an optional Speedlight to the accessory shoe.*

The N55 QD model is not offered in all markets.

Please inquire with the local Nikon distributor about the availability of the QD model in your area.

Take trial shots

Take trial shots before shooting at important occasions like weddings or graduations.

Have Nikon spot-check your camera regularly

Nikon recommends that you have your camera serviced by an authorized dealer or service center at least once every two years.

Using your camera correctly

The Nikon N55's performance has been optimized for use with Nikon brand accessories. Accessories made by other manufacturers may not meet Nikon's criteria for specifications, and nonconforming accessories could damage the N55's components. Nikon cannot guarantee the N55's performance when it is used with other than Nikon brand accessories.

Contents

BEFORE YOU BEGIN2-11

Introduction.....	2-3
Nomenclature.....	6-7
LCD Panel/Viewfinder Display	8-9
Available Exposure Modes	10-11

Start Shooting Immediately 12-13

PREPARATION.....15-24

1. Install Batteries and Check Battery Power.....	16-17
2. Mount Lens.....	18-19
3. Load Film	20-21
4. Set Date and Time (QD model only).....	22-23
About Shutter Release Button	24

BASIC OPERATION 125-33

1. Set Focus Mode to AF.....	26-27
2. Set Exposure Mode to 	28-29
3. Hold Camera and Focus.....	30-31
4. Release Shutter	32-33

About Metering Systems and Exposure34

BASIC OPERATION 2.....35-44

Shooting with Vari-Program.....	36-39
Using Built-In Speedlight.....	40-41
Self-Timer Operation.....	42-43
Imprinting Date/Time (QD model only).....	44

FOCUS OPERATION45-52

Focus Mode.....	46-47
Focus Area.....	48-49
AF-Assist Illuminator.....	50-51
Focus Lock.....	52

EXPOSURE MODE53-62

Auto-Multi Program	54-55
Shutter-Priority Auto Exposure Mode.....	56-57
Aperture-Priority Auto Exposure Mode	58-59
Manual Exposure Mode.....	60-61
Long Time Exposure	62

ADVANCED OPERATION63-70

Exposure Compensation	64-65
Auto Exposure Bracketing	66-68
Multiple Exposure	69-70

OTHER FUNCTIONS71-74

Film Rewind.....	72
Diopter Adjustment/Viewfinder Accessories.....	73
Available Mode Combinations	74

FLASH PHOTOGRAPHY 75-85

Built-In Speedlight/Ready-Light	76-77
Flash Sync Mode Features.....	78-79
Using Built-In Speedlight.....	80-85
Flash Shooting Distance Range.....	83
Available Flash Sync Mode Combinations	84
Usable Lenses with Built-In Speedlight.....	84-85

About Depth of Field	86
----------------------------	----

MISCELLANEOUS87-117

Lens Compatibility	88-90
Usable Optional Speedlights	91-97
Optional Accessories	98-99
Camera Care.....	100-101
Notes on Batteries	102
Troubleshooting	103-105
Glossary	106-109
Specifications	110-114
Index	116-117

Nomenclature

Focus mode selector (PP. 46-47)

Lens release button
(P. 19)

Auto Exposure
Bracketing (P. 66)/
Multiple Exposure
(P. 69)/Film rewind
button (P. 72)

Flash lock-release
(P. 80)/Flash sync mode
button (P. 78)

Camera strap
eyelet

Exposure mode dial
(P. 10)

Accessory shoe (P. 91)

LCD panel (P. 8)

Focus area button (P. 48)

Built-in Speedlight (P. 40/76)

Self-timer (P. 42)/
AF-Assist Illuminator (P. 50)/
Red-Eye Reduction lamp (P. 79)

Power switch (P. 16)

Shutter release
button (P. 17/24)

Camera strap
eyelet

Self-timer button
(P. 42)

Aperture (P. 61)/Exposure
Compensation button (P. 64)/
Film rewind button (P. 72)

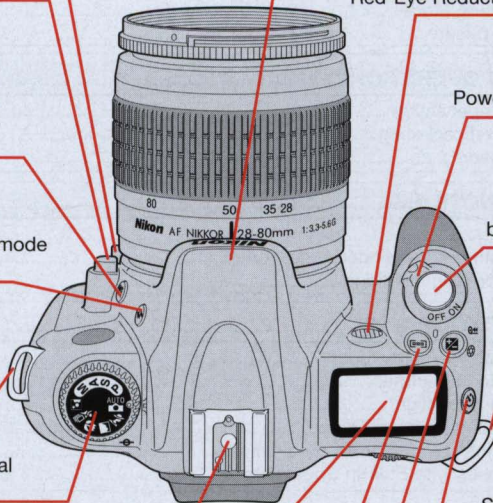

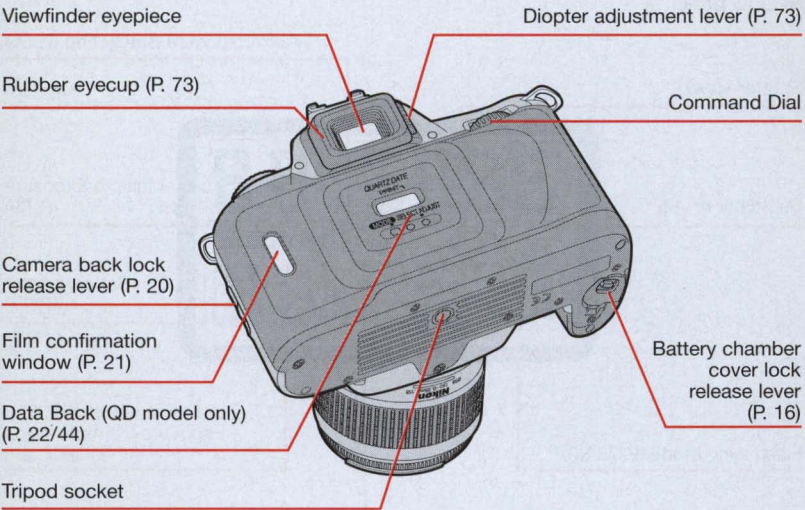

* Illustration shown is the N55 QD model. The camera back of the N55 non-QD model differs from the QD model.

■ QD model only: Data imprint LCD/buttons

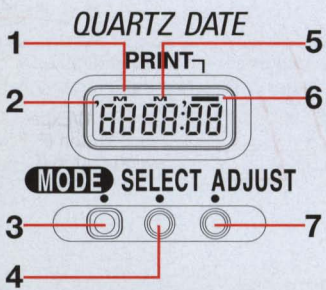

1. Date/time LCD
2. ¹: Year indicator
3. MODE button: Push to select one of five available displays.
4. SELECT button: Push to select date/time to be adjusted.
5. **M**: Month indicator
6. **█**: Data imprint indicator: Blinks approx. 2 sec. when data is imprinted.
7. ADJUST button: Push to adjust date/time.

LCD Panel/Viewfinder Display

■ LCD panel

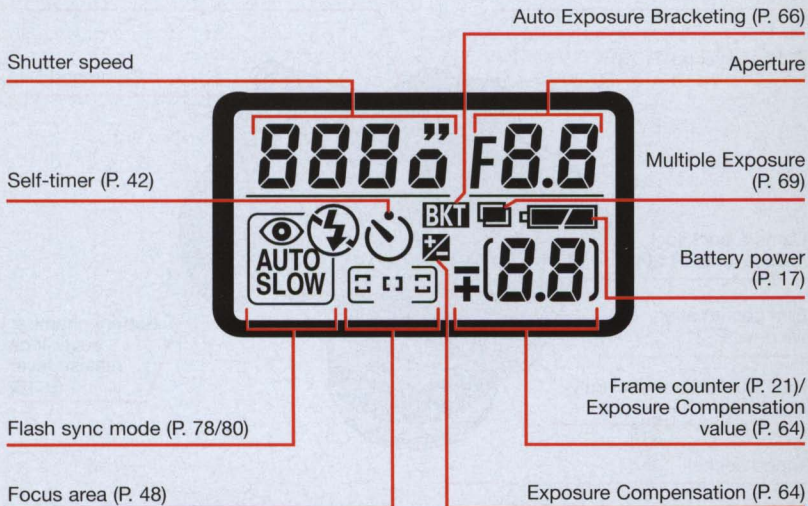

* The illustrations are fully labelled for your reference.

NOTE: About LCD

The LCD panel and viewfinder displays tend to turn darker at high temperatures and have slower response time at low temperatures. In either case, when the temperature returns to normal, the displays also return to normal.

■ Viewfinder display

Focus area (focus brackets) (P. 30/48)

Center Partial Metering area (p. 60)

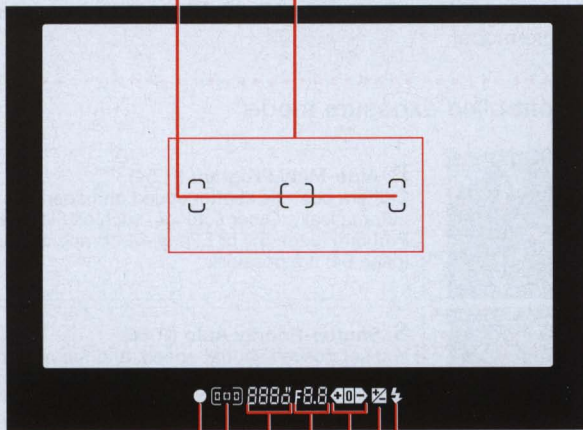

Focus indicator (P. 31/46)

Flash ready-light (P. 41/77)/
Flash recommended
indication (P. 80)

Focus area (P. 48)

Exposure Compensation
(P. 64)

Shutter speed

Electronic analog exposure (P. 61)/
Exposure Compensation value
display (P. 64)

Aperture

Available Exposure Modes

The exposure mode dial of the Nikon N55 can be divided into two sections. One is the user-controlled exposure mode with Auto-Multi Program, Shutter-Priority Auto, Aperture-Priority Auto or Manual exposure modes, where the photographer can determine various exposure factors. The other section is point-and-shoot exposure mode in which the camera automatically controls various exposure settings. See pages 28, 37-39, 54-62 for more details on each exposure mode.

■ User-controlled exposure mode



P: Auto-Multi Program (P. 54)

Camera controls shutter speed and aperture automatically. Other settings, such as Flexible Program (page 55) or Exposure Compensation (page 64) are possible.



S: Shutter-Priority Auto (P. 56)

You set desired shutter speed, and the camera selects the correct aperture. Freeze the motion of a moving subject or blur the subject.



A: Aperture-Priority Auto (P. 58)

You set the desired aperture, and the camera selects the correct shutter speed. Lets you determine depth of the in-focus area.



M: Manual (P. 60)

Shutter speed and aperture are set manually. Suitable for taking photographs with unique effects.



■ Point-and-shoot exposure mode

AUTO

: AUTO mode (P. 28)

Camera automatically controls all the exposure settings. Suitable for taking pictures right away.



: Portrait mode (P. 37)

Use this mode to take portraits. The background is blurred to accentuate your main subject.



: Landscape mode (P. 37)

Use this mode to take pictures of distant daytime or nighttime scenes. The overall landscape will be sharply focused.



: Close-Up mode (P. 38)

Use this mode to take up-close pictures of subjects such as flowers or insects.



: Sports Continuous mode (P. 38)

Use this mode to freeze the motion of fast-moving subjects. Continuous shooting is also possible with this mode.



: Night Portrait mode (P. 39)

Use this mode for subjects with an evening or night background.



Start Shooting Immediately

- 1** Open the battery chamber and install batteries while the camera's power is off (page 16).

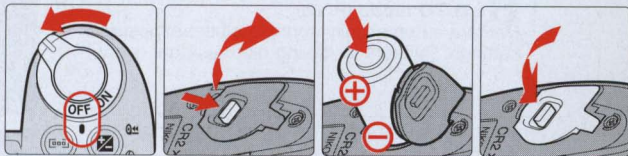

- 2** Attach the lens and turn the power switch on (page 18).

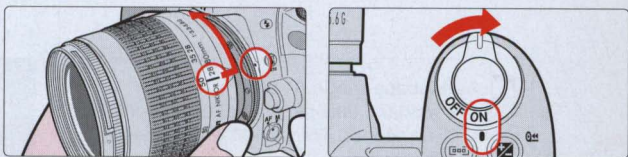

- 3** Open the camera back and install the film (page 20).

- When the camera back is closed, the film is automatically advanced and the number of available exposures is displayed in the LCD panel.

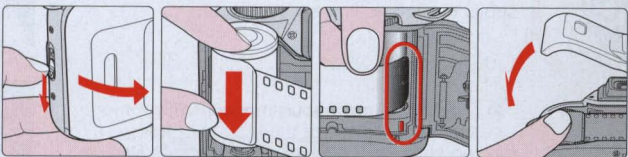

- 4** Set the focus mode selector to AF (autofocus) (page 26) and the exposure mode dial to  (AUTO mode) (page 28).

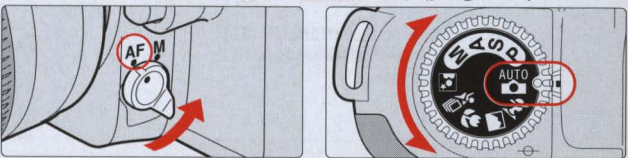

5 Hold the camera properly, compose frame and focus by lightly pressing the shutter release button (page 30).



6 Confirm focus indicator ● appears without blinking and slowly depress the shutter release button (page 32).

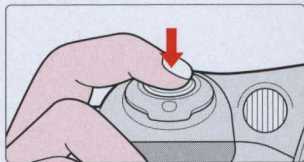

7 Film starts to rewind automatically when it reaches the end of the roll (page 33).

- Make sure **E** is blinking in the LCD panel when removing the film cartridge.

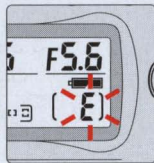
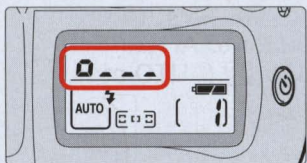

PREPARATION

This section introduces the various operations necessary before you start shooting.

- Install batteries and check battery power
- Mount lens
- Load film
- Set date and time (QD model only)
- About shutter release button

1

Install Batteries and Check Battery Power

Use two CR2-type 3V lithium batteries.

- 1 Turn the power switch off and open the battery chamber cover by sliding the battery chamber cover lock release lever toward indicated direction.

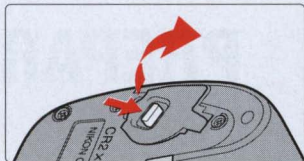
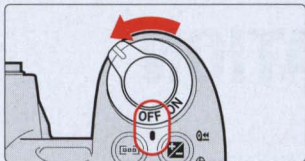

- When replacing batteries, be sure to turn the power switch off and replace both batteries at the same time. Always use fresh batteries of the same brand.

NOTE: Storing batteries

Keep the batteries out of children's reach. If swallowed, contact a doctor immediately. (For "Notes on Batteries", see page 102.)

- 2 Insert batteries with the \oplus and \ominus ends positioned as marked inside the battery chamber, then firmly close the battery chamber cover.

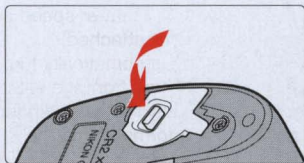
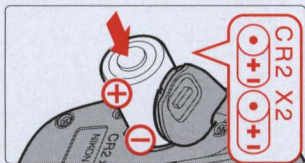



- Make sure to firmly close the battery chamber cover until it locks into place.
- Incorrect positioning of \oplus and \ominus poles may damage the camera.

Check points

- We recommend that you take spare batteries with you, especially when travelling.
- For the number of film rolls that can be shot with fresh batteries, see page 114.

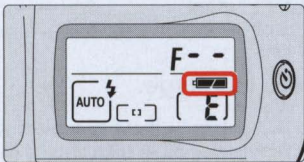
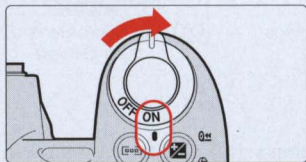
3 Turn the power switch on and confirm battery power with the indication.



 appears: Sufficient battery power.

 appears: Batteries are nearing exhaustion. Have a fresh set ready. (Viewfinder indications turn off when you release your finger from the shutter release button after taking the picture.)

 blinks: Batteries are exhausted. Replace batteries. (Shutter locks.)

Lightly press the shutter release button to activate the exposure meter.

Lightly pressing the shutter release button reactivates the exposure meter and indications in the LCD panel and viewfinder. Shutter speed and aperture (F - - when lens is not attached) indications in the LCD panel automatically turn off 5 sec. after releasing your finger from the shutter release button. (All indications in the viewfinder turn off.) See page 24 for information on the shutter release button.

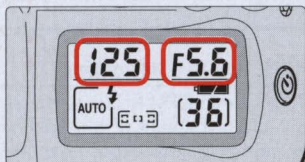
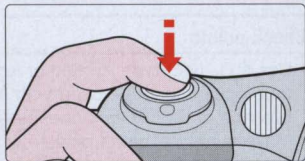

2 Mount Lens

Turn the power switch off and mount the lens to the camera body.

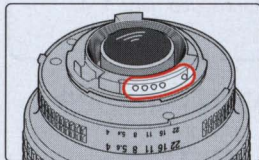

CPU contacts of CPU Nikon lens

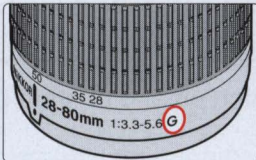

① G-type Nikon lens

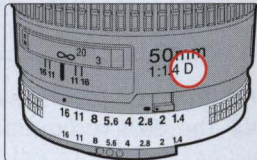

② CPU Nikon lens other than G-type

1 Check the lens type.

- ① G-type Nikon lens, without aperture ring
- ② CPU Nikon lenses other than G-type (Illustration is D-type Nikon lens), with aperture ring

G-type Nikon lens

The G-type Nikon lens has no aperture ring; aperture should be selected from camera body. Unlike other CPU Nikon lenses, aperture does not need to be set to minimum.

Check points

- Use a G- or D-type AF Nikon lens to utilize all of this camera's functions. However, autofocus cannot be used with AF-S and AF-I lenses, and the Vibration Reduction function of the VR lens does not function (p. 88).
- Make sure to turn the power switch off when attaching/detaching the lens.
- Avoid direct sunlight when attaching/detaching the lens.

NOTE: Non-CPU Nikon lens

When a non-CPU Nikon lens is attached and the power switch is turned on, F - - blinks in the LCD panel and viewfinder, and the shutter cannot be released (except in Manual exposure mode). See page 90 for a non-CPU lens.

2 Turn the power switch off and mount the lens to the camera body.

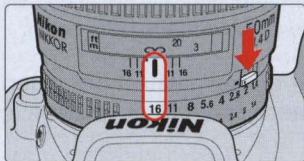
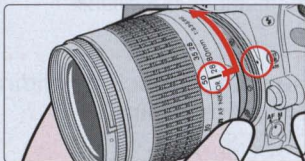

With G-type Nikkor lens

Position lens in the camera's bayonet mount so that the mounting indexes on lens and camera body are aligned, then twist lens anticlockwise until it locks into place. (Be sure not to touch the lens release button.)

With CPU Nikkor lens with aperture ring (other than G-type)

Position lens in the camera's bayonet mount so that the mounting indexes on lens and camera body are aligned, then twist lens anticlockwise until it locks into place. (Be sure not to touch the lens release button.) And then, **set the lens aperture to its minimum and lock.**

- When the lens is not set to its minimum aperture setting and the power switch is turned on, **fEE** blinks in the LCD panel and viewfinder and the shutter cannot be released.

3 Detach the lens.

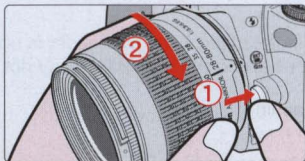

- Push and hold the lens release button, then turn the lens clockwise to detach the lens.

When camera is left unattended without lens

When you leave the camera unattended without a lens attached, be sure to attach the supplied body cap (page 2), or optional body cap BF-1A. (BF-1 body cap cannot be used.)

3

Load Film

Turn the power switch on and load DX-coded film. With DX-coded film, film speed will be set automatically (ISO 25-5000). When the camera back is closed, the film automatically advances and the number of available exposures is displayed in the LCD panel.

- 1** Turn the power switch on, open the camera back by sliding the camera back lock release lever and load film.

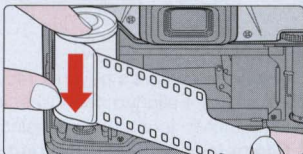
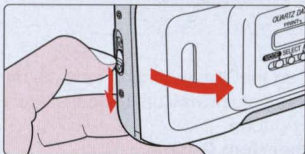

- Film cartridge can be loaded smoothly if inserted from the bottom.
- Make sure to insert the film cartridge all the way in.

- 2** Pull film leader across to red index mark.

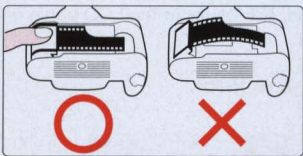
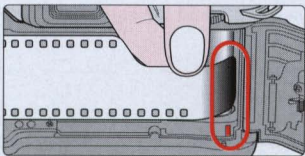

- Make sure to align the film leader to the red index mark; if the film leader is not properly aligned to the index mark (short of or beyond the mark), film may not be loaded properly.
- Hold the film cartridge and ensure film is properly positioned with no slack.



NOTE: Loading/removing film

Shutter curtains are very thin. Do not touch the shutter curtains with your finger or the film leader.

3 Gently close the camera back until the camera back snaps closed.

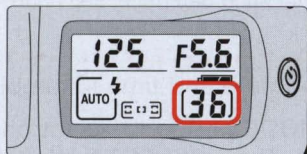
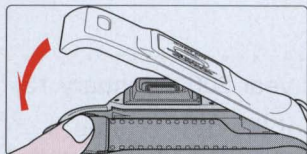

- The film automatically advances to final frame with blinking \square , \square -, \square .., \square ... as indicated in LCD panel.
- When the film has completed set up, a shutter sound is let out but no picture has been taken.
- LCD Panel indicates number of exposures left on film.
- Film rewinds one frame at a time as photos are taken.
- When E appears in the LCD panel, film is not properly installed. Open the camera back again and reload film by aligning the film leader to the red index mark.
- When Err and E in the LCD panel and Err in viewfinder blink, film is not correctly advanced. Open the camera back again and reload film.
- Pictures taken on frames beyond the indicated number of the exposures for the film roll may be discarded in the process of developing.

DX-coded film

With DX-coded film, film speed will be set automatically between ISO 25 to ISO 5000. Film speed is set to ISO 100 with non-DX-coded film.

DX-coded film

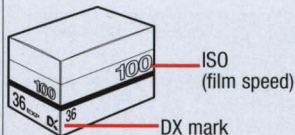

Check points

- Avoid direct sunlight when changing film outdoors.
- You can check the number of available exposures on the film roll and film speed through the film confirmation window.
- Infrared films cannot be used with this camera since an infrared sensor is used for the detection of the film frame position.

4

Set Date and Time (QD model only)

This camera allows you to imprint Year/Month/Day, Day/Hour/Minute (24-hour clock), Month/Day/Year or Day/Month/Year on your picture in any exposure mode. (For imprinting date/time, see page 44.)

■ Adjusting date and time (Example: year 2002, January 15)

1 Push MODE button to select one of the date or time displays. Push SELECT button so section to be corrected starts blinking.

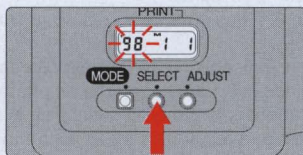
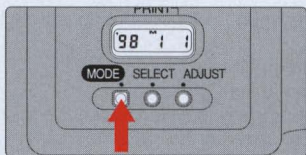

- Date cannot be set in Day/Hour/Minute display. To set date, select Year/Month/Day, Month/Day/Year or Day/Month/Year.
- Set the time in Day/Hour/Minute display.

2 Push ADJUST button to change the blinking numbers and after correction, push SELECT button until the numbers stop blinking.

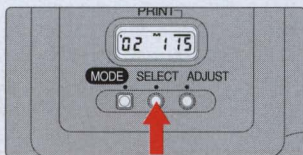
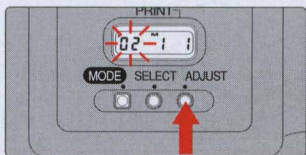

- Each time you push the ADJUST button, year section moves up from 98 to 49 (back to 98 after 49).
- To change the numerical indication rapidly, hold the ADJUST button down for more than 1 sec.
- Push SELECT button until the date/time display stops blinking. When the imprint indicator — appears in the data imprint LCD panel, the setting is complete.

■ Changing battery for imprinting

- 1 Open camera back, remove the battery chamber cover for imprinting by removing the screw using a screwdriver.

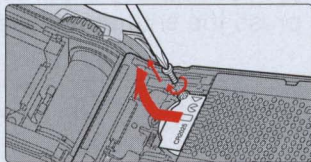
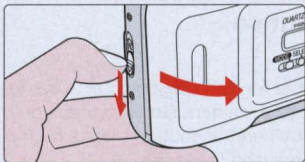

- 2 Remove the used battery and insert a new CR2025 3V lithium battery with \oplus side facing up. Attach the battery chamber cover by reinserting the screw.

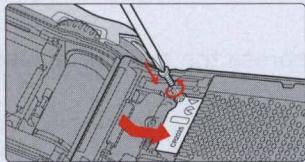
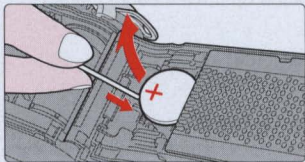

- Use a pointed object to remove the battery.

NOTE: Battery requirements for imprinting

Imprinting of date/time requires one CR2025 3V lithium battery separate from the batteries required for the camera body. Battery life is approx. 3 years. When the imprinting on the photo appears faded and/or the display of the data imprint on the LCD becomes faint or disappears, this indicates low battery power. Replace the battery (making sure to set correct date/time after changing battery).

NOTE: Storing batteries

Keep the batteries out of children's reach. If swallowed, contact a doctor immediately. (For "Notes on Batteries", see page 102.)

About Shutter Release Button

Lightly pressing the shutter release button and holding it halfway down activates the camera's exposure meter and pressing it all the way down releases the shutter.

1 Lightly press the shutter release button.

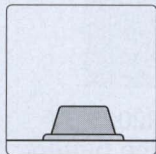

Before pressing



Lightly pressing

- When the focus mode selector is set to AF (autofocus), camera starts to focus on the subject when the shutter release button is lightly pressed (page 30).
- Lightly pressing the shutter release button activates the indications in the LCD panel and viewfinder (for approx. 5 sec. from removal of finger). (See page 17 for information on the exposure meter.)

2 Fully depress the shutter release button.

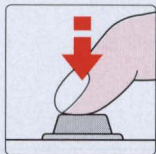

Lightly pressing



Fully
depressing

- Fully depressing the shutter release button releases shutter and film automatically advances to the next frame.

NOTE: Camera shake

Pressing the shutter release button abruptly can result in picture blur. Make sure to press the shutter release button slowly.

BASIC OPERATION 1

This section features the settings for most common picture-taking situations using AUTO mode (AUTO) to enable easy operation even for beginners.

Shooting modes/functions explained in this section are as follows:

Lens attached	G-type AF Nikkor (P. 18)
Focus mode	AF (autofocus) (P. 26)
Focus area	Dynamic AF Mode with Closest-Subject Priority* (P. 26)
Exposure metering system	Five-segment 3D Matrix Metering* (P. 28)
Exposure mode	AUTO mode (AUTO) (P. 28)
Flash sync mode	Front-Curtain Sync (⚡)* (P. 78)

* Automatically set when AUTO mode is selected.

1

Set Focus Mode to AF

Set focus mode to AF (autofocus). (See page 46 for details.)

Turn the power switch on and set the focus mode selector to AF (autofocus).

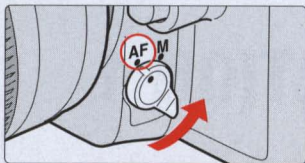



- Make sure to turn the focus mode selector until it clicks into position.
- To focus, lightly press the shutter release button (page 24).

NOTE: AF focus mode

Do not rotate the lens focusing ring manually when the focus mode selector is set to AF.

Dynamic AF Mode with Closest-Subject Priority

Dynamic AF Mode with Closest-Subject Priority automatically focuses on the subject located closest to any of three focus areas (page 48). If the subject moves from the selected focus area, the camera automatically focuses on the subject determining the data from the other focus areas. When the exposure mode is set to  (AUTO mode, page 28) or to any Vari-Program (page 36) (except  Close-Up mode), the N55 automatically selects Dynamic AF Mode with Closest-Subject Priority for easy operation, making it unnecessary to switch the focus area.

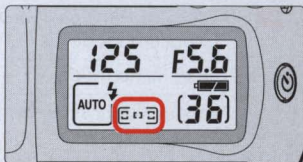
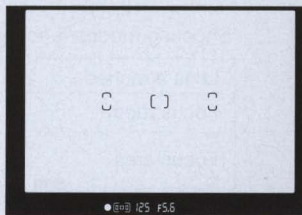

Situations where autofocus may not work as expected

Autofocus may not work as expected in the following situations. In such situations, focus manually using the clear matte field (page 47) or focus on a different subject located at the same distance, use focus lock (page 52) then recompose.



Low-contrast scenes

For example, where the subject is wearing clothing the same color as a wall or other background.



Scenes with subjects within the focus brackets located at different distances from the camera

For example, when photographing an animal in a cage or a person in a forest.

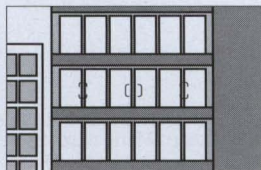

Patterned subject or scene

For example, building windows.

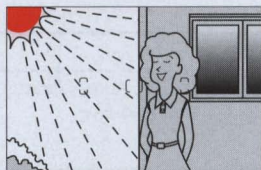



Scenes with pronounced differences in brightness within the focus brackets

For example, when the sun is in the background and the main subject is in shadow.

2

Set Exposure Mode to

When the exposure mode is set to , the camera automatically controls all the exposure settings.

Set exposure mode to .

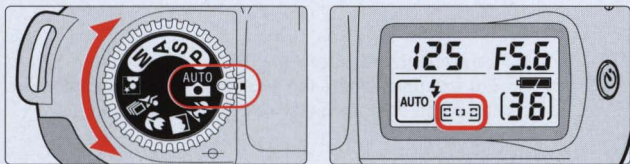

- When the shutter release button is lightly pressed, shutter speed and aperture are indicated in the LCD panel and viewfinder.
- When the exposure mode is set to , **Matrix Metering** is automatically selected.
- Check if the AF Area mode is set to **Dynamic AF Mode with Closest-Subject Priority**. See page 48 for details.

Matrix Metering (page 34)

The Matrix Meter employed in the N55 uses a five-segment sensor to achieve superior metering results even in extremely complex lighting conditions. The microcomputer analyzes data including scene brightness and contrast—and subject distance when you use a G- or D-type Nikkor lens (**3D Matrix Metering** is performed)—and makes the calculations necessary to assure correct exposure. This camera automatically selects Matrix Metering in all exposure modes except Manual exposure mode (page 60).

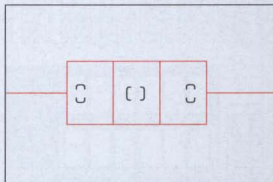







Check point

In  mode, Flexible Program (p. 55), Exposure Compensation (p. 64), Auto Exposure Bracketing (p. 66), Multiple Exposure (p. 69), Slow Sync (p. 78) and Red-Eye Reduction with Slow Sync (p. 79) cannot be set.

■ About exposure mode

Four exposure modes besides  and five Vari-Program modes are available with this camera. Utilizing the characteristics of each exposure mode, effective results can be achieved with various types of subjects or shooting situations. And the five Vari-Program modes enable you to easily choose proper exposure controls by simply selecting the desired mode for various shooting situations.

See each reference page for operating instructions and details.

Symbol	Exposure mode	Characteristics/Shooting situations	
	AUTO P. 28	The easiest exposure mode for general shooting. Camera controls shutter speed and aperture automatically depending on the subject's brightness—allowing you to freely take pictures, concentrating only on the shutter release opportunity.	
Vari-Program		Portrait P. 37	Use this mode to take portraits. The background is blurred to accentuate your main subject.
		Landscape P. 37	Use this mode to take pictures of distant scenes. The overall landscape will be sharply focused. This mode is also suitable for capturing nighttime or twilight scenes.
		Close-Up P. 38	Use this mode to take up-close pictures of subjects such as flowers or insects. Your close-ups will be taken with an artistically blurred background.
		Sports Continuous P. 38	Use this mode to take sports pictures. Using a fast shutter speed, it freezes the motion of fast-moving subjects to create exciting action photos. Continuous shooting is possible with this mode.
		Night Portrait P. 39	Use this mode for subjects with an evening or night background. This mode captures all lighting in the scene, including the foreground subject which is illuminated by the flash, and the background.
P	Auto-Multi Program P. 54	Camera controls shutter speed and aperture automatically, while allowing you to make other settings, such as Flexible Program (page 55) or Exposure Compensation (page 64).	
S	Shutter-Priority Auto P. 56	You set desired shutter speed, and the camera selects the correct aperture. Freeze the motion of a moving subject using a fast shutter speed or blur the subject using a slower speed.	
A	Aperture-Priority Auto P. 58	You set the desired aperture, and the camera selects the correct shutter speed. Lets you determine depth of the in-focus area, so you can choose whether near or far subjects are in sharp focus, or whether foreground or background is to be blurred.	
M	Manual P. 60	Shutter speed and aperture are set manually. Suitable for situations where it is difficult to attain the desired effect using other exposure modes. Long Time exposure is possible with this exposure mode.	

3

Hold Camera and Focus



Lightly pressing the shutter release button automatically focuses the camera on the subject and when the subject is in focus, causes ● to appear in the viewfinder.

1 Hold the camera properly.



- Keep your elbow propped against your body for support.
- Stand with one foot forward a half step and keep your upper body still.
- Grasp the camera handgrip with your right hand and use your left hand to cradle the camera (or lens).



NOTE: Camera shake

Camera shake is likely to occur when the camera is not held steady or with slow shutter speed. The built-in Speedlight automatically fires in dark conditions (where slow shutter speed is required) in  or Vari-Program (except for  and ) with this camera but always remember to hold the camera correctly.

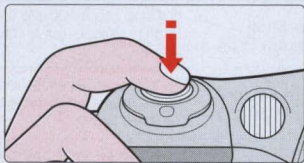
2 Compose frame, center focus brackets on your subject, and focus by lightly pressing the shutter release button.





- Compose frame so that the subject to be focused is located closest at any of three focus areas and lightly press the shutter release button. When the Dynamic AF Mode with Closest-Subject Priority (pages 26, 48) is set, camera automatically maintains focus on the subject located closest to any of three focus areas.

- When shutter release button is lightly pressed, the camera focuses automatically and focus indicator appears or blinks as follows:
 - appears: Subject is in focus.
 - (with red lines) blinks: Unable to focus using autofocus.
- With dark subjects, the camera's AF-Assist Illuminator (page 50) is automatically activated to guide autofocus (except in  or .

Check points

- Diopter adjustment (page 73) enables you to see more clearly through the viewfinder.
- To take a picture of a subject outside the focus area, shift the focus area (page 48) or use focus lock (page 52).
- In situations where autofocus may not work as expected, see page 27.

Built-in Speedlight

When the subject is dark or backlit and the shutter release button is lightly pressed, the built-in Speedlight automatically pops up in  or Vari-Program (except in  or ). See page 40 for details.

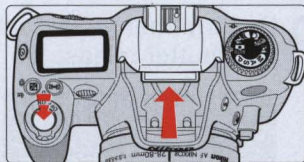

NOTE: Composing frame

This camera's viewfinder frame shows approximately 89% of the image actually exposed on the film frame. Therefore, the actual exposed frame is somewhat larger than the image you see through the viewfinder. Note that the edges of a negative film are partially cropped by most labs.

4 Release Shutter

Confirm that ● (in-focus indicator) appears in the viewfinder, then slowly, fully depress the shutter release button. With a moving subject, Continuous Servo AF (page 46) activates and camera continuously focuses on the subject.

1 Confirm indications in the viewfinder while lightly pressing the shutter release button.



- When the subject is dark or backlit and shutter release button is lightly pressed, the built-in Speedlight automatically pops up and starts charging (pages 40, 76).

2 Confirm that focus indicator ● appears and slowly depress the shutter release button.



- After the shutter is released, the film automatically advances to the next frame and the next shot can be taken.

3 Film starts to rewind automatically when the last shot is taken.

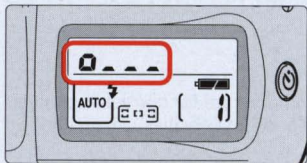

- 0... is displayed during film rewind.

4 Confirm that film is completely rewound, then remove film cartridge.

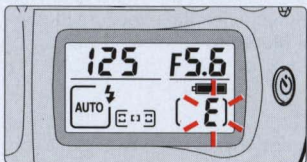

- Film is completely rewound when the frame counter shows blinking E in the LCD panel. (E appears without blinking when the exposure meter is off.) Make sure the film is completely rewound (E is blinking in the LCD panel), open the camera back away from sunlight and remove the film cartridge.

Check points

- If any other warning indications appear, see page 103.
- For mid-roll rewind, see page 72.

About Metering Systems and Exposure

Metering systems and exposure are important factors for taking pictures. Knowing the characteristics of each factor helps you widen your photographic expression.

■ Metering Systems

As the proper combination of shutter speed and aperture for correct exposure is determined according to subject brightness and film sensitivity, measuring subject brightness is very important.

In general, brightness inside the viewfinder is not uniform. The N55 provides two metering systems: **Matrix Metering** (page 28) and **Center Partial Metering** (page 60). With **Matrix Metering**, data on scene brightness is detected by the five-segment Matrix sensor. Using G- or D-type Nikkor lenses, the N55 camera performs **3D Matrix Metering** by adding distance information to determine correct exposure. With **Center Partial Metering**, brightness is detected at the central areas including three focus areas in the viewfinder. With the N55, **Matrix Metering** is automatically selected when the exposure mode is set to other than Manual and **Center Partial Metering** is selected with Manual exposure mode.

■ Exposure

Light from the subject passes through the lens and exposes the film. Light reaching the film is controlled by the shutter speed and aperture. The proper combination of shutter speed and aperture for subject brightness and film sensitivity results in the correct exposure.

The N55's AUTO mode (page 28), Auto-Multi Program (page 54) and Vari-Program (page 36) automatically control shutter speed and aperture. Vari-Program gives you the option to choose from Portrait, Landscape, Close-Up, Sports Continuous or Night Portrait mode—designed for specific picture-taking situations and photographic images. In Shutter-Priority Auto exposure mode (page 56), you can manually set shutter speed and the camera automatically sets the proper aperture. In Aperture-Priority Auto exposure mode (page 58), you can manually set aperture and the camera automatically sets the proper shutter speed. In Manual exposure mode (page 60), you manually set both shutter speed and aperture.



BASIC OPERATION 2

This section describes the following basic operations:

- Shooting with Vari-Program
- Using Built-In Speedlight
- Self-Timer Operation
- Imprinting Date/Time (QD model only)

Shooting with Vari-Program

Vari-Program gives you the option to choose from Portrait, Landscape, Close-Up, Sports Continuous or Night Portrait mode—designed for specific picture-taking situations and photographic images.

- 1** Set the exposure mode dial to the desired Vari-Program, then lightly press the shutter release button.

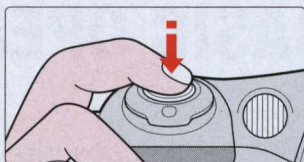



- Center the focus brackets on your subject (where you want the focus) and lightly press the shutter release button. The camera focuses automatically and focus indicator appears or blinks as follows:

● appears: Subject is in focus.

⦿ blinks: Unable to focus using autofocus.

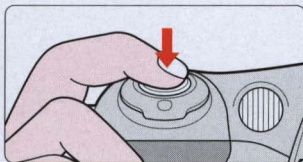
- 2** Confirm that focus indicator ● appears and slowly depress the shutter release button.



- Shutter speed and aperture are automatically determined to suit the selected Vari-Program and are displayed in the LCD panel and viewfinder.
- When the subject is dark or backlit, the built-in Speedlight automatically pops up and fires (except in  or .

: Portrait mode

Use this mode whenever you are taking pictures of people. It creates a blurred background to accentuate your main subject.

- 85mm to 200mm telephoto lenses with large maximum apertures are recommended.
- Distancing the main subject and the background emphasizes the effect.



: Landscape mode

Use this mode whenever you're taking a picture of a distant scene. The overall picture, whether the subject is near or far, is sharply focused. It also allows you to capture the beauty of nighttime or twilight scenes.

- Built-in Speedlight does not fire even when the subject is dark or backlit.
- In some shooting situations, especially shooting night scenes, slow shutter speed is selected. To avoid camera shake, use a tripod. Use of self-timer also helps to avoid camera shake.
- A wide-angle lens is suited to capturing a wide view of the landscape.



NOTE: Vari-Program

Flexible Program (page 55), Auto Exposure Bracketing (page 66) and Multiple Exposure (page 69) cannot be performed in Vari-Program. When using the flash in Vari-Program, available Flash Sync modes differ with each program (page 84).

Shooting with Vari-Program—continued



Close-Up mode

Use this mode when you are taking pictures up close. It creates a blurred background to accentuate your main subject. Useful in taking close-ups of subjects such as flowers or insects.

- Dynamic AF Mode and center focus area are automatically selected (page 48).
- In some shooting situations, slow shutter speed is selected. To avoid camera shake, use a tripod. Use of self-timer also helps to avoid camera shake.
- Effect is maximized at minimum focusing distance of the lens in use. When using a zoom lens, use telephoto zoom position.
- For more professional uses, Micro-Nikkor lenses are recommended.

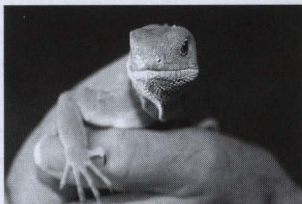

Sports Continuous mode

Use this mode to freeze action. It uses a fast shutter speed suitable for stop-action photography. In Sports Continuous mode, Continuous Servo AF (page 46) is automatically activated and the camera continues to focus on the subject without Focus lock (page 52). Also, the shutter is released repeatedly as long as the shutter release button is fully depressed.

- Built-in Speedlight does not fire even when the subject is dark or backlit.
- 80mm to 300mm telephoto lenses are recommended.
- Use of ISO 400 or faster film speed is recommended.
- A tripod is recommended when using a telephoto lens to avoid camera shake.







: Night Portrait mode

Use this mode for subjects with an evening or night background. Night Portrait mode captures all the lighting in the scene, including the foreground subject and background.

- Use Landscape mode for twilight or nighttime scene without foreground subject.
- Use of ISO 400 or faster film speed is recommended.
- To avoid camera shake, use a tripod.



Using Built-In Speedlight

When the subject is dark or backlit and the shutter release button is lightly pressed, the built-in Speedlight automatically pops up in  or Vari-Program (except in  or ). Fully depress the shutter release button to take pictures with the Speedlight.

- 1** When the subject is dark or backlit and the shutter release button is lightly pressed, the built-in Speedlight automatically pops up and starts charging.

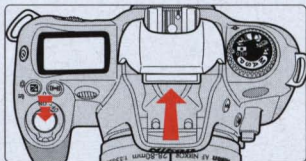

- When the built-in Speedlight is ready to fire,  appears without blinking in the viewfinder (when the camera's meter is on).
- When you want to take a picture without the flash, close the built-in Speedlight until it clicks shut while lightly pressing the shutter release button. (When the flash is canceled in this manner, as long as the shutter release button is kept lightly pressed, flash is canceled for subsequent shots. When you remove your finger from the shutter release button and shutter release button is lightly pressed again, the built-in Speedlight pops up again and flash starts charging.)
- To cancel the flash, select the Flash Cancel mode (page 79) before lightly pressing the shutter release button.

Built-in Speedlight and Matrix Balanced Fill-Flash

- The built-in Speedlight offers an angle of coverage of 28mm lens with a guide number of 12/40 (ISO 100, m/ft.). When a wide-angle lens of less than 28mm focal length is used in flash photography using the built-in Speedlight, the flash may not reach the peripheral area and may result in a dark picture.
- Using CPU Nikkor lenses such as a G- or D-type Nikkor lens enables use of **Matrix Balanced Fill-Flash**. Analyzing the brightness and contrast level derived from Matrix Metering, the **Matrix Balanced Fill-Flash** ensures proper exposure of the main subject and background, while providing adequate flash output to create natural-looking flash photography. See page 76 for details.

2 Confirm \blacksquare in viewfinder, then compose, focus and take the picture with flash by fully depressing the shutter release button.

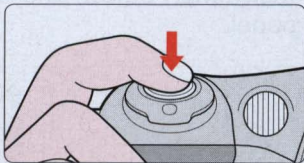
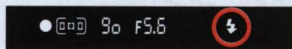

- The shutter cannot be released unless \blacksquare appears without blinking in the viewfinder.
- \blacksquare blinks in the viewfinder approx. 3 sec. after full flash output. If this happens, underexposure may have occurred. Check the flash shooting distance range (page 83) and shoot again.
- With dark subjects, the camera's AF-Assist Illuminator is automatically activated to guide autofocus. See page 50 for details.

NOTE: Continuous use of built-in Speedlight



After continuous use of the built-in Speedlight, it may stop firing to protect the firing tube. Wait for a while before using the built-in Speedlight again.

Check points

- Be sure to remove (or store) the lens hood before flash shooting.
- Some lenses have limitations using the built-in Speedlight and may cause vignetting (a shadow may appear within the frame) (page 85).
- Normal Front-Curtain Sync flash mode is introduced in this section. Various flash sync modes are also available. For details, see page 78.

Self-Timer Operation

You can use the self-timer when you want to be in the photograph or reduce camera shake.

- 1 Press  (self-timer) button and confirm that  appears on the LCD panel.

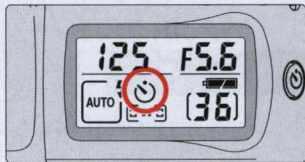
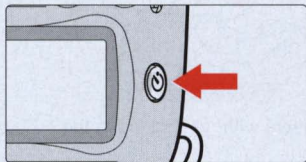



Check points

- Use a tripod or place the camera on a stable surface before using the self-timer.
- To shoot in an exposure mode other than Manual, cover the eyepiece with the supplied eyepiece cap DK-5 (page 2) or with your hand before pressing the shutter release button to prevent interference from stray light and achieve correct exposure.
- Do not stand in front of the lens when setting the self-timer in autofocus mode.

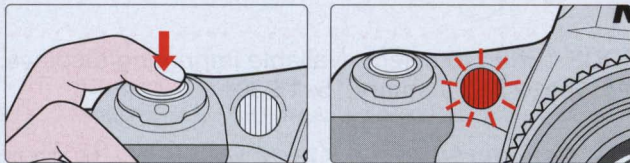
2 Compose picture, focus by lightly pressing the shutter release button and fully depress the shutter release button.



- Self-timer shooting cannot be performed unless the camera's shutter can be released (i.e. when subject cannot be brought into focus with autofocus).
- Once the self-timer is activated, the shutter will release in 10 seconds. The self-timer lamp will blink for 8 sec. and then illuminate for 2 sec. before the shutter is released.
- When Red-Eye Reduction (page 79) is set, self-timer activates and the self-timer/red-eye reduction lamp lights for 1 sec. before the shutter releases at the same output level as the normal Red-Eye Reduction function.
- To cancel the self-timer mode or the self-timer during self-timer operation, either turn the power switch off, or press the  button until  disappears from the LCD panel.

Imprinting Date/Time (QD model only)

You can imprint the following date information on your picture:
Year/Month/Day, Day/Hour/Minute, Month/Day/Year or Day/Month/Year. See page 22 to set date and time.

1 Push MODE button to select available imprinting displays. (Example: year 2002, January 15, 15:30)

Each time you push the MODE button the display changes as follows:

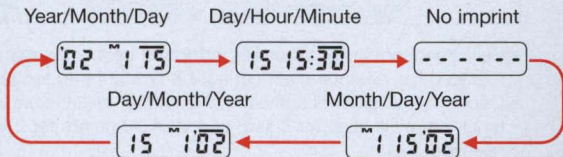
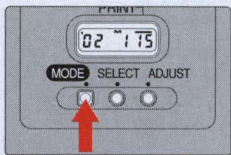

- The data displayed on the data imprint LCD will be imprinted on the picture. Select - - - - (no imprint) to cancel data imprint. Compatible film speeds for data imprinting are ISO32-3200.

2 Compose picture, focus and fully depress the shutter release button to take a picture with the imprinted date/time.

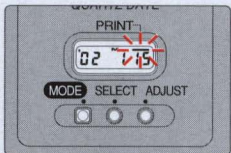

- Data imprint indicator  blinks for approx. two to three sec. immediately after the shutter is released (when film is loaded).

Imprinted date/time

The illustration at right indicates the position of the imprinted date/time on the film. It may be difficult to read against bright colors such as white or reddish hues.

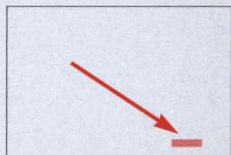

FOCUS OPERATION

This section features detailed descriptions of focusing operations.

- Focus mode
- Focus area
- AF-Assist Illuminator
- Focus lock

Focus Mode

Two focus modes, autofocus using the Auto-Servo AF (Single Servo AF and Continuous Servo AF) and Manual focus, are available with this camera.

■ Autofocus

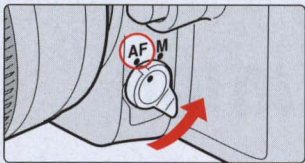

- With the focus mode selector set to **AF**, lightly pressing the shutter release button automatically focuses the camera on the subject at the focus area (page 9/48) and causes ● to appear in the viewfinder.

■ Auto-Servo AF

Camera automatically chooses Single Servo AF or Continuous Servo AF operation according to the subject status, i.e. stationary or moving.

• Single Servo AF

Automatically activated when shooting a stationary subject.

The shutter can be released when the focus indicator ● appears in the viewfinder. Once focused on a subject, keeping the shutter release button lightly pressed locks focus (Focus Lock, page 52). However, if the subject starts moving, Focus Lock is deactivated, and the focus mode automatically switches to Continuous Servo AF.

• Continuous Servo AF

Continuous Servo AF is automatically activated when the subject is moving. The shutter can be released when the focus indicator ● appears in the viewfinder; however, focus is not locked and the camera continues to focus on the subject until shutter release. With a moving subject, Focus Tracking (page 108) is activated and the camera continuously focuses on the subject. Also, N55 will continue to focus firmly on a main subject with Lock-On™.

- When  Sports Continuous mode is selected, Continuous Servo AF is automatically activated and the camera continuously focuses on the subject.

About Lock-On™

Lock-On™ Autofocus keeps focus firmly on a main subject even if some other object momentarily blocks it in the viewfinder.

Manual focus

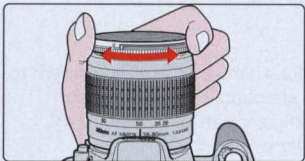
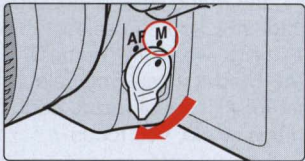

- Set the focus mode selector to **M**. Look through the viewfinder and rotate the lens focusing ring until the image appears sharp on the clear matte field in the viewfinder. The shutter can be released whether or not the subject is in focus and regardless of the focus indicator status.
- Use Manual focus in situations where autofocus may not work as expected (page 27) or with lenses which do not allow autofocus operation when attached to the N55 (page 88).
- When using a lens with the A-M select function, set the switch/ring to **M** to focus manually. If **M/A** (autofocus with manual priority) is available with your lens, Manual focus is possible either with the switch/ring set to **M** or **M/A**. See the instruction manual of your lens for details.

Manual focus using Electronic Rangefinder

Set the focus mode selector to **M**. The focus can be confirmed with ● indication in the viewfinder. The Electronic Rangefinder works with most Nikkor lenses (including AF Nikkors when operated manually) having a maximum aperture of $f/5.6$ or faster. Lightly press the shutter release button and while the meter is on, rotate the lens focusing ring until ● appears in the viewfinder. The shutter can be released anytime. The Electronic Rangefinder can be activated with any of three focus brackets selected as the focus area (page 9/49).

Focus Area

This camera's three focus areas cover a wide frame area, and you can select among them, depending on the subject's position in the frame or your desired composition. When the focus mode is set to **AF** (page 46), you can select either **Dynamic AF Mode with Closest-Subject Priority**, where the camera automatically selects the focus area, or **Dynamic AF Mode**, where you select the desired focus area. When the focus mode is set to M (manual focus, page 47), Single Area Mode is automatically selected. In this mode, you focus manually using the selected focus area.

Tip

Dynamic AF Mode with Closest-Subject Priority is useful when you want the camera to take automatic control over focus operations, or when shooting a moving subject. Dynamic AF Mode is useful in achieving focus on a particular part of a subject, or when the composition of the photograph is your top priority.

■ When focus mode is set to Autofocus

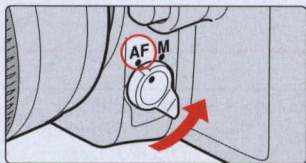

Set the focus mode selector to **AF** (autofocus) and rotate the Command Dial while pressing the focus area button to select focus area.

- Rotating the Command Dial while pressing the focus area button changes the display as follows:

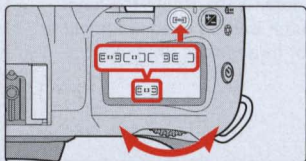

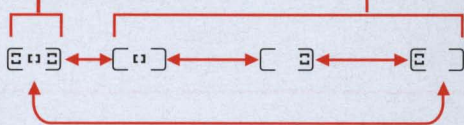

Dynamic AF Mode with Closest-Subject Priority Dynamic AF Mode

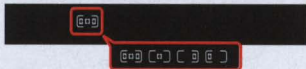

- Confirm selected focus area in the LCD panel and viewfinder.



• Dynamic AF Mode with Closest-Subject Priority

Dynamic AF Mode with Closest-Subject Priority automatically maintains focus on the subject located closest to any of three focus areas and focus is locked once it is achieved. If the subject moves from the selected focus area, the camera automatically focuses on the subject determining the data from the other focus areas. When  AUTO mode or Vari-Program (except  Close-Up mode) is selected, Dynamic AF Mode with Closest-Subject Priority is automatically selected.

• Dynamic AF Mode

Focus is obtained at the selected focus area and focusing is locked (as long as the shutter release button is lightly pressed) once it is achieved. If the subject moves from the selected focus area, the camera automatically focuses on the subject determining the data from the other focus areas. When  Close-Up mode is selected, Dynamic AF Mode and center focus area are automatically selected.

■ When focus mode is set to Manual

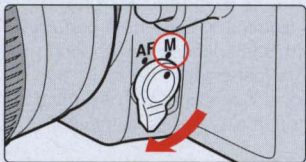

Set the focus mode selector to **M** (manual) and rotate the Command Dial while pressing the focus area button to select focus area.

- Rotating the Command Dial while pressing the focus area button changes the display as follows:

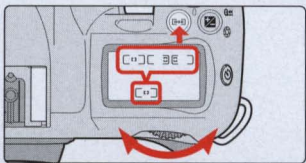

- Confirm selected focus area in the LCD panel and viewfinder.





• Single Area Mode

Single Area Mode is automatically selected when the focus mode selector is set to **M** (manual). Focus is obtained only at the selected focus area when using the manual focus.

AF-Assist Illuminator

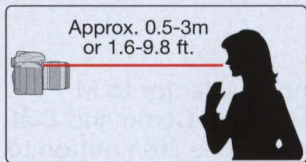
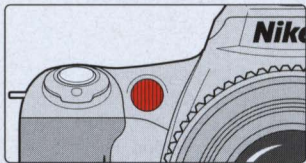
When the subject is dark and the shutter release button is pressed lightly, the camera's AF-Assist Illuminator automatically turns on and enables autofocus operation in a dark environment.



- AF-Assist Illuminator automatically turns on in the following situations:
Focus mode is autofocus, AF Nikkor lens (except AF-S and AF-I) is used, subject is dark and center focus area is selected or Dynamic AF Mode with Closest-Subject Priority is activated.
- AF-Assist Illuminator does not turn on in  or .
- Focal length of the usable AF Nikkor lens is 24-200mm.
- The distance range of the AF-Assist Illuminator is approx. 0.5-3m or 1.6-9.8 ft. Autofocus using the camera's AF-Assist Illuminator cannot be performed due to vignetting with some lenses at a shooting distance less than 1m (page 51).
- Even when the optional Speedlight with AF-Assist Illuminator is attached, the camera's Illuminator turns on (page 94).

NOTE: Continuous use of the AF-Assist Illuminator

When the AF-Assist Illuminator is used continuously, illumination is limited temporarily to protect the firing tube. The illumination restarts after a few moments. Also, when the AF-Assist Illuminator is used repeatedly in a short period of time, be careful not to touch the AF-Assist Illuminator lamp because it may become hot.

NOTE: Lenses incompatible with AF-Assist Illuminator

- Lenses with autofocus using the camera's AF-Assist Illuminator cannot be performed due to vignetting at a shooting distance less than 1m.
 - AF Micro 200mm f/4 IF-ED
 - AF 18-35mm f/3.5-4.5 ED
 - AF 20-35mm f/2.8 IF
 - AF 24-85mm f/2.8-4 IF
 - AF 24-120mm f/3.5-5.6 IF
 - AF Micro 70-180mm f/4.5-5.6 ED
- Lenses with autofocus using the camera's AF-Assist Illuminator cannot be performed due to vignetting regardless of shooting distance.
 - AF 80-200mm f/2.8 ED
 - AF VR 80-400mm f/4.5-5.6 ED
- Autofocus cannot be used with AF-S and AF-I lenses (AF-Assist Illuminator also does not turn on).

Focus Lock

Focus lock is useful in autofocus shooting when you want to capture a subject that's framed outside of the N55's three focus areas.

Tip

Focus lock is best suited for a photograph where composition is your top priority, and in situations where autofocus may not work as expected (page 27).



1 Position the focus area on the subject and lightly press the shutter release button. (For example, when center focus area is selected.)

- appears when the subject is in focus and the focus is locked as long as the shutter release button is kept lightly pressed.
- Focus lock cannot be used in .
- Focus is not locked with a moving subject. To lock focus on a stationary subject which has been moving, remove your finger from the shutter release button and lightly press the shutter release button again.



2 Confirm focus indicator ●, compose while lightly pressing the shutter release button and shoot.

- After you have locked focus, do not change the camera-to-subject distance.

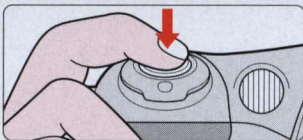

EXPOSURE MODE

This section describes how to take pictures in each exposure mode.

- Auto-Multi Program
- Shutter-Priority Auto
- Aperture-Priority Auto
- Manual

Auto-Multi Program



P: Auto-Multi Program

The camera automatically controls exposure to achieve correct exposure in any shooting situation. For more complex shooting, use Flexible Program (page 55), Exposure Compensation (page 64) or Auto Exposure Bracketing (page 66).

- **P** (Auto-Multi Program) can only be used with a CPU Nikkor lens such as G- or D-type Nikkor (page 88).



Tip

Auto-Multi Program is best suited for snapshots.

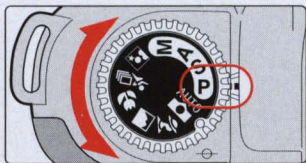

1 Set the exposure mode dial to **P**.

NOTE: CPU Nikkor lenses other than G-type

Always set the aperture ring of a CPU Nikkor lens (except G-type) to its minimum (largest f-number). When the lens is not set to its minimum aperture setting, **fEE** blinks in the LCD panel and viewfinder, and the shutter locks.

Difference between (AUTO mode) and P (Auto-Multi Program)

Although exposure controls are the same, with Auto-Multi Program, you can select functions such as Flexible Program, Exposure Compensation, Auto Exposure Bracketing, Multiple Exposure (page 69) or Slow Sync flash (page 78) for more flexible shooting. In Auto-Multi Program, however, the built-in Speedlight does not pop up automatically with a dark or backlit subject.

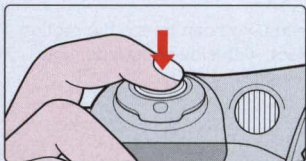

2 Compose picture, confirm focus indicator ● and shoot.

- When the subject is too dark or too bright, one of the following warning indications will appear in the viewfinder and LCD panel.
 - **H** **I**: Use ND filter (optional).
 - **L** **A**: Use Speedlight.
- If the subject is too dark or backlit, the flash recommended indication **⚡** blinks in the viewfinder when you lightly press the shutter release button. Use the Speedlight (page 80/91).

Flexible Program

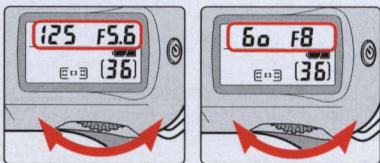

By rotating Command Dial in Auto-Multi Program, you can change the combination of shutter speed and aperture while maintaining correct exposure. With this function, you can shoot in Auto-Multi Program as though shooting in Shutter-Priority Auto or Aperture-Priority Auto. To cancel the

Flexible Program, either change the exposure mode, turn off the power switch, or use the built-in Speedlight (page 80).

Shutter-Priority Auto Exposure Mode



Fast shutter speed 1/500 sec.

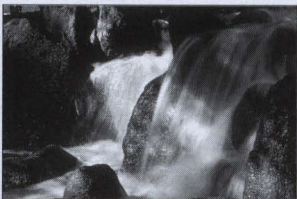

Slow shutter speed 1/4 sec.

S: Shutter-Priority Auto

Enables you to manually set the desired shutter speed (30-1/2000 sec.); the camera automatically selects the proper aperture to provide correct exposure.

- **S** (Shutter-Priority Auto) can only be used with a CPU Nikkor lens such as G- or D-type Nikkor (page 88).



Tip

With high shutter speeds, you can freeze the motion of a fast-moving subject; with slower speeds, you can create a motion effect.

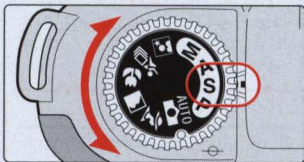

1

Set the exposure mode dial to **S**.

NOTE: CPU Nikkor lenses other than G-type

Always set the aperture ring of a CPU Nikkor lens (except G-type) to its minimum (largest f-number). When the lens is not set to its minimum aperture setting, **fE** blinks in the LCD panel and viewfinder, and the shutter locks.

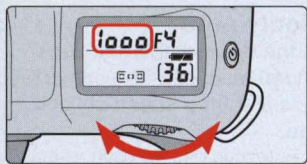

2 Set the shutter speed (30-1/2000 sec.) with the Command Dial.



3 Compose picture, confirm focus indicator ● and shoot.

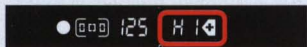

Overexposure

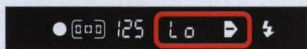

Underexposure

- When the subject is too dark or too bright, one of the following warning indications will appear in the viewfinder and LCD panel. (Over- or underexposure value is indicated with the electronic analog exposure display in the viewfinder.)
 - **H 1/4**: Select higher shutter speed. If the warning indication still remains on, use an ND filter (optional).
 - **L 1/4**: Select slower shutter speed. If the warning indication still remains on, use the Speedlight. When the Speedlight is used, fastest shutter speed is limited to 1/90 sec.
- If the subject is too dark or backlit, the flash recommended indication ⚡ blinks in the viewfinder when you lightly press the shutter release button. Use the Speedlight (page 80/91).

Check point

- If -- (Long Time exposure) is selected in Manual exposure mode and the exposure mode is changed to Shutter-Priority Auto without cancelling --, -- blinks and the shutter locks. To shoot in Shutter-Priority Auto exposure mode, select shutter speed other than -- by rotating the Command Dial.

Aperture-Priority Auto Exposure Mode



Small aperture $f/32$



Large aperture $f/2.8$

A: Aperture-Priority Auto

Enables you to set the desired aperture (lens' minimum to maximum) manually. The camera automatically selects a shutter speed suitable for correct exposure.

- **A** (Aperture-Priority Auto) can only be used with a CPU Nikkor lens such as G- or D-type Nikkor (page 88).
- In flash photography, varying the aperture changes the flash shooting distance (page 83).

Tip

By varying the aperture, and thus controlling the depth of field (page 86), you can sharpen the background and foreground, or blur the background.



1 Set the exposure mode dial to A.

NOTE: CPU Nikkor lenses other than G-type

Always set the aperture ring of a CPU Nikkor lens (except G-type) to its minimum (largest f-number). When the lens is not set to its minimum aperture setting, **fE** E blinks in the LCD panel and viewfinder, and the shutter locks.

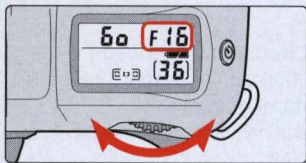

2 Set the aperture (lens' minimum to maximum) by rotating the Command Dial.

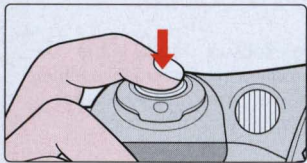

3 Compose picture, confirm focus indicator ● and shoot.

- When the subject is too dark or too bright, one of the following warning indications will appear in the viewfinder and LCD panel. (Over- or underexposure value is indicated with the electronic analog exposure display in the viewfinder.)
 - **H I**: Select smaller aperture (larger f-number). If the warning indication remains on, use an ND filter (optional).
 - **L O**: Select larger aperture (smaller f-number). If the warning indication remains on, use the Speedlight.
- If the subject is too dark or backlit, the flash recommended indication **⚡** blinks in the viewfinder when you lightly press the shutter release button. Use the Speedlight (page 80/91).

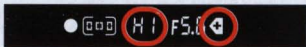

Overexposure

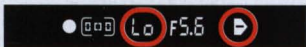

Underexposure

Manual Exposure Mode



M: Manual

Enables you to set both shutter speed (- - [Time] and 30-1/2000 sec.) and aperture (lens' minimum to maximum) manually.

- Non-CPU lenses (page 90) can only be used in Manual exposure mode.



Tip

With electronic analog exposure display in the viewfinder, you can produce various creative effects by adjusting the exposure. Long Time exposure (Time) can be set in Manual exposure mode.



1 Set the exposure mode dial to M.

- Metering system automatically switches to **Center Partial** from Matrix in Manual exposure mode.
- When a non-CPU Nikkor lens is attached, F- - appears in the LCD panel and viewfinder. Set/confirm aperture with the lens aperture ring. Camera's exposure meter cannot be used. See page 90 for details.

Center Partial Metering

Center Partial Metering places special emphasis on brightness around three focus areas in the center of the viewfinder and is thus useful for basing exposure on the center area of the scene.

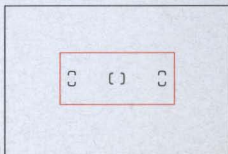

NOTE: CPU Nikkor lenses other than G-type

Always set the aperture ring of a CPU Nikkor lens (except G-type) to its minimum (largest f-number). When the lens is not set to its minimum aperture setting, **fE** blinks in the LCD panel and viewfinder, and the shutter locks.

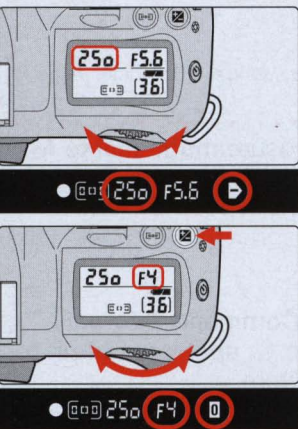

2 Set the shutter speed and aperture while checking the electronic analog exposure display in the viewfinder.

- Set the shutter speed (- - [Time] and 30-1/2000 sec.) by rotating the Command Dial and aperture (minimum to maximum) by rotating the Command Dial while pressing the aperture button.
- The electronic analog display in the viewfinder indicates the difference between the selected exposure (shutter speed and aperture) and the correct exposure. The electronic analog exposure display blinks when the subject brightness is beyond the camera's exposure range. (Electronic analog exposure display is not available with Long Time exposure.) The following examples show electronic analog exposure display indications:

	Over 1 EV
0	+1/2 EV
0	Correct exposure
0	-1/2 EV
	Under -1 EV



3 Compose picture, focus and shoot.

- If the subject is too dark or backlit, the flash recommended indication blinks in the viewfinder when you lightly press the shutter release button. Use the Speedlight (page 80/91).

Long Time Exposure

■ Long Time (Time) exposure of more than 30 sec.

When the exposure mode dial is set to M (Manual), set the shutter speed indication to -- (next after 30 sec.) to set Long Time (Time) exposure. Depress the shutter release button once to open the shutter, then press the shutter release button again to close the shutter. This function is useful for shooting nighttime scenes or stars.

Tip

In Long Time exposure, camera shake can be reduced by using the Self-Timer (page 42) and tripod.

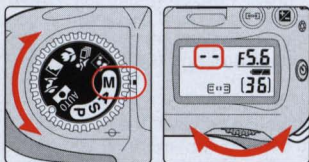

1 Set the exposure mode dial to **M** and rotate the Command Dial to set the shutter speed indication to --.

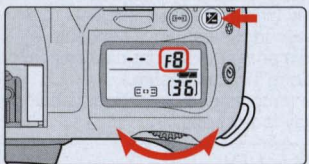

2 Rotate the Command Dial while pressing the  aperture button to set the aperture.

3 Compose picture, focus and shoot.

- Depressing the shutter release button once opens the shutter and the self-timer lamp flickers slightly during Long Time (Time) exposure.
- -- and other indications such as aperture are displayed in the LCD panel, but all the indications turn off in the viewfinder.
- Press the shutter release button again to close the shutter.
- Continuous exposure is possible for approx. 4 hours with a fresh set of batteries. Note that continuous exposure time is reduced when shooting in low temperatures.
- Auto Exposure Bracketing (page 66) cannot be performed during Long Time (Time) exposure.

ADVANCED OPERATION

This section features descriptions of operations using this camera's advanced functions.

- Exposure Compensation
- Auto Exposure Bracketing
- Multiple Exposure

Exposure Compensation

To modify exposure control (i.e. from the ISO standard), use the Exposure Compensation function. This can be useful when intentionally achieving under- or overexposure to obtain a specific photographic effect. This camera offers compensation of -2 EV to $+2$ EV in $1/2$ steps.

- Exposure Compensation can be set in **P**, **S**, **A** and Vari-Program.

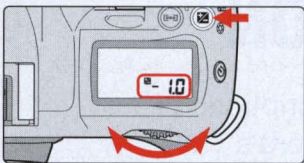

Tip

Compensate to the $+$ side to brighten, and the $-$ side to darken overall picture to obtain specific photographic effect.



Electronic analog exposure display

- 1 Set Exposure Compensation by rotating the Command Dial while pressing the  button until the desired compensation value appears (-2 EV to $+2$ EV in $1/2$ steps).

- When the Exposure Compensation is set,  appears in the LCD panel and viewfinder.
- The compensation value can be checked by pressing the  button. The electronic analog exposure display also appears as illustrated in the viewfinder when the  button is pressed.



No compensation



+0.5 EV compensation



-0.5 EV compensation



Over +1.0 EV compensation



Under -1.0 EV compensation

NOTE: Setting Exposure Compensation

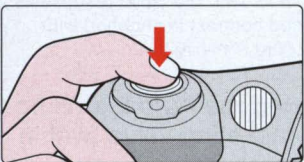

Normally, you should compensate exposure to the + side when the background is brighter than your main subject, or to the - side when the background is darker.



2 Compose picture, confirm focus indicator ● and shoot.

- To cancel Exposure Compensation, rotate the Command Dial while pressing the  button to reset the compensation value to 0.0. In Vari-Program, changing the exposure mode also cancels the Exposure Compensation. (Turning the power switch off does not cancel the Exposure Compensation.)

Check points

- The Exposure Compensation cannot be set in  or **M** exposure mode.
- Once the Exposure Compensation is set in each **P**, **S** or **A** exposure mode, compensation remains in that exposure mode. Changing the exposure mode to **M**,  or Vari-Program temporarily cancels the compensation.
- Exposure Compensation set in Vari-Program is canceled when exposure mode is changed.
- If the exposure compensation is set when the built-in Speedlight is used, the flash output level is also compensated.

Auto Exposure Bracketing

Auto Exposure Bracketing allows you to shoot in selected compensated EV values (maximum of ± 2 EV) shifting from the automatically set proper exposure (or selected exposure in Manual exposure mode) for three shots each time the shutter is released.

- Auto Exposure Bracketing is available in **P**, **S**, **A** and **M** exposure modes.



Tip

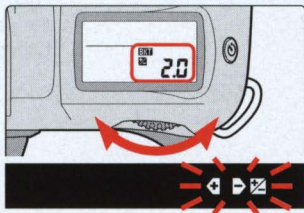
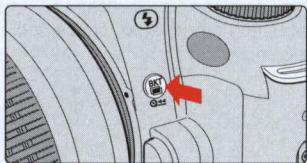

Bracketing is useful in selecting one shot out of several shots with bracketed exposures after processing the film, when the subject has pronounced contrast in shooting with color slide film and where the latitude of the proper exposure is minimal.

- 1 Rotate the Command Dial while pressing the Auto Exposure Bracketing  button to set desired bracketing value (within ± 2 EV without combining exposure compensation).



The display changes as follows:



- When the bracketing value is set (and while the exposure meter is on), **BKT** appears and  blinks in the LCD panel, and  and electronic analog exposure display blink in the viewfinder.
- Bracketing value can be confirmed by pressing the  button.

- Shutter speed and aperture in P, aperture in S and shutter speed in A and M exposure mode are bracketed.
- In any of the exposure modes, both flash output level for the flash illuminated subject and exposure on the background are bracketed when a Speedlight is used.

■ Compensated EV value and bracketing order

Compensated EV value	Bracketing order
0.5	0, -0.5, +0.5
1.0	0, -1.0, +1.0
1.5	0, -1.5, +1.5
2.0	0, -2.0, +2.0

2 Compose picture, confirm focus indicator ● and shoot.

- Each time the shutter release button is depressed, correct EV, under EV, and over EV exposure are performed in that order while the blinking electronic analog exposure display shows the correct, under-, then overexposure. Compensated shutter speed and aperture values are displayed during shooting.
- If the Exposure Compensation function (page 64) is also set, bracketing will be combined with the Exposure Compensation values. It is useful to perform Bracketing with a compensated value of over +2 EV or under -2 EV (maximum of ± 4 EV).
- If the end of the film roll is reached during bracketing, the remaining shots can be taken after new film has been loaded. Also, if you turn the power switch off during bracketing, the remaining shots can be taken after the power is turned back on.

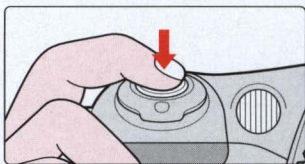

Electronic analog exposure display

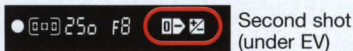

Auto Exposure Bracketing—continued

3 Auto Exposure Bracketing is completed and automatically canceled when the third shot is taken.

- **BKT** and **☑** in the LCD panel and **☑** and the electronic analog exposure display in the viewfinder disappear when the bracketing is completed.
- To cancel the bracketing, rotate the Command Dial while pressing the **OK** button so **BKT** disappears from the LCD panel. Turning the power switch off does not cancel bracketing.



Check points

- Auto Exposure Bracketing cannot be performed in **AUTO** and Vari-Program.
- Auto Exposure Bracketing and Multiple Exposure (page 69) cannot be set simultaneously.
- Auto Exposure Bracketing and Long Time exposure (page 62) cannot be set simultaneously.

Multiple Exposure

Multiple Exposure consists of two or more exposures of one or more subjects in the same frame.

Multiple Exposure can be set in **P**, **S**, **A** and **M** exposure modes.

- 1 Rotate the Command Dial while pressing the multiple exposure  button so  appears in the LCD panel. The display changes as follows:

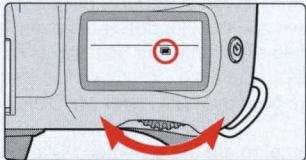
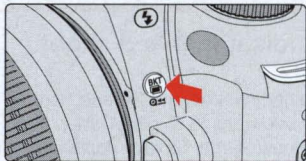

-  appears in the LCD panel when the Multiple Exposure is set.

- 2 Rotate the Command Dial while pressing the  button to set the necessary Exposure Compensation.

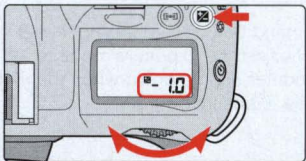

- Test shooting is recommended since the compensation actually required varies depending on the shooting situation.
- When the background is completely dark and subjects do not overlap, no compensation is necessary for each shot.
- In some cases, frames may shift slightly in multiple exposure. In particular, film advance becomes unstable at the beginning and near the end of a film roll so multiple exposure is not recommended.

Multiple Exposure—continued

Standard compensation value in multiple exposure

Number of exposures	Compensation value
Two	-1.0 EV
Three	-1.5 EV
Four	-2.0 EV
Eight or nine	-3.0 EV

Exposure Compensation is necessary depending on the number of exposures in multiple exposure since more than one image is exposed in the same frame.

3 Compose picture, confirm focus indicator ● and shoot.

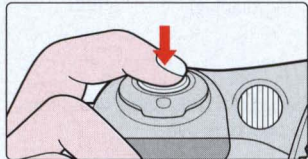

- The first shot is taken and and frame counter blink in the LCD panel when the shutter release button is fully depressed. The frame counter in the LCD panel does not count down and the film does not advance, and multiple exposures can be taken from the second shutter release. The multiple exposure

is canceled, film advances and disappears from the LCD panel when the second shot is taken.

- To take more than two shots on the same frame, rotate the Command Dial while pressing the button again after the first shot is taken by depressing the shutter release button and while is blinking so appears without blinking. Repeat this operation as many times as you wish to continue taking pictures on the same frame.
- To cancel multiple exposure, rotate the Command Dial while pressing the button so disappears from the LCD panel or set the exposure mode to or Vari-Program. Film is advanced and frame counter counts down when the multiple exposure is canceled before or during multiple exposure operation.

Check points

- Multiple Exposure cannot be performed in the or Vari-Program.
- Multiple Exposure and Auto Exposure Bracketing (page 66) cannot be set simultaneously.

OTHER FUNCTIONS

This section describes other useful camera functions and information.







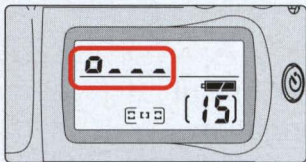
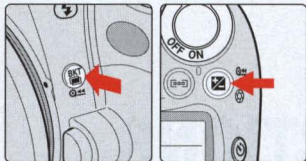

- Film rewind
- Diopter adjustment/Viewfinder accessories
- Available mode combinations

Film Rewind

This section explains mid-roll rewind and what to do if the film does not rewind.



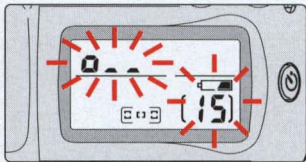

Mid-roll rewind

- To rewind film at mid-roll, press the two film rewind buttons  simultaneously for approx. 1 sec.
- , ,  and then  appear in the LCD panel during film rewind and the frame counter counts backwards until rewind is complete.
- Film is completely rewound when a blinking  shows in the frame counter. ( appears without blinking when the exposure meter is off.) Make sure  is blinking, open the camera back and remove the film cartridge.



If film does not start to rewind or film rewind stops at mid-roll

- When battery power is very low, or at low temperatures, film may not start rewinding or film rewind may stop at mid-roll, and , frame number and insufficient battery power indication  will blink in the LCD panel. In this case, turn the power switch off, change batteries, then turn the power switch on and press the two film rewind buttons  simultaneously for approx. 1 sec. to rewind film again.

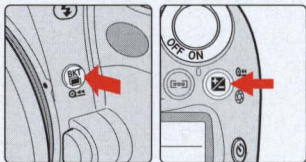

Diopter Adjustment/Viewfinder Accessories

The N55 enables near- or far-sighted photographers to adjust the eyepiece diopter to suit their vision. Viewfinder accessories such as an eyepiece cap or eyepiece correction lens can also be attached.

Diopter adjustment

Remove the rubber eyecup and slide the diopter adjustment lever while looking through the viewfinder until the focus brackets or other displays in the viewfinder appear sharp. Attach the rubber eyecup again after adjustment.

The adjustable range of the finder diopter is $-1.5m^{-1}$ to $+0.8m^{-1}$. Nine optional eyepiece correction lenses provide a viewfinder diopter range of $-5m^{-1}$ to $+3m^{-1}$ (page 98).

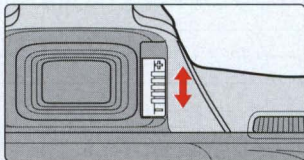
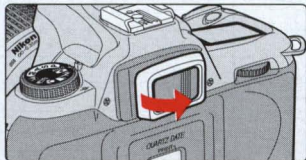

NOTE: Using the diopter adjustment lever

Since the diopter adjustment lever is located next to the viewfinder, be careful not to poke yourself in the eye with your finger or fingernail while sliding the lever.

Attaching viewfinder accessories





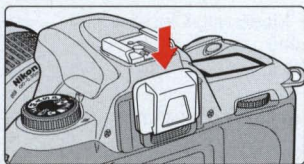
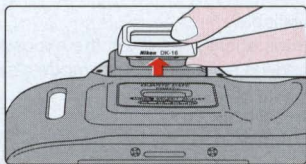

To attach an eyepiece cap or eyepiece correction lens, remove the rubber eyecup and slide down the eyepiece cap or eyepiece correction lens.







To reattach the rubber eyecup after removing the eyepiece cap or eyepiece correction lens, make sure the “**Nikon DK-16**” stamp is at the bottom.



Available Mode Combinations

The following chart lists available modes when a CPU Nikkor lens such as a G- or D-type lens is attached.

Exposure mode	AF-Assist Illuminator	Flexible Program	Exposure compensation	Auto Exposure Bracketing	Multiple exposure
	○	—	—	—	—
	○	—	○	—	—
	—	—	○	—	—
	○	—	○	—	—
	—	—	○	—	—
	○	—	○	—	—
P	○	○	○	○	○
S	○	—	○	○	○
A	○	—	○	○	○
M	○	—	—	○	○

Exposure mode	Metering system	Film advance mode	Focus mode		
			AF		MF
			①	②	③
	Matrix	Single frame	⊙	○	○
	Matrix	Single frame	⊙	○	○
	Matrix	Single frame	⊙	○	○
	Matrix	Single frame	○	⊙ (Center)	○
	Matrix	Continuous*	⊙	○	○
	Matrix	Single frame	⊙	○	○
P	Matrix	Single frame	○	○	○
S	Matrix	Single frame	○	○	○
A	Matrix	Single frame	○	○	○
M	Center Partial	Single frame	○	○	○

①: Dynamic AF Mode with Closest-Subject Priority

②: Dynamic AF Mode

③: Single Area Mode

* Single frame with use of built-in Speedlight.

○: Available

⊙: Automatically set when the exposure mode is selected. (Other mode also selectable.)

—: Unavailable



FLASH PHOTOGRAPHY

This section introduces various aspects of flash photography using the built-in Speedlight.

- Built-in Speedlight (Matrix Balanced Fill-Flash, Standard TTL Flash)/Ready-light
- Flash sync mode features
- Using built-in Speedlight

Built-In Speedlight/Ready-Light

■ Built-in Speedlight and TTL Flash modes

This camera is equipped with a built-in Speedlight that provides an angle of coverage for a 28mm lens with a guide number of 12 (ISO 100, m) or 40 (ISO 100, ft.). When the subject is dark or backlit, in  or Vari-Program (except in  or ) the built-in Speedlight automatically pops up. When the shutter is released, the flash fires to create natural-looking flash photography utilising **Matrix Balanced Fill-Flash**.

In **P**, **S**, **A** or **M** exposure mode, when the subject is dark or backlit, flash recommended indication  blinks in the viewfinder, and the Speedlight pops up when the Speedlight lock-release button is pressed and the **Matrix Balanced Fill-Flash** is possible. (In **M** exposure mode, **Standard TTL Flash** is selected.) In addition to shooting in dim light, the flash can be used in daylight to reduce shadows on the main subject or to put catchlights in your subject's eyes.

Four flash sync modes—**Front-Curtain Sync** (Normal Sync), **Slow Sync**, **Red-Eye Reduction** and **Red-Eye Reduction with Slow Sync**—are available with this camera.

- See below for the TTL Flash modes, page 80 for using the built-in Speedlight and page 78 for the flash sync modes.

Matrix Balanced Fill-Flash





- Matrix Balanced Fill-Flash is automatically set in , Vari-Program, **P**, **S** or **A** exposure mode. In this flash mode, a well-balanced exposure of the main subject (subject in focus) and the background is achieved—based on the brightness sensed by the Matrix Metering.

Standard TTL Flash



- Standard TTL Flash is automatically selected when the exposure mode is set to **M**. In Standard TTL Flash, the main subject is correctly exposed but background exposure is not considered. Standard TTL Flash is useful when you want to highlight the main subject.

Ready-light

A black rectangular area representing a camera's LCD display. From left to right, it shows a white circle with a square inside, the number '90', and 'F5.6'. To the right of these is a white lightning bolt icon (the ready-light) enclosed within a red circle.

- When using the built-in Speedlight or an optional Speedlight (p. 91), the ready-light  appears in the viewfinder when the Speedlight is fully charged and ready to fire.
- If the ready-light  blinks approx. 3 sec. after full flash output, underexposure may have occurred (when using built-in Speedlight or optional Speedlight set to non-TTL Auto Flash mode). Check the focus distance, aperture or flash shooting distance range and shoot again.
- When the optional Speedlight is set to TTL and the shutter release button is lightly pressed, the ready-light  in the viewfinder blinks to indicate that the flash will be fired at full output. Make sure to set the optional Speedlight to A (non-TTL Auto Flash) or M (Manual Flash) mode.



Flash Sync Mode Features

Five flash sync modes can be selected for desired photographic effect depending on the conditions when using the built-in Speedlight. In  and  modes, flash is not available even when the subject is dark or backlit.

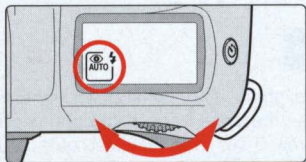
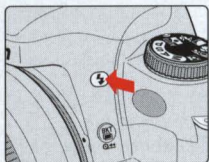
Set the flash sync mode by rotating the Command Dial while pressing the flash sync mode button .





: Front-Curtain Sync (Normal Sync)

Set the flash sync mode to Front-Curtain Sync for normal flash photography. The camera's shutter speed is automatically set to 1/90 sec. for flash photography in , , , **P** or **A** exposure mode.





: Slow Sync

Slow Sync can be used in , **P** or **A** exposure mode. Normally, the camera's shutter speed is automatically set to 1/90 sec. for flash photography. However, for shooting nighttime scenes, Slow Sync uses a slower shutter speed (down to maximum of 30 sec., 1 sec. in ) to bring out background details using all of the available light.





: Red-Eye Reduction

The Red-Eye Reduction lamp lights for approx. 1 sec. before the flash fires in order to reduce the red-eye effect in photos of people or animals. Red-Eye Reduction can be used in , Vari-Program (except for  and ) , **P**, **S**, **A**, or **M** exposure mode.









: Red-Eye Reduction with Slow Sync

Red-Eye Reduction with Slow Sync can be used in , **P** or **A** exposure mode. Red-Eye Reduction and Slow Sync mode are simultaneously set.



: Flash Cancel

Flash Cancel can only be selected in  or Vari-Program (except for  and ) with the Command Dial and  button. Set Flash Cancel when you want to cancel the flash and have the photograph exposed only with the natural light. Flash Cancel cannot be set when the built-in Speedlight is in the up position. Set the Flash Cancel before lightly pressing the shutter release button.





- If  or  is set when the built-in Speedlight is in the up position, flash is automatically canceled.

NOTE: Flash Sync Modes

- In Front-Curtain Sync, shutter speed shifts automatically to 1/90 sec. when the shutter speed is set to faster than 1/90 sec. in S or M exposure mode.
- When Red-Eye Reduction or Red-Eye Reduction with Slow Sync is selected, the Red-Eye Reduction lamp lights for approx. 1 sec. before the flash fires. Do not move the camera or let the subject move until the shutter is released. (Red-Eye Reduction is not recommended in shooting situations where shutter release is your top priority.)
- With some lenses, light from the Red-Eye Reduction lamp may not reach the subject's eyes. In some cases, the red-eye effect may not be sufficiently reduced due to the location of subject.
- With Slow Sync and Red-Eye Reduction with Slow Sync, keep the camera steady to prevent picture blur since the shutter speed is slow. Use of a tripod is recommended.

Using Built-In Speedlight



This section explains how to use the built-in Speedlight set to desired flash sync mode when a G- or D-type AF Nikkor lens is attached.

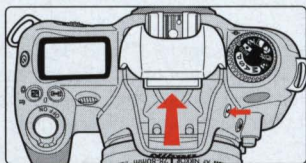



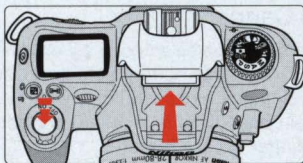



- 1** In P, S, A or M exposure mode, release the built-in Speedlight by pressing the  flash lock-release button. In  or Vari-Program (except in  or ), when the subject is dark or backlit and the shutter release button is lightly pressed, the built-in Speedlight automatically pops up.



In P, S, A or M exposure mode







In  or Vari-Program (except  or )

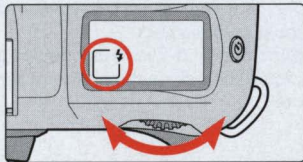
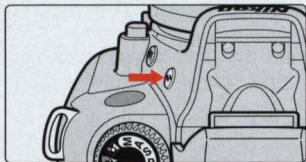



- When the subject is dark or backlit and shutter release button is lightly pressed, the flash recommended indication  blinks in the viewfinder in P, S, A or M exposure mode. To use built-in Speedlight, press the  flash lock-release button.
- In ,  or ,  is displayed in the LCD panel; in ,  is displayed.
- When the Speedlight is ready to fire,  appears without blinking in the viewfinder (when the camera's meter is on).
- Press the Speedlight down gently until it clicks into place to retract it.

- 2** Set the flash sync mode by rotating the Command Dial while pressing the  flash sync button.



- If  or  is set when the built-in Speedlight is in the up position, flash is automatically canceled.
- **Matrix Balanced Fill-Flash** is selected in exposure modes other than **M** and **Standard TTL Flash** is selected for **M** exposure mode. See page 76 for details.
- See the table on pages 82, 83 and 84 for shutter speed and aperture, available sync mode in each exposure mode.
- In **P**, **S**, **A** or **M** exposure mode, selected flash sync mode remains once it is set. To change the flash sync mode, rotate the Command Dial while pressing the  button to select another flash sync mode.
- In  or Vari-Program, turning the power switch off or selecting another exposure mode cancels the selected flash sync mode and returns to its initial setting.

■ Rotating the Command Dial while pressing the  button changes the display as follows.

In  or Vari-Program (except ,  or ):



In :



In **P** or **A** exposure mode:

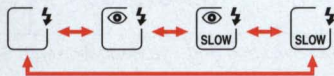

In **S** or **M** exposure mode:





*  cannot be set when the built-in Speedlight is up.



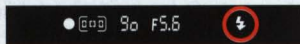

Using Built-In Speedlight—continued

3 Confirm  appears in the viewfinder, make sure the subject is within the flash shooting distance range and shoot.



- The shutter cannot be released unless  appears without blinking in the viewfinder.
-  in the viewfinder blinks approx. 3 sec. after full flash output. This may indicate underexposure has occurred. Check the focus distance, aperture or flash shooting distance range and shoot again.
- When the subject is dark, the AF-Assist Illuminator automatically turns on to guide autofocus. See page 50 for details.

■ Available shutter speed and aperture in each exposure mode

Exposure mode	Available shutter speed	Available aperture	Page
	Automatically set to 1/90 sec.	Automatically set	28
			37
			38
	Automatically set to 1/90-1 sec.		39
P	Automatically set to 1/90 sec.*1		54
S	1/90-30 sec.*2		56
A	Automatically set to 1/90 sec.*1	Desired setting*3	58
M	1/90-30 sec.*2, -- (Time)		60

*1 Shutter speed is prolonged up to 30 sec. with Slow Sync and Red-Eye Reduction with Slow Sync.

*2 Shutter speed shifts automatically to 1/90 sec. when the shutter speed is set to faster than 1/90 sec. and the built-in Speedlight pops up.

*3 Flash shooting distance range depends on the ISO speed of the film in use and aperture setting. In A or M exposure mode, set the aperture according to the flash shooting distance range table on the next page.

Flash shooting distance range

Flash shooting distance for the built-in Speedlight changes according to the film speed in use and aperture setting.

ISO film speed	25	50	100	200	400	800	Flash shooting distance range (m/ft.)
Guide number (m/ft.)	6/20	8.5/28	12/40	17/56	24/79	34/122	
Aperture value	—	—	1.4	2	2.8	4	2-8.5/6.6-28
	—	1.4	2	2.8	4	5.6	1.4-6/4.6-20
	1.4	2	2.8	4	5.6	8	1-4.2/3.3-14
	2	2.8	4	5.6	8	11	0.7-3/2.3-9.8
	2.8	4	5.6	8	11	16	0.6-2.1/2.0-6.9
	4	5.6	8	11	16	22	0.6-1.5/2.0-4.9
	5.6	8	11	16	22	32	0.6-1.1/2.0-3.6
8	11	16	22	32	—	0.6-0.8/2.0-2.6	







- The maximum flash shooting distance can also be calculated by dividing the guide number by the selected aperture value.

Example: When f/2.8 is selected with ISO 100 film using the camera's built-in Speedlight, the maximum flash shooting distance will be:

$$12/2.8 = \text{approx. } 4.2\text{m or } 40/2.8 = \text{approx. } 14 \text{ ft.}$$

Using Built-In Speedlight—continued

Available flash sync mode combinations

Exposure mode	TTL Auto Flash	Front-Curtain Sync	Red-Eye Reduction	Red-Eye Reduction with Slow Sync	Slow Sync	Flash Cancel
ALTO 	①	⊙	○	—	—	○*1
	①	⊙	○	—	—	○*1
	—	—	—	—	—	⊙*2
	①	⊙	○	—	—	○*1
	—	—	—	—	—	⊙*2
	①	—	—	○	⊙	○*1
P	①	○	○	○	○	—
S	①	○	○	—	—	—
A	①	○	○	○	○	—
M	②	○	○	—	—	—

①: Matrix Balanced Fill-Flash

②: Standard TTL flash

○: Available

⊙: Automatically set when the exposure mode is selected. (Other flash sync mode also selectable.)

—: Unavailable

*1 Selectable when built-in Speedlight is retracted.

*2 Flash is automatically canceled if  or  is selected when built-in Speedlight is up.

Usable lenses with built-in Speedlight

28mm to 200mm non-zoom CPU Nikkor lenses, AF 300mm f/4 ED and AF-S 300mm f/4 ED lenses can be used with the built-in Speedlight.

NOTE: Using built-in Speedlight

- Make sure to remove the lens hood.
- The built-in Speedlight cannot be used with zoom lenses set to Macro in wideangle.
- AF-S 17-35mm f/2.8 ED, AF 18-35mm f/3.5-4.5 ED, AF 20-35mm f/2.8 zoom lenses cannot be used with the built-in Speedlight.

Vignetting occurs at the edges of the frame resulting in underexposure with the following lenses, which have limitations in usable focal length or shooting distance. Vignetting is reduced, however, with regular color print film compared to color slide film since the edges of the frame are cropped out in film processing with color print film.

With standard color print film

Lens	Limitations
AF 24-85mm f/2.8-4	35mm or longer focal length; and at 35mm, 1.5m (4.9 ft.) or longer shooting distance; at 50mm, 1m (3.3 ft.) or longer shooting distance
AF 24-120mm f/3.5-5.6	35mm or longer focal length; and at 35mm, 1m (3.3 ft.) or longer shooting distance
AF 28mm f/1.4	1.5m (4.9 ft.) or longer shooting distance
AF-S 28-70mm f/2.8 ED	70mm focal length
AF 28-80mm f/3.5-5.6	At 28mm, 1m (3.3 ft.) or longer shooting distance
AF 28-105mm f/3.5-4.5	
AF 28-200mm f/3.5-5.6	35mm or longer focal length, and at 35mm, 2m (6.6 ft.) or longer shooting distance
AF 35-70mm f/2.8	At 35mm, 2.5m (8.2 ft.) or longer shooting distance
AF Micro 70-180mm f/4.5-5.6 ED	At 70-85mm, 1m (3.3 ft.) or longer shooting distance
AF-S 80-200mm f/2.8 ED	105mm or longer focal length

With color slide film

Lens	Limitations
AF 24-50mm f/3.3-4.5	35mm or longer focal length
AF 24-85mm f/2.8-4	35mm or longer focal length; and at 35mm, 2.5m (8.2 ft.) or longer shooting distance; at 50mm, 1m (3.3 ft.) or longer shooting distance
AF 24-120mm f/3.5-5.6	35mm or longer focal length; and at 35mm, 1.5m (4.9 ft.) or longer shooting distance
AF 28mm f/1.4	2m (6.6 ft.) or longer shooting distance
AF-S 28-70mm f/2.8 ED	70mm focal length
AF 28-70mm f/3.5-4.5	At 28mm, 1m (3.3 ft.) or longer shooting distance
AF 28-80mm f/3.3-5.6G	
AF 28-80mm f/3.5-5.6	At 28mm, 1.5m (4.9 ft.) or longer shooting distance
AF 28-105mm f/3.5-4.5	
AF 28-200mm f/3.5-5.6	35mm or longer focal length; and at 35mm, 2.5m (8.2 ft.) or longer shooting distance
AF 35-70mm f/2.8	50mm or longer focal length
AF Micro 70-180mm f/4.5-5.6 ED	At 70mm, 1.5m (4.9 ft.) or longer shooting distance; at 85-105mm, 1m (3.3 ft.) or longer shooting distance
AF-S 80-200mm f/2.8 ED	105mm or longer focal length

About Depth of Field

Basics of the relationship between focus and depth of field are explained in this section.

■ Depth of field

When focusing, depth of field should be considered. Depth of field is the zone of sharpest focus in front of and behind the subject on which the lens is focused. It varies according to shooting distance, focal length and, above all, aperture. Smaller apertures (larger f-numbers) will produce a deeper depth of field where the background and foreground become sharper; larger apertures (smaller f-numbers) will produce a shallower depth of field where the background becomes blurred. Similarly, shorter shooting distance or longer focal length will produce a shallower depth of field, and longer shooting distance or shorter focal length will produce a deeper depth of field. Note that depth of field tends to be shallower in front of and deeper behind the subject in focus.



Large aperture f/2.8

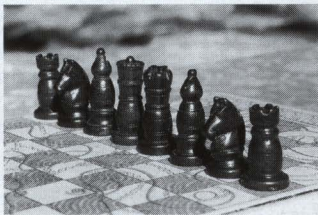

Small aperture f/32



MISCELLANEOUS

This section explains miscellaneous information.

- Lens compatibility
- Usable optional Speedlights
- Optional accessories
- Camera care
- Notes on batteries
- Troubleshooting
- Glossary
- Specifications
- Index

Lens Compatibility

Use a CPU Nikkor lens (except IX-Nikkor) with this camera. G- or D-type AF lenses give you access to all available functions. (This camera is not compatible with the Vibration Reduction function of the VR Nikkor lens and autofocus function of the AF-S and AF-I lens.)

Mode Lens/accessories		Focus mode			Exposure mode		Metering system		
		Autofocus	Manual with electronic rangefinder	Manual	Any mode other than M	M	Matrix		Center Partial*1
							3D 5-segment	5-segment	
CPU Nikkor*2	G-type AF Nikkor, D-type AF Nikkor*3	○	○	○	○	○	○	—	○
	AF-S, AF-I Nikkor	—	○	○	○	○	○	—	○
	PC Micro-Nikkor 85mm f/2.8D*4	—	○*5	○	—	○	—	—	○
	AF-S/AF-I Teleconverter*6	—	○*7	○	○	○	—	○	○
	Non-G or D-type AF Nikkor (except AF Nikkor for F3AF)	○	○	○	○	○	—	○	○
	AI-P Nikkor	—	○*8	○	○	○	—	○	○
Non-CPU Nikkor*9	AI-S or AI type Nikkor, Series-E, AI-modified Nikkor	—	○*8	○	—	○*10	—	—	—
	Medical-Nikkor 120mm f/4	—	○	○	—	○*11	—	—	—
	Reflex-Nikkor	—	—	○	—	○*10	—	—	—
	PC-Nikkor	—	○*5	○	—	○*10	—	—	—
	AI-S or AI type Teleconverters	—	○*7	○	—	○*10	—	—	—
	Bellows Focusing Attachment PB-6*12	—	○*7	○	—	○*10	—	—	—
Auto Extension Rings (PK-11A, PK-12, PK-13 and PN-11)	—	○*7	○	—	○*10	—	—	—	

- *1 Metering system automatically switches to Center Partial Metering when the exposure mode is set to Manual.
- *2 IX-Nikkor lenses cannot be attached.
- *3 This camera is not compatible with the Vibration Reduction function of the VR Nikkor lens.
- *4 The camera's exposure metering and flash control system do not work properly when shifting and/or tilting the lens, or when using an aperture other than the maximum aperture.
- *5 Without shifting and/or tilting the lens.
- *6 Compatible with AF-S and AF-I Nikkor except AF-S 17-35mm f/2.8D IF-ED and AF-S 28-70mm f/2.8D IF-ED.
- *7 With maximum effective aperture of f/5.6 or faster.
- *8 With maximum aperture of f/5.6 or faster.
- *9 Some lenses/accessories cannot be attached. (See page 90.)
- *10 With exposure mode set to Manual. The exposure meter cannot be used.
- *11 With exposure mode set to Manual and shutter speed set to 1/90 sec. or slower, the exposure meter cannot be used.
- *12 Attach the PB-6 vertically. (PB-6 can be set to horizontal position after attaching.)
 - AS-15 must be attached in combination with Medical-Nikkor 200mm f/5.6 for the lens to fire the flash.
 - Reprocopy Outfit PF-4 can be attached in combination with Camera Holder PA-4.

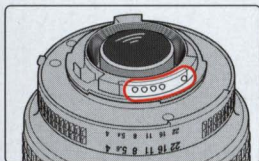

CPU contacts of CPU
Nikkor lens

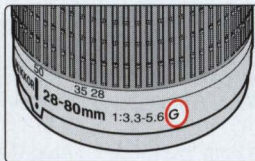

G-type Nikkor lens

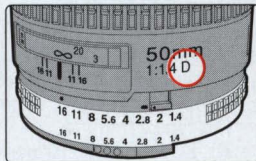

D-type Nikkor lens

G-type Nikkor and other CPU Nikkor lens (page 19)

- The G-type Nikkor lens has no aperture ring; aperture should be selected from the camera body. Unlike other CPU Nikkor lenses, aperture does not need to be set to minimum (largest f-number).
- CPU Nikkor lenses other than G-type Nikkor lens have an aperture ring. Set the lens aperture to its minimum and lock. When the lens is not set to its minimum aperture setting and the power switch is turned on, $f\bar{E}\bar{E}$ blinks in the LCD panel and viewfinder and the shutter cannot be released.

Lens Compatibility—continued

When a non-CPU lens is attached

Set exposure mode to M with a non-CPU lens. (When other modes are selected, shutter cannot be released.) The camera's exposure meter cannot be used and the aperture cannot be set using the Command Dial when using non-CPU lenses. F - - appears in place of the aperture indication in the LCD panel and viewfinder; set/confirm aperture using the lens aperture ring.

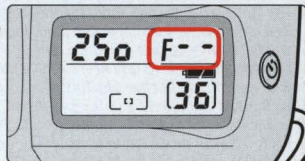

CAUTION: Nikkor lenses/accessories that cannot be attached to the N55

The following non-CPU Nikkor lenses/accessories cannot be attached to the N55 (otherwise camera body or lens may be damaged):

- TC-16A Teleconverter
- Non-AI lenses
- 400mm f/4.5, 600mm f/5.6, 800mm f/8 and 1200mm f/11 with Focusing Unit AU-1
- Fisheye 6mm f/5.6, 7.5mm f/5.6, 8mm f/8 and OP 10mm f/5.6
- Old-type 21mm f/4
- K1, K2 Ring, Auto Extension Ring PK-1, PK-11, Auto Ring BR-2, BR-4
- ED 180-600mm f/8 (No. 174041-174180)
- ED 360-1200mm f/11 (No. 174031-174127)
- 200-600mm f/9.5 (No. 280001-300490)
- 80mm f/2.8, 200mm f/3.5 and TC-16 Teleconverter for F3AF
- PC 28mm f/4 (No. 180900 or smaller)
- PC 35mm f/2.8 (No. 851001-906200)
- Old-type PC 35mm f/3.5
- Old-type Reflex 1000mm f/6.3
- Reflex 1000mm f/11 (No. 142361-143000)
- Reflex 2000mm f/11 (No. 200111-200310)

Usable Optional Speedlights

Usable optional Speedlights and available flash modes are listed in the following table. Available modes are listed assuming a CPU lens is attached.

Speedlight	Flash mode	Non-TTL Auto Flash	Manual Flash
SB-29*1, SB-28, SB-27, SB-26, SB-25, SB-24, SB-22, SB-22s, SB-20, SB-16B, SB-15, SB-14, SB-11, SB-140*2		○	○
SB-21B*1		—	○

- *Standby mode of optional Speedlight cannot be used. Make sure to cancel standby mode.*
- *TTL Auto Flash cannot be used. Set the Speedlight to A (non-TTL Auto Flash) or M (Manual Flash).*
- *SB-28DX, SB-50DX and SB-23 cannot be used.*
- **1 Autofocus is only available with AF Micro lens (60mm, 105mm, 200mm or 70-180mm).*
- **2 Ultraviolet photography can be performed only when SB-140 is set to M. (Infrared photography cannot be performed.)*

MISCELLANEOUS

Accessory shoe

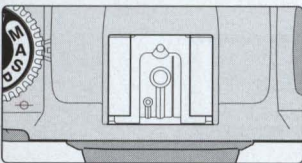

- An optional Speedlight, i.e. SB-28, SB-27 or SB-22s can be attached directly to the accessory shoe of the N55 without a cord. This accessory shoe is equipped with a safety lock which prevents accidental drop when a Speedlight with a safety-lock pin (SB-28, SB-27, SB-26, SB-25 or SB-22s) is attached.

Usable Optional Speedlights—continued

Flash photography can be performed using an optional Speedlight attached to the accessory shoe of this camera (Non-TTL Auto Flash using the optional Speedlight's light sensor). It is useful in situations such as when the camera's built-in Speedlight does not reach the subject. See your Speedlight manual for details on operation.

■ Non-TTL Auto Flash using optional Speedlight

- 1 Attach the optional Speedlight to the accessory shoe of the camera. Turn the camera power switch on and set the exposure mode dial to A or M.

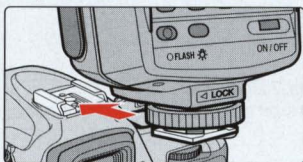

- Programmed Auto Flash is performed when the exposure mode dial is set to  AUTO, Vari-Program, P or S. See page 95 for details.

- 2 Turn the optional Speedlight on and set the flash mode to A (Non-TTL Auto Flash).

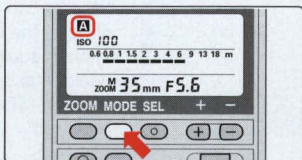
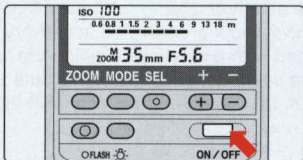

- In A exposure mode, the shutter speed is automatically set to 1/90 sec. In M exposure mode, the shutter speed is automatically set to 1/90 sec. when a shutter speed faster than 1/90 sec. is selected.
-  appears in the viewfinder when the optional Speedlight is fully charged (when the camera meter is on).

NOTE: Standby function of optional Speedlight

Make sure to cancel the standby mode of the optional Speedlight.

NOTE: Flash mode with optional Speedlight

Only A (Non-TTL Auto Flash) and M (Manual Flash) modes are available with the optional Speedlight. Proper flash operation cannot be performed when the flash mode is set to TTL Auto Flash. When the optional Speedlight is set to TTL Auto Flash and the shutter release button is lightly pressed, ζ blinks in the viewfinder to warn that flash synchronization is not being performed and the optional Speedlight will fire at full output. See your Speedlight manual for details on Manual Flash.

3 Compose picture and set aperture so that the subject is located within the flash shooting distance.

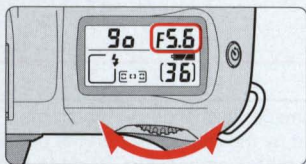

4 Set ISO film speed, aperture and zoom-head position of the optional Speedlight according to camera's ISO film speed, aperture and focal length (zoom position).

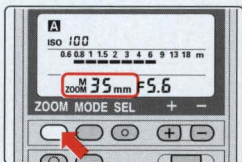
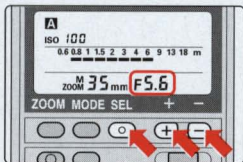
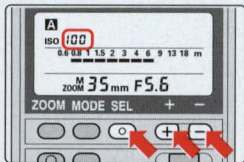

- Automatic power zoom of the optional Speedlight does not function. Always set the zoom-head position manually.

Usable Optional Speedlights—continued

5 Confirm  appears in the viewfinder, focus and fully depress the shutter release button to shoot.

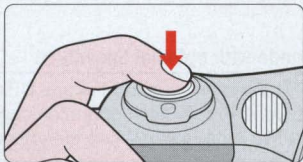
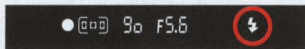

-  in the viewfinder blinks approx. 3 sec. after full flash output. This may indicate underexposure has occurred. Check the focus distance, aperture or flash shooting distance range and shoot again.
- When the subject is dark, the camera's AF-Assist Illuminator automatically turns on to guide autofocus (the Speedlight's AF-Assist Illuminator does not turn on). See page 50 for details.

Non-TTL Auto Flash

In Non-TTL Auto Flash shooting, light output automatically changes to match the flash-to-subject distance, but the light is measured by the light sensor on the optional Speedlight instead of being measured through the lens. Compared to TTL Auto Flash of the built-in Speedlight, where the light is measured through the lens, the control of the flash output level is somewhat less accurate.

■ Programmed Flash mode







When the optional Speedlight is attached with the flash mode set to A (Non-TTL Auto Flash) and the exposure mode dial is set to , Vari-Program, P or S, Programmed Flash is performed (camera aperture is automatically controlled according to the film speed).



- When an optional Speedlight is attached and the camera power switch is turned on, the camera automatically selects the aperture according to the film speed. Set the aperture on the Speedlight according to the aperture indicated on the camera.

ISO film speed	25	50	100	200	400	800
Aperture	2	2.8	4	5.6	8	11

- * One EV change in the film speed changes aperture by one EV. If the film speed of the film in use is an intermediate value of the film speed indicated in the table, the aperture changes accordingly. If the controlled aperture is darker than maximum aperture, maximum aperture of the attached lens is selected.
- See “Non-TTL Auto Flash using optional Speedlight” on page 92 for the operation other than setting the aperture.

■ Available flash sync mode with optional Speedlight

Exposure mode	Front-Curtain Sync	Red-Eye Reduction	Red-Eye Reduction with Slow Sync	Slow Sync	Flash Cancel
	<input type="radio"/>	<input type="radio"/>	—	—	—
	<input type="radio"/>	<input type="radio"/>	—	—	—
 *	<input type="radio"/>	<input type="radio"/>	—	—	—
	<input type="radio"/>	<input type="radio"/>	—	—	—
 *	<input type="radio"/>	<input type="radio"/>	—	—	—
	<input type="radio"/>	<input type="radio"/>	—	—	—
P	<input type="radio"/>	<input type="radio"/>	—	—	—
S	<input type="radio"/>	<input type="radio"/>	—	—	—
A	<input type="radio"/>	<input type="radio"/>	<input type="radio"/>	<input type="radio"/>	—
M	<input type="radio"/>	<input type="radio"/>	—	—	—



- * Built-in Speedlight is always set to Flash Cancel when  or  is selected but flash shooting becomes possible with optional Speedlight. However, turning the optional Speedlight power off activates Flash Cancel mode.

Usable Optional Speedlights—continued



■ Notes on using optional Speedlights

- See your Speedlight manual for details.
- Make sure to cancel the standby mode of the optional Speedlight.
- Flash sync speed is 1/90 sec. or slower when using an optional Speedlight.
- When Red-Eye Reduction or Red-Eye Reduction with Slow Sync is set on a camera attached with an optional Speedlight, the Red-Eye Reduction lamp of the camera body lights up.
- Even when an optional Speedlight with AF-Assist Illuminator is attached, the AF-Assist Illuminator of the camera body emits light when the focus mode is set to AF, an AF Nikkor lens is attached, the subject is dark and center focus area is selected or Dynamic AF Mode with Closest-Subject Priority is activated.
- Selecting Flash Cancel mode on the camera does not override the operation of the optional Speedlight.
- Flash exposure compensation is not performed with the optional Speedlight.
- With the SB-26, 25 or 24, Speedlight performs Front-Curtain Sync even if Rear-Curtain Sync is set on Speedlight (Speedlight setting is overridden).
- With the SB-26, 25 or 24, when Slow Sync is set on the camera body in , Slow Sync Flash is not performed and the shutter speed is automatically set to 1/90 sec.
- Use the optional Accessory Shoe Adaptor AS-15 to use the sync terminal.

NOTE: When optional Speedlight is attached

Turn on the optional Speedlight power switch or set the built-in Speedlight to Flash Cancel mode so the built-in Speedlight won't pop up automatically when an optional Speedlight is attached. When the built-in Speedlight automatically pops up in  or Vari-Program (except  or ), vignetting or uneven illumination may result since the Speedlight may not pop up all the way.

NOTE: Flash attachments made by manufacturers other than Nikon

Use only Nikon Speedlights. Other units may damage the camera's electrical circuit due to incompatible voltage requirements (not compatible with 250V or higher), electric contact alignment or switch phase. When flash attachments made by manufacturers other than Nikon are attached, the built-in Speedlight may not pop up all the way (with power switch of the Speedlight on or off). When the built-in Speedlight is automatically fired in  or Vari-Program (except  or ), vignetting or uneven illumination may result.

Optional Accessories

A variety of optional accessories, including lens and Speedlight is available for the N55.

Eyepiece correction lenses

- Eyepiece correction lenses enable near- or far-sighted photographers to adjust the eyepiece diopter to suit their vision, and can be attached easily by inserting onto the viewfinder eyepiece. Nine optional eyepiece correction lenses provide viewfinder diopter settings of -5 , -4 , -3 , -2 , 0 , $+0.5$, $+1$, $+2$ and $+3m^{-1}$ (combined diopter with setting on camera body). We recommend that you actually look through the viewfinder with various correction lenses attached before making a purchase, since viewfinder diopter differs from one person to another. Use the optional eyepiece correction lens when you need eyepiece correction over -1.5 to $+0.8m^{-1}$ that can be adjusted using the N55's diopter adjustment lever.

The rubber eyecup cannot be used together with the eyepiece correction lenses.

Lenses

- A wide variety of AF lenses—wideangle, telephoto, zoom, Micro or DC (Defocus image Control)—is available for the N55.

Filters

- Nikon filters can be divided into three types: screw-in, drop-in and rear-interchange. With the N55, the filter factor need not be considered except for the R60 filter. Compensate exposure $+1$ EV when using the R60. Note that when special filters available from manufacturers other than Nikon are used, autofocus or the electronic rangefinder may not operate properly.
- Use circular-polarising filter C-PL instead of polarising filter Polar. The linear polarising filter cannot be used with the N55.
- Use NC filter when using the filter to protect the lens.
- Moiré may occur when shooting a subject against bright light or if a bright light source is in the frame. In this case, remove the filter before shooting.

Speedlight SB-28/SB-27

- Speedlight SB-28/SB-27 normally uses four AA-type alkaline-manganese batteries with a guide number of 36/118 (SB-28) and 30/98 (SB-27) (manual flash, 35mm zoom-head position, ISO 100, m/ft., 20°C/68°F). Optional external power source SD-7 and SD-8A or Power Bracket SK-6A (SB-28 only) can also be used. Non-TTL Auto Flash is compatible with the SB-28/SB-27.

Soft case (CF-62)

- Camera case CF-62 is available for this camera. The camera body fits inside the case with AF 28-80mm f/3.3-5.6G or smaller lens attached.

Neckstraps/Handstrap AH-4

- Braid-type AN-4B (black) and AN-4Y (yellow), wide braid-type AN-6Y (yellow) and AN-6W (burgundy) neckstraps are available.
- Handstrap AH-4 helps you hold the camera firmly and easily, and shoot in quick-motion.

Camera Care

• **Cleaning camera body**

Use a blower brush to remove dirt and dust from the camera body and clean it with a soft, clean cloth. After using the camera near seawater, wipe the camera body with a soft, clean cloth slightly moistened with pure water to remove salt, and then dry it with a dry cloth. **NEVER** use organic solvents like thinner or benzene. They may damage the camera.

• **Cleaning mirror and lens**

Use a blower brush to remove dirt and dust from the mirror or lens. To remove fingerprints or smudges from the lens' surface, use a soft, clean cotton cloth or lens tissue moistened with ethanol (alcohol) or lens cleaner.

• **Do not subject the camera or lens to strong vibration or shock**

Do not drop the camera body and lens or hit them against a hard surface as this may damage their precision mechanism.

• **Do not touch the shutter curtains**

The shutter is made of very thin curtains. Do not hold, poke, or blow strongly with a blower brush. Doing so may scratch, deform or tear the shutter curtains.

• **Avoid strong electric or magnetic fields**

The camera may not function properly in strong electric or magnetic fields such as near a transmitter tower. Avoid using the camera in such locations.

• **Store the camera in a cool, dry place**

Store the camera in a cool, dry place to prevent mold and mildew.

Keep it away from naphthalene or camphor (moth repellent), electrical appliances that generate magnetic fields or an excessively hot place such as inside a vehicle during the summer or near a heater.

• **Avoid extreme temperature change**

An extreme temperature change can cause condensation inside the camera body.

When taking the camera to a very hot place from a very cold place or vice versa, place it inside an airtight container such as a plastic bag and leave it inside a while to expose the camera gradually to the temperature change.

• **Avoid water or moisture**

Keep the camera away from water or moisture. When using the camera near water, guard against splashes, especially salt water spray.

• Remove the batteries and store the camera with a desiccant

If you do not intend to use the camera for a long time, remove the batteries to protect the camera from battery leakage.

- In a humid environment, store the camera inside a plastic bag with a desiccant to keep out dust, moisture and salt. Note, however, that storing leather cases in vinyl bags may cause the leather to deteriorate. Keep the batteries in a cool, dry place away from heat or humidity.
- Change the desiccant occasionally since it does not absorb moisture effectively after a while.
- Leaving the camera unused for a long period of time may cause mold to grow and result in malfunction. Turn the power on and release the shutter a few times once per month.
- To maintain the built-in Speedlight in peak condition, fire it a few times every month. This will enable you to use the flash for many years.

Nikon cannot be held responsible for any malfunction resulting from the use of the camera other than as specified in this manual.

Notes on Batteries



WARNING



Do not leave

Keep batteries out of children's reach. If someone accidentally swallows batteries, call a doctor immediately.

• Use two CR2-type 3V lithium batteries

Use two CR2-type 3V lithium batteries.

- Change the batteries well before the end of their life and prepare spare batteries before important photographic occasions.

• Turn the camera power off when changing batteries

Turn the camera power off before changing batteries and insert the batteries with \oplus and \ominus ends positioned correctly.

- Stains on the battery poles may cause lack of contact. Wipe the batteries well with a dry cloth before installing.

• Use fresh batteries at low temperatures

Battery power diminishes at extremely low temperatures and the camera may not function properly with old batteries. Use a fresh set of batteries at low temperatures, keep spare batteries warm, and use them alternately.

- Film advance speed lowers and number of usable film rolls becomes less at low temperatures. However, battery power may recover when the temperature returns to normal.

• Do not throw batteries into a fire or short circuit batteries

Do not throw batteries into a fire. Do not short, disassemble, heat or charge batteries.

Troubleshooting

LCD panel	Viewfinder	Cause	Remedy	Page
FEE blinks	FEE blinks	<ul style="list-style-type: none"> • CPU Nikkor lens other than G-type is not set to its minimum aperture. 	<ul style="list-style-type: none"> • Set lens to minimum aperture. 	19
appears	—	<ul style="list-style-type: none"> • Batteries are nearing exhaustion. 	<ul style="list-style-type: none"> • Have fresh ones ready. 	17
blinks	—	<ul style="list-style-type: none"> • Batteries are just about exhausted. 	<ul style="list-style-type: none"> • Turn the power off and replace batteries with new ones. 	17
and frame counter blink	—	<ul style="list-style-type: none"> • Batteries are exhausted during film rewind. 	<ul style="list-style-type: none"> • Turn the power off, replace batteries with new ones and turn the power on again, then press two film rewind buttons simultaneously for more than 1 sec. to start film rewind again. If this warning appears frequently, contact authorized Nikon dealer or service center. 	72
F-- blinks	F-- blinks	<ul style="list-style-type: none"> • Non-CPU lens is attached or lens is not attached. 	<ul style="list-style-type: none"> • Attach CPU lens. With a non-CPU lens, set the exposure mode to M and set the aperture with lens' aperture ring. 	19, 89, 90
E appears	—	<ul style="list-style-type: none"> • Film is not correctly installed. 	<ul style="list-style-type: none"> • Reload film. 	20
Err and E blink	Err blinks	<ul style="list-style-type: none"> • Film is not correctly advanced. 	<ul style="list-style-type: none"> • Reload film. 	20
E blinks when exposure meter is turned on	—	<ul style="list-style-type: none"> • Film remains in the camera after film rewind is complete. 	<ul style="list-style-type: none"> • Remove the film cartridge. 	33

Troubleshooting—continued

LCD panel	Viewfinder	Cause	Remedy	Page
—	● blinks	<ul style="list-style-type: none"> Autofocus is not possible. 	<ul style="list-style-type: none"> Focus manually. 	47
H i appears	H i appears	<ul style="list-style-type: none"> Overexposure warning (subject is too bright). 	<ul style="list-style-type: none"> P mode, use ND filter. In S mode, select faster shutter speed. In A mode, select smaller aperture (larger f-number). (If the warning indication remains after performing above remedies in S or A mode, use ND filter as well.) 	54 56 58
l o appears	l o appears	<ul style="list-style-type: none"> Underexposure warning (subject is too dark). 	<ul style="list-style-type: none"> In P mode, use flash. In S mode, select slower shutter speed. In A mode, select larger aperture (smaller f-number). (If the warning indication remains after performing above remedies in S or A mode, use flash as well.) 	54 56 58
—	⏪ or ⏩ blinks (in M exposure mode)	<ul style="list-style-type: none"> Subject brightness is beyond camera's exposure range. 	<ul style="list-style-type: none"> When the subject is bright, use ND filter and when the subject is dark, use flash. The electronic analog exposure display remains blinking when the Speedlight is used. 	61
-- blinks	-- blinks	<ul style="list-style-type: none"> Shutter speed is set to -- (Time) in S mode. Auto Exposure Bracketing is set during Long Time exposure. 	<ul style="list-style-type: none"> Cancel the -- by selecting 30 sec. or faster shutter speed, or select M mode to perform Long Time Exposure. Select shutter speed other than -- to cancel Long Time exposure, or cancel Auto Exposure Bracketing. 	56, 62 62, 66

LCD panel	Viewfinder	Cause	Remedy	Page
90 appears (when shutter speed faster than 90 sec. is selected)	90 appears	<ul style="list-style-type: none"> Shutter speed faster than sync speed is selected in S or M mode. 	<ul style="list-style-type: none"> Simply release the shutter to take a flash picture. (Shutter speed automatically shifts to 1/90 sec.) 	79, 82
—	⚡ blinks	<ul style="list-style-type: none"> Subject is too dark and flash is recommended in P, S, A or M mode. 	<ul style="list-style-type: none"> Use Speedlight. 	55, 57, 59, 61, 76, 80
—	⚡ blinks for 3 sec. after flash	<ul style="list-style-type: none"> Flash has fired at full output and underexposure may have occurred. 	<ul style="list-style-type: none"> Shoot again after confirming focus distance, aperture or flash shooting distance range. 	77, 82, 83
—	⚡ blinks	<ul style="list-style-type: none"> Optional Speedlight is set to TTL Auto Flash 	<ul style="list-style-type: none"> Set the optional Speedlight to A (Non-TTL Auto Flash) or M (Manual flash). 	93
Err blinks	Err blinks	<ul style="list-style-type: none"> Malfunction detected. 	<ul style="list-style-type: none"> Turn the power off once and then on again. If the warning indication remains, or this warning appears frequently, contact authorized Nikon dealer or service center. 	

In certain cases, due to static electricity, the N55's microcomputer may turn the camera off, even with fresh, properly installed batteries. For the same reason, the film may not advance properly. In each of these cases, to resume operation, simply turn the power off, then turn it on again. Or, remove and reinstall the batteries.

Glossary

CPU

Central Processing Unit. The electronic component that controls an electronic product's functions.

AF Nikkor (including G- and D-type AF Nikkor) and AI-P-Nikkor lenses have built-in CPUs.

EV

Exposure Value: A number representing the available combinations of shutter speeds and apertures that give the same exposure effect under conditions of similar scene brightness and ISO.

At ISO 100, the combination of a one-second shutter speed and an aperture of f/1.4 is defined as EV1.

The camera can be used only within the EV range of the exposure meter. For example, with the N55, the exposure metering range is from EV1 to EV20 at ISO 100 with an f/1.4 lens.

Exposure bracketing

Shooting the same subject a number of times at a range of different exposures to attain proper exposure. Three shots with metered EV, under EV, and over EV exposure are performed in that order with the N55.

Automatic exposure bracketing is performed with varied shutter speeds and/or apertures.

Exposure Compensation

In a situation such as when your subject is strongly backlit, exposure compensation enables you to intentionally compensate the standard exposure value measured by the camera to create a desired effect. Exposure compensation of -2 EV to +2 EV in 1/2 stops is available with the N55.

Flash shooting distance range

The distance range over which a flash can effectively provide light. Flash shooting distance range is controlled by the amount of flash output available. Each automatic Speedlight's flash output varies from maximum duration to minimum duration. Close-up subjects will require lower (to minimum) output, while more distant subjects will require more light up to the maximum output.

The flash shooting distance range varies with the aperture, film speed, etc.

Flash sync speed

Shutter speed at which the entire film frame is exposed when the flash is fired in flash shooting. The N55's flash sync speed is 1/90 sec. or slower.

Flexible Program

Flexible Program function temporarily shifts an automatically selected shutter speed/aperture combination while maintaining correct exposure. That is, the desired shutter speed or aperture can be selected in Auto-Multi Program.

f-number

The f-number represents the aperture value and is calculated from lens' focal length divided by the effective aperture opening. The standard numbers for calibration are 1, 1.4, 2, 2.8, 4, 5.6, 8, 11, 16, 22, 32, etc.

The smallest f-number is called maximum aperture and the largest f-number is called minimum aperture. Lenses with large maximum apertures (smaller f-numbers) are 'fast' lenses that allow photographers to use faster shutter speeds in dim light. Lenses with smaller maximum apertures (larger f-numbers) allow the use of lower shutter speeds for available light but are also lighter and smaller than faster lenses. With some zoom lenses, aperture varies depending on the focal length setting.

Focal length

The distance from the principal point to the focal point. In 35mm-format cameras, lenses with a focal length of approx. 50mm are called normal or standard lenses. Lenses with a focal length less than approx. 35mm are called wideangle lenses, and lenses with a focal length more than approx. 85mm are called telephoto lenses. Lenses which allow the user to continuously vary the focal length without changing focus are called zoom lenses.

Glossary—continued

Focus Tracking

Enables the camera to analyze the speed of a moving subject according to the focus data detected, and to obtain correct focus by anticipating the subject's position—at the exact moment of exposure.

Lock-On™ Autofocus keeps focus firmly on a main subject during Focus Tracking even if some other object momentarily blocks it in the viewfinder.

Front-Curtain Sync

The flash fires an instant after the front curtain of a focal plane shutter has completed its travel across the film plane. This is the way the N55 operates with the flash sync mode at Normal Sync.

Guide number

The guide number indicates the power of a flash in relation to ISO film speed. The guide number of the built-in Speedlight of the N55 is 12 (ISO 100, m). Guide numbers are quoted in either meters or feet. Guide numbers are used to calculate the f/stop for correct exposure as follows:

$$f/stop = \frac{\text{guide number}}{\text{flash-to-subject distance}}$$

Using a selected aperture, we can calculate the required flash-to-subject distance with the formula:

$$\text{flash-to-subject distance} = \frac{\text{guide number}}{f/stop}$$

Useful for determining the maximum flash-to-subject distance for flash photography.

ISO film speed

The international standard for representing film sensitivity. The higher the number, the greater the sensitivity, and vice versa. A film speed of ISO 200 is twice as sensitive as ISO 100, and half that of ISO 400 film.

Slow Sync







A flash technique for using the flash at a slow shutter speed. Flash shooting in dim light or at night at a fast shutter speed often results in a flash-illuminated subject against a dark background. Using a slower shutter speed with the flash brings out the background details in the picture.



The N55's Slow Sync mode extends the automatically controlled shutter speed range down to 30 sec. (in Auto-Multi Program, Aperture-Priority Auto) or 1 sec. (in  Night Portrait mode).

Vignetting









Progressively diminished illumination on the film from the center to the corners. There are two kinds of vignetting—natural vignetting caused by the lens, and vignetting that is caused by improper use of accessories such as a lens hood or filter.

Specifications

Type of camera	Integral-motor autofocus 35mm single-lens reflex with electronically controlled focal-plane shutter and built-in Speedlight
Exposure modes	<p>: AUTO mode Vari-Program (: Portrait, : Landscape, : Close-Up, : Sports Continuous, : Night Portrait mode) P: Auto-Multi Program (Flexible Program possible) S: Shutter-Priority Auto A: Aperture-Priority Auto M: Manual</p>
Picture format	24 x 36mm (standard 35mm film format)
Lens mount	Nikon F mount (with AF coupling, AF contacts)
Lens	Nikkor and Nikon lenses having Nikon F mount* * <i>With limitations; see chart on page 88.</i>
Viewfinder	Fixed-eyelevel penta-Dach-mirror type, built-in diopter adjustment (-1.5 to +0.8m ⁻¹)
Eyepoint	17mm (at -1.0m ⁻¹)
Focusing screen	B-type Clear Matte Screen V with focus brackets
Viewfinder frame coverage	Approx. 89%
Finder magnification	Approx. 0.68-0.60x with 50mm lens set to infinity (at -1.5 to +0.8m ⁻¹)
Viewfinder information (with illuminator)	Focus indications, focus area, shutter speed, aperture, electronic analog exposure display/Exposure Compensation value display, Exposure Compensation, flash ready-light/flash recommended/full flash output Three sets of focus brackets (area)
Reflex mirror	Automatic, instant-return type
Lens aperture	Instant-return type



Autofocus	TTL phase detection, Nikon Multi-CAM530 autofocus module with AF-Assist Illuminator (approx. 0.5m-3m or 1.6-9.8 ft.) • Detection range: EV -1 to EV 19 (ISO 100, at normal temperature)
Lens servo	AF: Auto-Servo AF: camera automatically chooses Single Servo AF or Continuous Servo AF operation according to the subject status, i.e. stationary or moving. • Single Servo AF (focus is locked when the subject is in-focus) • Continuous Servo AF (camera continues to focus on a moving subject) Focus Tracking with Lock-On™ automatically activated by subject's status M: Manual focus
Focus area	One of three focus areas can be selected
Focus Area mode	• Dynamic AF Mode with Closest-Subject Priority • Dynamic AF Mode • Single Area with M focus mode
Metering system	TTL full-aperture exposure metering system Three metering systems selectable (limitations with lens used) • 3D five-segment Matrix Metering: with G- or D-type AF Nikkor • Five-segment Matrix Metering: with AF Nikkor other than G- or D-type (except AF Nikkor for F3AF and IX-Nikkor), AI-P Nikkor • Center Partial Metering: automatically selected with Manual exposure mode
Metering range	3D Matrix Metering: EV 1-20 Center Partial Metering: EV 1-20 (at normal temperature, ISO 100, f/1.4 lens)
Exposure meter coupling	CPU
Exposure Compensation	Exposure compensated in ± 2 EV range, in 1/2 steps (except in M ,  or Programmed Flash)
Auto Exposure Bracketing	Bracketing range: ± 2 EV; number of shots: three; bracketing steps: 0.5, 1, 1.5 or 2 EV (except in  or Vari-Program)
Film speed setting	• Automatically set to ISO film speed of DX-coded film in use (manual not selectable) • Film speed range: DX: ISO 25-5000, automatically set to ISO 100 with non-DX-coded film

Specifications—continued

Shutter	Electronically controlled vertical-travel focal-plane shutter
Shutter speeds	<ul style="list-style-type: none"> • In AUTO, , , , , , , P, A: Automatically set between 30 and 1/2000 sec. • In S: 30 to 1/2000 sec. (in 1/2 steps) • In M: 30 to 1/2000 sec. (in 1/2 steps), Time
Sync contact	X-contact only; flash synchronization up to 1/90 sec.
Built-in Speedlight	<ul style="list-style-type: none"> • In AUTO, Vari-Program (except in  or ) Automatically activated • In P, S, A, M: Activated by pressing flash lock-release button Guide number: 12/40 (at ISO 100, m/ft.); flash coverage: 28mm or longer lens; film speed range: ISO 25 to ISO 800
Flash control	Controlled by TTL Sensor <ul style="list-style-type: none"> • Matrix Balanced Fill-Flash: built-in Speedlight and CPU Nikkor lens (except in Manual exposure mode) • Standard TTL: in Manual exposure mode • Programmed Flash (Non-TTL Auto Flash): optional Speedlight and CPU Nikkor lens (except in A or M exposure mode) • Film speed range in TTL auto flash: ISO 25 to 800
Flash sync mode	Front-Curtain Sync (normal sync), Slow Sync, Red-Eye Reduction, Red-Eye Reduction with Slow Sync, Flash Cancel
Ready-light	<ul style="list-style-type: none"> • Flash fully charged: ready-light lights • Full output warning: ready-light blinks
Flash recommended indication	Blinks when the subject is dark or backlit and Speedlight is recommended in P, S, A and M
Accessory shoe	Standard ISO-type hot-shoe contact (sync contact, ready-light contact, GND), safety lock provided
Self-timer	Electronically controlled; timer duration: 10 sec.

Film loading	Easy loading, automatic prewind with built-in motor; film automatically advances to first frame (frame of the maximum number of available exposure) when camera back is closed
Film advance	<ul style="list-style-type: none"> • Automatic advance with built-in motor • Continuous shooting possible in  Sports Continuous mode • Film advance speed: approx. 1.5 fps (fresh batteries)
Film rewind	<ul style="list-style-type: none"> • Automatic rewind with built-in motor • Mid-roll rewind available
Multiple Exposure	Selectable in P, S, A, M
LCD panel information	Shutter speed, aperture, Exposure Compensation, Exposure Compensation value, Auto Exposure Bracketing, Multiple Exposure, flash sync mode, focus area, battery power, frame counter, self-timer
Date/time imprint function (QD model only)	<p>Built-in clock: 24-hour type with timing accuracy within ± 90 seconds a month; leap year adjustment until December 31, 2049</p> <p>Usable film: ISO 32 to 3200 DX-coded film</p> <p>Display mode: Year/Month/Day, Day/Hour/Minute, No Imprint, Month/Day/Year and Day/Month/Year</p> <p>Power source: one 3V CR2025 lithium battery, battery life; approx. three years (depending upon use of data imprint function and other operating conditions)</p>
Camera back	Hinged back with film confirmation window QD model: data imprint LCD panel/buttons
Power source	Two 3V CR2 lithium batteries
Power switch	Power ON and OFF position
Exposure meter	Auto meter shut-off 5 sec. after power turned on if no operations are performed; activated by lightly pressing shutter release button after power is turned on

Specifications—continued

Battery power confirmation	In LCD panel, with exposure meter on <ul style="list-style-type: none"> •  for sufficient power •  indicates batteries are nearing exhaustion • Blinking  indicates batteries are just about exhausted 		
Usable number of 36-exposure (24-exposure) film rolls per set of two fresh 3V lithium batteries		At 20°C/68°F	At -10°C/14°F
	Without flash	Approx. 45 (67)	Approx. 27 (40)
	With flash and AF-Assist Illuminator for half of all exposures	Approx. 11 (16)	Approx. 7 (10)
<i>Autofocus operation using an AF Zoom-Nikkor 28-80mm f/3.3-5.6G lens, covering the full range from infinity (∞) to the closest distance and back to infinity (∞) before each shot, with a shutter speed of 1/90 sec. or faster.</i>			
Tripod socket	1/4 (diameter, JIS standard)		
Dimensions (W x H x D)	Approx. 129 x 92 x 65mm or 5.1 x 3.6 x 2.6 in. QD model: Approx. 129 x 92 x 67.5mm or 5.1 x 3.6 x 2.7 in.		
Weight (without batteries)	Approx. 350g or 12.3 oz. QD model: Approx. 360g or 12.7 oz.		
Optional exclusive accessories	Soft case CF-62		

All specifications apply when fresh batteries are used at normal temperature (20°C/68°F). Specifications and design are subject to change without notice.

Index

A

- AF-Assist Illuminator.....
..... 31, 41, 50-51, 74, 82, 94
- Aperture-Priority Auto exposure mode
.....10, 29, 34, 58-59, 74, 82, 84, 95
- Auto Exposure Bracketing.....
...28, 37, 54-55, 62-63, 66-68, 70, 74, 106
- Autofocus.....26-27, 46
- AUTO mode..11, 28, 29, 55, 74, 82, 84, 95
- Auto-Multi Program.....
.....10, 29, 34, 54-55, 74, 82, 84, 95
- Auto-Servo AF.....46

C

- Center Partial Metering.....9, 34, 60
- Continuous shooting.....38, 74
- Continuous Servo AF.....46
- CPU Nikkor lens.....18-19, 88-90, 106

D

- Depth of field.....58, 86
- Diopter adjustment.....73
- Distance information.....28, 34
- D-type Nikkor lens.....18, 88
- DX-coded film.....21
- Dynamic AF Mode.....38, 48-49, 74
- Dynamic AF Mode with Closest-Subject
Priority.....26, 48-49, 74

E

- Electronic rangefinder.....47
- Exposure Compensation.....64, 74, 106
- Exposure meter.....17, 24
- Exposure mode.....
.....10-11, 28-29, 54-62, 74, 84, 88, 95

F

- Film advance mode.....74
- Flash Cancel.....40, 79, 81, 84, 95
- Flash shooting distance range.....83, 107
- Flash sync mode.....78-79, 81, 84, 95
- Flexible Program.....55, 74, 107
- Focus brackets (area).....8, 9, 30, 48-49
- Focus Lock.....27, 52
- Focus mode.....26, 46-47, 74, 88
- Focus Tracking.....46, 108
- Front-Curtain Sync.....41, 78, 84, 95, 108

G

- G-type Nikkor lens.....18, 88
- Guide number.....40, 76, 83, 108

L
 Long Time exposure (Time).....57, 62

M
 Manual exposure mode.....
10, 29, 34, 60-62, 74, 82, 84, 95
 Manual focus27, 47
 Manual focus with electronic rangefinder ...
47
 Matrix Balanced Fill-Flash.....40, 76, 84
 Matrix Metering28, 34
 Maximum aperture58, 60
 Metering system.....28, 34, 60, 74, 88
 Minimum aperture19, 54, 56, 58, 60, 89
 Multiple Exposure69-70, 74

R
 Ready-light9, 41, 77, 80, 82, 94
 Red-Eye Reduction43, 79, 84, 95, 96
 Red-Eye Reduction with Slow Sync.....
79, 84, 95, 96

S
 Self-timer42-43
 Shutter-Priority Auto exposure mode.....
10, 29, 34, 55-57, 74, 82, 84, 95
 Single Area Mode49, 74
 Single-frame shooting74
 Single Servo AF46
 Slow Sync flash.....78, 84, 95, 109
 Standard TTL flash77, 84
 Sync shutter speed82

T
 3D 5-Segment Matrix Metering.....28, 34

V
 Vari-Program.....
11, 29, 34, 36-39, 74, 82, 84, 95
 Vignetting51, 84-85, 109

No reproduction in any form of this manual, in whole or in part (except for brief quotation in critical articles or reviews), may be made without written authorization from NIKON CORPORATION.

Nikon

NIKON CORPORATION

FUJI BLDG., 2-3, MARUNOUCHI 3-CHOME,
CHIYODA-KU, TOKYO 100-8331, JAPAN

Printed in Thailand