

Nikon

FEA

INSTRUCTION MANUAL

NOMENCLATURE

① Aperture-direct-readout (ADR) window

LCD illumination window ⑫

② Shutter speed indication illumination window

Meter coupling lever ⑬

③ Neckstrap eyelet

Sync terminal ⑭

④ Focusing screen holder release lever

Lens mounting index ⑮

⑤ Depth-of-field preview lever

Lens type signal pin ⑯

⑥ Handgrip

Lens release button ⑰

⑦ Handgrip attachment screw

Lens release pin ⑱

⑧ Self-timer lever

Focal length indexing lever ⑲

⑨ Metering control button

Maximum aperture indexing lever ⑳

⑩ Aperture coupling lever

Reflex mirror ㉑

⑪ Lens mounting flange



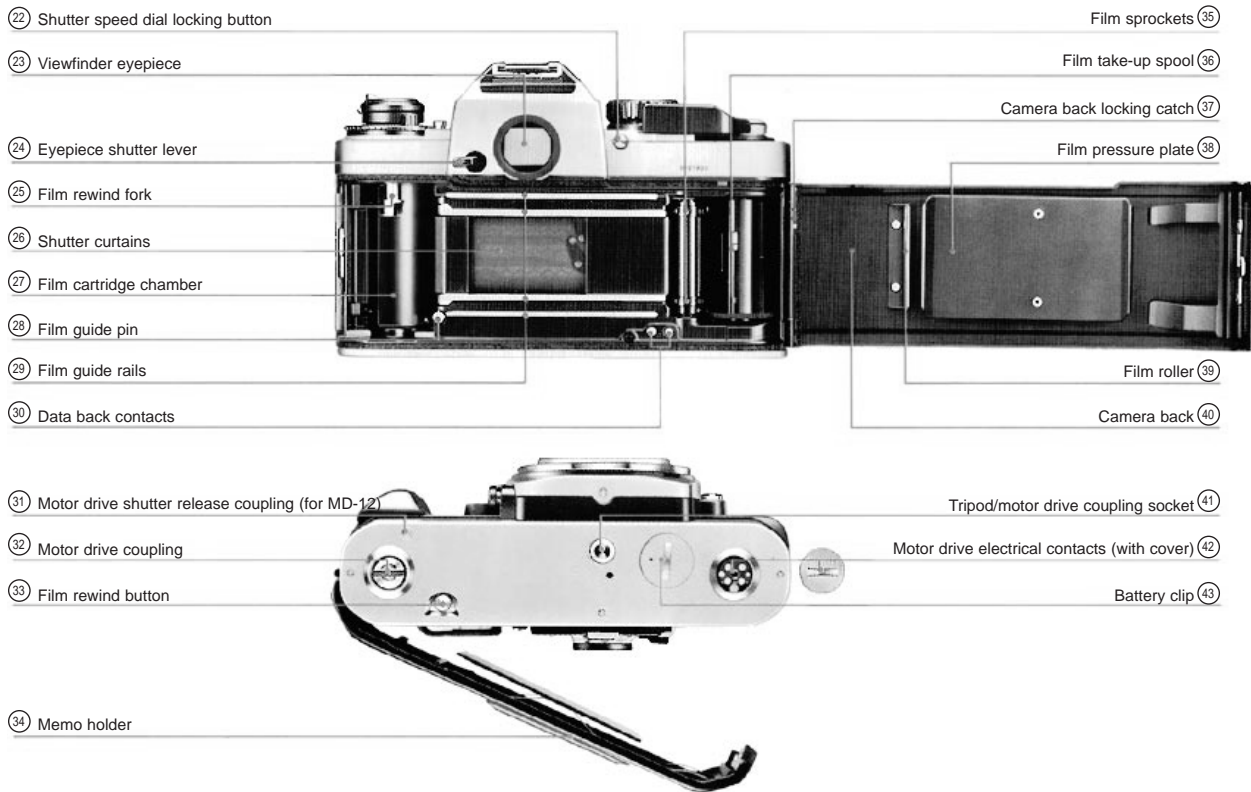

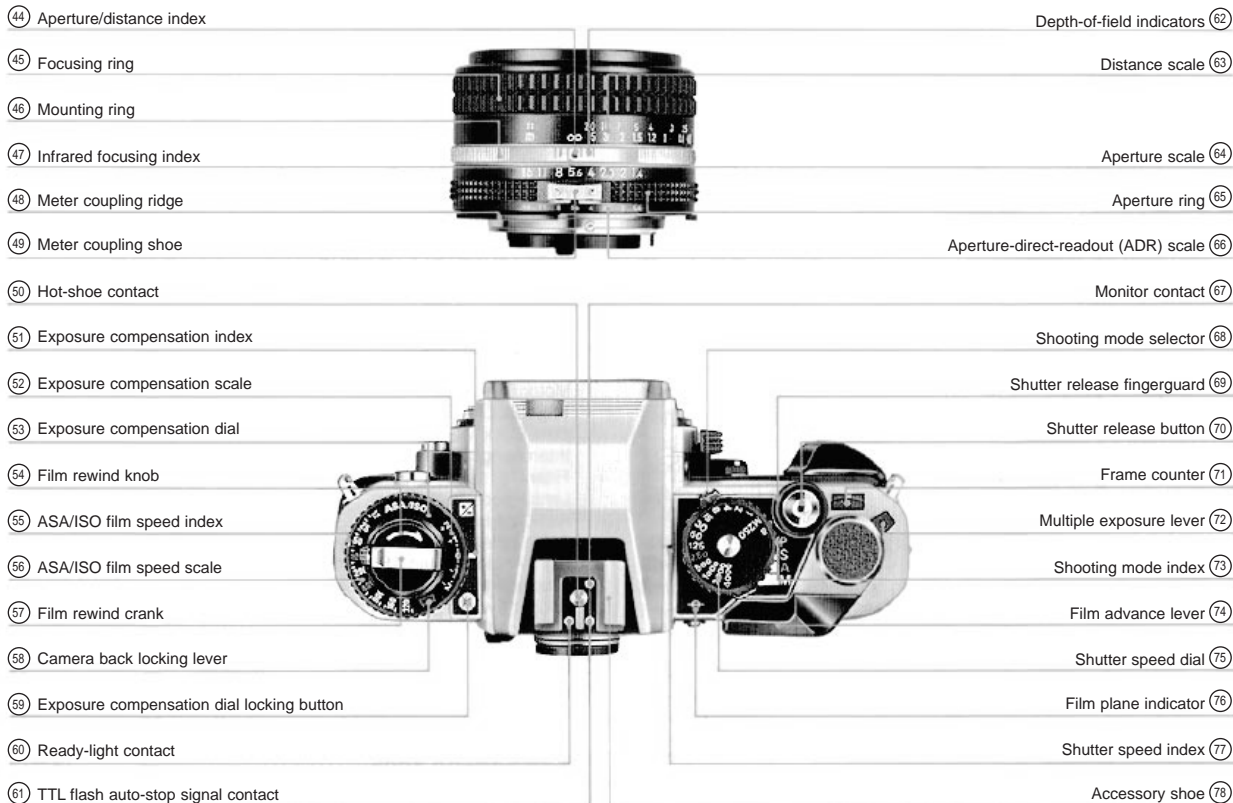

CONTENTS

NOMENCLATURE.....	3 - 5
FOREWORD	7
BASIC OPERATION	8 - 38
INSTALLING BATTERIES	8
CHECKING BATTERY POWER	9
MOUNTING THE LENS	10 - 11
Usable Lenses	10
AI-S Nikkor: An Updated Version of AI-Nikkor Lenses	11
LOADING FILM	12 - 15
Frame Counter	15
Film Advance Lever	15
Memo Holder	15
SETTING FILM SPEED	16
SELECTING THE SHOOTING MODE	17 - 31
Viewfinder Information	19
P(Programmed) Mode	20 - 23
S (Shutter-Priority) Mode	24 - 27
A (Aperture-Priority) Mode	28 - 29
M (Manual) Mode	30 - 31
HOLDING THE CAMERA	32 - 33
Detachable Handgrip	33
FOCUSING	34 - 35
TAKING PICTURES	36
UNLOADING FILM	37 - 38
TECHNICAL INFORMATION /	
PHOTOGRAPHIC TECHNIQUES	39 - 62
EXPOSURE METERING SYSTEM	39 - 45
Metering Control Button	40
Comparison of Automatic Multi-Pattern and Centerweighted Metering	41 - 45
RELATIONSHIP BETWEEN SHUTTER SPEED AND APERTURE	46 - 47
DEPTH OF FIELD	48 - 49
EXPOSURE COMPENSATION	50 - 53
In Automatic Exposure Modes	50 - 51
In the Manual Mode	52
Duplication Work and Photomicrography	53
STOP-DOWN EXPOSURE MEASUREMENT	54

MULTIPLE EXPOSURE PHOTOGRAPHY	55
UNMANNED PHOTOGRAPHY	56 - 57
Self-Timer	56
Eyepiece Shutter	57
INFRARED PHOTOGRAPHY	57
FLASH PHOTOGRAPHY	58 - 61
Accessory Shoe and Sync Terminal	59
Ready-Light Indication in the Viewfinder	60
Nikon FA/Speedlight Combination Chart	61
CLOSE UP PHOTOGRAPHY	62
Close-Up Equipment	62
ACCESSORIES	63 - 69
ELECTRONIC FLASH UNITS	63
Speedlight SB-15	63
Speedlight SB-16B	63
Speedlight SB-18	63
MOTOR DRIVES	64
Motor Drive MD-15	64
Motor Drive MD-12	64
MISCELLANEOUS	65 - 69
Data Back MF-16	65
Interchangeable Focusing Screens	66 - 67
Filters	68
Lens Hoods	68
Anti-Cold Battery Pack DB-2	69
Cable Release AR-3	69
Right-Angle Viewing Attachment DR-3	69
Eyepiece Magnifier DG-2	69
Rubber Eyecup	69
Eyepiece Correction Lenses	69
Camera Cases	69
Neckstraps	69
EV RANGE OF THE CAMERA	70 - 71
What is EV?	70
EV Chart	70 - 71
TIPS ON CAMERA CARE	72 - 73
TIPS ON BATTERY USE	74
ABOUT THE LIQUID CRYSTAL DISPLAY (LCD)	74
SPECIFICATIONS	75 - 77

FOREWORD

Welcome to Nikon's exciting world of picture-taking ease.

To put you in total control, the Nikon FA offers three automatic exposure modes, in addition to full manual override. For fastbreaking events, the programmed mode automatically sets both shutter speed and aperture for correct exposure in any light. Or when action must be stopped or blurred, such as in sports photography, shutter priority lets you choose the shutter speed manually, then the FA automatically sets the aperture to match. If depth of field is important, aperture. priority allows you to select the precise aperture with the matching shutter speed set automatically.

But possibly even more important are the FA's two separate metering methods. In Nikon's revolutionary automatic multipattern metering system, the brightness from 5 areas of the focusing screen is analyzed by the camera's microcomputer; this automatically ensures the correct exposure-even in tricky lighting situations-without any exposure compensation whatsoever.

Traditional centerweighted metering is reserved for the manual mode, but is usable in any of the three automatic modes with the metering control button. Other features of the FA include 1/4000sec. top shutter speed, 1/250sec. flash sync, interchangeable focusing screens, and a comprehensive line of Nikon accessories.

Before using the camera, please read this instruction manual from cover to cover. A few minutes invested now will pay off in years of rewarding picture-taking experiences.

BASIC OPERATION

INSTALLING BATTERIES



1. **Remove the battery clip.** ④ Use a coin to unscrew it in counter clockwise direction



2. **Insert batteries.** Wipe the battery terminals clean and insert the batteries, **making sure that the + signs are up.** Useable batteries for the Nikon FA camera are:
 - One 3V lithium battery
 - Two 1.55V silver-oxide batteries (3.1V)
 - Two 1.5V alkaline-manganese batteries (3V)



3. **Reattach the battery clips.** Slip the clip back into the camera body and screw it tightly into place.

CHECKING BATTERY POWER



1. Pull out the film advance lever (74) to unlock the shutter release button (70). The lever doubles as a shutter release button lock.



2. Depress the shutter release button halfway to activate the exposure meter.

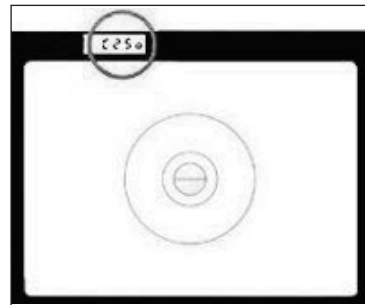

3. Check the LCD. Confirm that the LCD (liquid crystal display) is shown at the upper left in the viewfinder. This indicates that battery installation is correct and power is sufficient. If necessary, replace with a new set.

With sufficient battery power, the LCD stays on for 16sec. after you take your finger off the button. If the batteries are almost depleted, the LCD will turn off immediately when you take your finger off the button. In this case, replace batteries as soon as possible. With exhausted batteries, you cannot trip the shutter unless the shutter speed dial (75) is set at a mechanical setting of M250 or B.

* The LCD does not appear when the shutter dial is set at M250 or B

MOUNTING THE LENS



Lenses usable with the Nikon FA are AI-S Nikkor, Nikon Series E, AI-Nikkor, most AI-modified, and certain special lenses shown at the right. First line up the aperture/distance index (44) on the lens with the lens mounting index (15) on the camera body. Then twist the lens mounting ring (46) counterclockwise until the lens clicks into place. Confirm that the aperture/distance index is exactly at the top.

To remove: While pushing the lens release button (17), turn the lens mounting ring clockwise until the lens comes off

• *When changing lenses with film loaded in the camera, be careful not to expose the mirror box to direct sunlight.*

Usable Lenses



The following lenses are usable with the Nikon FA:

- AI-S Nikkor lenses
- Nikon Series E lenses
- AI Nikkor (including AI-modified Nikkor) lenses
- Reflex Nikkor 500mm f/8
- PC Nikkor 28mm f/3.5
- Medical-Nikkor 120mm f/4 IF
- Ref ex-Nikkor 1000mm f/11 (No.143001 or higher)
- Ret ex-Nikkor 2000mm f/11 (No.200311 or higher)
- PC-Nikkor 28mm f/4 (No 180901 or higher)
- PC-Nikkor 35mm f/2.8 (No 851000 or lower or No. 906201 or higher)
- Zoom-Nikkor 180-600mm f/8 ED (No.174167 or higher)
- Zoom-Nikkor 200-600mm f/9.5 (No.300491 or higher)
- Zoom-Nikkor 360-1200mm f/11 ED (No.174088 or higher)

- *The last seven lenses having serial numbers not listed above cannot be mounted on the FA as they hit the camera's meter coupling lever (13). However, they can be used after modification. In addition, AI-modification of most non-AI lenses having a meter coupling shoe (48) is available. Do not attempt to mount older Nikkor lenses which have not been AI-modified, as they might damage the camera. For further information concerning lens modification, please contact your local authorized Nikon dealer*
- *The following lenses cannot be used on the FA even if they are modified to have the AI facility:*
 - 55mm f/1.2 (No. 184711-970110)
 - 28mm f/3.5 (No. 625611-999999)
 - 35mm U14 (No. 385001-400000)
- *If you use lenses other than those manufactured by Nikon, proper performance may not be obtained and they may even damage the camera.*

AI-S Nikkor: An Updated Version of AI-Nikkor Lenses

In 1977, Nikon introduced AI-Nikkor lenses which feature full aperture metering via Nikon's "Automatic Maximum Aperture Indexing" or "AI" system. Just by mounting an AI lens on the camera, the maximum aperture is automatically indexed into the camera's metering system. All AI-type lenses feature a meter coupling ridge  and a meter coupling shoe having two holes (Illust. 1).

Then in 1981, Nikon modified their entire line of AI-Nikkor lenses, so that they would be fully compatible with the upcoming Nikon FA. These new lenses, called AI-S Nikkor, are easily distinguishable by (a) an orange minimum aperture on both regular aperture  and aperture-direct-readout (ADR) scales  (Illust. 2), and (b) a special notch on the bayonet mount (Illust. 3). In addition, the AI-S symbol appears on the front cover on the instruction manual for each lens.

When used with the Nikon FA in the programmed mode, AI-S lenses provide either a normal or high-speed program depending on the focal length in use; in the shutter-priority mode, they give you uniform exposure control in any lighting situation.

Nikon Series E lenses also have the same features as AI-S Nikkors, but do not have a meter coupling shoe. Of course, older AI-Nikkor and AI modified Nikkor lenses can be used with all current and older Nikon cameras, including the FA Nikon's new series of teleconverters—the TC-201, TC-301, TC-14A and TC-14B—have been specially designed for AI-S Nikkor lenses, but can be used with older AI-type lenses, too. As soon as they are attached, they automatically switch the FA to the high-speed program in the programmed mode.



Illust.1

AI-Type Lens

Lens type signal notch

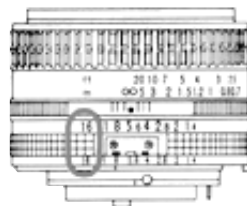

Illust.2

AI-S Nikkor Lens

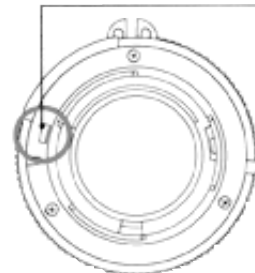

Illust.3

LOADING FILM



1. **Open the camera back** (40) While pushing the camera back locking lever (58) counterclockwise, pull up the film rewind knob (54) until the camera back pops open.

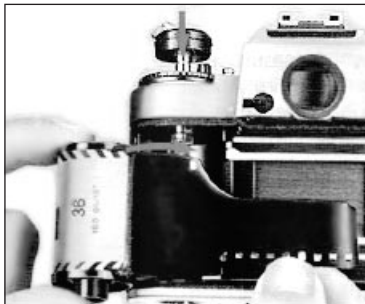

2. **Insert the film cartridge.** Position the cartridge in the film cartridge chamber (27) with the leader pointing towards the takeup spool (36); then push the rewind knob back down to secure the cartridge in place. You can use any type of 35mm film on the market. It is advisable to handle film in the shade to avoid direct exposure to sunlight.



3. **Insert the film leader in the take.** Pull the leader across the camera and insert it into any one of the slots in the takeup spool.



4. **Engage the film's perforations with the sprocket teeth.** Turn the takeup spool slightly with your thumb, so that the first or second perforation at the bottom edge of the film is engaged with the small tooth at the bottom of the slot in the takeout spool, and the top and bottom perforations mesh securely with the sprockets (35)

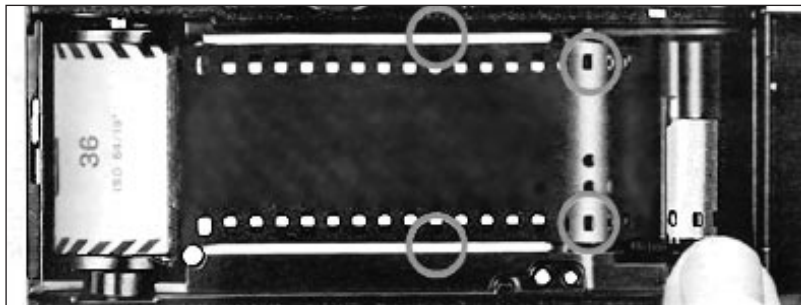

2. **Advance the film** by rotating the takeup spool further with your thumb. Make sure the perforations on both film edges are securely engaged with the sprocket teeth. Also confirm that the film is properly seated between both film guide rails (29) and there is no film slack. Then close the camera back until it snaps shut.



6. **Take up film slack.** Fold out the film rewind crank (57) and rotate gently in the direction of the arrow on the film rewind knob until you feel a slight resistance. Then fold the crank back in.

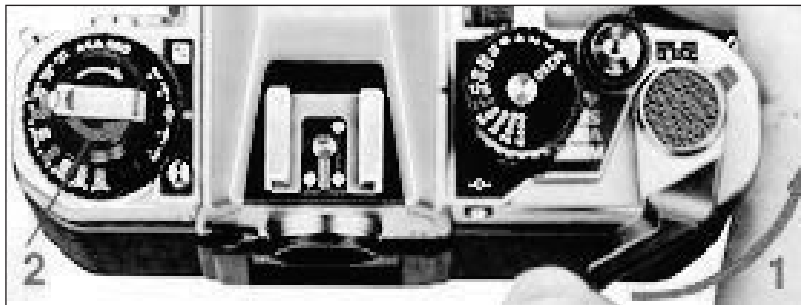

7. **Make blank exposure.** To dispose of the first few frames exposed during film loading, continue to alternately advance the film and depress the shutter release button until the frame counter (71) reaches frame 1. While making blank exposures, check that the rewind knob is rotating, indicating the film has been loaded correctly and is being advanced. If the knob does not rotate, reload the film.

•Do not take pictures prior to frame 1, because the meter does not function properly and the shutter fires at a fixed speed of 1/250sec. regardless of the shutter speed dial setting. To indicate blank exposures, the LCD displays C250 when the shooting mode selector is set at the P, S, or A position or M C250 at M.

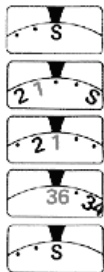

Frame Counter

The additive type frame counter is graduated from S, two dots, 1, 2, 4—up to 36—in even numbers with odd numbers indicated by white dots in between. The frame counter advances a single frame by one complete stroke of the film advance lever. After reaching frame 36 of a 36-exposure roll of film, the counter will not operate. However, film will be advanced until the actual end of the film roll. The frame counter automatically resets to S when the camera back is opened.

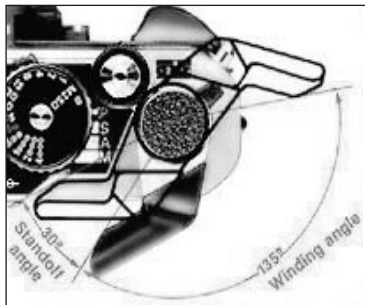

Film Advance Lever

To advance the film, wind the lever to the right completely until it stops. The lever returns to the standoff position as soon as you take your thumb off the lever. A single complete stroke advances the film one frame and simultaneously cocks the shutter.

•If the lever becomes difficult to operate at the beginning of the roll, this means that the film is not winding onto the takeup spool properly. In this case, rewind the film immediately and load again.



Memo Holder ⁽³⁴⁾

To remind yourself of the type of film and number of exposures, clip off the end of the film carton and insert it into the memo holder. Of course, you can use the holder to store something else like your name card or a handwritten note.

SETTING FILM SPEED

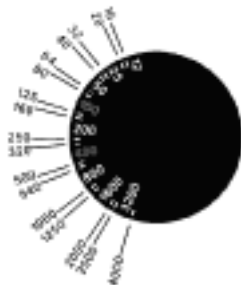

To program the camera to give the correct exposure with a particular film, you must set the camera to the correct film speed

Lift up the ASA/ISO film speed ring and rotate it in either direction until the red index dot (55) is opposite the film speed in use. The scale (56) on the ASA/ISO dial has settings from ASA/ISO 12 to 4000. Two lines between each number stand for intermediate settings, such as 64, 80, etc.

The film speed, indicated by an ASA/ISO number printed on both the film carton and cartridge, is a numerical rating of the film's sensitivity to a given amount of light: the higher the number, the greater the sensitivity, and vice versa.

- Make sure that the exposure compensation dial (53) is set at 0. If not, turn the dial until the 0 click stops opposite the red index line (51) while depressing the exposure compensation dial locking button (58).

SELECTING THE SHOOTING MODE

The Nikon FA offers four shooting modes: three automatic exposure modes, including P (programmed), S (shutter-priority), and A (aperture-priority), in addition to M (manual) mode.

Moreover, the FA utilizes an automatic multi-pattern metering system in all three automatic modes to ensure correct exposure even in difficult lighting situations. In this system, light is individually measured from five separate areas of the focusing screen and then analyzed by the camera's microcomputer, giving you the automatically corrected exposure without the need for manual exposure compensation. In the manual mode, regular centerweighted metering is always in operation. Just center the main subject in the viewfinder to get correct exposure. Selection of centerweighted metering is also possible in all automatic modes by depressing the metering control button  (refer to page 40 for more information). The metering system in use also depends on which lens is mounted on the camera (see page 18).

Each shooting mode has its own advantages as explained below. Choose your desired mode and set the shooting mode selector  to the appropriate click-stop. Intermediate settings cannot be used. According to the shooting mode you select, you must also set the shutter speed and/or aperture which will then be displayed in the viewfinder.

P (Programmed)

The optimum combination of shutter speed and aperture is automatically set by the FA's microcomputer, depending upon scene brightness, film speed, and lens focal length in use. For short lenses (less than 135mm), the FA uses a normal program to ensure correct exposure. But with telephotos of 135mm or longer, the camera automatically switches to a special

highspeed program to reduce the possibility of camera shake caused by slow shutter speeds. The P mode not only greatly simplifies operation but also lets you concentrate on picture composition, making it desirable for fast-breaking action when there isn't time to think.

S (Shutter Priority)

You set the shutter speed manually and the FA's microcomputer automatically selects the matching aperture. This mode is good for stopping fast action and required when motion is an important factor in your pictures, such as in sports photography.

A (Aperture-Priority)

Select the lens aperture first; then the FA's microcomputer selects the matching shutter speed for you. This mode is recommended when the rendition of depth must be controlled exactly. For instance, you may want to blur out the background in portraiture or make everything come out sharp in scenic photography.

M (Manual)

You set both the shutter speed and aperture manually according to the desired effect. Necessary exposure information is shown in the viewfinder. With this mode, it's possible to create intentional over- or underexposed photos. It's also good under special shooting situations. Time exposures at the B setting or mechanical release at M250 are performed in the manual mode. Flash photography with flash units other than Nikon dedicated flash units should also be performed in this mode.

BASIC OPERATION — continued

Usable Shooting Modes/Metering Method Combination Chart

Lens or accessory		Shooting mode					Metering method	
		P		S	A	M	automatic multi-pattern	centerweighted
		normal	high-speed					
AI-S Nikkor	135mm or longer	X	O	O	O	O	O	
	105mm or shorter	O	X	O	O	O	O	
AI-Nikkor		O	X	O	O	O	O	
Nikon Series E	135mm or longer	X	O	O	O	O	O	
	100mm or shorter	O	X	O	O	O	O	
AI-modified Nikkor		O	X	O	O	O	X	
PC-Nikkor		X	X	X	X	O	X	
Reflex-Nikkor		Δ	X	Δ	O	O	X	
Medical-Nikkor		X	X	X	X	O	X	
Teleconverters TC-201, TC-301, TC-14A and TC-14B		X	O	O	O	O	O	
Teleconverters TC-200, TC-300 and TC-14		O	X	O	O	O	X	
Bellows, K ring		X	X	X	O	O	X	

O = In operation or possible

X = Not possible

Δ = Because Reflex-Nikkor have a fixed aperture, the shutter speed is shifted according to the aperture, just as in the A mode.

• When using any Nikon teleconverter attached to lenses of f/1.8 or faster, no exposure compensation is required in the P, S, or A mode, but is necessary in the M mode as explained in the teleconverter's instruction manual.

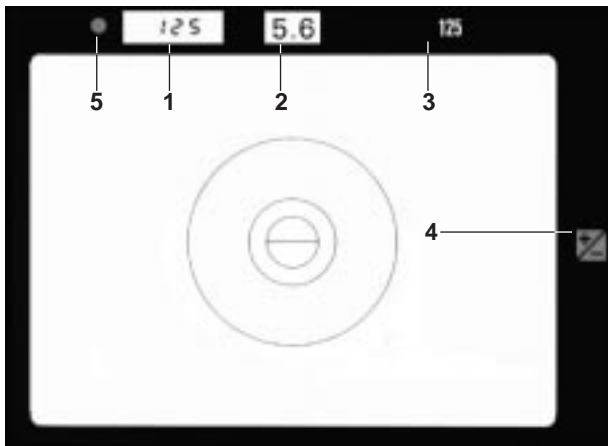

Viewfinder Information

1. LCD exposure display. Appears when the exposure meter is turned on to show you the shutter speed or aperture selected by the camera in an automatic exposure mode or the shutter speed you set in the manual mode. Although the shutter speed and/or aperture is controlled steplessly in the automatic exposure modes, intermediate shutter speeds or f-numbers appear in the display as discrete numbers which are closest to actual shutter speeds or f numbers.

2. ADR f-number. Appears in the A or M mode to show you the aperture set on the lens (AI-S Nikkor, Nikon Series E, and AI Nikkor, including AI-modified lenses).

3. Shutter speed indication. Appears only in the S mode to show you the shutter speed set on the shutter speed dial.

4. LED exposure compensation mark. Appears when the exposure compensation dial is not set to O to indicate exposure compensation.

5. Flash ready-light. Lights up to indicate flash readiness of Nikon dedicated electronic flash units

P (PROGRAMMED) MODE

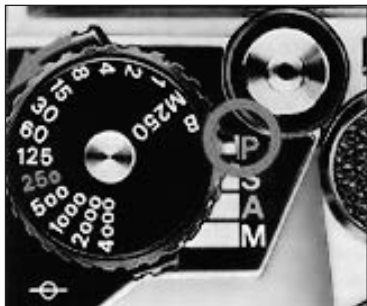

1. Set the mode selector to P.



2. Set the lens to its minimum aperture (the largest f-number). The shutter speed dial can be set at any position except M250 and B



3. Confirm that automatic multi-pattern metering is in operation by making sure that the metering control button is in the normal "out" position and the red index is not on top (refer to page 40 for more information).

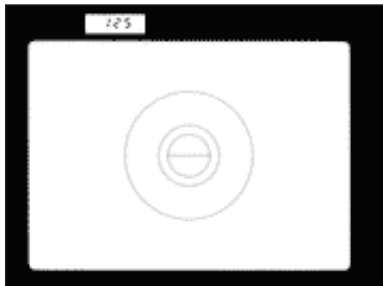

4. **Look through the viewfinder and check the exposure information.** Depress the shutter release button halfway and you will see the LCD showing the shutter speed (as a reciprocal) selected by the camera to provide correct exposure. Note that a slow shutter speed results in blurred images (techniques for avoiding blurred images are explained on page 46).

Warning Indications



If the LCD shows **HI**, this means the scene is too-bright, indicating over exposure may occur. In this case, use a neutral density (ND) filter or change to a slower speed film



If the LCD displays **Lo**, this means the scene is too dark, indicating under exposure may occur. Use an electronic flash or change to faster film.



If the LCD shows **FEE**, this means the aperture ring (65) is not set at f/11 or a larger f-number. Reset the lens to its minimum aperture. When using an AI-modified Nikkor lens, a Nikon Teleconverter TC-200, TC-300, or TC-14, or a PK ring this warning will not appear. So, be sure to set the aperture to its minimum. However, even if the aperture is set incorrectly, you can still get the correct exposure (in most cases), but the programmed aperture will be restricted to the range between the lens maximum aperture and the actual aperture you set on the lens.

BASIC OPERATION — continued

Programmed Exposure Measurement Graph

In the programmed automatic exposure mode, the FA provides the optimum combination of aperture and shutter speed to match the film speed in use and the brightness of the scene. These combinations were arrived at through intensive research and then fed into the FA's microcomputer to provide a predetermined exposure program. Thus, when actual exposure measurement takes place at the time of shooting, the ideal combination on is selected, resulting in perfect exposures for every shot.

Moreover, the FA features two different exposure programs to match the lens focal length (applies only to AI-S Nikkor and Nikon Series E lenses) The normal program is for lenses less than 135mm; the high-speed program is for 135mm and longer (including zoom lenses whose longest focal length exceeds 135mm). To minimize camera shake with telephoto lenses, the high speed program does not go below 1/125 sec until the lens maximum aperture is reached: then slower speeds are progressively chosen. With all other lenses, the normal program is in operation The high-speed program is also automatically chosen by the FA when a Nikon Teleconverter TC-201, TC-301, TC-14A, or TC-14B is attached to AI S, Nikon Series E, and AI-Nikkor (including AI-modified) lenses; with Nikon Teleconverters TC-200, TC-300, or TC 14, the normal program is in operation.

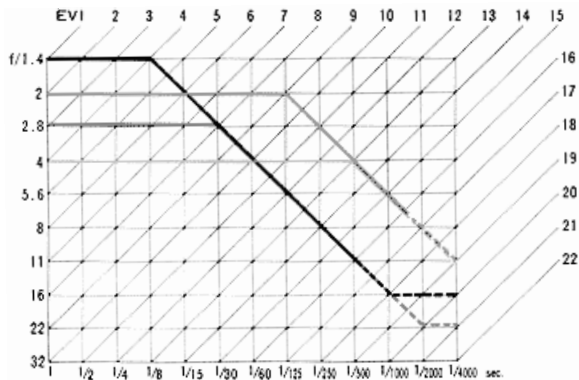

The black line represents the normal program for an AI-S or AI-Nikkor 50mm f/1.4 lens with ASA/ISO 100 film, whereas the green line represents the high-speed program for an AI-S Nikkor 135mm f/2 lens. For lenses with different maximum apertures (e.g. an AI-S or AI-Nikkor 24mm f/2.8 which is indicated by a red line or an AI-S Nikkor 200mm f/4 by a pink line), the graph is read from that particular aperture until intersection with the diagonal line and then downward along the same line. Solid program lines represent automatic multi-pattern metering, whereas solid and dotted lines centerweighted metering. In extremely bright lighting situations such as snow scenes, scenes at the beach etc exposure compensation of approx +2 EV is required with conventional centerweighted metering. Taking this into consideration, automatic multi pattern metering is pre programmed to automatically make exposure compensation by reducing extreme brightness to EV 16-1/3.

-
- *The following lenses cannot be used in the P or S mode
Zoom-Nikkor 50-300mm f/4 5 ED (older AI type without
orange minimum aperture on ADR sea/e)
AI modified Micro-Nikkor 105mm f/4*
 - *When using a Nikon Teleconverter TC 200, TC-300 or TC 14,
the shutter speed may vary by approx. one step from that
displayed in the view finder. However you will still obtain the
correct exposure.*
 - *With a teleconverter attached, shutter speeds become slower.
Than those indicated by the normal or high-speed program line,
respectively. Similarly, with an AI modified Nikkor or PK ring
attached, shutter speeds become slower. While the actual
shutter speed will be the one indicated by the LCD and correct
exposure is assured even in these cases, be sure to check the
LCD to avoid blurred images at slower shutter speeds.*

S (SHUTTER-PRIORITY) MODE

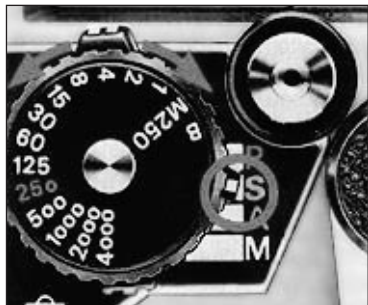

1. Set the mode selector to S.



2. Set the lens to its minimum aperture.

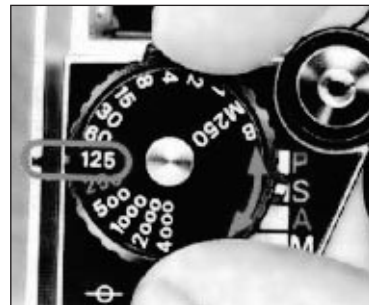

3. Set the shutter speed dial to the desired shutter speed. The numbers on the dial are reciprocals, e.g., 4000 means 1/4000sec. The 250 engraved in red indicates the fastest sync speed for an electronic flash unit. Each setting has a click stop; intermediate settings **cannot** be used. Use fast shutter speed to freeze motion or use slow speeds to produce a deliberate blur. Note that in the S mode, M250 and B settings cannot be used. (to prevent accidental missetting of the dial, a locking mechanism is provided.)



4. **Confirm that automatic multi-pattern metering is in operation** by making sure that the metering control button is in the normal “out” position and the red index is not on top (refer to page 40 for more information)

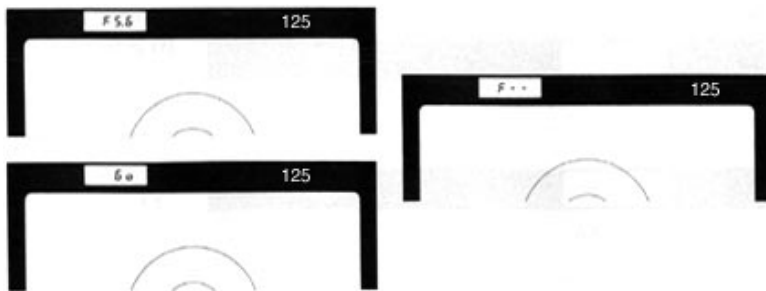

5. **Look through the viewfinder and check the exposure information.** The shutter speed you set is shown at The upper right-hand corner. When the shutter release button is depressed halfway, the LCD at the upper left-hand corner shows the aperture (a number preceded by F) selected by the camera to match the shutter speed you selected

If the LCD shows the shutter speed (a number without F), this means you cannot obtain the correct exposure at the shutter speed you selected and the camera is overriding your choice by automatically selecting a slower or Faster speed.

With an AI-modified Nikkor lens, Nikon Teleconverter TC-200, TC-300 or TC-14, PK ring or bellows attachment attached, the LCD shows **F - -**, instead of the aperture selected by the camera. In the same way, a shutter speed will appear instead of the **F - -**, if the camera automatically modifies the shutter speed you selected to obtain correct exposure

Warning Indications



If the LCD shows **HI**, this means the scene is too bright, indicating overexposure may occur. In this case, use a neutral density (ND) filter or change to a slower speed film



If the LCD displays **Lo**, this means the scene is too dark, indicating underexposure may occur. In this case, use an electronic flash or change to faster film



If the LCD shows **FEE**, this means you failed to set the lens to its minimum aperture and the scene is too bright for the aperture s U (If you failed to set the lens to its minimum aperture and **FEE** does not appear, you can still get correct exposure) In this case, reset the lens to its minimum aperture. When using an AI modified Nikkor lens, Nikon Teleconverter TC 200, TC-300 or TC 14, or PK ring, the **FEE** warning will not appear; however, the correct exposure can be obtained until **HI** appears, but the operative metering range will be reduced. So, for best results, be sure to set the aperture to its minimum.

Shutter Speed/Aperture Combinations in S mode

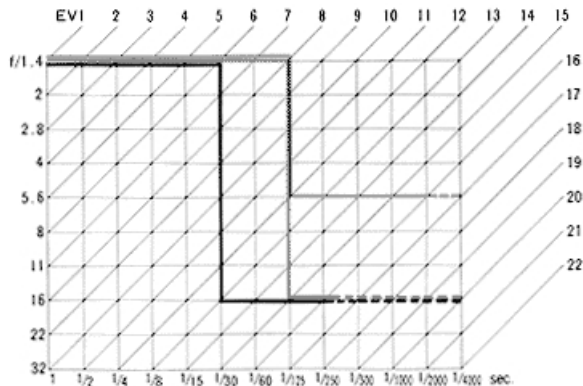

The graph shows the shutter speed/aperture combination in the S mode at ASA/ISO 100. The red line represents an AI-S or AI-Nikkor 50mm f/1.4 lens at a shutter speed of 1/125 sec, while the black line for the same lens used at 1/30 sec. The green line represents the control when the aperture ring is set by mistake to settings other than the minimum aperture (in this case, f/5.6). Solid lines represent the usable metering range for the lens when automatic multi-pattern metering is in use, solid and dotted lines show the usable metering range with centerweighted metering

-
- *The following lenses cannot be used in the P and S modes:
Zoom Nikkor 50-300mm f/4 5 ED (older AI-type without orange minimum aperture on ADR scale)
AI modified Micro Nikkor 105mm f/4*
 - *In the S mode, if an aperture of f/11 or smaller is selected the following AI-Nikkor (including AI-modified) lenses may cause approx one step slower shutter speeds than those indicated by the shutter speed indication or by the LCD in the viewfinder; however, you will still get the correct exposure. In case exact shutter speed information is desired, use the A or M mode the lenses are:
Nikkor 24mm f/2
Nikkor 28mm f/2
Nikkor 35mm f/1.4
Nikkor 35mm f/2
Nikkor 35mm f/2.8
Nikkor 50mm f/ 1.2
Nikkor 50mm f/1.8
Nikkor 50mm f/2
Nikkor 55mm f/ 1.2
Noct Nikkor 58mm f/12
Nikkor 105mm f/2.5 (The same thing happens with this lens at aperture between U5 6 and f/16)
Nikkor 135mm f/2.8
Nikkor 200mm f/4*
 - *When using a Nikon teleconverter TC 200, TC 300, or TC 14, the shutter speed may vary by approx one step from that displayed in the viewfinder. However, you will still obtain the correct exposure.*

A (APERTURE-PRIORITY) MODE

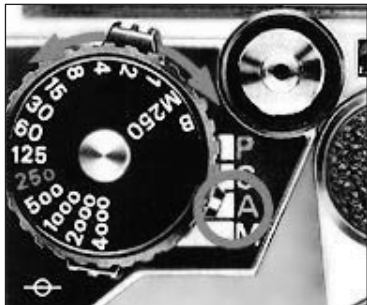

1. Set the mode selector to A.



2. Set the lens to the desired f-number. Although each number on the lens aperture ring has a click stop, you can also set the ring to intermediate settings. Note that small apertures give greater depth of field, while large apertures restrict the zone of sharp focus to the main subject. The shutter speed dial can be set at any position except M250 and B



3. Confirm that automatic multi-pattern metering is in operation by making sure that the metering control button is in the normal "out" position and the red index is not on top (refer to page 40 for more information).

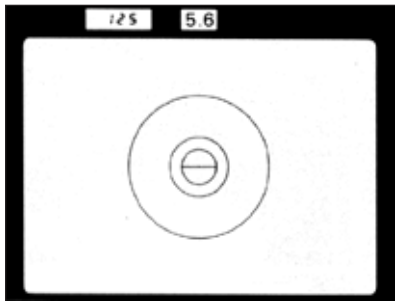

4. **Look through the viewfinder and check the exposure information.** The aperture you set is shown through the ADR window ①. When the shutter speed selected by the camera to obtain correct exposure with the aperture you set. If necessary, use a wider aperture to prevent a slow shutter speed from causing blurred images. (For additional information on avoiding blurred images, see page 46.)

Warning Indications

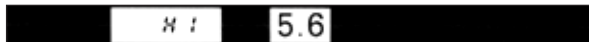

If the LCD shows **HI**, this means the scene is too bright and there is no shutter speed to match the aperture you selected. In this case, overexposure may occur. To prevent this, stop the lens down until **HI** disappears, if all else fails, attach a neutral density (ND) filter to the lens or change to a slower speed film.



If the LCD displays **Lo**, the scene is too dark and there is no shutter speed to match the aperture you selected. In this case, underexposure may occur. To prevent this, select a wider aperture or, if necessary, attach an electronic flash. As a last resort, change to a faster film.

M (MANUAL) MODE



1. Set the mode selector to M.



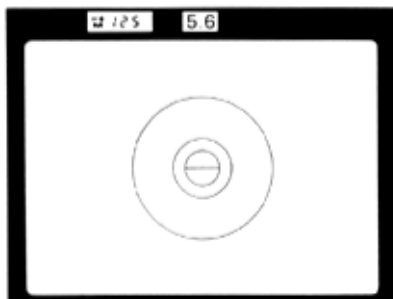

Correct exposure

M 125

Underexposure

M 250

Overexposure

M 60

4. Center your main subject in the viewfinder and check the exposure information. Remember that in the manual mode, centerweighted metering is always in operation regardless of the position of the metering control button. The selected f-number is shown through the ADR window. When the shutter release button is depressed halfway, the LCD shows the selected shutter speed preceded by the letter M.

If the + indication is displayed above the M, you will get the correct exposure with the selected combination of aperture and shutter speed. If only - is shown, this indicates possible underexposure: use a wider aperture or a slower shutter speed. If only + is shown, this indicates possible overexposure: in this case, use a smaller aperture or faster shutter speed.

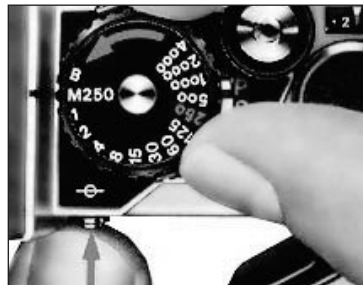

M250 and B Settings

At M250 and B, the FA's shutter is mechanically controlled without the exposure meter being activated or exposure information appearing in the viewfinder.

At M250, the shutter operates at a mechanical speed of 1/250sec. This setting is used when the batteries are depleted and other shutter speeds are not operable. It also can be used for flash photography.

At B, the shutter remains open for as long as the shutter release button is depressed. B is especially useful for making long time exposures with a cable release and tripod.

A locking mechanism is provided between 1 and M250 on the shutter speed dial. To set either M250 or B, depress the locking button (2) and rotate the dial to either M250 or B.

- *At these mechanical settings, you must depress the shutter release button a little bit more than at other settings to trip the shutter. Note that with the Soft Shutter Release AR 9 attached, you cannot release the shutter at these settings.*

HOLDING THE CAMERA



Many blurred shots are caused by unsteady holding of the camera. The basic shooting posture is: Hold the camera at eye level while looking through the viewfinder. Cradle it in your hands with the fingers of your left hand wrapped around the lens barrel and your elbow propped against your body for support. Grasp the handgrip ⑥, with your right hand and use your index finger to depress the shutter release button and your thumb to wind the

film advance lever. You can look through the viewfinder with either the right or left eye, while the other eyes are open or closed. It's easy to adapt this basic posture to both horizontal- and vertical-format shooting. To hold the camera steady, stand with your feet flat on the ground and slightly apart; if possible, lean on or against something strong and stable, such as a wall, especially when using slow shutter speeds.



Detachable Handgrip

The FA's handgrip not only allows steady shooting but also fits comfortably in your hand. However, when shooting with a motor drive, you should remove the grip first. To do this, insert a coin into the slot, turn the screw ⑦ counterclockwise until it loosens, then slide the grip down until it separates from the body.

To reattach, align the grip attachment screw with the inner hole in the handgrip, slip the grip up until it stops, then screw clockwise until it becomes tight.

FOCUSING

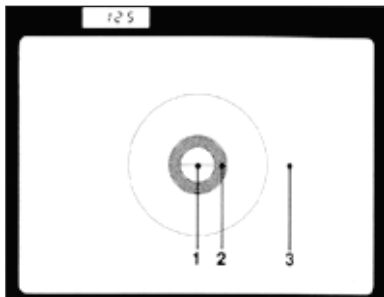

1. Split-image rangefinder
2. Microprism collar
3. Matte field

The FA-comes equipped with Type K2 focusing screen suitable for all-purpose photography. While looking through the viewfinder compose your photo and turn the focusing ring (45) of the lens until the subject looks clear. For precise pinpoint focusing on subjects with distant contours, use the central split-image rangefinder; turn the focusing ring until the split image becomes whole (A). For rapid focusing and for subjects with indistinct outlines, use the microprism collar; turn the focusing ring until the shimmering image becomes sharp (B) In close up

or microphotography, or when using telephoto lenses with maximum apertures of approx $f/4.5$ or smaller, the split-image spot and microprism collar are likely to darken. Therefore, use the matte portion of the screen; turn the focusing ring until the image looks sharp (C).

•Finder coverage of the FA is approx 93%; therefore the actual image size will be slightly larger than the image seen in the viewfinder.

(A) Split-image focusing

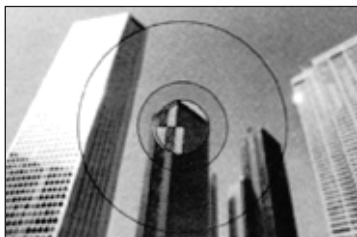

Out of focus

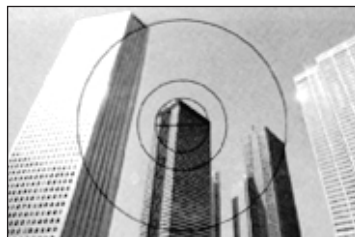

In focus

(B) Microprism focusing



Out of focus



In focus

(C) Matte field focusing

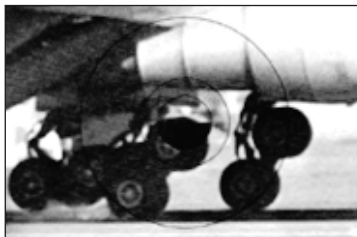

Out of focus

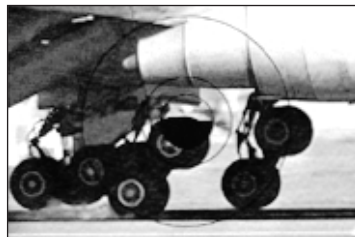

In focus

TAKING PICTURES



Trip the shutter by pushing the shutter release button all the way down; apply light but steady pressure with the ball of your index finger to avoid camera shake which might result in blurred images.

The shutter release button is threaded in its center to accept a standard cable release for tripping the shutter with the camera mounted on a tripod.

- The shutter cannot be tripped unless : a) the film advance lever is pulled out to standard position, b) the film advance lever is stroked completely to cock the shutter and c) the batteries are in proper working order. To release the shutter when the batteries are dead use a mechanical setting of M250 or B
- When using a tripod be careful not to screw it into the camera's tripod socket (41) too tightly, as this might damage the camera. Also if the tripod has a large head, contact between the lens barrel and the head may make it impossible to turn the lens aperture ring. In this case use the special tripod adapter (supplied with the camera) between the tripod head and the camera body.

UNLOADING FILM

When the film reaches the end of the roll, the film advance lever cannot be wound any further. In this case, rewind and unload the film without forcing the lever using the following procedure.



1. Push the film advance lever back into place to turn off the camera and lock the shutter release button. This action prevents inadvertent shutter release.



2. Depress the rewind button ⁽³³⁾ on the bottom of the camera. You don't have to apply continuous pressure to the button; just press it once.



3. **Rewind the film** unfolding the film rewind crank and turning it in the direction of the arrow. When you feel the tension lessen, give it a few more turns until crank turns freely, indicating the film leader is rewound completely back into the cartridge.



4. **Open the camera back and take out film cartridge.** Avoid unloading in direct sunlight. If there is no shade available, turn your back to the sun and use your own shadow to shield the camera.

EXPOSURE METERING SYSTEM

The Nikon FA employs through-the-lens (TTL) full aperture exposure metering. This means that light passing through the lens is measured at maximum aperture, thus assuring a bright finder image during shooting. Furthermore, to make exposure measurement easier than ever, the Nikon FA features two types of metering methods—automatic multi-pattern and centerweighted. In automatic multi-pattern metering, light from five separate areas of the focusing screen is metered individually so that not only brightness in the central area but also around the outside is measured. This exposure data is then fed into the FA's micro-computer where it is compared with various predetermined metering patterns stored in the memory. Only then is the exposure determined, thus assuring the correct automatic exposure. By just composing the picture and tripping the shutter, you can get good results even in difficult lighting situations where experience and complicated exposure-compensation techniques would be required with conventional centerweighted metering. In regular centerweighted metering, special emphasis is placed on the brightness in the 12mm-diameter central area. So, by placing the main subject in the center of the frame, you can get the correct exposure in most situations. Centerweighted metering is also highly recommended when you want to create special effects, such as high-key or low-key photographs.

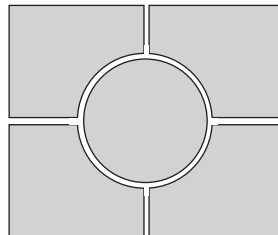

Automatic multi-pattern metering

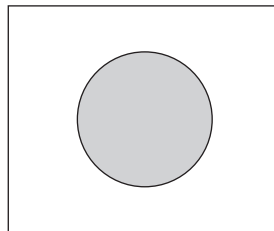

Centerweighted-metering

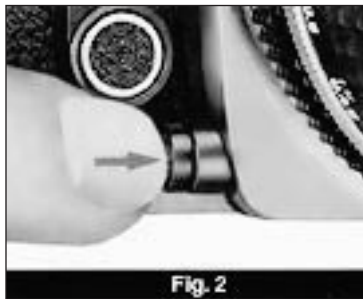

Metering Control Button

To change from one metering method to the other, the Nikon FA features a metering control button. In its normal "out" position, you cannot see the red index (Fig. 1). In this position, the automatic multi-pattern metering method is automatically operating with the camera set at any of its automatic modes and with an AI type Nikkor lens attached

At any time, you can change to centerweighted metering by simply pushing in the button (Fig. 2). To lock it in position, hold on the button as you rotate it clockwise until the red index faces up (Fig 3) With the button at the "in" position, metering is always centerweighted.

To return the button to the normal "out" position, rotate it counterclockwise until the red index disappears. Confirm that the button is in the "out" position after you remove your finger. Regardless of the position of the button, metering is always centerweighted when the camera is in the manual mode or when a lens other than an AI-S Nikkor, AI-Nikkor or Nikon Series E is used.

Comparison of Automatic Multi-Pattern and Centerweighted Metering

If you compare the automatic multi-pattern and centerweighted metering systems, meter readings are virtually the same for ordinary front-lit subjects or scenes having little difference in contrast between the main subject and the background.

However, with scenes containing both very bright and very dark areas, the results are quite different. For example:

Outdoor backlit subjects

A backlit subject or a scene containing people against a bright sky and/or clouds may lead to an underexposed shot with centerweighted metering. But with automatic multi-pattern metering, exposure compensation is automatically made, giving more exposure to the darker subject to ensure the correct overall exposure.

Outdoor backlit subject



Automatic Multi-pattern



Centerweighted

Front-lit subject against dark background

If a brightly lit subject is positioned against a dark background, and is not in the center, centerweighted metering places too much emphasis on the dark center of the picture. The result is a correctly exposed background, but an overexposed main subject. However, with automatic multi-pattern metering, the camera automatically integrates both the dark background and bright subject to ensure the best overall exposure.

Scenes with high reflectivity

If a scene contains spectral highlights, such as the sun itself or bright reflections from water or metallic objects, the main subject will come out as a silhouette with regular centerweighted metering. However, with automatic multi-pattern metering, the light value of the darker parts is also measured, resulting in a well-balanced exposure. In addition, overall bright scenes, such as snow scenes, come out correctly exposed with automatic multi-pattern metering. What happens is that extreme brightness is uniformly reduced to EV 16-1/3, automatically making the right amount of exposure compensation for correct exposure.

Front-lit subject



Automatic Multi-pattern



Centerweighted

Scene containing the sun



Automatic Multi-pattern



Centerweighted

Scene containing bright reflection



Automatic Multi-pattern



Centerweighted

On the other hand, certain subjects are difficult for automatic multi-pattern metering to handle. For example:

Sunrises and sunsets

Here, you should change to centerweighted metering, especially when you want to emphasize the sun and clouds. With automatic multi-pattern metering, the sky comes out too light. Similarly, whenever you want to make the light source the subject of the picture, such as when shooting neon signs at night, you should select centerweighted metering.

Sunrise



Automatic Multi-pattern



Centerweighted

Indoor backlit subjects

If the main subject is indoors in front of a bright window, underexposure may occur even if the subject occupies a large portion of the picture area because the difference in contrast between subject and background is too great for the camera to handle. And even with centerweighted metering, the results may not be acceptable when shooting on automatic. The best solution is to switch to the manual mode (in which centerweighted metering is always in operation) and make manual exposure compensation as explained on page 52. As an alternative use an electronic flash to obtain correct exposure for the main subject.



Indoor backlit subject



Automatic Multi-pattern



Centerweighted

RELATIONSHIP BETWEEN SHUTTER SPEED AND APERTURE

Shutter Speed (sec.)	1/4000	1/2000	1/1000	1/500	1/250	1/125	1/60	1/30
Aperture (f-number)	1.4	2	2.8	4	5.6	8	11	16

The amount of light reaching the film plane is determined by a combination of shutter speed and lens aperture. A shutter speed of 1/125sec. lets in twice as much light as a setting of 1/250sec and only half as much light as 1/60sec. An aperture setting of f/11 lets in twice as much light as f/16, half as much as f/8. Thus, if the correct exposure for a particular picture-taking situation is 1/500 at f/4, then 1/250 at f/5.6 or 1/125 at f/8 will give the same exposure.

The table above is one example showing the interrelationship between shutter speed and aperture. Each combination produces correct exposure but the effects of the pictures are quite different. The best combination will depend on the results you want. Fast shutter speeds freeze motion while slow speeds produce a deliberate blur. Also, small apertures give greater

depth of field, while large apertures restrict the zone of sharp focus to the main subject. (Refer to page 48 for details on depth of field.)

A good rule to follow in preventing camera shake is to select a shutter speed which is never slower than the reciprocal of the focal length of the lens in use. For example, when using a normal 50mm lens, select a speed no slower than 1/60sec (the closest number to 1/50). For a 200 mm super-telephoto, use no less than 1/250 sec., and so forth.

If a slow shutter speed is necessary or the camera selects one in the automatic exposure modes, attach the camera to a tripod. As an alternative, use an electronic flash or change to faster film.



A fast shutter speed of $1/4000\text{sec.}$
stops the water in midair.



At a slow $1/30\text{sec.}$
the water comes out a blur.

DEPTH OF FIELD

When you shoot at a certain aperture and focusing distance, you will find that not only the main subject but also objects within a certain range in front of and behind it will be sharp in the final photograph. This "in focus zone" is known as depth of field. Objects beyond this range become increasingly out of focus. When the zone of sharpness is large, depth of field is deep; when it is small, depth of field is shallow. The following is true of depth of field:

- 1) The smaller the shooting aperture (i.e., the larger the numerical f-number), the deeper the depth of field; the larger the aperture, the shallower the depth of field.
- 2) The farther away the subject is from the lens, the deeper the depth of field becomes; the closer to the lens, the shallower the depth of field.
- 3) The longer the focal length of a lens, the shallower the depth of field at each f/stop, the shorter the focal length, the deeper the depth of field.
- 4) There is greater depth of field behind the main subject than in front of it.

The depth of field at each aperture is indicated on the lens by a set of color-coded lines (62) (corresponding to the colors of the f-numbers on the aperture ring (65)) which are used in conjunction with the distance scale (63) on the focusing ring (45). The range is indicated by the distance between the lines.



When a lens with an automatic diaphragm is used, the image in the viewfinder is viewed with the lens at maximum aperture. However, when the depth-of-field preview lever's is pushed down, the lens will be stopped down to the aperture set, enabling you to examine depth of field before shooting. The image in the viewfinder darkens according to the selected f-number, the smaller the aperture, the darker the image. Portions of the picture that appear in focus when the lever is pushed down—will be in the zone of sharp focus.

Note that the lever should be depressed all the way.

This lever is also used for stop-down exposure measurement (refer to page 54.)

- *Certain Zoom-, Reflex-, and PC-Nikkor lenses do not have a depth-of-field scale*

- *Pushing the lever automatically changes the metering method from automatic multi-pattern to centerweighted*

- *Depth-of-field can be previewed only in the A and M modes*



Lens set at f/2



Lens set at f/16

EXPOSURE COMPENSATION



Suggested Applications for Exposure Compensation



- +2 White background, snow scene
- +1 White background occupying half of viewing area
- 1 Spotlighted subject, black background occupying half of viewing area
- 2 Black background

In Automatic Exposure Modes

If you elect to use centerweighted metering in any of the automatic exposure modes, you can use the exposure compensation dial to obtain the correct exposure for the types of picturetaking situations listed above. Also under normal conditions, you can create special "high-key" or "low-key" effects by intentionally over- or underexposing the shot. Note that before using the exposure compensation dial, you must switch to centerweighted metering. In automatic multi-pattern metering, you cannot obtain the necessary amount of compensation.

The exposure compensation dial is graduated in one-third stop increments; -1 and -2 indicate one and two stops less exposure, whereas +1 and +2 indicate one and two stops additional exposure. At ASA/ISO 4000, the compensation extends to only -1; at ASA/ISO 12, up to +1.



To operate, press the locking button  and turn the dial until the desired compensation value is opposite the red index . As a reminder, a red LED exposure compensation mark (+/-) appears on the right side of the viewfinder as soon as the exposure meter is turned on

After use, make sure you reset the dial so that 0 is opposite the index



In the Manual Mode

There are two situations where it is difficult to get the correct exposure on automatic with centerweighted metering. They are (1) a front-lit scene with the main subject off-center and (2) an indoor backlit subject with the main subject either in the center or off-center. Therefore, to get the correct exposure, switch to the manual mode and follow this procedure:

- 1) For front-lit subjects, just center the main subject. For backlit ones, you should move in close until it fills up the frame. (When taking a close-up meter reading, be careful not to cast a shadow with your own body or the camera.)
- 2) Depress the shutter release button halfway to turn on the meter and adjust the shutter speed and/or aperture for correct exposure
- 3) Recompose the scene as you like and take the picture.

Remember that in the manual mode, the exposure compensation dial does not operate, so the only way to make exposure compensation is by centering the main subject in the viewfinder and, if necessary, taking a close-up meter reading.

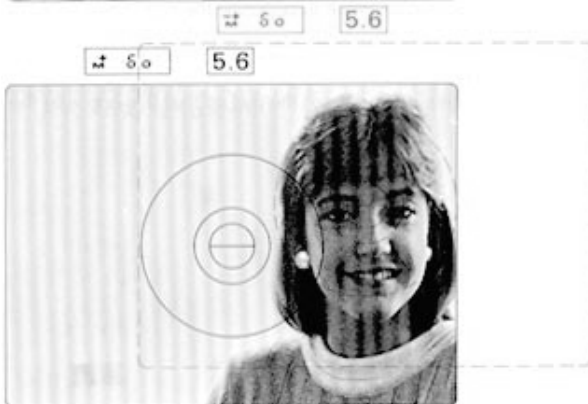

Duplication Work and Photomicrography

In copy work, slide duplication, and photomicrography, you must make exposure compensation with centerweighted metering, because these types of photography represent unusual contrast situations. Some lenses automatically switch the metering method to centerweighted. The table below shows the relationship between specific types of photos and proper exposure. Since this is meant to be only a guide, in practice you should make further compensation by experimentation until you achieve the proper results.

- *The exposure compensation values listed below are reference data obtained when general purpose film was used. With color reversal film or microfilm for duplication work, it is advisable to take additional shots with + one stop exposure compensation as these films have very small exposure latitude.*
- *To avoid vibration, you can make the exposure by turning the illumination on and off*
- *It is advisable to use a cable release to eliminate camera vibration.*

	Subject	Method of exposure measurement	Exposure compensation	Required accessories	Remarks
Copy work	Photographs and pictures with continuous gradation	Full-aperture or stop-down	Compensation not necessary	Micro Nikkor 55mm f/2.8; Cable release	For high contrast subjects, use of an 18% reflectance gray card in determining exposure is recommended. With the card, no exposure compensation is required regardless of whether the background is black or white.
	Documents and drawings of high contrast		Approx. + 1 to + 2 stops for black letters on white background: approx. -1/2 to -1 stop for white letters on black background.		
Slide duplication	Slide with continuous gradation	Stop-down	Approx + 1 to +2 stops	Micro-Nikkor 55mm f/2.8; Nikon Slide Copying Adapter PS-6: Nikon Bellows Focusing Attachment PB36- Cable release	When using Nikon Slide Copying Adapter PS-6, set the flood lamp 30cm away from its opal plate
	Slide of documents and drawings photographed		Approx + 1 1/2 to +2 1/2 stops for black letters on white background.		
			0 to approx -1 /2 stop for white letters on black background		
Photo micrography	Prepared specimen	Stop-down	Approx. +1 stop	Microflex PFX	Generally, results come out better with more exposure in photomicrography. The compensation value on the left is only a guide: determine the compensation value by test shooting

STOP-DOWN EXPOSURE MEASUREMENT

Stop-down exposure measurement must be made whenever the aperture ring of the lens doesn't couple with the meter coupling lever, ~, of the camera. After focusing and switching on the meter, follow these procedures:

For Lenses with Automatic Diaphragms

In P, S, or A mode: Push the depth-of-field preview lever all the way down, manually stop the lens down or open it up to your desired f-number, and trip the shutter while holding the lever. Note that, with the lever depressed, metering is automatically switched to centerweighted

In M mode: Hold down the preview lever and turn the shutter speed dial and/or lens aperture ring until the LCD shows --+, indicating correct exposure on manual. Release the preview lever and take the shot.

•If the depth-of-field lever is pushed down in the P or S mode, the shooting mode is automatically switched to the A mode; also the LCD shows the shutter speed selected by the camera for the aperture in use In the S mode, the shutter speed indication showing the shutter speed set on the dial does not disappear.

For Lenses or Accessories Without Automatic Diaphragms

In A mode only: P and S modes should not be used. Stop the lens down manually until the desired shutter speed appears in the viewfinder Then take the picture.

In M mode: Adjust the shutter speed or aperture until the --+ indication appears above M

For Fixed-Aperture Lenses, Photomicrography, or Astrophotography

In P, S, or A mode: No adjustment of aperture and shutter speed is necessary; just take the picture. In M mode: Adjust the shutter speed dial until the LCD shows --+, indicating correct exposure on manual. If correct exposure is unobtainable, use an ND (neutral density) filter or electronic flash unit As a last resort, change to a faster or slower film.

MULTIPLE EXPOSURE PHOTOGRAPHY



A multiple exposure is created by taking more than one shot on the same frame of film. Follow this procedure:

- 1) **Take the first shot.**
- 2) **Push the multiple exposure lever⁽⁷²⁾ in the direction of the arrow** as you wind the film advance lever⁽⁷⁴⁾ fully. The film and frame counter⁽⁷¹⁾ will not advance; only the shutter is cocked. Although your finger will naturally slip off the lever as the film advance lever is wound, multiple exposure operation will have been performed correctly.
- 3) **Take the second shot** after winding the film advance lever fully.

To make three or more exposures on the same frame, just repeat the same procedure for each additional exposure.

•In multiple exposure photography, the M is designed to reduce film dislocation to the minimum. But it may occur due to film curling, film slack or inappropriate film winding.



UNMANNED PHOTOGRAPHY

To include yourself in your pictures, you can mount the FA on a tripod and use the self-timer to trip the shutter. Or by attaching a motor drive, you can control the FA from a distance with optional remote control accessories or an intervalometer.

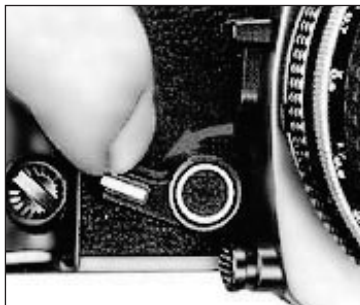
**Self-Timer**

To set the self-timer, push the self-timer lever [ⓑ] down as far as it will go. This can be done either before or after the film is advanced. After the self-timer has been set, press the shutter release button [ⓓ].

Immediately the reflex mirror [ⓔ] will rise and the self-timer will start to operate; the shutter is then released approx. 10 sec. later. If you want to cancel self timer operation after the lever has been set, move it back to its original position. You can then take pictures in the normal way. However, returning the selftimer lever to its original position after self-timer operation has begun will immediately trip the shutter. The self-timer can be used at any shutter speed dial setting except B.

INFRARED PHOTOGRAPHY

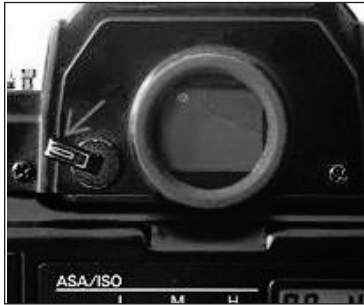

Eyepiece Shutter

When unmanned photography is performed with the FA in one of its automatic exposure modes, stray light entering the eyepiece will affect the meter reading. To prevent this, use the eyepiece shutter. Just push the lever up to close the shutter. As a visual reminder that it is in use, the shutter blind is painted red.



To create other-worldly effects, in which vegetation comes out light in tone and blue skies very dark, try shooting with black and white infrared film. In black and white infrared photography, you must use a red filter (R60) and refocus the lens to compensate for the fact that infrared light rays focus at a point slightly in front of visible light. For this purpose, most lenses have an infrared focusing index ⁽⁴⁷⁾ (a red dot or line) beside the distance index ⁽⁴⁴⁾ as a rule of thumb.

Follow this procedure:

- 1) Without the red filter in place, look into the viewfinder and focus on your subject.
- 2) Look at the lens and take note of the focused distance.
- 3) Reset the focusing ring so that the desired distance is aligned with the infrared focusing index.
- 4) Attach the red filter and take the shot.

FLASH PHOTOGRAPHY

An electronic flash unit is convenient not only for night and dimlight shooting but also as a supplementary light to fill in the shadows in daylight. Daylight fill-in flash is especially effective when shooting outdoor subjects which are backlit or in motion. With a Nikon dedicated flash, such as the SB-15 SB-16B or SB-18, the FA offers fully automatic through-the-lens (TTL) control of the flash exposure. This means that while the shutter is open, a special silicon photodiode (SPD), located at the bottom of the mirror box, reads the light reflected directly off the film and determines the timing to cut off the flash output, ensuring correct exposure.



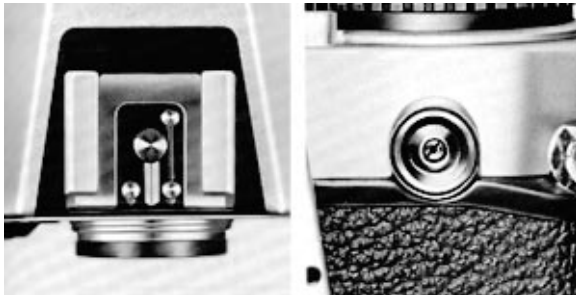

Accessory Shoe ⁽⁷⁸⁾ and Sync Terminal ⁽¹⁴⁾

The accessory shoe of the FA allows direct mounting of the Nikon Speedlight SB-15, SB-16B, SB-18, SB-19 or other electronic flash with an ISO-type mounting foot. Other flash units may be mounted with a flash unit coupler (see table on page 61). Four electrical contacts ⁽⁵⁹⁾ ⁽⁶⁰⁾ ⁽⁶¹⁾ ⁽⁶⁷⁾ in the shoe provide the following: proper synchronization of the flash unit, automatic flash output stop, identification of a TTL flash unit, and both ready-light indication in the camera's viewfinder (via and LED) and autoswitching to the proper sync speed of 1/250sec. with Nikon dedicated flash units.

To use flashbulbs or an electronic flash unit without a hot-shoe contact, use the camera's sync terminal. The FA's sync terminal with a protective screw-in cover, accepts all standard plug-in PC cords. It is also threaded for use with a Nikon screw-in PC cord.

The FA features an X-sync contact only, allowing electronic flash units to be synchronized at a speed of 1/250sec or slower to prevent mistakes, the camera also offers automatic switchover of the shutter speed for proper synchronization with the SB-15, SB-16B, SB-18, SB-19, etc., as shown in the table on the next page. For creative fill-in flash effects, you can set the speed manually to 1/250sec or below and the shutter fires at the speed set with the speed in use displayed in the viewfinder.

Flashbulbs can also be used at the following shutter speed sync ranges.

Shutter speed (sec.)	1/4000	1/2000	1/1000	1/500	1/250	1/125	1/60	1/30-1	M250	B
Speedlight										
M, FP and MF Flashbulbs										

Synchronized
 Cannot be use

- *The use of other manufacturers' flash units, even with the same ISO-type mounting foot, may cause abnormalities to the IC circuitry. Units having a high voltage synchro circuit may also affect shutter speed precision.*
- *When using a special electronic flash unit that has provision for time lag, adjust the shutter speed down to 1/125 sec. or slower according to the time lag.*

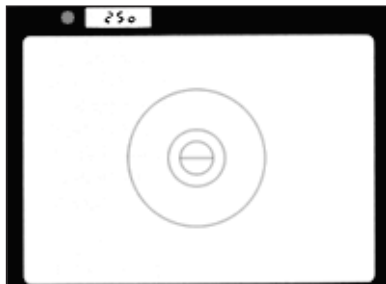

Ready-Light Indication in the Viewfinder

When the Nikon FA is used with Nikon Speedlights SB-15, SB-16B, SB 18, SB 19, etc, the FA's ready-light LED in the viewfinder lights up when the flash is recycled. This way, you're easily informed of flash readiness without having to take your eye away from the viewfinder. Depending on which Nikon flash unit is attached, the same LED blinks to warn of insufficient flash output. incorrect setting of the flash unit or incorrect setting of the FA. The more detailed information, refer to the flash unit's instruction manual.

Relationship Between Camera's Meter, Ready-Light Indication and Shutter Speed

Shooting Mode Selector	Shutter speed dial setting	Camera's exposure meter				
		On			Off	
		Ready-light	LCD indication	Actual shutter speed (sec.)	Ready-light	Actual shutter speed
P,S,A*	All except M250 and B	light up	250	1/250	Does not light up	-
M	1/4000-1/500sec	light up	M250**	1/250	Does not light up	-
	1/250-1sec	light up	as set	as set	Does not light up	-
P,S,A,M	M250, B	-	-	-	light up	as set

* Because automatic exposure modes are cancelled as soon as the flash unit is turned on, you should determine the proper aperture beforehand.

** + and/or - indication on M disappears as soon as the flash unit is turned on.

Nikon FA/Speedlight Combination Chart

Speedlight	Connection	Camera's ready light indication	Shutter speed automatically switched to 1/250sec.	Usable flash modes
SB-19	direct	provided	yes	auto
SB-18	direct	provided	yes	TTL, manual
SB-17	via AS-6 coupler	provided	yes	auto, manual, MD
SB-16A	via AS-6 coupler	provided	yes	auto, manual, MD
SB-16B	direct	provided	yes	TTL, manual, auto, MD
SB-15	direct	provided	yes	TTL, manual, auto, MD
SB-11/14	via SC-11 sync cord	not provided	no	auto, manual
	via SC-13 sensor cord	provided	yes	auto, manual
SB-12	via AS-6 coupler	provided	yes	manual
SB-10	direct	provided	yes	auto, manual
SB-7E	via AS-2 coupler	not provided	no	auto, manual
SB-6	via SC-6 sync cord	not provided	no	manual
	via AS-2 with SC-9 extension cord (w/SU-1)	not provided	no	auto, manual
SB-E	direct	provided	yes	auto

CLOSE-UP PHOTOGRAPHY



For shooting subjects which are located closer than the closest possible focusing distance of the lens, Nikon offers a wide variety of close up equipment as shown below.

In close up photography, depth of field is usually quite shallow.

Thus, you should stop the lens down as much as possible when photographing a subject having great depth

To focus in close-up photography, use the matte portion of the screen. Or replace the standard Type K2 focusing screen with the Type B2 or E2 screen. (For details about interchangeable focusing screens, refer to page 66.)

To measure the exact distance between the subject and film plane, use the film plane indicator Λ -r which indicates the exact position of the film plane inside the camera. The distance between the film plane and the lens mounting flange is exactly 46.5 mm.

Close-Up Equipment

- **Close-Up Attachment Lenses Nos. 0, 1, 2, 3T, 4T, 5T, 6T.**

These lenses screw into the front of the lens just like filters to magnify the image. Exposure metering can still be done at full aperture without compensation.

- **Auto Extension Rings PK-11, PK-12, PK-13.** These fit between the lens and camera body. Used singly or in combination, exposure determination is done at full aperture with all AI-type lenses.
- **Bellows Attachment PB-6.** The PB-6 is also attached between the lens and camera body. Exposure is determined by the stop-down method with centerweighted metering. The beauty of this accessory is that you can change magnifications continuously by extending the bellows.
- **Micro-Nikkor 55mm f/2.8, 105mm f/2.8, 200mm f/4 IF lenses.** These specially designed lenses for close-up photography offer continuous focusing from infinity down to 1/2X lifesize.



Micro-Nikkors



Bellows Attachment



Auto Extension Rings



Close-Up Lenses

ACCESSORIES

ELECTRONIC FLASH UNITS

Designed to complement the versatility of the FA, Nikon has three electronic flash units which mount directly to the camera's accessory shoe and feature automatic TTL (through-the-lens) control of the flash exposure Also, with the camera in one of the automatic exposure modes (P, S and A), or manually set at 1/500sec. or faster, the proper synchronization speed of 1/250 sec is automatically set.

Speedlight SB-15

Features special tilting flashtube module for bounce flash or shooting close-ups Guide number of 25 (ASA/ISO 100 and meters) or 41 (ASA/ ISO 25 and feet).

Speedlight SB-16B

Most versatile direct-mounting flash from Nikon. Truly creative bounce flash possible with two flash heads: main head has zoom settings for 28, 35, 50, and 85 mm lenses and tilts back 90° and rotates 270°: smaller secondary head faces straight ahead to provide a catchlight in the eyes Special MD (motor drive) setting allows shooting of 8 consecutive frames at 4 frames per second Powerful guide number of 32 (ASA/ISO 100 and meters) or 52 (ASA/ISO 25 and feet).

Speedlight SB-18

Lightweight and easy to operate Choice of TTL or manual control Guide number of 20 (ASA/ISO 100 and meters) or 33 (ASA/ ISO 25 and feet).



MOTOR DRIVES

Motor Drive MD-15

The use of the Motor Drive MD-15 with the FA enables automatic film advance when the unit's trigger button is pressed. In addition to single frame shooting, continuous firing at the maximum rate of 3.2 frames per second is possible (at 1/125 sec or faster). The MD-15 is very convenient when shooting fast-moving subjects since the photographer does not have to wind film manually or take his eye off the subject.

To attach, remove the FA's handgrip and engage the tripod socket of the camera with the mounting screw of the motor drive.

With the MD-15 attached, the FA is powered by batteries inside the motor drive.

Motor Drive MD-12

The FA also accepts the Motor Drive MD-12 for approx. 2.7 frames per second shooting (at 1/125sec or faster). Compared with the MD-15, it takes slightly longer for the shutter to be released after you depress the MD-12's trigger button.

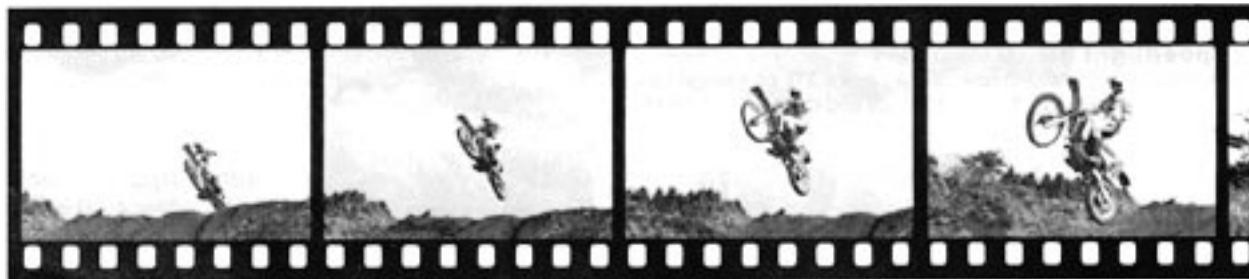

MISCELLANEOUS

Data Back MF-16

To keep track of when photos were taken, the FA accepts the slim, lightweight Data Back MF-16. This back attaches in place of the FA's regular camera back with no sync cord required. Three imprinting modes are provided: year/month/day (up to the year 2100), day/hour/minute, or picture counting (up to 2000): each mode is displayed on the data back in clear LCD numerals and printed by LED's, on the photo in unobtrusive red numerals. Serving as a handy clock, a quartz timer with alarm is incorporated

- *The Nikon FA a/so accepts Data Back MF 12. In this case, use the cord provided with the data back to connect the socket contact of the MF-12 to the sync terminal of the camera.*



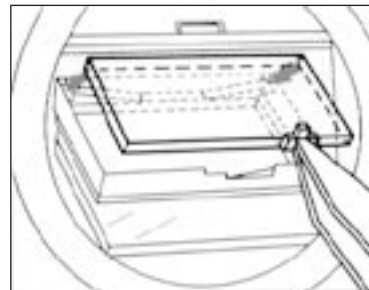



Interchangeable Focusing Screens

Three different types of focusing screens are usable with the Nikon FA. The Type K2 screen comes with the camera as a standard accessory. Two optional focusing screens, Type B2 (matte/Fresnel with focusing spot) and Type E2 (matte/Fresnel with focusing spot and etched grid lines) are also available for the FA to match your particular requirements.

To change focusing screens, follow this procedure:

1. Remove the lens from the camera body.
 2. Slip the small tip of the special tweezers (that come with the optional screens) under the focusing screen release latch 4 at the top front of the mirror box casting and put outward to spring open the holder.
 3. Take the screen out by grasping the small tab with the tweezers.
 4. Carefully position another screen in place with the flat side facing down and the side with the tab facing up.
 5. Then push the front edge of the holder upward with the tweezers until it clicks into position.
- *To avoid getting smudges or fingerprints on the screen's optical/ surface, do not handle the screen with your fingers.*

Focusing Screen Selection Guide

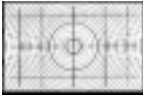
Type	Name/style	Features
	Split-image rangefinder/ microprism system	Suitable for general photography Has microprism collar around the central split-image rangefinder spot. With PC-Nikkor or lensed having a maximum aperture slower than f/4.5, the split-image rangefinder or microprism collar is dim. In this case, focus on the surrounding matte area.
	Matte system	Works well for general photography, close-up photography and duplica- tion work. Especially useful for peo- ple who prefer to focus on the matte focusing spot at the center of the screen, or when it is inconve- nient to use the split-image rangefinder for focusing, as is the case with telephoto lenses.
	Horizontal and vertical line etched system	Extremely useful in pictorial compo- sition. Consists of Type B matte field with etched horizontal and ver- tical lines. Also useful with PC- Nikkor lenses.



Caution: Type K2/B2/E2 focusing screens have a notched tab. The Type K/B/E screens cannot be used in the M.

ACCESSORIES — continued

Filters

Nikon filters allow you to balance the light to match your film or to create interesting artistic effects. Nikon filters are divided into the screw-in, drop-in, and bayonet type. With the Nikon FA, the filter factor can be ignored except in the case of the R60. When using the R60 in tungsten lighting, set the aperture one f/stop wider than the figure indicated by the exposure meter.

- For lens protection, the L39 or L37C is recommended.
- When shooting a backlit subject or if there's a bright light source in the frame, a ghost image is likely to result from the use of a filter. In this case, you should take the picture with out a filter.

Lens Hoods

Recommended to prevent extraneous light from striking the lens. Nikon's lens hoods come in four styles: screw-in, slip-on, snap-on, and collapsible-rubber.

Type		Filter designation	Filter factor		Screw-in-type (mm)						Drop-in type (Series IX)	Bayonet mount type		
			Daylight	Tungsten light	39	52	62	72	85	122			160	
For Both Color and Black & White Film	Skylight	L1BC	1		●	●	●	●					●	
	Ultraviolet	L37C	1		●	●	●	●	●	●				
For Black & White Film	Ultraviolet	L39	1		●							●		
	Yellow	Light	Y44	1.5 (1/2)	1	●							●	
		Medium	Y48	1.7 (2/3)	1.2 (1/2)	●	●	●	●	●			●	●
		Deep	Y52	2 (1)	1.4 (1/2)	●	●	●	●	●			●	
	Orange	O52	3.5 (1 1/4)	2 (1)	●	●	●	●	●	●		●	●	
	Red	R60	8 (3)	5 (2 1/2)	●	●	●	●	●	●		●	●	
	Green	Light	X0	2 (1)	1.7 (2/3)	●								
		Deep	X1	5 (1/2)	3.5 (1 1/4)	●								
For Black & White Film	Soft filters	No.1	1		●	●								
		No.2	1		●	●								
	Polarizing	Polar	2 - 4 (1 - 2)		●	●	●							
	Neutral Density	ND2X	2 (1)		●									
		ND4X	4 (2)		●	●	●							
		ND8X	8 (3)		●	●								
ND400X		400 (8.3)		●										
For Color Film	Amber	Light	A2	1.2 (1/3)		●	●	●					●	
		Deep	A12	2 (1)		●	●	●						
	Blue	Light	B2	1.2 (1/3)		●	●	●					●	
		Medium	B8	1.6 (1/2)		●	●							
		Deep	B12	2.2 (1 1/4)		●	●							

() indicates increase in f/stop

Anti-Cold Battery Pack DB-2

In cold weather, use the Anti-Cold Battery Pack DB-2, which accepts two AA-type batteries, as an alternative power supply to the batteries inside the camera body. Simply connect the DB-2 to the camera body, then slip the assembly inside your pocket or coat to keep it warm. This assures that the camera's metering system will function even in very cold temperatures.

Cable Release AR-3

The screw-type AR-3 makes for vibration-free shutter release.

Right-Angle Viewing Attachment DR-3

Screws onto the viewfinder eyepiece to provide a viewfinder image at a 90° angle to the camera's optical axis. Very helpful for close-up photography, duplication work, and photomicrography.

Eyepiece Magnifier DG-2

Attached to the viewfinder eyepiece, this accessory enlarges the image at the center of the viewfinder to assure ever precise focusing in close-up photography, duplication work, and telephotography.

Rubber Eyecup

Attached to the finder eyepiece, this eyecup excludes stray light and helps prevent eye fatigue.

Eyepiece Correction Lenses

Accessory lenses that screw onto the viewfinder eyepiece "s: to enable near- and farsighted photographers to take pictures without having to wear eyeglasses. Nine models are available, offering a choice of the following diopters: -5, 4, -3, -2, 0, +0.5, +1, +2 and +3.

Camera Case

The CF-30, a semi-soft case, accommodates the FA mounted with a 50mm f/1.4 lens or smaller. The CF-28A, a front flap, is also available for use with all lenses up to the Nikkor 35 70mm f/3.5 or 35-105mm f/3.5 4.5.

Neckstraps

Available are the leather neckstrap AN-1 (black), webbed nylon neckstraps AN-4Y (yellow) and AN-4B (black), and wider webbed nylon neckstraps AN-6Y (yellow) and AN-6W (wine-red).

EV RANGE OF THE CAMERA

What is EV?

Exposure value (EV) is a number representing the available combinations of shutter speed and aperture that give the same exposure effect when the scene brightness and ASA/ISO remain the same.

At ASA/ISO 100, the combination of a one-second shutter speed and an aperture of f/1 4 is defined as EV 1. If the aperture is stopped down by one full f/stop or the shutter' speed is one step faster. the EV increases by one; if the aperture is opened up by one full f/stop or the shutter speed is one step slower, EV decreases by one Using ASA/ISO 100 as an example, 1 sec. at f/2 represents EV 2, 1/2 sec. at f/5.6 represents EV 5, while 1/125sec. at f/5.6 represents EV 12. As the exposure is the same. 1/30sec. at f/11 and 1/1000sec. at f/2 are also EV 12.

EV Chart

The Nikon FA's meter can only be used within the meter's EV range. The chart shows the relationship between the shutter speed, f/stop, and film speed Careful attention to this chart will assure precise exposure, automatically, over the entire usable range of the FA Depending on film speed, EV range determines the following: in the P mode, the usable combinations of aperture and shutter speed, in the S mode, the usable apertures to match the shutter speed set on the dial: and in the A mode, the possible shutter speeds to match the aperture set on the lens. With ASA/ISO 100 film and a 50mm f/1 4 lens, the usable EV range is 1 to 20 As you can see from the chart, any shutter speed from 1 to 1/4000sec. can be used within this range However, when using ASA/ISO 200 film, the EV range is reduced to 2 to 20, whereas with ASA/ISO 400 film, it becomes 3 to 20. Therefore, with ASA/ISO 200 film, the slowest usable shutter speed is 1/2sec., whereas 1/4sec. is the slowest speed usable with ASA/ISO 400 film. This information is reflected in the LCD inside the camera's viewfinder. For example, with ASA/ISO 200, if you set the mode selector to P or A, **1** will never appear, but as the light gets dim, **Lo** appears immediately after **2** Likewise, with ASA/ISO 200 in the S mode, if you set 1 sec. on the shutter speed dial, **1** will not appear, but in its place either a faster shutter speed is displayed (if the shutter speed is shifted to a higher one when the scene is bright) or **Lo** appears (when the scene is too dark). With ASA/ISO 400 film, **1** and **2** never appear, indicating that 1 and 1/2sec. are unusable shutter speeds.

EV chart with 50mm f/1.4 lens

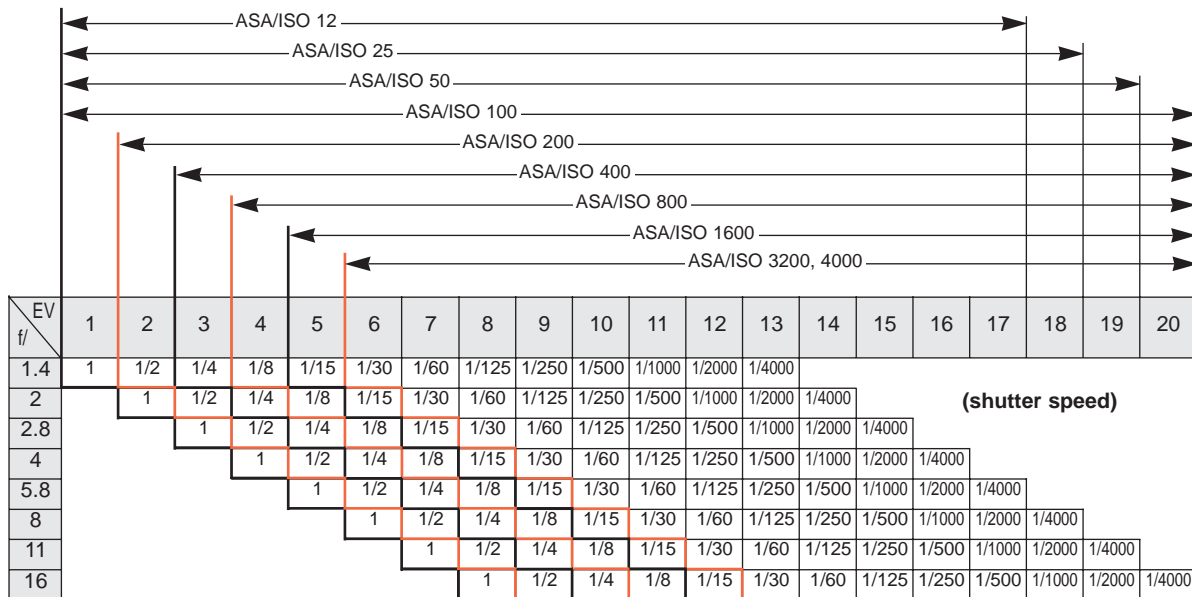

TIPS ON CAMERA CARE

Although the PA is a tough and durable camera bear in mind that it is a precision optical instrument and that careless or rough handling may damage it. Observe the following tips and the FA will always work as perfectly as the day you bought it.



- Before using the camera, it is a good practice to check it thoroughly first.



- Never touch the reflex mirror or the focusing screen, to prevent them from becoming scratched. Remove dust with a blower brush.

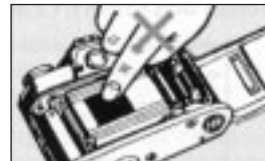

- Do not touch the shutter curtains (26)



- Generally the camera does not need lubrication.



- If the camera body is exposed to rain or mist, wipe moisture gently with a soft cloth and dry the camera. After using the camera near salt water wipe it with a cloth moistened with pure water to remove possible traces of salt.



- If the inside of the camera body accidentally gets wet, its internal precision parts may get rusty. Take the camera right away to the nearest authorized Nikon dealer for a checkup, which may require repair payment.



- Clean metallic parts with a blower brush or with a soft dry cloth.



- Clean glass surfaces such as the lens or the finder eyepiece with a blower brush; avoid using lens tissue as much as possible. Gently wipe dirt, smudges, or fingerprints with soft cotton moistened with a small amount of absolute alcohol, using a spiral motion from center to periphery. Make sure you leave no wiping traces.



- When not using the camera for a long time, take out the batteries and store the camera away from high temperature, high humidity, naphthalene, or camphor.



- In a humid environment, it is best to store the camera in a vinyl bag with a desiccant to keep away dust, moisture and salt.



- Note that storing leather cases in a vinyl bag may cause the leather to deteriorate, so exercise due care.

Caution

Please note that the use of a spray gun type blower to clean the lens may cause possible damage to the glass (especially when ED glass is used for the front lens element) by suddenly lowering the temperature on the lens surface. To avoid damage hold the blower upright, keep its nozzle more than 50cm away from the lens surface and move the nozzle around so that the stream of air is not concentrated in one spot.

TIPS ON BATTERY USE

- Keep batteries away from infants and small children, In case a battery is accidentally swallowed, call a doctor immediately as the material inside the batteries may be fatal.
- Battery power falls off in extremely cold temperatures and this may cause the camera to cease to operate. In this situation, use new batteries and protect the camera body from the cold. Note that battery power will be recovered as soon as the temperature becomes normal.
- When not using the camera for a long period of time, take the batteries out and store them in a cool (below 20°C), dry place. Should the batteries be left in the battery chamber for a long period of time, insufficient contact may occur due to battery contamination. Thus, it is good practice to periodically clean the batteries and the contact section in the battery chamber with a soft cloth. If the battery chamber is stained by a leaking battery, remove the batteries at once and clean the chamber.
- Never mix new and old batteries or batteries of different makes.
- Always check battery power before every shooting session. It is a good idea to have spare batteries on hand during a lengthy shooting assignment.
- Never disassemble batteries or dispose of them by burning.

ABOUT THE LIQUID CRYSTAL DISPLAY (LCD)

To keep the LCD in top working order, note the following:

- At high temperatures (over approx. 60°C); the whole surface turns black so that the exposure information cannot be read. However, this situation will return to normal when the temperature drops.
- Avoid storing the camera in excessively hot places, such as in a car parked in direct sunlight or inside the trunk. You may shorten the LCD's life by doing so.
- When the temperature goes below freezing, the response time decreases as the liquid crystal becomes more viscose.

SPECIFICATIONS

Type of camera	35mm single-lens reflex	Exposure meter switch	Meter turned on when shutter release button is depressed halfway; meter stays on for approx. 16 sec. after finger is lifted off button
Picture format	24mm X 36mm (standard 35 mm film format)	Metering range	EV1 to EV20 at ASA/ISO 100 with f/1.4 lens
Lens mount	Nikon bayonet mount	Exposure control range	Automatic multi-pattern metering: EV1 to EV16-1/3 at ASA/ISO 100 with 50mmf/1.4 lens. Centerweighted metering: EV1 to EV20 at ASA/ISO 100 with 50mmf/1.4 lens.
Lenses	More than 60 Nikkor and Nikon Series E lenses available	Exposure control	Three automatic exposure modes: P (programmed), S (shutter-priority) and A (aperture-priority); M (manual) exposure mode also provided P mode: Shutter speed and aperture are both set automatically and steplessly; normal program operative with all AI-type lenses. high-speed program operative with AI S Nikkor and Nikon Series E lens of 135mm or longer S mode: Shutter speed set manually while aperture is set automatically and steplessly; shutter speed automatically corrected for correct exposure in case shutter speed you set is improper. A mode: Aperture set manually while shutter speed is set automatically and steplessly
Viewfinder	Fixed eyelevel pentaprism type; 0.8X magnification with 50mm lens set at infinity; 93°/0 frame coverage; eye piece shutter provided		
Focusing screen	Matte/Fresnel focusing screen with central split-image rangefinder spot and microprism collar (Nikon Type K2 screen); two other types of screens available optionally (Type B2 and E2)		
Exposure metering	TTL full-aperture exposure measurement; employs two silicon photo diodes (SPD's) with automatic multi-pattern and centerweighted metering methods; selection of metering method via metering control button Automatic multi-pattern metering: Light is individually measured from five separate areas of focusing screen, providing correct automatic exposure, even in difficult lighting situations Centerweighted metering: Major portion of meter's sensitivity concentrated in 12mm dia. center spot of focusing screen		

Exposure information

M mode: Both aperture and shutter speed set manually.

P mode: Viewfinder LCD shows discrete shutter speed closest to automatically selected speed; LCD also shows **HI** or **Lo** indication to warn of over- or underexposure or **FEE** to warn of aperture missetting.

S mode: LCD shows discrete f-number closest to automatically selected aperture or discrete shutter speed closest to automatically selected speed when manually set shutter speed is improper; LCD also shows **HI** or **Lo** to warn of over or under exposure or **FEE** to warn of aperture missetting; manually set shutter speed always shown via shutter speed indication.

A mode: LCD shows discrete shutter speed closest to automatically selected speed; LCD also shows **HI** or **Lo** to warn of over- or underexposure; manually set aperture always shown via ADR window.

M mode: LCD shows manually set shutter speed preceded by M; -+ indicates correct exposure with + or - indicating over or underexposure; manually set aperture always shown via ADR window.

Exposure compensation

±2 EV compensation (in one-third increments) possible via dial; red LED exposure compensation mark visible in viewfinder when meter is on.

Film speed range Shutter

Electromagnetically controlled vertical travel, metal focal plane shutter with titanium curtains.

Shutter speeds

Stepless speed from 1 to 1/4000 sec. in automatic exposure modes (except S mode); ceramic-oscillator-controlled discrete speeds from 1 to 1/4000 sec. in S and M modes; mechanically controlled, 1/250 sec. at M250 setting and long exposure at B setting available.

Film advance lever

Wound in single stroke with 30° stand-off angle and 135° winding angle; doubles as shutter release button lock

Automatic film advance

Possible with optional Motor Drive MD-15 or MD-12

Frame counter

Additive type, self-resetting; for blank exposures before frame 1, shutter fires at 1/250 sec at any shutter speed dial setting except B

Film rewind

Via folding crank and rewind button in baseplate

Self timer

10 sec. delayed exposure

Eyepiece shutter

Prevents stray light from entering viewfinder during unmanned operation

Depth-of-field preview lever	Provides visual verification of depth of field; with lever depressed, center weighted metering only available	Flash ready-light	Viewfinder LED lights up when Nikon dedicated flash unit is completely recycled; blinks to warn of insufficient light output or improper shutter speed dial or film speed setting
Reflex mirror	Automatic instant-return type		
Multiple exposures	Possible via lever		
Camera back	Hinged interchangeable type with memo holder; interchangeable with Data Back MF-16 or MF-12	Batteries	One 3V lithium battery, two 1.55V silver-oxide batteries or two 1.5V alkaline-manganese batteries
Data back contacts	Two contacts are provided for the Data Back MF-16	Dimensions	Approx, 142.5mm (W) x 92mm (H) x 64.5mm (D)
Handgrip	Detachable type provides comfortable shooting; must be detached when attaching motor drive	Weight (body only)	Approx 625 g
Accessory shoe	Standard ISO-type contains hot-shoe contact, ready-light contact. TTL flash auto-stop signal contact and monitor contact; accepts Nikon SB-15, SB-16B or SB-18 for TTL direct flash output control using camera's SPD metering cell.		
Sync terminal	Threaded type provided for off-camera or multiple flash photography		
Flash synchronization	Speeds of 1/250 sec or slower with electronic flash: with Nikon dedicated flash unit, flash sync automatically set to 1/250 sec when camera is set at any automatic exposure mode or when shutter speed dial is set at 1/500 or higher in manual mode; at slower speed on manual, shutter fires at speed set		

Nikon

NIPPON KOGAKU K.K.



Nikon FA, 1983-1989

Modern Classic SLRs Series :
Nikon FA - Specifications

Type of camera	35mm single-lens reflex
Picture format	24mm X 36mm (standard 35 mm film format)
Lens mount	Nikon bayonet mount, Maximum aperture index that works with Automatic with AI-S and AI Nikkor lenses
Lenses	Standard lenses during its official availability: AI-S Nikkor 50mm F1.2, 50mm F1.4, 50mm F1.8 and with options of more than 60 Nikkor and Nikon Series E lenses available.
Viewfinder	Fixed eyelevel pentaprism type; 0.8X magnification with 50mm lens set at infinity; 93° frame coverage; eyepiece shutter provided, Finder diopter: Minus 1+0.5 dpt Viewfinder information: A: Ready-light LED B: LCD panel; 7-segments, 4-digit C: ADR aperture f-number in use D: Shutter Speed in set E) Exposure compensation mark - will light up when exposure compensation in use
Focusing screen	Interchangeable matte/fresnel focusing screen with central split-image rangefinder spot and microprism collar (Nikon Type K2) as standard; two other types of screens available optionally (Type B2 and E2). How to change focusing screens: By pulling the focusing screen, release latch at the top front of the mirror box. A special tweezers is provided for screens change.
Exposure metering	TTL full-aperture exposure measurement; employs two silicon photo diodes (SPD's) with automatic multi-pattern and centerweighted metering methods; selection of metering method via metering control button Automatic multi-pattern metering: Light is individually measured from five separate areas of focusing screen, providing correct automatic exposure, even in difficult lighting situations Centerweighted metering: Major portion of meter's sensitivity concentrated in 12mm dia. center spot of focusing screen
Exposure meter switch	Meter turned on when shutter release button is depressed halfway; meter stays on for approx. 16 sec. after finger is lifted off button
Metering range	EV1 to EV20 at ASA/ISO 100 with f/1.4 lens
Exposure control range	Automatic multi-pattern metering: EV1 to EV16-1/3 at ASA/ISO 100 with 50mm/f1.4 lens. Centerweighted metering: EV1 to EV20 at ASA/ISO 100 with 50mm/f1.4 lens.
Exposure control	Three automatic exposure modes: P (programmed), S (shutter-priority) and A (aperture-priority); M (manual) exposure mode also provided, exposure mode selected via Mode Changeover knob. P mode: 'P' mode: With minimum aperture setting of the lens, the FA automatically selects the optimum combination of shutter speed and lens aperture settings for correct exposure by the pre-arranged program of its microcomputer. Also, the FA's micro-computer activates the High-Speed program automatically via Focal Length (Fmm) signal when a Nikkor, Nikon Series E or any of the AF Nikkor lenses of 135mm or longer are used. Note: High-Speed program operable lenses are AI-S Nikkor, Nikon Series E, AF Nikkor lenses and 'newer' teleconverters for Shutter speed AI-S type. S mode: Shutter speed set manually while aperture is set automatically and steplessly; shutter speed automatically corrected for correct exposure in case shutter speed you set is improper. A mode: Aperture set manually while shutter speed is set automatically and steplessly
Exposure information	P mode: Viewfinder LCD shows discrete shutter speed closest to automatically selected speed; LCD also shows HI or Lo indication to warn of over- or underexposure or FEE to warn of aperture missetting. S mode: LCD shows discrete f-number closest to automatically selected aperture or discrete shutter speed closest to automatically selected speed when manually set shutter speed is improper; LCD also shows HI or Lo to warn of over or underexposure or FEE to warn of aperture missetting; manually set shutter speed always shown via shutter speed indication. A mode: LCD shows discrete shutter speed closest to automatically selected speed; LCD also shows HI or Lo to warn of over- or underexposure; manually set aperture always shown via ADR window. M mode: LCD shows manually set shutter speed preceded by M; +- indicates correct exposure with + or - indicating over or underexposure; manually set aperture always shown via ADR window.
Exposure compensation	±2 EV compensation (in one-third increments) possible via dial; red LED exposure compensation mark visible in viewfinder when meter is on.
Film speed range	ASA/ISO 12 to 4000
Shutter	Electromagnetically controlled vertical travel, metal focal plane shutter with titanium curtains.
Shutter speeds	Stepless speed from 1 to 1/4000 sec. in automatic exposure modes (except S mode); ceramic-oscillator-controlled discrete speeds from 1 to 1/4000 sec. in S and M modes; mechanically controlled, 1/250 sec. at M250 setting and long exposure at B setting available.
Shutter Release:	At 1-1/4000 sec dial settings, depressing shutter release button halfway turns power switch on and further depressing turns magnetic release switch on and to release shutter. At 'M' 1/250 sec and 'B' settings, shutter releases mechanically.
Power Switch:	Power switch is turned on when shutter release button is depressed halfway; it remains on for approx 16 sec. after finger is lifted off the button. By setting shutter dial to M250 and B, power switch turns off.
Film advance lever	Wound in single stroke with 30° stand-off angle and 135° winding angle; doubles as shutter release button lock
Automatic film advance	Possible with optional Motor Drive MD-15 or MD-12
Frame counter	Additive type, self resetting until the frame counter reaches '1'. Shutter fires at 1/250 sec at any shutter speed except 'B'; LCD in the viewfinder displays 'C 250' on P, S and A modes, while 'MC 250' on M mode.
Film rewind	Via folding crank and rewind button in baseplate
Self timer	Self timer: 8 - 14 sec delayed exposure; mechanical type: can be cancellable after setting.
Eyepiece shutter	Prevents stray light from entering viewfinder during unmanned operation
Depth-of-field preview lever	Provides visual verification of depth of field; with lever depressed, centerweighted metering only available (i.e. P and S modes changed into full-aperture center-weighted metering on A mode; A and M modes changed into stopped-down center weighted metering.)
Shutter Speed Ring Lock:	Release by depressing the Shutter Dial Lock release button at the back, just below the Shutter speed dial.
Reflex mirror	Automatic instant-return type
Multiple exposures	Possible via lever
Camera back	Hinged interchangeable type with memo holder; interchangeable with Data Back MF-16 or MF-12
Data back contacts	Two contacts are provided for the Data Back MF-16 (Earlier MF-12 is not operative thru these contacts, you MUST use the cable supplied to plug into the PC terminal).
Handgrip	Detachable type provides comfortable shooting; must be detached when attaching motor drive
Accessory shoe	Standard ISO-type contains hot-shoe contact, ready-light contact. TTL flash auto-stop signal contact and monitor contact; accepts Nikon SB-15, SB-16B or SB-18 or any dedicated Nikon flash units for TTL direct flash output control using camera's SPD metering cell.
Sync terminal	Threading type provided for off-camera or multiple flash photography
Flash synchronization	Speeds of 1/250 sec or slower with electronic flash: with Nikon dedicated flash unit, flash sync automatically set to 1/250 sec when camera is set at any automatic exposure mode or when shutter speed dial is set at 1/500 or higher in manual mode; at slower speed on manual, shutter fires at speed set
Flash ready-light	Viewfinder LED lights up when Nikon dedicated flash unit is completely recycled; blinks to warn of insufficient light output or improper shutter speed dial or film speed setting
Batteries	One 3V lithium battery, two 1.55V silver oxide batteries or two 1.5V alkaline-manganese batteries. Battery power is supply by MD-15 automatically when mounted.
Dimensions	Approx, 142.5mm (W) x 92mm (H) x 64.5mm (D)
Weight (body only)	Approx 625 g