

Nikon

En

F6

Instruction Manual

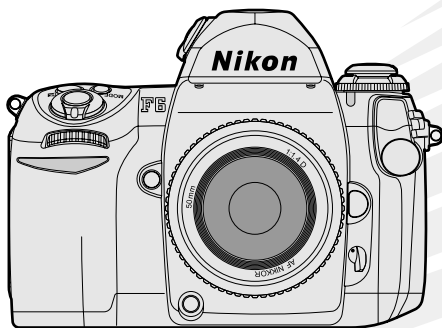

CE

Contents

Before You Begin	2-14
Introduction	4-5
Nomenclature/Controls	6-14
Camera body	6-7
Top LCD panel	8
Viewfinder display	9
Rear LCD panel (shooting data display)	10
Rear LCD panel (menu display)	11
Command Dials and operating buttons	12-13
Multi-selector	14
Basic Operation	15-36
1. Installing Batteries	16-17
2. Checking Battery Power	18-19
3. Mounting a Lens	20-21
4. Loading Film and Setting Film Advance Mode	22-23
5. Setting Focus Mode, AF Area Mode and Focus Area	24-25
6. Setting Metering System and Exposure Mode	26-27
7. Holding the Camera and Focusing	28-29
8. Confirming Indications in Viewfinder and Releasing the Shutter	30-31
9. Rewinding the Film	32-33
Setting Language and Date/Time	34-36
Detailed Operation	37-86
Lens Compatibility	36-42
CPU Nikkor	38
Non-CPU Nikkor	39
Using a non-CPU Nikkor lenses	40
Using a non-AI lenses	41-42
Film	43-47
Aligning frame counter and number of frame on the film/	
Confirming film advance status	43
Setting and confirming film speed	44
Selecting film advance mode	45
Film rewinding with button operation	46
Rewinding film using the film rewind crank	47
Autofocus	48-59
Selecting AF Servo	48-49
Selecting focus area	50-51
Selecting AF Area mode	52-53
Combinations of AF functions (Single Servo AF: AF-S)	54-55
Combinations of AF functions (Continuous Servo AF: AF-C)	56-57
Focus lock	58-59
Situations Where Autofocus May Not Work As Expected	60
Manual Focus	61
Exposure Metering System	62-63
Shooting in Each Exposure Mode	64-71
Programmed Auto	64-65

Shutter-Priority Auto	66-67
Aperture-Priority Auto	68-69
Manual	70-71
Auto Exposure Lock	72-73
Exposure Compensation	74
Auto Exposure Bracketing	75-79
Long Time Exposure	80
Diopter Adjustment/LCD Illuminator	81
Self-Timer Operation	82
Depth-of-Field Preview/Film Plane Indicator	83
Mirror Up Photography	84
Changing Focusing Screens	85
Self-Diagnostic Shutter System	86
Menu Guide	87-148
Operation in Menu (all menus)	88-89
Custom Setting Menu	90-110
Setup Menu	111-124
Recording Shooting Data	112-124
Shooting Menu	125-143
Imprinting Shooting Data	126-137
Multiple Exposure	138-139
Interval Timer Photography	140-143
Non-CPU lens	144-146
Two-Button Reset	147
Recorded/imprinted exposure compensation/flash exposure compensation value	148
Flash Photography	149-163
Creative Lighting System	150-153
Non-CLS supporting Speedlight	154
Non-TTL flash modes	155
Accessory shoe	156
Sync terminal	156
Ready-light	156
Flash sync mode	157-158
Usable optional Speedlights	159-161
Using Speedlight	162-163
About Depth of Field	164
Miscellaneous	165-191
Optional Accessories	166-171
Camera Care	172-173
Notes on Batteries	174
Troubleshooting	176-180
Specifications	181-187
Index	188-191

Introduction

Thank you for purchasing the Nikon F6. Get to know your F6 camera, and be sure to read this manual thoroughly before using it. We recommend that you keep this manual handy.

Main features of the F6:

- Nikon's exclusive new 11-area autofocus sensor (Multi-CAM2000) system, including 9 cross-type sensors, achieves superior performance in continuous high-speed shooting and enables sharp focus even on erratically moving subjects.
- Exclusive 3D Color Matrix Metering with a 1,005-pixel RGB sensor provides a correct exposure in diverse shooting situations.
- Various settings feature a menu list displayed on the large-sized LCD panel on camera back, Custom Settings feature customized combinations of various functions/modes, and two Command Dials and a multi-selector provide access to more versatile functions.
- Various accessory systems including interchangeable lenses. When used with an optional Nikon Speedlight that features the Creative Lighting System (CLS), new levels of flash performance, including i-TTL, Auto FP High-Speed Sync and Advanced Wireless Lighting, can be achieved.
- Shooting data such as shutter speed, aperture or lens' focal length can be stored in the camera and saved on a CompactFlash™ (CF) memory card (with the optional Data Reader MV-1).

Supplied accessories



Body cap (🔋 21)

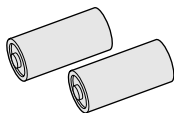

Two 3V lithium batteries (🔋 16)



Strap*

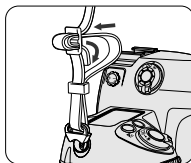

Attaching strap

* Strap is not supplied in the U.S.A. and Canada.

■ Take test shots

Before taking pictures on important occasions (for example, at wedding or before taking the camera with you on a trip), take a test shot to ensure that the camera is functioning normally. Nikon will not be held liable for damages or lost profits that may result from product malfunction.





■ Have Nikon spot-check your camera regularly

Nikon recommends that you have your camera serviced by an authorized dealer or service center at least once every two years.

■ Using your camera correctly

Nikon F6 performance has been optimized for use with Nikon brand accessories. Accessories made by other manufacturers may not meet Nikon's criteria for specifications, and nonconforming accessories could damage F6 components. Nikon cannot guarantee the performance of the F6 when it is used with anything other than Nikon brand accessories.

Marks used in this manual

-  This icon indicates cautions, information that should be read before use to prevent damage to the camera.
-  This icon indicates notes, information that should be read before using the camera.
-  This icon indicates tips, additional information that may be helpful when using the camera.
-  This icon indicates that more information is available elsewhere in this manual.

CSM 00: This icon indicates settings that can be fine-tuned from the Custom Settings menu.

Life-Long Learning

As part of Nikon's Life-Long Learning commitment to ongoing product support and education, continually-updated information is available on-line at the following sites:

- For users in the U.S.A.: <http://www.nikonusa.com/>
- For users in Europe: <http://www.europe-nikon.com/support>
- For users in Asia, Oceania, the Middle East, and Africa: <http://www.nikon-asia.com/>

Visit these sites to keep up-to-date with the latest product information, tips, answers to frequently-asked questions (FAQs), and general advice on photography. Additional information may be available from the Nikon representative in your area. See the URL below for contact information:







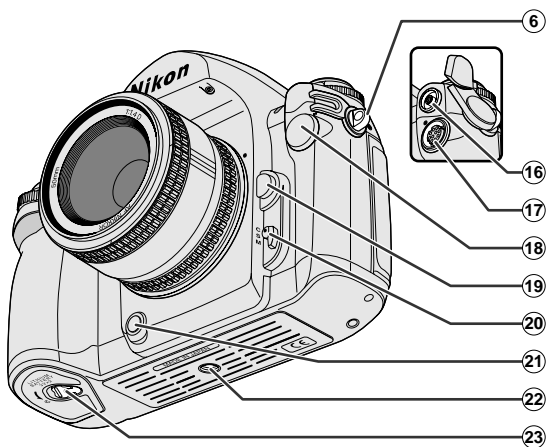
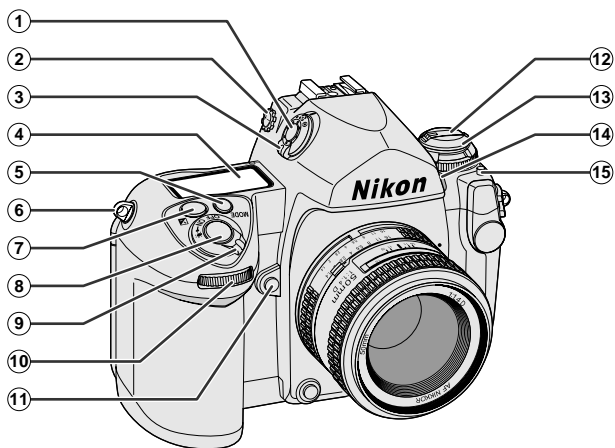

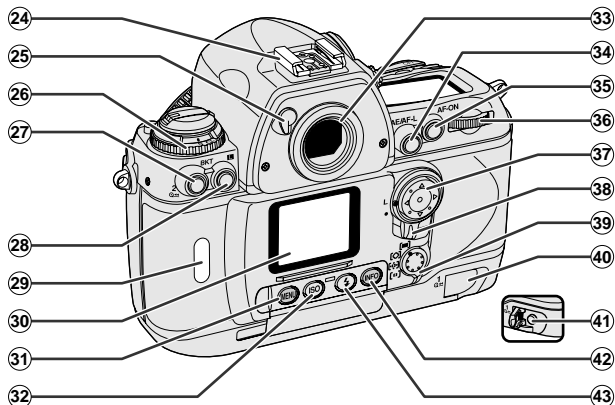

































<http://nikonimaging.com/>

Nomenclature/Controls

■ Camera body





- | | |
|--|--|
| ① Metering system selector lock release  26, 62 | ②④ Accessory shoe  156 |
| ② Diopter adjustment knob  81 | ⑤ Eyepiece shutter lever  81, 82 |
| ③ Metering system selector  26, 62 | ⑥ Film advance mode selector  22, 45, 84 |
| ④ Top LCD panel  8 | ⑦ Auto Exposure Bracketing button  75 |
| ⑤ Exposure mode button ..  26, 64-71 | Film rewind (R2) button  46 |
| ⑥ Camera strap eyelet | ⑧ Command lock button  67, 69 |
| ⑦ Exposure compensation button  74 | ⑨ Film confirmation window  23 |
| ⑧ Shutter release button  18 | ⑩ Rear LCD panel  10 |
| ⑨ Power switch  26, 19 | ⑪ MENU button  11, 88, 147 |
| ⑩ Sub-Command Dial  12-13 | ⑫ Film speed (ISO) button  44 |
| ⑪ Depth-of-field preview button ..  83 | ⑬ Eyepiece DK-17  81 |
| ⑫ Film rewind crank  47 | ⑭ AE/AF-L (Auto Exposure/Autofocus lock) button  58, 72, 99 |
| ⑬ Film rewind knob  22, 32, 47 | ⑮ AF start button  49, 95 |
| ⑭ Self-timer indicator LED  82 | ⑯ Main-Command Dial  12-13 |
| ⑮ Film advance mode selector lock release  22, 45, 82, 84 | ⑰ Multi-selector  14 |
| ⑯ Sync terminal  156 | ⑱ Multi-selector lock lever  24, 51, 88 |
| ⑰ 10-pin terminal  171 | ⑲ AF Area mode selector .  24, 50, 52 |
| ⑱ Terminal cap | ⑳ Film rewind (R1) button cover  46 |
| ⑲ Lens release button  20 | ㉑ Film rewind (R1) button  46 |
| ⑳ Focus mode selector  48, 61 | ㉒ INFO button  122, 145, 147 |
| ㉑ Function button  108, 146, 152 | ㉓ Flash sync mode button  157 |
| ㉒ Tripod socket  187 | |
| ㉓ Battery holder release knob  16 | |

Nomenclature/Controls—continued

■ Top LCD panel

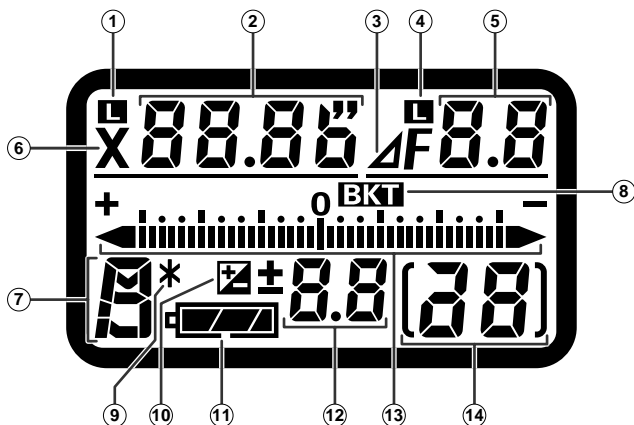

- | | | | | | |
|---------------------------------|--|------------|--------------------------------------|--|----|
| ① Shutter speed lock..... | | 67 | ⑩ Exposure compensation..... | | 74 |
| ② Shutter speed..... | | 66, 70, 80 | ⑪ Battery power..... | | 19 |
| ③ Aperture stop..... | | 21, 40 | ⑫ Exposure compensation value... | | 74 |
| ④ Aperture lock..... | | 69 | ⑬ Electronic analog exposure display | | 71 |
| ⑤ Aperture..... | | 68, 70 | | | 71 |
| ⑥ Sync speed..... | | 104 | Exposure compensation value | | 74 |
| ⑦ Exposure mode..... | | 26, 64-71 | | | 74 |
| ⑧ Auto Exposure Bracketing..... | | 75 | Auto Exposure Bracketing status | | 75 |
| ⑨ Flexible program..... | | 64 | | | 75 |
| | | | ⑭ Frame counter..... | | 22 |

■ Viewfinder display

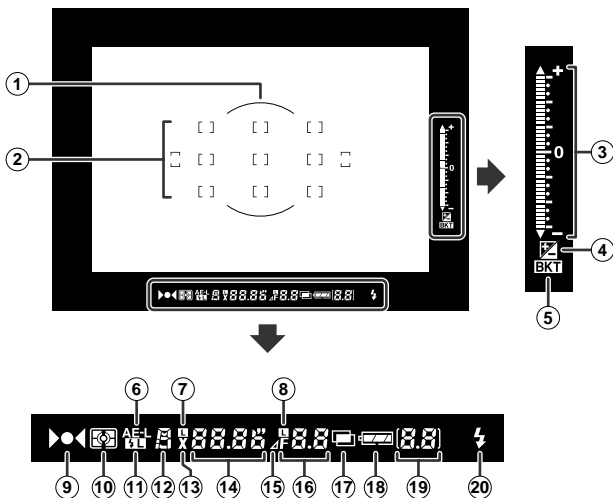

- | | |
|--|-----------------------------------|
| ① 12mm-dia. reference circle for Center-Weighted Metering area
..... 63 | ⑧ Aperture lock 69 |
| ② Focus area (focus brackets) 50
Spot Metering area 63 | ⑨ Focus indicators 28, 29 |
| ③ Electronic analog exposure display
..... 71
Exposure compensation value... 74
Auto Exposure Bracketing status
..... 75 | ⑩ Metering system 26, 62 |
| ④ Exposure compensation 74 | ⑪ FV lock 152 |
| ⑤ Auto Exposure Bracketing 75 | ⑫ Exposure mode 26, 64-71 |
| ⑥ Auto Exposure Lock 72 | ⑬ Sync speed 104 |
| ⑦ Shutter speed lock 67 | ⑭ Shutter speed 66, 70, 80 |
| | ⑮ Aperture stop 21, 40 |
| | ⑯ Aperture 68, 70 |
| | ⑰ Multiple exposure 138 |
| | ⑱ Battery power 19 |
| | ⑲ Frame counter 22 |
| | Exposure compensation value... 74 |
| | ⑳ Flash ready-light 156 |

■ Rear LCD panel (shooting data displays)

- At the default setting, shooting data is displayed in normal mode. It can be changed to detailed or large display by selecting “Detailed” or “Large” in Custom Setting “d7: Rear panel info” (103).

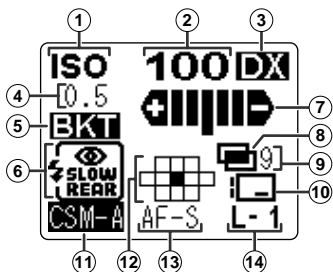

Normal display

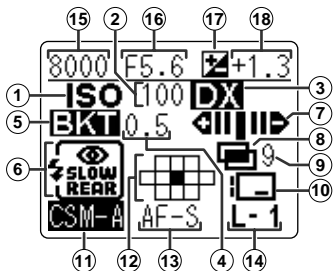

Detailed display

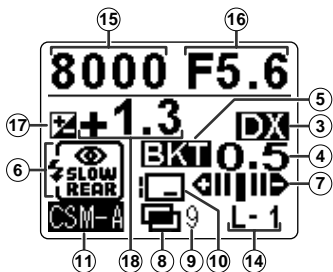

Large display

① ISO	☑	44
② Film speed	☑	44
③ DX	☑	23
④ EV steps in Auto Exposure Bracketing	☑	75
⑤ Auto Exposure Bracketing	☑	75
⑥ Flash sync mode	☑	157
⑦ Auto Exposure Bracketing status	☑	75
⑧ Multiple exposures	☑	138
⑨ Number of shots in multiple exposure	☑	138
⑩ Data imprint	☑	128, 133
⑪ Custom Setting	☑	91
⑫ Focus area	☑	50
⑬ AF servo mode	☑	48
⑭ Lens number	☑	145
⑮ Shutter speed	☑	66, 70, 80
⑯ Aperture	☑	68, 70
⑰ Exposure compensation	☑	74
⑱ Exposure compensation value	☑	74

■ Rear LCD panel (menu displays)

- Press the MENU button (if shooting data is displayed) to display the MENU. The shooting data is displayed by pressing the MENU button again.
- Five types of menu—Custom Setting, Setup, Shooting, Non-CPU lens and Language—are available with the F6.

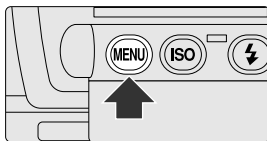

- Custom Setting menu (📖 90)

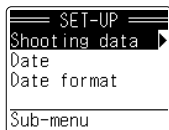

- Setup menu (📖 111)

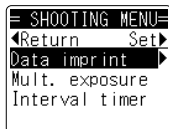

- Shooting menu (📖 125)

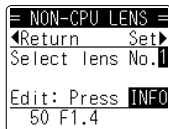

- Non-CPU lens (📖 144)



- Language (📖 34)

Nomenclature/Controls—continued

■ Command Dials and operating buttons

- The F6's Main- and Sub-Command Dials can be used alone or in combination with other buttons to select and set various functions and modes.

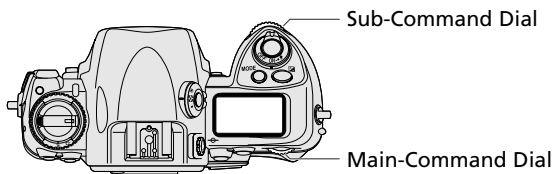

■ Film

- Setting ISO film speed (📷 44)

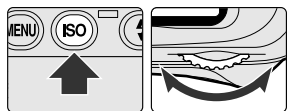

■ Exposure

- Selecting exposure mode (📷 26, 64-71)



- Performing Flexible Program in Programmed Auto exposure mode (📷 64)



- Setting the shutter speed in Shutter-Priority Auto or Manual exposure mode*1 (📷 66, 70)



- Setting the aperture in Aperture-Priority Auto or Manual exposure mode*1 (📷 68, 70)

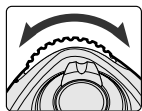

- Locking/unlocking shutter speed*1 (📷 67, 70)



- Locking/unlocking aperture*1 (📷 69, 70)

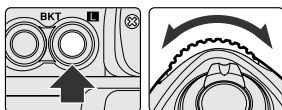

- Setting exposure compensation value*2 (📷 74)



- Setting the number of shots in Auto Exposure Bracketing*3 (📷 75)



- Setting an EV compensation value in Auto Exposure Bracketing*3 (📷 75)

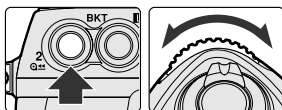

Flash

- Selecting flash sync mode (📷 157)

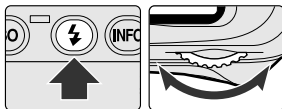

- *1 **CSM f4**: The shutter speed can be set to change with the Sub-Command Dial and the aperture with the Main-Command Dial (📷 109).
- *2 **CSM b3**: Exposure compensation can be set to be activated with the Main- or Sub-Command Dial without having to press the exposure compensation button (📷 97).
- *3 **CSM e8**: Auto Exposure Bracketing can be set to turn on/off with the Main-Command Dial, while the Sub-Command Dial can be used to select the number of shots and EV compensation value (📷 106).

■ Multi-selector

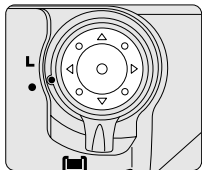

- Use the multi-selector to select focus area (📷 50), operate menu (📷 88), or display shooting data (📷 122).
- When “Activate meter” is selected in Custom Setting “f2: Multi selector”, exposure meter can be activated with the multi-selector (when exposure meter is off) (📷 107). (Or, by selecting “Initiate AF”, Autofocus can be activated.)

■ Focus area selection

- ▲ (Top) : Select top focus area or focus area group*1
- ▼ (Bottom): Select bottom focus area or focus area group*1
- ▶ (Right) : Select right focus area or focus area group*1
- ◀ (Left) : Select left focus area or focus area group*1
- (Center) : Select center focus area or focus area group*2

■ Menu operation

- ▲ (Top) : Select option item or set option such as a number*3
- ▼ (Bottom): Select option item or set option such as a number*3
- ▶ (Right) : Set selection or go to next page*3
- ◀ (Left) : Cancel selection or go back one page*3
- (Center) : Set or go to next page*3

■ Shooting data display

- ▲ (Top) : Display film number or frame data
- ▼ (Bottom): Display film number or frame data
- ▶ (Right) : Set film number or go back to film number selection display
- ◀ (Left) : Go back to shooting data display or film number selection display











*1 **CSM a6:** Focus area position can be set to change continuously in the same horizontal or vertical direction. With this option, the focus area can be switched to the opposite position without pressing the opposite position on the multi-selector (📷 96).

*2 **CSM f1:** Your selected focus area can be set to be highlighted when the center of the multi-selector is pressed. Also, any operation can be canceled when the center of the multi-selector is pressed (📷 107).

*3 **CSM f4:** You can also activate menu operation with the Command Dials (📷 110).

Basic Operation

Shooting modes/functions explained in this section are as follows:

Lens attached	G/D-type AF Nikkor	 20
Film speed		 23
Film advance mode	S (Single frame)	 22
Focus mode	S (Single Servo AF)	 24
AF area mode	 (Single Area AF)	 24
Exposure metering	 (3D Color Matrix Metering)	 26
Exposure mode	P (Programmed Auto)	 26
Custom Setting	Initial (default) settings	 90

1. Installing Batteries

Use two 3V lithium batteries.

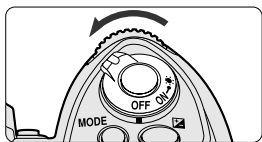

1 Turn the power switch off, then turn the battery holder (MS-41) release knob toward the  icon to release the lock.

- When replacing batteries, be sure to turn the power switch off and replace both batteries at the same time. Always use fresh batteries of the same brand and type.

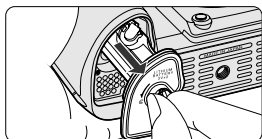
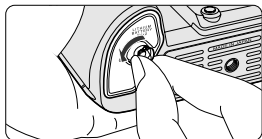

2 Remove the battery holder and insert two 3V lithium batteries with the "+" and "-" ends positioned as marked on the battery holder.

- Incorrect positioning of the batteries' + and - poles may damage the camera.

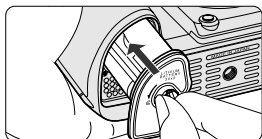
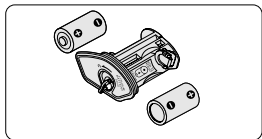

3 Return battery holder to the battery chamber and turn the battery holder release knob away from the  icon to lock the holder.

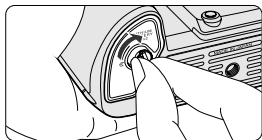

✔ Note on storing batteries

Keep the batteries out of children's reach. If swallowed, contact a doctor immediately. (For "Notes on Batteries",  174.)

✎ Backup battery

The F6 is equipped with a built-in backup battery for the camera's clock. This charges in approximately 48 hours when 3 V lithium or the optional Multi Power Battery Pack MB-40 ( 166) is supplying power to the F6. When the built-in battery is fully charged, it is able to supply the F6's built-in clock with power for approx. 4 months.



✎ When camera's built-in clock has been reset

When power is not supplied for a long time or when batteries are installed for the first time and power is turned on, "CLOCK HAS BEEN RESET. Set time and date." may be displayed in the rear LCD panel (the display returns to normal when any of the F6's buttons or Command Dial are used). In this case, set the date and time ( 35).



CLOCK HAS BEEN
RESET.

Set time and
date.

- The camera functions normally without setting the date and time but shooting data cannot be recorded (date and time) ( 112) or imprinted (day/hour/minute, date and time) ( 126) correctly and interval timer ( 140) cannot be executed correctly.
- If the camera power switch is turned on after the clock data has been lost, date and time start from 2004, January 1st, 0 hour 0 minute. If date and time are left unset, the clock data will be lost every time the power switch is turned off.

✎ For number of film rolls that can be shot with fresh batteries, see page 185.

💡 Power source other than 3V lithium batteries



Eight AA-type batteries or optional Rechargeable Li-ion Batteries EN-EL4 (with optional Battery Chamber Cover BL-3) can be used to power the F6 with an optional Multi Power Battery Pack MB-40 ( 166) attached.

💡 We recommend that you take spare batteries with you, especially when traveling.

2. Checking Battery Power

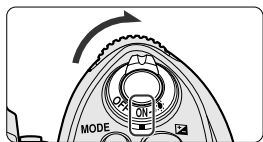
Battery power can be checked in the top LCD panel and viewfinder.



- 1** Turn the power switch on and confirm battery power with the  indication.
- If  appears, battery power is sufficient. If any other indication appears, see table on the next page.
 - When the power switch is turned on, exposure meter turns on.

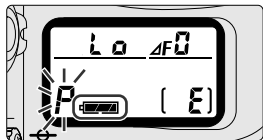



Top LCD panel



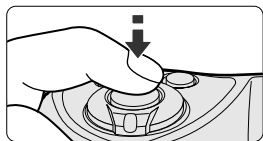

Viewfinder

■ Shutter release button operation and exposure meter



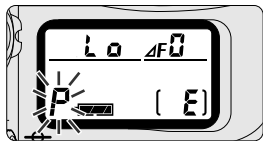







- Some indicators in the top and rear LCD panels and all indicators in the viewfinder turn off after approx. 8 sec. if the power switch is turned on and no operation is performed (exposure meter off). To reactivate the indicators (exposure meter on), lightly press the shutter release button.
- "F6 Nikon" is displayed in the rear LCD panel when exposure meter is off under following conditions:
 - Film speed: 
 - AF area mode:  (Single Area AF)
 - Focus area: center
 - Exposure mode: P (Programmed Auto)
 - Exposure compensation: 00 (no compensation)
 - Auto Exposure Bracketing: no setting
 - Data imprint: no setting (all off)
 - Flash sync mode: Front-Curtain Sync





CSM c4: It is possible to change the duration before automatic meter switch-off occurs ( 100).

Indications and battery status

Battery indications and corresponding battery power status are as follows:

Top LCD panel	Viewfinder (Camera's meter on)	Battery status
 (appears)	 (appears)	Sufficient battery power.
 (appears)	 (appears)	Battery power has begun to decline.
 (appears)	 (appears)	Batteries are nearing exhaustion. Have a fresh set ready.
 (blinks)	 (blinks)	Batteries are exhausted. Replace batteries. (Shutter locks and rear LCD panel turns off.)





- Battery life depends on the battery brand and temperatures. Low battery power indication  appears or blinks relatively soon at low temperatures. However, battery power may recover and the indication returns to  or  when the temperature returns to normal.

Indications when the camera power is off

When the power switch is turned off (with batteries installed), only the frame counter is displayed in the top LCD panel.



For setting language and date, see pages 34 and 35.

- Set language ( 34) for rear LCD panel displays. In addition to English, German, Spanish, French, Chinese (simplified) and Japanese are available.
- Set date and time ( 35) for recording/imprinting shooting data ( 112/126) or Interval Timer photography ( 140).

3. Mounting a Lens

Nikon recommends using a G- or D-type CPU lens to take full advantage of the features the camera offers.

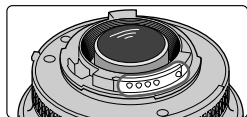

CPU Nikon lenses have CPU contacts



G-type Nikon lens

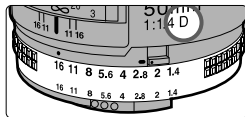

D-type Nikon lens

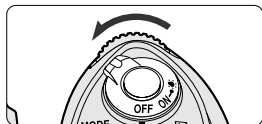

1 Turn the power switch off.

- Turn the power switch off before mounting or detaching lenses.

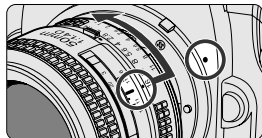

2 Mount the lens to the camera body.

- Position lens in the camera's bayonet mount so that the mounting indexes on the lens and camera body are aligned, then twist the lens counterclockwise until it locks into place.
- Be sure not to touch the lens release button.

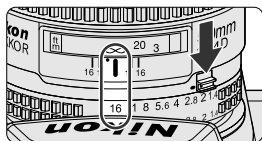

3 Lock aperture at the minimum setting.

- With a CPU Nikon lens other than G-type, set the lens to its minimum aperture (smallest f/stop) and lock. When a CPU Nikon lens other than G-type is not set to its smallest aperture setting and the power switch is turned on, **FE E** will blink in the top LCD panel and viewfinder and the shutter cannot be released.
- G-type Nikon lenses have no aperture ring. Unlike other CPU Nikon lenses, aperture does not need to be set to minimum.

■ Detaching the lens

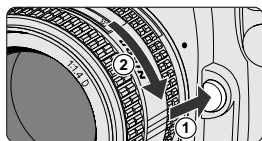

- Turn the power switch off, push and hold the lens release button ①, then turn the lens clockwise ②.

Attaching/detaching the lens

- Make sure to turn the power switch off before attaching/detaching the lens.
- Avoid direct sunlight when attaching/detaching the lens.

When camera is left unattended without a lens

If you leave the camera unattended without a lens attached, be sure to attach the supplied body cap ( 4), or optional body cap BF-1A. (BF-1 body cap cannot be used.)

 **For details on lens compatibility, see page 38.**

Non-CPU Nikkor lens

With a non-CPU Nikkor lens attached, the aperture indication shows the number of EV steps from the maximum aperture (e.g. $\Delta f2$: two steps from the maximum aperture). However, by specifying the focal length and maximum aperture using “specifying lens data” ( 144), functions available with a CPU lens, such as aperture indication or Color Matrix Metering, can be used. Non-AI lenses cannot be attached without modification; see page 41 before attaching a non-AI lens.

4. Loading Film and Setting Film Advance Mode

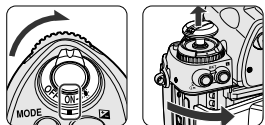

1 Turn the power switch on and lift the film rewind knob. The camera back will pop open.



2 Insert film and pull film leader out as far as the red index mark.

- Film cartridge can be loaded smoothly if inserted from the top.
- Make sure to insert the film cartridge all the way in.
- Make sure to align the film leader to the red index mark; if the film leader is not properly aligned to the index mark (short of or beyond the mark), film may not load properly.
- Hold the film cartridge down to ensure that the film is properly positioned with no slack.

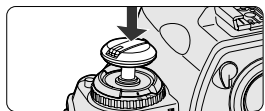
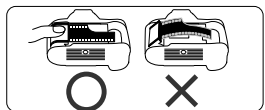
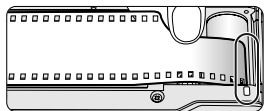

3 Press the film rewind knob down to its original position and gently close camera back until it locks. Film automatically advances to the first frame.

- When 1 appears on the top LCD panel, the film has advanced to the first frame.
- If **Err** and **E** blink in the top LCD panel and viewfinder, and "FILM LOAD ERROR" is displayed in the rear LCD panel, the film is not properly installed. Open the camera back again and reload film.

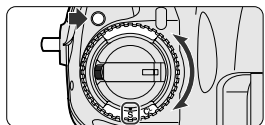
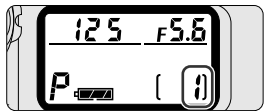
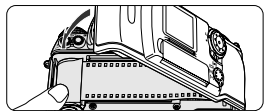

4 Set the film advance mode selector to **S** (single-frame shooting) while pressing the film advance mode selector lock release.

✓ Loading/removing film

- When loading film for the first time, remove the shutter curtain's protective cover .
- Shutter curtains are very thin. Do not touch the shutter curtains with your finger or the film leader.
- Avoid direct sunlight when changing film.

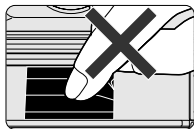
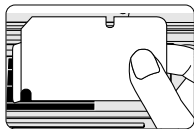

✓ Film slack

Do not turn the film rewind crank to reduce film slack, because the tip of the film may come off and film will not advance properly. It could also damage the shutter curtain.

✎ DX-coded film

When the camera's film speed is set to **DX** and DX-coded film is loaded, film speed will be set automatically (ISO 25-5000). When a non-DX-coded film is loaded with the camera film speed set to **DX**, **Err** blinks in the top LCD panel and viewfinder and "DX ERR" is displayed in the rear LCD panel, and the shutter locks. In this case, set film speed manually (📷 44).

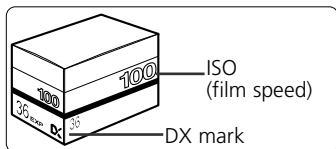

- ✎ You can check the number of available exposures on the film roll through the film cartridge confirmation window.

✎ Film rewind knob

No lock is available for the film rewind knob on this camera. Make sure you do not accidentally open the camera back.

- ✎ For details on film advance mode, see page 45.

CSM d1: Camera can be set to advance the film automatically to the first frame by pressing the shutter release button (📷 101).

5. Set Focus Mode, AF Area Mode and Focus Area

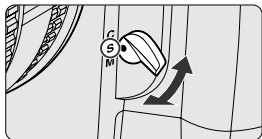

1 Set the focus mode selector to **S** (Single Servo AF).

- Make sure the focus mode selector clicks properly into position.

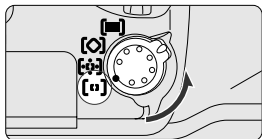

2 Set the AF Area mode selector to **[]**.

- In Single Area AF mode, you can select your desired focus area from 11 possible choices (52).

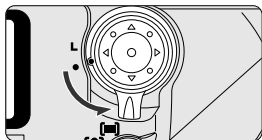

3 Rotate the multi-selector lock lever to release the lock and select the center focus area with the multi-selector.

- Lightly press the shutter release button and press the multi-selector up/down/right/left to shift the focus area in your desired direction. (Press the center of the multi-selector to select center focus area.)
- The selected focus area will be highlighted in the rear LCD panel (in normal and detailed display) and indicated in red in the viewfinder.

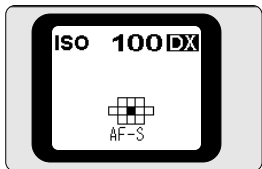
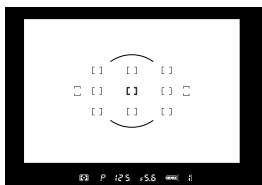





In normal display

Focus mode set to S or C

Do not attempt to rotate the lens focus ring manually while the focus mode is set to S or C, unless the lens is an AF-S or AF-I type AF Nikkor and is set to M/A mode.

 For situations where autofocus may not work as expected, see page 60.

Characteristics of AF Area modes

AF Area mode		Characteristic
	Single Area AF Mode	Focus is obtained at your selected focus area out of 11 possible choices.
	Dynamic AF Mode	You designate the primary sensor (the first to detect the subject), then if the detected subject moves, Dynamic AF automatically shifts to the next sensor that detects the subject, following it by shifting among a progression of sensors as the subject moves.
	Group Dynamic AF Mode	A group of neighboring focus areas at the center, top, bottom, left and right areas of the frame can be selected. Group Dynamic AF Mode automatically maintains a focus on the subject located closest to one of the focus areas within a group.
	Dynamic AF Mode with Closest-Subject Priority	Automatically selects one of 11 focus areas in which the closest subject is located. If the subject moves from the selected focus area, the camera will automatically focus on the subject using data from the other focus areas.



 For details regarding focus mode, focus area and AF Area mode, see pages 48-61.

6. Setting Metering System and Exposure Mode

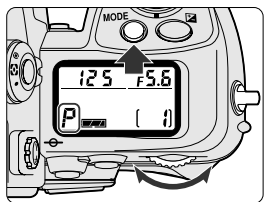
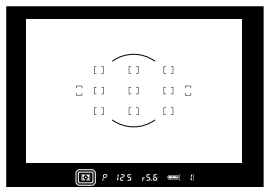
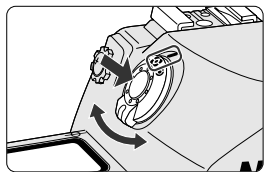
Set metering system to  (3D Color Matrix Metering) and exposure mode to **P** (Programmed Auto).



1 Set the metering system selector to  (Matrix Metering) while pressing the metering system selector lock release.



- The Matrix Metering indication  appears in the viewfinder.
- Exposure data from the 1,005-pixel RGB sensor, as well as scene brightness, contrast, subject distance (Distance Information) and the scene's colors are accounted for in order to provide an accurate exposure in 3D Color Matrix Metering ( 62).

2 Rotate the Main-Command Dial while pressing the exposure mode button to set the exposure mode to **P** (Programmed Auto).

- When the shutter release button is lightly pressed, the correct shutter speed and aperture—as automatically determined by the camera—appear in the top and rear (in large and detailed display) LCD panel and viewfinder.

Metering Systems



Since brightness and film sensitivity determine the proper combination of shutter speed and aperture for correct exposure, measuring subject brightness is very important.

The F6 provides three metering systems. With Matrix Metering ( 62), brightness data is detected using the 1,005-pixel Matrix sensor. With Center-Weighted Metering ( 63), brightness is detected in the central area of the viewfinder. With Spot Metering ( 63), sensitivity is concentrated in one of the 11 available focus areas.

Exposure

Light from the subject passes through the lens and exposes the film. Shutter speed and aperture control how much light reaches the film. The correct combination of shutter speed and aperture results in a correct exposure—a result provided by the F6's four exposure modes: Programmed Auto, Shutter-Priority Auto, Aperture-Priority Auto and Manual.

Characteristics of exposure modes

Symbol	Exposure mode	Shooting situations
P	Programmed Auto P. 64	Camera controls shutter speed and aperture automatically, while allowing you to make other settings, such as Flexible Program ( 64) or exposure compensation ( 74).
S	Shutter-Priority Auto P. 66	You set your desired shutter speed, and the camera selects the correct aperture. Allows you to “freeze” the motion of a moving subject using a fast shutter speed or blur the subject using a slower speed.
A	Aperture-Priority Auto P. 68	You set the desired aperture, and the camera selects the correct shutter speed. This lets you determine the depth of the in-focus area ( 164), so you can choose whether near or distant subjects are in sharp focus, or whether foreground or background should be blurred.
M	Manual P. 70	Shutter speed and aperture are set manually. Long Time Exposure (Bulb) can also be selected.

7. Holding the Camera and Focusing

Lightly pressing the shutter release button automatically focuses the camera on the subject.

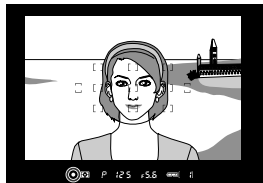
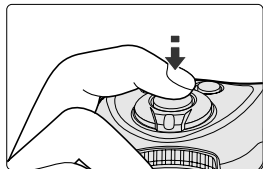

1 Hold the camera properly.

- Keep your elbow propped against your body for support.
- Stand with one foot a half step forward keeping your upper body as still as possible.
- Use your right hand to grasp the camera handgrip and your left hand to cradle the lens.

2 Compose your shot.

- Center the focus brackets on your subject and lightly press the shutter release button.
- Lightly pressing the shutter release button automatically focuses the camera on the subject (focus brackets flicker momentarily) and when the subject is in focus, ● appears in the viewfinder.

Camera shake



Camera shake is likely to occur when the camera is not held steadily and/or when using a slow shutter speed. In general, you should set the shutter speed faster than $1/\text{focal length of your lens sec.}$ (Example: when using a 50mm lens, set the shutter speed faster than $1/50 \text{ sec.}$) Use of a tripod or VR lens is recommended for shooting at slower shutter speeds.



Composing frame



The F6's viewfinder frame shows approximately 100% of the image actually exposed on the film frame. Please be aware that most processing labs partially crop the edges of film.

Focus indications

- Focus indicators appear or blink as follows:
 - appears: Subject is in focus.
 - ▶ appears: Camera is focused on an area between the camera and the subject.
 - ◀ appears: Camera is focused on an area behind the subject.
 - ▶ ◀ blinks: Unable to focus using autofocus.

 **Diopter adjustment ( 81) enables you to see more clearly through the viewfinder.**

 **To take a picture of a subject outside the focus area use focus lock ( 58).**

 **In situations where autofocus may not work as expected,  60.**

Multi Power Battery Pack MB-40

Multi Power Battery Pack MB-40 (optional,  166) features a shutter release button for shooting in vertical position.

CSM a4: Autofocus detection can be set to start by pressing the AF start button (rather than lightly pressing the shutter release button) ( 95).

8. Confirming Indications in Viewfinder and Releasing the Shutter

Confirm that ● (in-focus indicator) appears in the viewfinder, then slowly, fully depress the shutter release button.

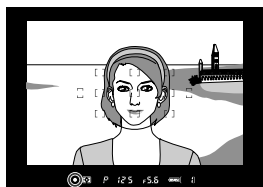
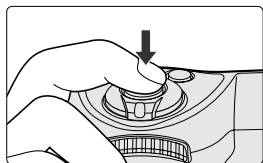
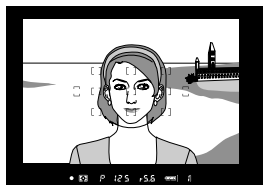
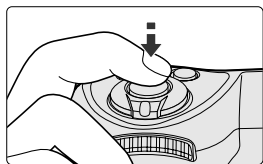



1 Confirm indications in the viewfinder while lightly pressing the shutter release button.

- Shutter speed and aperture are shown in 1/3 EV steps.
- If any warning indications appear in the LCD panel or viewfinder, see page 65.



2 Confirm that focus indicator ● appears and slowly depress the shutter release button.

- After the shutter is released, the film automatically advances to the next frame and the next shot can be taken.

 For self-timer operation,  82.

 For remote control operation,  171.

Focus Tracking

When the focus mode selector is set to Single Servo AF (S) ( 48) or Continuous Servo AF (C) ( 48) and the shutter release button is lightly pressed or the AF Start button ( 49) is continuously pressed, the camera will automatically switch to Focus Tracking when a moving subject is detected. Focus Tracking enables the camera to analyze the speed of the moving subject based on the focus detection data. It also obtains the correct focus by anticipating the subject's position—then driving the lens to that position—at the exact moment of exposure.

- In Single Servo AF, Focus Tracking is activated with a subject that has been moving in advance to the focus detection, and focus is locked when the subject stops moving and ● appears in the viewfinder.
- In Continuous Servo AF, the camera continues to track a subject (even a subject that began moving during focus detection) and focus is not locked.

Imprinting/recording shooting data

With the F6, date, shutter speed, aperture and lens focal length can be imprinted in the frame, between the frames or before the first frame on the film roll. (The data that can be imprinted differs with the position on the film.) The shooting data is also recorded in the camera's built-in memory. For details on data imprinting, see page 126. For details on recording data, see page 112.

CSM b1: Shutter speed and aperture can be changed to display settings in steps of 1/2 or one EV ( 97).

9. Rewinding the Film

Always make sure that the film has completely rewound before removing the film cartridge.

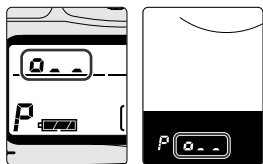

1 Film starts to rewind automatically after the last shot is taken.

- \square , \square , and then \square is displayed in the top LCD panel and viewfinder while the film is rewinding. The frame counter counts down backwards until the rewind is complete. Also, "Rewinding . . ." is displayed in the rear LCD panel.

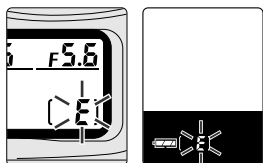
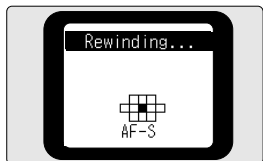

2 Confirm that E is blinking in the top LCD panel. Then, open the camera back by lifting the film rewind knob and remove the film cartridge.

- Film is completely rewound when the frame counter shows a blinking E in the top LCD panel and viewfinder, and "REWIND COMPLETED" is displayed in the rear LCD panel. (E appears without blinking in the top LCD panel, and viewfinder indication and "REWIND COMPLETED" display in the rear LCD panel disappear when the exposure meter is off.) Make sure the film is completely rewound (E is blinking or "REWIND COMPLETED" is displayed), then open the camera back away from sunlight and remove the film cartridge.

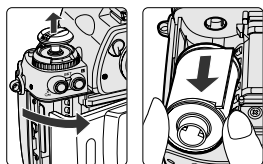
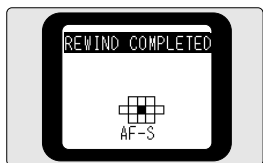



 For mid-roll rewind,  46.

 To rewind film manually using the film rewind crank,  47.

Film rewind knob

No lock is available for the film rewind knob on this camera. Make sure that the knob is down before rewinding film.

 Pictures taken on frames beyond the film's indicated number of exposures may be discarded in the process of developing.

CSM d2: The F6 can be programmed to not automatically begin film rewind when it reaches the end of a roll (execute film rewind by pressing the film rewind buttons) ( 101).

CSM d3: Film leader can be set to remain outside the film cartridge when it is rewound ( 101).

CSM d4: Film advance can be changed to stop at the 35th or 36th frame ( 102).

Setting Language and Date/Time

You can set the language and date/time for various settings in the menu, imprint/record shooting data or perform Interval Timer photography.

■ Setting language

1 Turn the power switch on and press the MENU button to display menu.

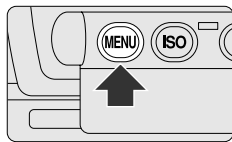
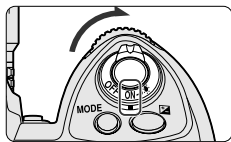

2 Display Language menu.



- Press ▲/▼ on multi-selector to select "Language" and ► so the available languages are displayed.

3 Select a language.



- Press ▲/▼ to select language (English) then press ► to set and return to menu display.

✍ Available options

Deutsch: German
English: English
Español: Spanish

Français: French
中文 (简体): Chinese (simplified)
日本語: Japanese

Setting date/time

1 Turn the power switch on and press the MENU button to display menu.

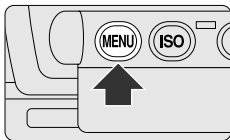
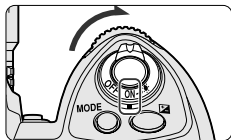

2 Display Date in SET-UP menu.

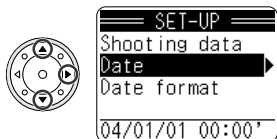

- Press ▲/▼ on multi-selector to select "SET-UP" then press ► so the SET-UP menu is displayed.

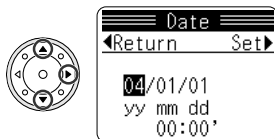

- Press ▲/▼ to select "Date" and ► so the date/time setup screen is displayed.

3 Set date and time.

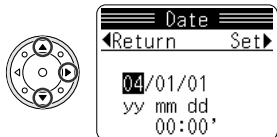

- Press ▲/▼ to adjust highlighted year.
- Press ► to highlight month, day and minute in that order and adjust each with ▲/▼.
- Press ► after adjusting minute to start the clock and return to SET-UP menu.

4 Select date display order.

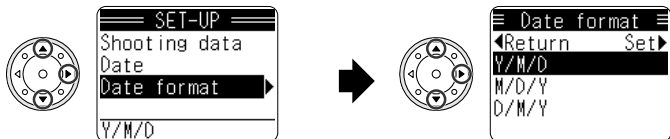

- Press ▲/▼ on multi-selector to select “Date format” then press ► so the date display screen is displayed.

5 Set date display order.

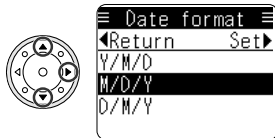

- Press ▲/▼ to select desired date display order and ► to set.
- The date display order in the rear LCD panel or in imprinted data (📷 126) is changed according to the display order set in this section.

6 Complete the procedure.

- Press ◀ to backtrack display by display, or press MENU button to return to the Shooting data display.

Internal clock

The camera clock is less accurate than most watches and household clocks. Check the clock regularly against more accurate time pieces and reset as necessary.

Detailed Operation

This section features detailed descriptions of all camera functions—including lens, film, focus, exposure and other functions.

Lens Compatibility

Use of a Nikon CPU lens (except IX-Nikkor/DX-Nikkor) is recommended with this camera. D or G-type AF lenses provide access to all available functions.

■ CPU Nikkor

Mode Lens/accessories	Focus mode			Exposure mode				Metering system			
	Autofocus	Manual with electronic rangefinder	Manual	P	S	A	M	Matrix		Center-Weighted	Spot
								3D Color	Color		
D-type AF Nikkor, G-type AF Nikkor, *1, *2 AF-S Nikkor AF-I Nikkor	○	○	○	○	○	○	○	○	—	○	○
PC Micro 85mm f/2.8D*3	—	○*4	○	—	—	—	○	○	—	○	○
AF-S/AF-I Teleconverter*5	○*6	○*6	○	○	○	○	○	○	—	○	○
Non-D/G-type AF Nikkor (except AF Nikkor for F3AF)	○*7	○*7	○	○	○	○	○	—	○	○	○
AI-P Nikkor	—	○*8	○	○	○	○	○	—	○	○	○

*1 This camera is compatible with the Vibration Reduction function of the VR Nikkor lens.

*2 IX-Nikkor lenses cannot be attached. DX-Nikkor lenses are designed exclusively for digital SLRs and cannot be used with 35mm (135)-type SLRs.

*3 The camera's exposure metering and flash control system do not work properly when shifting and/or tilting the lens, or when using an aperture other than the maximum aperture.

*4 When lens is not shifted or tilted.

*5 Compatible with AF-S and AF-I Nikkor, except for AF-S 17-35mm f/2.8D IF-ED, AF-S 24-85mm f/3.5-4.5G IF-ED, AF-S VR 24-120mm f/3.5-5.6G IF-ED and AF-S 28-70mm f/2.8D IF-ED. Autofocus cannot be used with the AF-S TC-17E II, AF-S TC-20E II and AF-I TC-20E in combination with the AF-S VR 200-400mm f/4G ED, AF-S 300mm f/4D ED, AF-S 500mm f/4D II ED, AF-S 500mm f/4D ED, AF-I 500mm f/4D ED, AF-S 600mm f/4D II ED, AF-S 600mm f/4D ED, AF-I 600mm f/4D ED.

*6 With maximum effective aperture of f/5.6 or faster.

*7 When AF 80-200mm f/2.8, AF 35-70mm f/2.8, AF 28-85mm f/3.5-4.5 or AF 28-85mm 3.5-4.5 is used in a telephoto zoom position at close range, image on the clear matte field may not coincide with the focus indication. In this case, focus manually using clear matte field.

*8 With maximum aperture of f/5.6 or faster.

■ Non-CPU Nikkor

Lens/accessories	Mode			Focus mode				Exposure mode				Metering system			
	Autofocus	Manual with electronic rangefinder	Manual	P	S	A	M	Matrix		Center-Weighted,	Spot*2				
								3D Color	Color*1						
AI-S or AI type Nikkor, Series-E	○*3	○*4	○	—	—	○	○	—	○	○	○				
AI-modified Nikkor	—	○*4	○	—	—	○	○	—	○	○	○				
Non-AI-type Nikkor*5	—	○*4	○	—	—	○*	○*	—	—	○*8	○*8				
Medical-Nikkor 120mm f/4	—	○	○	—	—	—	○*	—	—	—	—				
Reflex-Nikkor*10	—	—	○	—	—	○	○	—	—	○	○				
PC-Nikkor*10	—	—	○	—	—	○**	○**	—	—	○*13	○*13				
Teleconverter TC-16A	○*14	—	—	—	—	○	○	—	○*15	○*15	○*15				
AI-S or AI type Teleconverters	—	○*16	○	—	—	○	○	—	○*15	○*15	○*15				
Bellows Focusing Attachment PB-6	—	○*16	○	—	—	○**	○*	—	—	○*13	○*13				
Auto Extension Rings (PK-11A, PK-12, PK-13 and PN-11)	—	○*16	○	—	—	○	○	—	—	○	○				

*1 Usable by setting focal length and maximum aperture in “specifying lens data” (144).

Accurate exposure metering cannot be obtained with some lenses even when focal length and maximum aperture are specified. Use Center-Weighted or Spot metering in this case.

*2 Exposure is locked to the center focus area.

*3 With TC-16A attached and maximum effective aperture of f/5.6 or faster.

*4 With maximum aperture of f/5.6 or faster.

*5 With modification (41).

*6 By stop-down metering. (Release shutter while pressing depth-of-field preview button.) (83)

*7 By stop-down metering.

*8 By stop-down metering. If the aperture is slower than f/4, set “+0.5” with the “b6: Screen comp.” in the Custom Setting (98).

*9 With shutter speed set to 1/125 sec. or slower (exposure meter of the camera cannot be used).

*10 Some lenses cannot be attached (40).

*11 By stop-down metering. Exposure is determined by pre-setting lens aperture. Exposure must be determined before shifting; use AE/AF-L button before shifting.

*12 By stop-down metering. Exposure is determined by pre-setting lens aperture. Exposure must be determined before shifting.

*13 By stop-down metering. Set to “+0.5” in the “b6: Screen comp.” in the Custom Setting (98).

*14 With maximum aperture of f/3.5 or faster in combination with AI-S, AI or Series-E lens. However, some lenses cannot be used (40).

*15 Exposure compensation is necessary with some lenses. See the instruction manual of the teleconverter for details.

*16 With maximum effective aperture of f/5.6 or faster.

*17 By stop-down metering. Exposure is determined by stopping down aperture on the bellows. Exposure must be determined before shooting.

■ Using a non-CPU Nikkor lens

Limitations of non-CPU Nikkor lenses

- Set exposure mode to **A** (Aperture-Priority Auto) or **M** (Manual). When other modes are selected, the exposure indication (**P** or **S**) in the LCD panel blinks, and exposure mode is automatically set to Aperture-Priority Auto. (**A** appears in the viewfinder.)
- With AI Nikkor lens, Color Matrix Metering can be used when the focal length and maximum aperture are set by “specifying lens data” (📷 144). If Matrix Metering 📷 is selected without specifying the lens data, however, the metering system automatically switches to Center-Weighted 📷.
- With AI Nikkor lens, aperture can be displayed when the maximum aperture is set by “specifying lens data”. If the lens data are not specified, however, the aperture indication will show the number of EV steps from the maximum aperture (e.g. Δf^2 : two steps from the maximum aperture).
- With a non-CPU lens, the aperture cannot be set using the Sub-Command Dial. Set/confirm aperture using the lens aperture ring.

Accessories that can be attached under certain conditions

- Bellows Focusing Attachment PB-6: use Auto Extension Ring (PB-6D is required to make horizontal/vertical change)
Double Release AR-10 (with Adapter Cord MC-25) is useful when using the PB-6.

✓ Non-CPU lenses/accessories that cannot be attached to the F6

The following Nikkor lenses/accessories cannot be attached to the F6 (damage may occur if attachment is attempted):

Fisheye 6mm f/5.6, Fisheye 7.5mm f/5.6, Fisheye 8mm f/8, OP 10mm f/5.6, old type 21mm f/4, old type PC 35mm f/3.5, old type Reflex 500mm f/8, old type Reflex 1000mm f/6.3, 80mm f/2.8 for F3AF, 200mm f/3.5 for F3AF, TC-16 Teleconverter for F3AF, K2 Ring, Repro-copy Outfit PF-4

✍ Lenses that cannot be attached to the TC-16A Teleconverter

PC-Nikkor, AI-modified Nikkor, AI Micro Nikkor 55mm f/3.5, AI Nikkor 20mm f/2.8, 35mm f/1.4, 400mm f/2.8, 400mm f/3.5, 28mm f/2 (No. 540020 or smaller), 28mm f/2.8 (No. 500000 or smaller), 35mm f/2 (No. 931000 or smaller), 35mm f/2.8 (No. 880000 or smaller), 50mm f/1.4 (No. 398000 or smaller), 50mm f/2 (No. 364000 or smaller)

■ Using a non-AI lens

To attach a Nikon lens that does not have an AI coupling mechanism (lenses made before 1977), the F6's meter coupling lever must first be modified. Contact an authorized Nikon dealer or service center for modification. After modification, follow the instructions for attaching a non-AI lens.

AI lens and non-AI lens

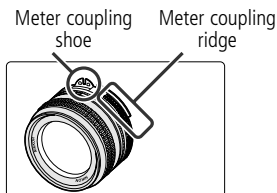

AI lens

- AI lenses have a meter coupling ridge and holes on the meter coupling shoe (AF Nikkor lens [except for F3AF], Series-E and Nikkor 50mm f/1.8 do not have a meter coupling shoe).

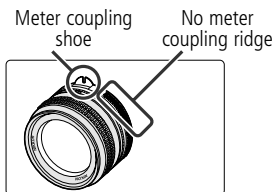

Non-AI lens

Attaching non-AI lens after modifying the meter coupling lever

Meter coupling lever

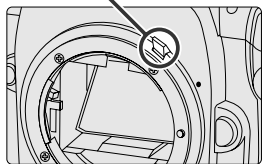

- 1 Push the meter coupling lever up.

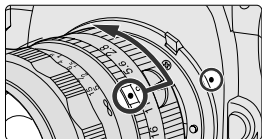

- 2 Position lens in the camera's bayonet mount so that the mounting indexes on the lens and camera body are aligned. Twist lens counterclockwise until it locks into place.

Nikkor lenses that can be attached after camera body modification

The following Nikkor lenses can be attached after modification of the camera's meter coupling lever:

- Non-AI lens
- Lenses with Focusing Unit AU-1 (400mm f/4.5, 600mm f/5.6, 800mm f/8 and 1200mm f/11)
- PC 28mm f/4 (Factory Serial No. 180900 or smaller)
- PC 35mm f/2.8 (No. 906200 or smaller)
- Reflex 1000mm f/11 (No. 142361 to 143000)
- Reflex 2000mm f/11 (No. 200111 to 200310)
- 180-600mm f/8 ED (No. 174041 to 174180)
- 360-1200mm f/11 ED (No. 174031 to 174127)
- 200-600mm f/9.5 (No. 280001 to 300490)

■ Aligning frame counter and number of frame on the film

The frame counter and the number of frame on the film in use can be aligned.

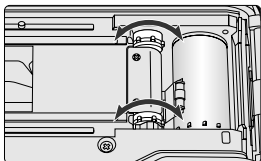

Insert film after rotating the camera sprocket with your finger until it stops rotating.

- You can rotate the sprocket in either direction.
- The frame counter and the number of frame on the film may not align precisely with some films.

■ Confirming film advance status

Film advance status can be confirmed while camera back is opened.

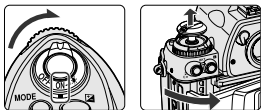

1 Turn the power switch on and lift the film rewind knob. The camera back will pop open.

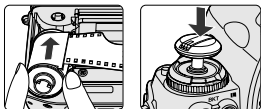

2 Insert film and press the film rewind knob down.

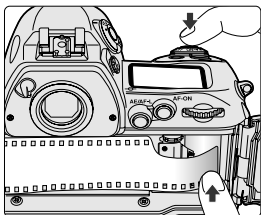

3 Align the film leader to the index mark and depress the shutter release button.

- Depress the shutter release button while aligning the perforations on the film with the projections on the film spool.
- Film advances another frame when the camera back is closed. (Release the shutter when "Press rel button" is set in Custom Setting "d1: Film loading",  101.)
- Note that the usable number of frames decreases as you keep depressing the shutter release button to confirm the film advance status.

■ Setting and confirming film speed

When using non-DX-coded film or when changing the film speed of DX-coded film to increase or decrease sensitivity, follow the instructions below.

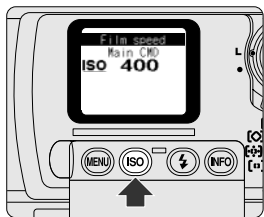

Rotate the Main-Command Dial while pressing the film speed ISO button to set film speed for the roll in use.

- Film speed can be set to **Dx** and between ISO 6-6400 in 1/3 steps.
- When film speed is set to **Dx** and DX-coded film is installed, film speed is set automatically between ISO 25 and 5000.
- With non-DX-coded film, film speed can be set between ISO 6-6400.
- Film speed set on the camera is displayed in the rear LCD panel (in normal and detailed display). (Press the ISO button to confirm film speed in the large display.)

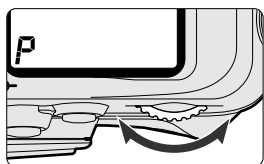

- 📌 Manually set film speed overrides the automatically selected DX-coded film speed, enabling you to easily increase or decrease film sensitivity.

CSM d6: When film speed is set to **Dx** and non-DX-coded film is loaded, **Err** blinks in the top LCD panel and viewfinder and “DX ERR” is displayed in the rear LCD panel after film is advanced to the first frame. This warning indication can be changed to appear when the power switch is turned on and camera back is closed (without advancing film to the first frame) (📖 102).

■ Selecting film advance mode

S (single-frame shooting), CL (continuous low-speed shooting), CH (continuous high-speed shooting), Cs (continuous silent-low-speed shooting), Ⓢ (self-timer) and M-UP (mirror up) are available for a variety of shooting situations.

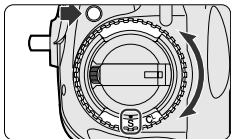

To select film advance mode, rotate the film advance mode selector while pressing the film advance mode selector lock release.

- The following film advance modes are available:

S: Single-frame shooting

Fully depressing the shutter release button takes one picture and automatically advances the film by one frame.

CL: Continuous low-speed shooting

Shots are taken continuously at approx. 2 fps (approx. 4 fps with Multi Power Battery Pack MB-40) as long as you keep the shutter release button fully depressed.

CH: Continuous high-speed shooting

Shots are taken continuously at approx. 5.5 fps (approx. 8 fps with Multi Power Battery Pack MB-40) as long as you keep the shutter release button fully depressed.

Cs: Continuous silent-low-speed shooting

Shots are taken continuously at approx. 1 fps (approx. 2 fps with Multi Power Battery Pack MB-40) as long as you keep the shutter release button fully depressed. In this mode, film rewind also slows and produces minimal rewind noise.

Ⓢ: Self-timer

Use the self-timer when you want to be in the photograph (📷 82).

M-UP: Mirror up

In a situation such as when you want to minimize camera shake, use mirror up photography. Press shutter release button once to raise the mirror, and press again to take photograph (📷 84).



* Film advance speed is tested using the camera settings of focus mode **C**, exposure mode **M**, shutter speed 1/250 sec. or faster, at normal temperature of 20°C (68°F), with fresh 3V lithium batteries, for the first to 36th frames of a film.

🔪 When batteries are exhausted (🔋 appears in the top LCD panel) in S, CH or self-timer mode, film advance speed slows down since film advance automatically switches to start after the camera's mirror retracts. (Normally, film advance begins immediately when the mirror starts to retract.) In this case, battery replacement is recommended.

■ Film rewinding with button operation

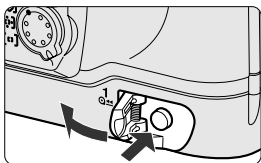
To rewind film at mid-roll or when the Custom Setting Menu “d2: Film rewind” (📷 101) is set to “Manual”, rewind the film according to the following instructions.



Open the R1 button cover and press the film rewind **R1**  button then press the **R2**  button.

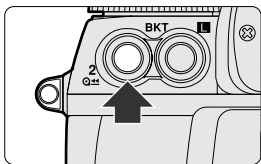

-  blinks in the top LCD panel and viewfinder during film rewind and the frame counter counts backwards until rewind is complete. Also, “Rewinding...” is displayed in the rear LCD panel during film rewind.
- Film is completely rewound when the frame counter shows a blinking **E** in the top LCD panel and viewfinder, and “REWIND COMPLETED” is displayed in the rear LCD panel. (**E** appears without blinking in the top LCD panel, and viewfinder indication and “REWIND COMPLETED” disappear from the rear LCD panel when the exposure meter is off.) Open the camera back and remove the film cartridge.

When rewinding film, make sure the film rewind knob is down.

- Film cannot be rewound with the film rewind knob in up position.

If film does not start to rewind or film rewind stops at mid-roll

- When battery power is very low, or at low temperatures, film may not start rewinding or film rewind may stop at mid-roll, and  and the frame number will blink in the top LCD panel and viewfinder. In this case, turn the power switch off, change batteries, then turn the power switch on and rewind film again. Or, rewind film manually using film rewind crank (📷 47).
- When the power switch is turned off during film rewind, film rewind stops. In this case, turn the power switch on and rewind film again. Or, activate film rewind manually using the film rewind crank (📷 47).

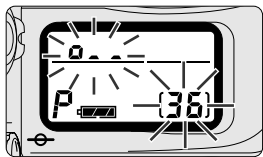

CSM d3: Film can be set to not rewind all the way and leave the film leader out (📷 101).

■ Rewinding film using the film rewind crank

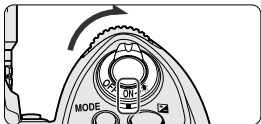

- 1** Turn the power switch on, open the R1 button cover and press the R1  button.

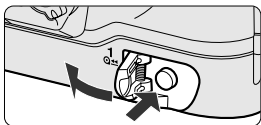

- 2** Lift the film rewind crank and turn in the direction of the arrow.

- Turn the film rewind crank a few times more after the tension is gone.
- Film is completely rewound when the frame counter shows a blinking **E** in the top LCD panel and viewfinder, and "REWIND COMPLETED" is displayed in the rear LCD panel. (**E** appears without blinking in the top LCD panel, and viewfinder indication and "REWIND COMPLETED" display in the rear LCD panel disappear when the exposure meter is off.) Open the camera back and remove the film cartridge.

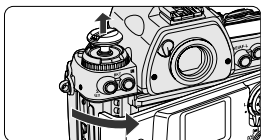
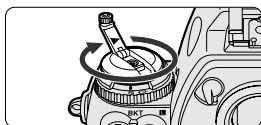

✓ Cautions on manual rewind

- Do not press the shutter release button until the film leader is rewound completely back into the cartridge. Doing so could damage the shutter curtain.

✎ Film rewind R1 button

- If you accidentally press the R1 button during shooting, press the shutter release button. This returns the R1 button to its original position. (The shutter will not open and film is advanced one frame without advancing the frame counter.)

✎ Frame counter

- The frame counter counts backward when film is rewound manually but the display may not indicate the correct frame number.

■ Selecting AF Servo

Choose from two AF Servo modes—Single Servo AF (Focus-Priority) or Continuous Servo AF (Release-Priority).

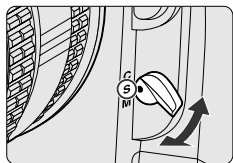

Set focus mode selector to **S** (Single Servo AF with Focus-Priority) or **C** (Continuous Servo AF with Release-Priority).

- Your selected focus mode, “AF-S” for Single Servo AF or “AF-C” for Continuous Servo AF, is displayed in the rear LCD panel (in normal and detailed displays).

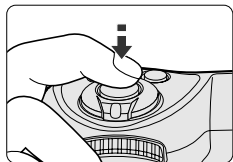

S: Single Servo AF with Focus-Priority (AF-S)

The shutter can only be released when the in-focus indicator ● appears in the viewfinder (Focus-Priority). Once focused on a subject, keeping the shutter release button lightly pressed locks the focus (Focus Lock). When tracking a moving subject, the camera remains focused on the subject as long as the shutter release button is kept lightly pressed (Focus Tracking,  31) and the focus locks when the subject stops moving.

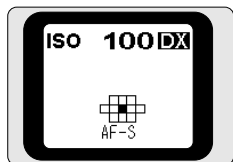

Normal display

C: Continuous Servo AF with Release-Priority (AF-C)

Since the priority is on shutter release, you can release the shutter regardless of the focus status (Release-Priority). Focus is not locked when ● appears in the viewfinder and the camera continues to focus on a subject until shutter release. With a moving subject, the camera continuously focuses on a subject as long as you keep the shutter release button lightly pressed (Focus Tracking,  31).

Manual focus

Focus can be performed manually when the focus mode selector is set to **M** ( 61).

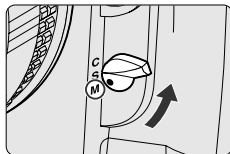

AF start button

Pressing the AF start button automatically activates autofocus in autofocus operation (as does lightly pressing the shutter release button).

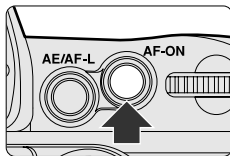

Autofocus operation on lens

Autofocus operation can be activated by pressing the AF-ON button on the AF-S VR 200mm f/2G IF-ED or AF-S VR 200-400mm f/4G IF-ED lens . For details, see the instruction manual of the lens.

CSM a4: Autofocus detection can be set to start by pressing the AF start button (rather than lightly pressing the shutter release button) ( 95).

- In this case, you can lock the focus ( 58) by releasing your finger from the AF start button after focus is achieved.

CSM c3: AF start and AE/AF-L buttons can be set to operate in the following ways ( 100):

- AF start button operates as AE/AF-L button and AE/AF-L button operates as AF start button.
- AE/AF-L button operates as AF start button (function of AF start button remains unchanged).
- AF start button operates as AE/AF-L button (function of AE/AF-L button remains unchanged).

■ Selecting focus area

The F6's 11 focus areas cover a broad range, and you can select among them depending on the subject's position in the frame or your desired composition. They provide a sharp, reliable focus without requiring that you use focus lock (📷 58).

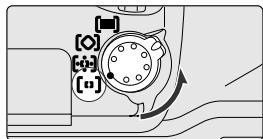

1 Set the AF Area mode selector to a position other than .

- When  is selected, multi-selector is locked and focus area cannot be selected.

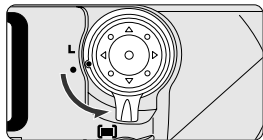

2 Rotate the multi-selector lock release to release the lock and press the multi-selector to select a focus area.

- Select a single focus area in Single Area AF or Dynamic AF modes, or a group of focus areas in Group Dynamic AF Mode.
- To change the focus area(s), lightly press the shutter release button and press the multi-selector up/down/right/left in the appropriate direction. (To select the center focus area[s], press the center of the multi-selector.)
- Selected focus area(s) appear(s) momentarily in red in the viewfinder.
- Selected focus area(s) is/are also indicated in the rear LCD panel (in normal and detailed display).

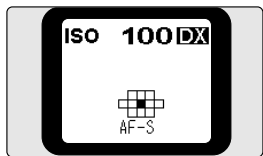
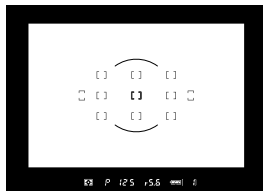
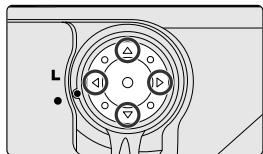

Display in single area AF mode

Focus area display in the rear LCD panel (in normal and detailed displays)

: Single Area AF Mode

Selected focus area is highlighted.

: Dynamic AF Mode

Selected focus area is highlighted.

: Group Dynamic AF Mode

Selected focus area group is highlighted as illustration on page 53.

: Dynamic AF Mode with Closest-Subject Priority

All focus areas are highlighted with "■" (focus area is selected automatically,  53).

The selected focus area can be locked by rotating the focus area selector lock release to lock position.

The focus area can also be changed with the optional focusing screen (168).

CSM a5: In manual focus or continuous shooting, you can cancel the highlighting of the selected focus area. Also, you can change the duration of the red focus area display to 0.2 sec. or 1 sec. ( 95).

CSM a6: The focus area position can be set to change continuously on the same horizontal or vertical plane. This enables the focus area to be switched to the opposite position without pressing the opposite direction on the multi-selector ( 96).

CSM f1: Selected focus area can be set to be highlighted when you press the center of the multi-selector. Also, any operation activated by pressing the center of the multi-selector can be canceled ( 107).

■ Selecting AF Area mode

In autofocus operation, any of four AF Area modes can be selected, depending on shooting conditions, to utilize the F6's 11 focus areas.

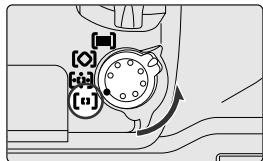

Rotate AF Area mode selector to select AF Area mode.

[□]: Single Area AF Mode

Focus is obtained at only one selected focus area out of 11. Useful for obtaining precise focus of a stationary subject in a particular area.

- Selected focus area is highlighted in the rear LCD panel (in normal and detailed displays).

[3x3]: Dynamic AF Mode

In Dynamic AF, you designate the primary sensor (the first to detect the subject). Then, if the detected subject moves, Dynamic AF automatically shifts to the next sensor that detects the subject, and the next, shifting among the progression of sensors as the subject moves. Dynamic AF thereby follows and maintains accurate focus even on subjects that move irregularly. (Viewfinder indication does not change as sensing shifts in Dynamic AF mode.)

- Selected focus area is highlighted in the rear LCD panel (in normal and detailed displays).

[3x3 with center square]: Group Dynamic AF Mode

Enables you to select a group of neighboring focus areas in the center, top, bottom, left or right areas of the frame. Group Dynamic AF Mode automatically maintains focus on a subject located in the center (indicated as "■" in the illustrations on next page) of the focus areas selected. This mode is useful when you can predict the movement of the subject.

- Selected focus areas are highlighted in the rear LCD panel (in normal and detailed displays).

- The combination of focus areas in Group Dynamic AF Mode can be changed as follows in Custom Setting “a3: Group dynamic AF” ( 94):

- Focus area pattern can be changed among six focus area groups—center 1, center 2, top, bottom, left and right (Pattern 2 Closest, Pattern 2 Center).
- In Pattern 1 Closest and Pattern 2 Closest, Dynamic AF with Closest-Subject Priority can be performed with focus areas within a group.

■ Pattern 1 Center (default)

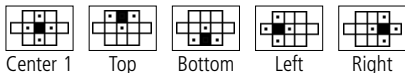

■ Pattern 1 Closest

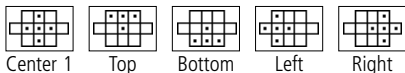

■ Pattern 2 Center

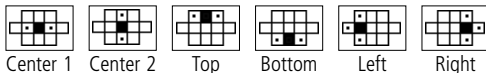

■ Pattern 2 Closest

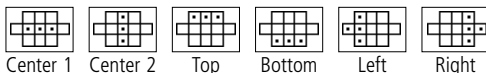



- Press the center of the multi-selector to switch between Center 1 and Center 2. However, if “Center AF area” is not selected in Custom Setting “f1: Center button” ( 107), Center 1 and Center 2 cannot be switched.

Dynamic AF Mode with Closest-Subject Priority

Dynamic AF Mode with Closest-Subject Priority automatically selects the focus area nearest to the closest subject. Focus is constantly maintained within one of the 11 focus areas so pictures are always in focus.

- In Single Servo AF with Focus-Priority, the area of the subject in focus is highlighted momentarily in the viewfinder. If “Focus priority” is selected in Custom Setting “a1: AF-C priority” ( 94), the area of the subject in focus is also highlighted even in Release-Priority.
- All focus areas are highlighted with “ ■ ” in the rear LCD panel (in normal and detailed displays).
- Focus may not be achieved on the closest subject when a telephoto lens is used or when the subject is too dark. In these situations, use Single Area AF Mode.

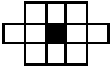
■ Combinations of AF functions (Single Servo AF: AF-S)

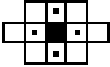
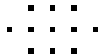
AF Servo	AF Area Mode	Rear LCD panel*1	Focus area indication	Focus area selection
AF-S	Single Area AF		Selected focus area	Manual
AF-S	Dynamic AF		Selected focus area	Manual
AF-S	Group Dynamic AF		Selected focus area group	Manual (center of selected group*2)
AF-S	Dynamic AF Mode with Closest-Subject Priority		Focus area where focus is achieved	Automatic





*1 The indications in the rear LCD panel (in normal or detailed display) are examples of when center focus area or focus area group is selected. (Focus area cannot be selected in Dynamic AF Mode with Closest-Subject Priority.) Pattern of focus areas in Group Dynamic AF is Pattern 1 Center.

*2 When "Pattern 1 Closest" or "Pattern 2 Closest" is selected in Custom Setting "a3: Group dynamic AF" ( 94), Dynamic AF with Closest-Subject Priority can be performed with focus areas within a group.

Focusing operation	Suitable shooting situation
Focus is obtained only at the selected focus area and focus is locked (as long as the shutter release button is lightly pressed) once focus is achieved.	General shooting such as a stationary subject.
Focus is obtained at the selected focus area and focus is locked (as long as the shutter release button is lightly pressed) once it is achieved. If the subject moves from the selected focus area before the focus locks, camera automatically focuses on the subject based on data from the other focus areas.	General shooting including a moving subject where you want to expand the range of a regular snapshot.
Focus is obtained at the center focus area within the selected group*2. Focus is locked once it is achieved. However, if the subject moves from the selected focus area before focus lock, camera automatically focuses on the subject based on data from the other focus areas within the selected group.	Snapshot where the camera's autofocus operation determines the focusing, allowing you to concentrate on the composition.
Automatically selects the focus area nearest to the closest subject and focus locks once it is achieved. If the subject moves from the selected focus area before the focus locks, the F6 automatically focuses on the subject based on data from the other focus areas.	Snapshot where the camera's autofocus operation determines the focusing.

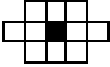
CSM a2: Shutter can be set to be released regardless of the focus status (Release-Priority) in Single Servo AF ( 94).

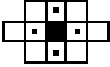
■ Combinations of AF functions (Continuous Servo AF: AF-C)

AF Servo	AF Area Mode	Rear LCD panel*1	Focus area indication	Focus area selection
AF-C	Single Area AF		Selected focus area	Manual
AF-C	Dynamic AF		Selected focus area	Manual
AF-C	Group Dynamic AF		Selected focus area group	Manual (center of selected group*2)
AF-C	Dynamic AF Mode with Closest-Subject Priority		Not indicated	Automatic

*1 The indications in the rear LCD panel (in normal or detailed display) are examples of when center focus area or focus area group is selected. (Focus area cannot be selected in Dynamic AF Mode with Closest-Subject Priority.) Pattern of focus areas in Group Dynamic AF is Pattern 1 Center.

*2 When "Pattern 1 Closest" or "Pattern 2 Closest" is selected in Custom Setting "a3: Group dynamic AF" (94), camera automatically selects the focus area nearest to the closest subject within the selected group.

Focusing operation	Suitable shooting situation
Focus is obtained only at the selected focus area. Focus is not locked and focusing continues until the shutter is released.	Subject moving straight toward or away from the camera—such as a racing car or track athlete—which can be followed by a single focus area.
Focus is obtained at the selected focus area. Focus is not locked even once achieved. If the subject moves from the selected focus area, the camera automatically focuses on the subject based on data from the other focus areas.	Irregularly moving subject that is difficult to follow in one focus area.
Focus is obtained at the center focus area within the selected group*2. Focus is not locked even once achieved. If the subject moves from the selected focus area, the camera automatically focuses on the subject based on data from the other focus areas within the selected group.	Snapshot of a moving subject where the camera's autofocus operation determines the focusing, allowing you to concentrate on the composition.
Automatically selects the focus area nearest to the closest subject. Focus is not locked even once achieved. If the subject moves from the selected focus area before the focus locks, camera automatically focuses on the subject based on data from the other focus areas.	Snapshot of a moving subject where the camera's autofocus operation determines the focusing.

CSM a1: In Continuous Servo AF, priority can be set to put more on focus. Also, shutter can be set to be released only when focus is achieved (Focus-Priority) ( 94).

■ Focus lock

Focus lock is useful in autofocus shooting when you want to capture a subject outside of the F6's 11 focus areas, and in situations where autofocus may not work as expected (👁️ 60). Focus locks performs differently in Single Servo AF and Continuous Servo AF.



- 1 Position the focus area on the subject and lightly press the shutter release button.
 - appears when the subject is in focus.

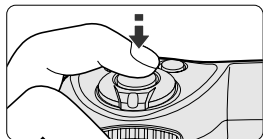

- 2 Confirm focus indicator ● and lock focus.

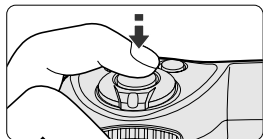

■ In Single Servo AF:

- Focus remains locked as long as you keep the shutter release button lightly pressed.
- Focus can also be locked by pressing the AE/AF-L button.

■ In Continuous Servo AF:

- Focus is locked as long as the AE/AF-L button is kept pressed, even if you remove your finger from the shutter release button. In Auto Exposure mode, exposure is also locked (👁️ 72).

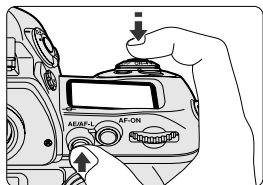

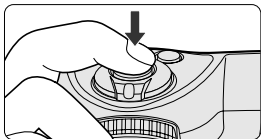
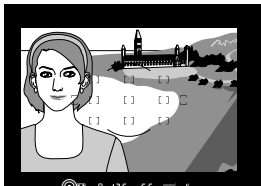

3 Recompose while focus is locked and shoot.

- After you have locked the focus, do not change the camera-to-subject distance.
- If you keep the shutter release button lightly pressed after releasing the shutter in Single Servo AF, the shutter can be released repeatedly with the same focusing. Similarly, if you keep the AE/AF-L button pressed after releasing the shutter, the shutter can be released repeatedly with the same focusing.
- If the subject moves after the focus is locked (if the camera-to-subject distance has changed), remove your finger from the shutter release button or AE/AF-L button to release the lock, then refocus and lock the focus again.

CSM c2: The AE/AF-L button can be set to lock only the focus (📷 99).

CSM c3: AF start and AE/AF-L buttons can be set to operate as follows (📷 100):

- AF start button operates as AE/AF-L button and AE/AF-L button operates as AF start button.
- AE/AF-L button operates as AF start button (function of AF start button remains unchanged).
- AF start button operates as AE/AF-L button (function of AE/AF-L button remains unchanged).

Situations Where Autofocus May Not Work As Expected

Autofocus does not perform well under the conditions listed below. If you cannot achieve your desired focus using autofocus, use manual focus (👁 61) or use focus lock (👁 58) to focus on another subject at the same distance, then recompose the picture.

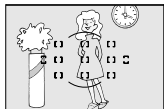

There is little or no contrast between the subject and the background.

Example: Subject is the same color as the background.



The focus area contains objects at different distances from the camera.

Example: Subject is inside a cage.

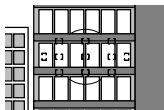

The subject is dominated by regular geometric patterns.

Example: A row of windows in a skyscraper.

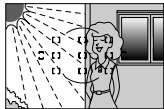

The focus zone contains areas of extreme contrast.

Example: Subject is half in the shade.

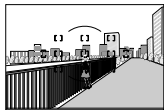

The subject appears smaller than the focus area.

Example: Focus area contains both a foreground subject and distant buildings.

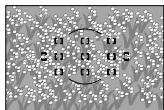

The subject contains many detailed elements.

Example: A field of flowers or other subjects that are small or lack variation in brightness.

AF-Assist Illuminators

If the subject is dark, a Speedlight with AF-Assist Illuminator can be used to assist the autofocus (👁 153, 161).

Manual Focus

Focus can be set manually when the focus mode selector is set to M.

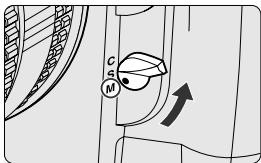

Set the focus mode selector to M. Look through the viewfinder and rotate the lens focusing ring until a sharp image appears on the clear matte field in the viewfinder.

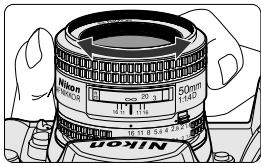

- The shutter can be released whether or not ● appears in the viewfinder. Use Manual focus in situations where autofocus may not work as expected (📷 60) or a lens other than an AF Nikkor (📷 38) is attached.
- Optional focusing screens type J, A or L (📷 168) can assist you in obtaining a quick focus.

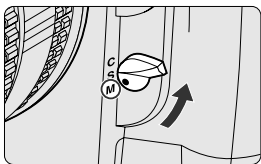

Manual focus using Electronic Rangefinder

Set the focus mode selector to M. The focus can be confirmed with ● indication in the viewfinder. The Electronic Rangefinder works with most Nikkor lenses (including AF Nikkors when operated manually) having a maximum aperture of f/5.6 or faster.



- Lightly press the shutter release button and while the meter remains on, rotate the lens focusing ring until ● appears in the viewfinder. The shutter can be released anytime.
- Electronic Rangefinder can be activated with any of 11 focus brackets selected as the focus area (📷 50).
- If ► appears in the viewfinder, the focus region is in front of the subject. If ◀ appears in the viewfinder, focus region is behind the subject. In either case, rotate the lens focusing ring until ● appears.

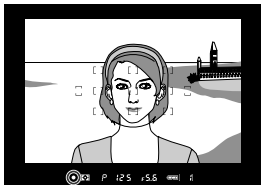

CSM a8: If the attached AF-S/AF-I lens supports autofocus with manual priority (M/A), you can choose to allow autofocus operation in Manual focus (📷 96).

Exposure Metering System

■ Selecting exposure metering system

Taking the infinite variety of possible lighting, the F6 is provided with three types of light meters. This selection will enable you to handle most lighting conditions.

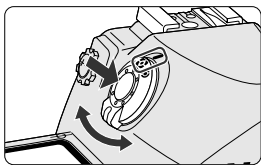

Rotate the metering system selector while pressing the metering system lock release to select your desired metering system.

- Selected metering system is indicated in the viewfinder.
- Certain metering systems cannot be used with some lenses (📖 38).
- Metering systems and characteristics of each are as follows:

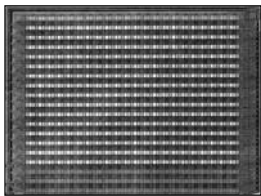

📊: 3D Color Matrix Metering

- This meter reads the entire image area and with 1,005-pixel RGB sensor, it determines the exposure through advanced calculations that consider scene brightness, contrast, subject distance and scene color.
- 3D Color Matrix Metering is available only with D- or G-type CPU lenses. With CPU lenses other than D- or G-type, or non-CPU lenses with focal lengths and maximum apertures set in the “Non-CPU lens data” display in the Shooting Menu (📖 144), Color Matrix Metering is activated without distance information from the lens.
- Matrix Metering is available only with CPU lenses or non-CPU lenses that has specified focal lengths and maximum apertures in the “Non-CPU lens data” display. With other lenses, metering system automatically switches to Center-Weighted.
- Center-Weighted or Spot Metering is recommended in Auto Exposure Lock (📖 72) or exposure compensation (📖 74).
- Set the metering system to Center-Weighted or Spot when using type U focusing screen (optional, 📖 168)..

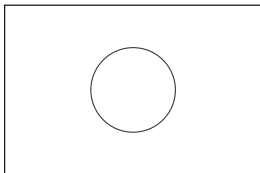

☉: Center-Weighted Metering

- Center-Weighted Metering places special emphasis on brightness within the 12mm-diameter circle in the viewfinder, so it is useful for basing exposure on a specific area of the scene.

CSM b4: The area of the Center-Weighted meter's sensitivity can be changed to 8mm-dia., 12mm-dia., 15mm-dia., 20mm-dia. circle or average of the entire viewfinder (☹ 98).

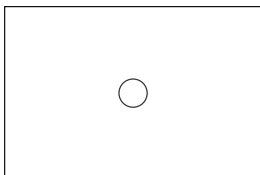

●: Spot Metering

- Nearly 100% of the meter's sensitivity is concentrated on the 4mm-dia. area (approx. 1.5% of entire frame) within the selected focus area of the viewfinder. Use Spot Metering to base the exposure on a very small area within the frame, such as with backlit subjects or high-contrast scenes.
- When Spot Metering is selected, shifting the focus area also shifts Spot Metering to the appropriate position. In Group Dynamic AF Mode (☹ 52), center focus area within the group is activated. However, Spot Metering area stays at the center (does not shift) as long as Dynamic AF Mode with Closest Subject Priority (☹ 53) is activated, when a non-CPU lens (☹ 39) is used or "Other screen" is selected in Custom setting "b6: Screen comp." (☹ 98) (meter's sensitivity area becomes 6mm-dia. [approx. 3.3% of entire frame]).

✎ Filters that require filter factor

Effect of Matrix Metering may not be fully attained when a filter that requires filter factor (☹ 169) is attached. In this case, Center-Weighted Metering is recommended.

CSM f3: Function of the FUNC button can be set to "Matrix metering", "Center-weighted" or "Spot metering". When the FUNC button is pressed, metering system can be temporarily switched to one designated (☹ 108).

Shooting in Each Exposure Mode

■ P: Programmed Auto

The camera automatically controls exposure based on an exposure combination in the program chart that provides a correct exposure for any shooting situation. For more complex shooting, use Flexible Program, exposure compensation (📷 74) or exposure bracketing (📷 75).

- Programmed Auto can only be selected when using a CPU lens.

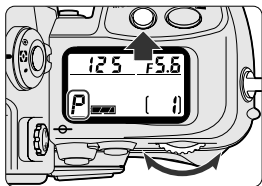

- 1 Rotate the Main-Command Dial while pressing the exposure mode MODE button to select P.



- 2 Compose picture, focus and shoot.

Flexible Program

In Programmed Auto, by rotating the Main-Command Dial you can change the combination of shutter speed and aperture while maintaining correct exposure. With this function, shooting in Programmed Auto is virtually the same as shooting in Shutter-Priority Auto or Aperture-Priority Auto. * appears in the top LCD panel when the Flexible Program is used. To cancel the Flexible Program, rotate the Main-Command Dial until * disappears, change the exposure mode, turn the power switch off, change the setting in Custom Setting "b1: EV step" (📷 97), or perform Two-Button Reset (📷 147).

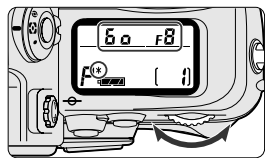
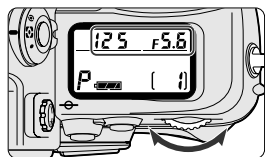

- ✎ When a CPU Nikkor lens other than G-type is not set to its minimum aperture setting, **FE** blinks in the top LCD panel and viewfinder and the shutter locks.
- ✎ When a non-CPU lens is attached, the exposure mode automatically switches to Aperture-Priority Auto, **P** blinks in the top LCD panel and **A** appears in the viewfinder. When the maximum aperture is specified in "Non-CPU lens data" (☞ 144), aperture value is displayed in the top LCD panel, rear LCD panel (in detailed or large display) and viewfinder. In this case, aperture can be set to intermediate values with the aperture ring but the display only shows changes in one EV steps. When the maximum aperture is not specified, the aperture display shows the EV step difference from the maximum aperture (i.e., **AF2**: two steps from the maximum aperture); set/confirm aperture with the lens aperture ring.
- ✎ When the subject is too dark or bright, one of the following warning indications will appear in the top and rear LCD panels (detailed and large displays) or viewfinder:
 - **H f**: Use ND filter.
 - **L a**: Use Speedlight.

🔍 Program chart

The program chart shows exposure control in Programmed Auto exposure mode.

- With ISO 100 film, a lens with a maximum aperture of f/1.4 and a minimum aperture of f/16 (e.g. AF 50mm f/1.4D):

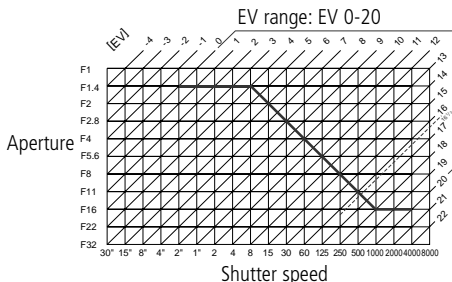

- There are limitations for minimum and maximum EV depending on the film speed.
- In Matrix Metering, any EV above 16 $\frac{1}{3}$ is maintained at EV 16 $\frac{1}{3}$ when using ISO 100 film.

CSM b1: Shutter speed/aperture value displayed in the top LCD panel, rear LCD panel (in detailed or large display) and viewfinder can be set to change in steps of 1/2 or one EV (☞ 97).

Shooting in Each Exposure Mode—continued

■ 5: Shutter-Priority Auto

Enables you to manually set your desired shutter speed (30-1/8000 sec., X); the camera automatically selects the proper aperture to provide correct exposure. With high shutter speeds, you can freeze the motion of a fast-moving subject; with slower speeds, you can create a blurry, motion effect.

- Shutter-Priority Auto can only be selected with a CPU lens.

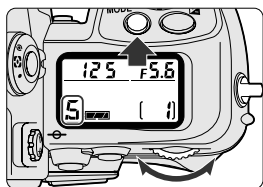

1 While pressing the exposure mode MODE button, rotate the Main-Command Dial to select **S**.

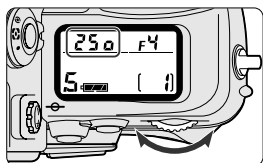

2 Set the shutter speed (30-1/8000 sec., X) by rotating the Main-Command Dial.



3 Compose picture, focus and shoot.





✎ Changing from Manual to Shutter-Priority Auto

If you select a shutter speed of **bulb** in Manual exposure mode and then select Shutter-Priority Auto without changing the shutter speed, the **bulb** indicator in the shutter speed display will blink and the shutter cannot be released. Rotate the main command dial to select a different shutter speed before shooting.

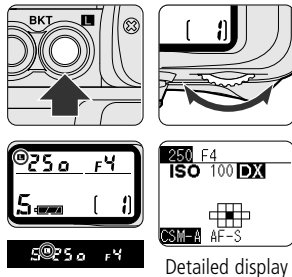
Locking shutter speed

To lock the shutter speed set in step 2, rotate the Main-Command Dial while pressing the shutter speed/aperture lock button so shutter speed lock indication **L** appears in the top LCD panel and viewfinder. The shutter speed display is reversed in the rear LCD panel (in detailed and large displays). To release the lock, rotate the Main-Command Dial while pressing the shutter speed/aperture lock button so shutter speed lock indication **L** disappears in the LCD panel and viewfinder.



-  When a CPU Nikkor lens other than G-type is not set to its minimum aperture setting, **FE** blinks in the top LCD panel and viewfinder and the shutter locks.
-  When a non-CPU lens is attached, exposure mode automatically switches to Aperture-Priority Auto. **S** blinks in the top LCD panel and **A** appears in the viewfinder. When the maximum aperture is specified in "Non-CPU lens data" ( 144), the aperture value is displayed in the top LCD panel, rear LCD panel (in detailed or large display) and viewfinder. In this case, aperture can be set to an intermediate value with the aperture ring but the display only shows changes in one EV steps. When the maximum aperture is not specified, aperture display shows the EV step difference from the maximum aperture (i.e., **AF2**: two steps from maximum aperture); set/confirm aperture with the lens aperture ring.
-  When the subject is too dark or too bright, one of the following warning indications will appear in the top and rear LCD panels (detailed and large displays) or viewfinder (electronic analog exposure display will also indicate the amount of under- or overexposure):
 - **H f**: Select higher shutter speed. If the warning indication does not disappear, use an ND filter.
 - **L a**: Select a slower shutter speed. If the warning indication does not disappear, use a Speedlight.

CSM b1: Shutter speed/aperture value displayed in the top LCD panel, rear LCD panel (in detailed or large display) and viewfinder can be set to change in steps of 1/2 or one EV ( 97).

CSM f4: Shutter speed can be set to be adjusted using the Sub-Command Dial ( 109).

Shooting in Each Exposure Mode—continued

■ A: Aperture-Priority Auto

Enables you to set the desired aperture (lens' minimum to maximum) manually. The camera automatically selects a shutter speed suitable for correct exposure. By varying the aperture, and thus controlling the depth of field, you can sharpen the background and foreground, or blur the background. In flash photography, varying the aperture changes the flash shooting distance (📖 163).

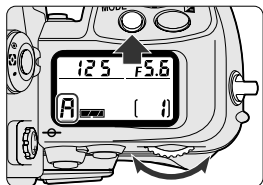

- 1 While pressing the exposure mode MODE button, rotate the Main-Command Dial to select A.

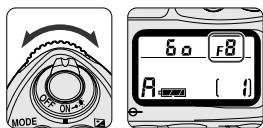



- 2 Set the aperture by rotating the Sub-Command Dial.







- 3 Compose picture, focus and shoot.

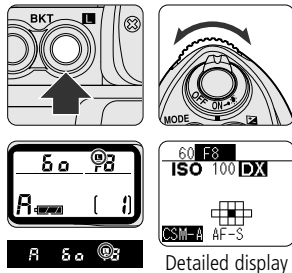

Locking aperture

To lock aperture set in step 2, rotate the Sub-Command Dial while pressing the shutter speed/aperture lock button so aperture lock indication  appears in the top LCD panel and viewfinder. The aperture display is reversed in the rear LCD panel (in detailed and large displays). To release the lock, rotate the Sub-Command Dial while pressing the shutter speed/aperture lock button so aperture lock indication  disappears in the LCD panel and viewfinder. Aperture lock is also released when the lens is detached.



-  When a CPU Nikkor lens other than G-type is not set to its minimum aperture setting, **FE E** blinks in the top LCD panel and viewfinder and the shutter locks.
-  When the maximum aperture is specified in “Non-CPU lens data” () 144), aperture value is displayed in the top LCD panel, rear LCD panel (in detailed or large display) and viewfinder. In this case, aperture can be set to an intermediate value with the aperture ring but the display only shows changes in one EV steps. When the maximum aperture is not specified, aperture display shows the EV step difference from the maximum aperture (i.e., **ΔF2**: two steps from maximum aperture); set/confirm aperture with the lens aperture ring.
-  When the subject is too dark or too bright, one of the following warnings will appear in the top and rear LCD panels (detailed and large displays) or viewfinder (electronic analog exposure display will also indicate the amount of under- or overexposure):
 - **H f**: Select smaller aperture (larger f-number). If the warning indication does not disappear, use an ND filter.
 - **L a**: Select larger aperture (smaller f-number). If the warning indication does not disappear, use a Speedlight.

CSM b1: Shutter speed/aperture value displayed in the top LCD panel, rear LCD panel (in detailed or large display) and viewfinder can be set to change in steps of 1/2 or one EV () 97).

CSM f4: When a lens other than G-type is attached, aperture can be set to be adjusted using only the lens aperture ring () 110). Also, aperture can be set to be adjusted using the Main-Command Dial () 109).

Shooting in Each Exposure Mode—continued

■ M: Manual

Enables you to set both shutter speed (Bulb and 30-1/8,000 sec., X) and aperture (lens' minimum to maximum) manually. With electronic analog exposure display in the top LCD panel or viewfinder, you can produce various creative effects by adjusting the exposure. Long Time Exposure (Bulb) can be set in Manual exposure mode.

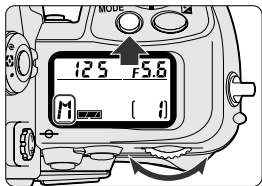

1 While pressing the exposure mode MODE button, rotate the Main-Command Dial to select M, then compose picture.

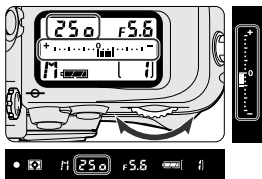

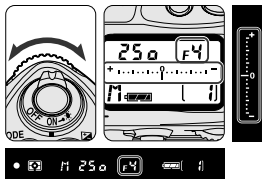

2 Set the shutter speed and aperture and confirm with the electronic analog exposure display in the viewfinder.

- Set the shutter speed by rotating the Main-Command Dial and the aperture by rotating the Sub-Command Dial. These functions can be set independently.
- Long Time Exposure (Bulb) can be selected by setting the shutter speed to **bulb** (80).



3 Compose picture, focus and shoot.

Locking shutter speed/aperture

Selected shutter speed and/or aperture can be locked. To lock shutter speed, see “Locking shutter speed”  67. To lock aperture, see “Locking aperture”  69.

Electronic analog exposure display

The following examples show electronic analog exposure display indications. The electronic analog exposure display blinks when subject brightness is beyond the camera's exposure range.

In 1/3 EV steps	In 1/2 EV steps	In one EV steps
Correct exposure + 0 -	Correct exposure + 0 -	Correct exposure + 0 -
-2/3 EV + 0 -	-1/2 EV + 0 -	Under -3 EV + 0 -
Over +3 EV + 0 -	+1/2 EV + 0 -	+1 EV + 0 -

Lens aperture ring

When a CPU Nikkor lens other than G-type is not set to its minimum aperture setting, **fEE** blinks in the top LCD panel and viewfinder and the shutter locks.

Non-CPU lens



When a non-CPU lens is attached and the maximum aperture is specified in "Non-CPU lens data" ( 144), aperture value is displayed in the top LCD panel, rear LCD panel (in detailed or large display) and viewfinder. In this case, aperture can be set to an intermediate value with the aperture ring but the display only shows changes in one EV steps. When the maximum aperture is not specified, aperture display shows the step difference from the maximum aperture (i.e., Δf^2 : two steps from maximum aperture); set/confirm aperture with the lens aperture ring.

Exposure factor with AF Micro-Nikkor lens

When an AF Micro-Nikkor lens is attached and you're setting aperture using Sub-Command Dial aided by an external exposure meter, you do not need to take the exposure factor into consideration. Exposure compensation is required only when setting aperture using the lens aperture ring.

CSM b1: Shutter speed/aperture value displayed in the top LCD panel, rear LCD panel (in detailed or large display) and viewfinder can be set to change in steps of 1/2 or one EV ( 97).

CSM b5: In Manual exposure mode, the slowest shutter speed can be prolonged from 30 sec. to 30 min. ( 98).

CSM f4: When a lens other than G-type is attached, aperture can be set to be adjusted using only the lens aperture ring ( 110). Also, shutter speed can be set to be adjusted using the Sub-Command Dial and aperture with the Main-Command Dial ( 109).

Auto Exposure Lock

To control the exposure of a specific area within a scene, measure the exposure for the area with Spot or Center-Weighted Metering, then press the AE/AF-L button to lock the exposure, and recompose the picture. Set exposure to a mode other than Manual.

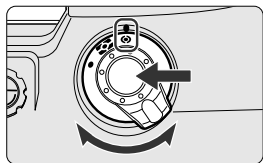

1 While pressing the metering system selector lock release, rotate the metering system selector to select Center-Weighted or Spot Metering.

- Matrix Metering is not recommended since the exposure cannot be properly locked.



2 Position focus area (in Spot metering) or center of the frame (in Center-Weighted metering) on subject and lightly press the shutter release button, then press the AE/AF-L button. Confirm focus indicator ● appears in the viewfinder.

- When the AE/AF-L button is pressed, **AE-L** appears in the viewfinder.

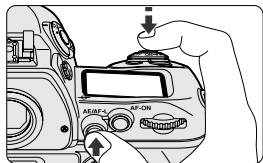







3 While pressing the AE/AF-L button, recompose, focus and shoot.

- While the exposure is locked, the metering system only changes when the AE/AF-L button is released (not when the metering system selector is adjusted).



Locked exposure area in each metering system

Spot Metering

- In Single Area AF mode (, 52), Dynamic AF mode (, 52) or Manual focus (, 61) with CPU lens:
Exposure at the selected focus area
- In Group Dynamic AF mode (, 52) with CPU lens:
Exposure at the center focus area of the selected focus group
- In Dynamic AF mode with Closest-Subject Priority (, 53), with non-CPU lens is used (, 39) or when "Other screen" is selected in Custom setting "b6: Screen comp." (, 98):
Exposure at the center focus area

Center-Weighted Metering



Exposure at 12mm-diameter circle at center

Available functions in Auto Exposure Lock with each exposure mode

- **P** (Programmed Auto): Flexible Program (, 64)
- **S** (Shutter-Priority Auto): Shutter speed adjustment
- **A** (Aperture-Priority Auto): Aperture adjustment

In any of these three situations, controlled shutter speed and/or aperture will be displayed.

Auto Exposure Lock in autofocus operation

- Focus Lock (, 58) is simultaneously activated. Confirm  in the viewfinder.

CSM c1: Auto Exposure Lock can be set to be activated by lightly pressing the shutter release button (, 99).

CSM c2: Operation when the AE/AF-L button is pressed can be changed as follows (, 99).





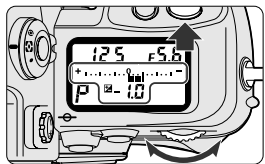

- Only exposure is locked.
- Exposure remains locked until shutter is released, exposure meter turns off or AE/AF-L button is pressed again.
- Exposure remains locked until exposure meter is off or AE/AF-L button is pressed again (pressing shutter release button does not release the lock).
- Only focus is locked.

Exposure Compensation

To adjust exposure control, use the exposure compensation function. This can be useful when the subject has pronounced contrast or when bracketing exposure with color slide film (where the latitude for a proper exposure is minimal). Use Center-Weighted or Spot Metering. Exposure compensation can be performed in any exposure mode.



1 Set exposure compensation by rotating the Main-Command Dial while pressing the  button until the desired compensation value appears (–5 EV to +5 EV in 1/3 EV steps).

- When the  button is pressed, the electronic analog exposure display indicates the exposure compensation value (and “0” of the indicator blinks).
- When the exposure compensation is set,  appears in the top LCD panel and viewfinder. The compensation value is displayed in the top and rear LCD panels (in detailed or large display).
- While the  button is pressed,  (if the compensation is to the + side) or  (if the compensation is to the – side) is displayed in the viewfinder.
- To cancel exposure compensation, rotate the Main-Command Dial while pressing the  button to reset the compensation value to 0.0. This can also be done by performing Two-Button Reset ( 147). (Turning the power switch off does not cancel the exposure compensation function.)

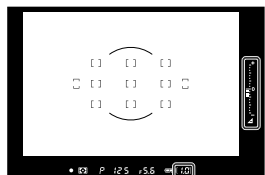

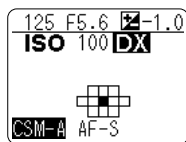

–1.0 EV compensation





–1.0 EV compensation
(detailed display)



2 Compose picture, focus and shoot.

-  When exposure compensation is set while Speedlight is used, flash output level is also compensated.
-  Normally, you should compensate exposure to the + side when the background is brighter than your main subject, or to the – side when the background is darker.

CSM b2: Compensation value can be set to be changed in 1/2 or one EV steps ( 97).

CSM b3: Exposure compensation can be set to be performed using the Main- or Sub-Command Dial without pressing the exposure compensation button ( 97).

Auto Exposure Bracketing

Auto Exposure Bracketing allows you to shoot at selected compensated EV values (maximum of ± 3 EV) shifting from the automatically set proper exposure (or selected exposure in Manual exposure mode) for a selected number of shots (maximum of 7) each time the shutter is released. Auto Exposure Bracketing can be performed in any exposure mode.

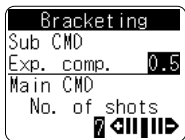
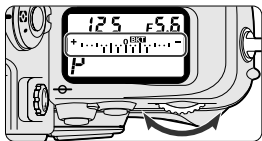
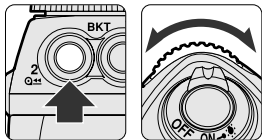



1 While pressing the Auto Exposure Bracketing BKT button, rotate the Main-Command Dial to set the number of shots and Sub-Command Dial to set compensated EV value.

- While the BKT button is pressed, check the number of shots and compensated EV values in the rear LCD panel.
- When the selected number of shots is a value other than "0", **BKT** appears in the top LCD panel and viewfinder. Electronic analog exposure display indicates the Bracketing status. (In Manual exposure mode, the Bracketing status is displayed only in the top LCD panel.) The compensated EV value and Bracketing indicator are displayed in the rear LCD panel.
- See pages 76-77 for the combinations of the number of shots and compensated EV value.

2 Compose picture, focus and shoot.

- Compensated shutter speed and aperture values are displayed during shooting.

-  **Shutter speed and aperture in Programmed Auto, aperture in Shutter-Priority Auto and shutter speed in Aperture-Priority Auto and Manual exposure mode are shifted.**
-  **In any of the exposure modes, Flash Exposure Bracketing (in which the TTL Auto Flash level of the lighted main subject is shifted) and Auto Exposure Bracketing (in which the exposure of a background lighted by ambient light is shifted) are performed simultaneously when a Speedlight is used.**

CSM e5: Bracketing can be set to perform only Auto Exposure Bracketing or Flash Exposure Bracketing where both are normally performed simultaneously ( 105).

CSM e6: In Manual exposure mode, shutter speed, aperture and flash output level, or aperture and flash output level, or only flash output level can be set to be shifted where normally shutter speed and flash output level are shifted ( 106).



CSM e8: Auto Exposure Bracketing can be set to be turned on/off with the Main-Command Dial, and the Sub-Command Dial can be used to select the number of shots and compensated EV value ( 106).

Auto Exposure Bracketing—continued

■ Combination of number of shots and compensated EV value

Compensated EV value	Number of shots	Bracketing indicator (top LCD panel)	Bracketing order (default setting)	Indication in "Preset select"*
1/3 step	7, – and + sides	+ 0 BKT -	0, -1.0, -0.7, -0.3, +0.3, +0.7, +1.0	—
1/2 step	7, – and + sides	+ 0 BKT -	0, -1.5, -1.0, -0.5, +0.5, +1.0, +1.5	—
2/3 step	7, – and + sides	+ 0 BKT -	0, -2.0, -1.3, -0.7, +0.7, +1.3, +2.0	—
1 step	7, – and + sides	+ 0 BKT -	0, -3.0, -2.0, -1.0, +1.0, +2.0, +3.0	—
1/3 step	5, – and + sides	+ 0 BKT -	0, -0.7, -0.3, +0.3, +0.7	—
1/2 step	5, – and + sides	+ 0 BKT -	0, -1.0, -0.5, +0.5, +1.0	—
2/3 step	5, – and + sides	+ 0 BKT -	0, -1.3, -0.7, +0.7, +1.3	—
1 step	5, – and + sides	+ 0 BKT -	0, -2.0, -1.0, +1.0, +2.0	—
1/3 step	3, – and + sides	+ 0 BKT -	0, -0.3, +0.3	3F0.3EV ◀ ▶
1/2 step	3, – and + sides	+ 0 BKT -	0, -0.5, +0.5	3F0.5EV ◀ ▶
2/3 step	3, – and + sides	+ 0 BKT -	0, -0.7, +0.7	3F0.7EV ◀ ▶
1 step	3, – and + sides	+ 0 BKT -	0, -1.0, +1.0	3F1.0EV ◀ ▶
1/3 step	2, – side	+ 0 BKT -	0, -0.3	2F0.3EV ▶
1/2 step	2, – side	+ 0 BKT -	0, -0.5	2F0.5EV ▶
2/3 step	2, – side	+ 0 BKT -	0, -0.7	2F0.7EV ▶
1 step	2, – side	+ 0 BKT -	0, -1.0	2F1.0EV ▶

Compensated EV value	Number of shots	Bracketing indicator (top LCD panel)	Bracketing order (default setting)	Indication in "Preset select"*
1/3 step	2, + side	+ 0 BKT -	0, +0.3	2F0.3EV ◀
1/2 step	2, + side	+ 0 BKT -	0, +0.5	2F0.5EV ◀
2/3 step	2, + side	+ 0 BKT -	0, +0.7	2F0.7EV ◀
1 step	2, + side	+ 0 BKT -	0, +1.0	2F1.0EV ◀
1/3 step	3, - side	+ 0 BKT -	-0.3, -0.7, 0	3F0.3EV ▶
1/2 step	3, - side	+ 0 BKT -	-1.0, -0.5, 0	3F0.5EV ▶
2/3 step	3, - side	+ 0 BKT -	-1.3, -0.7, 0	3F0.7EV ▶
1 step	3, - side	+ 0 BKT -	-2.0, -1.0, 0	3F1.0EV ▶
1/3 step	3, + side	+ 0 BKT -	+0.3, 0, +0.7	3F0.3EV ◀
1/2 step	3, + side	+ 0 BKT -	+0.5, 0, +1.0	3F0.5EV ◀
2/3 step	3, + side	+ 0 BKT -	+0.7, 0, +1.3	3F0.7EV ◀
1 step	3, + side	+ 0 BKT -	+1.0, 0, +2.0	3F1.0EV ◀

* When the "Preset select" is set in "e8: Auto BKT selection", ( 106) the indication appears when selecting the combinations of compensated EV value and the number of shots. In this setting, the combinations indicated with  cannot be selected.

- When the number of shots other than two is selected, shot of middle EV value is taken first. The following shots are successively taken from negative to positive value.
- Compensated EV value can be set regardless of the setting in Custom Setting "b1: EV step" ( 97). Shutter speed and aperture indication may not correspond to actual values during Bracketing depending on the setting in "b1: EV step".

CSM e7: Bracketing order can be set to change from negative EV value to positive EV value ( 106).

Auto Exposure Bracketing—continued

■ Canceling Auto Exposure Bracketing

- To cancel Bracketing, while pressing the BKT button rotate the Main-Command Dial so the number of shots becomes “0” (the compensated EV value previously selected will remain). Or, rotate the Main-Command Dial and select “OFF” when the “Preset value select” is selected in “e8: Auto BKT selection” (the number of shots and compensated EV values previously selected will remain).
- Bracketing is also canceled when Two-Button Reset (🔧 147) is performed, selecting another Custom Bank (🔧 91), Custom Reset is performed (🔧 92) or setting is changed in Custom Setting “b1: EV step” or “b2: Exp. comp. EV” (🔧 97).

🔧 Auto Exposure Bracketing and other functions

- If the exposure compensation function (🔧 74) is also set, Bracketing will be combined with the exposure compensation values. It is useful to perform Bracketing with a compensated value of over +3 EV or under -3 EV.
- With film advance mode in CL (continuous low-speed), CH (continuous high-speed) or Cs (continuous silent-low-speed), fully depress and hold the shutter release button until the set number of shots has been taken and film advance stops automatically. If “Bracketing burst” is selected in the Custom Setting menu “f3 FUNC Button”, Auto Exposure Bracketing will be performed repeatedly even after the selected number of shots has been reached as long as the shutter release button is kept pressed while the FUNC. button is pressed (🔧 108).
- In S (single frame) film advance mode, if “Bracketing burst” is selected in the Custom Setting menu “f3 FUNC Button”, Bracketing is performed until the set number of shots has been taken as long as the shutter release button is kept depressed while the FUNC. button is pressed, and film advance stops automatically (🔧 108).
- If the Self-Timer (🔧 82) is also set, Bracketing is performed one frame at a time (until the selected number of shots has been reached).





















🔧 If the end of the film roll is reached during Bracketing

The remaining shots can be taken after new film has been loaded. Also, if you turn the power switch off during Bracketing, the remaining shots can be taken after the power is turned back on.

- 🔧 Shutter speed is not shifted under the conditions noted below. If “Aperture”, “Speed/Aperture” or “Flash” is selected in Custom Setting menu “e6 M mode bkting”, Auto Exposure Bracketing (in which aperture or TTL Auto flash level is shifted) can be performed (🔧 106).
 - “On” is selected in Custom Setting menu “b5 Extend Shtr. Spd” (🔧 98) and shutter speed slower than 40 sec. is set.
 - Shutter speed is set to X in Manual exposure mode.
 - Shutter speed is set to Bulb when using a Speedlight.











Bracketing indicator during shooting

- As each shot is taken, the indicator for each compensated EV value disappears.
- See examples below.

Status of Bracketing	1/3 EV steps, 3 shots, – and +		2/3 EV steps, 3 shots, –	
	Top LCD panel	Rear LCD panel	Top LCD panel	Rear LCD panel
Setting done	+ 0 	- 0.3  ◀ ▶	+ 0 	- 0.7  ▶
1st shot taken	+ 0 	- 0.3  ◀	+ 0 	- 0.7  ▶
2nd shot taken	+ 0 	- 0.3  ◀	+ 0 	- 0.7 
3rd shot taken	+ 0 	- 0.3 	+ 0 	- 0.7 
Approx. 0.5 sec. after the 3rd shot	+ 0 	- 0.3  ◀ ▶	+ 0 	- 0.7  ▶

Bracketing indicator in exposure compensation

- Bracketing indication is shifted according to the exposure compensation value. However, if the maximum compensation value exceeds the indicator's scale, ◀ or ▶ appears.

Compensation value	1/3 EV steps 3 shots, – and +	2/3 EV steps 3 shots, –
No compensation	+ 0 	+ 0 
+1.0	+ 0 	+ 0 
+2.7	+ 0 	+ 0 
-3.0	+ 0 	+ 0 
-4.0	+ 0 	+ 0 

Long Time Exposure

This function is useful for shooting nighttime scenes such as stars, which require an extended exposure of more than 30 sec. The shutter remains open as long as the shutter release button is kept fully depressed. (Use of a tripod is recommended.)

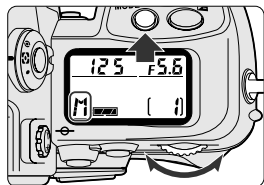

1 While pressing the exposure mode button **MODE**, rotate the Main-Command Dial to select **M** (Manual exposure).

- Use the LCD illuminator ( 81) to view the LCD panel in the dark.

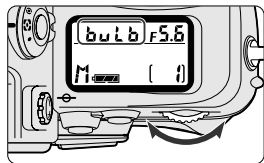

2 Rotate the Main-Command Dial to select **bulb** and rotate the Sub-Command Dial to set the aperture.

- If **bulb** is selected in Manual exposure mode and the exposure mode is changed to Shutter-Priority Auto, **bulb** blinks and the shutter locks.
- Continuous exposure of approx. 5 hours is possible with 3V lithium batteries. Note that when shooting at low temperatures, continuous exposure time is reduced.



3 Compose picture, focus and shoot.

- The shutter remains open as long as the shutter release button is kept fully depressed.
- Use of the optional remote cord MC-20 or MC-30 ( 171) reduces camera shake.

Power source

Use of a fresh set of batteries is recommended to avoid power shortage during long time exposure. Also, optional Multi Power Battery Pack MB-40 ( 166) enables prolonged long time exposure.

CSM b5: In Manual exposure mode, the slowest shutter speed can be changed from 30 sec. to 30 min. ( 98).

Dioptr Adjustment/LCD Illuminator

■ Dioptr adjustment

The finder diopter enables near- or far-sighted photographers to adjust the eyepiece diopter to suit their vision.

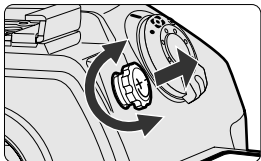

Pull up the diopter adjustment knob and rotate while looking through the viewfinder until the focus brackets in the viewfinder appear sharp.

- The adjustable range of the finder diopter is $-2m^{-1}$ to $+1m^{-1}$. Five optional eyepiece correction lenses DK-17C provide a viewfinder diopter range of $-3m^{-1}$ to $+2m^{-1}$ (☒ 167).

☑ Using the diopter adjustment knob

Since the diopter adjustment knob is located next to the viewfinder, take care to avoid injuring your eye while rotating the knob.

👁 Attaching eyepiece correction lenses

Before attaching an eyepiece correction lens (optional; ☒ 167), remove the viewfinder eyepiece DK-17.

1. Close the eyepiece shutter and unlock ①.
2. Detach the supplied eyepiece from the camera body by rotating it counterclockwise ②.
3. Attach the eyepiece correction lens by firmly screwing it in clockwise.
4. Open the eyepiece shutter and lock.

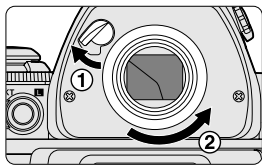

■ LCD illuminator

Displays in the top and rear LCD panels can be confirmed in the dark with the LCD illuminator.

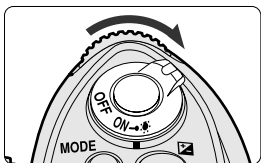



Rotate the power switch to . The exposure meter turns on and the LCD panel is illuminated in green.

- When the power switch is released, it returns to the “on” position, but illumination remains on as long as the exposure meter is on. Illumination turns off after shutter release.

Self-Timer Operation

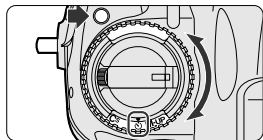
The self-timer allows you to put yourself in the picture, or if you want to avoid touching the camera to avoid shake just before exposure. Use a tripod or place the camera on a stable surface before using the self-timer.



- 1** While pressing the film advance mode selector lock release, set the film advance mode selector to .

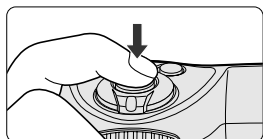

- 2** Compose picture, focus and fully depress the shutter release button.

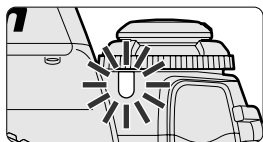

- Do not stand in front of the lens when setting the self-timer in autofocus mode.
- Once the self-timer is activated, the shutter will release in 10 seconds (default setting). The self-timer indicator LED will blink for 8 sec., then stop blinking 2 sec. before the shutter is released.
- Self-timer shooting cannot be performed when the camera's shutter cannot be released (i.e. when subject cannot be brought into focus with autofocus in Single Servo AF).
- To cancel the self-timer, set the film advance mode selector to a position other than .
- When **b u l l b** is selected in Manual exposure mode, shutter speed is controlled to approx. 1/10 sec.

Close the viewfinder eyepiece shutter

To ensure correct exposure in exposure modes other than manual, close the viewfinder eyepiece shutter after focusing. This will prevent light entering via the viewfinder from interfering with the autoexposure operation.

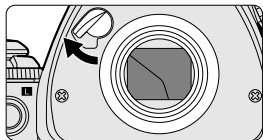

CSM c5: The time delay of the self-timer can also be set to 2, 5, or 20 sec. ( 100).

Depth-of-Field Preview/Film Plane Indicator

■ Depth-of-field preview

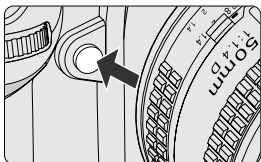

Depress the depth-of-field preview button to confirm the depth of field through the viewfinder.

- Pressing the depth-of-field button stops the lens down to the aperture controlled in Programmed Auto or Shutter-Priority Auto exposure mode, and down to the aperture selected in Aperture-Priority Auto or Manual exposure mode. By looking through the viewfinder, the approximate depth of field (📷 164) with the given aperture can be confirmed.
- Modeling flash is also fired with optional Speedlight SB-800 and SB-600 (📷 151). To cancel modeling flash, turn the Speedlight off or select "Off" in the Custom Setting "e4: Modeling flash" (📷 105).
- Exposure is locked (📷 72) simultaneously before stopping the lens down with CPU lens. Correct exposure will be obtained by releasing the shutter with the depth-of-field button pressed.

■ Film plane indicator

The film plane indicator shows the position of the film plane inside the camera body.

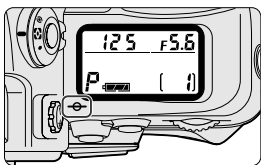

- The film plane indicator shows the standard line of the shooting distance and indicates the position of the film plane inside the camera body. Use this indicator when measuring actual camera-to-subject distance, e.g. in close-up photography.
- The exact distance from the lens mounting flange to the film plane is 46.5mm.

Mirror Up Photography

Mirror up photography is ideal for situations in which camera shake is likely. Press the shutter release button once to raise mirror, and press again to take the photograph.

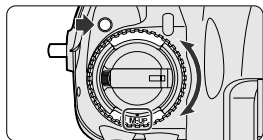

- 1** While pressing the film advance mode selector lock release, set the film advance mode selector to **M-UP** (mirror up).

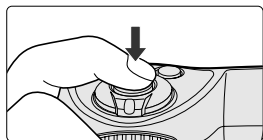

- 2** Compose picture, focus and press the shutter release button to raise the mirror.
 - In AF operation, exposure and focus are locked just before the mirror is raised, and framing cannot be confirmed in the viewfinder while the mirror is raised.

- 3** Press the shutter release button again to release the shutter. The mirror returns to original position.

■ Canceling mirror up mode

- Set the film advance mode selector to a position other than M-UP after releasing the shutter. (Mirror up mode is canceled by the same operation while the mirror is up; however, shutter is released automatically and film advances by one frame.)
- In the following situations, the shutter is automatically released and film advances by one frame but mirror up mode is not canceled:
 - Approx. 30 sec. after mirror is raised
 - Camera power is turned off

✔ Cautions in mirror up photography

- Do not leave the camera in M-UP mode under sunlight, especially when using a large-diameter lens. The shutter curtain could be burned.
- When the R1 button is pressed while mirror is up, the shutter is released, **Err** blinks in the top LCD panel and viewfinder, and ERR is displayed in the rear LCD panel. Depress the shutter release button to turn off these warnings (film advances by one frame but the frame counter remains unchanged).

- ✔ Use of a Remote Cord MC-20 or MC-30 reduces camera shake even more in mirror up photography (📷 171).

Changing Focusing Screens

In addition to the supplied B-type BriteView screen, other optional interchangeable focusing screens (type U, E, M, J, A and L,  168) are available for the F6.

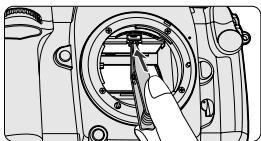
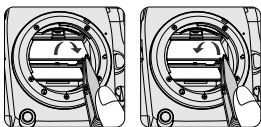
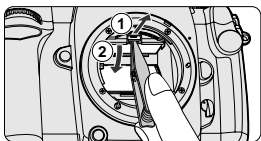
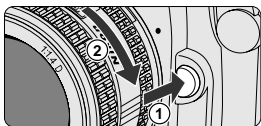
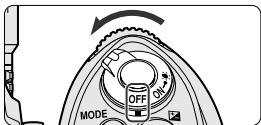

1 Turn the power switch off, remove the lens from the camera body and pull the focusing screen release latch outward using the supplied tweezers.

- The holder will spring open when the focusing screen release latch is pulled outward.

2 Remove the screen by grasping the small tab with the tweezers, and set the replacement screen in place.

- Make sure the screen is set properly.

3 Using the tweezers, push the front edge of the holder upward until it clicks into place.

- Be sure not to touch the reflex mirror or the surfaces of the focusing screens.
- Always use F6 focusing screens (focusing screens for other cameras cannot be used).

Focusing screen compensation

No compensation is required with type B or E focusing screens or in Matrix metering. With screens other than type B or E, the EV level of the focusing screen may require compensation depending upon the focusing screen, lens, or teleconverter attached. To compensate EV level, set "Other screen" in Custom Setting "b6 Screen comp." ( 98). (For the appropriate compensation value, see the instruction manual of the focusing screen.)

- For focusing screens other than B- or E-type, "Other screen" must be set even when the compensation value is "0".

Self-Diagnostic Shutter System

The F6 is equipped with a self-diagnostic shutter that automatically controls the shutter speed for each release of the shutter.

The self-diagnostic shutter automatically detects inaccuracies in performance and readjusts the shutter speed for greater accuracy in subsequent shooting. Also, if a malfunction is detected or the shutter curtain fails to operate, **Err** blinks in the top LCD panel and in the viewfinder.

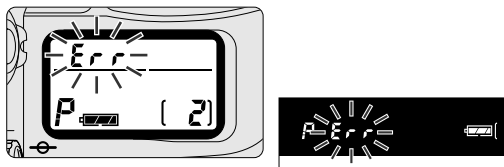

- The above warnings are displayed when any malfunction is detected. Fully depress the shutter release button once. If **Err** in the top LCD panel and viewfinder stops blinking, the malfunction is corrected. If **Err** continues blinking, turn the power off and take the camera to an authorized Nikon dealer or service center for repair.
- The picture at the frame where the warning appeared may not have been taken properly.
- In rare cases, the warning may not appear when the shutter malfunctions.

Menu Guide

Details on each menu are described in this section.

■ Custom Setting menu (🔗 90-110)

- Create a combination of functions that are different from the initial factory settings.



■ Setup menu (🔗 111-124)

- Settings such as recording shooting data or date (🔗 35) are in setup menu.

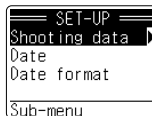

■ Shooting menu (🔗 125-143)

- Imprint shooting data, multiple exposure and interval timer settings are selected in shooting menu.

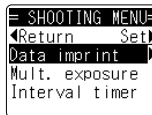

■ Non-CPU lens (🔗 144-146)

- Focal length and maximum aperture of non-CPU lens are set in lens data.

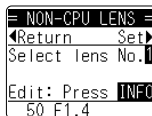

■ Language (🔗 34)

- Set language displayed in the rear LCD panel.



Operation in Menu (all menus)

Press ▲ or ▼ on the multi-selector to change the highlighted selection and ► (or center) to make settings or selections in the menu display.

■ Setting menu (Example: Custom Setting menu, a3: Group dynamic AF)

- 1 Turn the Power switch on and press the MENU button to display the menu.



- Unlock the multi-selector if it is locked.

- 2 Display desired menu.

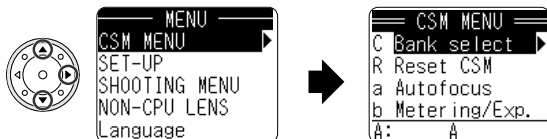

- Press ▲/▼ on the multi-selector to select the desired menu and press ► so the menu display appears.

- 3 Display desired item.

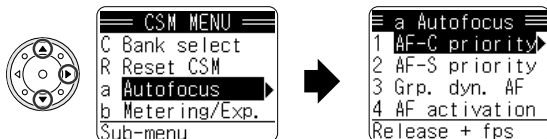

- Press ▲/▼ to select your desired item and ► to display details of the item (sub-menu).

- 4 Display the desired function.

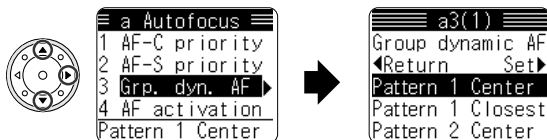

- Press ▲/▼ to select your desired function from the sub-menu and ► to display settings of the function.

- Further sub-menus are available in the “a5: Focus area illum” and “f4: Command dials”.

5 Set the function.

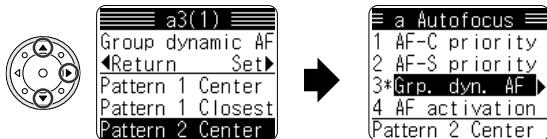

- Press ▲/▼ to select the desired setting and ► to set and return to the menu display selected in step 3.

6 Complete the procedure.

- Press ◀ button to backtrack display by display, or press MENU button twice to return to the Shooting data display.

Menu display



①: Level of layer [=====]

The number of horizontal lines at the top of the menu indicates the level of layer. The deeper the layer you are, the greater the number of lines displayed.



②: Submenu [►]

“►” to the right of an option indicates that a submenu is available for that option.



③: Setting other than default [*]

“*” to the left of an option indicates that the selected option is a setting other than default.

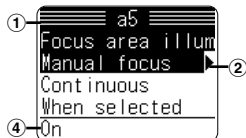

④: Setting

The selected option setting is displayed at the bottom. If a submenu is available for the selected option, “Sub-menu” is displayed.

Custom Setting Menu

This feature allows you to create a combination of functions that differ from the initial factory settings.

■ Custom Setting options

CSM MENU	
C	Bank select
R	Reset CSM
a	Autofocus
b	Metering/Exp.
A:	A

CSM MENU	
c	Timers/Lock
d	Shoot/Display
e	BKT/Flash
f	Controls
Sub-menu	

- Sub-menus are available for all options in groups a to f.

Custom setting option		
C: Bank select		91
R: Reset CSM		92
a: Autofocus		
a1	AF-C priority	94
a2	AF-S priority	94
a3	Grp. dyn. AF	94
a4	AF activation	95
a5	Area illum.	95
a6	Area select	96
a7	Vert. AF-ON	96
a8	M/A mode	96
b: Metering/Exp.		
b1	EV step	97
b2	Exp. comp. EV	97
b3	Exp. comp.	97
b4	Center weight	98
b5	Shutter spd.	98
b6	Screen comp.	98
c: Timers/Lock		
c1	AE Lock	99
c2	AE-L/AF-L	99
c3	AF-ON/AE-L	100
c4	Auto mtr-off	100
c5	Self-timer	100

Custom setting option		
d: Shoot/Display		
d1	Film loading	101
d2	Film rewind	101
d3	Film leader	101
d4	Last frame	102
d5	MB-40 CH fps	102
d6	DX warning	102
d7	Rear panel	103
d8	Imprint den.	103
d9	MB-40 Battery	103
e: BKT/Flash		
e1	Sync speed	104
e2	Slowest speed	104
e3	AA flash mode	105
e4	Modeling	105
e5	Auto BKT set	105
e6	M mode bkting	106
e7	Bkting order	106
e8	Bkting select	106
f: Controls		
f1	Center button	107
f2	Selector	107
f3	FUNC. button	108
f4	Command dials	109
f5	Buttons/dials	110

■ Details on Custom Setting options (default setting in bold type)

C: Bank select

Combinations of functions set in groups a-f can be stored in "bank" A, B, C or D, and a six-letter/number can be designated for each bank.

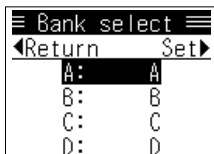

Options:

- A: Select bank A
- B: Select bank B
- C: Select bank C
- D: Select bank D

- Select your desired Custom Setting bank from A-D and press ► to display "Rename". If you do not wish to rename, press ► to set. To name the bank, see the following.

■ Renaming bank

Six letters (A to Z and a blank) and/or numbers (0 to 9) can be assigned to each Custom Setting bank.

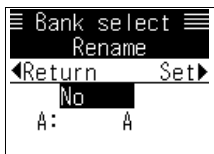

- Press ▲/▼ on the multi-selector to highlight " A "
- and ► to highlight the first digit.
- Press ▲/▼ to select the desired letter/number.
- Press ► to highlight the second to sixth digits and ▲/▼ to select the desired letter/number for each.
- Press ► after selecting the sixth letter/number to set. The display returns to the Custom Setting menu.

✍ Changing the setting for an option in a particular bank (A to D) does not affect the setting for that option in other banks.

✍ If any setting in selected Custom bank (A to D) has been changed from the original factory setting, Custom Setting indication is displayed in the rear LCD panel. Example: **CSM-A** (Custom bank A)

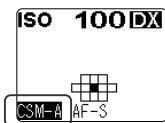

Custom Setting Menu—continued

R: Reset CSM

In Reset CSM, all options can be reset to their initial factory settings. Only the settings in your selected Custom Setting bank (A to D) will be reset.

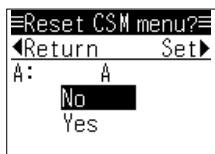

Options:
No: Reset is not executed
Yes: Reset is executed

- Select desired Custom Setting bank from A-D and press ► on the multi-selector to display the confirmation window.
- Select “Yes” and press ► to execute reset.

■ Default settings of each option

Custom setting option	Default setting
a: Autofocus	
a1 AF-C priority	Release + fps
a2 AF-S priority	Focus priority
a3 Grp.dyn. AF	Pattern 1 Center
a4 AF activation	Release/AF-ON
a5 Area illum.	
Manual focus	On
Continuous	On
When selected	0.2 s
a6 Area select	No wrap
a7 Vert. AF-ON	AF-ON
a8 M/A mode	Autofocus off
b: Metering/Exp.	
b1 EV step	1/3 step
b2 Exp. comp. EV	1/3 step
b3 Exp. comp.	[+/-] & CMD Dial
b4 Center weight	∅ 12mm
b5 Shutter Spd.	Off
b6 Screen comp.	B or E (off)

Custom setting option		Default setting
c: Timers/Lock		
c1	AE Lock	AE-L/AF-L button
c2	AE-L/AF-L	AE/AF lock
c3	AF-ON/AE-L	Default
c4	Auto mtr-off	8 s
c5	Self-timer	10 s
d: Shoot/Display		
d1	Film loading	Close back
d2	Film rewind	Auto
d3	Film leader	Rewind leader in
d4	Last frame	End of film
d5	MB-40 CH fps	8 fps
d6	DX warning	After film load
d7	Rear panel	Normal
d8	Imprint den.	0
d9	MB-40 Battery	Alkaline (AA)
e: BKT/Flash		
e1	Sync speed	1/250
e2	Slowest speed	1/60
e3	AA flash mode	Off
e4	Modeling	On
e5	Auto BKT set	AE & flash
e6	M mode bkting	Speed
e7	Bkting order	MTR>Under>Over
e8	Bkting select	Manual select
f: Controls		
f1	Center button	Center AF area
f2	Selector	No action
f3	FUNC. button	FV Lock
f4	Command dials	
	Rotation	Normal
	Assignment	Off
	Aperture	Sub-command dial
	Menus	Off
f5	Buttons/dials	Default

Custom Setting Menu—continued

a1: AF-C priority

 48

The default setting for Continuous Servo AF is release priority. However, film advance speed can be set to decrease as much as possible to ensure a correct focus. (Useful in situations such as using focus tracking under dark conditions.) Also, it can be changed to focus priority, in which the shutter can be released only when the subject is in focus

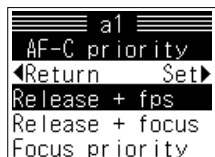

Options:

Release + fps: Shutter is released when the shutter release button is pressed

Release + focus: Shutter is released when the shutter release button is pressed but film advance rate drops to ensure a correct focus

Focus priority: Shutter cannot be released unless subject is in-focus

a2: AF-S priority

 48

The default setting for Single Servo AF is focus priority. However, it can be changed to release priority.

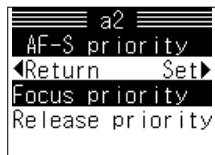

Options:

Focus priority: Shutter cannot be released unless subject is in-focus

Release priority: Shutter is released when the shutter release button is pressed

a3: Group dynamic AF

 52

The pattern of the groups in Group Dynamic AF Mode can be changed.

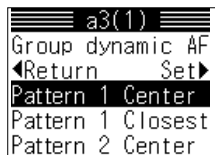

Options:

Pattern 1 Center: Center-Subject Priority in Pattern 1

Pattern 1 Closest: Closest-Subject Priority in Pattern 1

Pattern 2 Center: Center-Subject Priority in Pattern 2

Pattern 2 Closest: Closest-Subject Priority in Pattern 2

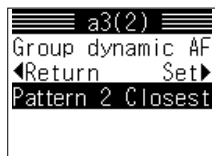

• For the pattern of the groups of focus areas in Group Dynamic AF Mode, see page 53.

a4: AF activation **28, 49**

Autofocus operation is activated by lightly pressing the shutter release button at the default setting. However, it can be set to be started only by pressing the AF start button.

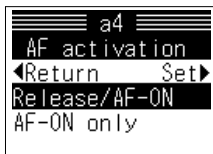

Options:

Release/AF-ON: Autofocus initiated by lightly pressing the shutter release button or AF start button

AF-ON only: Autofocus initiated only by pressing the AF start button

a5: Area illum. **50**

In manual focus or continuous shooting, you can cancel the red highlighting of the selected focus area. Also, you can change the duration of the red focus area display to 0.2 sec. or 1 sec.

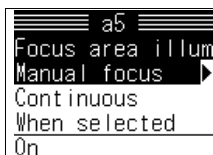

Options:

Manual focus: Select On/Off for focus area illumination in Manual focus

Continuous: Select On/Off for focus area illumination in continuous shooting

When selected: Select the duration of illumination

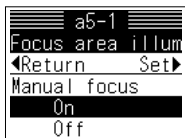
a5-1: Manual focus

Options:

On: Selected focus area illuminated in Manual focus

Off: Selected focus area not illuminated in Manual focus

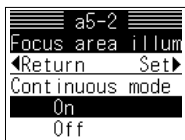
a5-2: Continuous mode

Options:

On: Selected focus area illuminated in continuous shooting

Off: Selected focus area not illuminated in continuous shooting

Custom Setting Menu—continued

a5-3: When selected

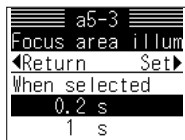

Options:

- 0.2 s:** Selected focus area (by multi-selector) is illuminated for 0.2 sec.
- 1 s:** Selected focus area (by multi-selector) is illuminated for 1 sec. In autofocus operation, selected focus area continues to blink.

a6: Area select

 50

The focus area can be set to be changed continuously in the same direction by pressing the same position on the multi-selector. This option enables you to switch the focus area to the opposite direction without having to press the opposite position on the multi-selector.

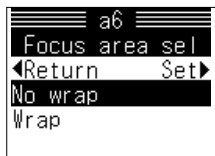

Options:

- No wrap:** Focus area does not change continuously in the same direction
- Wrap:** Focus area changes continuously in the same direction

a7: Vert. AF-ON

 166

The function of the AF start button for vertical shooting on Multi Power Battery Pack MB-40 (optional) can be changed to assume the function of the AE/AF-L button.

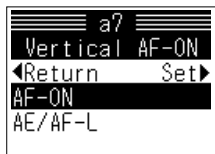

Options:

- AF-ON:** Operate as AF start button
 - AE/AF-L:** Operate as AE/AF-L button
- Setting in Custom Setting "c2: AE-L/AF-L" ( 99) becomes effective when "AE/AF-L" is selected.

a8: M/A mode

 61

If the AF-S lens you are using supports autofocus with manual priority (M/A), you can choose to allow autofocus operation in Manual focus.

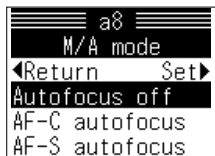

Options:

- Autofocus off:** Manual focus selected
- AF-C autofocus:** Autofocus possible in Continuous Servo AF
- AF-S autofocus:** Autofocus possible in Single Servo AF

b1: EV step

 64, 66, 68, 70

At the default setting, shutter speed and aperture are indicated in 1/3 EV steps. However, this can be changed to 1/2 or 1 EV steps.



Options:

1/3 step: Indicated/selected in 1/3 EV steps

1/2 step: Indicated/selected in 1/2 EV steps

1 step: Indicated/selected in 1 EV steps

b2: Exp. comp. EV

 74

At the default setting, exposure compensation is set in 1/3 EV steps. However, this can be changed to 1/2 or 1 EV steps.

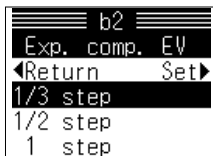

Options:

1/3 step: Selected in 1/3 EV steps

1/2 step: Selected in 1/2 EV steps

1 step: Selected in 1 EV steps

b3: Exposure comp.

 74

Exposure compensation is set using the Main-Command Dial and the  button by default. However, it can be set to be selected using only the Sub-Command Dial in Programmed Auto and Shutter-Priority Auto, or using only the Main-Command Dial in Aperture-Priority Auto exposure mode.

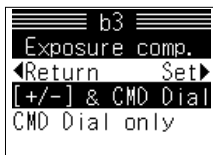

Options:

[+/-] & CMD Dial: Exposure compensation selected with Command Dial while pressing the  button

CMD Dial only: Exposure compensation selected only with Command Dial

- If “CMD Dial only” is selected in Manual exposure mode, electronic analog displays in the top LCD panel and viewfinder appear and “0” of the display blinks. In Manual exposure mode, exposure compensation cannot be selected only with the Command Dial even if “CMD Dial only” is selected.
- If “Change Main/Sub” is selected in “f4: Command dials” ( 109), the operation of the Main- and Sub-Command Dials switch (except in Programmed Auto exposure mode).

Custom Setting Menu—continued

b4: Center weight

 63

Area of meter's sensitivity (concentration of 75%) in Center-Weighted Metering can be changed. Also, the sensitivity can be set to average in the entire frame.



Options:

- ø 8mm: 8mm dia. Center-Weighted Metering circle
- ø 12mm:** 12mm dia. Center-Weighted Metering circle
- ø 15mm: 15mm dia. Center-Weighted Metering circle
- ø 20mm: 20mm dia. Center-Weighted Metering circle
- Average: Average of entire viewfinder

b5: Extend Shtr. Spd

 70

At the default setting, shutter speed in Manual exposure mode can be selected as slow as 30 sec. This can be extended down to 30 min.



Options:

- Off:** Not extended
- On: Extended

- With "On" selected, the following shutter speeds over 30 sec. can be selected with the Main-Command Dial.
40 sec., 50 sec., 1 min., 1.5 min., 2 min., 3 min., 4 min., 5 min., 6 min., 8 min., 10 min., 13 min., 15 min., 20 min., 25 min., 30 min.
- When these shutter speeds are selected, shutter speed is not compensated in Auto Exposure Bracketing and electronic analog display turns off.

b6: Screen comp.

 85, 168

Exposure value must be compensated depending on focusing screen, lens or teleconverter used.

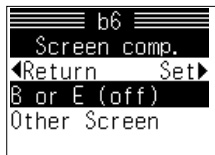

Options:

- B or E (off):** No compensation
- Other screen: Compensation

- See the next page for setting compensation value.
- For focusing screen other than B- or E-type, "Other screen" must be set even when the required compensation value is "0".

■ Setting compensation value

Exposure can be compensated up to ± 2 EV in 1/2 steps (see the instruction manual of the focusing screen for the required compensation value).

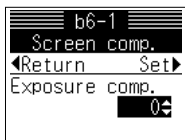

- Press **▶** on the multi-selector after selecting “Other screen”. Display for setting compensation value appears.
- Press **▲/▼** to select compensation value and **▶** to set.

c1: AE Lock

 72

At the default setting, exposure is locked when AE/AF-L button is pressed. Exposure can also be set to be locked by pressing the shutter release button.



Options:

- AE-L/AF-L button:** Exposure locked with AE/AF-L button only
- + Release button: Exposure locked with either AE/AF-L button or shutter release button

c2: AE-L/AF-L

 58, 72

At the default setting, pressing the AE/AF-L button locks both exposure and focus. This can be changed as following.



Options:

- AE/AF lock:** Both exposure and focus are locked
- AE lock only:** Only exposure is locked
- AE-L hold/reset:** Exposure remains locked until shutter is released, exposure meter is off or AE/AF-L button is pressed again
- AE lock hold:** Exposure remains locked until exposure meter is off or AE/AF-L button is pressed again (pressing shutter release button does not release the lock)
- AF lock only:** Only focus is locked

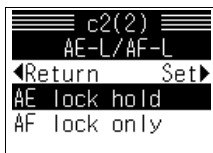

Custom Setting Menu—continued

c3: AF-ON/AE-L

 49, 58, 72

Functions of the AF start and AE/AF-L buttons can be changed as following.



Options:

Default: Functions remain unchanged

Switch function: Exchange each functions

Both AF-ON: Autofocus activated with AE/AF-L button
(function of AF start button unchanged)

Both AE-L: Exposure/focus locked with AF start button
(function of AE/AF-L button unchanged)



- Setting in “c2: AE-L/AF-L” ( 99) is also active in this option. For example, if “Both AE-L” is selected and “AF lock only” is set in “c2: AE-L/AF-L”, only focus is locked by pressing either AE/AF-L or AF start button.

c4: Auto meter-off

 18

After the shutter release button is pressed, the camera's exposure meter remains on for approx. 8 sec. (if no other operation is performed). This duration can be changed to 4, 15 or 30 sec.

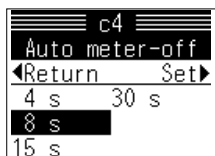

Options:

4 s

8 s

15 s

30 s

- Note that with longer auto meter-off duration, batteries are exhausted faster and usable number of film roll per battery decreases.

c5: Self-timer

 82

At the default setting, the shutter is released 10 sec. after the shutter release button is fully depressed. This duration can be changed to 2, 5 or 20 sec.



Options:

2 s

5 s

10 s

20 s

d1: Film loading

22

At the default setting, closing the camera back advances the loaded film to the first frame. However, this can be changed to start when the shutter release button is pressed.



Options:

Close back: Film is advanced to the first frame when camera back is closed

Press rel button: Film is advanced to the first frame when shutter release button is pressed

d2: Film rewind

46

Film starts to rewind automatically at the end of the roll. However, it can be set so it does not rewind automatically at the end of the film roll.

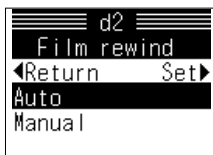

Options:

Auto: Film starts to rewind at the end of film roll

Manual: Film does not start to rewind film at the end of film roll. Press film rewind buttons to start film rewind.

d3: Film leader

32, 46

Film leader can be set to remain outside the film cartridge when it is rewound.

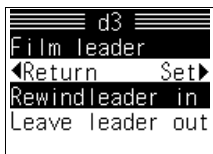

Options:

Rewind leader in: Film leader is rewound all the way

Leave leader out: Film leader remains outside the film cartridge when film is rewound

When Film leader is set to Leave leader out

- Do not release the shutter when film with film leader left outside the cartridge is loaded. Doing so can damage the shutter curtain.

d4: Last frame

 32

At the default setting, film starts to rewind automatically at the end of film roll. However, this can be changed to start after frame 36 or 35. (Useful in saving the film negative in 6 strips of 6-frame or 7 strips of 5-frame.)



Options:

End of film: Film starts to rewind at the end of film roll

Frame 36: Film starts to rewind after frame 36

Frame 35: Film starts to rewind after frame 35

- Film advance stops at frame 36 or 35 when “d2; film rewind” ( 101) is set to “Manual”.

d5: MB-40 CH fps

 45, 166

With the Multi Power Battery Pack MB-40 (optional) attached, the maximum film advance speed in CH (continuous high-speed) is 8 fps. However, this can be changed to 7 fps or 6 fps.



Options:

8 fps: Maximum film advance speed of 8 fps

7 fps: Maximum film advance speed of 7 fps

6 fps: Maximum film advance speed of 6 fps

d6: DX warning

 23

When film sensitivity is set to **DX** and non-DX-coded film is loaded, a warning appears when film is advanced to the first frame. However this can be changed so the warning appears when the power is turned on and camera back is closed (without advancing the film to the first frame).

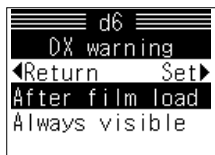

Options:

After film load: Non-DX film warning when film is advanced to the first frame

Always visible: Non-DX film warning when the power is turned on and camera back is closed (without advancing the film to the first frame)

d7: Rear panel **10**

The display on the rear LCD panel can be changed (from normal) to detailed display or large display.

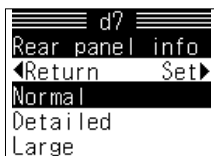

Options:
Normal
 Detailed
 Large

d8: Imprint density **136**

The darkness of data imprint can be adjusted in five levels.



Options:
 +2: Darker than +1
 +1: Darker
0: Default
 -1: Lighter
 -2: Lighter than -1

Adjusting setting:

- Press **▶** on the multi-selector after selecting "Imprint density". Display for setting appears.
- Press **▲/▼** to select darkness and **▶** to set.

d9: MB-40 Battery **19, 166**

Specify battery type so the battery power indication is displayed correctly when the Multi Power Battery Pack MB-40 (optional) is used.

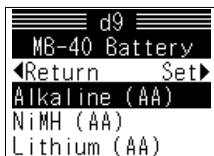

Options:
Alkaline (AA): AA-type alkaline-manganese
 NiMH (AA): AA-type Ni-MH
 Lithium (AA): AA-type lithium

- No specification is needed when using optional Rechargeable Li-ion Battery EN-EL4 (with optional Battery Chamber Cover BL-3).

Custom Setting Menu—continued

e1: Flash sync speed

 162

The top TTL flash sync speed can be changed (from 1/250 sec.) to any of the following settings:



Options:

- 1/250:** Top TTL flash sync speed of 1/250 sec.
- 1/250FP:** Top TTL flash sync speed of 1/250 sec.; when SB-800/SB-600 is attached and shutter speed is faster than 1/250 sec., FP High-Speed Sync Flash is automatically executed
- 1/200:** Top TTL flash sync speed of 1/200 sec.
- 1/160:** Top TTL flash sync speed of 1/160 sec.
- 1/125:** Top TTL flash sync speed of 1/125 sec.
- 1/100:** Top TTL flash sync speed of 1/100 sec.
- 1/80:** Top TTL flash sync speed of 1/80 sec.
- 1/60:** Top TTL flash sync speed of 1/60 sec.

- When “X” shutter speed is selected in Shutter-Priority Auto or Manual exposure mode, the shutter speed is automatically set to the speed set in “Flash sync speed”.
- See page 153 for details on FP High-Speed Sync Flash.

■ Setting flash sync speed:

- Press **▶** on the multi-selector after selecting “Sync speed”. Display for setting flash sync speed appears.
- Press **▲/▼** to select flash sync speed and **▶** to set.

e2: Slowest speed

 162

Slowest TTL flash sync speed in Programmed Auto or Aperture-Priority Auto exposure mode can be changed (from 1/60 sec.) to any of the following settings:

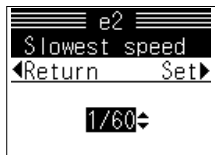

Options:

- | | |
|------------------------|--------------|
| 1/60: 1/60 sec. | 1": 1 sec. |
| 1/30: 1/30 sec. | 2": 2 sec. |
| 1/15: 1/15 sec. | 4": 4 sec. |
| 1/8: 1/8 sec. | 8": 8 sec. |
| 1/4: 1/4 sec. | 15": 15 sec. |
| 1/2: 1/2 sec. | 30": 30 sec. |

- The Slowest TTL flash sync speed is automatically set to 30 sec. in Slow Sync mode ( 158).

■ Setting shutter speed

- Press **▶** on the multi-selector after selecting “Slowest speed”. Display for setting shutter speed appears.
- Press **▲/▼** to select shutter speed and **▶** to set.

e3: AA flash mode

155

When non-TTL Auto flash mode is used with the SB-80DX or SB-28DX, Auto Aperture flash is not performed. However, this can be changed.

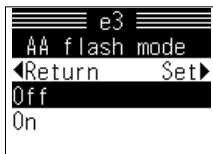

Options:

Off: Non-TTL Auto flash without Auto Aperture flash (Set aperture on the Speedlight)

On: Non-TTL Auto flash with Auto Aperture flash

- With the SB-800, setting on the Speedlight overrides the setting in “e3: AA flash mode”.

e4: Modeling flash

151

On the SB-800/SB-600, the modeling flash fires when the depth-of-field preview button on the camera is pressed. However, this can be changed.

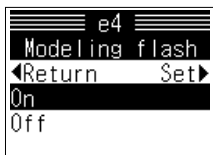

Options:

On: Modeling flash fired and depth-of-field preview

Off: Depth-of-field preview only

e5: Auto BKT set

75

At the default setting, both Auto Exposure Bracketing and Flash Exposure Bracketing are active. However, this can be changed so that only Auto Exposure Bracketing or Flash Exposure Bracketing is active.

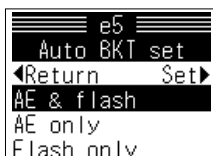

Options:

AE & flash: Auto Exposure Bracketing and Flash Exposure Bracketing are active

AE only: Only Auto Exposure Bracketing is active

Flash only: Only Flash Exposure Bracketing is active

Custom Setting Menu—continued

e6: M mode bkting

 75

At the default setting, shutter speed and flash output level are bracketed in Manual exposure mode. However, this can be changed to vary aperture, shutter speed and aperture or flash output level only.

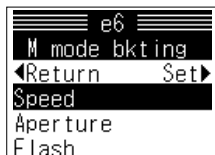

Options:

- Speed:** Shutter speed and flash output level* are varied
- Speed/ :** Shutter speed, aperture and flash output level* are varied
- Aperture** are varied
- Aperture:** Aperture and flash output level* are varied
- Flash:** Flash output level is varied

- When “AE only” is selected in “e5: Auto BKT set” ( 105), flash output level is not varied.

e7: Bkting order

 75

This option controls the order in which bracketing is performed.

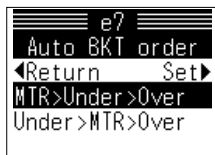

Options:

- MTR>Under>Over:** Bracketing performed in order shown on pages 76-77
- Under>MTR>Over:** Bracketing proceeds in order from lowest to highest value

e8: Auto BKT select

 75

At the default setting, the Main-Command Dial is used to select the number of shots, and the Sub-Command Dial is used to select compensated EV value. However, these dials can be set to control Bracketing as described below.

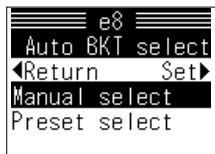

Options:

- Manual select:** Select number of shots using Main-Command Dial and compensated EV value using Sub-Command Dial
- Preset select:** Turn Bracketing on/off using Main-Command Dial and select set of Bracketing combinations using Sub-Command Dial

- See pages 76-77 for the set of Bracketing combinations that can be selected.

f1: Center button

 50, 88

Pressing the center of the multi-selector selects the center focus area or focus-area group (Group Dynamic AF). However its operation can be changed to any of the following settings:

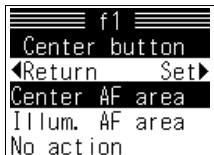

Options:

Center AF area: Pressing the center of the multi-selector selects the center focus area or center focus-area group (Group Dynamic AF)

Illum. AF area: Pressing center of multi-selector illuminates active focus area or focus-area group in viewfinder

No action: Pressing center of multi-selector has no effect when camera is in shooting mode

f2: Multi selector

 18, 28

The multi-selector can be used to activate the exposure meters or initiate autofocus, as described below

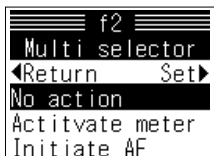

Options:

No action: Multi-selector does not activate exposure meters or initiate autofocus.

Activate meter: Pressing multi-selector activates exposure meter

Initiate AF: Pressing multi-selector initiates autofocus (except in Manual focus)

f3: FUNC. button



At the default setting, pressing the FUNC. button activated FV Lock (📷 151). However, this can be changed to any of the following settings:



Options:

FV Lock: If SB-800/SB-600 is attached, flash value locks when FUNC. button is pressed

FV Lock/Lens data: If SB-800/SB-600 is attached and on, flash value locks when FUNC. button is pressed; otherwise, focal length and maximum aperture combination of non-CPU lens (lens number) can be set with FUNC. button



1step spd/aptr: Shutter speed/aperture can be changed in 1 EV steps by rotating Main-/Sub-Command Dial regardless of the setting in the Custom Setting “b1: EV step”

As AE-L/AF-L: FUNC. button performs same function as AE/AF-L button



Flash off: To temporarily disable flash, press shutter release button while FUNC. button is pressed

Bracketing burst: While FUNC. button is pressed, all shots in Auto Exposure or Flash Exposure Bracketing will be taken each time shutter release button is pressed in single-frame shooting mode; in continuous shooting mode, camera will repeat bracketing burst while shutter release button is held down

Matrix metering: Matrix Metering is active while FUNC. button is pressed

Center-weighted: Center-Weighted Metering is active while FUNC. button is pressed

Spot metering: Spot Metering is active while FUNC. button is pressed

- “Lens data” cannot be selected alone; “FV Lock” is also selected.
- When “As AE-L/AF-L” is selected, function selected in “c2: AE-L/AF-L” (📷 99) is performed.

f4: Command dials

This option controls the operation of the Main- and Sub-Command Dials.



Options:

Rotation: Controls direction of command dials

Assignment: Exchange the functions of the Main- and Sub-Command Dials

Aperture: Set aperture with the lens' aperture ring only with non-G-type lens

Menus: Perform menu operations with command dials in addition to the multi-selector



- When options in the “Command dials” are changed, operation with Command Dials on the optional Multi Power Battery Pack MB-40 (166) and aperture setting are affected.

f4-1: Rotate direction



Options:

Normal: Normal command dial rotation

Reverse: Reverse rotation of command dials

f4-2: Change Main/Sub

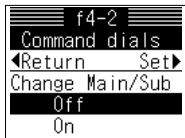

Options:

Off: Main-Command Dial controls shutter speed, Sub-Command Dial controls aperture

On: Main-Command Dial controls aperture, Sub-Command Dial controls shutter speed

Custom Setting Menu—continued

f4-3: Aperture setting



Options:

Sub-command dial: Aperture can only be adjusted using the Sub-Command Dial

Aperture ring: Aperture can only be adjusted using the lens' aperture ring when a non-G-type CPU lens is attached

- In Programmed Auto or Shutter-Priority Auto exposure modes, aperture cannot be set with the lens aperture ring even when "Aperture ring" option is selected.

f4-4: Menu status

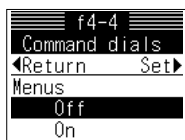

Options:

Off: Perform menu operations with multi-selector

On: Perform menu operations with multi-selector and command dials

- When "On" is selected, the Main-Command Dial operates as ▲/▼ on the multi-selector and the Sub-Command Dial operates as ◀▶.

f5: Buttons & dials



12

Normally, changes to settings that involve both a command dial and a button are made by rotating the command dial while the button is held down. If desired, this can be changed so that the buttons do not have to be held down for 20 sec. while the command dial is rotated. (Press the button again or lightly press the shutter release button to cancel the hold.)

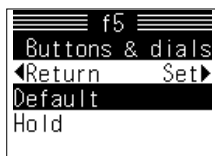

Options:

Default: Changes to settings made by rotating command dial while button is held down

Hold: Settings can be changed by rotating command dial even after button is released

- If "30 s" is selected in "Auto mtr-off", duration of "hold" becomes approximately 30 sec. (📷 100).

Setup Menu

Details on setup menu options (default setting in bold type)

Shooting data

 112

These settings are for storing shooting data. For details, see pages 112-124 “Recording shooting data”.

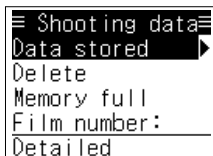

Options:

Data stored: Turns storing of shooting data on/off or selects shooting data mode



Delete: Deletes all shooting data

Memory full: Select operation when camera's memory is full (overwrite shooting data without warning or warning is displayed and shutter is locked without overwriting)

Film number: Sets ID number and film number

Date

 35

Set date for “recording shooting data” ( 112) and “imprinting shooting data” ( 126). For details on “setting date/time”, see pages 35-36.



• Set year, month, day, hour and minute.

Date format

 35

Set display order of data in rear LCD panel and in imprinting date ( 126).

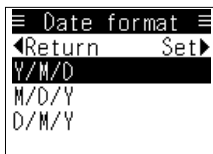

Options:

Y/M/D: Date is displayed/imprinted in order of year/month/day

M/D/Y: Date is displayed/imprinted in order of month/day/year

D/M/Y: Date is displayed/imprinted in order of day/month/year

Setup Menu [Recording Shooting Data]

Shooting data such as shutter speed, aperture or lens' focal length can be recorded in the camera, displayed in the rear LCD panel, or copied onto a CompactFlash™ card using the optional Data Reader MV-1 for use on a personal computer.

■ Recording mode and recording data

Two data recording modes—basic, in which 13 items of data can be recorded, and detailed, which enables recording of 21 items—are available.

Recorded data	Recording mode	
	Basic	Detailed
① Film sensitivity	<input type="radio"/>	<input type="radio"/>
② Film number	<input type="radio"/>	<input type="radio"/>
③ ID number	<input type="radio"/>	<input type="radio"/>
④ Frame count number	<input type="radio"/>	<input type="radio"/>
⑤ Shutter speed	<input type="radio"/>	<input type="radio"/>
⑥ Aperture	<input type="radio"/>	<input type="radio"/>
⑦ Selected focal length	<input type="radio"/>	<input type="radio"/>
⑧ Lens focal length		<input type="radio"/>
⑨ Maximum aperture		<input type="radio"/>
⑩ Metering system	<input type="radio"/>	<input type="radio"/>
⑪ Exposure mode	<input type="radio"/>	<input type="radio"/>

Recorded data	Recording mode	
	Basic	Detailed
⑫ Flash sync mode		<input type="radio"/>
⑬ Exposure compensation value	<input type="radio"/>	<input type="radio"/>
⑭ EV difference in Manual	<input type="radio"/>	<input type="radio"/>
⑮ Flash exposure compensation value		<input type="radio"/>
⑯ Speedlight		<input type="radio"/>
⑰ Multiple exposure	<input type="radio"/>	<input type="radio"/>
⑱ Auto Exposure lock		<input type="radio"/>
⑲ VR		<input type="radio"/>
⑳ Date	<input type="radio"/>	<input type="radio"/>
㉑ Time		<input type="radio"/>

- ① to ③: Film data
- ④ to ㉑: Frame data
- See page 113 for details on each data item.
- See page 116 for setting shooting data recording.

■ Recording data items

① Film sensitivity:

Film sensitivity of the loaded film when first shot is taken is recorded.

- With DX-coded film (when  is set), automatically set film sensitivity is recorded. When film sensitivity is manually set, the selected film sensitivity is recorded.

② Film number:

Film number (four-digit number) set at "SET-UP menu: Setting film number" ( 121) is recorded.

- Film number is recorded when a film roll is loaded and first shot is taken. One is added to the film number when a new film is loaded and first shot is taken.
- "0001" will be recorded after film number "9999" is reached.

③ ID number (data recording only):

ID number (three-digit number) set at "Resetting ID number or film number" ( 121) is recorded.

- The ID number becomes the folder name when recording shooting data on a memory card using the Data Reader MV-1 ( 166).

④ Frame count number:

Frame count number displayed in top LCD panel and viewfinder when shots are taken is recorded.

⑤ Shutter speed:

Shutter speed displayed in top and rear (in detailed and large displays) LCD panel and viewfinder when shots are taken is recorded.

⑥ Aperture:

Aperture displayed in top and rear (in detailed and large displays) LCD panels and viewfinder when shots are taken is recorded.

⑦ Selected focal length:

Selected focal length (zoom position) when shots are taken is recorded.

- Zoom position is recorded with a zoom lens and lens focal length is recorded with non-zoom lens.

⑧ Lens focal length:

Focal length of the attached lens when shots are taken is recorded.

- Lens' focal length at widest angle and at most telephoto (zoom range) are recorded with a zoom lens.

⑨ Maximum aperture:

Maximum aperture of the attached lens when shots are taken is recorded.

- Lens' maximum aperture lens at widest angle and most telephoto settings are recorded.

Setup Menu [Recording Shooting Data]—continued

⑩ Metering system:

Exposure metering system selected when shots are taken is recorded.

⑪ Exposure mode:

Exposure mode selected when shots are taken is recorded.

⑫ Flash sync mode:

Flash sync mode selected ( 157) when shots are taken is recorded.

- Even when Speedlight is not used, flash sync mode displayed in the rear LCD panel is recorded.

⑬ Exposure compensation value:

Exposure compensation value ( 74) set when shots are taken is recorded in 1/6 EV steps.



- “0” is recorded when no exposure compensation is set.
- In Auto Exposure Bracketing ( 75), Bracketing EV value is added to the compensation value. See “Recorded/imprinted exposure compensation/flash exposure compensation value” on page 148 for details.

⑭ EV difference in Manual (recording only):

Difference between the correct exposure measured by the camera and exposure value controlled by the camera or selected exposure (under- or overexposure) is recorded in 1/6 EV steps.

⑮ Flash exposure compensation value:

Flash exposure compensation value set when shots are taken is recorded. (See the instruction manual of the Speedlight for details on flash exposure compensation.)

- “0” is recorded when no flash exposure compensation is set.
- When exposure compensation ( 74) or Flash Exposure Bracketing ( 75) is performed in flash photography, flash output level is also compensated and recorded as flash exposure compensation value even when no flash exposure compensation is set. See “Recorded/imprinted exposure compensation/flash exposure compensation value” on page 148 for details.

⑯ Speedlight:

Speedlight settings are recorded. Following five items are recorded.

a: Flash mode (TTL)

Whether flash mode is TTL (i-TTL) or not is recorded.

- Flash mode is recorded as TTL when flash mode is set to i-TTL Balanced Fill-Flash, Standard i-TTL Flash, Automatic Balanced Fill-Flash with TTL Multi Sensor or Standard TTL Flash ( 150, 154)
- Flash mode is recorded as not TTL when no flash is used

b: Speedlight in use/not in use

Whether Speedlight is fired or not when shots are taken is recorded.

- Only Speedlight equipped with TTL flash capability ( 159, 160) is recorded.
- Even when Speedlight is attached, Speedlight is recorded as “not used” if it is turned off.

c: Advanced Wireless Lighting (recording only)

Whether Advanced Wireless Lighting (📷 151) is used or not when shots are taken is recorded.

d: Auto FP High-Speed Sync (recording only)

Whether Auto FP High-Speed Sync is used or not when shots are taken is recorded.

- Auto FP High-Speed Sync is recorded as used when FP High-Speed Sync (📷 153) is executed with a Speedlight not compatible with the Creative Lighting System.

e: FV Lock

Whether FV Lock (📷 151) is used or not when shots are taken is recorded.

⑰ **Multiple exposure:**

Whether or not multi exposure (📷 138) is executed when shots are taken is recorded.

⑱ **Auto Exposure Lock:**

Whether or not Auto Exposure Lock (📷 72) is activated when shots are taken is recorded.

⑲ **VR (recording only):**

When VR Nikkor lens (📷 38) is attached, whether or not VR (Vibration Reduction) function is used when shots are taken is recorded.

- VR is recorded as not used when a lens not compatible with VR function is attached.

⑳ **Date:**

Date when shots are taken is recorded in year/month/day, month/day/year or day/month/year.

㉑ **Time:**

Time when shots are taken is recorded in hour/minute.

Recording only data

- The items with “recording only” title, the data is not displayed when shooting data appears on rear LCD panel (📷 122) but the data is recorded in the camera’s memory and can be copied onto a memory card (📷 124) using optional Data Reader MV-1 (📷 166).

Aperture and focal length

- “⑥ Aperture”, “⑦ Selected focal length” ⑧ Lens focal length” and “⑨ Maximum aperture” are recorded only with CPU lens.
- With non-CPU lens, if the lens data is set in “Specifying lens data” (📷 144), set data is recorded (difference of EV steps from the maximum aperture is recorded if no maximum aperture is set; blank is recorded for maximum aperture and focal length if no lens data is specified).
- Effective aperture is recorded when Teleconverter is attached (only with CPU lens). However, the focal length is not recorded correctly when AF-S Teleconverter TC-17E II is used with AF-S 300mm f/2.8D ED or AF-S 400mm f/2.8D ED (focal length is recorded correctly with AF-S 300mm f/2.8D II ED or AF-S 400mm f/2.8D II ED).

■ Setting shooting data recording

- 1** Turn the power switch on when film is not loaded and press the MENU button to display menu.

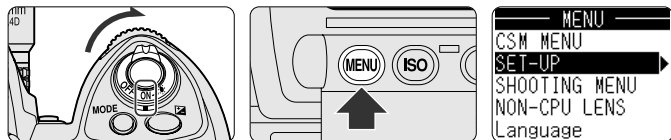

- Unload the film before setting shooting data. Shooting data cannot be set when the film is loaded.
- The shooting data recording cannot be set when shooting data is stored in camera's memory. Delete shooting data before setting. (See "Deleting shooting data" on page 118.)

2 Display Shooting data menu in SET-UP menu.

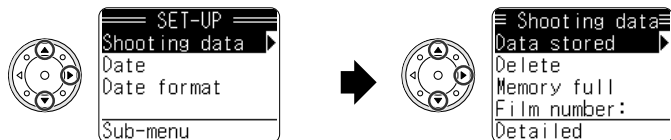

- Press ▲/▼ on multi-selector to select "SET-UP" menu and press ► so the SET-UP menu is displayed.
- Press ▲/▼ to select "Shooting data" menu and ► so the Shooting data menu is displayed.

3 Select Store settings in the Shooting data menu.

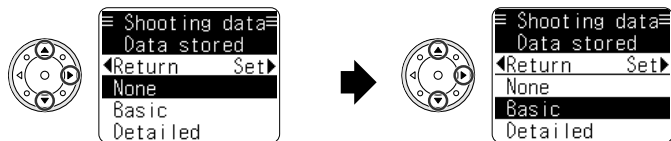

- Press ▲/▼ to select "Data stored" and ► to set.
- Press ▲/▼ to select "Basic" or "Detailed" and ► to set. The display returns to Shooting data menu.

4 Complete the procedure.



- Press ◀ to backtrack display by display, or press MENU button twice to return to the Shooting data display.

 **Make sure to set date/time ( 35) before setting the shooting data recording.**

 **Recording capacity (number of 36-frame film rolls)**

- In Basic recording mode: approx. 57 rolls
- In Detailed recording mode: approx. 31 rolls
- Select operation when camera's memory is full (overwrite shooting data without warning or warning is displayed and shutter is locked without overwriting) in "Shooting data menu: Stop data rec." in SET-UP menu,  119.

 **Sample of shooting data displays**





- When displaying shooting data in the rear LCD panel ( 122), film data and frame data are displayed separately.
- Following data are not displayed but recorded ( 124):
 - ID number
 - Flash sync mode
 - EV difference in Manual
 - Advanced Lighting System and Auto FP High-Speed Sync in Speedlight
 - VR

Film no./speed	
0009	100
0008	100
0007	400
0006	100
0005	400

Film data

0009		03Frame
250	F5.6	 +0.3
80mm		M
05/07/25		

Frame data
(basic recording mode)

0009		03Frame
250	F5.6	 +0.3
80mm		M  -0.6
AE-L FV-L TTL		
24-120/3.5-5.6		
05/07/25 21:09'		

Frame data
(detailed recording mode)

 **Data is recorded at first exposure in multiple exposure ( 138).**

■ Deleting shooting data

1 Turn the power switch on when no film loaded, press the MENU button to display menu and then display Shooting data menu in the SET-UP menu.

- See steps 1 and 2 on page 116 to display the Shooting data menu.
- Unload the film before deleting shooting data. Shooting data cannot be deleted when the film is loaded.

2 Select Delete all data.



- Press ▲▼ on multi-selector to select "Delete" and ► to set.



- Press ► to select "Delete all data". Confirm "Deleting all data" then press ► again to delete all the data. (Press ◀ to abort deleting data and return to Shooting data menu.)
- After all the data is deleted, the display returns to Shooting data menu.

3 Complete the procedure.

- Press ◀ to backtrack display by display, or press MENU button twice to return to the Shooting data display.

✍ When shooting data is copied onto a CF Memory card

When shooting data is copied onto a CompactFlash™ card using the optional Data Reader MV-1 (📷 166), data stored in the camera's memory is automatically deleted. (When film is loaded, shooting data of the loaded film is not copied and remains in the camera's memory.)

■ Memory full setting

Select operation when the number of film rolls that can be recorded in the camera's memory (📷 117) has been exceeded (overwrite shooting data without warning or warning is displayed and shutter is locked without overwriting).

1 Turn the power switch on while film is not loaded. Press the MENU button to display menu and select Shooting data menu in the SET-UP menu.

- See steps 1 and 2 on page 116 to display Shooting data menu.
- Unload the film before setting. Memory full setting cannot be selected when the film is loaded.
- "Memory full" cannot be set when any shooting data is stored in the camera's memory. Delete all shooting data (🗑️ 118) before setting.

2 Select Memory full setting.

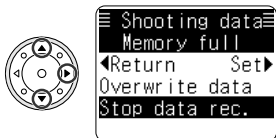
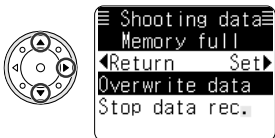

- Press ▲/▼ on multi-selector to select "Memory full" and ► to set.
- Press ▲/▼ to select "Overwrite data" or "Stop data rec." and ► to set. The Shooting data menu reappears.

3 Complete the procedure.

- Press ◀ to backtrack display by display, or press MENU button twice to return to the Shooting data display.

✍️ Memory full options

When the number of film rolls that can be recorded in the camera's memory has been exceeded:

Overwrite data (default setting)

- The oldest data is overwritten by new data
- No warning indication

Stop data rec.

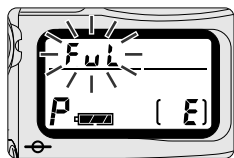

- The shutter locks and data recording stops
- Warning indication displayed

Warning indications for memory full setting



OUT OF MEMORY.
CANNOT RECORD
SHOOTING DATA.
TURN CAMERA OFF.

When “Stop data rec.” is set at the memory full setting and you reach the maximum number of film rolls that can be recorded in camera’s memory ( 117), illustrated warning indications appear and the shutter locks (indications disappear when exposure meter is off). Take one of the following measures:

- Turn the power switch off once and on again. The shutter lock is released and pictures can be taken but no shooting data is recorded.
- Delete all shooting data ( 118). The shutter lock is released and pictures can be taken, and new shooting data is recorded.
- The shutter lock is released and pictures can be taken when shooting data is copied onto a CompactFlash™ card using optional Data Reader MV-1 ( 166). Data in the camera’s memory is deleted and new shooting data will be recorded. (When film is loaded, shooting data of the loaded film is not copied and remains in the camera’s memory.)

■ Resetting ID number or film number

1 Turn the power switch on when no film loaded, press the MENU button to display menu and then display Shooting data menu in the SET-UP menu.

- See steps 1 and 2 on page 116 to display the Shooting data menu.
- Unload the film before resetting ID number or film number. The ID number and film number cannot be reset when the film is loaded.
- The ID number and film number cannot be set when shooting data is stored in camera's memory. Delete shooting data before setting (▶ 118).

2 Select Film number in the Shooting data menu.



- Press ▲/▼ on multi-selector to select "Film number" and press ▶.

3 Select ID number and film number.

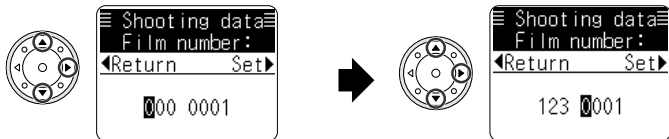

- Three-digit number at left is the ID number.
- Press ▲/▼ to select highlighted first digit and ▶ to set.
- Press ▲/▼ to select numbers for each digit.
- Press ▶ after setting the last digit. First number at right is highlighted.
- Four-digit number at right is the film number.
- Press ▲/▼ to select highlighted first digit and ▶ to set.
- Press ▲/▼ to select numbers for each digit.
- Press ▶ after setting the last digit to set ID number and film number. The display returns to Shooting data menu.

4 Complete the procedure.

- Press ◀ to backtrack display by display, or press MENU button twice to return to the Shooting data display.

Displaying shooting data

- 1** Turn the power switch on and press the INFO button to display film data.

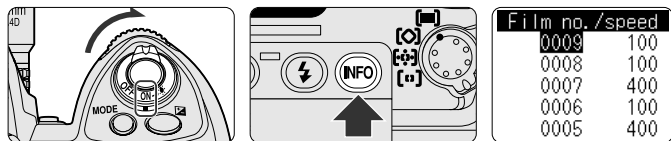

- Film data is displayed beginning with the most recent information.

- 2** Press the multi-selector to select film for which you want to display the frame data.

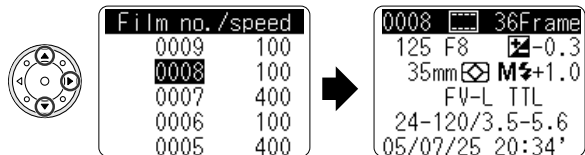

- Press \blacktriangle / \blacktriangledown to select film and \blacktriangleright to display the frame data of the film.
- Frame data is displayed beginning with the most recent information. Press \blacktriangleleft to return to film data and \blacktriangleright again to display most recently displayed frame data.
- Number of data displayed differs with the data recording mode.

- 3** Press the multi-selector to select frame data to be displayed.

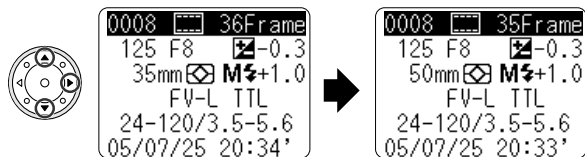

- Press \blacktriangle / \blacktriangledown to select frame data to be displayed.
- Press \blacktriangleleft / \blacktriangleright to return to the film data display.
- Press \blacktriangleleft to backtrack display by display, or press INFO button to return to the Shooting data display.

Details on shooting data display

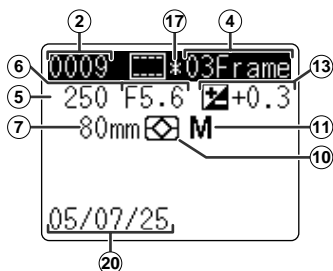

Basic display

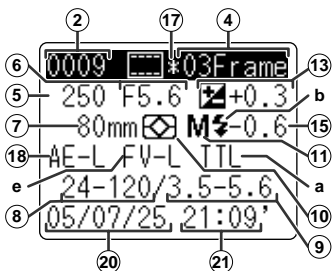

Detailed display

Display item	Example	
②	Film number	0009
④	Frame count number	3rd frame
⑤	Shutter speed	1/250 sec.
⑥	Aperture	f/5.6
⑦	Selected focal length	80mm
⑧	Lens focal length	24-120mm
⑨	Maximum aperture	f/3.5-5.6
⑩	Metering system	Matrix
⑪	Exposure mode	Manual

Display item	Example	
⑬	Exposure compensation value	+0.3
⑮	Flash exposure compensation value	-0.6
a	Flash mode (TTL)	TTL auto flash
b	Speedlight used/not used	used
e	FV Lock	used
⑰	Multiple exposure	executed
⑱	Auto Exposure lock	used
⑳	Date	2005, July 25
㉑	Time	21:09

• Displays other than numbers indicate:

- ⑩: (Matrix metering), (Center-Weighted metering), (Spot metering)
- ⑪: P (Programmed Auto), S (Shutter-Priority Auto), A (Aperture-Priority Auto), M (Manual)
- a: TTL (TTL [i-TTL] mode used), no display (flash mode other than TTL used)
- b: (Speedlight used), no display (Speedlight not used)
- e: FV-L (FV Lock used), no display (FV Lock not used)
- ⑰: (multiple exposure), no display (normal [single] exposure)
- ⑱: AE-L (Auto Exposure lock), no display (Auto Exposure lock not used)
- ⑳ Date is displayed in the order set at Setup menu, "Date display" (36).
- For details on recording data items, see pages 113 to 115.

Setup Menu [Recording Shooting Data]—continued

Copying shooting data to CompactFlash™ memory card

Data can be copied onto a CF memory card using optional Data Reader MV-1 ( 166). Copied data can then be transferred to a personal computer for further manipulation. For details, see the Data Reader MV-1 instruction manual.

- Data is copied onto a CF card in CSV (Comma Separated Value) format and can be used in software such as Microsoft® Excel.
- Optional PC Card Adapter EC-AD1 or a CF Data Reader is required to transfer data to a personal computer.

Example: application of shooting data

- Table of shooting data created using Microsoft® Excel.

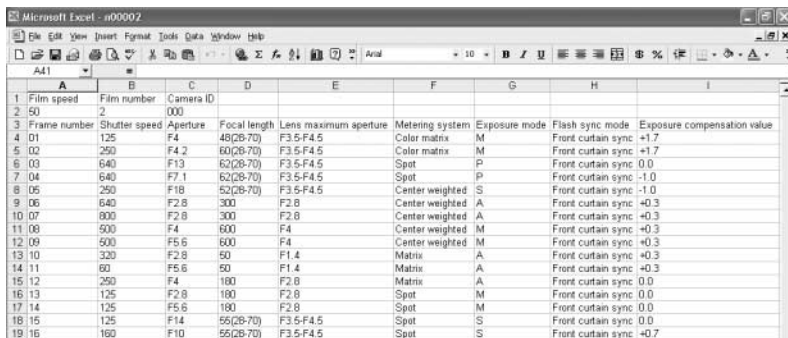

The screenshot shows a Microsoft Excel spreadsheet with the following data:

1	Film speed	Film number	Camera ID						
3	Frame number	Shutter speed	Aperture	Focal length	Lens maximum aperture	Metering system	Exposure mode	Flash sync mode	Exposure compensation value
2	50	2	000						
4	01	125	F4	48(28-70)	F3.5-F4.5	Color matrix	M	Front curtain sync	+1.7
5	02	250	F4.2	60(28-70)	F3.5-F4.5	Color matrix	M	Front curtain sync	+1.7
6	03	640	F13	62(28-70)	F3.5-F4.5	Spot	P	Front curtain sync	0.0
7	04	640	F7.1	62(28-70)	F3.5-F4.5	Spot	P	Front curtain sync	-1.0
8	05	250	F18	52(28-70)	F3.5-F4.5	Center weighted	S	Front curtain sync	-1.0
9	06	640	F2.8	300	F2.8	Center weighted	A	Front curtain sync	+0.3
10	07	800	F2.8	300	F2.8	Center weighted	A	Front curtain sync	+0.3
11	08	500	F4	600	F4	Center weighted	M	Front curtain sync	+0.3
12	09	500	F5.6	600	F4	Center weighted	M	Front curtain sync	+0.3
13	10	320	F2.8	50	F1.4	Matrix	A	Front curtain sync	+0.3
14	11	60	F5.6	50	F1.4	Matrix	A	Front curtain sync	+0.3
15	12	250	F4	180	F2.8	Matrix	A	Front curtain sync	0.0
16	13	125	F2.8	180	F2.8	Spot	M	Front curtain sync	0.0
17	14	125	F5.6	180	F2.8	Spot	M	Front curtain sync	0.0
18	15	125	F14	55(28-70)	F3.5-F4.5	Spot	S	Front curtain sync	0.0
19	16	160	F10	55(28-70)	F3.5-F4.5	Spot	S	Front curtain sync	+0.7

Shooting Menu

Setting data imprint, multiple exposure and interval timer.

■ Details on shooting menu options

Data imprint

 126

Shooting data can be imprinted within or between the frames or on frame number 0. For details, see page 126-137 "imprinting shooting data".

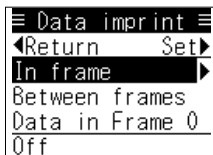

Options:

In frame: Data is imprinted within the frame

Between frames: Data is imprinted between frames

Frame 0: Data is imprinted at frame number 0

Mult. exposure

 138

Set number of shots in multiple exposure. For details, see page 138-139 "multiple exposure".



- Select and set the number of shots (2-10) in multiple exposure.

Interval timer

 140

Controls various interval timer settings. For details, see page 140-143 "interval timer".



- Set start day/time, interval, repeating time and the number of shots per operation.

Shooting Menu [Imprinting Shooting Data]

Shooting data can be imprinted within or between the frames or on one frame before the first frame (frame number 0).

■ Imprinting data in-frame

Date, date and time, a number of your choice, the frame count number or a sequential number can be imprinted in-frame.

■ Imprinted data

Date:

The year/month/day (month/day/year or day/month/year) of shooting is imprinted.

- If you change the display order to month/day/year or day/month/year in "Date" in SET UP menu ( 36), the date is imprinted in that order.

Date and time:

Day/hour/minute of the shooting is imprinted.

User Index No.:

Designated six-digit number is imprinted.



- The same user index number can be imprinted between frames ( 130)

Frame count number:

The frame counter number indicated in the top LCD panel and viewfinder during shooting is imprinted.

Sequential number:

A sequential six-digit number beginning from the number selected by the user ( 129) is imprinted when each shot is taken. The number is increased by one for each frame following the first frame. This is useful in confirming the total number of frames.

- The number returns to "00 00 00" after "99 99 99".
- The sequential number can also be imprinted between frames ( 130). The number continues to increase as long as the in-frame or between frames imprint is selected. The number does not change if the sequential number is not selected.
- The sequential number does not change when film is not loaded or when film is advanced to the first frame after loading.
- The sequential number does not reset when the camera back is opened for film change.
- In multiple exposure mode ( 138), the number only increases once, at the first exposure.

Position of imprinted data and example

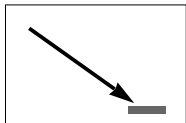

Imprinted data	Imprint example
Date*	'05 07 25
Date and time	25 15:30
User Index No.	03 12 02
Frame count	FC 28
Sequential No.	00 01 23

- The data is imprinted in the bottom-right corner of the frame as illustrated.
 - The imprinted image may be difficult to read against bright colors such as white or reddish hues.
 - The imprint example above shows the date and time (2005, July 25, 15:30); a fixed number (31202); a frame count number (28); and a sequential number (123).
- * If you change the display order in "Date" in the SET UP menu ( 35) to month/day/year, "7 25 '05" is imprinted. If you change the display order to day/month/year, "25 7 '05" is imprinted.

 For notes on imprinting shooting data, see page 136.

■ Setting imprinting data in-frame

- 1** Turn the power switch on and press the MENU button to display menu.

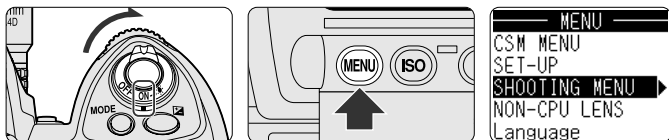

- 2** Display Data imprint menu in SHOOTING MENU.

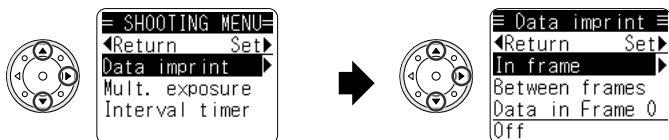

- Press ▲▼ on the multi-selector to select "SHOOTING MENU" and press ► to display the SHOOTING MENU.
- Press ▲▼ to select "Data imprint" and ► so the Data imprint menu is displayed.

- 3** Select In-frame imprint in the Data imprint menu.

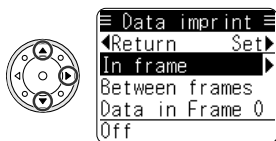

- Press ▲▼ to select "In frame" and ► to set.

- 4** Select data to be imprinted.

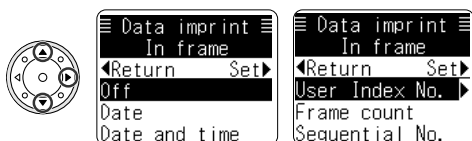

- Press ▲▼ to select "Date", "Day and time", "User Index No.", "Frame count" or "Sequential No." and ► to set.

- The display returns to the data imprint menu when date, day/hour/minute or frame count number is selected.
- The number setting display appears when user index number or sequential number is selected.

■ When a user index number is selected

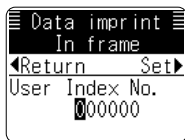

- Press ▲▼ to set highlighted first digit.
- Press ► to select the second to sixth digit, then ▲▼ to set each.
- The display returns to the imprint menu when ► is pressed after setting the sixth digit.
- "00 00 00" is imprinted when no number is selected.

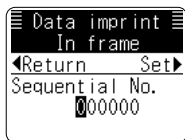

■ When a sequential number is selected:

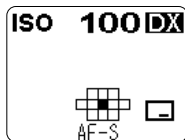

- Press ▲▼ to set highlighted first digit.
- Press ► to select the second to sixth digit, then ▲▼ to set each.
- The display returns to imprint menu when ► is pressed after setting the sixth digit.
- With each successive shot, the number increases by one, and that number is imprinted.
- "00 00 00" is imprinted when no number is selected.

5 Complete the operation.



- Press ◀ to backtrack display by display or press the MENU button twice to return to the shooting data display.
-  is displayed in the rear LCD panel when in-frame imprint is set, and  is displayed when both in-frame imprint and imprint between frames are set.

■ Imprinting data between frames

In addition to the date, date and time, user index number, frame count number or sequential number, which can also be imprinted in-frame, additional detailed shooting data can be imprinted between frames.

■ Imprinted data

Date, date and time, user index number, frame count number or sequential number:

See the in-frame imprinted data on page 126 for details.

Shutter speed:

The shutter speed displayed in the top and rear LCD panels (in detailed and large display) and viewfinder when pictures are taken is imprinted.

Aperture:

The aperture displayed in top and rear LCD panels (in detailed and large display) and viewfinder when pictures are taken is imprinted.

- When a non-CPU lens is attached and the lens' maximum aperture is not specified in "specifying lens data" (📷 144), the number of EV steps from maximum aperture (with the ▲ mark) is imprinted.

Exposure mode:

Location of imprinted "■" indicates the exposure mode.

- Programmed Auto: no indication
- Shutter-Priority Auto: indication at the shutter speed
- Aperture-Priority Auto: indication at the aperture
- Manual: indications at both shutter speed and aperture

Exposure compensation value:

Selected exposure compensation value (📷 74) is imprinted in Programmed Auto, Shutter-Priority Auto and Aperture-Priority Auto. In Manual exposure mode, under or over EV value from the correct exposure is imprinted (within ± 9.7 , if the value exceeds, -9.7 or $+9.7$ is imprinted).

- "0.0" is imprinted if no exposure compensation is set.
- "--" is imprinted in multiple exposure (📷 138).
- In Auto Exposure Bracketing (📷 75), added compensation value of the Bracketing is imprinted. See "Recorded/imprinted exposure compensation/flash exposure compensation value" on page 148 for details.

Flash exposure compensation (📷):

Flash exposure compensation value set in flash shooting is imprinted. (See the instruction manual of the Speedlight for the flash exposure compensaiton.)

- If no flash exposure compensation is set, "0.0" is imprinted.

- When exposure compensation (📷 74) or Auto Exposure Bracketing (📷 75) is performed in flash photography, flash output level is also compensated and recorded as flash exposure compensation value even when no flash exposure compensation is set. See “Recorded/imprinted exposure compensation/flash exposure compensation value” on page 148 for details.
- No data is imprinted if attached Speedlight is turned off.

Metering system:

The exposure metering system (📷 62) in use when pictures are taken is imprinted.

Focal length:

Selected focal length (lens' zoom position) when pictures are taken is imprinted.



- Zoom position is imprinted with a zoom lens. The lens' focal length is imprinted with a non-zoom lens.
- With non-CPU lens, if the lens data is set in “Specifying lens data” (📷 144), set data is imprinted (no data is imprinted when lens data is not specified).
- Effective aperture is imprinted when Teleconverter is attached (only with CPU lens). However, the focal length is not imprinted correctly when AF-S Teleconverter TC-17E II is used with AF-S 300mm f/2.8D ED or AF-S 400mm f/2.8D ED (focal length is imprinted correctly with AF-S 300mm f/2.8D II ED or AF-S 400mm f/2.8D II ED).

Time:

Time of shooting is imprinted.

imprinted shooting data

- Following combinations of shooting data can be imprinted.



Imprinted item	Imprinted data
+Date	Shutter speed, aperture, exposure mode, exposure compensation value, date
+Date and time	Shutter speed, aperture, exposure mode, exposure compensation value, date and time
+Use Index No.	Shutter speed, aperture, exposure mode, exposure compensation value, user index number
Frame count	Shutter speed, aperture, exposure mode, exposure compensation value, frame count number
Sequential No.	Shutter speed, aperture, exposure mode, exposure compensation value, sequential number
 +metering mode	Shutter speed, aperture, exposure mode, exposure compensation value, flash exposure compensation value, metering system
 +focal length	Shutter speed, aperture, exposure mode, exposure compensation value, flash exposure compensation value, focal length
 +time	Shutter speed, aperture, exposure mode, exposure compensation value, flash exposure compensation value, time
Date	Date
Date and time	Day/hour/minute
Use Index No.	User index number

Shooting Menu [Imprinting Shooting Data]—continued

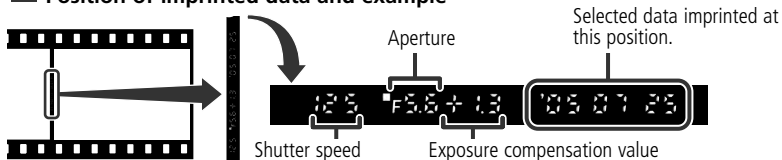
Position of imprinted data and example



- Data is imprinted at the left side of the frame as illustrated.
- The example shows: shutter speed (1/125 sec.); aperture (f/5.6); in Aperture-Priority Auto exposure mode*1; exposure compensation (+1.3); and date*2 (2005, July 25th.).
 - 1* "125 F5.6" in Programmed Auto, "125 F5.6" in Shutter-Priority Auto, "125 F5.6" in Aperture-Priority Auto and "125 F5.6" in Manual is imprinted.
 - 2* "7 25 '05" is imprinted when month/day year is selected, and "25 7 '05" is imprinted when day/month/year is selected in "Date display" in SET-UP menu (36).
- When data other than date is selected, the following data is imprinted (sample).

Imprinted data	Imprint example
Date and time (+ Date and time)	25 15:30
User Index No. (+ User Index No.)	03 12 02
Frame count	FC 28
Sequential No.	00 01 23
 + metering mode*3	-2.0 CW
 + focal length	-2.0 3 00
 + time	-2.0 15:30

- The imprint example above shows: the date and time (25th, 15:30); fixed number (31202); frame count number (28); sequential number (123); flash exposure compensation  (-2.0); metering system (Center-Weighted); focal length (300mm).
 - 3* "AmP" in Matrix metering or "SP" in Spot metering is imprinted.

 For notes on imprinting shooting data, see page 136.

■ Setting imprint data between frames

1 Turn the power switch on, press the MENU button to display menu, then display the Data imprint menu in SHOOTING MENU.

- For details on how to display Data imprint menu, see steps 1 and 2 on page 128.

2 Select Between frames imprint in the Data imprint menu.

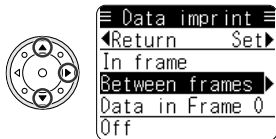

- Press ▲/▼ on the multi-selector to select "Between frames" and press ► to set.

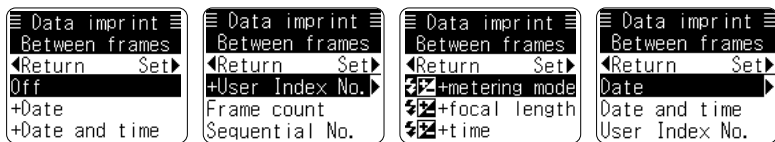

3 Select data to be imprinted.

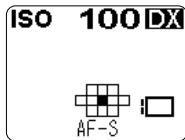

- Press ▲/▼ to select "+ Date", "+ Date and time", "+ User Index No.", "Frame count", "Sequential No.", "⚡ + metering mode", "⚡ + focal length", or "⚡ + time" and ► to set.
- When "+ Date", "+ Date and time", "Frame count", "⚡ + metering mode", "⚡ + focal length", or "⚡ + time" is set, the display returns to the Data imprint menu.
- When "+ User Index No." or "Sequential No." is set, the display for editing numbers appears. To edit the number, see step 4 on page 128.

4 Complete the operation.



- Press ◀ to backtrack display by display or press MENU button twice to return to the shooting data display.
-  is displayed in the rear LCD panel when between frames imprint is set, and  is displayed when both in-frame imprint and between frames imprint are set.

■ Imprinting data on frame number 0

When film is loaded, film is advanced three frames before stopping; data is imprinted on frame number 0 (the frame before the first frame), then the film is advanced to the first frame. ID number, film number and the date of film loading can be imprinted between frames, and the date and film number can be imprinted on frame number 0.

■ Imprinted data

ID number (camera ID):

ID number set in “Recording shooting data” (📷 121) is imprinted.

Film number:

Film number set in “Recording shooting data” (📷 121) is imprinted.

Date:

The year/month/day (month/day/year or day/month/year) of film loading is imprinted.

- If you change the display order to month/day/year or day/month/year in “Date” in the SET-UP menu (📷 36), date is imprinted in that order.

📝 Position of imprinted data and example

Between frames:

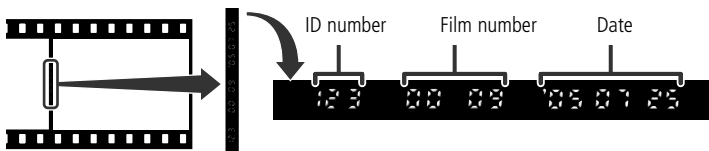

- Data is imprinted at the left side of frame number 0 as illustrated above.

In-frame:



Imprinted data	Imprint example
Date in-frame*	'05 07 25
Film number in-frame	00 09

- The data is imprinted at the bottom-right corner of frame number 0 as illustrated above.
- The imprint example above shows: the ID number (123); film number (0009); and date (2005, July 25th).

* If you change the display order to month/day/year in “Date” in the SET-UP menu (📷 124), “7 25 '05” is imprinted. If you change it to day/month/year, “25 7 '05” is imprinted.

📝 For notes on imprinting shooting data, see page 136.

■ Setting imprint data for frame number 0

1 Turn the power switch on, press the MENU button to display menu, then display the Data imprint menu in SHOOTING MENU.

- To display the Data imprint menu, see steps 1 and 2 in on page 128.

2 Select Data in frame 0 imprint from the Data imprint menu.

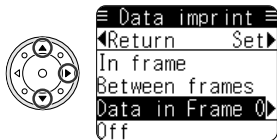

- Press ▲/▼ on the multi-selector to select "Data in Frame 0" and press ► to set.

3 Select data to be imprinted.

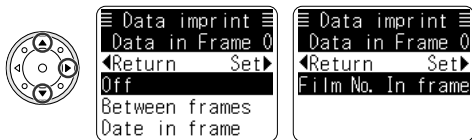

- Press ▲/▼ to select "Between frames", "Date in frame" or "Film No. In frame" and ► to set. The display returns to the data imprint menu.

4 Complete the operation.

- Press ◀ to backtrack display by display or press MENU button twice to return to the shooting data display.

✍ Notes on imprinting data on frame number 0

- Data is imprinted when the film is loaded. Even if no pictures are taken before film is unloaded, data is imprinted on the film.
- If the film is pulled out too far when loading film, frame number 0 is exposed and imprinted data may be unreadable.

Notes on imprinting data

Darkness of imprinted data

- Darkness of the imprinted data is automatically adjusted by the camera depending upon the sensitivity of the loaded film. However, imprinted data may appear darker or lighter depending on the type of film used even with the same film sensitivity since data is imprinted from the reverse side of the film. So make trial shots to check the darkness of the imprinted data and if it is not adequate, adjust the darkness in Custom Setting “d8: Imprint density” ( 103).
- Set the imprint density to +1 or +2 with a film such as Kodachrome 64, Kodachrome 200 or Fujichrome Velvia, that has low sensitivity from the reverse side.

Special purpose film

- Data cannot be imprinted on low-sensitivity films such as infrared film or reprocopy film.

Make sure to set the date/time before setting imprinted data (35).

Data imprint in multiple exposure

- In multiple exposure mode ( 138), data is imprinted at first exposure.
- Imprinted data may become difficult to read when many backgrounds or subjects are exposed in multiple exposure.



Using in-frame imprint in combination with between-frame imprint

- Some data cannot be imprinted when both in-frame and between-frame imprint are selected. If you cannot select your desired data or imprint is not possible, change the data imprint setting.

When in-frame imprint is selected beforehand:

- When in-frame imprint is set to date, date and time, user index number, frame count number or sequential number, the same data is imprinted between frames and different data cannot be selected. However, “+Date” for date, “+Date and time” for date and time and “+User Index No.” for user index number can be set.

When between-frame imprint is selected beforehand:

- When between-frame imprint is set to date, date and time, user index number, frame count number or sequential number, the same data is imprinted in-frame and different data cannot be selected.
- When “ + metering system”, “ + focal length” or “ + time” is selected for between-frame imprint, data cannot be imprinted in-frame.

Imprinting data at low temperatures

- Liquid crystal is used for imprinting data to the film. Because liquid crystal tends to become slower at low temperatures, note the following when imprinting data under 0°C or 32°F:

In-frame and between-frame imprint

- Release the shutter more than 2 sec. after power is turned on (or exposure meter is on) and before the exposure meter turns off. If the shutter is released before 2 sec., data may not be imprinted correctly.
- Wait for more than 2 sec. before taking next shot. Otherwise, the data for a given frame may be imprinted twice at the same location (or mistakenly printed to a second frame).

0-frame imprint

- Load film (advance the film to the first frame) more than 2 sec. after power is turned on (or exposure meter is on) and before the exposure meter turns off. If the film is advanced to the first frame before 2 sec., data may not be imprinted correctly.

Film advance speed in data imprint shooting

- When imprinted data other than date, date and time or user index number is selected, film advance speed tends to slow down even at normal temperatures if CL (continuous low-speed) or CH (continuous high-speed) film advance mode is selected.
 - To prevent the slowdown of the film advance speed, select either date, date and time or user index number only, or cancel data imprint.
 - Film advance speed depends on film sensitivity, temperature and imprint density (selected in Custom Setting "d8: Imprint density,  103); it slows down when low-sensitivity film is loaded, at low temperatures and darker imprint density is selected.
- Even when the date, date and time or user index number only is selected for imprinting data, film advance speed slows down if the film sensitivity is slower than ISO 160 or imprint density is set to "+2" in CH (continuous high-speed) shooting.

Processing film with between-frame imprint

- Film may be cut in film processing, including your imprint data (or even the photo image itself). To avoid this, make sure to have the entire film roll processed in one piece.

Shooting Menu [Multiple Exposure]

Multiple exposure consists of two or more exposures of one or more subjects in the same frame. Multiple exposure can be performed in any of the available exposure modes.

- 1 Turn the power switch on and press the MENU button so the Menu display appears on the rear LCD.

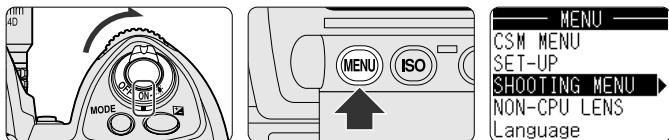

- 2 Select Multiple exposure display in the SHOOTING MENU.

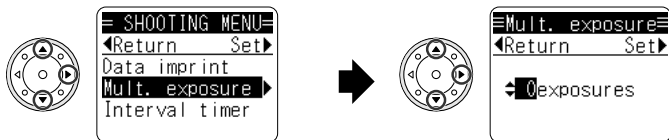



- Press ▲▼ on the multi-selector to select "SHOOTING MENU" and press ► so the SHOOTING MENU display appears.

- Press ▲▼ to select "Mult. exposure" and press ► so the Multiple exposure display appears.

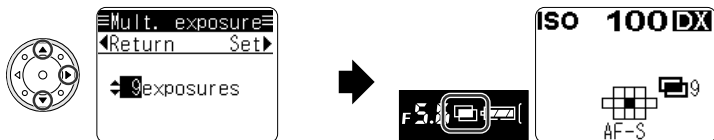
- 3 Select number of exposures.



- Press ▲▼ to select your desired number of exposures from 2 to 10, then press ► to set.

- When the multiple exposure is set,  appears in the viewfinder and  and the number of exposures in the rear LCD panel.

4 Compose picture, confirm focus indicator ● and shoot.

- If the film advance mode is set to S (single frame), the first shot will be taken when the shutter release button is fully depressed. The film does not advance but the Multiple exposure indication in the viewfinder blinks. Multiple exposures can then be taken from the second shutter release. After the selected number of exposures has been taken, the film automatically advances to the next frame.
- If film advance mode is set to CL (continuous low-speed), CH (continuous high-speed) or Cs (continuous silent-low-speed), selected numbers of exposures will be taken continuously as long as you keep the shutter release button fully depressed. The film then automatically advances to the next frame and multiple exposure is canceled.
- The film does not advance and the frame counter does not increase during multiple exposure operation.

■ Canceling multiple exposure

- Set the number of exposures to “0” at step 3, or perform Two-Button Reset (147). The film will advance to the next frame when the next shot is taken; film is not advanced if no shot is taken.
- Multiple exposure is canceled when film is rewind after setting or during multiple exposure. Multiple exposure is also canceled if the shutter release button is depressed after pressing the R1 button (the shutter curtain will not open and film will advance to the next frame).

Exposure compensation according to number of exposures

Depending on the number of exposures taken in multiple exposure, exposure compensation may be necessary since more than one image is exposed in the same frame.

- Standard compensation value:

Number of exposures	Compensation value
Two	-1.0 EV
Three	-1.5 EV
Four	-2.0 EV
Eight or Nine	-3.0 EV

- Test shooting is recommended since the actual compensation required varies according to the shooting situation.
 - If the background is completely dark and subjects do not overlap, no compensation is required for each shot.
-  In some cases, frames may shift slightly in multiple exposure. In particular, at the beginning and near the end of a film roll, film advance/rewind becomes unstable so multiple exposure is not recommended.

Shooting Menu [Interval Timer Photography]

The F6 is equipped to take photographs automatically at preset intervals.

Available options and range

Option	Range	
Start time/day	Day	- -, 1-31
	Hour	00-23
	Minute	00-59
Interval	Hour	00-99
	Minute	00-59
	Second	00-59
Repeating time	1-99	
Number of shots in one operation	1-36	

- When the start day is set to "- -", interval timer starts immediately after setting is complete (minute and second cannot be set).
- Start day can be set to a day during the current one-month period.

Example: If day 6 is set on January 7th, interval timer starts on February 6th.

If day 7, 15:00, is set on January 7th, 16:00, interval timer starts on February 7th, 15:00.

Example of interval timer photograph

- Start day/time: Day 17, 16:00
- Interval: 1 hour 30 minutes 00 second
- Repeating time: five
- Number of shots in one operation: 3 frames

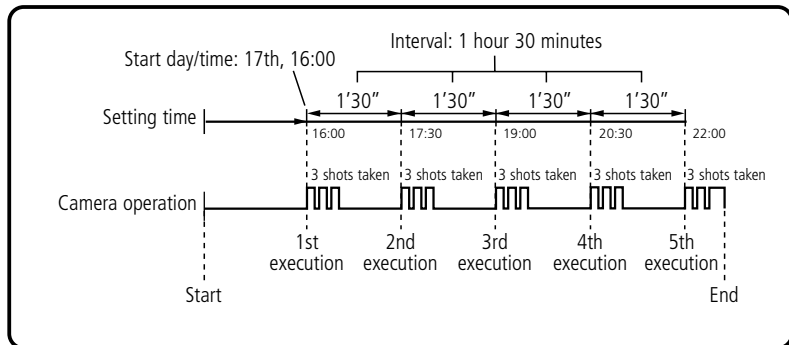

■ Setting interval timer

- 1 Turn the power switch on and press the MENU button so MENU is displayed in the rear LCD panel.

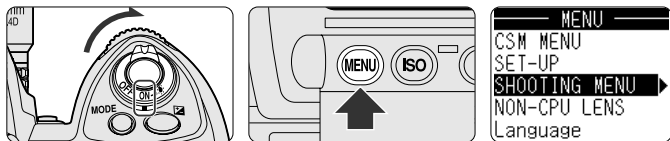

- Make sure to set date and time (☞ 35) before setting the interval timer.

- 2 Select Interval timer display in the SHOOTING MENU.

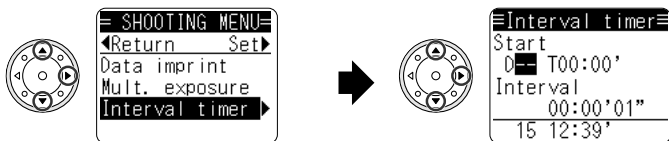

- Press ▲/▼ on the multi-selector to select "SHOOTING MENU" and press ► so the SHOOTING MENU appears.
- Press ▲/▼ to select "Interval timer" and press ► to set. Start time/Interval display is shown and the current time appears at the bottom.

- 3 Set start day/time and interval.

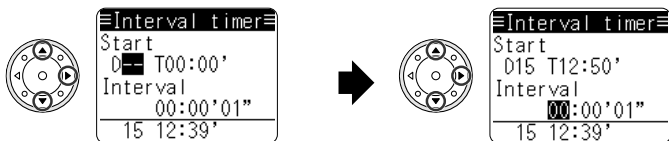

- Press ▲/▼ to select the highlighted start day and press ► to set.
- Press ▲/▼ to select highlighted minute/second and the ► to set.
- Press ▲/▼ to select the highlighted hour interval and press ► to set.
- Press ▲/▼ to select the highlighted minute/second and ► to set. Press ► to display repeating time and the number of shots in one operation.

4 Set repeating time and number of shots per operation.



- Press ▲▼ to select the highlighted repeating time and press ► to set.



- Press ▲▼ to select the highlighted number of shots per operation and press ► to set.

5 Start interval timer.



- Press ▲▼ to select "Start On" and press ► to start interval timer.
- Selecting "Start Off" does not start interval timer and display returns to the SHOOTING MENU.



- Setting is complete and interval timer starts. "Timer active." appears and the start day/time, (next shooting), repeating time and number of shots in one operation are displayed in the rear LCD panel.

6 Shots are taken.

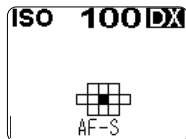



- Timer starts to count down 10 sec. before the first shot. The indicated number of shots counts down as each shot is taken. When one set of shots has been taken, the start time for the next shots and the remaining number of repeating time are displayed. The operation is repeated as many times as specified and interval timer is canceled when the entire operation is complete.
- Interval timer is canceled when the power is turned off, Two-Button reset (147) is performed or the interval timer setting is changed during interval timer operation.



Camera status/control during interval timer operation

- When the set interval is relatively long, the camera's exposure meter turns off. Camera's meter turns on 30 sec. before shots are taken. In autofocus operation, autofocus is activated 2 sec. before shots are taken.
- Rear LCD panel display changes to shooting data and camera's settings can be confirmed by pressing the INFO button.
- Normal shooting can be performed during interval timer photography. The interval timer remains active and the selected repeating time and number of shots per operation do not change.
- A set of shots will be canceled when focus cannot be achieved in Single Servo AF. However, the next (and successive) set of shots will be taken.
- Interval timer is canceled when the film is rewound during the interval timer.
- An interval can be set regardless of the set/controlled shutter speed. When the start time before the interval timer photography is reached during normal shooting, the current set of shots will be canceled but next (and successive) set of shots will be taken.
- When the shutter speed is set to **bulb**, the shutter speed is automatically controlled to 1/10 sec.

Combining interval timer with other functions

- In mirror up mode ( 84), each exposure starts approx. 0.4 sec. after the mirror is up.
- When two or more shots are selected for one operation in single frame shooting or mirror up mode, film advance mode automatically changes to CL (continuous low-speed).
- When combined with Auto Exposure Bracketing ( 75), the number of shots in one operation is automatically set to the number of shots selected in Bracketing. When Auto Exposure Bracketing is set during interval timer operation, the number of shots in one operation changes to the number of shots in Bracketing. (Number of shots returns to the number set in interval timer when Bracketing is canceled.)
- Interval timer can be used together with multiple exposure mode ( 138). For example, if the number of multiple exposure shots is set to three and the number of shots in one in interval timer operation is set to two, two multiple exposure shots will be taken in first set of shots (film is not advanced). The third shot will be taken as the first shot of the next set of shots. The film is then advanced, multiple exposure is canceled and the second shot is taken. Normal interval timer photography is executed thereafter.

Imprinting data in interval timer photography

- Set the interval time to 2 sec. or longer when data imprint ( 126, 130) is simultaneously set at temperature below 0°C (32°F). Also, data may not be imprinted properly when Bracketing ( 75) is simultaneously set at low temperatures.

Non-CPU Lens

By specifying lens data (lens focal length and maximum aperture), you can gain access to a variety of CPU lens functions when using a non-CPU lens.

Available functions

- If the focal length of the lens is known:
Automatic power zoom can be used with attached Speedlight
- When the maximum aperture of the lens is known:
The aperture value is displayed in the top LCD panel and viewfinder .
Auto Aperture flash can be used with attached Speedlights (📷 155).
- Specifying both the focal length and maximum aperture of the lens:
Enables Color Matrix Metering (📷 62).

Functions for improved accuracy

- Specifying both the focal length and maximum aperture of the lens improves accuracy in: Center-Weighted and Spot Metering (📷 63), i-TTL Balanced Fill-Flash* (📷 150), Multi-Sensor Balanced Fill-Flash* (📷 154).
* Set the metering system other than Spot.

Available focal length and aperture

- Focal lengths:
6, 8, 13, 15, 16, 18, 20, 24, 25, 28, 35, 43, 45, 50, 55, 58, 70, 80, 85, 86, 100, 105, 135, 180, 200, 300, 360, 400, 500, 600, 800, 1000, 1200, 1400, 1600, 2000, 2400, 2800, 3200, and 4000mm
- Apertures:
f/1.2, 1.4, 1.8, 2, 2.5, 2.8, 3.3, 3.5, 4, 4.5, 5, 5.6, 6.3, 7.1, 8, 9.5, 11, 13, 15, 16, 19, 22

📷 Available non-CPU lens

- Non-CPU lens data can be specified with AI Nikkor lenses. Non-AI lens does not function accurately even when the lens data are specified. To use non-AI lens, select a lens number in which no focus length and maximum aperture are specified.

📷 Available focal lengths and apertures

- If the corresponding focal length is not listed, choose the closest value greater than the actual focal length of the lens. If you are using a Speedlight in this condition, adjust the zoom head position manually.

📷 Zooming with zoom lenses

- Lens data are not adjusted when non-CPU lenses are zoomed in or out. After changing the zoom position, select new values for the lens focal length and maximum aperture.

■ Specifying lens data

- 1** Turn the power switch on and press the MENU button so the Menu display appears on the rear LCD.

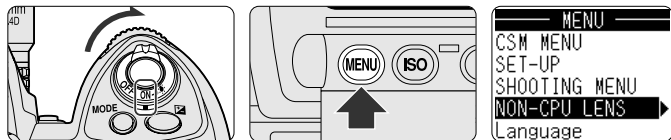

- 2** Select the Non-CPU lens data display.

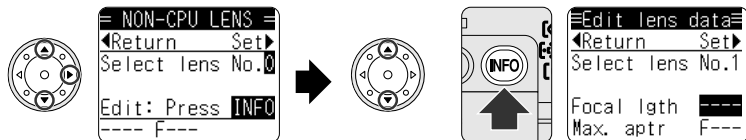

- Press ▲▼ on the multi-selector to select “Non-CPU lens data” and press ► so the Non-CPU lens data display appears.
- Up to 10 lens data can be set. Press ▲▼ to select number (0-9) and press INFO button so the Edit lens data display appears. (Press ► without pressing INFO button to set lens number and return to the Menu display.)

- 3** Specify non-CPU lens data.

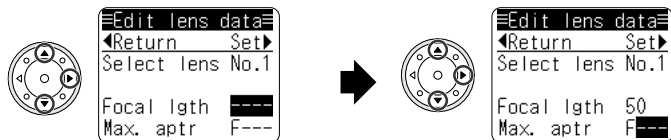

- Press ▲▼ to set focal length. Press ► to highlight “Max. aperture”.
- Press ▲▼ to set maximum aperture. Press ► to enter the lens data to selected lens number and return to the Menu display.

- 4** Complete the operation.

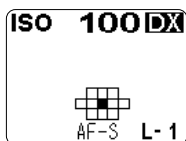

- Press ◀ to backtrack display by display or press MENU button twice to return to the shooting data display.
- With lens number 1, the selected lens number is displayed as “L-1” in the rear LCD panel. No number is displayed when a CPU lens is attached and when either focal length or maximum aperture is not specified with non-CPU lens.

Non-CPU Lens—continued

■ Selecting lens number with button and dial operation

Lens number (combination of focal length and maximum aperture) set at the “Specifying lens data” can be selected using the FUNC button and Main-Command Dial (without menu operation).

- 1 Set “FV Lock” and “Lens data” in the “f3 FUNC. Button” (👁 108).

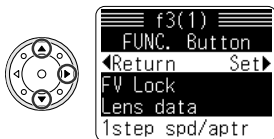

- Select “FV Lock” and “Lens data” in the “f3FUNC. Button” referring to “Operation in Menu” on page 88.
- “Lens data” cannot be selected alone; “FV Lock” is also selected.

- 2 Press the FUNC. button and rotate the Main-Command Dial to select lens number (0-9).

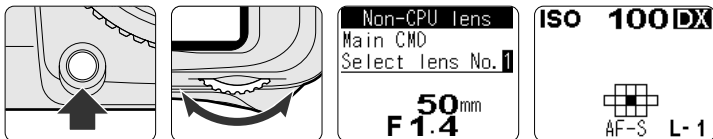

- The lens data display appears when the FUNC. button is pressed. Check the focal length and maximum aperture and select your desired lens number.
- With lens number 1, the selected lens number is displayed as “L-1” in the rear LCD panel. No number is displayed when a CPU lens is attached and when either focal length or maximum aperture is not specified with non-CPU lens.
- If an SB-800 or 600 Speedlight is mounted on the camera, turn the Speedlight off before pressing the FUNC. button (since the FV Lock [👁 151] has priority over the Lens data).

Two-Button Reset

Two-Button Reset allows you to instantly reset specified settings to their original default settings.

Press and hold down the MENU and INFO buttons for more than two seconds. "Reset completed." is displayed in the rear LCD panel.

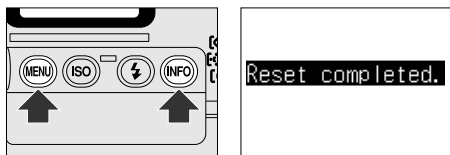

- Two-Button Reset is complete when normal shooting data is displayed after "Reset completed." on the rear LCD panel.

Option	Default
Exposure mode	Programmed Auto
Flexible program	Off
Focus area	Center (center group in Group Dynamic AF)
Flash sync mode	Front-Curtain sync
Exposure compensation	Off
Auto Exposure Bracketing	Off*1
Auto Exposure lock	Off
Shutter speed lock	Off
Aperture lock	Off
Data imprint	Off
Multiple exposure	Off
Interval timer	Off*2

*1 Settings reset to default; compensated EV value: 1/3 step, number of shots: 0. If "Preset select" is set in Custom Setting "e8: Auto BKT select", compensated EV value: 1/3 step, number of shots: three, and off will set.

*2 Settings reset to default; start time: --, interval: 1 sec., repeating time: 1, number of shots in one operation: 1

Options set in each Custom Setting menu, setup menu, lens data and language remain unchanged.

- Custom Settings for the current Custom Settings bank can be restored to default values by selecting "Yes" for Custom Setting R (Menu Reset) ( 92).

Recorded/imprinted exposure compensation/ flash exposure compensation value

Recorded (📷 114) or imprinted (📷 130) exposure compensation value and flash exposure compensation value are as follows depending on the combination of executed operations.

A: Value set in exposure compensation (on camera)

B: Value set in flash exposure compensation (on Speedlight)

C: Value set in Auto Exposure Bracketing (on camera)

SB compensation: Flash exposure compensation

AE Bracketing: Auto Exposure Bracketing

SB Bracketing: Flash Exposure Bracketing

Combination of compensation	Exposure compensation value*1	Flash exposure compensation value*2
No compensation	0*3	0*3
Exposure compensation	A	A
SB compensation	0*3	B
AE/SB Bracketing	C	C
AE Bracketing	C	0*3
SB Bracketing	0*3	C
Exposure compensation + SB compensation	A	A+B
Exposure compensation + AE/SB Bracketing	A+C	A+C
Exposure compensation + AE Bracketing	A+C	A
Exposure compensation + SB Bracketing	A	A+C
Exposure compensation + SB compensation + AE/SB Bracketing	A+C	A+B+C
Exposure compensation + SB compensation + AE Bracketing	A+C	A+B
Exposure compensation + SB compensation + SB Bracketing	A	A+B+C

- When Custom Setting “e6: M mode bkting” (📷 106) is set to “Flash” in Manual exposure mode and Auto Exposure Bracketing (📷 75) is performed, recorded/imprinted exposure compensation/flash exposure compensation are as follows.

Combination of compensation	Exposure compensation value*1	Flash exposure compensation value*2
AE/SB Bracketing	0*3	C
AE Bracketing	0*3	0*3
SB Bracketing	0*3	C
Exposure compensation + AE/SB Bracketing	A	A+C
Exposure compensation + AE Bracketing	A	A
Exposure compensation + SB Bracketing	A	A+C
Exposure compensation + SB compensation + AE/SB Bracketing	A	A+B+C
Exposure compensation + SB compensation + AE Bracketing	A	A+B
Exposure compensation + SB compensation + SB Bracketing	A	A+B+C

*1 When the exposure compensation value is imprinted in Manual exposure mode, over or under EV value from the correct exposure is imprinted.

*2 When Speedlight power is off, “0” is recorded but no data is imprinted.

*3 “0.0” is imprinted (instead of “0”).

Flash Photography

When used with an optional Speedlight featuring the Nikon Creative Lighting System (CLS), the F6 supports a full range of available options.

Creative Lighting System

The F6 supports flash photography when an optional Speedlight is mounted on the camera's accessory shoe. A flash can be used not only when natural lighting is inadequate, but also to fill in shadows, illuminate backlit subjects, and even to add a catchlight to the eyes of a portrait subject.

The Creative Lighting System

When used with an SB-800 or SB-600 Speedlight (available separately), the F6 supports the full range of options available with the Nikon Creative Lighting System (CLS), including i-TTL flash control, FV Lock, Auto FP High-Speed Sync, and AF-assist illumination for multi-area autofocus. When used with multiple SB-800/SB-600 flash units, the F6 also supports Advanced Wireless Lighting.

■ i-TTL Flash Control

When used with the F6 and set to TTL, the SB-800/SB-600 automatically uses one of the following types of i-TTL flash control:

i-TTL Balanced Fill-Flash

The Speedlight emits a series of nearly invisible preflashes (monitor preflashes) immediately before the main flash. Preflashes reflected from objects in all areas of the frame are picked up by the five-segment TTL flash control sensor or 1,005-pixel RGB sensor and are analyzed in combination with information from the Matrix Metering system to adjust flash output for natural balance between the main subject and ambient background lighting. When a type G or D lens is used, distance information is included when calculating flash output. Precision of calculation can be increased for non-CPU lenses by providing lens data (focal length and maximum aperture;  144). Select a metering system on the F6 other than Spot Metering. (With Spot Metering, the Flash mode automatically switches to Standard TTL flash.)

Standard TTL Flash

Flash output is adjusted to ensure the main subject is correctly exposed; background brightness is not taken into account. Recommended for shots in which the main subject is emphasized at the expense of background details, or when exposure compensation is used. Standard TTL flash is activated automatically when Spot metering is selected.

Monitor Preflash will not normally operate in Standard TTL flash; it does, however, operate in Auto FP High-Speed Sync or FV Lock (Standard i-TTL flash).

Flash may not fire when the background is extremely bright.

■ Advanced Wireless Lighting

Multiple SB-800/SB-600 flash units can be used to eliminate shadows for a natural lighting effect or to light other areas of the frame, away from the main subject.

Supported flash modes include i-TTL flash control, AA (Auto Aperture) and manual operation. A master Speedlight, mounted on the camera or connected using an SC-29 TTL Remote Cord, can control up to three groups (A, B, C) of remotely positioned Speedlights using wireless operation. The master Speedlight must be a Nikon SB-800, while remote units can include SB-800/SB-600. Using multiple Speedlights enables creative lighting; it is possible to turn off the illumination from the master Speedlight and enable it to control all of the remote units, or you can allow the main Speedlight to add to the lighting arrangement. See Speedlight instruction manual for details.

Modeling flash

SB-800/SB-600 Speedlights emit a modeling flash when the camera depth-of-field preview button is pressed. This feature can be used with Advanced Wireless Lighting to preview the total lighting effect achieved with multiple flash units. Modeling flash can be turned off using Custom Setting “e4: Modeling flash” (👁️ 105).

■ FV Lock

This feature is used to lock flash output, allowing photographs to be recomposed without changing the flash level.

This ensures that flash output is appropriate to the subject even when the subject is not positioned in the center of the frame. Flash output is adjusted automatically for any changes in sensitivity (ISO equivalency), aperture, and Speedlight zoom head position. FV Lock is available with i-TTL and Auto Aperture flash control, Advanced Wireless Lighting, and Auto FP High-Speed Sync. For using FV Lock, see the next page.

Creative Lighting System—continued

■ To use FV Lock:

- 1 Select “FV Lock” or “FV Lock/Lens data” for Custom Setting “f3: FUNC. button” ( 108).
- 2 Mount an SB-800/SB-600 Speedlight on the camera accessory shoe, then turn the Speedlight on and set the flash mode to TTL or AA (SB-800 only) (for details, see the Speedlight’s instruction manual).
 - Non-TTL Auto flash can be set with a master Speedlight that features Advanced Wireless Lighting.
- 3 Position the subject in the center of the frame and lightly press the shutter-release button to focus.

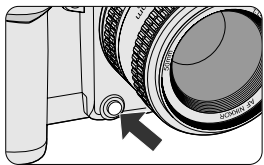

- 4 Press the FUNC. button.
 - The Speedlight will emit a monitor preflash to determine the appropriate flash level.
 - Flash output will be locked at this level and FV Lock icons  will appear in the viewfinder.

- 5 Recompose and fully depress the shutter-release button to shoot.
 - If desired, additional pictures can be taken without releasing FV Lock.
 - To release FV Lock, press the FUNC. button and confirm that the FV Lock icons  are no longer displayed in the viewfinder. FV Lock is also released when:
 - Exposure meter is off
 - Film rewind is performed
 - Lens is detached
 - Speedlight is turned off
 - Flash mode other than i-TTL is selected
 - Flash zoom position is changed
 - Modeling flash is set on Speedlight
 - Metering system is changed (except between Matrix and Center-Weighted metering)
 - Option other than “FV Lock” or “FV Lock, Lens data” is selected in “f3: FUNC. button” in Custom Setting.

Exposure area in FV Lock

Shooting situation	Flash mode	Exposure area
Single Speedlight	i-TTL mode	6mm-dia. at center
	Auto Aperture flash	Exposure area measured by the Speedlight
Multiple flash with Advanced Wireless Lighting	i-TTL mode	Entire frame
	Auto Aperture flash	Exposure area measured by the Speedlight
	Non-TTL Auto flash (Master Speedlight)	

■ Auto FP High-Speed Sync

Auto FP High-Speed Sync is activated automatically at shutter speeds faster than 1/250 sec., allowing auto flash control at all shutter speeds up to and including 1/8,000 sec. As a result, the flash can be used without concern for maximum sync speed, even in daylight shots taken at maximum aperture.

To use Auto FP High-Speed Sync, choose "1/250 (FP auto)" for Custom Setting "e1: Flash sync speed" ( 104). Auto FP High-Speed Sync supports Advanced Wireless Lighting. With a single Speedlight, i-TTL flash control, Auto Aperture flash, Distance-Priority manual, and manual flash mode are available. In multiple flash, you can choose from i-TTL flash control, Auto Aperture flash, Non-TTL Auto flash, and manual flash mode.

■ AF-Assist for Multi-Area AF

The SB-800/SB-600 features AF-assist illuminator linked to the F6 focus areas, allowing autofocus to be used even at night, regardless of the subject's position in the frame.

AF-assist illuminator can be used in all AF Area modes, including Single Area AF, Dynamic AF, Group Dynamic AF, and Dynamic AF with Closest-Subject Priority. If the subject is poorly lit, the AF-assist illuminator will light automatically when Single Servo AF is used in combination with a 24-105mm AF Nikkor lens (if a lens wider than 35mm is used, the illuminator may not light if the focus area at the left or right edge of the frame are selected).

Non-CLS supporting Speedlight

■ Available flash mode with non-CLS supporting Speedlight

When a Nikon Speedlight other than SB-800/SB-600 is attached and set to TTL mode, the following TTL Auto Flash modes are available depending on the type of lens used.

Multi-Sensor Balanced Fill-Flash/3D Multi-Sensor Balanced Fill-Flash (Automatic Balanced Fill-Flash with TTL Multi Sensor)

Automatic Balanced Fill-Flash with TTL Multi Sensor can be performed with a combination of F6 camera, CPU lens and Nikon TTL AF Speedlight. In this flash mode, just after you press the shutter release button and before the shutter is activated, the Speedlight with Monitor Preflash function (SB-80DX, SB-50DX, SB-28/28DX, SB-27, SB-26 and SB-25) will fire a series of imperceptible preflashes that are detected by the F6's five-segment TTL Multi Sensor, then analyzed for brightness and contrast. Furthermore, when a D- or G-type AF Nikkor lens is attached, it integrates Distance Information from the lens with other exposure control information, automatically compensating the flash output level so that flash output and ambient light are balanced (3D Multi-Sensor Balanced Fill-Flash).

With Speedlights that do not have the Monitor Preflash feature, or with a non-G/D-type lens or a non-CPU lens with non-CPU lens data specified, Multi-Sensor Balanced Fill-Flash (without data from the Monitor Preflash and Distance Information) is performed. Select a metering system on the F6 other than Spot Metering. (With Spot Metering, the Flash mode automatically switches to Standard TTL flash.)

Standard TTL Flash

Can be set on SB-80DX, SB-50DX, SB-28/28DX, SB-27, SB-26, SB-25 or SB-24 Speedlight. With other Speedlights, Standard TTL Flash is set automatically when the camera is set to Manual exposure mode. In Standard TTL Flash, flash output is adjusted to ensure the main subject is correctly exposed; background brightness is not taken into account. Recommended for shots in which the main subject is emphasized at the expense of background details, or when exposure compensation is used. Standard TTL flash is activated automatically when Spot metering is selected.

Non-TTL flash modes

In addition to TTL, flash modes such as Non-TTL Auto flash and manual flash are available. Flash mode availability depends on the type of Speedlight used; for details, see the instruction manual of the Speedlight.

■ Auto Aperture Flash (AA)

The Speedlight's built-in sensor measures the flash illumination reflected from the subject and controls flash output in combination with data automatically transmitted from the camera and lens to the Speedlight, including ISO sensitivity and exposure compensation values, and lens' aperture and focal length.

- With the SB-80DX or SB-28DX, set Custom Setting "e3: AA flash mode" to "On" (📷 105). With the SB-800, the Speedlight setting overrides the Custom Setting.

■ Non-TTL Auto flash (A)

The Speedlight's built-in sensor measures flash illumination reflected from the subject, automatically controlling the Speedlight's light output to provide correct exposure. This enables you to make exposure compensation (📷 74) easily by varying the aperture set on the camera or lens.

- With the SB-80DX or SB-28DX, set Custom Setting "e3: AA flash mode" to "Off" (📷 105). With the SB-800, the Speedlight setting overrides the Custom Setting.
- Aperture must be set manually on the Speedlight.

■ Distance-Priority Manual flash (GN)

In this flash operation, the Speedlight controls the light output automatically based on the shooting distance, aperture value and ISO sensitivity. Enter the shooting distance and you can take pictures having the same exposure even when shooting at different apertures.

■ Manual flash (M)

In Manual flash photography, you select the aperture and flash output level. This allows you to control the exposure and flash shooting distance when shooting subjects where the correct exposure is difficult to obtain in TTL or Non-TTL Auto flash mode. The flash output level can be set from M1/1 (full output) to M1/128 to suit your creative preferences. (Usable flash output level depends on the Speedlight.)

■ Repeating flash (RPT)

In Repeating flash operation, the Speedlight fires repeatedly during a single exposure, creating stroboscopic multi-exposure effects. This feature is useful when shooting fast-moving subjects.

- Manually set the flash output level, frequency (Hz), and number of repeating flashes per frame.

Accessory shoe/Sync terminal/Ready-light

■ Accessory shoe

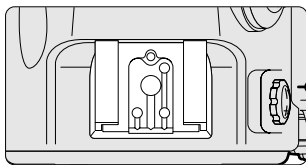

- An optional Speedlight such as the SB-800, SB-600, SB-80DX, SB-50DX, SB-30, SB-29s/29, SB-28/28DX, SB-27, SB-26, SB-25, SB-24, SB-23 or SB-22s can be attached directly to the accessory shoe of the F6 without a cord. This accessory shoe is equipped with a safety lock that prevents accidental drop when a Speedlight having a safety-lock pin (SB-800, SB-600, SB-80DX, SB-30, SB-29s/29, SB-28/28DX, SB-27, SB-26, SB-25 or SB-22s) is attached.

■ Sync terminal

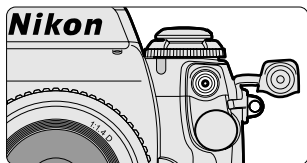

- To use a Speedlight that requires a sync cord, attach one end of the sync cord to the sync terminal.
When performing rear-curtain sync with a Speedlight such as SB-800, SB-600, SB-80DX, SB-50DX, SB-28/28DX, SB-27, SB-26, SB-25 or SB-24 attached to the F6's accessory shoe, do not attach a additional Speedlight via the sync terminal.

■ Ready-light



- When using a Speedlight such as the SB-800, SB-600, SB-80DX, SB-50DX, SB-30, SB-29s/29, SB-28/28DX, SB-27, SB-26, SB-25, SB-24, SB-23 or SB-22s, the ready-light  lights up when the Speedlight is fully charged and ready to fire.
- If the ready-light blinks approx. 3 sec. after full flash output (when the Speedlight is set to TTL, Auto Aperture flash or Non-TTL Auto flash mode), underexposure may have occurred. Check the focus distance, aperture or flash shooting distance range and shoot again.

Flash sync mode

■ Setting flash sync mode

Set flash sync mode by rotating the Main-Command Dial while pressing the flash sync mode button.

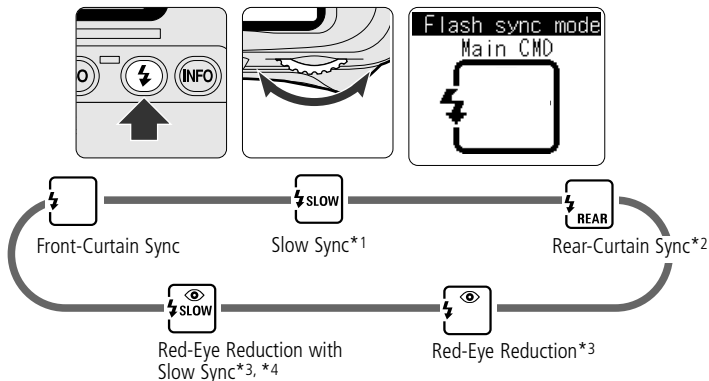

*1 Front-Curtain Sync is selected automatically in Shutter-Priority Auto or Manual exposure mode

*2 Slow Sync is set simultaneously in Programmed Auto or Aperture-Priority Auto exposure mode. Rear-Curtain Sync with Slow Sync is indicated as below in the rear LCD panel.

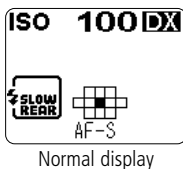

*3 Flash sync mode indication is reversed if attached Speedlight is not compatible with Red-Eye Reduction mode.

*4 Red-Eye Reduction is selected automatically in Shutter-Priority Auto or Manual exposure mode

✍ Studio flash system

• Rear-Curtain Sync cannot be used with a studio flash system since the correct synchronization cannot be obtained.

Flash sync mode—continued

Front-Curtain Sync

Set the flash sync mode to Front-Curtain Sync for normal flash photography. (With the SB-26, SB-25 or SB-24, set the Speedlight's sync mode selector to NORMAL.)

Slow Sync

In most Programmed Auto or Aperture-Priority Auto exposure mode flash photography shooting situations, the camera's shutter speed is automatically set to 1/60 to 1/250 sec. (1/60-1/8,000 sec. in Auto FP High-Speed Sync). However, for shooting nighttime scenes, Slow Sync uses a slower shutter speed (down to 30 sec.) to bring out background details using all of the available light.

Rear-Curtain Sync

The Speedlight fires at the end of the exposure, turning available light into a stream of light that follows the flash-illuminated moving subject. (With the SB-26, 25 or 24, set the Speedlight's sync mode selector to REAR.) When Rear-Curtain Sync is set in Programmed Auto or Aperture-Priority Auto exposure mode, Slow Sync is set automatically.

Red-Eye Reduction

The Monitor Preflash or Red-Eye Reduction lamp lights before the flash fires in order to reduce the red-eye effect in photos of people or animals. (With SB-800, SB-600, SB-80DX, SB-28/28DX, SB-27, SB-26 or SB-25 only.)

Red-Eye Reduction with Slow Sync

Red-Eye Reduction and Slow Sync mode are set simultaneously (the SB-800, SB-600, SB-80DX, SB-28/28DX, SB-27, SB-26 or SB-25). Set the exposure mode to Programmed Auto or Aperture-Priority Auto.

Flash Sync Modes

- When Red-Eye Reduction or Red-Eye Reduction with Slow Sync is selected, the Monitor Preflash or Red-Eye Reduction lamp lights before the flash fires. Do not move the camera or allow the subject to move until the shutter is released. (Red-Eye Reduction is not recommended in shooting situations where shutter release is your top priority.)
- With Slow Sync and Red-Eye Reduction with Slow Sync, keep the camera steady to prevent picture blur since the shutter speed is slow. Use of a tripod is recommended.

Usable optional Speedlights

Usable optional Speedlights

The following optional Speedlights are compatible with the F6.

In the lens row, ①, ② and ③ indicate:

①: G- or D-type Nikkor (except DX- or IX-Nikkor)

②: An AF Nikkor lens other than G/D-type or a non-CPU lens with "Non-CPU lens data" specified (☒ 144)

③: Non-CPU lens

■ Speedlights compatible with the Creative Lighting System

Speedlight	SB-800 (Attached to camera)			SB-800 (As remote unit)*1			SB-600 (Attached to camera)			SB-600 (As remote unit)*1		
	①	②	③	①	②	③	①	②	③	①	②	③
i-TTL Balanced Fill-Flash*2.	○	○	○	○	○	○	○	○	○	○	○	○
Standard TTL*3	○	○	○				○	○	○			
Auto Aperture flash	○	○		○	○							
Non-TTL Auto flash	○	○	○			○						
Distance-Priority manual	○	○	○									
Manual	○	○	○	○	○	○	○	○	○	○	○	○
Auto FP High-Speed Sync	○	○	○	○	○	○	○	○	○	○	○	○
FV Lock	○	○	○	○	○	○	○	○	○	○	○	○
Wide-Area AF-Assist Illuminator	○	○*4					○	○*4				
Repeating flash	○	○	○	○	○	○				○	○	○
Rear-Curtain Sync	○	○	○	○	○	○	○	○	○	○	○	○
Red-Eye Reduction	○	○	○				○	○	○			

*1 In Advanced Wireless Lighting.



*2 Set metering system other than Spot metering.

*3 Standard TTL flash is activated automatically when Spot metering is selected.

*4 Available only with an AF lens.

Usable optional Speedlights—continued

Speedlights that are compatible with F6 for flash operation other than the Creative Lighting System

Speedlight	Lens	TTL			A	M			REAR	
		3D Multi-Sensor Balanced Fill-Flash	Multi-Sensor Balanced Fill-Flash	Standard TTL*1	Non-TTL Auto*2	Manual	FP High-Speed Sync	Repeating Flash	Rear-Curtain Sync	Red-Eye Reduction
SB-80DX,	①	○		○	○	○	○	○	○	○
SB-28/28DX	②③		○	○	○	○	○	○	○	○
SB-50DX	①	○		○		○			○	
	②③		○	○		○			○	
SB-27	①	○		○	○	○			○	○
	②③		○	○	○	○			○	○
SB-26*3	①	○		○	○	○	○	○	○	○
	②③		○	○	○	○	○	○	○	○
SB-25	①	○		○	○	○	○	○	○	○
	②③		○	○	○	○	○	○	○	○
SB-24	①②③		○	○	○	○		○	○	
SB-29s/29*4, SB-23, SB-21B	①②③		○	○		○			○	
SB-30, SB-22s, SB-22, SB-20, SB-16B, SB-15	①②③		○	○	○	○			○	
SB-11*5, SB-14*5, SB-140*5,*6	①②③		○	○	○	○			○	

- *1 Standard TTL flash is activated automatically when Spot metering is selected. Setting exposure to Manual automatically changes the flash mode to Standard TTL with Speedlights other than SB-80DX, 50DX, 28/28DX, 27, 26, 25 and 24 that are equipped with TTL Auto Flash.
- *2 Auto Aperture flash is available with SB-80DX/28DX and lenses ① or ②. Set Custom Setting "e3: AA flash mode" ( 105) to "On".
- *3 Shutter speed is automatically controlled to slower than 1/200 sec. when the Wireless Slave Flash selector is set to D.
- *4 With the SB-29s/29 and SB-21B, autofocus can be used only when an AF Micro-Nikkor (60mm, 105mm, 200mm and 70-180mm) is attached.
- *5 TTL auto flash is possible with TTL Remote Cord SC-23. In A or M flash mode, attach SU-2 to SC-13 with SB-11 and SB-14 or attach SU-3 to SC-13 with SB-140. SC-11 or SC-15 can also be used; however, the ready-light does not appear in the viewfinder and the shutter speed does not change automatically.
- *6 Ultraviolet and infrared photography can be performed only when SB-140 is set to M.

✓ Flash units made by manufacturers other than Nikon

Use only Nikon Speedlights. Other units may damage the camera's electrical circuit due to incompatible voltage requirements (not compatible with 250V or higher), electric contact alignment or switch phase.

✎ Notes on using the optional Speedlight

- See your Speedlight manual for details.
 - If the camera groups are defined in the Speedlight manual under CLS, see that section for camera groups compatible with CLS.
 - If the camera groups are defined in the non-CLS supporting Speedlight manual under TTL auto flash, see that section for camera group I.
- With the SB-26, 25 or 24, flash sync mode set on the Speedlight overrides the setting on the camera body. However with the SB-26, Red-Eye Reduction or Red-Eye Reduction with Slow Sync setting on the camera overrides Speedlight setting.
- The flash sync speed is 1/250 sec. or slower when using an optional Speedlight. (With Medical-Nikkor 120mm f/4, set the shutter speed to 1/125 sec. or slower.)
- Available film speeds for TTL auto flash are ISO 25 to ISO 1000.
- For Speedlights not compatible with the Wide-Area AF-Assist Illuminator, the AF-Assist Illuminator does not emit light under the following conditions:
 - Center focus area is not selected in Single Area AF or Dynamic AF mode.
 - A group of focus areas that does not include the center focus area is selected in Group Dynamic AF mode
- In Programmed Auto exposure mode, the camera automatically controls the maximum available aperture in relation to the film speed as follows:

ISO film speed	25	50	100	200	400	800	1000
Maximum available aperture	2.8	3.3	4	4.8	5.6	6.7	7.1

- * When film speed increases by one step, the maximum available aperture is stopped down by 1/2 f/stop. If you are using a lens with a maximum aperture smaller than that listed above, the automatically controlled aperture range is from the lens' maximum to minimum aperture.
- When flash exposure compensation is set,  appears in the viewfinder without the compensation value.

Using Speedlight

Operations described in this section apply when the SB-800 or SB-600 Speedlight is used with a D- or G-type Nikkor in i-TTL Balanced Fill-Flash.

1 Attach the Speedlight and set the metering system.

- Set a metering system other than Spot metering.

2 Set the exposure mode and confirm shutter speed and aperture.

- When using Red-Eye Reduction with Slow Sync or Slow Sync, set the exposure mode to Programmed Auto or Aperture-Priority Auto.
- Available shutter speeds and apertures in each exposure mode

Exposure mode	Available shutter speed	Available aperture	
Programmed Auto	Automatically set (1/250-1/60 sec.)* ¹	Automatically set	64
Shutter-Priority Auto	1/250-30 sec.* ²		66
Aperture-Priority Auto	Automatically set (1/250-1/60 sec.)* ¹	Desired setting* ³	68
Manual	1/250-30 sec.* ² , Bulb		70

*¹ Shutter speed can be prolonged up to 30 sec. in Slow Sync, Rear-Curtain Sync or Red-Eye Reduction with Slow Sync. In Auto FP High-Speed Sync, shutter speed is controlled at up to 1/8000 sec.

*² In Auto FP High-Speed Sync, shutter speed is controlled at up to 1/8000 sec.

*³ Flash shooting distance range depends on the ISO speed of the film in use and aperture setting. In Aperture-Priority Auto or Manual exposure mode, set the aperture according to the flash shooting distance range table provided with the Speedlight.

- The camera determines background exposure from the selected shutter speed so over- or underexposure indication tends to appear more frequently in Shutter-Priority Auto and Aperture-Priority Auto exposure modes. To bring out the background exposure, set the shutter speed so the electronic analog display indicates a correct exposure in Shutter-Priority Auto or Manual exposure mode. Select Slow Sync in Programmed Auto or Aperture-Priority exposure mode.

3 Set the flash sync mode.

4 Set TTL-BL.

- Set the power switch of the Speedlight to ON and set the flash mode to TTL auto flash.

5 Check the display in the LCD panel.

- Confirm that the indicator **TTLBL** (SB-800) or **TTLBL** (SB-600) for i-TTL Balanced Fill-Flash appears in the LCD panel. If this indication does not appear in the LCD panel, press the MODE button until it appears.

6 Compose picture, focus and confirm the indication in the viewfinder.



- Lightly press the shutter release button and confirm the in-focus ● indicator and ready-light indicator ⚡ appears in the viewfinder.

7 Confirm the flash shooting distance range and shoot.

- If the ready-light blinks approx. 3 sec. after full flash output, underexposure may have occurred. Check the focus distance, aperture or flash shooting distance range and shoot again.
- When using a Speedlight, make sure to read its instruction manual as well.

CSM e1: Auto FP High-Speed Sync can be set, or 1/60 to 1/250 sec. can be selected as the fastest limit for the sync shutter speed (📷 104).

CSM e2: 30 to 1/60 sec. can be selected as the slowest limit for the sync shutter speed in Programmed Auto or Aperture-Priority Auto (📷 104).

About Depth of Field

The section provides a basic explanation of the relationship between focus and depth of field.

■ Depth of field

When focusing, depth of field should always be considered. Depth of field is the area of your photo that is most sharply in focus in front of and behind the subject in which the lens is focused. Depth of field varies according to shooting distance, focal length and, above all, aperture. Smaller apertures (represented by larger f-numbers) will produce a deeper depth of field where the background and foreground remain sharp; larger apertures (represented by smaller f-numbers) will produce a shallower depth of field where the background becomes blurred. Similarly, a shorter shooting distance or a longer focal length will produce a shallower depth of field, and a longer shooting distance or a shorter focal length will produce a deeper depth of field. Note that depth of field tends to be shallower in front of the subject in focus and deeper behind it.



Large aperture $f/2.8$



Small aperture $f/32$



Miscellaneous

This section explains miscellaneous information such as optional accessories, camera care, notes on batteries, specifications or index.

Optional Accessories

Power sources, Speedlights and various other optional accessories are available for the F6.

■ Multi Power Battery Pack MB-40

- With Multi Power Battery Pack MB-40, eight 1.5V AA-type alkaline-manganese, Ni-MH or lithium batteries, or one optional Rechargeable Li-ion Battery EN-EL4 (with optional Battery Chamber Cover BL-3) can be used to power the F6. Film advance speed increases up to 8 fps in continuous high-speed film advance mode. Multi Power Battery Pack MB-40 improves camera holding in the vertical position, and the pack is equipped with an extra shutter release button, the Main- and Sub-Command Dial, AF start button and multi-selector for vertical shooting.

■ Rechargeable Li-ion Battery EN-EL4

- Rechargeable Li-ion Battery EN-EL4 is designed for use with Multi Power Battery Pack MB-40. Rechargeable Li-ion Battery EN-EL4 can be recharged and calibrated using Quick Charger MH-21. Use optional Battery Chamber Cover BL-3 for inserting Rechargeable Li-ion Battery EN-EL4 into Multi Power Battery Pack MB-40.

■ Quick Charger MH-21

- Quick Charger MH-21 fully recharges a discharged Rechargeable Li-ion Battery EN-EL4 in approx. 100 minutes. Use with AC 100-240V, 50-60Hz.

■ Data Reader MV-1

- Transfers shooting data stored in the F6 (📷 112) to a CompactFlash™ memory card (supplied with the MV-1). Data then can be transferred from the memory card to a personal computer.
* Transferring data to a PC requires additional equipment such as PC Card Adapter EC-AD1, commercial PC card adapter for memory cards, or memory card reader.

■ Antifog Finder Eyepiece DK-14/DK-17A

- Antifog Finder Eyepiece DK-14/DK-17A provides a clear viewfinder image and eliminates the problem of finder eyepiece fogging in low temperatures or high humidity. The eyepiece lock is available with the DK-17A.

■ Eyepiece correction lens/Eyepiece correction lens DK-17C

- Enables near- or far-sighted photographers to adjust the eyepiece diopter to suit their vision, and can be attached easily by screwing it onto the viewfinder eyepiece. Five optional eyepiece correction lenses provide viewfinder diopter settings of -3 , -2 , 0 , $+1$ and $+2m^{-1}$. We recommend that you actually look through the viewfinder with various correction lenses attached before making a purchase, since viewfinder diopter differs from one person to another. Use the optional eyepiece correction lens when you need eyepiece correction over -2 to $+1m^{-1}$ that can be adjusted using the F6's diopter adjustment knob. When using an eyepiece correction lens, set the diopter adjustment of the F6 to $-1m^{-1}$. The eyepiece lock is available with the DK-17C.

■ Rubber Eyecup DK-19

- Rubber Eyecup DK-19 can be attached to the viewfinder eyepiece to enable you to see through the viewfinder more clearly while preventing your eyes from becoming tired. The eyepiece lock of the DK-17 (supplied), DK-17A or DK-17C is available with the DK-19.

■ Right-Angle Viewing Attachment DR-5

- Right-Angle Viewing Attachment DR-5 provides an upright and unreversed image with right-angle viewing. The DR-5 allows you to set the reproduction ratio to either 1:1 or 2:1*. An adapter ring is required when attaching to the F6.
* Vignetting occurs around the peripheral area with a reproduction ratio of 2:1.

■ Eyepiece Magnifier DG-2/Eyepiece Adapter DK-7

- Eyepiece Magnifier DG-2 provides 2X magnification of the central portion of the finder image with Eyepiece Adapter DK-7. Eyesight adjustment provided. Useful for critical focusing in close-up photography.

■ Soft case CF-64



- Camera case CF-64 (for AF-S VR 24-120mm f/3.5-5.6G IF-ED or smaller lens attached) is available for this camera.

■ Neckstraps/Handstrap AH-4

- Available neckstraps: leather-type AN-1 (black), braid-type AN-4B (black), and AN-4Y (yellow); wide braid-type neckstrap AN-6Y (yellow), and AN-6W (burgundy).
- Handstrap AH-4 helps you to hold the camera firmly and comfortably and shoot in rapid-motion.

Optional Accessories—continued

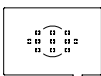
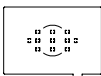
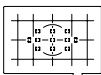
■ Focusing Screens

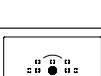
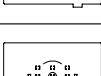
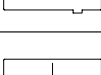
B		Supplied with the F6 camera. Fine-ground matte field with focus brackets. Good for general photography.
U		Matte/Fresnel field with 12mm-dia. reference circle and focus brackets. Suitable with telephoto lenses longer than 200mm. Center-Weighted or Spot metering is recommended.
E		Etched horizontal and vertical lines added to B-type screen make the E-type screen suitable for copying and architectural photography. Especially for use with PC-Nikkor lens.
M		Fine-ground matte field with 5mm-dia. clear spot and cross hair for use in parallax focusing on aerial images, plus millimeter scales for calculating magnification of individual objects or for measuring objects. Brilliant image in dim light. Suitable for close-ups, photomicrography and other high-magnification applications.
J		Matte/Fresnel field with central 5mm-dia. microprism focusing spot and 12mm-dia. reference circle. Good for general photography.
A		Matte/Fresnel field with 5mm-dia. BriteView split-image rangefinder. Rapid, accurate focusing for subjects with both straight lines and ill-defined contours. Suitable for general photography.
L		Same as Type A but with BriteView split-image rangefinder line at a 45° angle. Rapid, accurate focusing for subjects with both straight lines and ill-defined contours. Suitable for general photography.

Type M focusing screen

- Exposure measurement is not possible with type M screen. When using type M screen, it is recommended to set “Off” in the Custom Setting “a5-1: Manual focus” in “a5: Focus area illum” ( 95) due to the optical characteristic of the type M screen.

Filters

- Nikon filters can be divided into three types: screw-in, rear-interchange and slip-in. With the F6, the filter factor need not be considered except when using the R60, which requires exposure compensation to +1 EV. Note that when special filters available from manufacturers other than Nikon are used, autofocus or the electronic rangefinder may not operate properly.
- Use circular-polarizing filter C-PL or C-PLII instead of polarizing filter Polar. The polarizing filter cannot be used with the F6.
- Use L37C or NC filter when using the filter to protect the lens.
- Moiré may occur when shooting a subject against bright light or if a bright light source is in the frame. In this case, remove the filter before shooting.
- Effect of Matrix metering may not be obtained with filters that require compensation other than 1; use of Center-Weighted metering is recommended. For details, see the instruction manual of the filter.

() = f/stop compensation

Film	Type	Designation	Filter factor		Screw-in attachment size (mm)										Rear-interchange	Slip-in (mm)			
			Daylight	Tungsten light	39	46	52	58	62	67	72	77	82	95	122	Bayonet	39	52	
Black & white and color	Neutral	NC	1			○	○	○	○	○	○								
	Skylight	L 1BC	1		○		○		○		○				○				
	Ultraviolet	L 37C	1		○		○		○		○		○	○	○				
		L 39	1				○												
Black & white	Yellow	Medium	Y 48	1.7 (2/3)	1.2 (1/3)	○		○		○		○			○				
		Deep	Y 52	2 (1)	1.4 (1/2)	○													
	Orange	O 56	3.5 (1 5/6)	2 (1)	○		○		○		○				○				
	Red	R 60	8 (3)	5 (2 1/3)	○		○		○		○				○				
Special photography (black & white and color)	Soft	Soft 1	1				○		○		○								
		Soft 2	1				○		○		○								
	Circular-polarizing	C-PL	2-4 (1-2)				○											○	○
		C-PLII					○		○		○		○					○	○
	Neutral density	ND 2xS	2 (1)		○														
		ND 4xS	4 (2)		○														
ND 8xS		8 (3)		○															
Color	Amber	Light	A 2	1.2 (1/3)		○		○		○		○			○				
		Deep	A 12	2 (1)		○													
	Blue	Light	B 2	1.2 (1/3)		○		○		○		○			○				
		Medium	B 8	1.6 (2/3)		○													
		Deep	B 12	2.2 (1 1/6)		○													

Optional Accessories—continued

■ Speedlight SB-800

This high-performance Speedlight has a Guide Number of 38/125 (m/ft., 35mm zoom head position, ISO 100, 20°C/68°F) and supports i-TTL, TTL, auto aperture (AA), non-TTL auto (A), manual, and repeating flash control. Flash sync mode, including slow and rear-curtain sync, can be set from the camera. When used with the F6, the SB-800 supports Auto FP High-Speed Sync for sync speeds faster than 1/250 sec. (repeating flash mode excluded), FV Lock for recomposing photos without changing flash level, and Advanced Wireless Lighting with support for i-TTL, auto aperture, manual, and repeating flash control. The built-in AF-assist illuminator can be used with all of the F6's 11 focus areas. For bounce-flash or close-up photography, the flash head can be rotated through 90° above and 7° below the horizontal, 180° left, and 90° right, while soft lighting can be achieved with the supplied SW-10H bounce adapter. Auto power zoom (24–105mm) ensures that illumination is adjusted in accord with the lens focal length. The built-in wide panel can be used for illuminating angles of 14mm and 17mm. An illuminator is included to assist in adjusting settings in the dark. The SB-800 accepts four AA batteries (five AA batteries when powered by the supplied SD-800 battery pack) or SD-6, SD-7, or SD-8A power sources (available separately). Custom settings are available for fine-tuning all aspects of flash operation.



■ Speedlight SB-600

This high-performance Speedlight has a Guide Number of 30/98 (m/ft., 35mm zoom head position, ISO 100, 20°C/68°F) and supports i-TTL, TTL, manual, and repeating flash control. When used with the F6, the SB-600 supports Auto FP High-Speed Sync for sync speeds faster than 1/250 sec. (repeating flash mode excluded), FV Lock for recomposing photos without changing flash level, and Advanced Wireless Lighting with support for i-TTL, auto aperture, manual, and repeating flash control. Auto power zoom (24–85mm) ensures that illumination is adjusted in accord with the lens focal length. The built-in wide panel can be used for illuminating angles of 14mm. An illuminator is included to assist in adjusting settings in the dark. The SB-600 accepts four AA batteries or SD-6, SD-7, or SD-8A power sources (available separately).



■ Accessories connected to 10-pin remote terminal

- By attaching the following accessories to the 10-pin remote terminal of the F6, you can perform operations such as remote shooting or automatic shooting.
- When the 10-pin remote terminal is not in use, make sure to cover it with the supplied cap. Exposure to dirt or contact with foreign objects may result in a malfunction.
- To connect an accessory to the 10-pin terminal, align the indexes, insert the plug, then turn the lock screw as shown.
- The cap of the 10-pin terminal can be removed smoothly if you first remove the cap on the sync terminal.

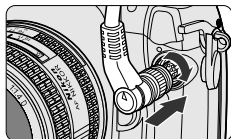

Accessory	Usage	Length
Remote Cord MC-20	Enables the shutter to be released remotely reducing camera shake. Long-Time Exposure and Time mode are available, and a beeping sound can be set to repeat each second for the duration of the exposure.	Approx. 80cm (2.6 ft.)
Extension Cord MC-21	Extension cord for MC-20, MC-22, MC-23, MC-25 or MC-30.	Approx. 3m (9.8 ft.)
Remote Cord MC-22	Remote cord with blue, yellow and black terminals to connect to a shutter triggering device. Remote control operation via sound or signal is available.	Approx. 1m (3.3 ft.)
Connecting Cord MC-23	Connects two F6 cameras for simultaneous operation	Approx. 40cm (1.3 ft.)
Adapter Cord MC-25	Adapter cord to connect a remote accessory for 2-pin remote terminal such as Radio Control Set MW-2, Intervalometer MT-2 or Modulite Remote Control Set ML-2 to F6.	Approx. 20cm (0.7 ft.)
Remote Cord MC-30	Useful for releasing shutter remotely to reduce camera shake. Also, shutter can be locked in Long Time Exposure (Bulb).	Approx. 80cm (2.6 ft.)
Modulite Remote Control Set ML-2	Enables remote control up to 100m (328 ft.) via an infrared pulse-modulated ray. Multiple ML-2s can be used to enable more distant remote control. (Adapter Cord MC-25 is required.)	—
Modulite Remote Control Set ML-3	Enables remote control up to 8m (26.2 ft.) via an infrared ray. Auto triggering, where the shutter is released when the subject enters the area directly between the transmitter and the receiver, is available.	—

Camera Care



WARNING



Do not use

NEVER use organic solvents such as thinner or benzene near the F6. Doing so could cause a fire or health hazard, and damage the camera.

• **Cleaning camera body**

Use a blower brush to remove dirt and dust from the camera body and clean it with a soft, clean cloth. After using the camera near seawater, wipe the camera body with a soft, clean cloth slightly moistened with pure water to remove salt, and then dry it with a dry cloth.

• **Cleaning mirror and lens**

Use a blower brush to remove dirt and dust from the mirror or lens. To remove fingerprints or smudges from the lens' surface, use a soft, clean cotton cloth or lens tissue moistened with ethanol (alcohol) or lens cleaner.

• **Do not subject the camera or lens to strong vibration or shock**

Do not drop the camera body and lens or allow them to impact against a hard surface as this may damage their precision mechanisms.

• **Do not touch the shutter curtains**

The shutter is made of very thin curtains. Do not hold, poke, or blow strongly with a blower brush. Doing so may scratch, deform or tear the shutter curtains.

• **Avoid strong electric or magnetic fields**

The camera may not function properly in strong electric or magnetic fields, such as near a transmitter tower. Avoid using the camera in such locations.

• **Store the camera in a cool, dry place**

Store the camera in a cool, dry place to prevent mold and mildew.

Keep it away from naphthalene or camphor (moth repellent), electrical appliances that generate magnetic fields, or excessive heat such as inside a vehicle during the summer or near a heater.

• **Avoid extreme temperature change**

Extreme temperature change can cause condensation inside the camera body.

When taking the camera to a very hot place from a very cold place, or vice versa, place it inside an airtight container such as a plastic bag and leave it inside the bag for a while to expose the camera gradually to the temperature change.

• Remove the batteries and store the camera with a desiccant

If you do not intend to use the camera for a long time, remove the batteries to protect the camera from battery leakage.

- In a humid environment, store the camera inside a plastic bag with a desiccant to keep out dust, moisture and salt. Note, however, that storing leather cases in vinyl bags may cause the leather to deteriorate. Keep the batteries in a cool, dry place away from heat or humidity.
- Change the desiccant occasionally since it does not absorb moisture effectively for long periods.
- Leaving the camera unused for a long period of time may cause mold to grow and result in malfunction. Turn the power on and release the shutter a few times once per month.

Nikon cannot be held responsible for any malfunction resulting from the use of the camera other than as specified in this manual.

Notes on Batteries



WARNING



Do not leave

Keep batteries out of reach of children.

If someone accidentally swallows a battery, call a doctor immediately.

• Use two lithium batteries

With Multi Power Battery Pack MB-40, eight 1.5V alkaline-manganese, lithium, Ni-MH, or one Rechargeable Li-ion Battery EN-EL4 can be used to power the F6.

- Change the batteries well before the end of their life and prepare spare batteries before important photographic occasions.

• Turn the camera power off when changing batteries

Turn the camera power off before changing batteries and insert the batteries with + and – ends positioned correctly.

- Stains on the battery poles may cause lack of contact. Wipe the batteries well with a dry cloth before installing.

• Use fresh batteries at low temperatures





Battery power diminishes at extremely low temperatures and the camera may not function properly with old batteries. Use a fresh set of batteries at low temperatures, and alternate them with spare batteries that you keep warm.



- At low temperatures, film advance speed decreases and the usable number of film rolls is reduced. However, battery power may recover when the temperature returns to normal.

• Do not throw batteries into a fire or short-circuit batteries

Do not throw batteries into a fire. Also, do not short-circuit, disassemble, heat or charge non-rechargeable batteries.

Troubleshooting

Top LCD panel	Viewfinder	Rear LCD panel	Cause
fEE blinks	fEE blinks	FEE appears	<ul style="list-style-type: none"> • CPU Nikkor lens (other than G-type) is not set to its minimum aperture.
 appears	 appears	—	<ul style="list-style-type: none"> • Batteries are nearing exhaustion.
 blinks	 blinks	—	<ul style="list-style-type: none"> • Batteries are just about exhausted.
—	—	CLOCK HAS BEEN RESET. Set time and date.	<ul style="list-style-type: none"> • Built-in clock has been reset.
Δf appears	Δf appears	Δf appears	<ul style="list-style-type: none"> • EV step difference from the lens' maximum aperture is displayed. Non-CPU lens with maximum aperture not specified is attached.
Err and E blink	Err and E blink	FILM LOAD ERROR	<ul style="list-style-type: none"> • Film does not correctly advance.
Err blinks	Err blinks	DX ERR	<ul style="list-style-type: none"> • Film speed is set to DX and non-DX-coded film is loaded.
E blinks	E blinks	REWIND COMPLETED	<ul style="list-style-type: none"> • Film remains in the camera after film rewind is complete.
End blinks	End blinks	END OF FILM	<ul style="list-style-type: none"> • The end of the film roll has been reached.
0.. and frame counter blink	0.. and frame counter blink	REWINDING...	<ul style="list-style-type: none"> • Batteries are exhausted during film rewind.
—	▶ ◀ blinks	—	<ul style="list-style-type: none"> • Autofocus is not possible.

	Remedy	Page
	• Set lens to minimum aperture.	20
	• Have fresh ones ready.	18
	• Turn the power off and replace batteries with new ones.	18
	• Set date and time in “Date” setup menu.	35
	• Specify maximum aperture of the non-CPU lens. Aperture will be displayed.	40, 144
	• Reload film.	22
	• Load DX-coded film or set the film speed manually.	23, 44
	• Remove the film cartridge.	32
	• Rewind film by pressing the two film rewind buttons  or by rotating the film rewind crank.	46, 47
	• Rewind film again by pressing the two film rewind buttons  after reloading fresh set of batteries or by rotating the film rewind crank.	46, 47
	• Focus manually.	61

Troubleshooting—continued

Top LCD panel	Viewfinder	Rear LCD panel	Cause
H I appears	H I appears	HI appears	<ul style="list-style-type: none"> • Overexposure may have occurred.
Lo appears	Lo appears	Lo appears	<ul style="list-style-type: none"> • Underexposure may have occurred.
Electronic analog display blinks	Electronic analog exposure display blinks	—	<ul style="list-style-type: none"> • Subject brightness is beyond camera's exposure range.
buLb blinks	buLb blinks	buLb appears	<ul style="list-style-type: none"> • Shutter speed is set to buLb in S mode.
P or S blinks	R appears	—	<ul style="list-style-type: none"> • Non-CPU lens is attached, or no lens is attached in P or S mode.
250 appears	250 appears	250 appears	<ul style="list-style-type: none"> • Shutter speed faster than 1/250 sec. (the highest sync speed) is selected in S or M mode.
—	⚡ blinks for 3 sec. after flash	—	<ul style="list-style-type: none"> • Flash has fired at full output and an underexposure may have occurred.
Err blinks	Err blinks	ERR appears	<ul style="list-style-type: none"> • Malfunction detected.
FuL blinks	FuL blinks	OUT OF MEMORY CANNOT RECORD SHOOTING DATA. TURN CAMERA OFF.	<ul style="list-style-type: none"> • F6's memory has reached its data storage limit.
—	—	 highlighted	<ul style="list-style-type: none"> • Red-Eye Reduction or Red-Eye Reduction with Slow Sync is set when a Speedlight without Red-Eye Reduction function is attached.

	Remedy	Page
	<ul style="list-style-type: none"> • In P mode, use ND filter. • In S mode, select a faster shutter speed. • In A mode, select a smaller aperture (larger f-number). (If the warning indication remains after performing the above remedies in S or A mode, use an ND filter as well.) 	65 67 69
	<ul style="list-style-type: none"> • In P mode, use flash. • In S mode, select a slower shutter speed. • In A mode, select a larger aperture (smaller f-number). (If the warning indication remains after performing the above remedies in S or A mode, use flash as well.) 	65 67 69
	<ul style="list-style-type: none"> • When the subject is bright, use an ND filter; when the subject is dark, use flash. 	67, 69, 71
	<ul style="list-style-type: none"> • Cancel bulb by selecting a shutter speed of 30 sec. or faster, or select M mode to perform Long Time Exposure. 	66, 70
	<ul style="list-style-type: none"> • If non-CPU lens is attached, set the exposure mode to A or M. 	65, 67, 68, 70
	<ul style="list-style-type: none"> • Release the shutter as is to take a flash picture. (Shutter speed automatically shifts to 1/250 sec.) • With SB-800/SB-600, perform Auto FP High-Speed Sync by setting Custom Setting "e1: Flash sync speed" to "1/250 (FP auto)". 	104 162
	<ul style="list-style-type: none"> • Shoot again after confirming focus distance, aperture or flash shooting distance range. 	156, 163
	<ul style="list-style-type: none"> • Release shutter again. If the warning indication remains, or this warning appears frequently, contact an authorized Nikon dealer or service center. 	—
	<ul style="list-style-type: none"> • Turn the power switch off once and on again. Warning indication disappears and additional data will not be recorded until the data in the memory is erased. 	120
	<ul style="list-style-type: none"> • Use a Speedlight equipped with Red-Eye Reduction function. 	159, 160

■ Microcomputer of the camera

In certain cases, due to static electricity or poorly loaded batteries, the F6's microcomputer may turn the camera off, even with fresh, properly installed batteries. For the same reason, the film may not advance properly. In each of these cases, to resume operation, simply turn the power off, then turn it on again. Or, remove and reinstall the batteries.

■ About the LCD

The LCD panel and viewfinder displays tend to turn darker at high temperatures and experience slower response at low temperatures. In either case, when the temperature returns to normal, the displays also return to normal.

■ LCD illuminator panel

The LCD illuminator panel wears out with time and the brightness of the LCD illumination becomes weaker. This is not a malfunction. Contact an authorized Nikon dealer or service center to replace the LCD illuminator panel with a new one.

Specifications

Type of camera	Integral-motor autofocus 35mm single-lens reflex with electronically controlled focal-plane shutter
Exposure modes	P : Programmed Auto (Flexible Program possible) S : Shutter-Priority Auto R : Aperture-Priority Auto M : Manual
Picture format	24 x 36mm (standard 35mm film format)
Lens mount	Nikon F mount (with AF coupling, AF contacts)
Lens	<ul style="list-style-type: none"> • G- or D-type AF Nikkor (except for DX- and IX-Nikkor): All functions possible • PC Micro-Nikkor 85mm f/2.8D: All functions except autofocus and exposure modes other than Manual possible without shifting and/or tilting the lens • AF Nikkor other than G/D-type (except AF Nikkor for F3AF): All functions except 3D Color Matrix Metering possible • AI-P Nikkor: All functions except 3D Matrix Metering and autofocus possible • Non-CPU: Usable in Aperture-Priority Auto or Manual exposure mode, electronic rangefinder usable with lens having a maximum aperture of f/5.6 or faster, Color Matrix Metering, aperture value display, etc. usable with the lens data specified (with AI lens) • TC-16A: Autofocus possible with lens having a maximum aperture of f/3.5 or faster (electronic rangefinder not usable) except with some lens • Non-AI lens: Can be attached with modification (stop-down measurement)
Viewfinder	Fixed eye-level pentaprism, built-in diopter adjustment (−2.0 to +1m ⁻¹), eyepiece shutter, eyepiece DK-17, eyepiece lock available
Eyepoint	18mm (at −1.0m ⁻¹)
Focusing screen	B-type BriteView clear Matte screen II, interchangeable with six optional focusing screens
Viewfinder frame coverage	Approx. 100%
Finder magnification	Approx. 0.74x with 50mm lens set to infinity and −1.0m ⁻¹
Viewfinder information	Focus indications, metering system, AE lock, FV lock, exposure mode, shutter speed lock, sync speed, shutter speed, aperture step, aperture lock, aperture, multiple exposure, battery level, frame counter/exposure compensation value, electronic analog exposure display, exposure compensation, bracketing, ready-light, 11 sets of focus brackets (area)
Reflex mirror	Automatic, instant-return type





Specifications—continued

Lens aperture	Instant-return type, with depth-of-field preview button
Autofocus	TTL phase detection, Nikon Multi-CAM2000 autofocus module <ul style="list-style-type: none"> • Detection range: EV -1 to EV 19 (ISO 100, at normal temperature)
Lens servo	<ul style="list-style-type: none"> • Single Servo AF (S), Continuous Servo AF (C), Manual focus (M) • Focus Tracking automatically activated in Single Servo AF (S) or Continuous Servo AF (C)
Focus area	One or group out of 11 focus areas can be selected
AF Area mode	<ul style="list-style-type: none"> • Single Area AF • Dynamic AF • Group Dynamic AF • Dynamic AF Mode with Closest-Subject Priority
Focus lock	Focus is locked by pressing AE/AF-L button or lightly pressing shutter release button in Single Servo AF
Metering system	TTL full-aperture exposure metering system <ul style="list-style-type: none"> • 3D Color Matrix Metering: With G- or D-type lens (except for DX- or IX-Nikkor) • Color Matrix Metering: With AF Nikkor lens other than G- or D-type (except AF Nikkor for F3AF), AI-P lens, non-CPU lens with lens data specified • Center-Weighted Metering: Approx. 75% of the meter's sensitivity concentrated on the 12mm dia. circle • Spot Metering: 4mm dia. circle (approx. 1.5% of entire frame); shifts according to focus area selected
Metering range	3D Color Matrix Metering: EV 0-20 Center-Weighted Metering: EV 0-20 Spot Metering: EV 2-20 (at normal temperature, ISO 100, 50mm f/1.4 lens)
Exposure meter coupling	CPU and AI combined, meter coupling lever can be modified
Exposure compensation	Exposure compensated in ± 5 EV range, in 1/3, 1/2 or 1 steps
Auto Exposure Lock	Detected exposure value locked by pressing AE/AF-L button
Auto Exposure Bracketing	Number of shots: 2-7; compensation steps: 1/3, 1/2, 2/3 or 1 EV steps
Film speed setting	<ul style="list-style-type: none"> • DX or manual selectable (manual setting has priority over DX detected film speed) • Film speed range: DX: ISO25-5000, Manual: ISO 6-6400 in 1/3 steps
Shutter	Electronically controlled vertical-travel focal-plane shutter (with built-in shutter monitor)

Shutter speeds	<ul style="list-style-type: none"> • In P, A: 30 to 1/8000 sec. • In S: 30 to 1/8000 sec. (in 1/3 steps), X (1/250 sec.) • In M: 30 to 1/8000 sec. (in 1/3 steps), Bulb, X (1/250 sec.) * Shutter speed can be prolonged to 30 min. in M mode
Sync contact	X-contact only; flash synchronization up to 1/250 sec. (up to 1/8000 sec. possible in Auto FP High-Speed Sync)
Flash control	<p>TTL flash control by combined five-segment TTL multi sensor with single-component IC and 1,005-pixel AE sensor</p> <ul style="list-style-type: none"> • i-TTL Balanced Fill-Flash with SB-800, 600 • Automatic Balanced Fill-Flash with TTL Multi Sensor: 3D Multi-Sensor Balanced Fill-Flash compatible with SB-80DX, SB-50DX, SB-28/28DX, SB-27, SB-26, SB-25 and D/G-type Nikkor lens; Multi-Sensor Balanced Fill-Flash with a Speedlight without Monitor Pre-Flash and CPU lens other than D/G-type or non-CPU lens • Standard TTL: With Spot Metering • Film speed range in TTL auto flash: ISO 25-1000
Flash sync mode	Front-Curtain Sync (normal sync), Red-Eye Reduction, Red-Eye Reduction with Slow Sync, Slow Sync, Rear-Curtain Sync
Ready-light	Lights up when flash fully charged with Speedlights SB-800, SB-600, SB-80DX, SB-50DX, SB-30, SB-29s/29, SB-28/28DX, SB-27, SB-26, SB-23, etc.; blinks (3 sec. after flash) for full output warning
Accessory shoe	ISO518 hot-shoe contact digital data communication (sync contact, ready-light contact, TTL auto flash contact, monitor contact, GND), safety lock provided
Sync terminal	ISO519 terminal, lock screw provided
Creative Lighting System	Advanced Wireless Lighting, Auto FP High-Speed Sync, Modeling flash, FV Lock and AF-Assist for Multi-Area AF available with Speedlights SB-800, SB-600
Self-timer	Electronically controlled; timer duration: 10 sec.
Depth-of-field preview button	Stop-down lens aperture by pressing depth-of-field button
Mirror up	Possible via film advance mode selector
Film loading	Film automatically advances to first frame when camera back is closed

Specifications—continued

Film advance	<ul style="list-style-type: none"> • Automatic advance with built-in motor • Film advance speed (with Continuous Servo AF (C), Manual exposure mode, shutter speed of 1/250 sec. or faster, 36-exposure film, CR123A-type lithium batteries [AA-type alkaline-manganese or Rechargeable Li-ion Battery EN-EL4 in Multi Power Battery Pack MB-40]) <ul style="list-style-type: none"> S: One-frame advance CL: Continuous low-speed shooting Approx. 2 fps [Approx. 4 fps] CH: Continuous high-speed shooting Approx. 5.5 fps [Approx. 8 fps] Cs: Continuous silent-low-speed shooting Approx. 1 fps [Approx. 2 fps]
Film rewind	<ul style="list-style-type: none"> • Automatic rewind with built-in motor (activate by pressing two film rewind buttons), manual film rewind with film rewind crank is also possible • Rewind speed with 36-exposure film: C: approx. 7 sec., Cs: approx. 12 sec.
Multiple exposure	Activate via shooting menu
Interval timer	Activate via shooting menu
Top LCD panel information (built-in illuminator)	Shutter speed lock, sync speed, shutter speed, aperture stop, aperture lock, aperture, Auto Exposure Bracketing, exposure mode, flexible program, exposure compensation, electronic analog exposure display, battery power, exposure compensation value, Auto Exposure Bracketing status, frame counter
Rear LCD panel information (built-in illuminator)	<ul style="list-style-type: none"> • Shooting display (normal, detailed, large display) • Shooting data display (film data, frame data) • Menu display (Custom Setting menu, set up menu, shooting menu, Non-CPU lens, language)
Data imprint	Activate via shooting menu <ul style="list-style-type: none"> • In-frame imprint, between-frame imprint, 0-frame imprint • Film speed range: DX: ISO 50-3200
Internal clock	Built-in clock; 24-hour type; leap year adjustment until 2099
Camera back	Hinged back; film confirmation window, AF area mode selector, multi-selector, MENU button, film speed (ISO) button, flash sync mode button, INFO button, rear LCD panel, built-in data imprint unit
Shooting data	Recordable number of film roll (36-exposures): Approx. 57 rolls in basic shooting data (13 items), Approx. 31 rolls in detailed shooting data (21 items)
10-pin remote terminal	Equipped

Power source	Battery holder MS-41 provided (two 3V lithium batteries); optional Multi Power Battery Pack MB-40 and AA-type battery holder MS-40 available (for eight alkaline-manganese, lithium or Ni-MH batteries, or one Rechargeable Li-ion Battery EN-EL4 with optional Battery Chamber Cover BL-3); built-in backup battery for internal clock			
Power switch	Power ON, OFF and LCD panel illuminator on position			
Exposure meter	Auto meter shut-off 8 sec. after power turned on if no operations are performed; activated by lightly pressing shutter release button or pressing AF start button after power is turned on			
Battery power confirmation	 for sufficient power;  indicates batteries has began exhaustion;  indicates low battery power; blinking  indicates batteries are exhausted; no indication/symbol appears when batteries are completely exhausted or improperly installed			
Usable number of 36-exposure film rolls per set of fresh batteries	The usable number of film roll is tested under following conditions by Nikon			
	Test 1			
	Camera setting: Using an AF-S VR 24-120mm f/3.5-5.6G ED lens, Vibration Reduction function on, in Continuous Servo AF with film advance mode at S and shutter speed of 1/250 sec.			
	Autofocus operation: After lightly pressing the shutter release button for 8 sec., autofocus operation covers the full range from infinity (∞) to the closest distance and back to infinity (∞) before each shot. After the exposure meter automatically turns off, the same operation follows for the next shot.			
		Temperature	At 20°C/68°F	At -10°C/14°F
	Battery			
	3V lithium		Approx. 15	Approx. 6
AA-type alkaline-manganese (with MB-40)		Approx. 10	Approx. 1	
AA-type Ni-MH (with MB-40)		Approx. 30	Approx. 30	
AA-type lithium (with MB-40)		Approx. 45	Approx. 35	
Rechargeable Li-ion Battery EN-EL4 (with MB-40)		Approx. 35	Approx. 25	

Specifications—continued

Usable number of 36-exposure film rolls per set of fresh batteries	Test 2 Camera setting: Using an AF-S VR 70-200mm f/2.8G IF-ED lens, Vibration Reduction function on, in Continuous Servo AF with film advance mode at CH and shutter speed of 1/250 sec. Autofocus operation: After lightly pressing the shutter release button for 3 sec., autofocus operation covers the full range from infinity (∞) to the closest distance and back to infinity (∞) three times before each shot. The same operation follows for the next shot.																		
	<table border="1"> <thead> <tr> <th>Battery \ Temperature</th> <th>At 20°C/68°F</th> <th>At -10°C/14°F</th> </tr> </thead> <tbody> <tr> <td>3V lithium</td> <td>Approx. 35</td> <td>Approx. 15</td> </tr> <tr> <td>AA-type alkaline-manganese (with MB-40)</td> <td>Approx. 55</td> <td>Approx. 4</td> </tr> <tr> <td>AA-type Ni-MH (with MB-40)</td> <td>Approx. 55</td> <td>Approx. 50</td> </tr> <tr> <td>AA-type lithium (with MB-40)</td> <td>Approx. 95</td> <td>Approx. 70</td> </tr> <tr> <td>Rechargeable Li-ion Battery EN-EL4 (with MB-40)</td> <td>Approx. 65</td> <td>Approx. 50</td> </tr> </tbody> </table>	Battery \ Temperature	At 20°C/68°F	At -10°C/14°F	3V lithium	Approx. 35	Approx. 15	AA-type alkaline-manganese (with MB-40)	Approx. 55	Approx. 4	AA-type Ni-MH (with MB-40)	Approx. 55	Approx. 50	AA-type lithium (with MB-40)	Approx. 95	Approx. 70	Rechargeable Li-ion Battery EN-EL4 (with MB-40)	Approx. 65	Approx. 50
	Battery \ Temperature	At 20°C/68°F	At -10°C/14°F																
	3V lithium	Approx. 35	Approx. 15																
	AA-type alkaline-manganese (with MB-40)	Approx. 55	Approx. 4																
	AA-type Ni-MH (with MB-40)	Approx. 55	Approx. 50																
	AA-type lithium (with MB-40)	Approx. 95	Approx. 70																
Rechargeable Li-ion Battery EN-EL4 (with MB-40)	Approx. 65	Approx. 50																	
Duration (in hours) of Long Time (Bulb) exposure	<table border="1"> <thead> <tr> <th>Battery \ Temperature</th> <th>At 20°C/68°F</th> <th>At -10°C/14°F</th> </tr> </thead> <tbody> <tr> <td>3V lithium</td> <td>Approx. 5</td> <td>Approx. 3</td> </tr> <tr> <td>AA-type alkaline-manganese (with MB-40)</td> <td>Approx. 6</td> <td>Approx. 1.5</td> </tr> <tr> <td>AA-type Ni-MH (with MB-40)</td> <td>Approx. 5</td> <td>Approx. 4</td> </tr> <tr> <td>AA-type lithium (with MB-40)</td> <td>Approx. 8.5</td> <td>Approx. 7</td> </tr> <tr> <td>Rechargeable Li-ion Battery EN-EL4 (with MB-40)</td> <td>Approx. 7</td> <td>Approx. 6</td> </tr> </tbody> </table>	Battery \ Temperature	At 20°C/68°F	At -10°C/14°F	3V lithium	Approx. 5	Approx. 3	AA-type alkaline-manganese (with MB-40)	Approx. 6	Approx. 1.5	AA-type Ni-MH (with MB-40)	Approx. 5	Approx. 4	AA-type lithium (with MB-40)	Approx. 8.5	Approx. 7	Rechargeable Li-ion Battery EN-EL4 (with MB-40)	Approx. 7	Approx. 6
	Battery \ Temperature	At 20°C/68°F	At -10°C/14°F																
	3V lithium	Approx. 5	Approx. 3																
	AA-type alkaline-manganese (with MB-40)	Approx. 6	Approx. 1.5																
	AA-type Ni-MH (with MB-40)	Approx. 5	Approx. 4																
	AA-type lithium (with MB-40)	Approx. 8.5	Approx. 7																
	Rechargeable Li-ion Battery EN-EL4 (with MB-40)	Approx. 7	Approx. 6																

Tripod socket	1/4 (ISO1222)
Custom Setting	41 Custom Setting menus are available ( 90)
Two-Button Reset	Pressing the MENU and INFO buttons simultaneously and holding them for more than 2 sec. resets various settings to their original default settings (with some exceptions)
Dimensions (W x H x D)	Approx. 157 x 119 x 78.5mm (6.2 x 4.7 x 3.1 in.)
Weight (without batteries)	Approx. 975g (34.4 oz.)
Optional exclusive accessories	Multi Power Battery Pack MB-40, Rechargeable Li-ion Battery EN-EL4, Battery Chamber Cover BL-3, Quick Charger MH-21, Data Reader MV-1, six types of focusing screens, Antifog Finder Eyepiece DK-17A, Eyepiece Correction Lens DK-17C, Soft case CF-64

Usable number of film rolls and duration of long time (Bulb) exposure were tested using the following batteries. Usable number of film rolls and duration of long time (Bulb) exposure may vary depending on shooting conditions.

- 3V lithium: CR123A, Matsushita Battery Industrial Co., Ltd.
- AA-type alkaline-manganese: LR6, Matsushita Battery Industrial Co., Ltd.
- AA-type Ni-MH: HR-3UB (2300mAh), Sanyo Electric Co., Ltd.
- AA-type lithium: FR6, Fuji Photo Film Co., Ltd.

All specifications apply when fresh 3V lithium (CR123A-type) batteries are used at normal temperature (20°C/68°F).

Specifications and design are subject to change without notice.

Trademark Information

- CompactFlash™ is a trademark of SanDisk Corporation.
- Microsoft®, Microsoft® Excel and Windows® are registered trademarks or trademarks of Microsoft Corporation in the United States and/or other countries.
- Other products and brand names are trademarks or registered trademarks of their respective companies.

A

Advanced Wireless Lighting	151
AF Area Mode	52
AF-Assist for Multi-Area AF	153
AF-Assist Illuminator	161
Aperture-Priority Auto exposure mode	68
Auto Exposure Bracketing	75
Auto Exposure Lock	72
Autofocus	24, 48, 60
Auto FP High-Speed Sync	153
Automatic Balanced Fill-Flash with TTL Multi Sensor	154

C

Center-Weighted Metering	63
Color Matrix Metering	38, 62
Command lock	67, 69
Continuous high-speed shooting (CH)	45
Continuous low-speed shooting (CL)	45
Continuous Servo AF (AF-C)	48
Continuous shooting	45
Continuous silent-low-speed shooting (Cs)	45
CPU Nikkor lens	20, 38
Creative Lighting System (CLS)	150
Custom Setting	90

D

Date/time, setting	35
Date display order	36
Depth of field	164
Diopter adjustment	81
Distance information	26, 62, 150, 154
D-type Nikkor lens	20, 38
DX-coded film	23
Dynamic AF Mode	52
Dynamic AF Mode with Closest-Subject Priority	53

E	
Exposure Compensation	74
Exposure meter	18
Exposure mode	26, 64-71
EV value	65

F	
Film advance mode	22, 45
Flash Exposure Bracketing	75
Flash shooting distance range	163
Flash sync mode	157, 158
Flexible Program	64
Focal length, specifying	144
Focus area	9, 28, 50
Focus brackets	9, 28, 50
Focusing screens	168
Focus Lock	58
Focus mode	24, 38, 48, 61
Focus Tracking	31, 48
Front-Curtain Sync	158
FV Lock	151, 152

G	
Group Dynamic AF Mode	52
G-type Nikkor lens	20, 38

I	
Imprinting data between frames	130
Imprinting data in-frame	126
Imprinting data on frame number 0	134
Imprinting shooting data	126
Interval timer	140
i-TTL Balanced Fill-Flash	150, 159
i-TTL flash control	150

L	
Language	34
LCD illuminator	81
Lens data	144
Long Time exposure (Bulb)	70, 80

M

Manual exposure mode.....	70
Manual flash	155
Manual focus	61
Manual focus with electronic rangefinder.....	38, 61
Matrix Metering	62
Maximum aperture.....	68, 70
Maximum aperture, specifying	144
Metering system.....	62
Minimum aperture	20, 68, 70
Mirror up (M-up) photography.....	84
Modeling flash	151
Monitor preflash	150, 152, 154
Multiple Exposure.....	138
Multi-Sensor Balanced Fill-Flash.....	154, 160

N

Non-AI lens	41
Non-CPU lens.....	39, 40, 144
Non-TTL Auto flash (A).....	155

P

Program chart	65
Programmed Auto.....	64

R

Rear-Curtain Sync.....	158
Ready-light.....	156
Recording shooting data	112
Red-Eye Reduction	158
Red-Eye Reduction with Slow Sync.....	158
Remote control.....	171

S	
Self-diagnostic shutter	86
Self-timer	82
Setup menu	111
Shooting menu	125
Shutter-Priority Auto exposure mode	66
Single Area AF Mode	52
Single-frame shooting	45
Single Servo AF (AF-S)	48
Slow Sync flash	158
Spot Metering	63
Standard i-TTL flash	150
Standard TTL flash	150, 154
Sync shutter speed	104, 153, 161

T	
1,005-pixel RGB sensor	62
3D Color Matrix Metering	38, 62
3D Multi-Sensor Balanced Fill-Flash	154, 160
TTL auto flash	154, 160
Two-Button Reset	147

V	
Viewfinder frame coverage	29

No reproduction in any form of this manual, in whole or in part (except for brief quotation in critical articles or reviews), may be made without written authorization from NIKON CORPORATION.

Nikon

NIKON CORPORATION

FUJI BLDG., 2-3, MARUNOUCHI 3-CHOME,
CHIYODA-KU, TOKYO 100-8331, JAPAN

Printed in Japan KL4J00500201 (S037) 11
8MAA2311--