

**Nikon**

**AF 100**

AF 100 (En)

INSTRUCTION MANUAL



# Nomenclature

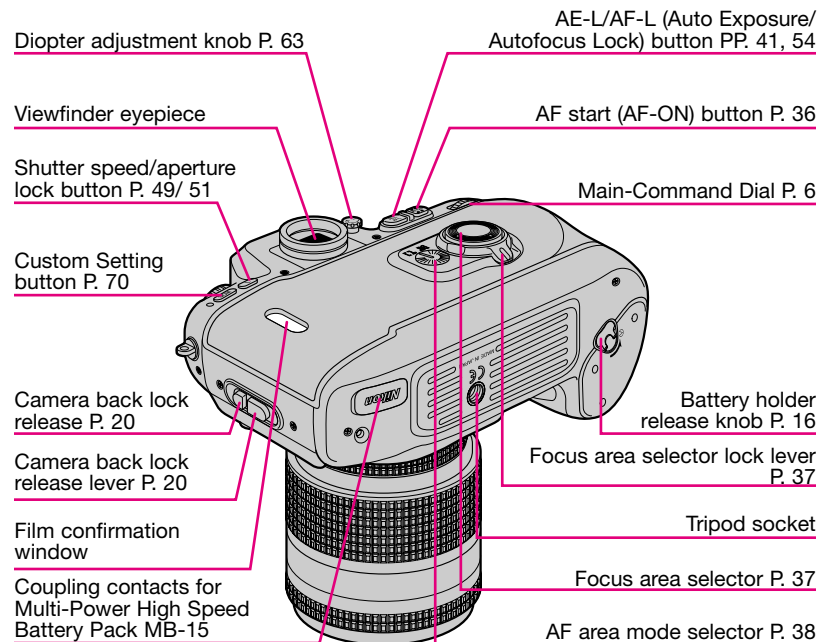
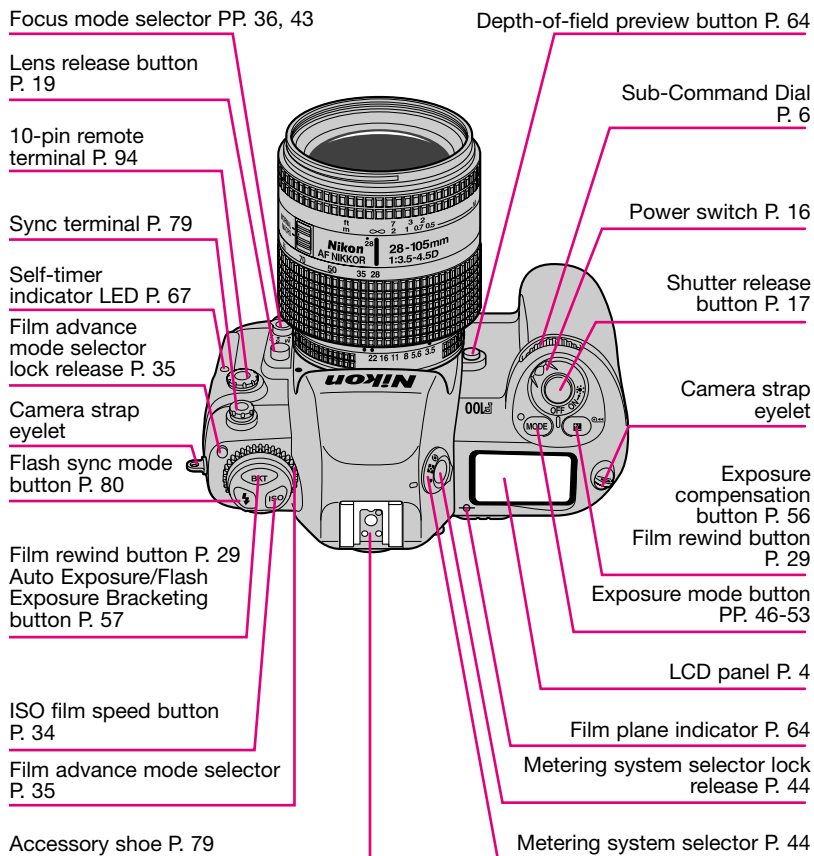

## Supplied accessories

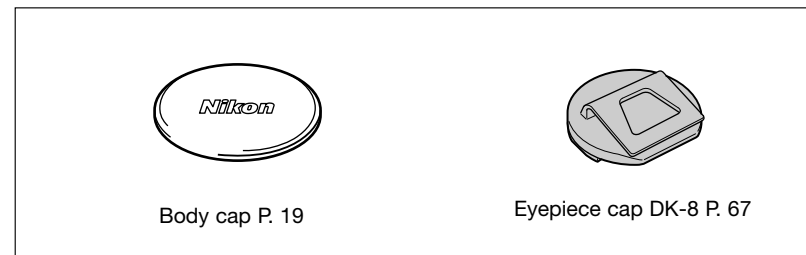

# LCD/Viewfinder Displays

## ■ LCD panel

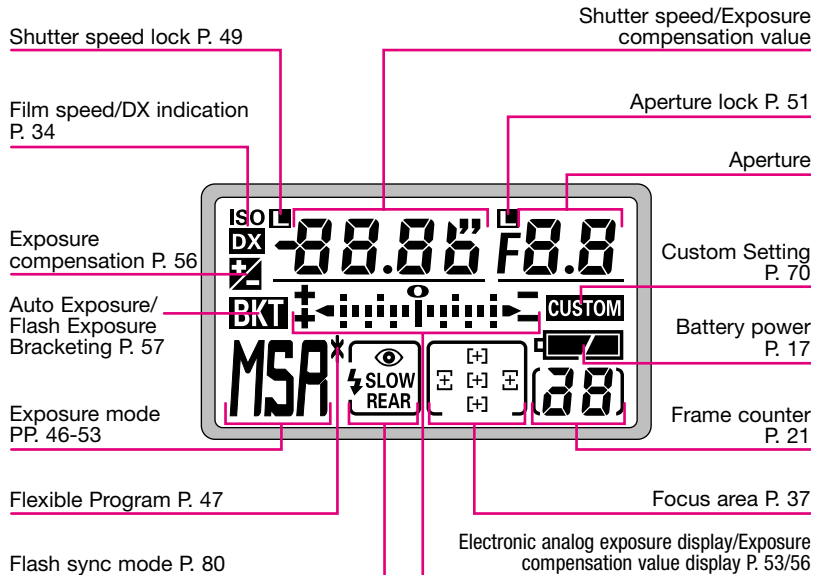

## About LCD illuminator panel

LCD illuminator panel brightness deteriorates over time, and is not a malfunction. Contact an authorized Nikon dealer or service center to replace the illuminator panel (at charge).

### About LCD

- At high temperatures of 60°C (140°F) or above, the display turns black, making it impossible to read. It returns to normal when the temperature drops to 20°C (68°F).
- At temperatures below freezing, the LCD's response time slows; when the temperature rises, it returns to normal.

## ■ Viewfinder Display

12mm-dia. reference circle for Center-Weighted Metering area

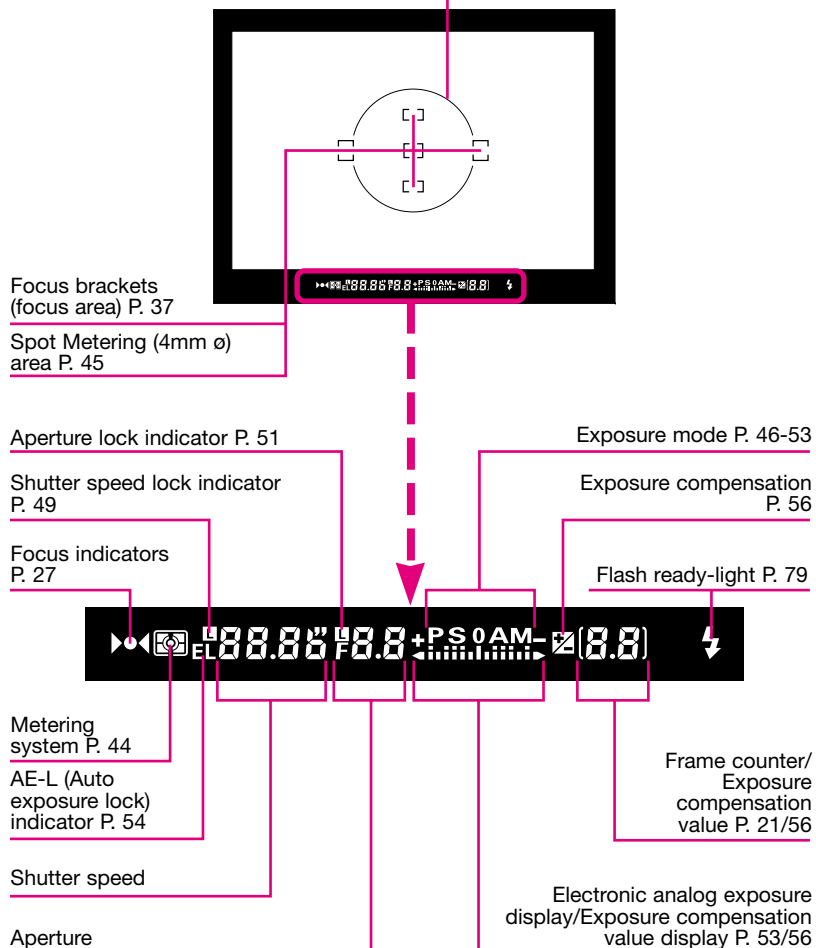

# Command Dials

■ The F100's Main- and Sub-Command Dials are used alone or in combination with other buttons to select/set various functions or modes.

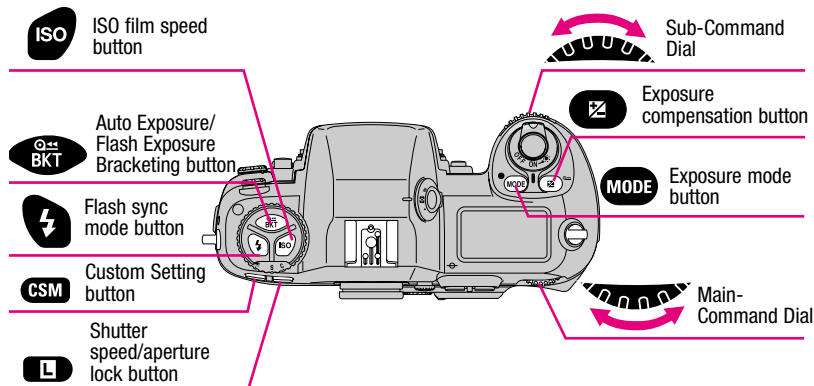

## Film

- Setting film speed

P. 34



## Exposure

- Selecting exposure mode

PP. 46-53



- Performing Flexible Program in Programmed Auto exposure mode

P. 47



- Setting shutter speed in Shutter-Priority Auto or Manual exposure mode\*1

P. 48/52



- Setting aperture in Aperture-Priority Auto or Manual exposure mode\*1

P. 50/52



- Locking/unlocking shutter speed\*1

P. 49



- Locking/unlocking aperture\*1

P. 51



- Performing exposure compensation\*2

P. 56



- Setting/canceling Auto Exposure/Flash Exposure Bracketing

P. 57



- Setting number of shots and compensated EV value in Auto Exposure/Flash Exposure Bracketing

P. 57



## Custom Setting

- Selecting menu number of Custom Setting

P. 70



- Selecting and making Custom Setting

P. 70



## Flash

- Selecting flash sync mode

P. 80



\*1 **CS** **iZ**: Shutter speed can be set to change with the Sub-Command Dial (in Shutter-Priority Auto or Manual exposure mode) and aperture with the Main-Command Dial (in Aperture-Priority Auto or Manual exposure mode) (page 73).

\*2 **CS** **iZ**: Exposure compensation can be set to be performed using the Main- or Sub-Command Dial without pressing the exposure compensation button (page 73).

# Introduction

- Thank you for purchasing the Nikon F100—a camera that you are sure to enjoy in making photography a bigger part of your life. Get to know your F100 camera, and be sure to read this manual thoroughly before using it. We recommend that you keep this manual handy.

## Main features of the F100:

- Nikon's exclusive new cross-ranged, five-area Multi-CAM1300 autofocus sensor system achieves superior performance in high-speed continuous shooting, and Dynamic AF, which also utilizes five-area autofocus, enables sharp focus on irregularly moving subjects.
- Nikon's exclusive 10-segment 3D Matrix Metering provides correct exposure in various shooting situations.
- Menu of 22 Custom Settings enables you to choose among customized combinations of various functions/modes and two Command Dials provide access to more versatile functions.
- F100's fortified die-cast body and Nikon lenses and accessories accommodate various photographic situations.

## ■ Take trial shots

Take trial shots before shooting at important occasions like weddings or graduations.

## ■ Have Nikon spot-check your camera regularly

Nikon recommends that you have your camera serviced by an authorized dealer or service center at least once every two years.

## ■ Using your camera correctly

The Nikon F100's performance has been optimized for use with Nikon brand accessories. Accessories made by other manufacturers may not meet Nikon's criteria for specifications, and nonconforming accessories could damage the F100's components. Nikon cannot guarantee the F100's performance when it is used with other than Nikon brand accessories.

Note: **CS** **00**

**CS** **00** (numbers from 1 to 22): indicates that the function/mode changes according to Custom Setting menu number.

# Contents

The “Basic Operation” section introduces battery, lens, film, focusing, exposure and shooting in basic steps easy enough even for SLR camera beginners to take pictures.

“Detailed Operation” explains each function, from lens to exposure functions, in detail, in approximately the same order as the steps in the “Basic Operation” section. After becoming familiar with basic shooting, refer to the detailed explanation of each operation/function, and start using advanced shooting techniques.

“Flash Photography” introduces flash photography using the optional Speedlight in darkness, Matrix Balanced Fill-Flash, as well as other flash-shooting applications in brightness.

## **PREPARATION .....2-13**

Nomenclature .....	2-3
LCD/Viewfinder Display .....	4-5
Command Dials .....	6-7
Introduction .....	8-9
About This Manual .....	12-13

## **BASIC OPERATION .....15-29**

1. Install Batteries and Check Battery Power .....	16-17
2. Mount Lens .....	18-19
3. Load Film .....	20-21
4. Set Focus Mode, Focus Area and AF Area Mode .....	22-23
5. Set Metering System and Exposure Mode .....	24-25
6. Hold Camera and Focus .....	26-27
7. Confirm Indications in Viewfinder and Release Shutter .....	28-29

About Metering System and Exposure.....	30
---	----

## **DETAILED OPERATION .....31-67**

Lens Compatibility .....	32-33
Film (film speed, mid-roll rewind, film advance mode, etc.) .....	34-35
Autofocus (Single Servo AF, Continuous Servo AF, AF start button) .....	36
Focus Area .....	37
AF Area Mode .....	38-39
Focus Lock (Single Servo AF, Continuous Servo AF) .....	40-41
Situations Where Autofocus May Not Work As Expected .....	42
Manual Focus .....	43

Exposure Metering System (Matrix, Center-Weighted, Spot) .....	44-45
Shooting in Each Exposure Mode.....	46-53
Programmed Auto Exposure Mode (Flexible Program, Program Chart).....	46-47
Shutter-Priority Auto Exposure Mode .....	48-49
Aperture-Priority Auto Exposure Mode .....	50-51
Manual Exposure Mode .....	52-53
Auto Exposure Lock .....	54-55
Exposure Compensation .....	56
Auto Exposure/Flash Exposure Bracketing .....	57-59
Multiple Exposure.....	60-61
Long Time Exposure.....	62
Diopter Adjustment/LCD Illuminator.....	63
Depth-of-Field Preview/Film Plane Indicator.....	64
Changing Focusing Screens.....	65
Changing Camera Back (Data Back MF-29).....	66
Self-Timer Operation .....	67

About Depth of Field and Focus Tracking.....	68
--	----

## **CUSTOM SETTING .....69-76**

Menu/Features of Custom Setting .....	70-75
Two-Button Reset .....	76

## **FLASH PHOTOGRAPHY ..... 77-85**

Types of TTL Auto Flash .....	78
Accessory Shoe/Sync Terminal/Ready-Light .....	79
Flash Sync Mode Features .....	80-81
Usable Optional Speedlights .....	82-83
Using the Speedlight.....	84-85

Combinations of AF Functions .....	86
------------------------------------	----

## **MISCELLANEOUS .....87-111**

Optional Accessories .....	88-95
Camera Care .....	96-97
Notes on Batteries .....	98
Troubleshooting .....	99-101
Specifications .....	102-107
Index.....	108-109
Custom Setting Menu .....	110-111

# About This Manual

## BASIC OPERATION

P. 15-29

**1** Install Batteries and Check Battery Power P. 16-17

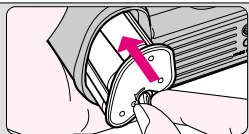

**2** Mount Lens P. 18-19

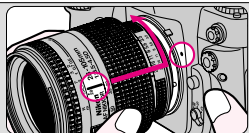

**3** Load Film P. 20-21

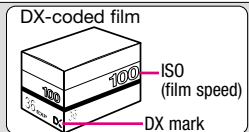

**4** Set Focus Mode, Focus Area and AF Area Mode P. 22-23

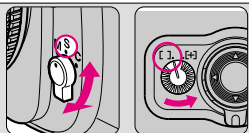

**5** Set Metering System and Exposure Mode P. 24-25

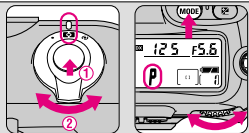

**6** Hold Camera and Focus P. 26-27



**7** Confirm Indications in Viewfinder and Release Shutter P. 28-29

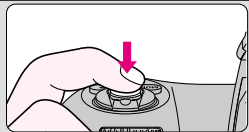

## Detailed Operation and Notes on Batteries P. 31-67, 88, 94, 98

External power source (P. 88); Notes on Batteries (P. 98)

Lens Compatibility (P. 32-33)—CPU Nikkor lens (P. 32)/Non-CPU lens (P. 33)

Film (P. 34-35)—Set/Confirm film speed (P. 34)/Mid-roll rewind (P. 34)/In case film does not start rewind or film rewind stops at mid-roll (P. 35)/Film advance mode (P. 35)

Autofocus (P. 36)—Single Servo AF, Continuous Servo AF, AF start button (P. 36); Focus Area (P. 37); AF Area Mode (P. 38-39); Focus Lock (P. 40-41)—Single Servo AF (P. 40)/Continuous Servo AF (P. 41); Situations Where Autofocus May Not Work As Expected (P. 42); Manual Focus (P. 43)—Manual focus/Manual focus with electronic rangefinder (P. 43)

Exposure Metering System (P. 44-45)—Matrix (P. 44)/Center-Weighted (P. 44)/Spot (P. 45); Shooting in Each Exposure Mode (P. 46-53)—P: Programmed Auto Exposure Mode (P. 46-47)/S: Shutter-Priority Auto Exposure Mode (P. 48-49)/A: Aperture-Priority Auto Exposure Mode (P. 50-51)/M: Manual Exposure Mode (P. 52-53); Auto Exposure Lock (P. 54-55); Exposure Compensation (P. 56); Auto Exposure/Flash Exposure Bracketing (P. 57-59); Multiple Exposure (P. 60-61); Long Time Exposure (P. 62)

Diopter Adjustment/LCD Illuminator (P. 63); Depth-of-Field Preview/Film Plane Indicator (P. 64); Changing Focusing Screens (P. 65); Changing Camera Back (Data Back MF-29) (P. 66)

Self-Timer Operation (P. 67); Remote control operation (P. 94)

Batteries

Lens

Film

Focus

Exposure

Composition

Shooting

# BASIC OPERATION

This section features the settings for most common picture-taking situations when using a D-type AF Nikkor lens (including AF-S and AF-I). The shooting modes explained in this section cover most of your shooting situations.

Shooting modes/functions explained in this section are as follows:

Lens attached	D-type AF Nikkor
Film advance mode	Single frame
AF mode	Single Servo AF
Focus area	Center*
AF area mode	Single Area AF
Exposure metering	3D Matrix Metering
Exposure mode	Programmed Auto*

\* Can be set using the Two-Button Reset. See page 76.



# Install Batteries and Check Battery Power

Use four 1.5V AA-type alkaline-manganese or lithium batteries. (See page 88 for other power sources.)

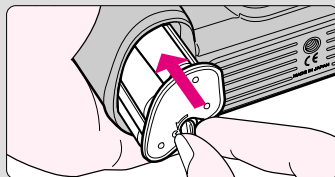

- 1.1** Turn the power switch off, and turn the battery holder release knob toward to release the lock.

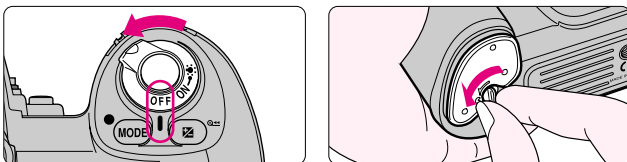

- 1.2** Remove the battery holder and insert batteries with the “+” and “-” ends positioned as marked on the battery holder.

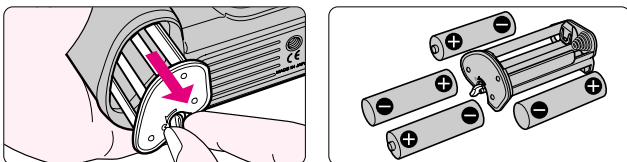

• Incorrect positioning of + and - poles may damage the camera.

- 1.3** Return battery holder to battery chamber and turn the battery holder release knob opposite to to lock the holder firmly.

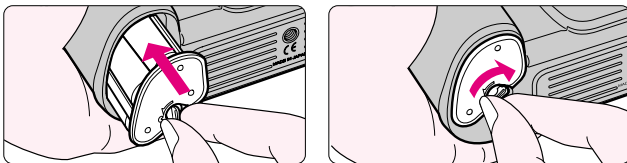

## ✓ Check points

- Keep the batteries out of children’s reach. If swallowed, contact a doctor immediately. (For “Notes on Batteries”, see page 98.)
- When replacing batteries, be sure to turn the power switch off and replace all four batteries at the same time. Always use fresh batteries of the same brand.
- We recommend that you take spare batteries with you, especially when traveling.

- 1.4** Turn the power switch on and confirm battery power with the indication.

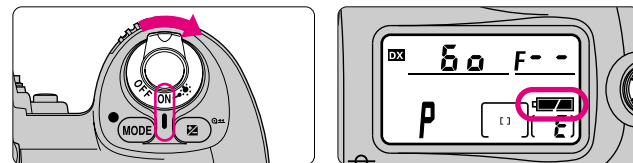

- Battery power
  - appears: Sufficient battery power.
  - appears: Batteries are nearing exhaustion. Have a fresh set ready.
  - blinks: Batteries are exhausted. Replace batteries. (Shutter locks.)
- Indications other than exposure mode, battery power, frame counter, focus area and Custom Setting (when Custom Setting is selected) in the LCD panel automatically turn off 6 sec. after the power switch is turned on and the camera remains unused. (All the indications in viewfinder turn off.)

- 1.5** Lightly press the shutter release button to activate the exposure meter.

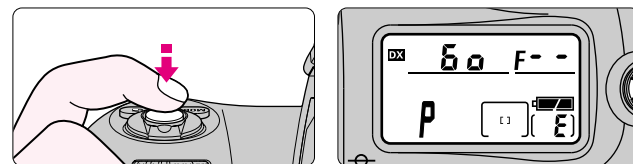

- Lightly pressing the shutter release button reactivates the exposure meter and indications in the LCD panel and viewfinder for approx. 6 sec.
- CS** **!5:** It is possible to change the duration of inactive time before automatic meter switch-off occurs (page. 74).

# Mount Lens

Turn the power switch off and mount the lens to the camera body.

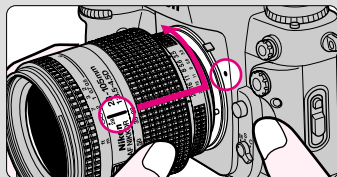

## Check points

- Use D- or G-type AF Nikkor lens to utilize all the functions of this camera. (See page 32 for Lens Compatibility.)
- Make sure to turn the power switch off when attaching/detaching the lens.
- When attaching the lens, take care not to press the lens release button.
- Avoid direct sunlight when attaching/detaching the lens.

## Check the lens type.

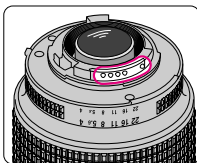

CPU contacts of CPU lens

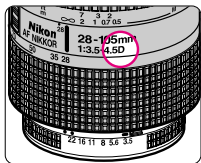

① CPU Nikkor lens other than G-type

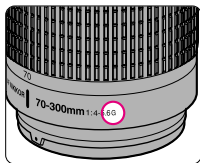

② G-type Nikkor lens

- ① CPU Nikkor lens other than G-type (Illustration is D-type Nikkor lens), with aperture ring
- ② G-type Nikkor lens, without aperture ring

## Turn the power switch off and mount the lens to the camera body.

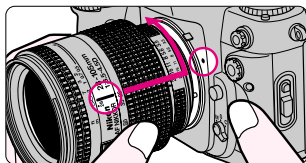
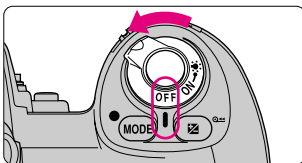

- Position lens in the camera's bayonet mount so that the mounting indexes on lens and camera body are aligned, then twist lens counterclockwise until it locks into place. (Be sure not to touch the lens release button.)
- When the lens is not attached or when a non-CPU lens (page 32) is attached and the power switch is turned on, F - - appears in the LCD panel and viewfinder. (Exposure mode indication P or S also blinks in Programmed Auto or Shutter-Priority Auto exposure mode. Page 46/48.)

## With CPU Nikkor lens with aperture ring (other than G-type), set the lens aperture to its minimum and lock.

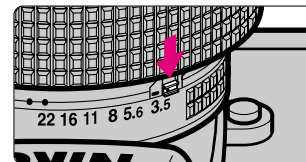
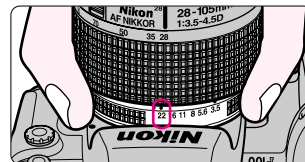

- When CPU Nikkor lens other than G-type is not set to its minimum aperture setting and the power switch is turned on, F E blinks in the LCD panel and viewfinder and the shutter cannot be released.
- With CPU Nikkor lens other than G-type, lock the lens aperture (except in case setting the aperture with the lens aperture ring) (page 75).
- The G-type Nikkor lens has no aperture ring; aperture should be selected from camera body. Unlike other CPU Nikkor lens, aperture does not need to be set to minimum.

## Detaching the lens.

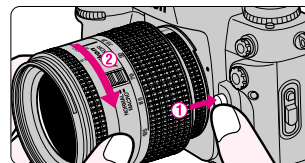

- Push and hold the lens release button ①, then turn the lens clockwise ②.

### When camera is left unattended without lens

When you leave the camera unattended without a lens attached, be sure to attach the supplied body cap (page 3), or optional body cap BF-1A. (BF-1 body cap cannot be used.)

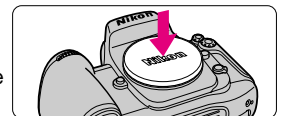

## Load Film

Turn the power switch on, set the camera's film speed setting to DX (page 34) and load DX-coded film. Film speed will be set automatically (ISO 25-5000). Close camera back and press the shutter release button to advance the film to the first frame.

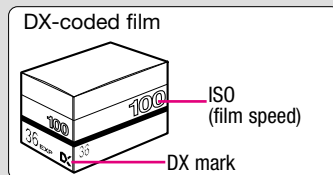

3.1

Turn the power switch on, confirm that the film speed setting is set to **DX**, then open the camera back by sliding the camera back lock release lever while pressing the camera back lock release.

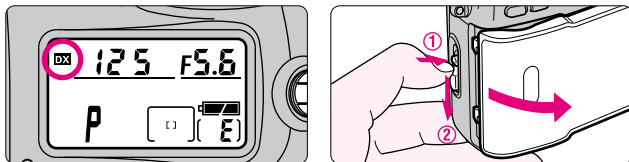

- See page 34 if the film speed setting is not set to **DX**.

3.2

Insert film from the top side and pull film leader out to red index mark.

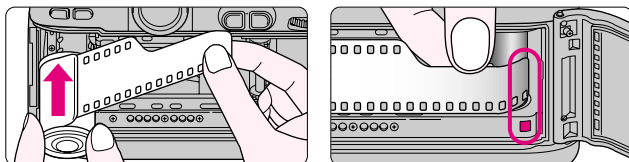

- Do not insert the film leader beyond the red index mark.

3.3

Hold the film cartridge and ensure film is properly positioned with no slack, then gently close the camera back until the camera back snaps closed.

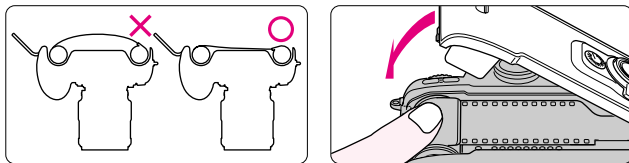

## ✓ Check points

- See page 34 for changing film speed with DX-coded film or selecting film advance mode.
- Shutter curtains are very thin. Make sure not to touch the shutter curtains with your finger or film leader.
- Avoid direct sunlight when changing film outdoors.

3.4

Press the shutter release button. Film automatically advances to the first frame.

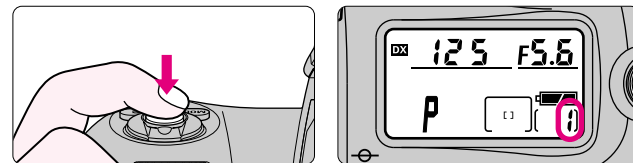

- When **1** appears on the LCD panel, the film has advanced to the first frame.
  - When **Err** and **E** blink in the LCD panel and viewfinder, film is not properly installed. Open the camera back again and reload film.
  - **ISO**, **DX** and **Err** blink and the shutter locks when a non-DX-coded film is loaded with camera film speed set to **DX**. Set film speed manually (page 34).
  - Frame number display remains when the power switch is off.
  - You can check the number of available exposures on the film roll through the film cartridge confirmation window.
- CS** **B**: Camera can be set to advance the film automatically to the first frame after the camera back is closed (page 72).

3.5

Set the film advance mode selector to **S** (single-frame shooting) while pressing the film advance mode selector lock release.

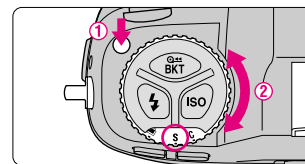

## Set Focus Mode, Focus Area and AF Area Mode

Set the focus mode to **S** (Single Servo AF), focus area to center and AF area mode to [1] (Single Area AF).

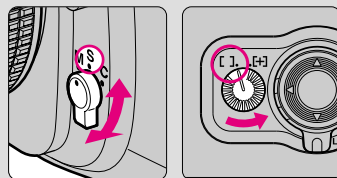

4.1

Set the focus mode selector to **S** (Single Servo AF).

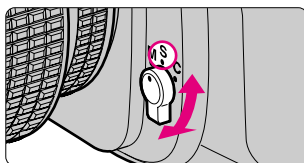

- Make sure to turn the focus mode selector until it clicks into position.
- To focus, lightly press the shutter release button (page 27) or keep pressing the AF start button (page 36).

**CS** 4: Autofocus detection can be set to start by pressing the AF start button only (page 71).

4.2

Rotate the focus area selector lock release and select center focus area with the focus area selector.

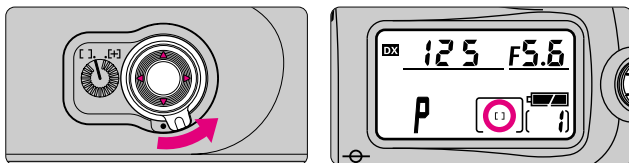

- Pressing the focus area selector up/down/right/left shifts the focus area toward the desired direction. Press the focus area selector while the exposure meter is on (page 37).
- Selected focus area is indicated in LCD panel and viewfinder (in red in the viewfinder) (page 37).

### ✓ Check points

- Do not attempt to rotate the lens focus ring manually while the focus mode is set to **S** or **C**.
- With the focus mode set at **S** (Single Servo AF), shutter cannot be released when the subject is out of focus.
- See pages 36-43 for details regarding focus mode, focus area and AF area mode.
- See page 42 for situations where autofocus may not work as expected.

4.3

Rotate the focus area selector lock release to lock focus area.

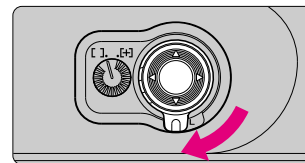

4.4

Set the AF area mode selector to [1] (Single Area AF).

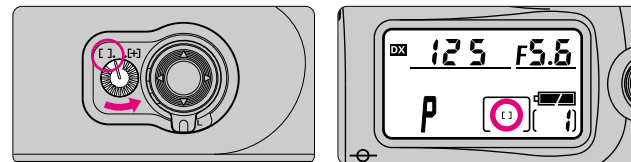

- Set the AF area mode selector firmly.

# Set Metering System and Exposure Mode

Set metering system to  (Matrix Metering) and exposure mode to P (Programmed Auto).

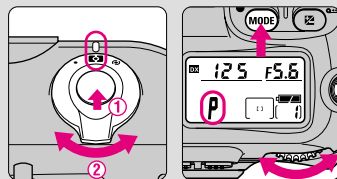

Set the metering system selector to  (Matrix Metering) while pressing the metering system selector lock release.

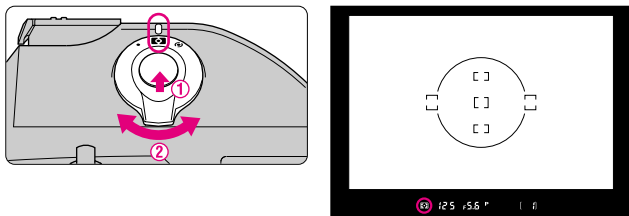

- Matrix Metering indication  appears in the viewfinder.
- The frame is divided into 10 segments in Matrix Metering, and data from each segment is used to determine correct exposure. Use of a D- or G-type AF lens automatically activates 3D Matrix Metering (page 44), which accounts for scene brightness and contrast, as well as subject distance (Distance Information) in order to determine exposure accurately.

Rotate the Main-Command Dial while pressing the exposure mode button **MODE** to set the exposure mode to P (Programmed Auto).

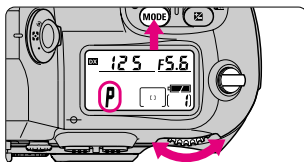

- When the shutter release button is lightly pressed, shutter speed and aperture appear in the LCD panel and viewfinder.

## ✓ Check points

- ❑ Three metering systems—the F100 features Matrix, Center-Weighted and Spot Metering (page 44).
- ❑ Four exposure modes—the F100 features Programmed Auto, Shutter-Priority Auto, Aperture-Priority Auto and Manual exposure modes. Each exposure mode provides a choice of exposure controls for various shooting situations. See step 5.2 for a summary of each exposure mode and its reference page for operating instructions and details.

## ■ Shooting characteristics of exposure modes

Symbol	Exposure mode	Shooting characteristics
P	Programmed Auto P. 46	Camera controls exposure automatically, while allowing you to make other settings, such as Flexible Program (page 47) or exposure compensation (page 56).
S	Shutter-Priority Auto P. 48	You set desired shutter speed, and the camera selects the correct aperture. “Freeze” the motion of a moving subject using a fast shutter speed or blur the subject using a slower speed.
A	Aperture-Priority Auto P. 50	You set the desired aperture, and the camera selects the correct shutter speed. Lets you determine depth of the in-focus area, so you can choose whether near or far subjects are in sharp focus, or whether foreground or background is to be blurred.
M	Manual P. 52	Shutter speed and aperture are set manually. Suitable for situations where it is difficult to attain the desired effect using other exposure modes.

# Hold Camera and Focus

Lightly pressing the shutter release button automatically focuses the camera on the subject and when the subject is in focus, causes ● to appear in the viewfinder.



## ✓ Check points

- Diopter adjustment (page 63) enables you to see more clearly through the viewfinder.
- To take a picture of a subject outside the focus area, shift the focus area by using the focus area selector (page 37) or use focus lock (page 40).
- The optional Data Back MF-29 lets you imprint date and/or time on your photos/negatives (page 92).

## 6.1 Hold the camera properly.



- Keep your elbow propped against your body for support.
- Stand with one foot forward a half step and keep your upper body still.
- Grasp the camera handgrip with your right hand and use your left hand to cradle the camera (or lens).
- The optional Multi-Power High Speed Battery Pack MB-15 (page 88) makes available a shutter release button for vertical frame shooting.

### Camera shake and shutter speed

Preventing camera shake is crucial when taking photographs. In general, you should set the shutter speed faster than '1/focal length of your lens' sec. (Example: when using a 50mm lens, set the shutter speed faster than 1/50 sec.) Use of a tripod is recommended for shooting at slower shutter speeds.

### NOTE: Composing frame

This camera's viewfinder frame shows approximately 96% of the image actually exposed on the film frame. Note that the edges of a negative film are partially cropped by most labs.

## 6.2

## Compose frame and focus by lightly pressing the shutter release button.

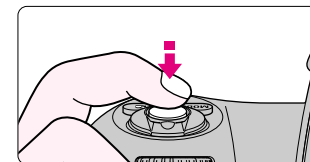

- Center the focus brackets on your subject and lightly press the shutter release button. The camera focuses automatically and focus indicator appears or blinks as follows.
  - appears: Subject is in focus.
  - ▶ appears: Camera is focused on an area between camera and subject.
  - ◀ appears: Camera is focused on an area behind the subject.
  - ▶ ◀ blinks: Unable to focus using autofocus.
- To take a picture of a subject outside the focus area, shift the focus area by using the focus area selector (page 37) or use focus lock (page 40).
- In situations where autofocus may not work as expected, see page 42.



## Confirm Indications in Viewfinder and Release Shutter

Confirm that ● (in-focus indicator) appears in the viewfinder, then slowly, fully depress the shutter release button. Camera automatically tracks subject that has been moving.

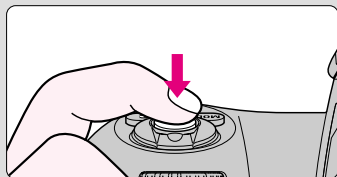

### ✓ Check points

- Focus, shutter speed and aperture can be confirmed in the viewfinder. If any other warning indications appear, see page 46.
- When you reach the end of the film roll, **End** blinks in the LCD panel. Press the two film rewind buttons **Q** and **W** simultaneously to rewind film.
- For mid-roll rewind, see page 34.
- For self-timer operation, see page 67.
- For remote control operation, see page 94.

## 7.1

Confirm indications in the viewfinder while lightly pressing the shutter release button. (Shutter speed and aperture are shown in 1/3 steps.)

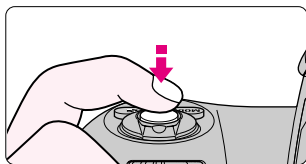

• If any warning indications appear in the LCD panel or viewfinder, see page 46.

**CS** **2**: Shutter speed and aperture can be changed to display settings in steps of 1/2 or one (page 71).

## 7.2

Confirm that focus indicator ● appears and slowly depress the shutter release button.

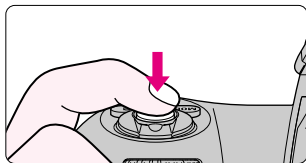

• After shutter is released, the film automatically advances to the next frame and the next shot can be taken.

## 7.3

When you reach the end of the film roll, **End** blinks in the LCD panel. Press the two film rewind buttons **Q** and **W** simultaneously for approx. 1 sec. to rewind film.

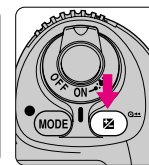
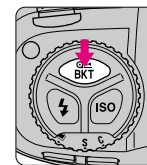
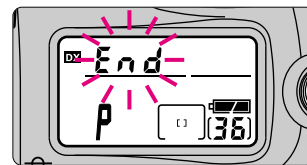

- **Q** and **W** blinks in the LCD panel during film rewind and the frame counter counts down backwards until rewind is complete.
- Pictures taken on frames beyond the indicated number of the exposures for the film roll may be discarded in the process of developing.

**CS** **1**: Film rewind can be changed to start automatically when the end of a film roll is reached (page 71).

## 7.4

Confirm that film is completely rewound, then remove film cartridge.

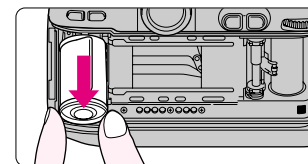
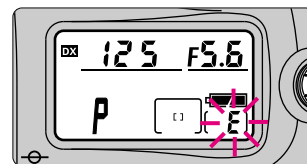

- Film is completely rewound when the frame counter shows blinking "E". (E appears without blinking when the exposure meter is off.) Open the camera back away from sunlight and remove the film cartridge by tilting it to one side.

## About Metering System and Exposure

Metering systems and exposure are important factors for taking pictures. Knowing the characteristics of each factor helps you widen your photographic expression.

### Metering System

As the proper combination of shutter speed and aperture for correct exposure is determined according to subject brightness and film sensitivity, measuring subject brightness is very important.

In general, brightness inside the viewfinder is not uniform. The F100 provides three metering systems: Matrix Metering, Center-Weighted Metering and Spot Metering. With Matrix Metering, scene brightness data is detected by the 10-segment Matrix sensor. With Center-Weighted Metering, most of the meter's sensitivity is concentrated on the 12mm-diameter center circle in the viewfinder. Spot Metering sensitivity is concentrated in a small, selected focus area from five available focus areas. Using D- or G-type Nikkor lenses, the F100 camera performs 3D Matrix Metering by adding distance information to determine correct exposure. See page 44.

### Exposure

Light from the subject passes through the lens and exposes the film. Shutter speed and aperture control how much light reaches the film. The combination of shutter speed and aperture appropriate for subject brightness and film sensitivity results in correct exposure—a result provided by the F100's four exposure modes: Programmed Auto (page 46), Shutter-Priority Auto (page 48), Aperture-Priority Auto (page 50) and Manual (page 52) exposure modes. Also, the F100 offers auto exposure lock (page 54), exposure compensation (page 56) or Auto Exposure/Flash Exposure Bracketing function (page 57) allowing a photographer greater control of exposure than that afforded by Auto exposure modes.

## DETAILED OPERATION

This section features detailed descriptions of all camera functions — including lens, film, focus, exposure and other functions.



# Lens Compatibility

- Use a CPU lens (except IX-Nikkor) with this camera. D- or G-type AF lenses give you access to all available functions.

## G-type Nikkor and other CPU Nikkor lens

- The G-type Nikkor lens has no aperture ring; aperture should be selected from camera body. Unlike other CPU Nikkor lenses, aperture does not need to be set to minimum (largest f-number).
- CPU Nikkor lenses other than G-type Nikkor lens have an aperture ring. Set the lens aperture to its minimum and lock. When the lens is not set to its minimum aperture setting and the power switch is turned on, **F E** blinks in the LCD panel and viewfinder and the shutter cannot be released.

### When a non-CPU lens is attached

Set exposure mode to **A** (Aperture-Priority Auto) or **M** (Manual) and metering system to Center-Weighted or Spot with a non-CPU lens. When other modes are selected, exposure indication (**P** or **S**) in the LCD panel blinks, exposure mode is automatically set to Aperture-Priority Auto and metering system is set to Center-Weighted . (**A** appears in the viewfinder.) With a non-CPU lens, the aperture cannot be set using the Sub-Command Dial. **F - -** appears in place of the aperture indication in the LCD panel and viewfinder; set/confirm aperture using the lens aperture ring.

## CAUTION: Nikkor lenses/accessories that cannot be attached to the F100

The following Nikkor lenses/accessories cannot be attached to the F100 (otherwise camera body or lens may be damaged):

- TC-16A Teleconverter
- Non-AI lenses
- 400mm f/4.5, 600mm f/5.6, 800mm f/8 and 1200mm f/11 with Focusing Unit AU-1
- Fisheye 6mm f/5.6, 7.5mm f/5.6, 8mm f/8 and OP 10mm f/5.6
- Old type 21mm f/4
- K1, K2 Ring, Auto Extension Ring PK-1, PK-11, Auto Ring BR-2, BR-4
- ED 180-600mm f/8 (No. 174041-174180)
- ED 360-1200mm f/11 (No. 174031-174127)
- 200-600mm f/9.5 (No. 280001-300490)
- 80mm f/2.8, 200mm f/3.5 and TC-16 Teleconverter for F3AF
- PC 28mm f/4 (No. 180900 or smaller)
- PC 35mm f/2.8 (No. 851001-906200)
- Old type PC 35mm f/3.5
- Old type Reflex 1000mm f/6.3
- Reflex 1000mm f/11 (No. 142361-143000)
- Reflex 2000mm f/11 (No. 200111-200310)

- Types of CPU lenses and other usable lenses/accessories

Lens/accessories	Mode			Focus mode		Exposure mode		Metering system		
	Autofocus	Manual with electronic rangefinder	Manual	P S	A M	Matrix		Center-Weighted, Spot*1		
						3D 10-segment	10-segment			
CPU Nikkor*2	D-type AF Nikkor*3, G-type AF Nikkor, AF-S, AF-I Nikkor	○	○	○	○	○	○	—	○	
	PC Micro 85mm f/2.8D*4	—	○*5	○	—	○*6	○	—	○	
	AF-S/AF-I Teleconverter*7	○*8	○*8	○	○	○	○	—	○	
	Non-D/G-type AF Nikkor (except AF Nikkor for F3AF)	○	○	○	○	○	—	○	○	
AI-P Nikkor	—	○*9	○	○	○	—	○	○		
Non-CPU Nikkor*10	AI-S or AI type Nikkor, Series-E, AI-modified Nikkor	—	○*9	○	—	○	—	—	○	
	Medical-Nikkor 120mm f/4	—	○	○	—	○*11	f/4	—	—	
	Reflex-Nikkor	—	—	○	—	○	—	—	○	
	PC-Nikkor	—	○*5	○	—	○*12	—	—	○	
	AI-S or AI type Teleconverters	—	○*8	○	—	○	—	—	○*13	
	Bellows Focusing Attachment PB-6*14	—	○*8	○	—	○*15	—	—	○	
Auto Extension Rings (PK-11A, PK-12, PK-13 and PN-11)	—	○*8	○	—	○	—	—	○		

\*1 Spot Metering area can be shifted with focus area selector (page 45) with CPU Nikkor lens.

\*2 IX-Nikkor lenses cannot be attached.

\*3 This camera is compatible with the Vibration Reduction function of the VR Nikkor lens.

\*4 The camera's exposure metering and flash control system do not work properly when shifting and/or tilting the lens, or when using an aperture other than the maximum aperture.

\*5 Without shifting and/or tilting the lens.

\*6 With exposure mode set to Manual.

\*7 Compatible with AF-S and AF-I Nikkor except AF-S 17-35mm f/2.8D IF-ED, AF-S 24-85mm f/3.5-4.5G IF-ED and AF-S 28-70mm f/2.8D IF-ED.

\*8 With maximum effective aperture of f/5.6 or faster.

\*9 With maximum aperture of f/5.6 or faster.

\*10 Some lenses/accessories cannot be attached. (See page 32.)

\*11 With exposure mode set to Manual and shutter speed set to 1/125 sec. or slower.

\*12 By stop-down metering. In Aperture-Priority Auto exposure mode, exposure is determined by presetting lens aperture. Exposure must also be determined before shifting; use AE-L/AF-L button before shifting. In Manual exposure mode, exposure is determined by presetting lens aperture. Exposure must also be determined before shifting.

\*13 Exposure compensation is necessary with Ai 28-85mm f/3.5, Ai 35-105mm f/3.5-4.5, Ai 35-135mm f/3.5-4.5 or AF-S 80-200mm f/2.8D lens. See the instruction manual of the teleconverter for details.

\*14 Attach the PB-6 vertically. (PB-6 can be set to horizontal position after attaching.)

\*15 By stop-down metering. In Aperture-Priority Auto exposure mode, exposure is determined by stopping down aperture on the bellows. Exposure must also be determined before shooting.

- Reprocopy Outfit PF-4 can be attached in combination with Camera Holder Adapter PA-4.

## ■ Setting and confirming film speed

Rotate the **Main-Command Dial** while pressing the film speed **ISO** button to set film speed in use.

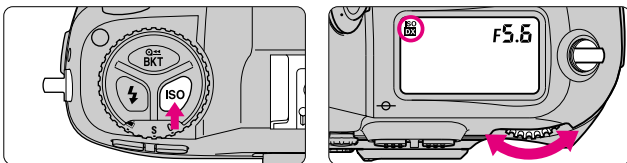

- Film speed can be set to **DX** and between ISO 6-6400 in 1/3 steps by rotating the Main-Command Dial.
- When film speed is set to **DX** and DX-coded film is installed, film speed is automatically set between ISO 25-5000. Film speed can also be set manually with DX-coded film to have an effect of increased or decreased film sensitivity.
- Film speed can be set between ISO 6-6400 with non-DX-coded film.
- Press the **ISO** button to confirm the film speed set on the camera.

**CS 5:** When film speed is set to **DX** and non-DX-coded film is loaded, **ISO**, **DX** and **Err** blink in the LCD panel after film is advanced to the first frame. This warning indication can be changed to appear when the power switch is turned on (page 71).

## ■ Mid-roll rewind

To rewind film at mid-roll, press the two film rewind buttons **⏮** simultaneously for approx. 1 sec.

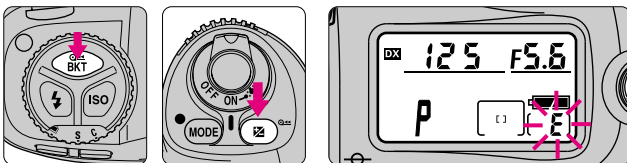

- **⏮** blinks in the LCD panel during film rewind and the frame counter counts backwards until rewind is complete.
- Film is completely rewound when the frame counter shows blinking "E". (E appears without blinking when the exposure meter is off.) Open the camera back and remove the film cartridge.

## ■ If film does not start to rewind or film rewind stops at mid-roll

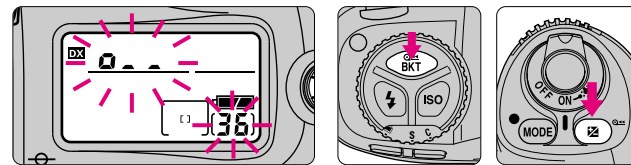

- When battery power is very low, or at low temperatures, film may not start rewinding or film rewind may stop at mid-roll, and **⏮** and frame number will blink in the LCD panel. In this case, turn the power switch off, change batteries, then turn the power switch on and rewind film again.

## ■ Film advance mode

Rotate the film advance mode selector while pressing the film advance mode selector lock release to select film advance mode.

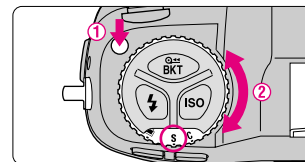

- The following film advance modes are available:
  - S:** **Single-frame shooting**  
Fully depressing the shutter release button takes one picture and automatically advances the film by one frame.
  - C:** **Continuous shooting**  
Shots are taken continuously at the rate of up to approx. 4.5 fps as long as you keep the shutter release button fully depressed.
  - Cs:** **Continuous silent-low-speed shooting**  
Shots are taken continuously at the rate of up to approx. 3 fps as long as you keep the shutter release button fully depressed. Film rewind speed also slows down and there is little rewind noise.

Film advance speed is tested using camera settings of focus mode **C**, exposure mode **M**, shutter speed 1/250 sec. or faster, aperture other than maximum, at normal temperature of 20°C (68°F), with AA-type alkaline-manganese batteries, for the first to 36th frames of a film.

- When the film advance mode selector is set to **☐**, multiple exposure can be performed (page 60). Also, when it is set to **☺**, self-timer operation can be performed (page 67).
- When the batteries are exhausted, film advance speed slows down since film advance automatically switches to start after the mirror is all the way down. (Normally, film advance starts immediately when the mirror starts to go down.) In this case, battery change is recommended.

# Autofocus

- Set focus mode selector to **S** or **C** for autofocus operation.

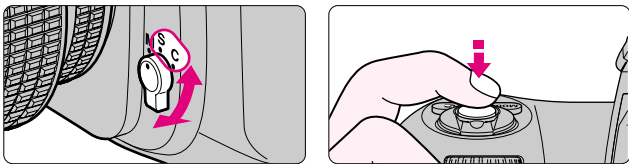

- Set focus mode selector to **S** (Single Servo AF with Focus-Priority) or **C** (Continuous Servo AF with Release-Priority). Camera continues to focus automatically on the subject when the shutter release button is lightly pressed.

## S: Single Servo AF with Focus-Priority

The shutter can only be released when in focus indicator ● appears in the viewfinder (Focus-Priority). Once focused on a subject, keeping the shutter release button lightly pressed locks focus (Focus Lock). With a subject that has been moving, the camera continuously focuses on a subject as long as the shutter release button is kept lightly pressed (Focus Tracking, page 68) and focus locks when the subject stops moving.

## C: Continuous Servo AF with Release-Priority

Since the priority is on shutter release, you can release the shutter regardless of the focus status (Release-Priority). Focus is not locked when ● appears in the viewfinder and the camera continues to focus on a subject until shutter release. With a moving subject, the camera continuously focuses on a subject as long as the shutter release button is kept lightly pressed (Focus Tracking, page 68).

- AF start button

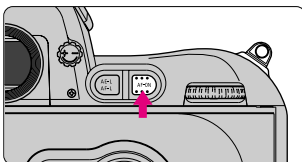

- Like lightly pressing the shutter release button, pressing the AF start **AF-ON** button automatically activates autofocus in autofocus operation.

**CS 4:** Autofocus detection can be set to start by pressing the **AF-ON** button only (not by lightly pressing the shutter release button) (page 71).

# Focus Area

- This camera's five focus areas cover a wide frame area, and you can select among them, depending on the subject's position in the frame or your desired composition. They reliably provide sharp focus without use of focus lock.

**Rotate the focus area selector lock release to release the lock, then select desired focus area with the focus area selector.**

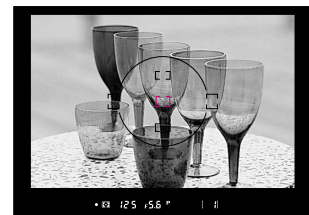
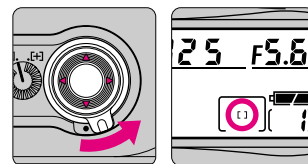

- Lightly press the shutter release button and press the focus area selector up/down/right/left to change the focus area toward the corresponding direction. Selected focus area is indicated in red in the viewfinder. Selected focus area is also indicated in LCD panel.
  - Selected focus area can be locked by rotating the focus area selector lock release to lock position.
  - Focus area can also be changed with the optional focusing screen.
- CS 5:** Focus area position can be set to change continuously in the same direction. For example, when the top of the focus area selector is pressed, focus area continues to change from top, bottom, middle and so on. With this option, focus area can be switched to the opposite position without pressing the opposite position on the focus area selector (page 72).

# AF Area Mode

- Autofocus operation lets you select Single Area AF that uses one focus area selected or Dynamic AF that also utilizes the other four focus areas.

## Rotate AF area mode selector to select AF area mode.

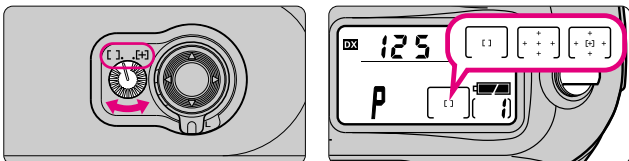

- SA appears when the Single Area AF is selected and SA or DA appears when Dynamic AF is selected in the LCD panel.

### [ SA ]: Single Area AF

With Single Area AF, only the focus brackets selected among five focus areas is used for autofocus. This mode is useful for achieving accurate focus on a selected focus brackets when shooting a relatively stationary subject.

### [ DA ]: Dynamic AF

In Dynamic AF, you designate the primary sensor (the first to detect the subject), then if the detected subject moves, Dynamic AF automatically shifts to the next sensor that detects the subject, then the next again, shifting among the progression of sensors as the subject moves. Dynamic AF thereby follows and maintains accurate focus even on subjects that move irregularly. (Viewfinder indication does not change as sensoring shifts in Dynamic AF mode.) Dynamic AF Mode with Closest Subject Priority can also be activated in Dynamic AF mode. See next page.

### Dynamic AF Mode with Closest Subject Priority

- The Closest Subject Priority AF operation is possible in the Dynamic AF, where the camera automatically selects the focus area with the closest subject. Focus is always achieved at any of the five focus areas so you can avoid out-of-focus pictures.
- In Dynamic AF Mode with Closest Subject Priority, focus area indication does not appear in the LCD panel and viewfinder.
- When the telephoto lens is attached or the subject is very dark, the closest subject may not be selected. In this case, use Single Area AF.

CS 9, iG: Dynamic AF Mode with Closest Subject Priority can be set to be cancelled in Single Servo AF in CS 9 or activated in Continuous Servo AF in CS iG (page 72).

### Autofocus modes

	Focus mode	Focus area	AF Area mode	Dynamic AF Mode with Closest Subject Priority	LCD panel	Focus area indication
I	Single Servo AF	Selectable	Single Area AF	—	[ SA ]	Appears
II	Single Servo AF	Automatically selected	Dynamic AF	Activated in initial setting	[ DA ]	Does not appear
III	Single Servo AF	Selectable	Dynamic AF	Cancelable with CS 9	[ DA ]	Appears
IV	Continuous Servo AF	Selectable	Single Area AF	—	[ SA ]	Appears
V	Continuous Servo AF	Selectable	Dynamic AF	Not activated in initial setting	[ DA ]	Appears
VI	Continuous Servo AF	Automatically selected	Dynamic AF	Activated with CS iG	[ DA ]	Does not appear

- See page 86 for the combinations of AF functions.

# Focus Lock

Focus lock is useful in autofocus shooting when you want to capture a subject that's framed outside of the F100's five focus areas, and in situations where autofocus may not work as expected (page 42).

## 1 Position the focus area on the subject and lightly press the shutter release button.



• ● appears when the subject is in focus.

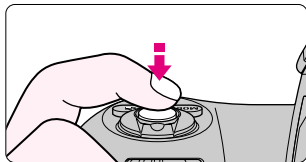



## 2 Confirm focus indicator ● and lock focus.

Focus lock is operated differently in Single Servo AF or Continuous Servo AF.

### In Single Servo AF:

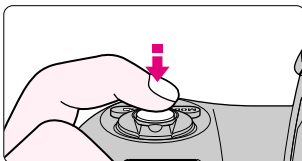
Focus is locked as long as the shutter release button is kept lightly pressed.





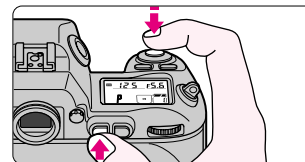

• Focus can also be locked by pressing the  button.

### In Continuous Servo AF

Confirm focus indicator ● then (while keeping shutter release button lightly pressed) press the  button.



• Focus is locked as long as the  button is kept pressed, even if you remove your finger from the shutter release button. In Auto Exposure mode, exposure is also locked in this case (page 54).

 : Only focus can be set to lock when  button is pressed (page 75).

## 3 While keeping the focus locked, recompose and shoot.

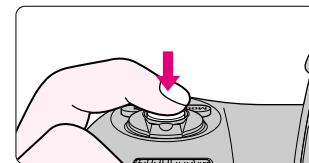

- After you have locked focus, do not change the camera-to-subject distance. Otherwise, refocus and lock the focus again.
- If you keep the shutter release button lightly pressed after releasing the shutter in Single Servo AF, the shutter can be released repeatedly with the same focusing. Similarly, if you keep the  button pressed after releasing the shutter, the shutter can be released repeatedly with the same focusing.

# Situations Where Autofocus May Not Work As Expected

- Autofocus may not work as expected in the following situations. In such situations, focus manually using the clear matte field (page 43) or focus using the method described.



## Very dark subject

Autofocus is possible when an optional Speedlight with the AF-Assist Illuminator (page 92) is used and center focus brackets are selected as the focus area.

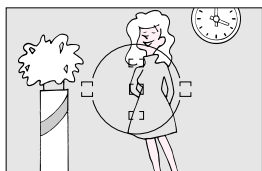

## Low-contrast scenes

For example, where the subject is wearing the same color clothing as a wall or other background.

- Focus on a different subject located at the same distance, use focus lock (page 40) then recompose.



## Scenes with subjects within the focus brackets located at different distances from the camera

For example, when shooting an animal in a cage or a person in a forest.

- Focus on a different subject at the same camera-to-subject distance, use focus lock (page 40), then recompose.

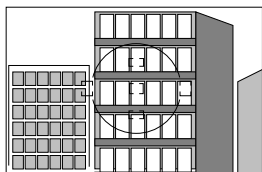

## Patterned subject or scene

For example, building windows.

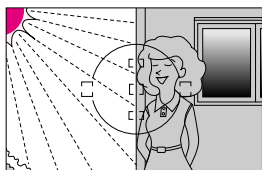

## Scenes with pronounced differences in brightness within the focus brackets

For example, when the sun is in the background and the main subject is in shadow.

# Manual Focus

- Focus can be set manually when the focus mode selector is set to **M**.

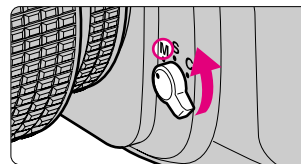

- Set the focus mode selector to **M**. Look through the viewfinder and rotate the lens focusing ring until a sharp image appears on the clear matte field in the viewfinder. The shutter can be released whether or not the subject is in focus, and ● does not appear in the viewfinder.

Use Manual focus in situations where autofocus may not work as expected (page 42) or a lens other than an AF Nikkor (page 33) is attached.

- Manual focus using Electronic Rangefinder



- Set the focus mode selector to **M**. The focus can be confirmed with ● indication in the viewfinder. The Electronic Rangefinder works with most Nikkor lenses (including AF Nikkors when operated manually) having a maximum aperture of f/5.6 or faster.
- Lightly press the shutter release button and while the meter is on, rotate the lens focusing ring until ● appears in the viewfinder. The shutter can be released anytime. Electronic Rangefinder can be activated with any of five focus brackets selected as the focus area (page 37).
- If ► appears in the viewfinder, focus region is in front of the subject. If ◀ appears in the viewfinder, focus region is behind the subject. In either case, rotate the lens focusing ring until ● appears.

# Exposure Metering System

■ Three choices of the metering system are available to suit the lighting for your subject.

**Rotate the metering system selector while pressing the metering system lock release to select desired metering system.**

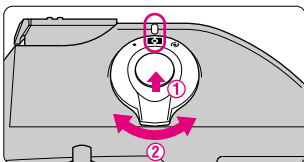

- Certain metering systems cannot be used with some lenses (page 33).
- Metering systems and characteristics of each are as follows:

## Matrix Metering/3D Matrix Metering

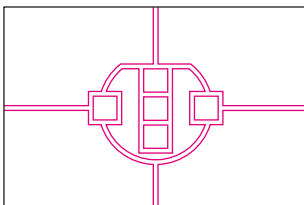

Matrix Metering provides correct exposure control using a 10-segment Matrix Sensor. With D- or G-type Nikkor lenses, 10-segment 3D Matrix Metering automatically activates, applying scene brightness, scene contrast and subject distance information to ensure even more accurate exposure control. Center-Weighted or Spot Metering is recommended for the Auto Exposure Lock function (page 54) or exposure compensation (page 56).

## Center-Weighted Metering

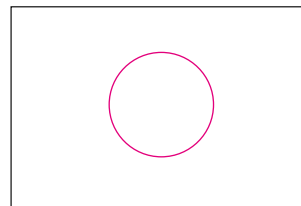

Center-Weighted Metering places special emphasis on brightness within the 12mm-diameter circle in the viewfinder, so it is useful for basing exposure on a specific area of the scene.

## Spot Metering

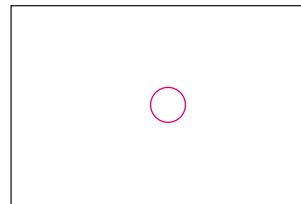

Nearly 100% of the meter's sensitivity is concentrated on the 4mm-dia. area (approx. 1% of entire frame) within the selected focus area of the viewfinder. Use Spot Metering when you want to base the exposure on a very small area within the frame, such as with a backlit subject or low-contrast scenes. When Spot Metering is selected, shifting focus area also shifts Spot Metering area to a corresponding position. However, Spot Metering area stays at center (does not shift) as long as Dynamic AF Mode with Closest Subject Priority (page 39) is activated or non-CPU lens (page 32) is attached.



# Shooting in Each Exposure Mode

## ■ P: Programmed Auto

The camera automatically controls exposure according to the exposure combination in the program chart for exposure that is correct for any shooting situation. For more complex shooting, use Flexible Program, exposure compensation (page 54) or exposure bracketing (page 57).



- Programmed Auto can only be selected when using a CPU lens.

### 1 Rotate the Main-Command Dial while pressing the exposure mode **MODE** button to select P.

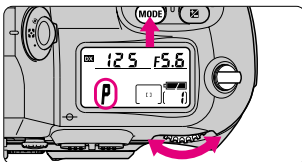

- When CPU Nikkor lens other than G-type is not set to its minimum aperture setting, **FEE** blinks in the LCD panel and viewfinder and the shutter locks.
- When a non-CPU lens is attached, exposure mode automatically switches to Aperture-Priority Auto. **P** blinks in the LCD panel and **A** appears in the viewfinder. Set/confirm aperture with the lens aperture ring since **F-** appears instead of the aperture value in the LCD panel and viewfinder.

### 2 Compose picture, focus and shoot.

- When the subject is too dark or bright, one of the following warning indications will appear in the viewfinder or LCD panel.
  - **H i**: Use ND filter.
  - **L o**: Use Speedlight.

**CS** **z**: Shutter speed/aperture value displayed in the LCD panel and viewfinder can be set to change in steps of 1/2 or one (page 71).

#### NOTE: Flexible Program

In Programmed Auto, by rotating the Main-Command Dial you can change the combination of shutter speed and aperture while maintaining correct exposure. With this function, you can shoot in Programmed Auto as though you were shooting in Shutter-Priority Auto or Aperture-Priority Auto. \* appears in the LCD panel when the Flexible Program is used. To cancel the Flexible Program, rotate the Main-Command Dial until \* disappears, change the exposure mode, turn the power switch off, or perform Two-Button Reset (page 76).

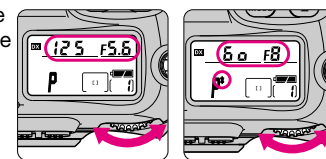

#### Program chart

The program chart shows exposure control in Programmed Auto exposure mode.

— With ISO 100, lens with maximum aperture of f/1.4 and minimum aperture of f/16 (e.g. AF 50mm f/1.4D).

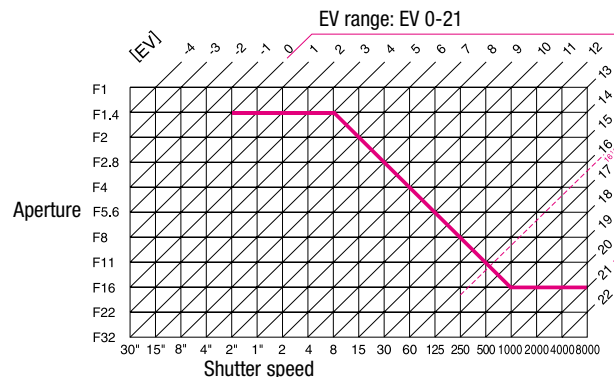

- There are limitations for minimum and maximum EV depending on the film speed.
- In Matrix Metering, any EV above 16 $\frac{1}{3}$  is controlled to EV 16 $\frac{1}{3}$  when using ISO 100 film.



# Shooting in Each Exposure Mode—continued

## ■ 5: Shutter-Priority Auto

Enables you to manually set your desired shutter speed (30-1/8000 sec.); the camera automatically selects the proper aperture to provide correct exposure. With high shutter speeds, you can freeze the motion of a fast-moving subject; with slower speeds, you can create a blurry, motion effect.



- Shutter-Priority Auto can only be selected with CPU lens.

### 1 Rotate the Main-Command Dial while pressing the exposure mode **MODE** button to select 5.

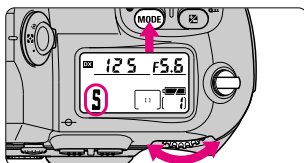

- When CPU Nikkor lens other than G-type is not set to its minimum aperture setting, **fE E** blinks in the LCD panel and viewfinder, and shutter locks.
- When a non-CPU lens is attached, exposure mode automatically switches to Aperture-Priority Auto. **S** blinks in the LCD panel and **A** appears in the viewfinder. Set/confirm aperture with the lens aperture ring since **F - -** appears instead of the aperture value in the LCD panel and viewfinder.

### 2 Set the shutter speed by rotating the Main-Command Dial.

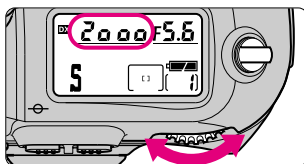

**CS** **12**: Shutter speed can be set to change with Sub-Command Dial (page 73).

### Locking shutter speed

To lock the shutter speed set in step 2, rotate the Main-Command Dial while pressing the shutter speed/aperture lock button **L** so shutter speed lock indication **L** appears in the LCD panel and viewfinder. To release the lock, rotate the Main-Command Dial while pressing the shutter speed/aperture lock button **L** so shutter speed lock indication **L** disappears in the LCD panel and viewfinder.

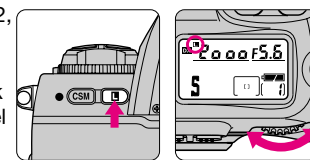

### 3 Compose picture, focus and shoot.

- When the subject is too dark or bright, one of the following warning indications will appear in the LCD panel or viewfinder. (Electronic analog exposure display will also indicate the amount of under- or overexposure.)
  - **H i**: Select higher shutter speed. If the warning indication still remains on, use ND filter.
  - **L a**: Select a slower shutter speed. If the warning indication still remains on, use Speedlight.
- CS** **2**: Shutter speed/aperture value displayed in the LCD panel and viewfinder can be set to change in steps of 1/2 or one (page 71).

# Shooting in Each Exposure Mode—continued

## ■ A: Aperture-Priority Auto

Enables you to set the desired aperture manually. The camera automatically selects a shutter speed suitable for correct exposure. By varying the aperture, and thus controlling the depth of field, you can sharpen the background and foreground, or blur the background. In flash photography, varying the aperture changes the flash shooting distance (page 85).



### 1 Rotate the Main-Command Dial while pressing the exposure mode **MODE** button to select **A**.

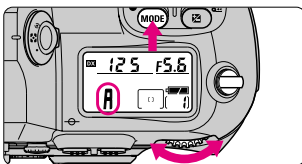

- When CPU Nikkor lens other than G-type is not set to its minimum aperture setting, **FEE** blinks in the LCD panel and viewfinder, and the shutter locks.
- When a non-CPU lens is attached, set/confirm aperture with the lens aperture ring since **F-** appears instead of the aperture value in the LCD panel and viewfinder.

**CS** **i2**: Aperture can be set to change only with the lens aperture ring (page 75).

### 2 Set the aperture by rotating the Sub-Command Dial.

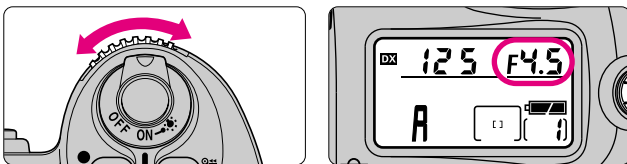

**CS** **i2**: Aperture can be set to change with Main-Command Dial (page 73).

### Locking aperture

To lock aperture set at step 2, rotate the Sub-Command Dial while pressing the shutter speed/aperture lock button **L** so aperture lock indication **L** appears in the LCD panel and viewfinder. To release the lock, rotate the Sub-Command Dial while pressing the shutter speed/aperture lock button **L** so aperture lock indication **L** disappears in the LCD panel and viewfinder.

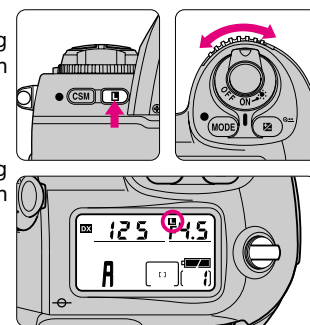

### 3 Compose picture, focus and shoot.

- When the subject is too dark or too bright, one of the following warnings will appear in the LCD panel and viewfinder. (Electronic analog exposure display will also indicate the amount of under- or overexposure.)
  - **H i**: Select smaller aperture (larger f-number). If the warning indication persists, use an ND filter.
  - **L a**: Select larger aperture (smaller f-number). If the warning indication persists, use the Speedlight.
- CS** **i2**: Shutter speed/aperture value displayed in the LCD panel and viewfinder can be set to change in steps of 1/2 or one (page 71).

# Shooting in Each Exposure Mode—continued

## M: Manual

Enables you to set both shutter speed and aperture manually. With electronic analog exposure display in the viewfinder, you can produce various creative effects by adjusting the exposure. Long Time Exposure (Bulb) can be set in Manual exposure mode.



- 1 Rotate the Main-Command Dial while pressing the exposure mode **MODE** button to select **M**, then compose picture.

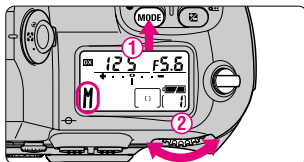

- When CPU Nikkor lens other than G-type is not set to its minimum aperture setting, **FEE** blinks in the LCD panel and viewfinder, and the shutter cannot be released.
  - When a non-CPU lens is attached, set/confirm aperture with the lens aperture ring since **F--** appears instead of the aperture value in the LCD panel and viewfinder.
- CS** 22: Aperture can be set to change only with the lens aperture ring (page 75).

- 2 Set the shutter speed and aperture and confirm by looking at the electronic analog exposure display in the viewfinder.

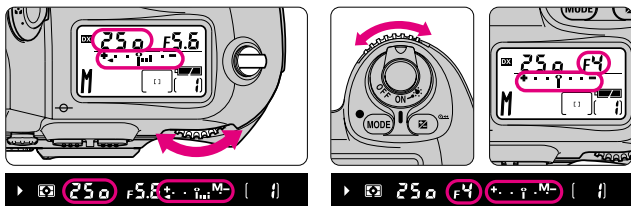

- Set the shutter speed by rotating the Main-Command Dial and the aperture by rotating the Sub-Command Dial. These functions can be set independently.
  - Long Time exposure (Bulb) can be set by setting the shutter speed to **bulb** (page 62).
  - When the shutter speed is set to 1/250 sec., the shutter can be released with the camera back open.
  - The shutter speed and aperture can be locked (pages 49 and 51).
- CS** 12: Shutter speed can be set to change with the Sub-Command Dial and aperture with the Main-Command Dial (page 73).
- CS** 2: Shutter speed/aperture value displayed in the LCD panel and viewfinder can be set to change in steps of 1/2 or one (page 71).

### Electronic analog exposure display

The following examples show electronic analog exposure display indications.

The electronic analog exposure display blinks when the subject brightness is beyond camera's exposure range.

In 1/3 EV steps	In 1/2 EV steps	In one EV steps
Correct exposure + . . .   . . . -	Correct exposure + . . .   . . . -	Correct exposure + . . .   . . . -
-2/3 EV + . . .   . . . -	-1/2 EV + . . .   . . . -	-1 EV + . . .   . . . -
Over +2 EV + <        . . . -	Over +3 EV + <        . . . -	Over +3 EV + <        . . . -

- 3 Compose picture, focus and shoot.

### Exposure factor with AF Micro-Nikkor lens

When an AF Micro-Nikkor lens is attached and you're setting aperture using Sub-Command Dial aided by an external exposure meter, you do not need to take the exposure factor into consideration. Exposure compensation is required only when setting aperture using the lens aperture ring.

# Auto Exposure Lock

- When you want to control the exposure of a specific area within a scene, measure the exposure on the area with Spot or Center-Weighted Metering, press the **AE-L** button to lock the exposure, then recompose the picture. Set exposure to a mode other than Manual.

## 1 Rotate the metering system selector while pressing the metering system selector lock release to select Center-Weighted or Spot Metering.

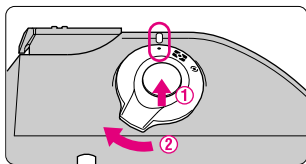

- Matrix Metering is not recommended since the exposure cannot be properly locked.

## 2 Position focus area on subject and lightly press the shutter release button, then press the **AE-L** button. Confirm focus indicator ● appears in the viewfinder.

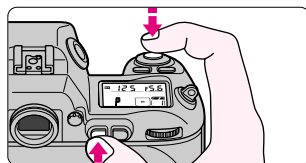

- When the **AE-L** button is pressed, exposure at the area of selected metering system is locked and remains locked as long as the button is kept pressed.
- When the **AE-L** button is pressed, **EL** appears in the viewfinder.
  - When the focus area and metering area are linked in Spot Metering (page 45), exposure is locked at selected focus area.
  - When the focus area and metering area are not linked in Spot Metering (page 45), exposure is locked at center focus area.

- When the Center-Weighted Metering is selected, exposure at 12mm-diameter circle is locked.

- In Single Servo AF or Continuous Servo AF, focus is also locked simultaneously (page 40). Make sure to confirm focus indicator ● appears in the viewfinder.

**CS 2 f**: Only exposure can be set to be locked when the **AE-L** button is pressed (page 75).

## 3 While keeping the **AE-L** button pressed, recompose, focus and shoot.

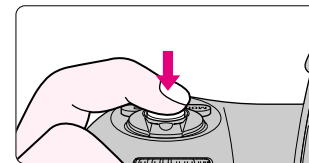

- The following functions can be operated while the **AE-L** button is kept pressed:
  - Flexible Program (page 47) in Programmed Auto Exposure mode
  - Shutter speed adjustment in Shutter-Priority Auto Exposure mode
  - Aperture adjustment in Aperture-Priority Auto Exposure mode
 In any of these three situations, controlled shutter speed and/or aperture will be displayed after change.

**CS 7**: Auto Exposure Lock can be set to be activated by lightly pressing the shutter release button (page 72).

**CS 2 f**: Auto Exposure Lock can be set to remain after you remove your finger from the **AE-L** button. In this case, AE lock is released when the **AE-L** button is pressed again (page 75).

■ To modify exposure control (i.e. from the ISO standard), use the exposure compensation function. This can be useful when the subject has pronounced contrast or when bracketing exposure with color slide film (where the latitude of the proper exposure is minimal). Use Center-Weighted or Spot Metering. Exposure compensation can be performed in any exposure mode.

## 1 Set exposure compensation by rotating the Main-Command Dial while pressing the **[Z]** button until the desired compensation value appears (-5 EV to +5 EV in 1/3 steps).

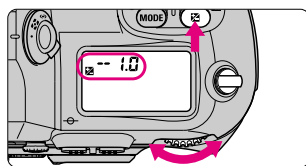

Electronic analog exposure display

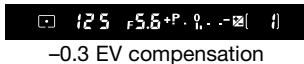

- When the exposure compensation is set, **[Z]** appears in the LCD panel and viewfinder. The compensation value can be checked by pressing the **[Z]** button.
- Electronic analog exposure display indicates the exposure compensation value and **0** blinks.
- Normally, you should compensate exposure to the + side when the background is brighter than your main subject, or to the - side when the background is darker.
- [CS]** **[Z]**: Compensation value can be set to be changed in 1/2 or one steps (page 71).
- [CS]** **[Z]**: Exposure compensation can be set to be performed using the Main- or Sub-Command Dial without pressing the exposure compensation button (page 73).

## 2 Compose picture, focus and shoot.

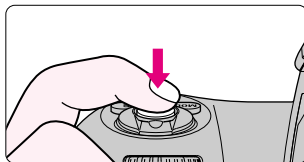

- To cancel exposure compensation, rotate the Main-Command Dial while pressing the **[Z]** button to reset the compensation value to **0.0**. Alternately, you can perform Two-Button Reset (page 76). (Turning the power switch off does not cancel the exposure compensation function.)

■ Auto Exposure/Flash Exposure Bracketing allow you to shoot in selected compensated EV value (maximum of  $\pm 2$  EV) shifting from the automatically set proper exposure (selected exposure in Manual exposure mode) for a selected number of shots (maximum of three) each time the shutter is released. Auto Exposure/Flash Exposure Bracketing can be performed in any exposure mode.

## 1 Rotate the Main-Command Dial while pressing the Auto Exposure/Flash Exposure Bracketing **[BKT]** button so **[BKT]** appears in the LCD panel.

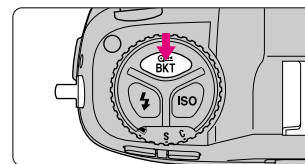

- Shutter speed and aperture in Programmed Auto, aperture in Shutter-Priority Auto and shutter speed in Aperture-Priority Auto and Manual exposure mode differ.
- In any of the exposure modes, Flash Exposure Bracketing (in which the TTL Auto Flash level of the lighted main subject is shifted) and Auto Exposure Bracketing (in which the exposure of a background lighted by ambient light is shifted) are simultaneously performed when a Speedlight is used.
- [CS]** **[BKT]**: Bracketing can be set to perform only Auto Exposure Bracketing or Flash Exposure Bracketing where both are normally performed simultaneously (page 73).

## 2 Set the number of shots and compensated EV value by rotating the Sub-Command Dial while pressing the Auto Exposure/Flash Exposure Bracketing **[BKT]** button.

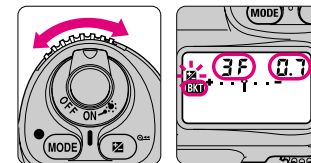
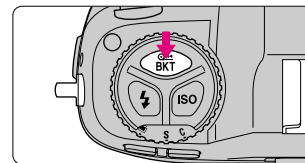

- See the table on the next page for the combinations of the number of shots and compensated EV value.
- [CS]** **[Z]**: Compensation value can be set to change in steps of 1/2 or one (page 71).

- Rotating the Sub-Command Dial while pressing the Auto Exposure/Flash Exposure Bracketing button  changes the setting as follows (when compensation value is set in steps of 1/3, 1/2 or one with Custom Setting):

## 1. With 1/3 steps

Number of shots and compensated EV value	Electronic analog exposure display	Shooting order
+2F0.3		0, +0.3
+2F0.7		0, +0.7
+2F 1.0		0, +1.0
--2F0.3		0, -0.3
--2F0.7		0, -0.7
--2F 1.0		0, -1.0
3F0.3		0, -0.3, +0.3
3F0.7		0, -0.7, +0.7
3F 1.0		0, -1.0, +1.0
+3F0.3		+0.3, 0, +0.7
+3F0.7		+0.7, 0, +1.3
+3F 1.0		+1.0, 0, +2.0
--3F0.3		-0.3, -0.7, 0
--3F0.7		-0.7, -1.3, 0
--3F 1.0		-1.0, -2.0, 0



## 2. With 1/2 steps

Number of shots and compensated EV value	Electronic analog exposure display	Shooting order
+2F0.5		0, +0.5
+2F 1.0		0, +1.0
--2F0.5		0, -0.5
--2F 1.0		0, -1.0
3F0.5		0, -0.5, +0.5
3F 1.0		0, -1.0, +1.0
+3F0.5		+0.5, 0, +1.0
+3F 1.0		+1.0, 0, +2.0
--3F0.5		-0.5, -1.0, 0
--3F 1.0		-1.0, -2.0, 0

## 3. With one steps

Number of shots and compensated EV value	Electronic analog exposure display	Shooting order
+2F 1.0		0, +1.0
--2F 1.0		0, -1.0
3F 1.0		0, -1.0, +1.0
+3F 1.0		+1.0, 0, +2.0
--3F 1.0		-1.0, -2.0, 0

## 3 Compose picture, focus and shoot.

- Compensated shutter speed and aperture values are displayed during shooting.
  - To cancel the Bracketing, rotate the Main-Command Dial while pressing the Auto Exposure/Flash Exposure Bracketing button  so  disappears from the LCD panel. The number of shots and compensated EV values previously selected will remain.
  - If the exposure compensation function (page 56) is also set, Bracketing will be combined with the exposure compensation values. It is useful to perform Bracketing with a compensated value of over +2 EV or under -2 EV.
  - With film advance mode in continuous shooting (**C** or **Cs**), fully depress and hold the shutter release button until the set number of shots has been taken and film advance stops automatically.
  - If the end of the film roll is reached during Bracketing, the remaining shots can be taken after new film has been loaded. Also, if you turn the power switch off during Bracketing, the remaining shots can be taken after the power is turned back on.
  - Bracketing is performed with one frame at a time when the self-timer (page 67) is set.
- CS**  3: Bracketing order can be set to change from negative EV value to positive EV value (page 71).

# Multiple Exposure

Multiple exposure consists of two or more exposures of one or more subjects in the same frame. Multiple exposure can be performed in any of the available exposure modes.

**1** Rotate and set the film advance mode selector to  while pressing the film advance mode selector lock release.

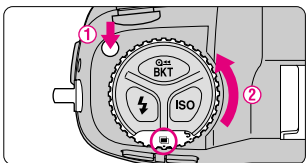

**2** Rotate the Main-Command Dial while pressing the  button to set the desired exposure compensation.

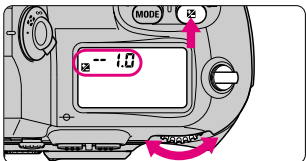



- Exposure compensation is necessary depending on the number of exposures in multiple exposure since more than one image is exposed in the same frame.
- Standard compensation value:

Number of exposures	Compensation value
Two	-1.0 EV
Three	-1.5 EV
Four	-2.0 EV
Eight or Nine	-3.0 EV

- Test shooting is recommended since the compensation actually required varies depending on the shooting situation.
- When the background is completely dark and subjects do not overlap, no compensation is necessary for each shot.
- In some cases, frames may shift slightly in multiple exposure. In particular, film advance/rewind becomes unstable at the beginning and near the end of a film roll so multiple exposure is not recommended.

**3** Compose picture, confirm focus indicator ● and shoot.

- The first shot is taken when the shutter release button is fully depressed. The film does not advance and multiple exposures can be taken from the second shutter release.
- The film does not advance and the frame counter does not count up as long as the film advance mode selector is set to .
- To cancel multiple exposure, set the film advance mode selector to a position other than . Film is advanced when the exposure meter is on and the shutter release button is lightly pressed. When the film is advanced, frame counter counts up.

**CS**  **14**: The film advance mode in multiple exposure is normally set to single-frame shooting. However, it can be set to continuous shooting (page 73).



## Long Time Exposure

- This function is useful for shooting nighttime scenes or stars, which require extended exposure of more than 30 sec. The shutter will be open as long as the shutter release button is kept fully depressed. (Use of a tripod is recommended.)

- 1 Rotate the Main-Command Dial while pressing the exposure mode button **MODE** to select **M** (Manual exposure).

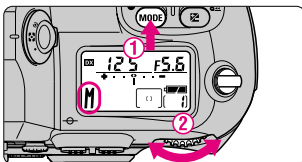

- Use the LCD illuminator (page 63) to view the LCD panel in the dark.

- 2 Rotate the Main-Command Dial to select **bULb** and rotate the Sub-Command Dial to set the aperture.

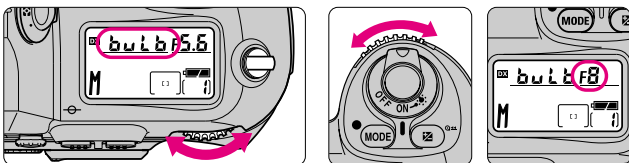

- If **bULb** is selected in Manual exposure mode and the exposure mode is changed to Shutter-Priority Auto, **bULb** blinks and the shutter locks.
- Continuous exposure of approx. 4 hours is possible with a fresh set of alkaline-manganese batteries, and approx. 7 hours with lithium batteries. Note that continuous exposure time is reduced when shooting at low temperatures.

- 3 Compose picture, focus and shoot.

- The shutter will be open as long as the shutter release button is kept fully depressed.
- Use of the optional remote cord (page 94) reduces camera shake.

## Diopter Adjustment/LCD Illuminator

- The finder diopter enables near- or far-sighted photographers to adjust the eyepiece diopter to suit their vision.

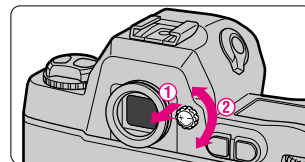

- Pull up and rotate the diopter adjustment knob while looking through the viewfinder until the focus brackets in the viewfinder appear sharp. The adjustable range of the finder diopter is  $-3m^{-1}$  to  $+1m^{-1}$ . Nine optional eyepiece correction lenses provide a viewfinder diopter range of  $-5$  to  $+3m^{-1}$ .

### NOTE: Using the diopter adjustment knob

Since the diopter adjustment knob is located next to the viewfinder, be careful not to poke yourself in the eye with your finger or fingernail while rotating the knob.

- Displays in the LCD panel can be confirmed in the dark with the LCD illuminator

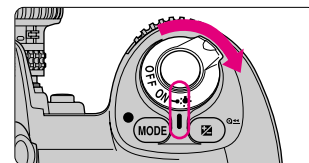

- Rotate the power switch to **ON**. The exposure meter turns on and the LCD panel is illuminated in green.
- The power switch returns to the "on" position when you remove your finger from the power switch, but illumination remains on as long as the exposure meter is on. Illumination turns off after shutter release.

**CS** **f7**: The illuminator can be set to come on when any button is pressed (page 74).



## Depth-of-Field Preview/Film Plane Indicator

- Depress the depth-of-field preview button to confirm the depth of field through the viewfinder (see page 68).

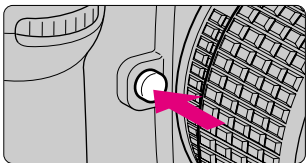

- Pressing the depth-of-field button stops the lens down to the aperture controlled in Programmed Auto or Shutter-Priority Auto exposure mode, and down to the aperture selected in Aperture-Priority Auto or Manual exposure mode. By looking through the viewfinder, the approximate depth of field with the given aperture can be confirmed.

- The film plane indicator shows the position of the film plane inside the camera body.

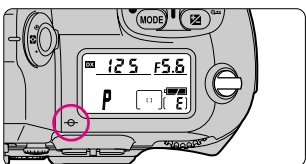

- The film plane indicator shows the standard line of the shooting distance and indicates the position of the film plane inside the camera body. Use this indicator when actually measuring camera-to-subject distance, e.g. in close-up photography.
- The exact distance from the lens mounting flange to the film plane is 46.5mm.

## Changing Focusing Screens

- In addition to the B-type BriteView screen supplied with the F100 camera, an E-type clear Matte/Fresnel screen with grid is available as an option. This screen is suitable for copying and architectural photography.

- 1 Remove the lens from the camera body and pull the focusing screen release latch outward using the supplied tweezers.

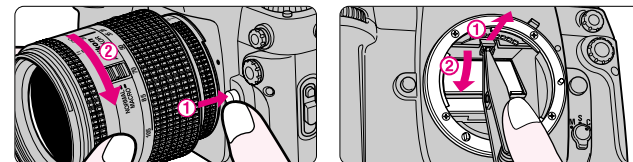

- The holder will spring open when the focusing screen release latch is pulled outward using the tweezers.

- 2 Remove the screen by grasping the small tab with the tweezers, and set the replacement screen in place.

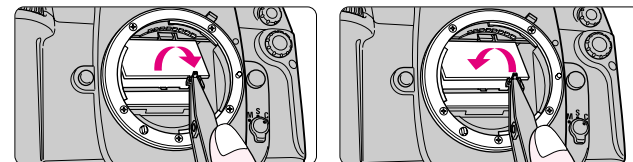

- Make sure the screen is in its proper place.

- 3 Using the tweezers, push the front edge of the holder upward until it clicks into place.

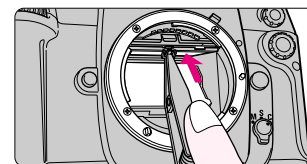

- Be sure not to touch the reflex mirror or the surfaces of the focusing screens.
- Always use F100 focusing screens (focusing screens for other cameras cannot be used).

## Changing Camera Back (Data Back MF-29)

- Optional Data Back MF-29 is available for the F100.  
Confirm through the film confirmation window that no film is loaded.

- 1 Open the camera back by sliding the camera back lock release lever while pressing the camera back lock release.

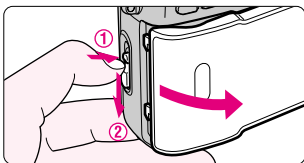

- 2 Remove the camera back by tilting it to the right while pressing the camera back release pin.

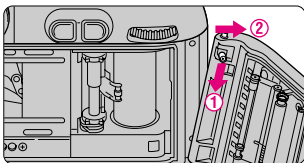

- Be sure not to touch the camera back contacts, film pressure plate or film pressure roller. If these parts become dirty, it may result in damage to the film or interference with data transmission between the camera back and body.
- To attach the camera back, attach it while pressing the camera back release pin. See the instruction manual of the Data Back MF-29 for details.

## Self-Timer Operation

- You can use the self-timer when you want to be in the photograph. Use a tripod or place the camera on a stable surface before using the self-timer.

- 1 Set the film advance mode selector to  while pressing the film advance mode selector lock release.

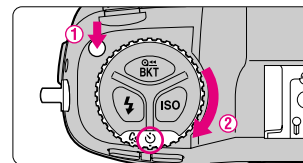

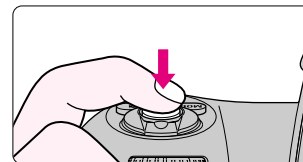

- Self-timer shooting cannot be performed unless the camera's shutter can be released (i.e. when subject cannot be brought into focus with autofocus in Single Servo AF).
- To shoot in an exposure mode other than Manual, cover the eyepiece with the supplied eyepiece cap (page 3) or with your hand before pressing the shutter release button to prevent interference and achieve correct exposure from stray light.
- Do not stand in front of the lens when setting the self-timer in autofocus mode.

- 2 Compose picture, focus and fully depress the shutter release button.



- Once the self-timer is activated, the shutter will release in 10 seconds. The self-timer indicator LED will blink for 8 sec. and then stop blinking for 2 sec. before the shutter is released.
- To cancel the self-timer, set the film advance mode selector to a position other than .
- When **bul b** is selected in Manual exposure mode, shutter speed is controlled to approx. 1/10 sec.

**CS**  : The time delay of the self-timer can be set to 2, 5, or 20 sec. (page 74).

# About Depth of Field and Focus Tracking

This camera is equipped with autofocus where focusing is automatically executed by the camera. Basics of the relationship between focus and depth of field and Focus Tracking are explained in this section.

## Depth of field

When focusing, depth of field should be considered. Depth of field is the zone of sharpest focus in front of and behind the subject on which the lens is focused. It varies according to shooting distance, focal length and, above all, aperture. Smaller apertures (larger f-numbers) will produce a deeper depth of field where the background and foreground become sharper; larger apertures (smaller f-numbers) will produce a shallower depth of field where the background becomes blurred. Similarly, shorter shooting distance or longer focal length will produce a shallower depth of field, and longer shooting distance or shorter focal length will produce a deeper depth of field. Note that depth of field tends to be shallower in front of and deeper behind the subject in focus.

## Focus Tracking

When the focus mode selector is set to Single Servo AF (**S**) or Continuous Servo AF (**C**) and the shutter release button is lightly pressed or AF Start button is kept pressed, the camera automatically switches to Focus Tracking when a moving subject is detected. Focus Tracking enables the camera to analyze the speed of the moving subject according to the focus data detected, and to obtain correct focus by anticipating the subject's position—and driving the lens to that position—at the exact moment of exposure.

In Single Servo AF, Focus Tracking is activated with a subject that has been moving in advance to the focus detection, and focus is locked when the subject stops moving and ● appears in the viewfinder. In Continuous Servo AF, camera continues to track subject (even with a subject which started moving in the middle of the focus detection) and focus is not locked.

# CUSTOM SETTING

Using the Custom Setting feature, you can create a combination of functions that are different from the initial factory settings. The functions listed in this section can be selected with the F100.

# Menu/Features of Custom Setting

## ■ Creating Custom Setting

- 1 Select a menu number by rotating the Main-Command Dial while pressing the Custom Setting button **CS**.

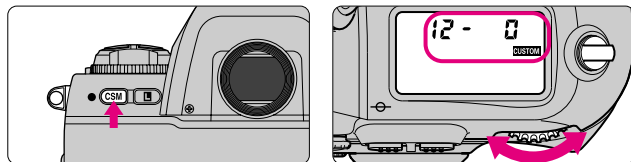

• 22 menus (1 to 22) are available with the F100.

- 2 While holding the **CS** button, select the desired option number (or character) by rotating the Sub-Command Dial.

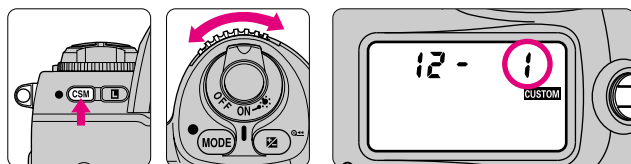

- When you remove your finger from the **CS** button after the desired option number (or character) is displayed in the LCD panel, **CUSTOM** appears in the LCD panel.
- See page 76 for returning all the Custom Settings to their initial factory settings.

## ■ Menu number and Custom Setting options

1. **Automatic film rewind at the end of film roll (page 29)**  
Options: **0**: Disabled (initial setting)  
**1**: Enabled  
At default setting, film rewind is started by pressing the two film rewind buttons **REW**. However, the camera can be set to start film rewind automatically when the end of the film roll is reached.
2. **Change of steps of the exposure values (shutter speed, aperture, exposure compensation or compensated EV value in Bracketing) (pages 46-53, 56-59)**  
Options: **3**: 1/3 steps (initial setting)  
**2**: 1/2 steps  
**1**: 1 steps  
At default setting, exposures (shutter speed, aperture, exposure compensation or compensated EV value in Bracketing) are displayed/selected in 1/3 steps. However, this can be changed to steps of 1/2 or one.
3. **Bracketing order (page 58)**  
Options: **0**: Initial setting (see page 58)  
**1**: From negative value to positive value  
Bracketing is normally performed in the order of the initial setting (page 58). However, this Bracketing order can be changed to be performed from negative compensation to positive compensation.
4. **Autofocus activated when shutter release button lightly pressed (page 36)**  
Options: **0**: Enabled (initial setting)  
**1**: Disabled  
At default setting, lightly pressing the shutter release button starts autofocus operation. However, it can be set to be started only by pressing the AF start button.
5. **Warning indications with non-DX-coded film (page 21)**  
Options: **0**: After film is advanced to the first frame (initial setting)  
**1**: When the power switch is on  
When a non-DX-coded film is loaded and the camera's film speed is set to **DX**, warning indications appear after the film is advanced to the first frame. However, the indications can be set to appear when the power switch is on.

- 6. Focus area selection changed to continuously in the same direction (page 37)**  
Options: **0**: Disabled (initial setting)  
          **1**: Enabled  
At default setting, the focus area can be selected by pressing the focus area selector in the desired direction. However, it can be set to be changed continuously in the same direction. For example, when the top of the focus area selector is pressed, focus area continues to change from top, bottom, middle and so on. With this option, focus area can be switched to the opposite position without pressing the opposite position on the focus area selector.
- 7. Auto Exposure Lock when shutter release button is lightly pressed (page 54)**  
Options: **0**: Disabled (initial setting)  
          **1**: Enabled  
At default setting, Auto Exposure Lock can be performed by pressing the **AE-L/AF-L** button. However, Auto Exposure can be set to be locked by lightly pressing the shutter release button.
- 8. Film advance with closing the camera back (when power switch is on) (page 21)**  
Options: **0**: Disabled (initial setting)  
          **1**: Enabled  
At default setting, film advances to the first frame after it is loaded, the camera back is closed and the shutter release button is fully depressed. However, film advance can be set to start when the camera back is closed.
- 9. Dynamic AF Mode with Closest Subject Priority in Single Servo AF (page 39)**  
Options: **0**: Enabled (initial setting)  
          **1**: Disabled  
At default setting, Dynamic AF Mode with Closest Subject Priority (page 39) is activated when Dynamic AF mode is selected in Single Servo AF. However, Dynamic AF Mode with Closest Subject Priority can be set to be disabled in Single Servo AF.
- 10. Dynamic AF Mode with Closest Subject Priority in Continuous Servo AF (page 39)**  
Options: **0**: Disabled (initial setting)  
          **1**: Enabled  
At default setting, selecting Dynamic AF in Continuous Servo AF does not activate Dynamic AF Mode with Closest Subject Priority (page 39). However, Dynamic AF Mode with Closest Subject Priority can be set to be activated in Continuous Servo AF.

## **11. Auto Exposure/Flash Exposure Bracketing options (page 57)**

Options: **AE**: Simultaneous activation of Auto Exposure/Flash Exposure Bracketing (initial setting)

**AE**: Only Auto Exposure Bracketing activated

**5b**: Only Flash Exposure Bracketing activated

At default setting, Auto Exposure and Flash Exposure Bracketing are activated simultaneously. However, only Auto Exposure or Flash Exposure Bracketing can be set to be activated.

## **12. Switching Command Dial operations (pages 48-53)**

Options: **0**: Disabled (initial setting)

**1**: Enabled

Unlike the default Command Dial operations, the Sub-Command Dial can be set to select shutter speed (in Shutter-Priority Auto or Manual exposure mode) and the Main-Command Dial to select aperture (in Aperture-Priority Auto or Manual exposure mode).

## **13. Easy Exposure Compensation (page 56)**

Options: **0**: Disabled (initial setting)

**1**: Enabled

When the Easy Exposure Compensation is activated, exposure compensation can be performed, without pressing the **WB** button, by simply rotating the Sub-Command Dial (in Programmed Auto or Shutter-Priority Auto exposure mode) or Main-Command Dial (in Aperture-Priority Auto or Manual exposure mode).

- If the exposure compensation values are set to change in Custom Setting menu **2**, up/down to  $\pm 5$  EV in 1/2 or 1 steps can be set.
- If the Command Dial operations are switched in Custom Setting menu **12**, Main- and Sub-Command Dials operate under opposite conditions except in Programmed Auto exposure mode.

## **14. Film advance in multiple exposure (page 61)**

Options: **0**: Single frame shooting (initial setting)

**1**: Continuous shooting

At default setting, the shutter is released once each time the shutter release button is fully depressed in multiple exposure (single frame shooting). However, it can be changed to continuous shooting where the shutter can be continuously released as long as the shutter release button is fully depressed.

## 15. Delay time for auto meter-switch off (page 17)

- Options 4 : 4 sec.  
 5 : 6 sec. (initial setting)  
 8 : 8 sec.  
 15 : 16 sec.

At default setting, the exposure meter automatically turns off 6 sec. after turning the power switch on or lightly pressing the shutter release button. However, it can be changed to 4 sec., 8 sec. or 16 sec. (Note that the usable number of film rolls per batteries decreases with the longer delay time for auto meter-switch-off since it consumes more power.)

## 16. Delay time for self-timer operation (page 67)

- Options 2 : 2 sec.  
 5 : 5 sec.  
 10 : 10 sec. (initial setting)  
 20 : 20 sec.

At default setting, the shutter is released 10 sec. after the shutter release button is fully depressed in self-timer operation. However, this can be changed to 2, 5, or 20 sec.

## 17. LCD illuminator activated by pressing any button (page 63)

- Options 0 : Disabled (initial setting)  
 1 : Enabled

At default setting, turning the power switch to  activates the LCD illuminator. However, it can be set to be activated with a press of any button.

## 18. Data imprint (year/month/day/hour/minute) on frame #0 (page 92)

- Options 0 : Disabled (initial setting)  
 1 : Enabled

With optional Data Back MF-29, data (year/month/day/hour/minute) can be set to be imprinted on frame #0. To imprint data on frame #0 only and not on frame #1 on, cancel the data imprint on the MF-29 after film is automatically advanced to the first frame.

## 19. Aperture control (pages 50-53)

- Options 0 : Aperture value remains (initial setting)  
 1 : Aperture step from the lens' maximum remains unchanged

When a Micro Nikkor lens is extended or the focal length is changed with a zoom lens in which maximum aperture varies with focal length, the aperture value set with the Sub-Command Dial remains. However, it can be changed to keep the aperture steps from the lens' maximum aperture (in Aperture-Priority Auto or Manual exposure mode).

Example: When AF Zoom-Nikkor 70-210mm f/4-5.6 is attached and f/8 (two steps from the maximum aperture of f/4) at 70mm is set on the lens, zooming up to 210mm does not change the aperture of f/8 with "0: Aperture value remains" setting. However, when the "1: Aperture step from the lens' maximum remains" is selected, aperture changes to f/11, two steps from the maximum aperture of f/5.6 at 210mm.



## 20. Shutter release confirmation with self-timer LED

- Options 0 : Disabled (initial setting)  
 1 : Enabled

At default setting, the self-timer LED only lights in the self-timer operation. However, it can be set to light immediately before shutter release in normal operation.

## 21. AE-L/AF-L button options (page 41/54)

- Options 0 : Simultaneous Auto Exposure/autofocus lock operation (initial setting)  
 1 : Auto Exposure lock only  
 2 : Autofocus lock only  
 3 : Auto Exposure lock remains after removing finger from the button

At default setting, Auto Exposure and autofocus are locked simultaneously when the  button is pressed. However, it can be set to be locked separately or exposure remains locked after removing your finger from the button and released when the  button is pressed again or picture is taken.

## 22. Aperture setting with lens' aperture ring (pages 50-53)

- Options 0 : Disabled (initial setting)  
 1 : Enabled

At default setting, aperture can be set using the Sub-Command Dial in Aperture-Priority Auto or Manual exposure mode. However, it can be set to be changed using the lens' aperture ring with CPU Nikkor lens other than G-type.

- Aperture will be displayed in one steps and regardless of the setting in Custom Setting menu 12, the aperture can only be selected using the lens' aperture ring.

## Two-Button Reset

- Two-Button Reset lets you instantly reset specified settings to their original default settings.

Press the **CS** and **MODE** buttons simultaneously, and hold them for more than 2 sec.

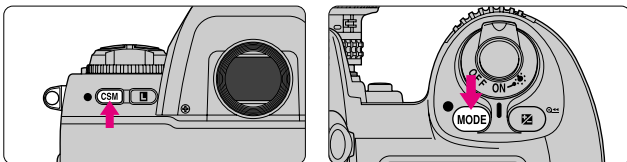

- The following functions are reset to their original settings:

Function	Condition
Focus area	Center
Exposure mode	Programmed Auto
Flexible Program	Canceled
Shutter speed lock	Canceled
Aperture lock	Canceled
Exposure compensation	Canceled
Auto Exposure Lock	Canceled
Auto Exposure/Flash Exposure Bracketing	Canceled
Flash Sync mode	Front-curtain sync

- Canceling Custom Setting

- During Two-Button Reset, the Custom Setting indication **CUSTOM** blinks for 2 sec. in the LCD panel. To cancel Custom Setting, release one of the two buttons once while the **CUSTOM** indication is blinking, then press both buttons again (page 70).

## FLASH PHOTOGRAPHY

You can enjoy the excitement of the Nikon F100's advanced flash technology by using Nikon's advanced SB-80DX, SB-28/28DX, SB-27 or SB-50DX AF Speedlight. With the F100 system you'll discover the benefits of flash for more picture-taking situations than ever. Make fill-flash a standard part of your photography. Brighten dull scenes and erase harsh shadows for beautiful portraits. With the F100 system's automatic operation, you can take flash pictures like never before.

## Types of TTL Auto Flash

- When an optional Nikon Speedlight is attached and set to TTL mode, the following TTL Auto Flash modes are available depending on the type of lens used.

### Multi-Sensor Balanced Fill-Flash/3D Multi-Sensor Balanced Fill-Flash (Automatic Balanced Fill-Flash with TTL Multi Sensor)

Automatic Balanced Fill-Flash with TTL Multi Sensor can be performed with a combination of the F100 camera, a CPU lens and the Nikon TTL AF Speedlight. In this flash mode, just after you press the shutter release button and before the shutter is activated, the Speedlight with Monitor Pre-Flash function (SB-80DX, SB-50DX, SB-28/28DX, SB-27, SB-26 and SB-25) will fire a series of imperceptible pre-flashes that are detected by the F100's five-segment TTL Multi Sensor, then analyzed for brightness and contrast. Furthermore, when a D- or G-type AF Nikkor lens is attached, it integrates Distance Information from the lens with other exposure control information, automatically compensating the flash output level so that flash output and ambient light are balanced.

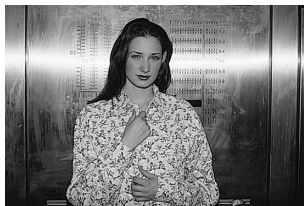

With a Speedlight with Monitor Pre-Flash function or the SB-24, you can cancel the Automatic Balanced Fill-Flash with TTL Multi Sensor to perform Standard TTL Flash. Multi-Sensor Balanced Fill-Flash can also be performed with the SB-24 and other dedicated Speedlights that do not have the Monitor Pre-Flash feature. Select a metering system other than Spot Metering with the F100. (The Flash mode automatically switches to Standard TTL flash with Spot Metering.)

### Center-Weighted Fill-Flash

Center-Weighted Fill-Flash is performed with a TTL AF Speedlight and non-CPU lens. Since Center-Weighted Metering is used instead of Matrix Metering with a non-CPU lens, flash output and ambient light of the main subject and background are roughly balanced. If a highly reflective object is located within the frame or the background is non-reflective, correct exposure may not be obtained. With a Speedlight with Monitor Pre-Flash function or the SB-24, you can cancel the Center-Weighted Fill-Flash to perform Standard TTL Flash.

### Standard TTL Flash

With a Speedlight with Monitor Pre-Flash function or the SB-24, Standard TTL Flash can be performed with any type of lens. With other Speedlights, Standard TTL Flash is automatically set when the camera is set to Manual exposure mode. In Standard TTL Flash, automatic flash output level compensation is not available. This means that, even though the main subject is correctly exposed, the background may not be. (Selecting Spot Metering automatically switches the TTL auto flash mode to Standard TTL Flash.)

## Accessory Shoe/Sync Terminal/Ready-Light

- Accessory shoe

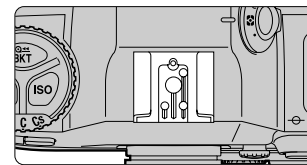

- An optional Speedlight such as SB-80DX, SB-50DX, SB-30, SB-29s/29, SB-28/28DX, SB-27, SB-23 or SB-22s can be attached directly to the accessory shoe of the F100 without a cord. This accessory shoe is equipped with a safety-lock which prevents accidental drop when a Speedlight with a safety-lock pin (SB-80DX, SB-30, SB-29s/29, SB-28/28DX, SB-27, SB-26, SB-25 or SB-22s) is attached.

- Sync terminal



- To use a Speedlight that requires a sync cord, attach one end of the sync cord to the sync terminal.

When a Speedlight such as SB-80DX, SB-50DX, SB-30, SB-29s/29, SB-28/28DX, SB-27, SB-23 or SB-22s is attached to the F100's accessory shoe and rear-curtain sync is performed, do not attach additional Speedlight via sync terminal.

- Ready-light



- When using a Speedlight such as the SB-80DX, SB-50DX, SB-30, SB-29s/29, SB-28/28DX, SB-27, SB-23 or SB-22s, the ready-light  lights up when the Speedlight is fully charged and ready to fire.
- If the ready-light blinks approx. 3 sec. after full flash output, underexposure may have occurred (when the Speedlight is set to TTL or non-TTL auto flash mode). Check the focus distance, aperture or flash shooting distance range and shoot again.



# Flash Sync Mode Features

- Five flash sync modes are available with the F100.

Set the flash sync mode by rotating the Main-Command Dial while pressing the flash sync mode button.

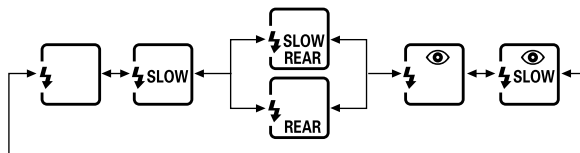
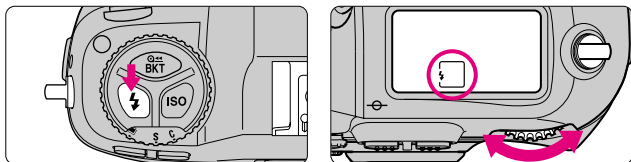

## Flash Sync Mode: Front-Curtain Sync

Set the flash sync mode to Front-Curtain Sync for normal flash photography. (With SB-26, SB-25 and SB-24, set the Speedlight's sync mode selector to NORMAL.)



## Flash Sync Mode: Slow Sync

Normally, the camera's shutter speed is automatically set to 1/60 to 1/250 sec. for flash photography in Programmed Auto or Aperture-Priority Auto exposure mode. However, for shooting nighttime scenes, Slow Sync uses a slower shutter speed (down to 30 sec.) to bring out background details using all of the available light.



## Flash Sync Mode: Rear-Curtain Sync

The Speedlight fires at the end of the exposure, turning available light into a stream of light that follows the flash-illuminated moving subject. (With SB-26, 25 and 24, set the Speedlight's sync mode selector to REAR.) When Rear-Curtain Sync is set in Programmed Auto or Aperture-Priority Auto exposure mode, Slow Sync is automatically set.



## Flash Sync Mode: Red-Eye Reduction

The Red-Eye Reduction lamp lights for approx. 1 sec. before the flash fires in order to reduce the red-eye effect in photos of people or animals. (With SB-80DX, SB-28/28DX, SB-27 or SB-26 only.)



## Flash Sync Mode: Red-Eye Reduction with Slow Sync

Red-Eye Reduction and Slow Sync mode are simultaneously set. (With SB-80DX, SB-28/28DX, SB-27 or SB-26 only.) Set the exposure mode to Programmed Auto or Aperture-Priority Auto.

### NOTE: Flash Sync Modes

- When Red-Eye Reduction or Red-Eye Reduction with Slow Sync is selected, Red-Eye Reduction lamp lights for approx. 1 sec. before the flash fires. Do not move the camera or let the subject move until the shutter is released. (Red-Eye Reduction is not recommended in shooting situations where shutter release is your top priority.)
- With Slow Sync and Red-Eye Reduction with Slow Sync, keep the camera steady to prevent picture blur since the shutter speed is slow. Use of a tripod is recommended.
- Rear-Curtain Sync cannot be used with a studio flash system since the correct synchronization cannot be obtained.

# Usable Optional Speedlights

■ The following optional Speedlights are compatible with the F100. In the table, ① indicates D- or G-type Nikkor (except IX-Nikkor), ② indicates an AF Nikkor lens other than D/G-type (except AF Nikkor for F3AF) and Ai-P Nikkor and ③ indicates non-CPU Nikkor lenses.

Speedlight	Flash mode Lens	TTL				A	M	REAR	REAR	REAR	
		3D Multi-Sensor Balanced Fill-Flash	Multi-Sensor Balanced Fill-Flash	Center-Weighted Fill-Flash	Standard TTL flash*1	Non-TTL Auto	Manual	FP High-Speed Sync	Repeating Flash	Rear-Curtain Sync	Red-Eye Reduction
SB-80DX*2, SB-28/28DX (Cordless)	①	○			○	○	○	○	○	○	○
	②		○		○	○	○	○	○	○	○
	③			○	○	○	○	○	○	○	○
SB-50DX (Cordless)	①	○			○	○	○	○	○	○	○
	②		○		○	○	○	○	○	○	○
	③			○	○	○	○	○	○	○	○
SB-27 (Cordless)	①	○			○	○	○	○	○	○	○
	②		○		○	○	○	○	○	○	○
	③			○	○	○	○	○	○	○	○
SB-26*2 (Cordless)	①	○			○	○	○	○	○	○	○
	②		○		○	○	○	○	○	○	○
	③			○	○	○	○	○	○	○	○
SB-25 (Cordless)	①	○			○	○	○	○	○	○	○
	②		○		○	○	○	○	○	○	○
	③			○	○	○	○	○	○	○	○
SB-24 (Cordless)	①②		○		○	○	○	○	○	○	○
	②			○	○	○	○	○	○	○	○
	③			○	○	○	○	○	○	○	○
SB-29s/29*3, SB-23, SB-21B*3 (Cordless)	①②		○		○	○	○	○	○	○	○
	②			○	○	○	○	○	○	○	○
	③			○	○	○	○	○	○	○	○
SB-30, SB-22s, SB-22, SB-20, SB-16B, SB-15 (Cordless)	①②		○		○	○	○	○	○	○	○
	②			○	○	○	○	○	○	○	○
	③			○	○	○	○	○	○	○	○
SB-11*4, SB-14, SB-140*5	①②		○		○	○	○	○	○	○	○
	②			○	○	○	○	○	○	○	○
	③			○	○	○	○	○	○	○	○

\*1 With Spot Metering, setting exposure to Manual automatically changes the flash mode to Standard TTL with Speedlights other than SB-80DX, 28/28DX, 27, 26, 25 and 24 that are equipped with TTL Auto Flash.

\*2 Wireless Slave Flash can be performed with the SB-80DX and SB-26. Shutter speed is automatically controlled to slower than 1/200 sec. when the Wireless Slave Flash selector is set to D.

\*3 With the SB-29s/29 and SB-21B, autofocus can only be used when an AF Micro-Nikkor (60mm, 105mm, 200mm and 70-180mm) is attached.

\*4 TTL auto flash is possible with TTL Remote Cord SC-23.

In Aperture-Priority Auto or Manual exposure mode, attach SU-2 to SC-13 with SB-11 and SB-14 or attach SU-3 to SC-13 with SB-140.

SC-11 or SC-15 can also be used; however, the ready-light does not appear in the viewfinder and the shutter speed does not change automatically.

\*5 Ultraviolet and infrared photography can be performed only when SB-140 is set to M.

## ■ Notes on using the optional Speedlight

- See your Speedlight manual for details. If the camera groups are defined in the manual of the Speedlight with TTL auto flash, see the section for camera group I.
- With the SB-26, 25 or 24, flash sync mode set on the Speedlight overrides the setting on the camera body.
- Flash sync speed is 1/250 sec. or slower when using an optional Speedlight. (Set the shutter speed to 1/125 sec. or slower with Medical-Nikkor 120mm f/4.)
- Available film speeds for TTL auto flash are ISO 25 to ISO 1000.
- The AF-Assist Illuminator does not emit light when the focus area is not set to center.
- In Programmed Auto exposure mode, the camera automatically controls the maximum available aperture as follows in relation to the film speed:

ISO film speed	25	50	100	200	400	800	1000
Maximum available aperture	2.8	3.3	4	4.8	5.6	6.7	7.1

- \* When film speed increases by one step, the maximum available aperture is stopped down by 1/2 f/stop. If you are using a lens with a maximum aperture smaller than that listed above, the automatically controlled aperture range is from the lens' maximum to minimum aperture.
- When flash exposure compensation is set,  $\pm$  appears in the viewfinder without the compensation value.

### NOTE: Flash attachments made by manufacturers other than Nikon

Use only Nikon Speedlights. Other units may damage the camera's electrical circuit due to incompatible voltage requirements (not compatible with 250V or higher), electric contact alignment or switch phase.

# Using the Speedlight

■ Operation described in this section applies when the SB-80DX, SB-50DX, SB-28/28DX, SB-27, SB-26 or SB-25 Speedlight and D- or G-type Nikkor are attached, and Automatic Balanced Fill-Flash with TTL Multi Sensor is used.

## 1 Attach the Speedlight and set the metering system.

- Set the metering system to Matrix or Center-Weighted Metering.

## 2 Set the exposure mode and confirm shutter speed and aperture.

- When using Red-Eye Reduction with Slow Sync or Slow Sync, set the exposure mode to Programmed Auto or Aperture-Priority Auto.
- Available shutter speed and aperture in each exposure mode

Exposure mode	Available shutter speed	Available aperture	Page
Programmed Auto	Automatically set	Automatically set	46
Shutter-Priority Auto	1/250-30 sec.*		48
Aperture-Priority Auto	Automatically set	Desired setting	50
Manual	1/250-30 sec.*, Bulb		52

\* Shutter speed changes automatically to 1/250 sec. when the shutter speed is set to 1/250 sec. or faster as soon as the attached optional Speedlight is turned on.





## 3 Set the flash sync mode.

- Red-Eye Reduction and Red-Eye Reduction with Slow Sync can only be set with the SB-80DX, SB-50DX, SB-28/28DX, SB-27 and SB-26.
- With the SB-26 and SB-25, Front- and Rear-Curtain Sync settings on the Speedlight override the setting on the camera body.

## 4 Set the power switch of the Speedlight to ON (or STBY) and set the flash mode selector (MODE button on the SB-80DX/SB-50DX/SB-28/28DX) for TTL auto flash mode.

- Set TTL with the SB-80DX, SB-50DX, SB-28/28DX, SB-26 or SB-25 and AUTO with SB-27.

## 5 Set the Speedlight's flash sync mode selector and check the display in the LCD panel.

- With the SB-26 or SB-25, the flash sync mode setting on the Speedlight overrides the setting on the camera body.
- With the SB-80DX, SB-50DX, SB-28/28DX or SB-27, set the flash sync mode on the camera body since the Speedlight has no flash sync mode selector.
- Confirm that the indicators  and  for Automatic Balanced Fill-Flash with TTL Multi Sensor appear in the LCD panel. If these indications do not appear in the LCD panel, press the M button (MODE button with SB-80DX/SB-50DX/SB-28/28DX) until  and  appear.

## 6 Compose picture, focus and confirm the indication in the viewfinder.



- Lightly press the shutter release button and confirm the ready-light  appears in the viewfinder.

## 7 Confirm the flash shooting distance range and shoot.

- If the ready-light blinks approx. 3 sec. after full flash output, underexposure may have occurred. Check the focus distance, aperture or flash shooting distance range and shoot again.
- When using a Speedlight, make sure to read its instruction manual as well.

## Combinations of AF Functions

The following focusing operations can be executed with combinations of the focus mode and AF Area mode. See also the autofocus modes on page 39.

	Focus mode	AF Area mode	Focusing operation	Suitable shooting situation
<b>I</b>	Single Servo AF	Single Area AF	Focus is obtained only at the selected focus area and focus is locked once focus is achieved.	General shooting such as a stationary subject.
<b>II</b>	Single Servo AF	Dynamic AF Mode with Closest Subject Priority	Dynamic AF Mode with Closest Subject Priority maintains focus on the subject located closest to any of five focus areas and focus is locked once focus is achieved. If the subject moves from the selected focus area before focus lock, camera automatically focuses on the subject determining the data from the other focus areas.	Snapshot where you let the camera's autofocus operation determine the focusing.
<b>III</b>	Single Servo AF	Dynamic AF	Focus is obtained only at the selected focus area and focus is locked once it is achieved ( <b>CS</b> <b>3</b> ). If the subject moves from the selected focus area before focus lock, camera automatically focuses on the subject determining the data from the other focus areas.	General shooting including a moving subject where you want to expand the range of a regular snapshot.
<b>IV</b>	Continuous Servo AF	Single Area AF	Focus is obtained only at the selected focus area and focus is not locked.	Subject moving straight toward or away from the camera such as a racing car or track athlete to follow a subject with one focus area.
<b>V</b>	Continuous Servo AF	Dynamic AF	If the subject moves from the selected focus area, camera automatically focuses on the subject utilizing the Focus Tracking and determining the data from the other focus areas.	Irregularly moving subject such as a player in a football game where subject is difficult to follow in one focus area.
<b>VI</b>	Continuous Servo AF	Dynamic AF Mode with Closest Subject Priority	Dynamic AF Mode with Closest Subject Priority maintains focus on the subject located closest to any of five focus areas. If the subject moves from the selected focus area, camera automatically focuses on the subject utilizing the Focus Tracking and determining the data from the other focus areas ( <b>CS</b> <b>13</b> ).	Snapshot of a moving subject where you let the camera's autofocus operation determine the focusing.

## MISCELLANEOUS

The Nikon F100 is a high-performance, precision instrument, designed to deliver superior pictures. You'll want to take good care of your camera to ensure the best possible performance. Take time to review this section thoroughly, as doing so will add to your picture-taking pleasure.

We've also included information about optional accessories and a detailed section with technical specifications. Please read these areas carefully.

# Optional Accessories

■ A variety of optional accessories, including power sources, Data Back and Speedlight are available for the F100.

## • 3V Lithium Battery Holder MS-13

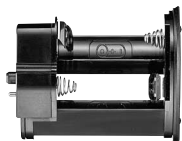

- Two 3V lithium batteries (CR123A or DL123A) can be used with the MS-13 in place of the supplied battery holder.

## • Multi-Power High Speed Battery Pack MB-15



- Multi-Power High Speed Battery Pack MB-15 improves camera holding in the vertical position, and the pack is equipped with an extra shutter release button and the Main-Command Dial for vertical shooting. With Multi-Power High Speed Battery Pack MB-15, six 1.5V AA-type alkaline-manganese or lithium batteries can be used to power the F100. (Film advance speed and usable number of film rolls vary depending on the shooting situation. See page 105/106.)

## • Ni-MH Battery MN-15



- Ni-MH battery MN-15 is exclusively designed for use with the Multi-Power High Speed Battery Pack MB-15. Ni-MH battery MN-15 can be recharged approx. 500 times using the Quick Charger MH-15. (Film advance speed and usable number of film rolls vary depending on the shooting situation. See page 105/106.)

## • Quick Charger MH-15



- Quick Charger MH-15 recharges a discharged Ni-MH battery MN-15 fully in approx. 70 minutes. This product has the same function as the Quick Charger EH-3 for the Rechargeable Ni-MH Battery Pack EN-3 for the Nikon E3/E3s Digital Camera. The MH-15 can also charge the Ni-MH battery EN-4 for Nikon D1 Digital Camera.

## • Antifog Finder Eyepiece DK-15

- Antifog Finder Eyepiece DK-15 prevents finder eyepiece from fogging in low temperatures or high humidity and provides clear viewfinder image.

## • Eyepiece correction lens

- Eyepiece correction lens enables near- or far-sighted photographers to adjust the eyepiece diopter to suit their vision, and can be attached easily by screwing it on the viewfinder eyepiece. Nine optional eyepiece correction lenses provide viewfinder diopter settings of  $-5$ ,  $-4$ ,  $-3$ ,  $-2$ ,  $0$ ,  $+0.5$ ,  $+1$ ,  $+2$  and  $+3m^{-1}$  (combined diopter with setting on camera body). We recommend that you actually look through the viewfinder with various correction lenses attached before making a purchase, since viewfinder diopter differs from one person to another. Use the optional eyepiece correction lens when you need eyepiece correction over  $-3$  to  $+1m^{-1}$  that can be adjusted using the F100's diopter adjustment knob. When using an eyepiece correction lens, set the diopter adjustment of the F100 to 0.

## • Rubber Eyecup DK-6

- The Rubber Eyecup DK-6 can be attached to the viewfinder eyepiece and lets you see through the viewfinder more clearly while preventing your eyes from becoming tired.

# Optional Accessories—continued

## • Right-Angle Viewing Attachment DR-4/Eyepiece Adapter DK-7

- The Right-Angle Viewing Attachment DR-4 lets you see the finder image at right angle to the light entering the lens.
- Eyepiece Adapter DK-7 lets you attach the Right-Angle Viewing Attachment DR-3 or Eyepiece Magnifier DG-2 to the F100.

## • Focusing Screens

- Two focusing screens are available exclusively for the F100. See page 65 for details on changing focusing screens.

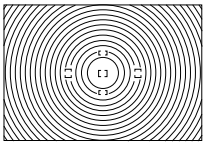
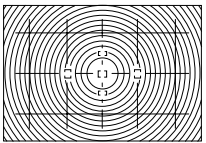
<b>B</b> BriteView		Supplied with the F100 camera
<b>E</b> Clear Matte/ Fresnel with grid		Etched horizontal and vertical lines added to B-type screen, the E-type screen is suitable for copying and architectural photography. Especially for use with PC-Nikkor lens.

\* Focus brackets and 12mm  $\varnothing$  center circle are not etched on the focusing screens.

## • Lenses



- A wide variety of lenses — 16mm to 600mm wideangle, telephoto, zoom, Micro or DC (Defocus image Control) — is available for the F100.

## • Filters

- Nikon filters can be divided into three types: screw-in, drop-in and rear-interchange. With the F100, the filter factor need not be considered except for the R60 filter. Compensate exposure +1 EV when using the R60. Note that when special filters available from manufacturers other than Nikon are used, autofocus or the electronic rangefinder may not operate properly.
- Use circular-polarizing filter C-PL instead of polarizing filter Polar. The polarizing filter cannot be used with the F100.
- Use NC filter when using the filter to protect the lens.
- Moiré may occur when shooting a subject against bright light or if a bright light source is in the frame. In this case, remove the filter before shooting.

( ) = f/stop compensation

Film	Type	Designation	Filter factor		Screw-in attachment size (mm)											Drop-in Series IX	Rear-interchange Bayonet	Slip-in	
			Daylight	Tungsten light	39	52	58	62	72	77	82	95	122	160					
Black & white and color	Neutral	NC	1	1	○	○	○	○	○										
	Skylight	L 1BC	1	1	○	○	○	○										○	
	Ultraviolet	L 37C	1	1	○	○	○	○	○	○	○	○	○					○	
Black & white	Ultraviolet	L 39	1	1	○														
	Yellow	Light	Y 44	1.5 (1/2)	1	○												○	
		Medium	Y 48	1.7 (2/3)	1.2 (1/3)	○	○	○	○	○	○	○						○	
		Deep	Y 52	2 (1)	1.4 (1/2)	○	○												
	Orange	O 56	3.5 (15/6)	2 (1)	○	○	○	○	○	○	○						○		
	Red	R 60	8 (3)	5 (2 1/3)	○	○	○	○	○	○	○						○		
	Green	Light	X 0	2 (1)	1.7 (2/3)	○													
Deep		X 1	5 (2 1/3)	3.5 (1 5/6)	○														
Special photography (black & white and color)	Soft	Soft 1	1	1	○	○	○												
		Soft 2	1	1	○	○	○												
	Circular-polarizing	C-PL	2-4 (1-2)	2-4 (1-2)	○	○	○	○										○	
	Neutral density	ND 2xS	2 (1)	2 (1)	○														
		ND 4x	4 (2)	4 (2)	○				○										
		ND 8x	8 (3)	8 (3)	○														
ND 8xS				○															
ND 400x	400 (8.6)	400 (8.6)	○																
Color	Amber	Light	A 2	1.2 (1/3)	○	○	○	○	○									○	
		Deep	A 12	2 (1)	○	○	○												
	Blue	Light	B 2	1.2 (1/3)	○	○	○	○	○										○
		Medium	B 8	1.6 (2/3)	○	○	○	○											
		Deep	B 12	2.2 (1 1/6)	○	○	○												

## Optional Accessories—continued

### • Data Back MF-29



- Data Back MF-29 allows you to imprint the desired data — year/month/day, month/day/year, day/month/year, day/hour/minute — or leave the film blank. See page 66 for details on attaching Data Back MF-29 in place of the camera back.

### • Speedlight SB-80DX



- Speedlight SB-80DX normally uses four AA-type alkaline-manganese batteries with a guide number of 38/125 (manual flash, 35mm zoom-head position, ISO 100, m/ft., 20°C/68°F).
- 3D Multi-Sensor Balanced Fill-Flash, which enables natural-looking overall exposures and a better balance between ambient light and the fill-flash (even when a highly reflective object is located within the frame or the background is non-reflective), is compatible with the SB-80DX. Also, the SB-80DX's AF Assist Illuminator enables autofocus operation in a dark environment (cancelable).
- Automatic power zoom continuously changes the zoom-head position according to the lens' focal length.
- A variety of flashes, including Slow Sync, Rear-Curtain Sync, non-TTL auto flash, manual flash, Repeating Flash, FP High-Speed Sync Flash and Wireless Slave Flash are compatible with the SB-80DX. Also, optional external power source SD-7 and SD-8A or Power Bracket SK-6A can be used with the SB-80DX.

### • Speedlight SB-27



- Speedlight SB-27 normally uses four AA-type alkaline-manganese batteries with a guide number of 30/98 (manual flash, 35mm zoom-head position, ISO 100, m/ft., 20°C/68°F).
- Compact and lightweight, the SB-27's flash head rotates from the horizontal to the vertical position along a 180° arc to control the effect of shadows.
- With the built-in bounce flash adapter, bounce flash operation is possible. And, with a diffuser card, by bouncing the light off the ceiling or walls, you can soften the shadows and produce more natural portraits or close-up photographs. Bounce flash can also make your subject's eyes appear more vibrant.
- 3D Multi-Sensor Balanced Fill-Flash, Standard TTL Flash, manual flash output level compensation, non-TTL auto flash and manual flash are compatible with the SB-27.
- The SB-27's AF-Assist Illuminator enables autofocus operation in a dark environment.

### • Wireless Slave Flash Controller SU-4



- TTL multi-flash, where a Speedlight to which Wireless Slave Flash Controller SU-4 is attached is fired simultaneously with the Speedlight attached to the F100, can also be used.



# Optional Accessories—continued

## • Accessories connected to 10-pin remote terminal

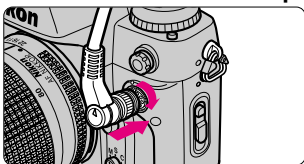

- By attaching the following accessories to the 10-pin remote terminal of the F100, operations such as remote shooting or automatic shooting are possible.
- When the 10-pin remote terminal is not in use, make sure to cover it with the supplied cap. Exposure to dirt or contact with foreign objects may result in a malfunction.
- To connect an accessory to the 10-pin terminal, align the indexes, insert the plug, then turn the lock screw as shown.

Accessory	Usage	Length
Remote Cord MC-20	Shutter can be released remotely and camera shake can be reduced easily. Also, Long-Time Exposure or Time mode is available, and beeping sound can be set to repeat each second for the duration of the exposure.	Approx. 80cm (2.6 ft.)
Extension Cord MC-21	Extension cord for MC-20, MC-22, MC-23, MC-25 or MC-30.	Approx. 3m (9.8 ft.)
Remote Cord MC-22	Remote cord with blue, yellow and black terminals to connected to a shutter triggering device. Remote control operation via sound or signal is possible.	Approx. 1m (3.3 ft.)
Connecting Cord MC-23	Connects two F100 cameras for simultaneous operation	Approx. 40cm (1.3 ft.)
Adapter Cord MC-25	Adapter cord to connect a remote accessory for 2-pin remote terminal such as Radio Control Set MW-2, Intervalometer MT-2 or Modulite Remote Control Set ML-2 to F100	Approx. 20cm (0.7 ft.)
Remote Cord MC-30	Useful in reducing camera shake or releasing shutter remotely. Also, shutter can be locked in Long Time Exposure (Bulb).	Approx. 80cm (2.6 ft.)
Modulite Remote Control Set ML-2	Remote control up to 100m (328 ft.) is possible via an infrared pulse-modulated ray. By using multiple number of ML-2s, more distant remote control is possible. (Adapter Cord MC-25 is required.)	—
Modulite Remote Control Set ML-3	Remote control up to 8m (26.2 ft.) is possible via an infrared ray.	—



## • Soft case (CF-57/CF-58)

- Two camera cases, CF-57 (for standard lens) and CF-58 (for telephoto lens) are available for this camera.
  - CF-57: Camera body fits inside case with 28-105mm f/3.5-4.5D IF or smaller lens attached.
  - CF-58: Camera body fits inside case with 70-300mm f/4-5.6D ED or smaller lens attached.

## • Neckstraps/Handstrap AH-4



- Leather-type AN-1 (black), braid-type AN-4B (black) and AN-4Y (yellow), wide braid-type neckstrap AN-6Y (yellow) and AN-6W (burgundy) neckstraps are available.
- Handstrap AH-4 helps you to hold the camera firmly and easily, and shoot in quick-motion.

 <b>WARNING</b>	 Do not use <b>Do NOT ever use organic solvents like thinner or benzene.</b> It causes fire or health hazard. It damages the camera.
---	---

### • **Cleaning camera body**

Use a blower brush to remove dirt and dust from the camera body and clean it with a soft, clean cloth. After using the camera near seawater, wipe the camera body with a soft, clean cloth slightly moistened with pure water to remove salt, and then dry it with a dry cloth.

### • **Cleaning mirror and lens**

Use a blower brush to remove dirt and dust from the mirror or lens. To remove fingerprints or smudges from the lens' surface, use a soft, clean cotton cloth or lens tissue moistened with ethanol (alcohol) or lens cleaner.

### • **Do not subject the camera or lens to strong vibration or shock**

Do not drop the camera body and lens or hit them against a hard surface as this may damage their precision mechanism.

### • **Do not touch the shutter curtains**

The shutter is made of very thin curtains. Do not hold, poke, or blow strongly with a blower brush. Doing so may scratch, deform or tear the shutter curtains.

### • **Avoid strong electric or magnetic fields**

The camera may not function properly in strong electric or magnetic fields such as near a transmitter tower. Avoid using the camera in such locations.

### • **Store the camera in a cool, dry place**

Store the camera in a cool, dry place to prevent mold and mildew. Keep it away from naphthalene or camphor (moth repellent), electrical appliances that generate magnetic fields or an excessively hot place such as inside a vehicle during the summer or near a heater.

### • **Avoid extreme temperature change**

An extreme temperature change can cause condensation inside the camera body. When taking the camera to a very hot place from a very cold place or vice versa, place it inside an airtight container such as a plastic bag and leave it inside a while to expose the camera gradually to the temperature change.

### • **Remove the batteries and store the camera with a desiccant**

If you do not intend to use the camera for a long time, remove the batteries to protect the camera from battery leakage.

- In a humid environment, store the camera inside a plastic bag with a desiccant to keep out dust, moisture and salt. Note, however, that storing leather cases in vinyl bags may cause the leather to deteriorate. Keep the batteries in a cool, dry place away from heat or humidity.
- Change the desiccant occasionally since it does not absorb moisture effectively after a while.
- Leaving the camera unused for a long period of time may cause mold to grow and result in malfunction. Turn the power on and release the shutter a few times once per month.

Nikon cannot be held responsible for any malfunction resulting from the use of the camera other than as specified in this manual.



**WARNING**



Do not leave

**Keep batteries out of children's reach.**  
If someone accidentally swallows batteries, call a doctor immediately.

**• Use four AA-type alkaline-manganese or lithium batteries**

Two 3V lithium batteries (CR123A or DL123A) can be used with optional 3V Lithium Battery Holder MS-13. With Multi-Power High Speed Battery Pack MB-15, six 1.5V alkaline-manganese or lithium batteries, or Ni-MH battery MN-15 can be used to power the F100.

- Change the batteries well before the end of their life and prepare spare batteries before important photographic occasions.

**• Turn the camera power off when changing batteries**

Turn the camera power off before changing batteries and insert the batteries with + and – ends positioned correctly.

- Stains on the battery poles may cause lack of contact. Wipe the batteries well with a dry cloth before installing.







**• Use fresh batteries at low temperatures**

Battery power diminishes at extremely low temperatures and the camera may not function properly with old batteries. Use a fresh set of batteries at low temperatures, keep spare batteries warm, and use them alternately.

- Film advance speed lowers and number of usable film roll becomes less at low temperatures. However, battery power may recover when the temperature returns to normal.

**• Do not throw batteries into a fire or short circuit batteries**

Do not throw batteries into a fire. Do not short, disassemble, heat or charge batteries.

LCD panel	Viewfinder	Cause	Remedy	Page
$\text{fE}$ blinks	$\text{fE}$ blinks	• CPU Nikkor lens (other than G-type) is not set to its minimum aperture.	• Set lens to minimum aperture.	18
 appears	—	• Batteries are nearing exhaustion.	• Have fresh ones ready.	17
 blinks	—	• Batteries are just about exhausted.	• Turn the power off and replace batteries with new ones.	17
 and <i>Err</i> blink	<i>Err</i> blinks	• Batteries are exhausted during film rewind.	• Replace batteries with new ones or recharge batteries and turn the power on again. If this warning appears frequently, contact authorized Nikon dealer or service center.	17
<i>F--</i> appears	<i>F--</i> appears	• Non-CPU lens is attached or lens is not attached.	• Attach CPU lens (except IX-Nikkor). With a non-CPU lens, set the exposure mode to A or M and set the aperture with lens' aperture ring.	18, 32
<i>Err</i> and <i>E</i> blink	<i>Err</i> and <i>E</i> blink	• Film is not correctly advanced.	• Reload film.	21
<b>ISO</b> , <b>DX</b> , and <i>Err</i> blink	<i>Err</i> blinks	• Film speed is set to DX and non-DX-coded film is loaded.	• Load DX-coded film or set the film speed manually.	21, 34
<i>E</i> blinks when exposure meter is turned on	<i>E</i> blinks when exposure meter is turned on	• Film remains in the camera after film rewind is complete.	• Remove the film cartridge.	29
<i>End</i> blinks	<i>End</i> blinks	• The end of the film roll has been reached.	• Rewind film by pressing the two film rewind buttons  .	29
—	  blinks	• Autofocus is not possible.	• Focus manually.	27

# Troubleshooting—continued



LCD panel	Viewfinder	Cause	Remedy	Page
<b>H i</b> appears	<b>H i</b> appears	<ul style="list-style-type: none"> <li>Overexposure may have occurred.</li> </ul>	<ul style="list-style-type: none"> <li>In P mode, use ND filter.</li> <li>In S mode, select faster shutter speed.</li> <li>In A mode, select smaller aperture (larger f-number). (If the warning indication remains after performing above remedies in S or A mode, use ND filter as well.)</li> </ul>	46-51 48 50
<b>L o</b> appears	<b>L o</b> appears	<ul style="list-style-type: none"> <li>Underexposure may have occurred.</li> </ul>	<ul style="list-style-type: none"> <li>In P mode, use flash.</li> <li>In S mode, select slower shutter speed.</li> <li>In A mode, select larger aperture (smaller f-number). (If the warning indication remains after performing above remedies in S or A mode, use flash as well.)</li> </ul>	46-51 48 50
Electronic analog exposure display blinks	Electronic analog exposure display blinks	<ul style="list-style-type: none"> <li>Subject brightness is beyond camera's exposure range.</li> </ul>	<ul style="list-style-type: none"> <li>When the subject is bright, use ND filter and when the subject is dark, use flash.</li> </ul>	53
<b>b u l b</b> blinks	<b>b u l b</b> blinks	<ul style="list-style-type: none"> <li>Shutter speed is set to <b>b u l b</b> in S mode.</li> </ul>	<ul style="list-style-type: none"> <li>Cancel the <b>b u l b</b> by selecting 30 sec. or faster shutter speed, or select M mode to perform Long Time Exposure.</li> </ul>	48, 62
P or S blinks	<b>A</b> appears	<ul style="list-style-type: none"> <li>Non-CPU lens is attached, or no lens is attached in P or S mode.</li> </ul>	<ul style="list-style-type: none"> <li>If non-CPU lens is attached, set the exposure mode to A or M.</li> </ul>	32, 46, 48-53
Shutter speed indication blinks	<b>250</b> appears	<ul style="list-style-type: none"> <li>Shutter speed faster than sync speed is selected in S or M mode.</li> </ul>	<ul style="list-style-type: none"> <li>Release the shutter as it is to take a flash picture. (Shutter speed automatically shifts to 1/250 sec.)</li> </ul>	84

LCD panel	Viewfinder	Cause	Remedy	Page
—	<b>⚡</b> blinks for 3 sec. after flash	<ul style="list-style-type: none"> <li>Flash has fired at full output and underexposure may have occurred.</li> </ul>	<ul style="list-style-type: none"> <li>Shoot again after confirming focus distance, aperture or flash shooting distance range.</li> </ul>	79, 85
<b>Err</b> blinks	<b>Err</b> blinks	<ul style="list-style-type: none"> <li>Malfunction detected.</li> </ul>	<ul style="list-style-type: none"> <li>Release shutter again. If the warning indication remains, or this warning appears frequently, contact authorized Nikon dealer or service center.</li> </ul>	
<b>F u l l</b> blinks	<b>F u l l</b> blinks	<ul style="list-style-type: none"> <li>Shooting data is full in F100's memory.</li> </ul>	<ul style="list-style-type: none"> <li>Turn the power switch off once and on again. Warning indication disappears and additional data will not be recorded until the data in the memory is erased.</li> </ul>	
<b>⦿</b> blinks	—	<ul style="list-style-type: none"> <li>Red-Eye Reduction or Red-Eye Reduction with Slow Sync is set when a Speedlight without Red-Eye Reduction function is attached.</li> </ul>	<ul style="list-style-type: none"> <li>Use a Speedlight equipped with Red-Eye Reduction function.</li> </ul>	81
<b>o . .</b> and frame counter blink	<b>o . .</b> and frame counter blink	<ul style="list-style-type: none"> <li>Film rewind stops midway due to low battery power.</li> </ul>	<ul style="list-style-type: none"> <li>Turn the power switch off, replace batteries with new ones and rewind the film again.</li> </ul>	29, 35

In certain cases, due to static electricity or poorly loaded batteries, the F100's microcomputer may turn the camera off, even with fresh, properly installed batteries. For the same reason, the film may not advance properly. In each of these cases, to resume operation, simply turn the power off, then turn it on again. Or, remove and reinstall the batteries.

# Specifications

Type of camera	Integral-motor autofocus 35mm single-lens reflex with electronically controlled focal-plane shutter
Exposure modes	P: Programmed Auto (Flexible Program possible) S: Shutter-Priority Auto A: Aperture-Priority Auto M: Manual
Picture format	24 x 36mm (standard 35mm film format)
Lens mount	Nikon F mount (with AF coupling, AF contacts)
Lens	<ul style="list-style-type: none"> <li>• D- or G-type AF Nikkor: All functions possible</li> <li>• PC Micro-Nikkor 85mm f/2.8D: All functions except autofocus and exposure modes other than Manual possible without shifting and/or tilting the lens</li> <li>• AF Nikkor other than D/G-type (except AF Nikkor for F3AF): All functions except 3D Matrix Metering possible</li> <li>• AI-P Nikkor: All functions except 3D Matrix Metering and autofocus possible</li> <li>• IX-Nikko: Cannot be used</li> <li>• Non-CPU: Usable in Aperture-Priority Auto or Manual exposure mode, Center-Weighted or Spot Metering Electronic Rangefinder usable with lens with maximum aperture of f/5.6 or faster</li> </ul>
Viewfinder	Fixed eye-level pentaprism, built-in diopter adjustment (-3 to +1m <sup>-1</sup> )
Eyepoint	21mm (at -1.0m <sup>-1</sup> )
Focusing screen	B-type BriteView clear Matte screen III, interchangeable with optional E-type screen with grid
Viewfinder frame coverage	Approx. 96%
Finder magnification	Approx. 0.70x with 50mm lens set to infinity and -1.0m <sup>-1</sup>
Viewfinder information	Focus indications, metering system, shutter speed lock, AE lock, shutter speed, aperture lock, aperture, exposure mode, electronic analog exposure display, exposure compensation, frame counter/exposure compensation value, ready-light, five sets of focus brackets (area)
Reflex mirror	Automatic, instant-return type
Lens aperture	Instant-return type, with depth-of-field preview button



Autofocus	TTL phase detection, Nikon Multi-CAM1300 autofocus module <ul style="list-style-type: none"> <li>• Detection range: EV -1 to EV 19 (ISO 100, at normal temperature)</li> </ul>
Lens servo	<ul style="list-style-type: none"> <li>• Single Servo AF (<b>S</b>), Continuous Servo AF (<b>C</b>), Manual focus (<b>M</b>)</li> <li>• Focus Tracking automatically activated in subject's status in Single Servo AF (<b>S</b>) or Continuous Servo AF (<b>C</b>)</li> </ul>
Focus area	One of five focus areas can be selected
AF Area mode	<ul style="list-style-type: none"> <li>• Single Area AF</li> <li>• Dynamic AF (Dynamic AF Mode with Closest Subject Priority is available)</li> </ul>
Focus lock	Focus is locked by pressing  button or lightly pressing shutter release button in Single Servo AF
Metering system	TTL full-aperture exposure metering system Three metering systems selectable (limitations with lens used) <ul style="list-style-type: none"> <li>• 3D Matrix Metering</li> <li>• Center-Weighted Metering: Approx. 75% of the meter's sensitivity concentrated on the 12mm dia. circle</li> <li>• Spot Metering: 4mm dia. circle (approx. 1% of entire frame)</li> </ul>
Metering range	3D Matrix Metering: EV 0-21 Center-Weighted Metering: EV 0-21 Spot Metering: EV 3-21 (at normal temperature, ISO 100, 50mm f/1.4 lens)
Exposure meter coupling	CPU and AI combined
Exposure compensation	Exposure compensated in ±5 EV range, in 1/3 steps
Auto Exposure Lock	Detected exposure value locked by pressing  button
Auto Exposure/Flash Exposure Bracketing	Number of shots: two or three; compensation steps: 1/3, 1/2, 2/3 or 1 steps
Film speed setting	<ul style="list-style-type: none"> <li>• DX or manual selectable (manual setting effective over DX detected film speed)</li> <li>• Film speed range: DX: ISO25-5000, Manual: ISO 6-6400 in 1/3 steps</li> </ul>

# Specifications—continued

Shutter	Electronically controlled vertical-travel focal-plane shutter
Shutter speeds	<ul style="list-style-type: none"> <li>• In P, R: 30 to 1/8000 sec.</li> <li>• In S: 30 to 1/8000 sec. (in 1/3 steps)</li> <li>• In M: 30 to 1/8000 sec. (in 1/3 steps), Bulb</li> </ul>
Sync contact	X-contact only; flash synchronization up to 1/250 sec.
Flash control	<p>Controlled by five-segment TTL Multi Sensor</p> <ul style="list-style-type: none"> <li>• Automatic Balanced Fill-Flash with TTL Multi Sensor: 3D Multi-Sensor Balanced Fill-Flash compatible with SB-80DX, 50DX, 28/28DX, 27, 26, 25 and D- or G-type Nikkor lens; Multi-Sensor Balanced Fill-Flash with a Speedlight such as SB-80DX, 50DX, 30, 29s/29, 28/28DX, 27, 26, 25, 24, 23, 22s, 22, 20 and AF Nikkor other than D/G-type or Ai-P Nikkor lens (except for AF Nikkor for F3AF)</li> <li>• Center-Weighted Fill-Flash: With Speedlights SB-80DX, 50DX, 30, 29s/29, 28/28DX, 27, 26, 25, 24, 23, 22s, 22, 20 and non-CPU Nikkor lens with Center-Weighted Metering</li> <li>• Film speed range in TTL auto flash: ISO 25-1000</li> </ul>
Flash sync mode	Front-Curtain Sync (normal sync), Red-Eye Reduction, Red-Eye Reduction with Slow Sync, Slow Sync, Rear-Curtain Sync
Ready-light	Lights up when flash fully charged with Speedlights SB-80DX, SB-50DX, SB-30, SB-29s/29, SB-28/28DX, SB-27, SB-26, SB-23, etc.; blinks (3 sec. after flash) for full output warning
Accessory shoe	Standard ISO-type hot-shoe contact (sync contact, ready-light contact, TTL auto flash contact, monitor contact, GND), safety lock provided
Sync terminal	Standard JIS terminal, lock screw provided
Self-timer	Electronically controlled; timer duration: 10 sec.
Depth-of-field preview button	Stop-down lens aperture by pressing depth-of-field button
Film loading	Film automatically advances to first frame when shutter release button is pressed once (shutter and reflection mirror not activated)

Film advance	<ul style="list-style-type: none"> <li>• Automatic advance with built-in motor; <b>S</b>, <b>C</b>, <b>Cs</b> selectable</li> <li>• Film advance speed (with Continuous Servo AF (<b>C</b>), Manual exposure mode, shutter speed 1/250 sec. or faster, 36-exposure film) <ul style="list-style-type: none"> <li><b>S</b>: One frame advance</li> <li><b>C</b>: Continuous shooting Approx. 4.5 fps (AA-type alkaline-manganese batteries) Approx. 5 fps (with Multi-Power High Speed Battery Pack MB-15)</li> <li><b>Cs</b>: Continuous silent-low-speed shooting Approx. 3 fps (AA-type alkaline-manganese batteries) Approx. 3 fps (with Multi-Power High Speed Battery Pack MB-15)</li> </ul> </li> </ul>
Film rewind	<ul style="list-style-type: none"> <li>• Automatic rewind with built-in motor (activate by pressing two film rewind buttons)</li> <li>• Rewind speed with 36-exposure film and AA-type alkaline-manganese batteries: <b>C</b>: approx. 9 sec., <b>Cs</b>: approx. 19 sec.</li> </ul>
Multiple exposure	Activated using film advance mode dial
LCD panel information (illuminator built-in)	Film speed, DX indication, shutter speed lock, shutter speed, aperture lock, aperture, exposure compensation, Auto Exposure/Flash Exposure Bracketing, electronic analog exposure display, Custom, exposure mode, Flexible Program, flash sync mode, AF area mode, focus area, battery power, frame counter
Camera back	Hinged back (removable); AF area mode selector, focus area selector; changeable with Data Back MF-29
10-pin remote terminal	Equipped
Power source	AA-type battery holder MS-12 provided (four alkaline-manganese or lithium batteries); optional 3V lithium battery holder MS-13 available (for two CR123A or DL123A batteries); optional Multi-Power High Speed Battery Pack MB-15 and AA-type battery holder MS-15 are also available (for six alkaline-manganese or lithium batteries, or optional Ni-MH battery MN-15)
Power switch	Power ON, OFF and LCD panel illuminator on position

# Specifications—continued

<b>Exposure meter</b>	Auto meter shut-off 6 sec. after power turned on if no operations are performed; activated by lightly pressing shutter release button or pressing AF start button after power is turned on			
<b>Battery power confirmation</b>	 for sufficient power;  indicates batteries are nearing exhaustion; blinking  indicates batteries are just about exhausted; no indication/symbol appears when batteries are completely exhausted or improperly installed			
<b>Usable number of film rolls</b>	<b>Battery Temperature</b>	AA-type alkaline-manganese	AA-type lithium	3V lithium (with MS-13)
	+20°C (68°F)	Approx. 60	Approx. 110	Approx. 60
	-10°C (14°F)	Approx. 3	Approx. 60	Approx. 25
	<b>Battery Temperature</b>	AA-type alkaline-manganese (with MB-15)	AA-type lithium (with MB-15)	Ni-MH (with MB-15)
	+20°C (68°F)	Approx. 100	Approx. 140	Approx. 70
	-10°C (14°F)	Approx. 6	Approx. 90	Approx. 50
	<i>With 36-exposure film, for Continuous Servo autofocus operation using an AF Zoom-Nikkor 28-105mm f/3.5-4.5D IF lens, in single-frame shooting, covering the full range from infinity (∞) to the closest distance and back to infinity (∞) before each shot, without intervals between shots, with a shutter speed of 1/250 sec. or faster.</i>			
	<b>Battery Temperature</b>	AA-type alkaline-manganese	AA-type lithium	3V lithium (with MS-13)
	+20°C (68°F)	Approx. 25	Approx. 40	Approx. 20
	-10°C (14°F)	Approx. 1	Approx. 20	Approx. 10
<b>Battery Temperature</b>	AA-type alkaline-manganese (with MB-15)	AA-type lithium (with MB-15)	Ni-MH (with MB-15)	
+20°C (68°F)	Approx. 35	Approx. 60	Approx. 20	
-10°C (14°F)	Approx. 3	Approx. 25	Approx. 15	
<i>With 36-exposure film, for Continuous Servo autofocus operation using an AF Zoom-Nikkor 80-200mm f/2.8D ED lens, in single-frame shooting, lightly pressing the shutter release button for 8 sec. and covering the full range from infinity (∞) to the closest distance and back to infinity (∞) before each shot, with a shutter speed of 1/250 sec. or faster. After the exposure meter automatically turns off (1 sec.), the same operation follows for the next shot.</i>				

<b>Duration of Long Time (Bulb) exposure</b>	<b>Battery Temperature</b>	AA-type alkaline-manganese	AA-type lithium	3V lithium (with MS-13)
	+20°C (68°F)	Approx. 4 hours	Approx. 7 hours	Approx. 3 hours
	-10°C (14°F)	Approx. 1.5 hours	Approx. 5 hours	Approx. 2.5 hours
<b>Battery Temperature</b>	AA-type alkaline-manganese (with MB-15)	AA-type lithium (with MB-15)	Ni-MH (with MB-15)	
	+20°C (68°F)	Approx. 8 hours	Approx. 10 hours	Approx. 4 hours
	-10°C (14°F)	Approx. 2 hours	Approx. 6 hours	Approx. 2.5 hours
<b>Tripod socket</b>	1/4 (ISO1222)			
<b>Custom Setting</b>	22 Custom Setting menus are available * See pages 110-111 for details.			
<b>Two-Button Reset</b>	Pressing the <b>CS</b> and <b>MODE</b> buttons simultaneously and holding them for more than 2 sec. resets various settings to their original default settings (with some exceptions)			
<b>Dimensions (W x H x D)</b>	Approx. 155 x 113 x 66mm (6.1 x 4.5 x 2.6 in.)			
<b>Weight (without batteries)</b>	Approx. 785g (27.7 oz.)			
<b>Optional exclusive accessories</b>	Data Back MF-29, 3V lithium battery holder MS-13, Multi-Power High Speed Battery Pack MB-15, Ni-MH Battery MN-15, Quick Charger MH-15, E-type focusing screen, Soft case CF-57/58			

All specifications apply when fresh AA-type alkaline-manganese batteries are used at normal temperature (20°C/68°F).

Specifications and design are subject to change without notice.



- A**
- AF area mode.....23, 38, 86
  - AF-Assist Illuminator .....42, 83, 92
  - Aperture-Priority Auto exposure mode .....50, 84
  - Auto Exposure Bracketing .....57, 73
  - Auto Exposure/Flash Exposure Bracketing .....57, 73
  - Auto Exposure Lock.....54, 75
  - Autofocus .....22, 36, 42
  - Automatic Balanced Fill-Flash with TTL Multi Sensor .....78, 82
- C**
- Center-Weighted Metering .....30, 33, 45
  - Center-Weighted Fill-Flash .....78, 82
  - Continuous shooting .....35
  - Continuous silent low-speed shooting .....35
  - Continuous Servo AF .....23, 36
  - CPU Nikkor lens .....19, 32-33, 78
  - Custom Setting .....69
- D**
- Depth of field.....50, 68
  - Dioptr adjustment.....63
  - Distance information .....30, 44, 78
  - D-type Nikkor lens.....18-19, 32-33
  - DX-coded film .....20, 34
  - Dynamic AF mode .....38, 72, 86
  - Dynamic AF Mode with Closest Subject Priority .....38, 72, 86
- E**
- Exposure compensation .....56
  - Exposure meter .....17, 74
  - Exposure metering system .....30, 33, 44
  - Exposure mode.....24, 33, 46-53
- F**
- Film advance mode.....21, 35
  - Flash Exposure Bracketing .....57, 73
  - Flash shooting distance range .....85
  - Flash sync mode.....76, 80, 84
  - Flexible Program .....47, 76
  - Focus brackets (area).....22, 27, 37
  - Focus Lock.....40, 42, 75
  - Focus mode .....22, 36
  - Focus Tracking .....36, 68
  - Front-Curtain Sync.....80, 84
- G**
- G-type Nikkor lens .....18-19, 32-33

- L**
- LCD illuminator.....63, 74
  - Long Time Exposure (Bulb).....62
- M**
- Manual exposure mode .....52, 62
  - Manual focus.....42, 43
  - Manual focus with electronic rangefinder .....33, 43
  - Matrix Metering .....30, 33, 44
  - Maximum aperture .....50, 52
  - Minimum aperture .....18, 46, 68
  - Monitor Pre-Flash.....78
  - Multiple exposure.....60, 73
  - Multi-Sensor Balanced Fill-Flash ..78, 87
- P**
- Programmed Auto exposure mode .....24, 46
- R**
- Ready-light .....79, 85
  - Rear-Curtain Sync.....81, 82, 84
  - Red-Eye Reduction .....81, 82, 84
  - Red-Eye Reduction with Slow Sync.....80, 84
  - Remote control operation .....94
- S**
- Self-timer .....67, 74
  - Shutter-Priority Auto exposure mode .....48, 84
  - Single Area AF mode .....23, 38, 86
  - Single-frame shooting .....21, 35
  - Single Servo AF.....22, 36
  - Slow Sync flash.....80
  - Spot Metering .....30, 33, 45
  - Standard TTL flash.....78, 82
  - Sync shutter speed .....84
- T**
- 3D Multi-Sensor Balanced Fill-Flash .....78, 82
  - 3D 10-Segment Matrix Metering .....30, 33, 44
  - Two-Button Reset.....76

# Custom Setting Menu

	Function	Options
1	Automatic film rewind at the end of film roll	⓪: Disabled (initial setting) Ⓛ: Enabled
2	Change of steps of the exposure values (shutter speed, aperture, exposure compensation or compensated EV value in Bracketing)	3: 1/3 steps (initial setting) 2: 1/2 steps 1: 1 steps
3	Bracketing order	⓪: Initial setting (See pages 58-59.) Ⓛ: From negative value to positive value
4	Autofocus activated when shutter release button lightly pressed	⓪: Enabled (initial setting) Ⓛ: Disabled
5	Warning indications with non-DX-coded film	⓪: After film is advanced to the first frame (initial setting) Ⓛ: When the power switch is on
6	Focus area selection changed to continuously in the same direction	⓪: Disabled (initial setting) Ⓛ: Enabled
7	Auto Exposure Lock when shutter release button is lightly pressed	⓪: Disabled (initial setting) Ⓛ: Enabled
8	Film advance with closing the camera back (when power switch is on)	⓪: Disabled (initial setting) Ⓛ: Enabled
9	Dynamic AF Mode with Closest Subject Priority in Single Servo AF	⓪: Enabled (initial setting) Ⓛ: Disabled
10	Dynamic AF Mode with Closest Subject Priority in Continuous Servo AF	⓪: Disabled (initial setting) Ⓛ: Enabled
11	Auto Exposure/Flash Exposure Bracketing options	Ⓐ5: Simultaneous activation of Auto Exposure/Flash Exposure Bracketing (initial setting) ⒶE: Only Auto Exposure Bracketing activated 5b: Only Flash Exposure Bracketing activated
12	Switching Command Dial operations	⓪: Disabled (initial setting) Ⓛ: Enabled

	Function	Options
13	Easy Exposure Compensation	⓪: Disabled (initial setting) Ⓛ: Enabled
14	Film advance in multiple exposure	⓪: Single frame shooting (initial setting) Ⓛ: Continuous shooting
15	Delay time for auto meter-switch off	4 : 4 sec. 6 : 6 sec. (initial setting) 8 : 8 sec. 16 : 16 sec.
16	Delay time for self-timer operation	2 : 2 sec. 5 : 5 sec. 10 : 10 sec. (initial setting) 20 : 20 sec.
17	LCD illuminator activated by pressing any button	⓪: Disabled (initial setting) Ⓛ: Enabled
18	Data imprint (year/month/day/hour/minute) on frame #0	⓪: Disabled (initial setting) Ⓛ: Enabled
19	Aperture control	⓪: Aperture value remains (initial setting) Ⓛ: Aperture step from the lens' maximum remains unchanged
20	Shutter release confirmation with self-timer LED	⓪: Disabled (initial setting) Ⓛ: Enabled
21	AE-L/AF-L button options	⓪: Simultaneous Auto Exposure/autofocus lock operation (initial setting) Ⓛ: Auto Exposure lock only 2: Autofocus lock only 3: Auto Exposure lock remains after removing finger from the button
22	Aperture setting with lens' aperture ring	⓪: Disabled (initial setting) Ⓛ: Enabled

To create Custom Setting: Rotate the Main-Command Dial while pressing the **CS** button to select menu number and rotate the Sub-Command Dial to select desired option number or character. See pages 70-75 for details.

No reproduction in any form of this manual, in whole or in part (except for brief quotation in critical articles or reviews), may be made without written authorization from NIKON CORPORATION.

***Nikon***

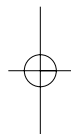

**NIKON CORPORATION**

FUJI BLDG., 2-3, MARUNOUCHI 3-CHOME,  
CHIYODA-KU, TOKYO 100-8331, JAPAN