

Nikon



INSTRUCTION MANUAL

NOMENCLATURE

Shutter-speed dial lock

Shutter release button lock

Neckstrap eyelet

Shutter release button

Depth-of-field preview button

Self-timer/Memory lock

Shutter-speed dial

Lens mounting flange

Reflex mirror

Battery chamber

Film rewind knob

Camera back latch release

Threaded sync terminal

Exposure compensation ring

Film-speed dial lock

Lens release button

Mirror lockup lever

Lens mounting index

Coupling lever release

Meter coupling lever

Film rewind button

Auto winder

film-advance coupling

Auto winder electrical contacts

Tripod socket

Distance scale

Aperture/Distance scale index

Focusing ring

Meter coupling shoe

Aperture ring

Depth-of-field indicators

Meter coupling ridge

ASA film-speed dial

Shutter-speed scale

ASA film-speed scale

Frame counter

Film rewind crank

Meter ON index

Film-speed scale index

Film-advance lever

Power check button

Film-plane indicator

Power check lamp

Viewfinder eyepiece

Accessory shoe

Hot-shoe contact

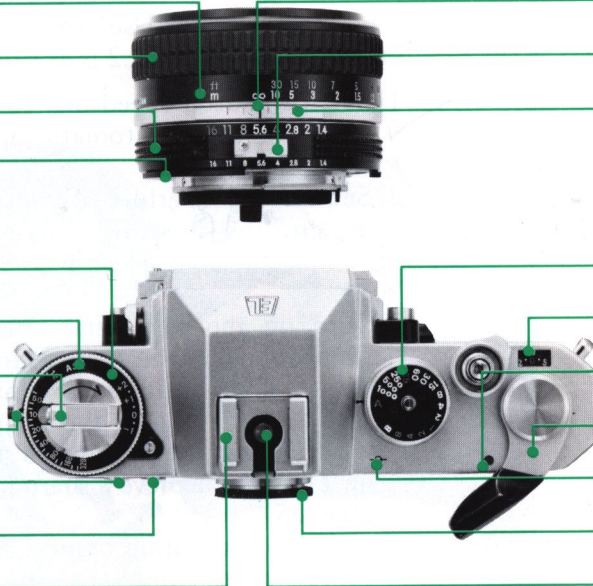

BRIEF GUIDE TO CAMERA HANDLING

The Nikon EL2's conveniently-placed controls and fully automatic shutter facilitate operation under even rapidly changing conditions. After performing the preliminary steps as presented in "Preparation for Use" (pages 8 ~ 12), shooting with the Nikon EL2 is as simple as:

- 1) Set the shutter speed dial to "A" to prepare the camera for automatic operation, as detailed on page 13.
- 2) Set the lens aperture to the setting appropriate for the shooting situation at hand by turning the aperture ring, as detailed on page 14.
- 3) Turn on the meter and shutter control by simply moving the film-advance lever to the 30° standoff position, as detailed on page 14.
- 4) View/focus/compose the subject through the viewfinder, turning the lens' focusing ring as necessary to achieve a sharp image (see pages 20 ~ 25).
- 5) Assume a shooting stance and depress the shutter button to expose the film (see pages 18 and 19).

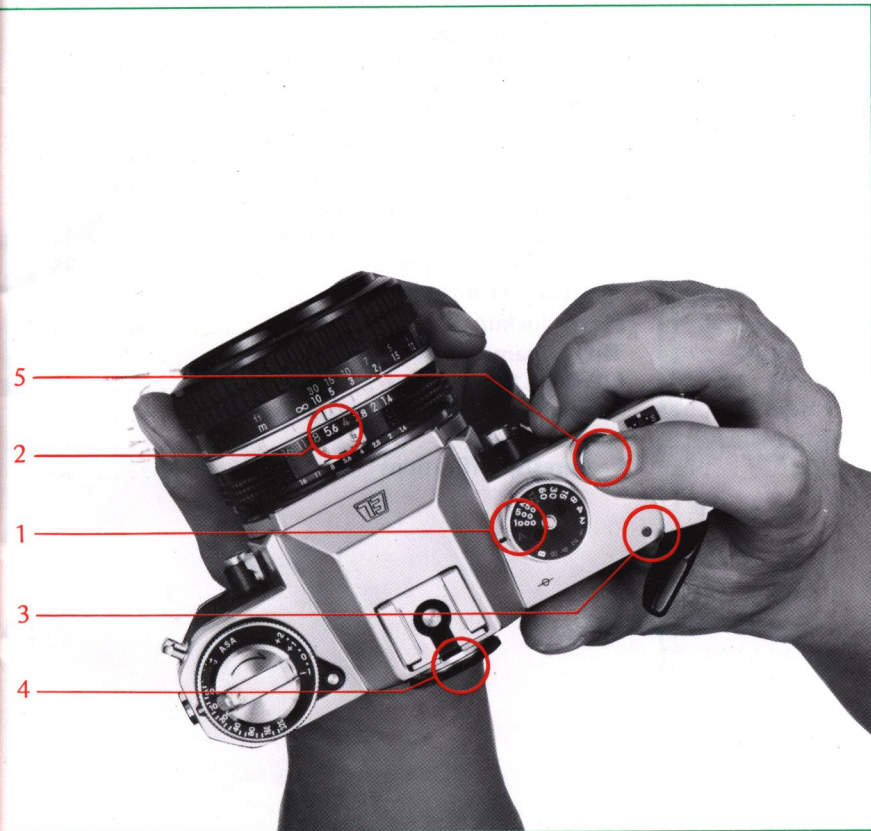

CONTENTS

Foreword	7	Exposure measurement	26
Preparation for use	8	Automatic shutter speed selection	26
Installing the battery	8	Manual shutter speed selection	28
Removing the battery	9	Exposure control	29
Checking the battery	9	Metering range	30
Loading the film	10	High-contrast lighting situations	30
Prior to shooting	11	Stop-down exposure measurement	32
Operation of camera controls	12	Exposure compensation adjustments	34
Setting the film speed	12	EV range of the camera	35
Setting the shutter speed	13	Flash synchronization	38
Setting the aperture	14	Mirror lockup	39
Film-advance lever	14	Tips on camera care	40
Frame counter	15	Changing the lens	42
Shutter release button lock	15	Coupling lever lock/release operation	43
Self-timer	16	Accessories	44
Memory lock	16	Features/specifications	46
Unloading film	17		
Holding the camera	18		
Shutter release operation	19		
Operation via cable release	19		
Focusing	20		
Infrared photography	22		
Film-plane indicator	22		
Depth of field	23		
Depth-of-field preview button	23		
Depth-of-field indicators	24		

FOREWORD

The Nikon EL2 camera offers the serious photographer the highest standard of quality, performance, convenience and versatility available in an auto 35mm SLR camera. The EL2 is engineered to take the guesswork out of photography with automatic features anyone can learn to use in minutes. To get the most out of your Nikon EL2 camera, study the instructions carefully and practice using the controls before you load any film in the camera. Keep this booklet handy for ready reference until you have mastered its basics, and follow the suggestions for camera care given on page 40. The few moments you spend familiarizing yourself with the camera will guarantee you the best results and increase your picture-taking enjoyment many times over.

PREPARATION FOR USE

Installing the Battery

DURACELL PX28

The exposure measurement and shutter control circuits of the EL2 are powered by a single 6-volt (type 544) battery mounted in the battery chamber at the bottom of the mirror box. To install the battery, first remove the lens (if mounted) from the camera body (see page 42) and lock up the mirror (turn the lockup lever upward as far as it will go, as described on page 39) to gain access to the battery chamber. Then, open the battery chamber (slide the lid to the left, then up) and install the battery, making sure to properly align the positive (+) and negative (-) terminals of the battery as depicted on the interior of the lid. After

inserting and properly seating the battery, snap the chamber lid shut, unlock the mirror and remount the lens preparatory to shooting.

Caution: Should the battery be installed incorrectly (i.e., in the reverse direction) in the chamber, its energy will be depleted in a matter of minutes; thus, take extra care to insert the battery properly. Also, be careful not to touch the shutter curtain and mirror surface while installing the battery.

Note: Remove the battery when the camera is not to be used for a long period; this will prevent leakage within the camera. Also, keep the camera as warm as possible when operating under cold-weather conditions; otherwise, the battery may fail to function. (See "Tips on Camera Care" on page 40 for additional information.)

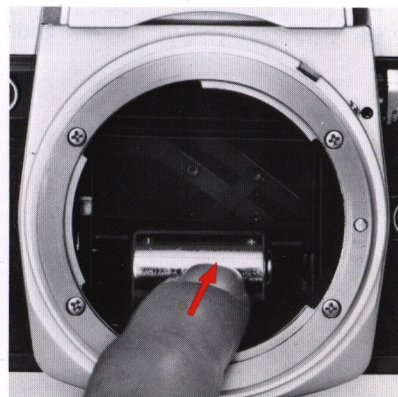
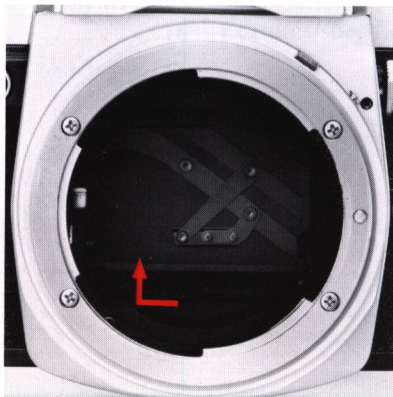

Removing the Battery

The battery chamber's built-in ejector-type mechanism makes for easier removal operation when removing/replacing the battery. To remove the battery from the camera, take off the lens and lock up the mirror as mentioned previously. Then, while holding the camera upside-down, release the battery chamber lid and push it slightly toward the back of the mirror box until the battery drops free of the chamber. After removing the battery, install a fresh one as explained previously.

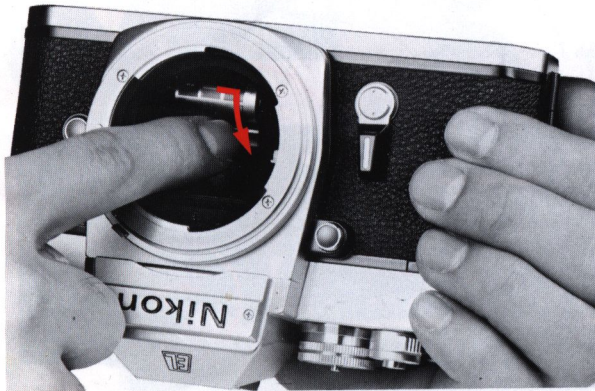

Checking the Battery

The EL2 is provided with a special circuit that enables the photographer to check the battery power condition without causing excessive battery drain which might occur by having to turn the camera on. To check battery power, simply depress the power check button and watch the power check lamp for indication of the power level. If the check lamp glows, battery power is sufficient. If the lamp fails to glow, battery positioning should be checked; then, if the lamp still fails to glow, replace the battery.

Note: When checking battery power, hold the button depressed only long enough for the check lamp to glow; prolonged depressing only serves to drain battery power.

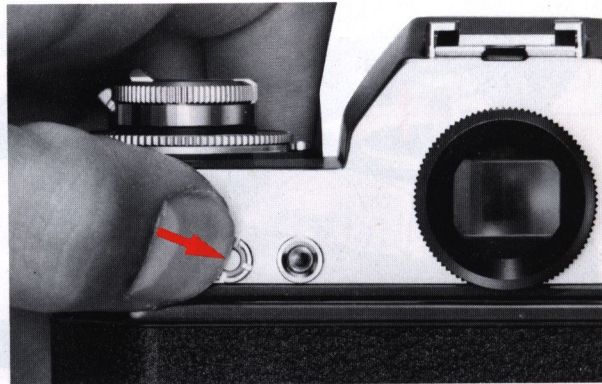

PREPARATION FOR USE—continued

Loading the Film

Slide the camera back latch release at the side of the rewind knob to the rear and, while holding the release back, lift the rewind knob up until the camera back pops open. Then, with the rewind knob in the up position, drop a standard film cartridge (a Nikon reloadable-type cassette cannot be used) into the left-hand film chamber with the film leader aligned along the film guide rails.

After positioning the cartridge and film leader properly, push the rewind knob down to hold the cartridge in place and, then, insert the end of the film leader into

any of the slots in the film take-up spool. If necessary, release the shutter and, then, stroke the film-advance lever slowly to make sure that the leader winds smoothly on the spool and that the film edge perforations engage with the film sprocket roller. When satisfied that the film is properly feeding and is traveling correctly along the film guide rails, snap the camera back shut to seal the film chamber. (Also, see “Tips on Camera Care” on page 40.)

Caution: When loading film, be sure to shade the camera from direct exposure to sunlight to prevent inadvertent “fogging” of the film.

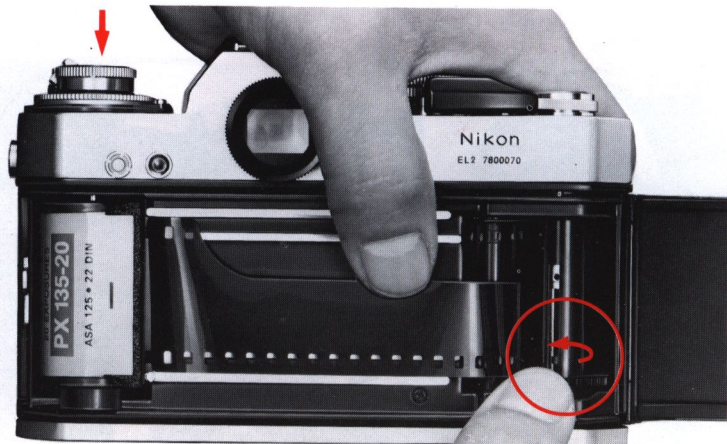

Prior to Shooting

Fold out the rewind crank and turn it gently in the direction of the engraved arrow until you feel a slight tension; this tension indicates that there is no more slack in the film cartridge. (Be sure not to rewind the film back into the cartridge.)

Advance the film and make two blank exposures to dispose of the initial portion of the film exposed during loading (for film advance operation, see page 14). While

advancing the film, check that the rewind crank turns in the direction opposite the arrow. Crank rotation indicates that the film has been loaded properly and is being advanced. Then, fold the crank flat for storage. After advancing the film two frames to dispose of the initial portion of the leader, the frame counter at the upper right of the camera will indicate "0"; now, advance the film one more frame to prepare the camera for taking the first exposure.

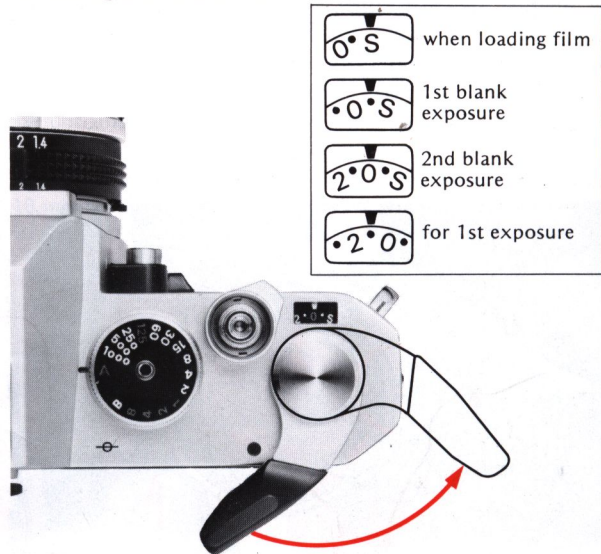
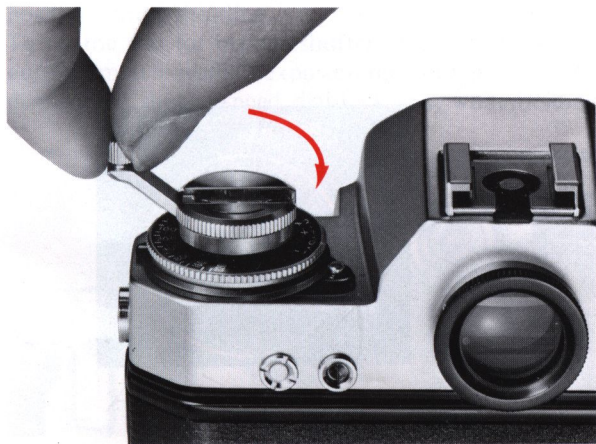

OPERATION OF CAMERA CONTROLS

Setting the Film Speed

As film response sensitivity during exposure to light (called "film speed") varies with film type, adjustment of the camera's metering circuit is essential to ensure uniform exposures under all operational conditions. Thus, a film-speed dial (ASA graduations) is provided for this purpose, with a safety lock mechanism built-in to prevent accidental shifting of the dial during shooting. To set the film speed, depress the film-speed dial lock and, while holding the lock depressed, turn the ASA

film-speed dial until the red index mark is aligned with the ASA value for the film in use. After setting the dial, release the lock and test the dial to ensure that it is set firmly at the desired ASA value. The meter is sensitive across the full range of from ASA 12 to ASA 3200. The film-speed dial has two graduations between each pair of numbers for intermediate settings such as 64, 80, 125, etc. The figure below indicates the values for all intermediate settings.

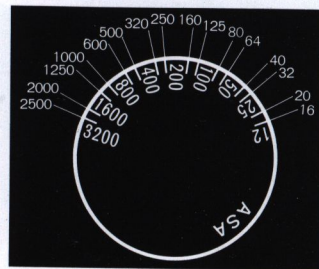
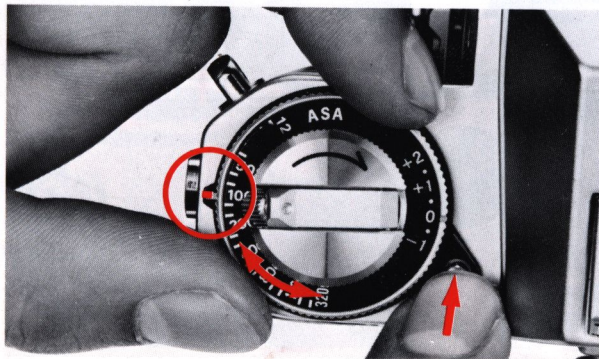

Setting the Shutter Speed

The Nikon EL2 is set for automatic or manual shutter speed selection via the shutter-speed dial positioned to the right of the finder, with setting operation possible at any time either before or after the shutter is wound. The dial is provided with positions for automatic ("A"), speeds of from 8 seconds to 1/1000 second, and a "B" setting. To set the dial for automatic shutter speed selection, simply rotate the dial clockwise until the green "A" (automatic) setting clicks and locks into place aligned with the shutter-speed scale index at the base of the dial; the built-in locking mechanism ensures that the dial cannot be accidentally shifted from the automatic position during shooting.

To set the dial for manual shutter speed selection used during "match-needle" exposure measurement, simply depress the shutter-speed dial lock and, while holding

the lock depressed, rotate the dial counterclockwise off of the "A" position; when the dial is aligned with white settings of from 2 to 1000, the actual shutter speed is a fractional value of from 1/2 second to 1/1000 second, while the remaining settings indicate the actual values of from 8 seconds to 1 second. The red "125" setting indicates that the 1/125 second shutter speed is the fastest speed providing X synchronization for use with electronic flash units. At the "B" setting, the shutter remains open as long as the shutter-release button is depressed. If you have forgotten to install the battery, the shutter gives a mechanically fixed speed of 1/90 second regardless of the dial position. (See "Flash Synchronization" on page 38 for additional information on flash photography.)

Note: At the "B" setting, exposures up to approximately 8 to 10 minutes are possible. If longer times are required, your camera will require adjustment at a Nikon Authorized Dealer.

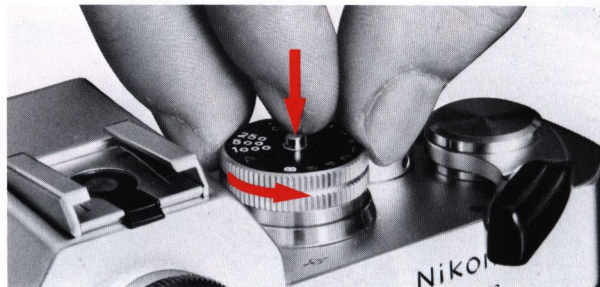
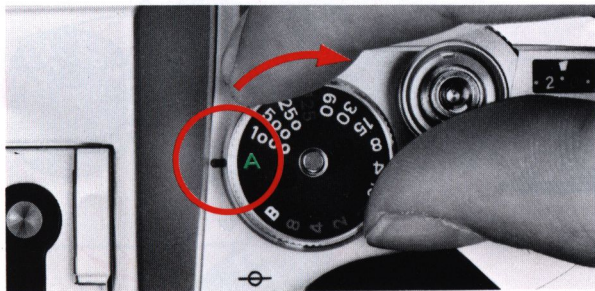

OPERATION OF CAMERA CONTROLS – continued

Setting the Aperture

The ring fitted at the base of the lens adjusts the size of the aperture (or opening) in the iris diaphragm. To pre-set the lens aperture, turn the aperture ring until the desired f/number setting on the scale is aligned with the index mark provided on the lens. The iris diaphragm can also be set to intermediate apertures between the click-stop settings for more precise exposures.



Film-Advance Lever

The film-advance lever simultaneously advances the film, cocks the shutter and operates the frame counter. It also switches on the exposure meter in the finder and unlocks the shutter-release button. To advance the film, stroke the lever with the right thumb in a single stroke totaling only 135° . A built-in locking device prevents the shutter from being released unless it is fully cocked and the film advanced a full frame. At the completion of film advance, release the lever and it will return to the 30° standoff position ready for shutter release.

Note: Do not apply pressure to the film-advance lever while making an exposure.

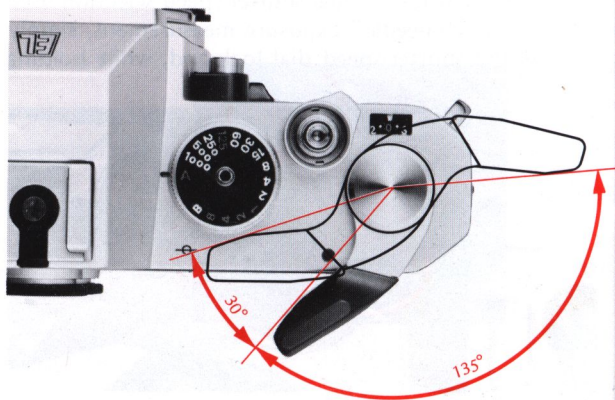

Frame Counter

The frame counter operates automatically to show how many frames have been exposed. When the camera back is opened for loading, the counter is reset to the "S" (start) position, two frames before "0." Once the camera is loaded and the back closed, each film-advance/shutter-release sequence will cause the frame counter to advance one position until the maximum 20 or 36 frames have been exposed. The dial of the frame counter is calibrated with dots (for odd numbers) and figures (for even numbers), and with settings of "S," "20" and "36" in red.

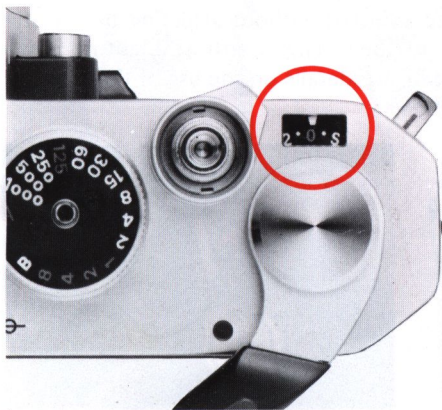

Shutter Release Button Lock

A special control is fitted around the base of the shutter release button to provide for greater ease of operation when using the EL2 with the Auto Winder AW-1 mounted for automatic film advance. With the shutter release button lock, the film-advance lever's meter ON/OFF and shutter button lock functions are duplicated to enable positioning of the lever flush to the body while using the Auto Winder. To operate the camera via the shutter release button lock, simply switch the lock to the left to reveal the red meter ON index; in this position, the meter is on and the shutter button is unlocked for normal release operation. When not using the Auto Winder, switch the lock back to the right and operate via the film-advance lever.

Note: Whenever the camera is stored, be sure that the shutter release button lock is set to the right-side position covering the red dot to ensure against accidental battery drain.

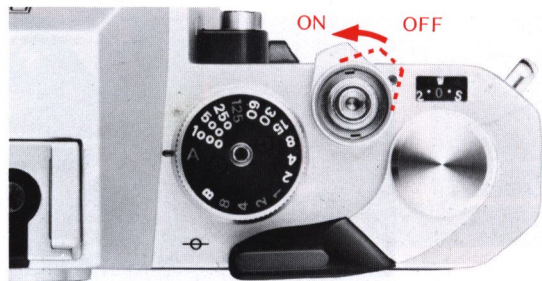

OPERATION OF CAMERA CONTROLS — continued

Self-Timer

The built-in self-timer can be used to trip the shutter after a delay of approximately 10 seconds, and it will operate whether the shutter speed dial is set for automatic or manual shutter speed selection. To take a picture using the self-timer to fire the camera, first set the aperture and shutter-speed controls, advance the film, and cock the self-timer by turning its lever downward as far as it will go; then, simply depress the shutter release button to start the countdown, with shutter release occurring at the completion of the cycle (note that the mirror will rise as the shutter button is depressed and return at the end of the cycle). Note that the self-timer can be set either before or after advancing film; however, once cocked, it cannot be reset except by pressing the shutter release button. The self-timer may not be used at the “B” shutter-speed dial setting.



Memory Lock

The convenient location of the self-timer lever, making for ready finger access, proves advantageous when using the built-in memory lock function. Memory lock enables the photographer to retain an exposure measurement taken close-up to the subject, or via selective composition through the viewfinder, by “locking in” the reading taken prior to operating the lock. To operate the memory lock, view through the finder and meter on the selected area; then, simply push the lever toward the lens to hold the reading until the completion of the exposure. The reading will be retained as long as the control is held in this position. Thus, several frames can be exposed using the same locked reading. Also, the aperture can be adjusted without affecting the shutter speed locked in. (See “High-Contrast Lighting Situations” on page 30 for details on the use of the memory lock function.)

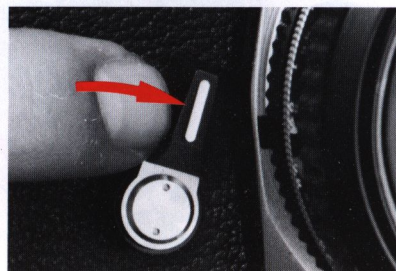

UNLOADING FILM

When the frame counter indicates the last exposure has been made, or when the film-advance lever can no longer be stroked, the roll of film has been fully exposed and it should be removed from the camera.

To unload the camera, first press the rewind button on the camera baseplate; then, unfold the rewind crank and turn it in the direction of the engraved arrow, using a smooth, even pressure. When no more tension is felt, the film leader has left the take-up spool and the camera back may be opened as explained previously.

After opening the camera back, carefully lift the film cartridge free of the film chamber. Note that as the film-advance lever is stroked for the next exposure, the rewind button will be released to engage the film-advance mechanism.

Caution: Be careful not to push the rewind button during film-advance operation, as temporary film stoppage and double exposure may occur. Also, do not attempt to force the advance lever at the completion of the roll, as this can result in tearing the film out of the cartridge.

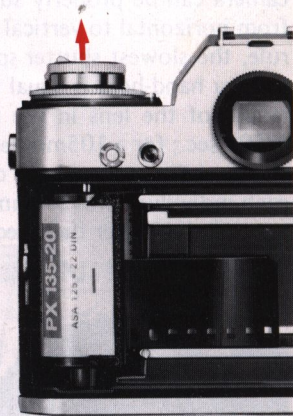
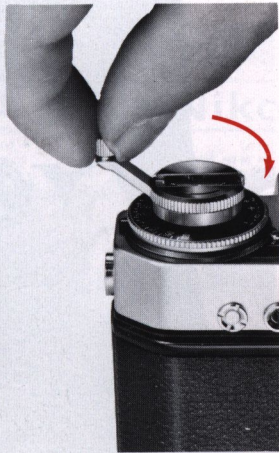
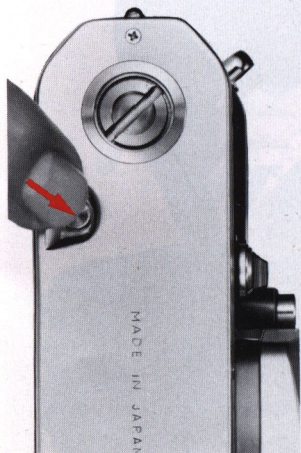

HOLDING THE CAMERA

Camera shake is one of the most common causes of unsharp pictures, especially at slow shutter speeds. Learn to hold the camera correctly and practice steady shutter squeezing. The photos show the best ways to hold the camera for sharp pictures.

Wrap the fingers of the right hand around the camera body so that the index finger rests comfortably on the shutter-release button and the thumb fits between the camera body and the film-advance lever. Position the camera so that the eye looks through the center of the viewfinder. Cradle the camera in the left hand for additional support, with the left thumb and index finger grasping the focusing ring. From this basic stance, the camera can be properly supported and easily switched from horizontal to vertical format shooting. As a general rule, the slowest shutter speed you should use with the camera hand-held is equal to the reciprocal of the focal length of the lens in use (e.g., for a 500mm lens, use 1/500 sec.; for a 105mm lens, use 1/125 sec.). However, as the ability to hold the camera steady may vary with each individual, we recommend that you experiment. In general, the higher the selected shutter speed, the sharper the picture.

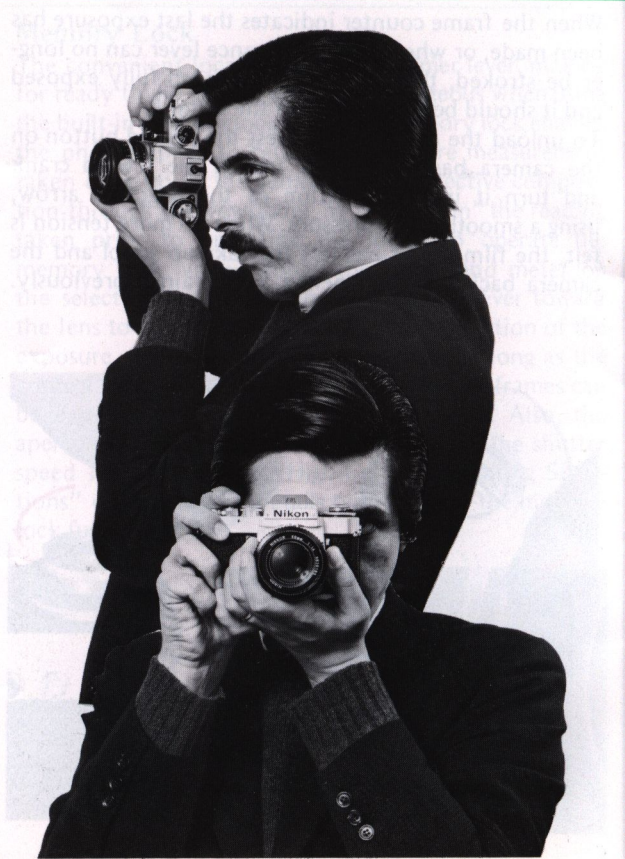

SHUTTER RELEASE OPERATION

For sharp pictures, correct shutter releasing is just as important as steady camera holding. After advancing the film to a fresh frame, the camera is set for shutter release via the button provided at the upper right. When taking the picture, hold the camera steady (as explained previously), relax and depress the button using a steady even pressure to release the camera's shutter—remember, a quick jab of the finger will cause camera movement and may result in a blurred photograph.

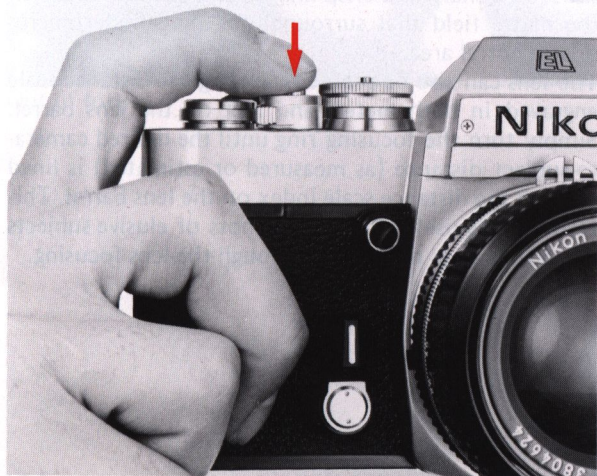

Operation via Cable Release

The shutter-release button can also be tripped via a cable release or similar accessory for more vibration-free operation when the camera is tripod-mounted and operated at slow shutter speeds. And, as two mounting threads are provided, virtually any type cable release can be used. To attach an ISO-thread release (Nikon model AR-3, etc.), screw the connector into the V-shaped thread in the center of the button. For Nikon-thread releases (model AR-2, etc.), screw the connector onto the threads provided around the button. The shutter is then tripped by depressing the release plunger.





Focusing is done at full aperture with Nikkor lenses fitted with an automatic diaphragm. This technique provides the brightest possible images on the focusing screen for easy focusing and composing. It also minimizes depth of field so that the image snaps in and out of focus distinctly.

The Nikon Type K screen comes with the camera as standard equipment. To focus, turn the focusing ring on the lens until the two halves of the rangefinder image coincide to form a single, crisp image; when using the microprism ring, turn until the microprism pattern shifts to a sharp and crisp image. You can also focus on the matte field that surrounds the rangefinder/microprism central area.

The lens can also be prefocused using the distance scale engraved in both meters and feet on the lens barrel. Simply turn the focusing ring until the desired camera-to-subject distance (as measured or estimated) is lined up with the distance scale index on the lens barrel. This technique is useful for candid shots of elusive subjects when time does not permit through-the-lens focusing.

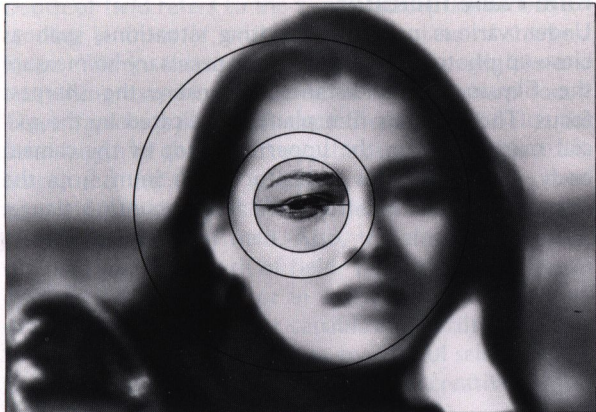

Out of focus

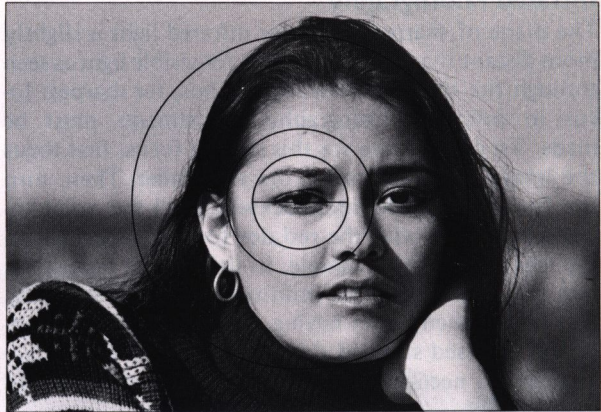

In focus

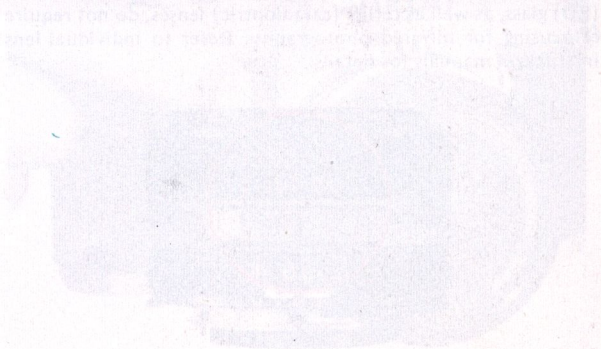
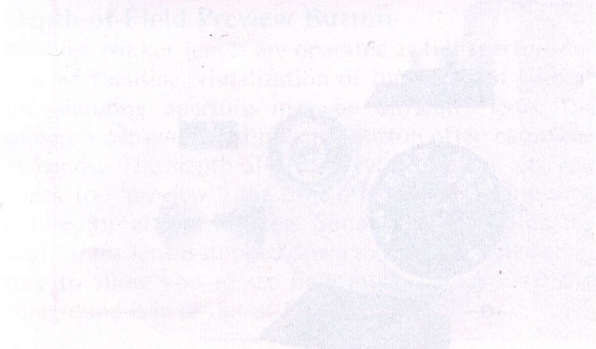

FOCUSING — continued

Infrared Photography

The plane of sharpest focus for infrared light is slightly more distant than its counterpart for visible light as seen through the camera's viewfinder. Thus, for sharpest focus in infrared photography, adjustments must be made. To compensate for this shift in focus, first focus the image sharply through the viewfinder. Then, turn the focusing ring counterclockwise until the point focused is aligned with the red dot (or line) provided on the lens barrel. For example, in the picture below, the lens has been focused for infinity (∞) infrared shooting. Note that when lenses having a focal length of 50mm or less are used stopped down to f/8 or below, no adjustment is necessary due to the large depth of field available.

Note: Some new optics using Nikon's Extra-low Dispersion (ED) glass, as well as reflex (catadioptric) lenses, do not require refocusing for infrared photography. Refer to individual lens instruction manuals for details.



Film-Plane Indicator

Under various precision shooting situations, such as close-up photography, it is often necessary to measure the film-to-subject distance to ensure the sharpest focus. The camera's film plane is indicated by the special mark (\ominus) on the upper right top of the camera body. Note that this indicator is 46.5mm from the front surface of the camera's lens mounting flange.

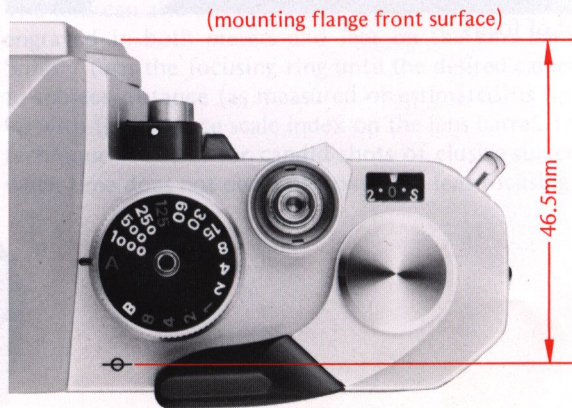

DEPTH OF FIELD

Depth of field refers to the zone of acceptable focus extending in front of, and behind, the plane of sharpest focus. Within this zone, image blur is negligible and everything may be considered as being in sharp focus. Three factors greatly influence the depth of field: the focal length of the lens in use, the camera-to-subject distance, and the taking aperture. The smaller the aperture and the shorter the focal length of the lens, the greater the depth of field. Also, the closer the subject, the shallower the depth of field. These three factors can operate independently or in conjunction with one another, with any one factor capable of partially canceling the effects of the other. Thus, by careful selection and use, the photographer can exercise wide creative control over the final picture.

Depth-of-Field Preview Button

As most Nikkor lenses are operated at full aperture for ease of focusing, visualization of the depth of field at the shooting aperture may be difficult. Thus, the camera's depth-of-field preview button often can come in handy. The depth-of-field preview button lets you check (or "preview") the zone of sharpness at any time before (or after) shooting. Simply by depressing the button, the lens is stopped down to the preselected aperture to allow you to see how much background and foreground is in or out of focus.



DEPTH OF FIELD — continued

Depth-of-Field Indicators

Depth of field can be read directly from the distance scale in meters or feet with the aid of the color-coded depth-of-field indicators engraved on the lens barrel. Each pair of colored lines on either side of the central distance scale index line corresponds to f/numbers of the same color on the aperture scale. To find the depth of field at a particular aperture, first focus the lens on the subject while looking through the viewfinder. Then check the numbers on the distance scale to determine the zone of focus for the aperture in use. The three photos shown clearly depict the changing depth of field; with the photo at the immediate right, the field is shallow at the $f/4^{\#}$ setting, while the photo at the extreme right shows a depth of field extending from approximately 2.7m (9 ft) to infinity (∞).

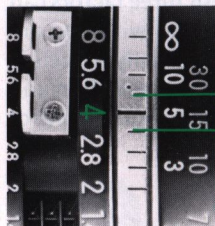

Lens set at $f/4^{\#}$: Shallow depth of field centered on the main subject.

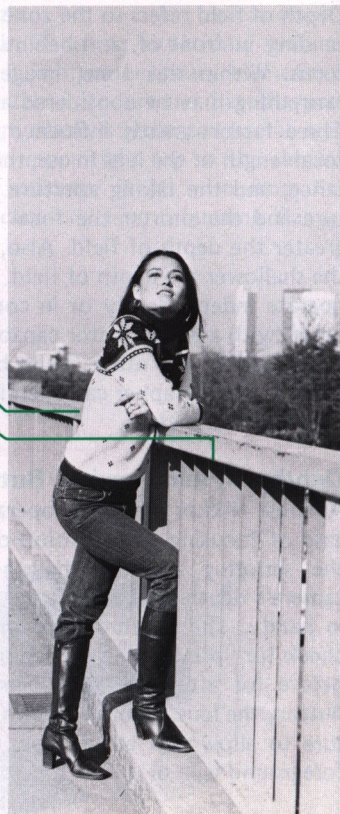

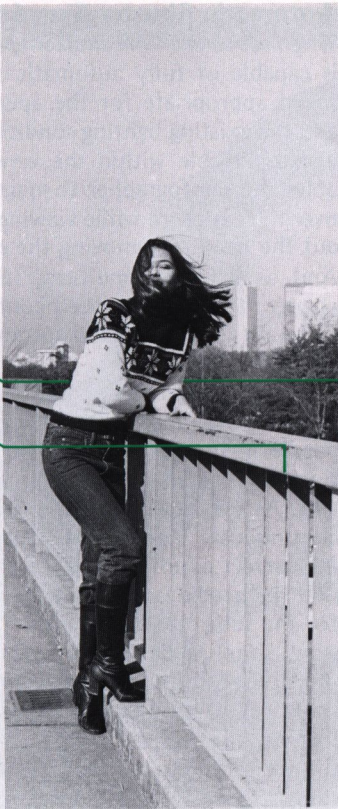
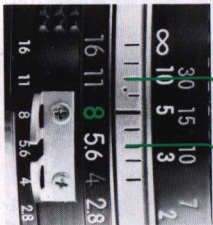

Lens at f/8: Depth of field extended in front of/behind the main subject.

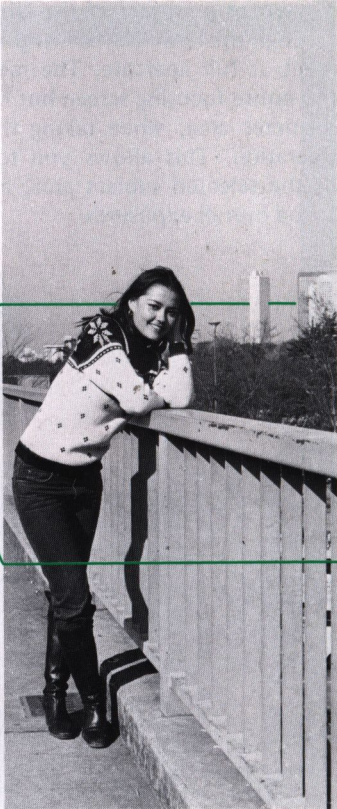
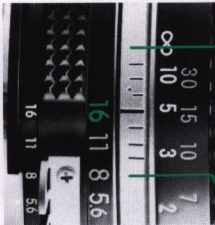

Lens at f/16: Sharp focus is extended to encompass the entire foreground and background.



EXPOSURE MEASUREMENT

The exposure meter of the Nikon EL2 utilizes Nikon's through-the-lens center-weighted exposure measurement at full aperture. The meter reads the light over the entire focusing screen but favors the central 12mm-diameter area, while taking the entire area into consideration. This allows you to make precise readings of the selected subject area, and results in more balanced overall exposures.

Automatic Shutter Speed Selection

When set to the "A" shutter-speed dial setting, the EL2 is capable of fully automatic selection of the shutter speed appropriate for the aperture setting of the lens and the existing lighting conditions. The exposure meter display, visible within the viewfield of the finder, enables the photographer to maintain continuous control over the exposure while viewing and focusing, and without the need of removing the eye from the viewfinder. And as lighting conditions (or the aperture setting) change, the shutter speed control circuit continues to maintain continuous and automatic control, for perfect exposure every time.

To take a picture using automatic shutter speed selection, first set the shutter-speed dial to "A" (the green needle in the finder will move to the upper "A" position and remain) and select an appropriate aperture setting. As you compose and focus, the black needle will continuously indicate the shutter speed being selected for correct exposure. Prior to exposing the film, verify that the needle is indicating a shutter speed appropriate for the subject; if the indicated speed is too fast or too slow, simply adjust the aperture ring on the lens until the desired shutter speed is indicated. Then, press the shutter release button to expose the film. Note that as long as the needle remains within the scale, provided the EV range of the metering system is not exceeded, the camera provides the correct exposure automatically.

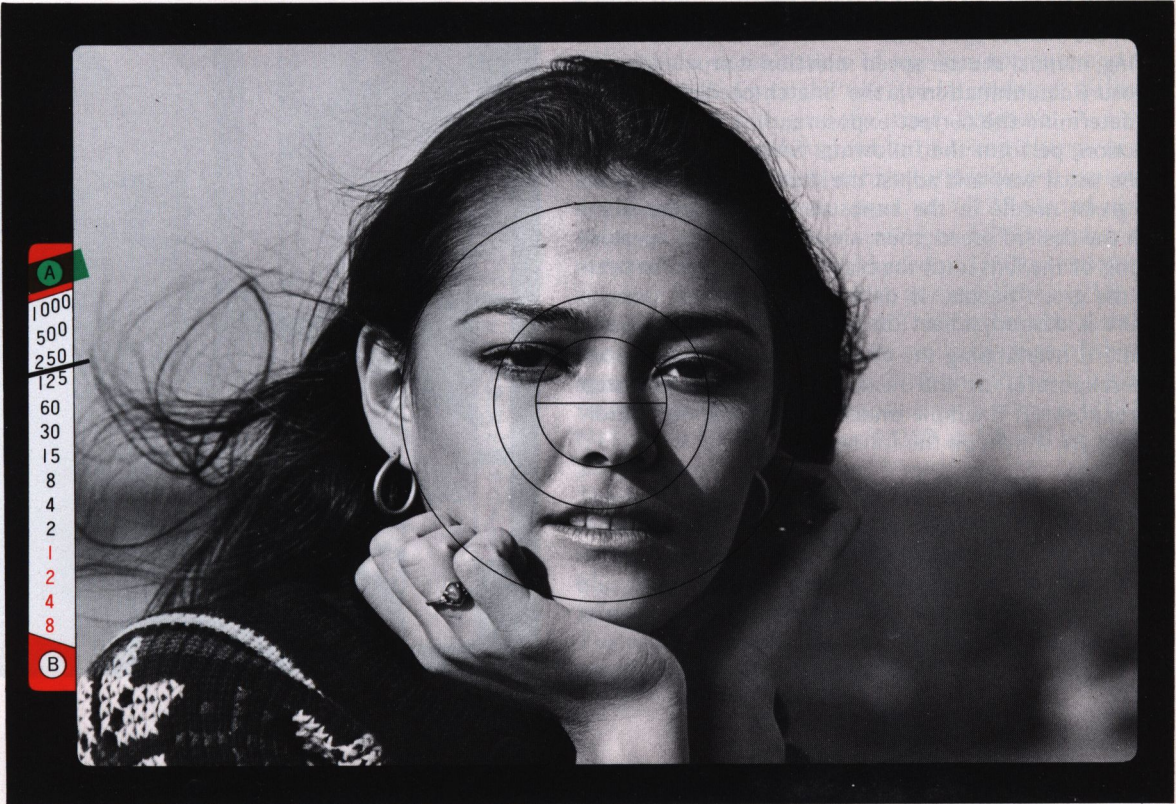

A

1000
500
250
125
60
30
15
8
4
2
1
2
4
8

B

EXPOSURE MEASUREMENT — continued

Manual Shutter Speed Selection

When the shutter-speed dial is set to other than the “A” setting, manual shutter speed selection is provided, with exposure determination via the “match-needle” method. To determine the correct exposure using manual speed selection, perform the following: Switch on the meter in the usual way and adjust the shutter-speed dial until the green needle in the exposure meter display aligns with the desired speed; then, simply adjust the aperture setting of the lens until the black needle moves to overlap the green needle. If deliberate under- or overexposure is desired, adjust the controls so that the green needle is overlapping the next higher number (one-step underexposure) or the next lower number (one-step overexposure). Example under- and overexposure indications are shown on the following page.





Deliberate
one-step
underexposure

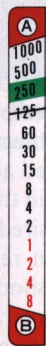
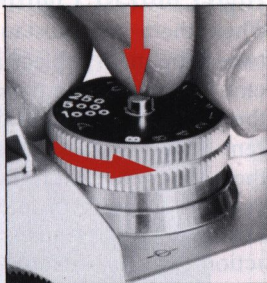

... and one-step
overexposure.

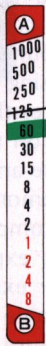

Exposure Control

The amount of light reaching the film plane is determined by a combination of the lens aperture and the shutter speed. Since the two are interrelated, different combinations will give the same exposure. A 1-step change in the shutter speed, or a 1-stop change in the aperture setting, will either halve or double the exposure. For example, a shutter speed of 1/125 second passes twice as much light as a setting of 1/250 second, and only half as much light as a speed of 1/60 second; for an aperture setting of f/11, twice as much light as f/16, and half as much as f/8, is passed. This feature characterizes the operation throughout the available range of shutter speeds and aperture settings. With this in mind, it's easy to see that if a correct exposure for a scene is 1/125 at f/11, then 1/60 at f/16 or 1/250 at f/8 will be equally acceptable.

The best combination for your needs will depend on the results desired. Use fast shutter speeds to freeze motion, or use slow speeds to produce deliberate and creative blur. Small apertures give greater depth of field, while large apertures restrict sharp focus to the main subject. The creative selection of both speeds and apertures will greatly enhance your photography.

EXPOSURE MEASUREMENT — continued

Metering Range

If the black meter needle fails to leave the “A” or “B” positions during auto (or fails to “match” the green needle in manual), even after all possible lens-aperture/shutter-speed combinations have been tried, then the available light is too bright or too dim for the meter’s range. To correct this situation, several measures may be taken, as follows: Switch to a new film (either higher or lower ASA) that more closely matches the available light; mount a neutral density filter on the lens to decrease the light reaching the film plane; or use artificial lighting (i.e., an electronic flash unit) to increase subject illumination. Remember, too, that the lens in use can greatly influence suitability for bright or dim shooting. For example, a 50mm f/1.4 lens (with ASA 100 film) couples from EV 1 (f/1.4 at 1 second) to EV 18 (f/16 at 1/1000 second) for excellent low-light performance; on the other hand, a 200mm f/4 lens proves more usable at bright-light levels, coupling (with ASA 100 film) to EV20 (f/32 at 1/1000 second). Thus, choose the lens carefully to match the existing lighting conditions.

High-Contrast Lighting Situations

When there are substantial brightness differences between the main subject and the background, unimportant bright spots or dark spots can adversely influence the finder reading, and thus the final exposure. To prevent under- or overexposure of the main subject under these shooting conditions, some corrective action must be taken to ensure proper exposure of the main subject. Fortunately, the finder’s center-weighted TTL metering action (and the memory lock function in auto) simplify adjustments, making for quicker camera operation and more accurate final results.

To compensate for an excessively bright or dark background, target the main subject in the center of the focusing screen while performing metering; this action ensures that the main emphasis of the meter reading will be on the chosen subject. Then, after completing aperture and shutter speed adjustments (and depressing the memory lock to retain the shutter speed, if set to auto), recompose to the desired picture composition and make the exposure without readjusting the camera controls. For example, when shooting landscapes, it is often advisable to aim the camera slightly downward during exposure measurement to eliminate the effects of a bright expanse of sky; without such compensation, the landscape may appear underexposed in the final print. Also, for backlit subjects, it may be necessary to move closer to the subject to ensure a proper reading.



- Metering with a bright area in the center will cause underexposure of the main subject.
- For correct exposure, first measure the main subject; then, recompose and shoot.

STOP-DOWN EXPOSURE MEASUREMENT

With some Nikkor lenses, full-aperture exposure measurement is not possible, either because the lens has no automatic diaphragm, or because the lens does not couple with the built-in meter; with certain accessories, too, lens/meter coupling is not possible, thus, preventing full-aperture measurement. However, the camera's meter can still be used for exposure measurement via the stop-down method. Before mounting the lens (or accessory) on the camera body, lock the meter coupling lever in the up position, as described in "Coupling Lever Lock/Release Operation" on page 43; the lever must remain up as long as stop-down measurement is being performed. After setting the lever, mount the lens or lens/accessory combination on the camera, switch on the meter by moving the film-advance lever to the standoff position (or moving the shutter-release button lock to the left), and then set the controls for correct exposure as follows:

For fixed-aperture lenses, such as Reflex-Nikkor lenses, choose the desired shutter speed operation mode (either automatic or manual selection) first. When automatic shutter speed selection is used, no additional settings are required; when manual speed selection is used, adjust the shutter-speed dial until the meter needles in the finder overlap. The exposure can additionally be controlled via built-in or accessory ND filters.

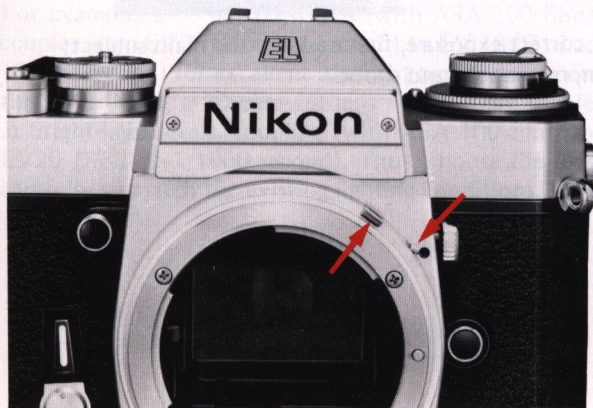

For automatic diaphragm lenses with no coupling ridge, first set the shutter-speed dial for either automatic or manual shutter speed selection. When using automatic, next depress and hold the depth-of-field button to stop-down the lens diaphragm and adjust the aperture ring until the black needle indicates the desired shutter speed; then, while holding the button depressed, press and hold the memory lock until the completion of the exposure. When using manual operation, select the desired shutter speed, depress and hold the depth-of-field button, and (while holding the button depressed) adjust the aperture ring until the meter needles in the finder overlap. Whichever mode of operation used, be sure to release the depth-of-field button prior to making the exposure.

For bellows units, extension rings and preset lenses, set the camera to the desired shutter speed (or to automatic); then, stop down the lens manually until the meter needles in the finder overlap (or the desired shutter speed is indicated); when using automatic shutter speed selection, it may be necessary to press the memory lock if the aperture is to be re-opened for focusing and/or composition. Preset-type lenses include PC-Nikkor lenses.

EXPOSURE COMPENSATION ADJUSTMENTS

Some exposure correction may be necessary when certain types of films are used for copying or photomicrography applications; the amount of correction required, however, will depend on the type of film and the specific application. The following table lists the exposure corrections in f/stops required for various film/shooting requirements. Compensation is possible by adjusting the shutter speed or the aperture by the indicated amount; also, compensation is possible by adjusting the special ring provided for this purpose. To adjust the exposure compensation ring, simply lift and turn it until the index mark is aligned with the value corresponding to the amount of compensation. In the example shown, the index is set to the +1 position, as required when performing photomicrography using Panchromatic film.

Original Type of film	Repro-copying & slide-copying			Photo- micrography
	B&W color photo	Letters or figures on light background	Letters or figures on dark background	
Panchromatic film for general use	No compensation necessary	+1½ stops	-½ stop	+1 stop

Caution: When performing general photography with the EL2, always make sure that the exposure compensation ring is set to the "0" position; if not, incorrect exposure will occur.

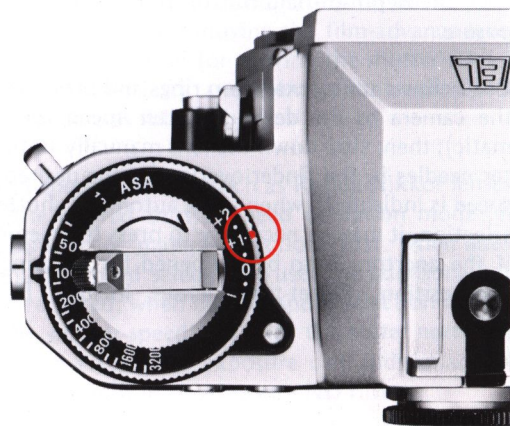

EV RANGE OF THE CAMERA

The camera's meter may be used only within the shutter speed range covered by the exposure value (EV) range of the meter, which varies with the aperture and ASA setting.

The chart on page 37 shows the relationships between the f-stop, shutter speed and film speed, indicating the slowest functioning shutter speed (for metering purposes) with any film speed/f-stop combination.

Careful attention to the following instructions will assure precise exposure, automatically, over the complete exposure control and meter range capability of your Nikon EL2.

■ Auto exposure control at full aperture

For example, with an f/1.4 lens and ASA 100 film, the automatic shutter will function down to one second with the lens set at 1.4, and proportionately slower as the aperture is closed.

Using a standard of ASA 25 film, you may be assured of at least a four-second speed regardless of the aperture of the lens used as long as the lens is set at full aperture (refer to Table).

Using ASA 400 at f/1.4, the slowest speed is 1/4 second; however, as the aperture is closed, the functioning shutter speed becomes progressively slower until we reach f/8 when the slowest speed of eight seconds is functioning.

■ Auto exposure control with stop-down metering

When using a bellows or other extension equipment which disengages the meter coupling device, it is necessary to revert to stop-down metering. Certain limitations are imposed in this mode.

As lens-to-film distance is increased, the metering range (EV range) changes proportionately. For example, when an f/2.0 lens is used at 2:1 reproduction (twice life-size) the effective f/number is f/5.6. When used at f/8, the effective f/number is f/22.

When pictures are taken under minimal light levels, it is desirable to use a high-speed film (ASA 160 or higher). Using Tri-X at film speed 400 with stop-down metering, with an effective f/number of f/8, the shutter speed range would be from 1/4 second to 1/1000. Should the light level drop below EV 6, it would be out of the shutter speed range of the meter.

Table Slowest shutter speed at full aperture with any lens

ASA speed	Slowest shutter speed (sec.)
3200	1/30
1600	1/15
800	1/8
400	1/4
200 (160)	1/2
100 (80)	1
50 (64)	2
25	4
12	8

EV RANGE OF THE CAMERA — continued

■ How to read the EV range chart

The chart indicates the EV (for ASA 100) vs. shutter speed range.

To determine the shutter speed range, note that the bars in section A indicate the responsive range of the EL2's photosensitive SPD element (i.e., f/8 covers EV 6 ~ 23, f/16 covers EV 8 ~ 23) for the f-stop in use.

In Section B, note the f-stop being used on the appropriate ASA scale. For example, at ASA 25 with the lens set at f/8, we follow the line diagonally and find that it intersects EV 5 at eight seconds, and at EV 18 runs off the scale at 1/1000 second. ASA 100 at f/8 runs from EV 3 at eight seconds to EV 16 at 1/1000 second.

In any case, it is generally the low end which requires a careful check. The wide exposure (EV) range of the Nikon EL2 will encompass most lighting situations.

It is only under dim-light or rare bright-light situations that any special attention need be paid.

Full-aperture metering

The metering range is determined by the bars (Section A), f/number range in appropriate ASA scale (Section B) and shutter speed (8 ~ 1/1000 sec., Section C). For example, the area encompassed by the heavy lines demonstrates a combination of an f/1.4 lens and ASA 100 film.

Stop-down metering

The metering range is determined by the bars (Section A), f/number in appropriate ASA scale (Section B) which corresponds to the stopped-down aperture in operation, and shutter speed (8 ~ 1/1000 sec., Section C). The broken line demonstrates stop-down measurement in the case of an f/8 lens combined with ASA 100 film, indicating a range from 1 sec. to 1/1000 sec.

Section B

EV Range Chart

ASA	f/number set at diaphragm ring															
3200	1.4	2	2.8	4	5.6	8	11	16	22	32	45	64	90	125	180	250
1600	1.4	2	2.8	4	5.6	8	11	16	22	32	45	64	90	125	180	250
800	1.4	2	2.8	4	5.6	8	11	16	22	32	45	64	90	125	180	250
400	1.4	2	2.8	4	5.6	8	11	16	22	32	45	64	90	125	180	250
200 (160)	1.4	2	2.8	4	5.6	8	11	16	22	32	45	64	90	125	180	250
100 (80)	1.4	2	2.8	4	5.6	8	11	16	22	32	45	64	90	125	180	250
50 (64)	1.4	2	2.8	4	5.6	8	11	16	22	32	45	64	90	125	180	250
25	1.4	2	2.8	4	5.6	8	11	16	22	32	45	64	90	125	180	250
12	1.4	2	2.8	4	5.6	8	11	16	22	32	45	64	90	125	180	250

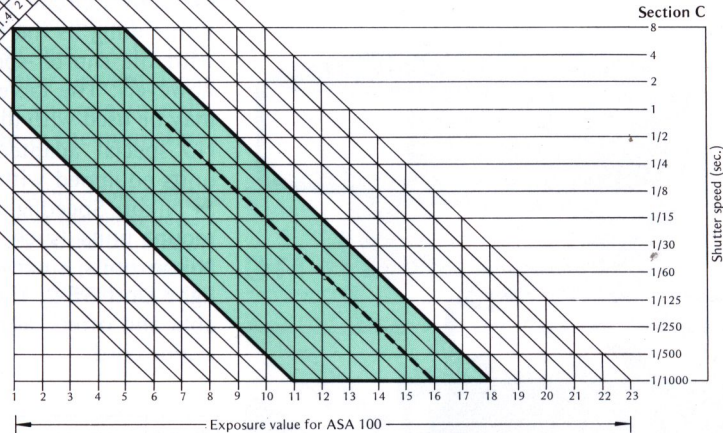

Section C

Shutter speed (sec.)

Working aperture during light measurement

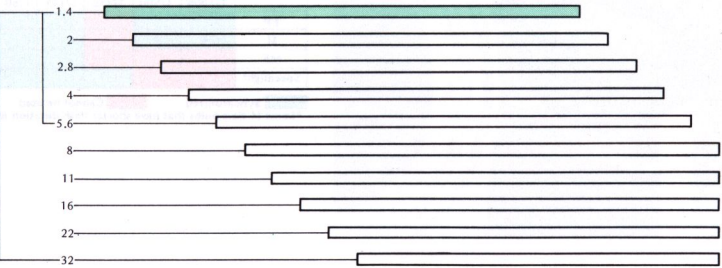

Section A

FLASH SYNCHRONIZATION



The Nikon EL2 camera is designed to synchronize with most types of flashbulbs at almost all shutter speeds and with electronic flash at speeds to 1/125 second. Additionally, the camera is fitted with an automatic sync switchover circuit which selects the proper synchronization timing as the shutter speed is selected (operation with the shutter-speed dial set to "A" is not possible, however). The table below shows which shutter speeds may be used with different types of flashbulbs.

No special adapters are necessary when using flash units equipped with an ISO-type hot-shoe mount (such as Nikon Speedlight Units SB-3 and SB-4) or bottom-mount units (such as the Speedlight SB-5). For other Nikon units, such as the Flash Unit BC-7 and Speedlight Unit SB-2, the Flash Unit Coupler AS-2 is available and offers, again, operation without the need for a sync cord.

Flashbulb	Shutter speed (sec.)														
	1/1000	1/500	1/250	1/125	1/60	1/30	1/15	1/8	1/4	1/2	1	2	4	8	B
FP															
M	*	*													
MF															
Speedlight															

Synchronized
 Cannot be used
 *Some M class bulbs that have shorter flash duration may not cover these speeds.

MIRROR LOCKUP

The reflex mirror must be locked in the up position when using either the Fisheye-Nikkor 6mm f/5.6 or the OP Fisheye-Nikkor 10mm f/5.6 lenses, since their rear elements protrude into the camera body and interfere with mirror movement. Locking up the mirror is also necessary when changing the battery mounted in the chamber at the bottom of the mirror box. To lock up the mirror, turn the mirror lockup lever upward as far as it will go (approx. 45°). The mirror will remain in the up position until the lever is returned to the normal position.

Note: The mirror lockup lever function can be duplicated by using the self-timer to trigger the camera, as the timer action causes the mirror to swing up at the start of the countdown process. This is convenient particularly when minimization of mirror shock is desired, without the need to actually lock the mirror up, as in photomicrographic applications.

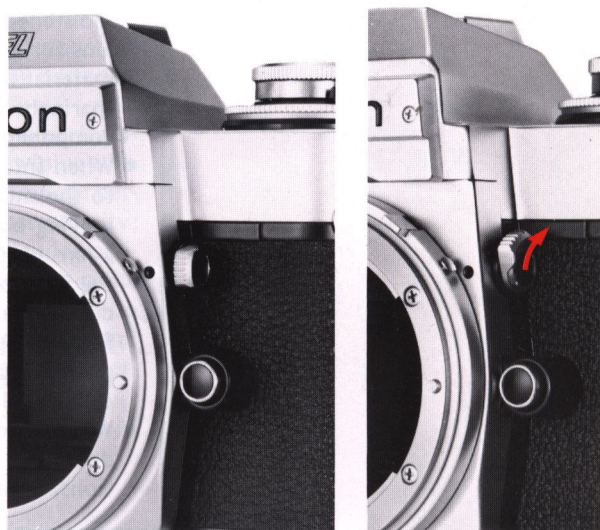

TIPS ON CAMERA CARE

Good camera care is primarily common-sense care. Treat your Nikon EL2 camera as you would any other precision optical instrument and it will provide you years of trouble-free service. Although ruggedly constructed, your camera may be damaged by shock, heat, water or misuse. By observing the following tips, you will be assured of the longest possible service life.

- Fingerprints or dust on lens/prism surfaces will make viewing uncomfortable, and will generally contribute to a deterioration of optical performance. Clean lens surfaces often using a quality lens tissue or a soft lens brush; stubborn smudges should be wiped with lens tissue moistened with methyl alcohol or a quality lens cleaner. Never clean lens surfaces using cloth, paper towels, ordinary tissue, or any other material that might scratch the lens surface; also, use cleaning fluids sparingly to prevent seepage, and resulting damage to mechanical components.
- When interchanging lenses, finders, etc., your camera is susceptible to the entry of dust or other contaminants. It is a good idea to clean moving body parts frequently to prevent the build-up of dust; here, a lens brush and blower will come in very handy. When blowing out the interior of the camera, however, avoid contact with the shutter curtains, as they are easily damaged. Also, wipe the outer body surfaces using a silicone-impregnated cleaning cloth to remove fingerprints, etc. quickly and easily. (Note that a silicone-impregnated cleaning cloth should **never** be used to clean the lens surfaces.)
- When exposed to sudden temperature changes or high humidity, condensation may form on the lens surfaces. After using in these situations, always dry the camera thoroughly (and slowly) at room tem-

perature and, then, store in a cool, dry location. Remember that failure to dry out the camera may result in the growth of fungus on lens surfaces—a condition that will render your camera useless.

- Should your camera be accidentally dropped on the floor or in water, take it to your dealer immediately for servicing. Thorough servicing can be guaranteed only at an authorized dealer.
- Always store the camera in an ever-ready case or compartment case when not in use. And be sure that the lens cap is attached to the lens. Do not leave film in the camera for a long period of time, and never store the camera with the shutter or self-timer cocked.
- Never lubricate any part of the camera. Lubrication should be left to an authorized service center. Prior to a holiday trip or important shooting assignment, test your camera (including changing batteries, if necessary) for proper operation.
- Observe normal battery handling procedures for maximum performance at all times. Be sure to: Clean batteries periodically (wiping with a rough cloth will remove residues that might otherwise impede performance); install batteries properly, checking for proper polarity; remove batteries when not using the equipment for an extended period; change weak batteries promptly to prevent leakage within the camera; store unused batteries properly (in a cool, dry location) to maximize service life; dispose of batteries properly (do not burn); and keep out of the reach of children. For details regarding battery performance, refer to the original manufacturer.

CHANGING THE LENS

To remove the lens from the camera body, press the lens release button and, holding the button depressed, twist the lens clockwise as far as it will go. With this action, the lens will come loose and can be lifted out.

To mount a lens fitted with a meter coupling ridge, perform the following: Check that the meter coupling lever is released (see “Coupling Lever Lock/Release Operation” on page 43 for details); position the lens in the camera’s lens mounting flange so that the mounting indexes on the lens and camera body are aligned; and, then, twist the lens counterclockwise

until it clicks and locks into place. These steps provide for full mounting of the lens, while simultaneously indexing the lens’ maximum aperture setting to the camera’s metering circuit.

To mount a lens not fitted with a meter coupling ridge, first lock the meter coupling lever in the up position (again, see “Coupling Lever Lock/Release Operation” for details). Then mount the lens and lock it into position as explained previously. For operation with lenses not fitted with a meter coupling ridge, stop-down measurement (as described on page 32) is required.



Coupling Lever Lock/Release Operation

The EL2 is fitted with a meter coupling lever at the base of the lens to provide for coupling between the metering circuit and the lens' meter coupling ridge. When the camera body is used with lenses offering automatic maximum aperture indexing, the lever remains in the normal position. However, when the camera body is used with lenses and/or accessories not provided with this feature, the lever must be locked up to permit exposure measurement via the stop-down method. To lock up the lever prior to mounting the lens, simply push in the coupling lever release and lift the lever up and out of the way for operation. To return the lever to its normal position for operation with a lens or accessory capable of automatic maximum aperture indexing, simply push the lever back down until the lever clicks into place; then, mount the lens as explained previously.



ACCESSORIES

Auto Winder AW-1

The compact and lightweight Nikon Auto Winder AW-1 is a precision drive accessory which offers greater versatility of operation with the EL2. The winder attaches directly to the baseplate of the camera and provides for effortless, automatic film advance operation that complements the camera's built-in automatic exposure features. And by providing the freedom from manual film advance, the AW-1 enables the photographer to concentrate fully on the viewfinder image and to follow even rapid action flow. Power for winder operation is provided by six standard penlight-type batteries mounted within the unit.



Lens Hoods

The use of a lens hood is recommended at all times to prevent extraneous light from striking the lens (a cause of flare and ghost), and as an added measure of protection for the lens. An extensive lineup of hoods is available to meet the needs of all Nikkor lenses.

Filters

Nikon filters, made of the finest optical glass finished to plano-parallel flatness, are available in a wide range of mounting sizes and types to meet the needs of both color and black-and-white photography. For best results, use Nikon filters on Nikkor lenses.

Eyepiece Correction Lenses

Available in nine different powers for maximum selectivity, Nikon eyepiece correction lenses permit the near- or far-sighted user to view and focus without wearing spectacles. Diopters available are -5 , -4 , -3 , -2 , 0 , $+0.5$, $+1$, $+2$ and $+3$, with each value representing the combined lens/finder dioptre.

Finder Eyecup

The rubber eyecup can be attached to the finder eyepiece to prevent extraneous light from entering the viewfinder.

Camera Cases

Available in both hard and soft (pouch) construction, Nikon camera cases offer excellent protection for your camera body and mounted lenses. Various sizes available ensure use with most Nikkor lenses.

FEATURES/SPECIFICATIONS

Type of camera: 35mm single-lens reflex (SLR)

Picture format: 24mm x 36mm (35mm film format)

Lens mount: Nikon F mount (bayonet type)

Lenses available: Nikkor 50mm f/1.4, f/2 or 55mm f/1.2 as standard; more than 50 Nikkor lenses in all

Shutter: Vertical-travel focal-plane shutter; speeds of from 8 seconds to 1/1000 second and "B"; automatic shutter speed selection available when set to "A" setting; shutter release via shutter button or self-timer

Flash synchronization: Automatic selection as shutter speed is manually set; hot-shoe contact (ISO-type) with built-in safety switch provided; one threaded PC terminal provided for off-camera flash operation

Synchronization range: 1/1000 ~ 8 sec. and "B" for flashbulbs; 1/125 ~ 8 sec. and "B" for electronic flash

Accessory shoe: ISO-type built into finder housing; fitted with hot-shoe contact and electric safety switch which turns on contact as flash unit is mounted

Viewfinder: Fixed eyelevel pentaprism type with built-in through-the-lens (TTL) exposure meter; shutter speed indicated to the left within the viewfield

Focusing screen: Matte Fresnel field with central split-image rangefinder surrounded by microprism ring; 12mm diameter reference circle defines area of meter center-weighting; similar to Nikon Type K screen

Reflex mirror: Instant-return type; lockup lever provided

Exposure metering: Through-the-lens, center-weighted, full-aperture measurement employing two silicon photo-diodes (SPD) for fast response; exposure correctly set either automatically or by matching two needles; meter cross-coupled with both diaphragm and shutter speed controls and automatically indexed as lens is mounted; powered by one 6V silver-oxide battery

Metering range: EV 1 ~ EV 18 (i.e., f/1.4 at 1 second ~ f/16 at 1/1000 second) with 50mm f/1.4 lens and ASA 100

Film speed scale: Settings provided for ASA 12 ~ 3200

Lens diaphragm coupling: Built-in meter coupling lever for Nikkor lenses capable of automatic maximum aperture indexing; meter/diaphragm coupling of from f/1.2 to f/32 provided

Film winding: Via single-stroke lever with 135° winding angle and 30° stand-off angle; lever also serves as meter ON/OFF switch

Frame counter: Shows number of frames exposed (additive type); automatically resets to "S" (two frames before "0") when camera back is opened

Film rewinding: Manual via film rewind crank

Depth-of-field preview: Via button provided on front of camera

Body finish: Satin-chrome and semi-gloss black

Weight: 780g (body only)

Dimensions: 145mm x 93.5mm x 54.5mm



NIPPON KOGAKU K.K.

No reproduction in any form of this booklet, in whole or in part (except for brief quotation in critical articles or reviews), may be made without written authorization from the publishers.

Printed in Japan (77.2.BO) &-1