

**E** INSTRUCTION MANUAL

**MAXXUM<sup>®</sup>**

***HT si***

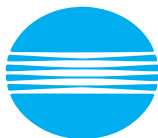

**MINOLTA**

**QUICK  
OPERATION**

**GETTING  
STARTED**

**FULL-AUTO  
OPERATION**

**SUBJECT  
PROGRAM  
SELECTION**

**CREATIVE  
EXPOSURE  
MODES**

**ADDITIONAL  
FEATURES**

**APPENDIX**

# FOR PROPER AND SAFE USE

This manual has been designed to help you understand the operation of your Minolta camera more quickly. After familiarizing yourself with the camera, start with Level I and learn to operate the camera in Full-Auto mode.

Move on to Level II and the Subject Program modes when you are comfortable with the camera and want to have more control. Here you decide the type of image you want to photograph and leave the exposure details to the camera.

When you are ready for full control, move on to Level III and the ASM exposure modes.

The information in this manual is relevant for products introduced before March, 1998. Contact the nearest authorized Minolta Service facility to obtain compatibility information for products released after this date.

This device complies with Part 15 of the FCC Rules. Operation is subject to the following two conditions: (1) This device may not cause harmful interference, and (2) this device must accept any interference received, including interference that may cause undesired operation. Changes or modifications not approved by the party responsible for compliance could void the user's authority to operate the equipment. This equipment has been tested and found to comply with the limits for a Class B digital device, pursuant to Part 15 of the FCC Rules. These limits are designed to provide reasonable protection against harmful interference in a residential installation. This equipment generates, uses and can radiate radio frequency energy and, if not installed and used in accordance with the instructions, may cause harmful interference to radio communications. However, there is no guarantee that interference will not occur in a particular installation. If this equipment does cause harmful interference to radio or television reception, which can be determined by turning the equipment off and on, the user is encouraged to try to correct the interference by one or more of the following measures:

- Reorient or relocate the receiving antenna.
- Increase the separation between the equipment and the receiver.
- Connect the equipment to an outlet on a circuit different from that to which the receiver is connected.
- Consult the dealer or an experienced radio/TV technician for help.

This Class B digital apparatus meets all requirements of the Canadian Interference-Causing Equipment Regulations.

**Read and understand all warnings and cautions before using this product.**

## **WARNING**

Batteries may become hot or explode due to improper use.

- Use only the batteries specified in this instruction manual.
- Do not install the batteries with the polarity (+/-) reversed.
- Do not subject batteries to fire or high temperatures.
- Do not attempt to recharge, short, or disassemble.
- Do not mix batteries of different types, brands, or ages.
- Tape over lithium battery contacts before disposal.
- Follow local regulations for battery disposal.

Use caution, accidents may occur when using this product near young children.

Keep batteries and other things that could be swallowed away from young children. Contact a doctor immediately if an object is swallowed.

Immediately remove the batteries and discontinue use if...

- the camera is dropped or subjected to an impact in which the interior is exposed.
- the camera emits a strange smell, heat, or smoke.

Do not disassemble. Electric shock may occur if a high voltage circuit inside the camera is touched. Take your camera to a Minolta Service Facility when repairs are required.

Do not look directly at the sun through the viewfinder.

Do not allow a camera lens to point directly at the sun. Fire may occur if sunlight comes to focus on a flammable surface. Replace the lens cap when the product is not being used.

# TABLE OF CONTENTS

<b>NAMES OF PARTS</b> .....	4
<b>QUICK OPERATION</b> .....	8

## GETTING STARTED

Strap .....	11
Batteries .....	12
Lens .....	14
Loading Film .....	16
Handling the Camera .....	18

## FULLY-AUTOMATIC OPERATION

Taking Pictures in Full-Auto .....	20
Focus Signals .....	21
Special Focus Situations.....	22
Focus Hold .....	23
Using the Built-in Flash	
Flash signals.....	25
Flash range.....	25
Fill flash .....	26
Flash cancel .....	26
Red-eye reduction .....	27
Rewinding the Film .....	28

## SUBJECT PROGRAM SELECTION

Portrait Mode .....	30
Landscape Mode .....	31
Close-up Mode .....	32
Sports Mode .....	33
Night Portrait Mode.....	34
Photographing Night Scenes .....	35
Self-timer .....	36
Continuous Advance .....	37

# TABLE OF CONTENTS

## CREATIVE EXPOSURE MODES

A-MODE – Aperture Priority .....	39
A-mode flash .....	40
Aperture control .....	41
S-MODE – Shutter Priority .....	42
S-mode flash .....	43
Shutter control .....	44
M-MODE – Manual.....	45
Metering in manual mode.....	46
M-mode flash .....	47
TAKING TIME EXPOSURES (buLb) .....	48

## ADDITIONAL FEATURES

### FOCUS

Wide Focus Area .....	51	Spot AF.....	52
Manual Focus.....	53	AF Illuminator .....	54

### EXPOSURE

14 Segment Metering.....	55	Spot Metering .....	56
Exposure Compensation ..	57	Setting the ISO Manually ..	58
Bracketing.....	59	Multiple Exposure.....	62

### FLASH

High-Speed Sync .....	65	Slow Sync.....	66
-----------------------	----	----------------	----

### FOR OWNERS OF THE DATE MODEL

Exposing the Date/Time ....	67	Setting the Date/Time.....	68
Replacing the Battery .....	69		

### CUSTOM FUNCTIONS

Setting .....	70	Details.....	71
---------------	----	--------------	----

## APPENDIX

Program Reset Button .....	77	Accessories .....	78
Exposure Warnings .....	81	Trouble Shooting .....	82
Care and Storage.....	84	Specifications .....	86

# NAMES OF PARTS

For information on specific parts, refer to the page numbers shown in parenthesis.

## Body

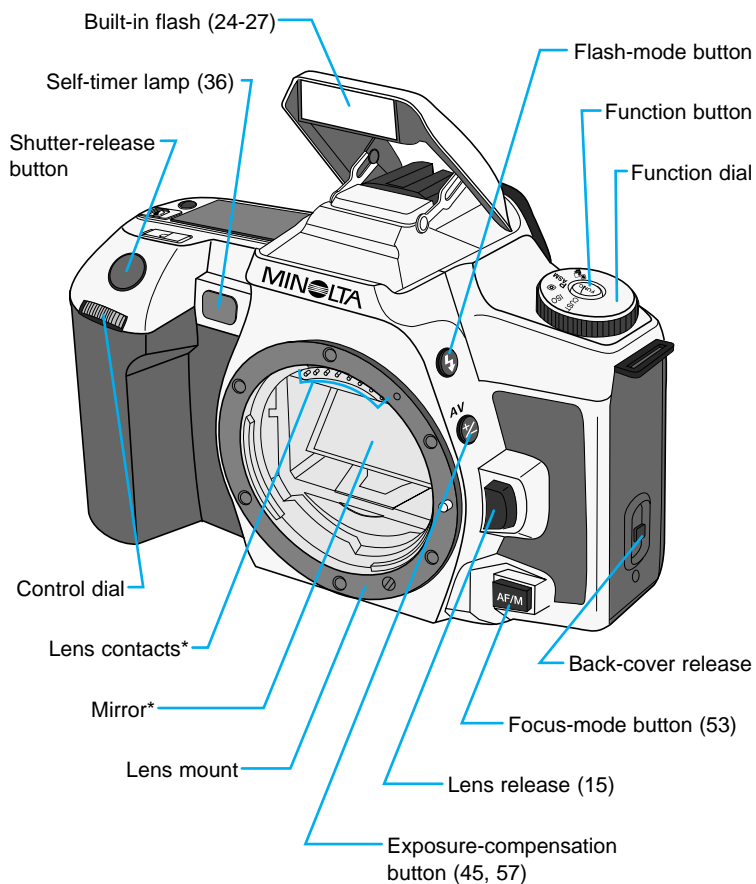

\* Do not touch

# NAMES OF PARTS

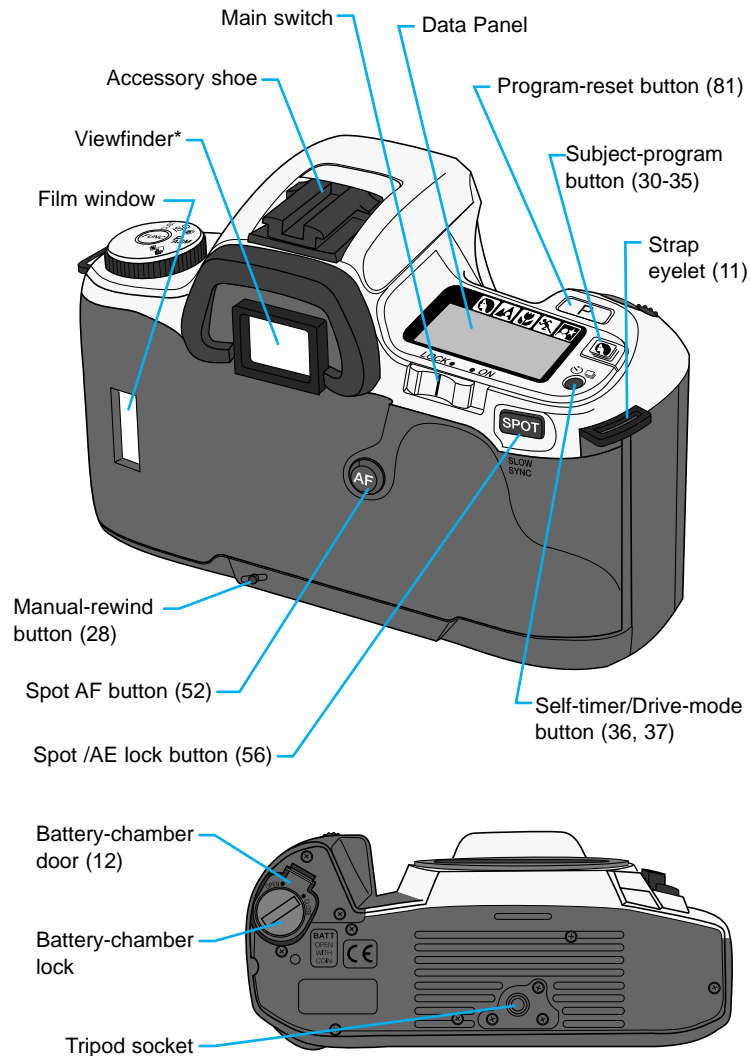

# NAMES OF PARTS

## Data Panel

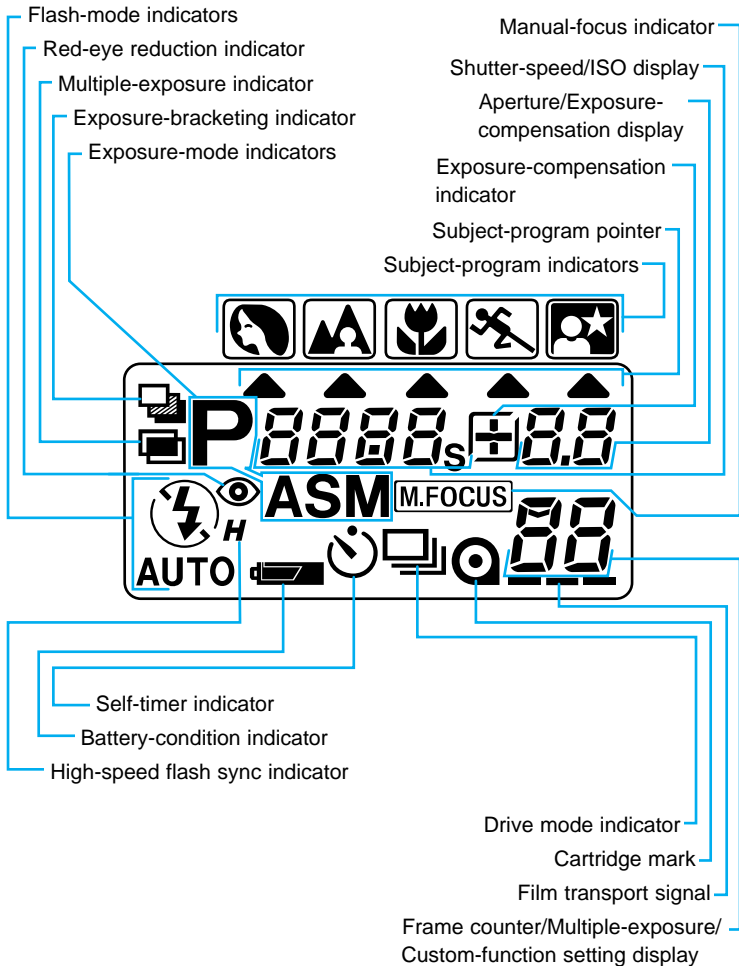

# NAMES OF PARTS

## Viewfinder

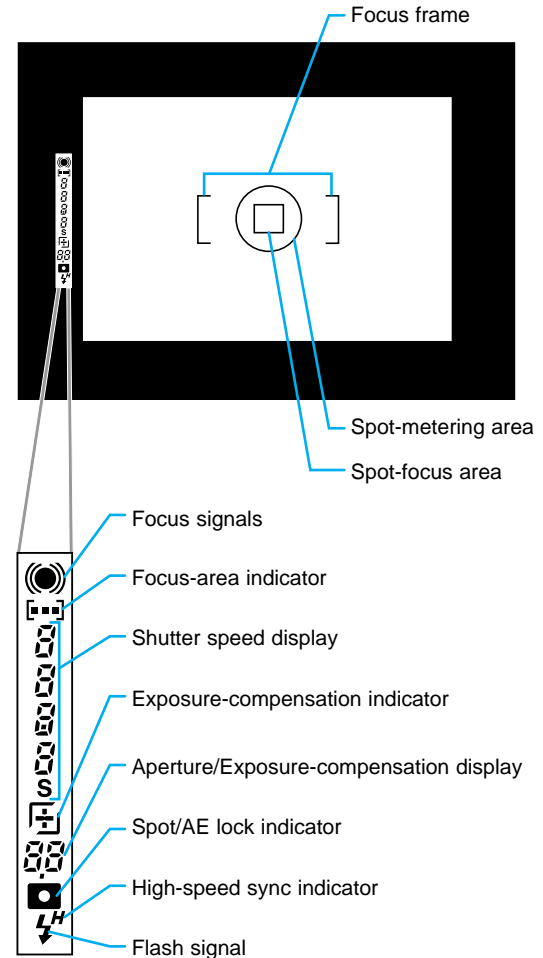

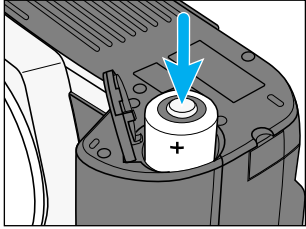

## 1. Insert batteries.

- This camera uses two CR2 lithium batteries.

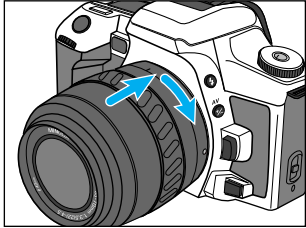

## 2. Attach lens.

- Align the red mounting dot on the lens with the one on the camera. Gently insert the lens into the mount and turn it clockwise until it clicks into the locked position.

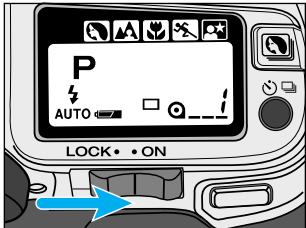

## 3. Turn on power.

- Slide the main switch to ON.

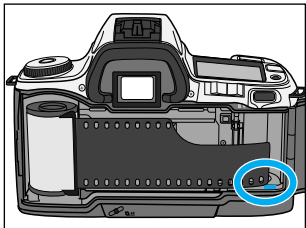

## 4. Load film.

- Align the film tip with the red mark, then close the back cover.

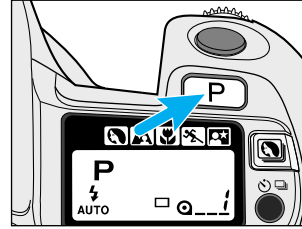

## 5. Set Full-Auto operation.

- Press the program-reset button to set the camera to fully-automatic operation.

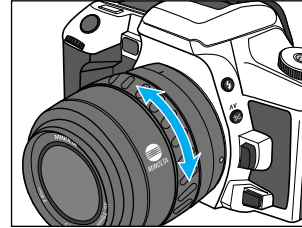

## 6. If using a zoom lens, rotate the zooming ring to frame your subject as desired.



## 7. Center your subject in the focus frame, then press the shutter release button partway down.

- The camera will focus and set exposure automatically.

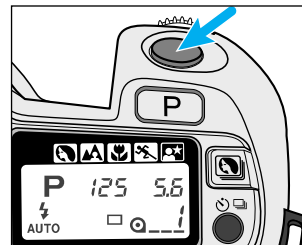

## 8. Take the picture.

- Gently press the shutter-release button all the way down to take the picture.

# LEVEL I

This section provides the information necessary to operate your camera in most photographic situations.

This section covers:

- Battery Installation
- Attaching and Removing the Lens
- Loading the Film
- Camera Handling
- Fully Automatic Camera Operation
- Special Focus Situations
- Basic Flash Operation
- Rewinding the Film

Once you fully understand the instructions in this section, proceed to the Advanced Operation and Additional Features sections to obtain more enjoyment from your camera.

## GETTING STARTED

### Attaching the Strap

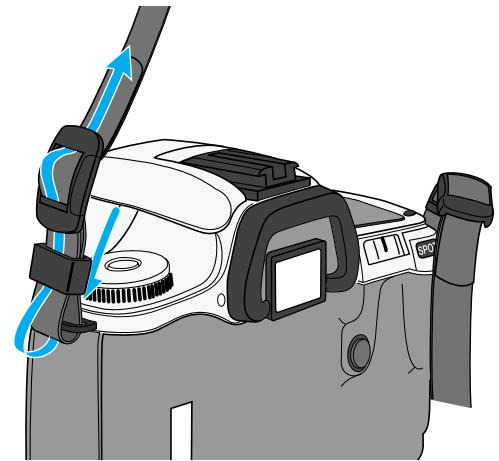

## Installing the Batteries

Your camera uses two 3V CR2 lithium batteries to supply power for all camera operations.

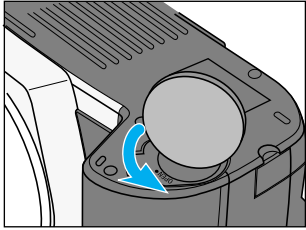

1. Using a coin or similar object, turn the battery-chamber lock to **OPEN**, then open the battery-chamber door.

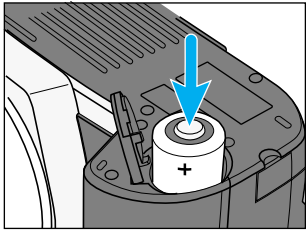

2. Insert the batteries as indicated by the + and - marks.

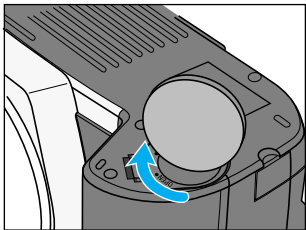

3. Close the battery-chamber door, then turn the battery-chamber lock to **CLOSE**.
  - Setting the camera down with the battery-chamber door open may damage the camera.

## Checking Battery Power

Each time the main switch is set to ON, a battery symbol appears in the data panel indicating the power status of the batteries.

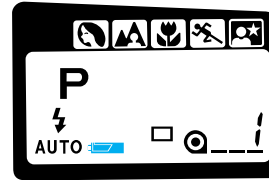

### Full-battery symbol

Power is sufficient for all camera operations.

-  will only appear for five seconds.

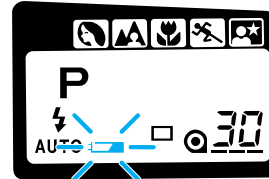

### Blinking low-battery symbol

Power is extremely low. All functions are operational, but the batteries will need to be replaced soon. Flash recycling time may be slow.

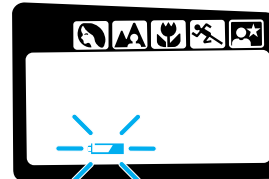

### Blinking low-battery symbol appears alone and the shutter locks.

Power is insufficient for camera operation. Replace the batteries.



### No display

Power is too low for the camera to operate. Replace the batteries or make sure they have been inserted correctly.



## Attaching the Lens

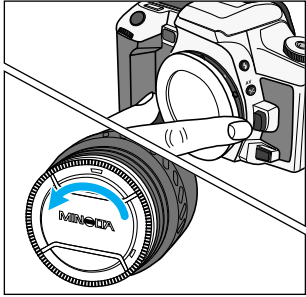

1. Remove the body and rear lens caps.

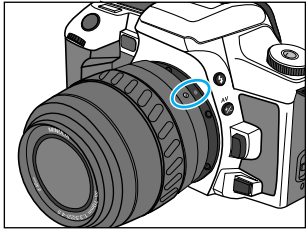

2. Align the red mounting dots on the lens and camera body.

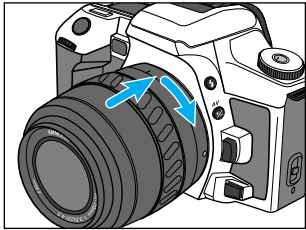

3. Gently insert the lens into the mount, then turn it clockwise until it clicks into the locked position.
  - Do not insert the lens at an angle.
  - Do not press the lens release when attaching the lens.

## Removing the Lens

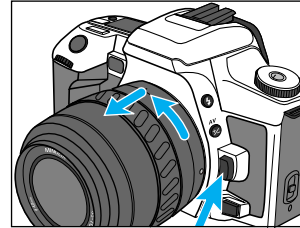

1. Press the lens release and turn the lens counter-clockwise until it stops.
2. Gently remove the lens and replace caps, or attach another lens.

### Caution

- Do not force the lens if it does not turn smoothly.
- Do not touch the inside of the camera, especially the lens contacts and mirror.

# LOADING FILM

Check the film window before loading film. If film is loaded, do not open the back cover. Refer to Manual Rewind on page 28 for instructions on removing a partially exposed roll.

- Load film in the shade to reduce the chances of fogging the film.
- Do not use Polaroid Instant 35mm film. Winding problems may occur.
- If DX-coded film is used, the camera automatically sets the correct ISO (film speed).
- If non DX-coded film is used, the camera will use the previous roll's ISO setting. Refer to page 58 to set the film speed manually.
- Do not use infrared film in this camera. The camera's frame counter sensor will fog infrared film.

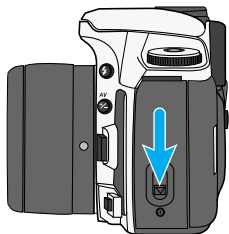

**1. Slide the back-cover release down to open the back cover.**

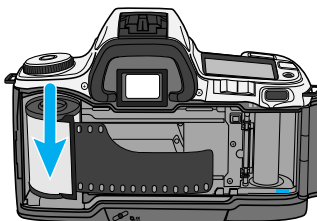

**2. Insert a film cartridge into the film chamber.**

The shutter curtain's precision design makes it extremely sensitive to pressure. Never touch it with your fingers or the film tip.

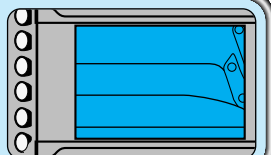

# LOADING FILM

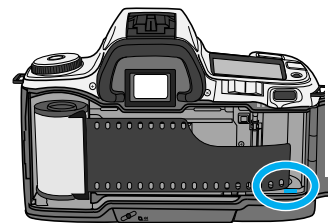

**3. Extend the leader between the guide rails to the index mark.**

- If the film tip extends beyond the index mark, push the excess film back into the cartridge.

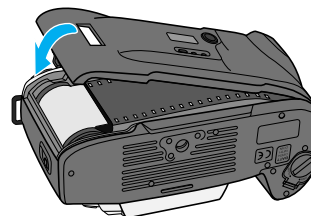
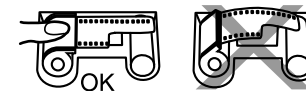

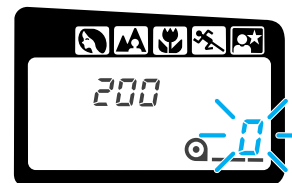

**4. Close the back cover.**

- The camera automatically advances the film to the first frame. 1 will appear in the frame counter.
- The ISO is displayed in the data panel for 5 seconds after loading.



-  blinks in the frame counter and the shutter locks when the film is loaded incorrectly. Open the back cover and repeat steps 2 – 4.

If film is loaded with the power off...  
The film's ISO and  appear in the data panel for approx. five seconds to indicate successful loading, then the camera shuts down.

- If the film did not load,  will blink in the data panel before the camera shuts down. Reload the film.

# HANDLING THE CAMERA

## Holding the Camera

Grip the camera firmly with your right hand, while supporting the lens with your left. Keep your elbows at your side and your feet shoulder-width apart to hold the camera steady. Keep the camera strap around your neck or wrist in the event you accidentally drop the camera.



- Do not touch the end of the lens barrel while taking a picture.
- Use a tripod when using slow shutter speeds or a telephoto lens.

## Pressing the Shutter-Release Button

Press the shutter-release button partway down to activate the camera's autofocus and auto-exposure systems.

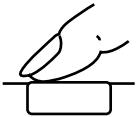
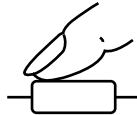

Gently press the shutter-release button all the way down to take the picture.

## FULLY-AUTOMATIC OPERATION

Full-Auto is the camera's standard operating mode and is suited for use in almost any situation. When selected, the camera sets the focus and exposure automatically and fires the built-in flash when necessary. Use Full-Auto when you are just starting out or when you are shooting under conditions that would require you to constantly adjust the focus and/or exposure.

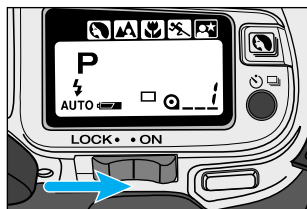

1. Slide the main switch to ON.

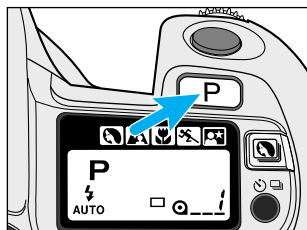

2. Press the program-reset button to set the camera to Full-Auto.

- The camera will return to its default settings (p77).

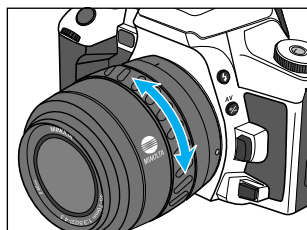

3. If using a zoom lens, rotate the lens' zooming ring to frame the subject as desired.

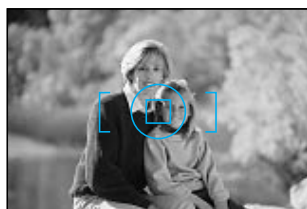

4. Center your subject in the focus frame [ ], then press the shutter-release button partway down to activate autofocus.

- ● or (●) will appear in the viewfinder when focus is confirmed.
- The built-in flash will pop-up and fire when necessary.

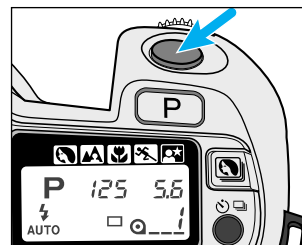

5. Press the shutter-release button all the way down to take the picture.

- In low-light conditions, the AF illuminator (flash) will fire to determine focus distance.
- Use focus hold (p23) if your subject is outside the focus frame.

## Focus Signals

The following signals appear in the viewfinder to indicate the focus status when the shutter release button is pressed partway down.



●	<b>Focus is confirmed</b>
(●)	Continuous autofocus – <b>Focus is confirmed</b>
(○)	Continuous autofocus – <b>Lens focusing</b> Shutter is locked
● (with radiating lines)	<b>Focus cannot be confirmed</b> – Shutter is locked. Subject is too close or is one of the special focus situations described on page 22.

The camera may not be able to focus in situations like those described below. When the focus lamp blinks, use focus hold (p23) or manual focus (p53). See page 21 for an explanation of the focus signals.



If the subject within the focus frame is very bright, or low in contrast.

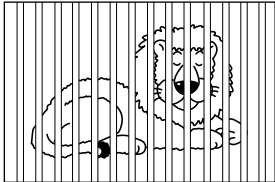

If two subjects at different distances overlap in the focus frame.

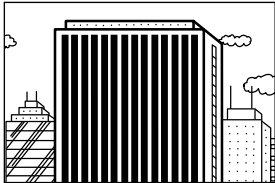

If a subject composed of alternating light and dark lines completely fills the focus frame.



If your subject is near a very bright object or area.

Use focus hold when your subject is outside the focus frame or when autofocus is difficult to confirm.



*Focus hold cannot be used for moving subjects.*



**1. Center your subject in the focus frame, then press the shutter-release button partway down.**

- ● appears in the viewfinder when the focus is confirmed.
- Focus hold also locks the exposure settings.



**2. Continue to hold the shutter-release button partway down while you compose your picture.**

**3. Press the shutter-release button the rest of the way down to take the picture.**

- Remove your finger from the shutter-release button to cancel focus hold.

## USING THE BUILT-IN FLASH

In Full- Auto mode (P), the built-in flash pops-up automatically when the shutter release button is pressed partway down. Once the flash is up, it will fire when necessary.

- The shutter will not release until the flash is charged.
- Select flash cancel (⏏) when you don't want the flash to fire.
- Pressing the program-reset button (P) resets the flash to autoflash mode.

*Do not use the built-in flash with focal lengths shorter than 28mm. The built-in flash cannot cover focal lengths wider than 28mm.*

**Custom Function 5 (p72) lets you cancel the built-in flash's auto pop-up feature. When selected, the flash-mode button must be pressed to raise the built-in flash.**



## Lens Shadowing

Lens shadowing occurs when the lens or lens hood blocks part of the output from the built-in flash. Lens shadowing appears as semi-circular shaded area at the bottom (horizontal) or side (vertical) of your image.

- Remove the lens hood before using the built-in flash.
- Lens shadowing may occur with the following lenses at shorter focal lengths.
  - AF Zoom 28-70mm f/2.8G
  - AF Zoom 17-35mm f/3.5G
  - AF Zoom 28-135mm f/4.0-4.5
  - AF Zoom 28-85mm f/3.5-4.5
- The built-in flash can not be used with the following lenses:
  - AF 300mm f/2.8 (APO tele)
  - AF 600mm f/4.0 (APO tele)

## USING THE BUILT-IN FLASH

### Flash Signals

	Flash is charged.
	Previous exposure was correct.

### Flash Range

The range of the built-in flash depends on the speed of the film and the selected aperture. Make sure your subject is within the flash range specified in the table below.

*Make sure you are at least 1m (3.3 ft.) from your subject when using the built-in flash.*

Aperture	ISO 100	ISO 200	ISO 400
<b>f/2.8</b>	1.0 ~ 4.3m (3.3 ~ 14.1 ft.)	1.0 ~ 6.1m (3.3 ~ 20. ft.)	1.0 ~ 8.6m (3.3 ~ 28.2 ft.)
<b>f/3.5</b>	1.0 ~ 3.4m (3.3 ~ 11.2 ft.)	1.0 ~ 4.8m (3.3 ~ 15.7 ft.)	1.0 ~ 6.8m (3.3 ~ 22.3 ft.)
<b>f/4.0</b>	1.0 ~ 3.0m (3.3 ~ 9.8 ft.)	1.0 ~ 4.2m (3.3 ~ 13.8 ft.)	1.0 ~ 6.0m (3.3 ~ 19.7 ft.)
<b>f/5.6</b>	1.0 ~ 2.1m (3.3 ~ 6.9 ft.)	1.0 ~ 3.0m (3.3 ~ 9.8 ft.)	1.0 ~ 4.3m (3.3 ~ 14.1 ft.)

## USING THE BUILT-IN FLASH

### Fill Flash

Use fill flash when taking pictures under fluorescent lighting or to eliminate harsh shadows. When set, the flash will fire every time a picture is taken. The TTL automatic flash metering system will ensure correct exposure.

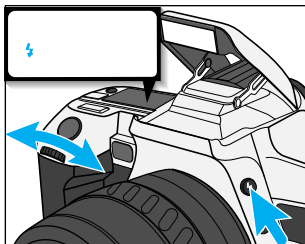



**Press the flash-mode button and turn the control dial until  appears in the data panel.**

- Make sure your subject is within the flash range specified in the table on page 25.
- Press the flash-mode button and turn the control dial until  appears to return to autoflash mode.
- For quick shots, hold the flash-mode button down when pressing the shutter-release button to fire the fill flash.

### Flash Cancel

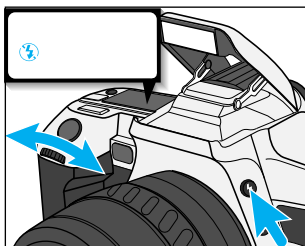
Use flash cancel when photographing twilight scenes or to capture the ambiance of existing light.



**Press the flash-mode button and turn the control dial until  appears in the data panel.**

- Press the flash-mode button and turn the control dial until  appears to return to autoflash mode.

*The shutter speed may be slow.  
Use of a tripod is recommended.*

## USING THE BUILT-IN FLASH

### Red-Eye Reduction

Light reflecting from your subject's eyes may produce the effect known as red-eye. Use the built-in flash's red-eye-reduction mode to produce more natural looking photographs by reducing the red-eye effect.

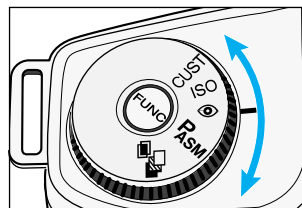

1. Turn the function dial to .

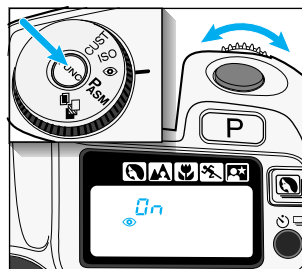



2. Press the function button and turn the control dial until  and **ON** appear in the data panel.

- Warn your subject that the flash will fire a few short flash bursts just before the picture is taken.

### Cancelling Red-eye Reduction





Turn the function dial to , then press the function button and turn the control dial until  and **OFF** appear in the data panel.

# REWINDING THE FILM

## Automatic Rewind

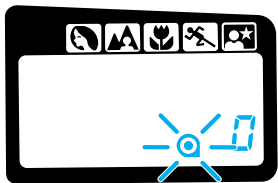
After you have exposed the last frame, the camera will automatically rewind the film. When the film is completely rewound, the motor will stop and  will blink in the data panel indicating it is safe to open the back of the camera.



1. **Wait until the film is completely rewound.**
  -  will appear and  will blink in the data panel.

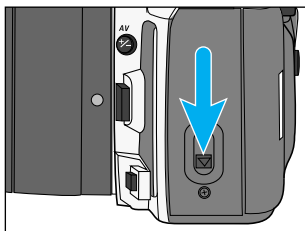

2. **Slide the back-cover release down to open the back cover.**
3. **Remove the film, then close the back cover.**

## Manual Rewind

Use manual rewind to rewind the film before the current roll is finished.

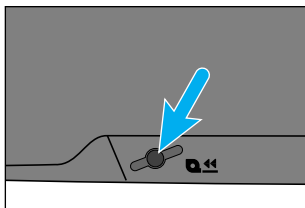

1. **Press the manual-rewind button.**
2. **Follow steps 1-3 from Automatic Rewind.**

# LEVEL II

Now that you are comfortable with the operation of the camera, take more control of the creative process by telling the camera what kind of picture you want to take.

The subject program modes let you take more control without leaving the program exposure mode. In each of the subject program modes, the camera will automatically set the best possible shutter speed and aperture for the type of picture you are taking.

This section also lets you explore the use of the Self-timer and Continuous Advance modes.

<b>Subject Program Selection</b>	<b>Page</b>
Portrait Mode	30
Landscape Mode	31
Close-Up Mode	32
Sports Mode	33
Night Portrait Mode	34
Photographing Night Scenes	35

<b>Drive Mode</b>	<b>Page</b>
Self Timer	36
Continuous Advance	37

Each of these functions can be explored independently after Level I has been mastered.

- Press the program-reset button to return the camera to Full-Auto operation.





# SUBJECT PROGRAM SELECTION

## Portrait Mode

Portraits have the greatest impact when a shallow depth-of-field\* is used to separate the subject from the background. In Portrait mode, the necessary settings are made automatically, leaving you free to capture the perfect expression.

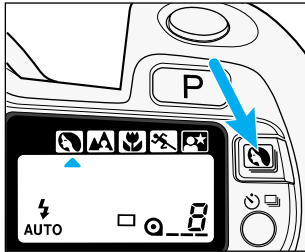
\* Depth-of-field is the area in front of and behind the point you focused on that appears sharp (p41).



Press the subject-program button until the subject-program pointer is under .

### Tips

- For best results use a mid-telephoto lens with a large aperture.
- Use fill flash when your (p26).
- Lock focus on your subject's eyes and be ready to capture the perfect expression.

# SUBJECT PROGRAM SELECTION

## Landscape Mode

Landscape photography requires a large depth-of-field to make sure everything is in focus. In Landscape mode, the camera is set to obtain the greatest depth-of-field possible, while maintaining a shutter speed fast enough to prevent blur due to camera shake.

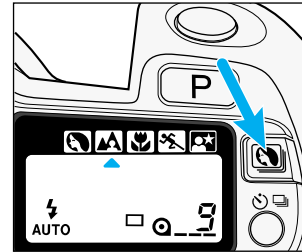

Press the subject-program button until the subject-program pointer is under .

### Tips

- For best results zoom to a wide view or use a wide angle lens and include a foreground subject or detail to create a feeling of depth in the picture.
- Use flash when a subject in the foreground is backlit or has strong shadows across the face. If there is no subject in the foreground, do not use flash.
- Use a tripod, especially at slower shutter speeds.

## Close-Up Mode

Set Close-Up mode when photographing small objects like flowers or jewelry. In Close-Up mode, the camera automatically sets the best possible aperture and shutter speed for the picture you are taking.

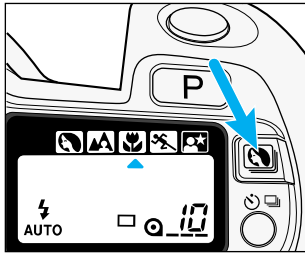

Press the subject-program button until the subject-program pointer is under .

### Tips

- For best results use a macro lens or a macro capable zoom lens.
- Do not use the built-in flash if your subject is closer than 1.0m (3.3 ft.). The lens may block the flash, creating a shadow at the bottom of your image (lens shadowing).
- Use a tripod to reduce camera shake.

## Sports Mode

Fast shutter speeds are needed to stop action. In Sports mode, the camera will set the fastest possible shutter speed and continually adjust the focus to track fast-moving subjects.

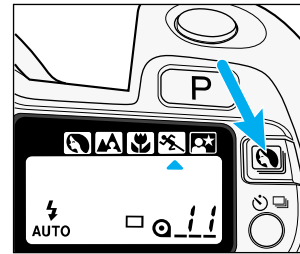

Press the subject-program button until the subject-program pointer is under .

### Tips

- The built-in flash is only effective when your subject is within the flash range.
- Use fast film and keep the focus frame on your subject.
- Mount the camera on a tripod when using telephoto lenses.
- Use spot AF to hold the focus in Sports mode (p52).

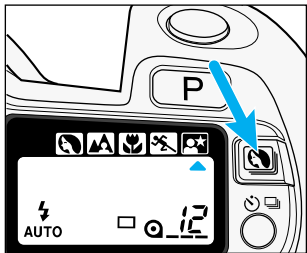

## Night Portrait Mode

Night portraits require the camera's flash exposure to be balanced with the background exposure. In Night Portrait mode, the camera sets the largest possible aperture with a longer shutter speed, allowing the background to appear in the photograph.



Press the subject-program button until the subject-program pointer is under .

### Tips

- Set the flash to  or  when using Night Portrait mode. See pages 26 and 27.
- Use faster film and a tripod.
- Focus on the main part of your subject.
- Warn your subject not to move while the picture is taken.

## Photographing Night Scenes

Cancel the flash in Night Portrait mode to photograph night scenes. The longer shutter speeds set in Night Portrait mode let you capture beautiful photographs of twilight scenes and night skylines.

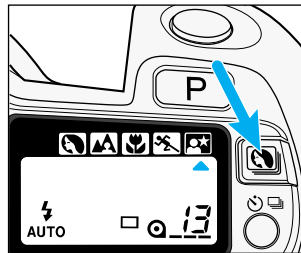

1. Press the subject-program button until the subject-program pointer is under .

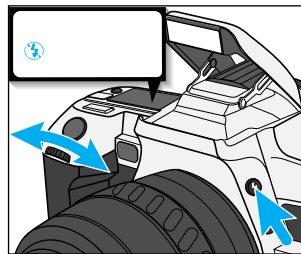



2. Press the flash-mode button and turn the control dial until  appears in the data panel.

### Tips

- Use faster film and a tripod.
- If you are photographing a dark night scene, it may be difficult for the camera to focus, use focus hold (p23) or manual focus (p53).

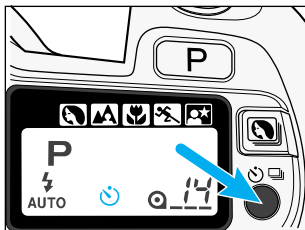
The self-timer delays the release of the shutter for approximately 10 seconds after the shutter-release button is pressed.



**1. Place the camera on a tripod, then press the self-timer button until  appears in the data panel.**



**2. Center your subject in the focus frame.**

**3. Press the shutter-release button all the way down to start the timer.**

- The self-timer indicator on the front of the camera will blink, then glow just before the shutter releases.

- Self-timer mode is cancelled after the shutter is released.
- Do not press the shutter-release button while standing in front of the camera.
- Attach the eyepiece cap if there is a bright light source behind the camera (p49).

Press the self-timer button or slide the main switch to LOCK to cancel the self-timer before the shutter releases.

In this mode, the camera continues to release the shutter and advance the film as long as the shutter-release button is held down.

- AF Zoom xi and Power zoom lenses cannot be zoomed when continuous-advance mode is selected.

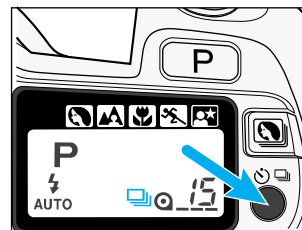

**1. Press the drive-mode button until  appears in the data panel.**

**2. Press the shutter-release button down and hold.**

- When taking flash pictures, the shutter will release after the flash is charged.
- When the subject is moving, the shutter will release after the camera focuses on the subject.
- To return to single frame mode, press the drive mode button until  appears in the data panel.

## LEVEL III

In this section you take full creative control of your camera. Depending on the selected exposure mode, you will control the aperture, shutter speed, or both to capture your image.

In the previous sections, only the Program (P) exposure mode has been explored. Here you will learn to use the Aperture Priority (A), Shutter Priority (S), and Manual (M) exposure modes. Select A-mode to control the depth-of-field in your images. Set S-mode to control the way moving subjects appear in your images. Set M-mode when you want full control over all the exposure functions.

A-Mode	Manually select aperture	39
S-Mode	Manually select shutter speed	42
M-Mode	Manually select the shutter speed and the aperture	45

- Each exposure mode can be explored independently.

In A-mode, you select the aperture and the camera automatically sets the shutter speed required for proper exposure. Set the camera to A-mode when you want to control the range of sharpness (depth-of-field) in an image. Refer to Aperture Control on page 41.

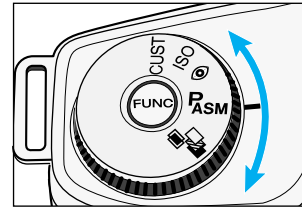

1. Turn the function dial to P<sub>ASM</sub>.

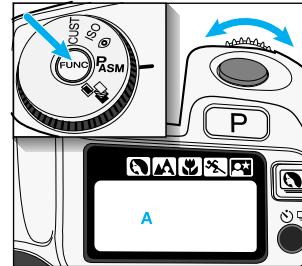

2. Press the function button and turn the control dial until A appears in the data panel.



3. Turn the control dial to select the aperture.

If 4000 or 30 s blinks in the data panel, the required setting is beyond the camera's shutter speed range. Turn the control dial until the blinking stops.

## A-Mode Flash

When the built-in flash is up or an attached accessory flash is on, it will fire each time a picture is taken. The camera's TTL automatic flash metering system will ensure proper exposure.

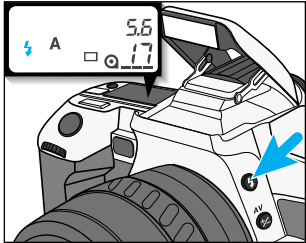

### Press the flash-mode button to pop-up the built-in flash.

- will appear in the data panel.
- The shutter speed is automatically set to 1/125 or slower.
- A smaller aperture (larger f-number) will result in a shorter flash range. Refer to Flash Range (p25) to determine the range of the built-in flash at the selected aperture.

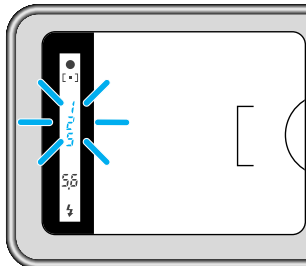

If 125 blinks in the viewfinder and the data panel, the light level is too bright for the selected aperture. Turn the control dial until the blinking stops or cancel the flash.

## Cancelling the Flash

Push the built-in flash down or turn the accessory flash off.

- will be displayed in the data panel.

## Aperture Control



**Large Aperture**  
(small f-number)



**Small Aperture**  
(large f-number)

The size of the aperture (lens opening) determines the depth-of-field in the final image as well as the intensity of the light falling on the film. Depth-of-field is the range in front of and behind the focus point that appears sharp in the final image. In the viewfinder, only the plane the camera is focused on will appear sharp. The photographed image however, will have a depth-of-field corresponding to the selected aperture.

Large apertures (small numbers) limit the depth-of-field to a narrow range in front of and behind the point of focus. Set a larger aperture when photographing portraits to make your subject stand out from the background.

Small apertures (large numbers) provide greater depth-of-field. Set a small aperture when photographing landscapes to ensure your entire scene is sharp.

- Usable apertures will depend on the aperture range of the lens you are using.

## S-MODE – SHUTTER PRIORITY

In S-mode, you select the shutter speed and the camera automatically sets the aperture required for proper exposure. Use S-mode when you want to control the blur caused by subject movement.

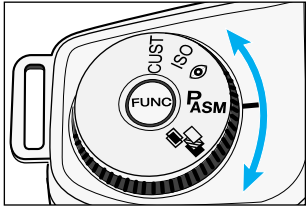

1. Turn the function dial to **P<sub>ASM</sub>**.

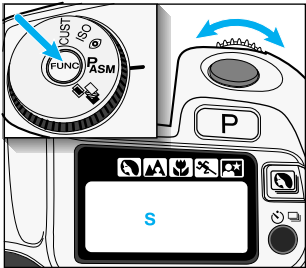

2. Press the function button and turn the control dial until **S** appears in the data panel.



3. Turn the control dial to select the shutter speed.

- The number 60, or 125, displayed in the data panel stands for 1/60th or 1/125th of a second.
- The seconds indicator appears in the viewfinder and data panel if the shutter speed is one second or longer.

If the aperture display in the data panel blinks, the required setting is outside the aperture range of the lens. Turn the control dial until the blinking stops.

## S-MODE – SHUTTER PRIORITY

### S-Mode Flash

When the built-in flash is up or an attached accessory flash is on, it will fire each time a picture is taken. Flash exposure is controlled by the camera's TTL automatic flash metering system.

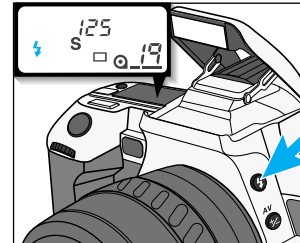

1. Press the flash-mode button to pop-up the built-in flash.

- ⚡ will appear in the data panel.

2. Turn the control dial to select any shutter speed up to 1/125th of a second.

- The camera automatically sets the aperture for the selected shutter speed.

### Cancelling the Flash

Push the built-in flash down or turn the accessory flash off.

- ⚡ will be displayed in the data panel.

## Shutter Control



Fast Shutter Speed



Slow Shutter Speed

In addition to controlling the duration of the exposure, shutter speed determines how moving subjects will appear in the final image. Depending on the speed of your subject, slow shutter speeds will make a moving subject appear to flow, creating a feeling of motion. In addition to stopping action, fast shutter speeds can help prevent blur caused by camera movement during exposure, known as camera shake.

- Use a fast shutter speed to stop the motion of your subject.
- Use a slow shutter speed to blur the motion of your subject.

M-mode gives you full control of the exposure. The camera's meter index displays how your settings compare to the exposure determined by the camera's metering system.

1. Turn the function dial to  $P_{ASM}$ .

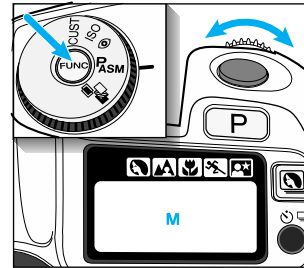

2. Press the function button and turn the control dial until M appears in the data panel.

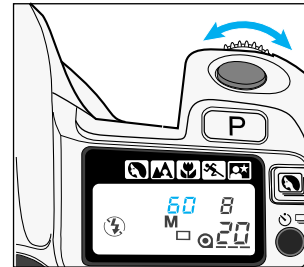

3. Turn the control dial to select the shutter speed.

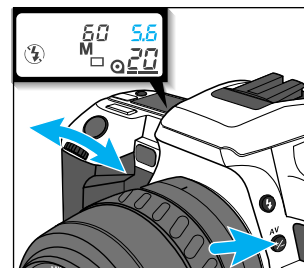



4. Press the exposure-compensation button and turn the control dial to select the aperture.



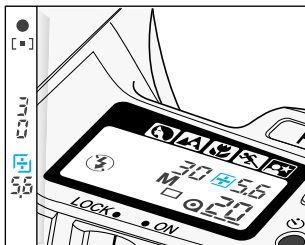

## Metering in Manual Mode

In manual mode, the meter index in the viewfinder and the data panel indicates how your exposure compares with the camera's meter reading.

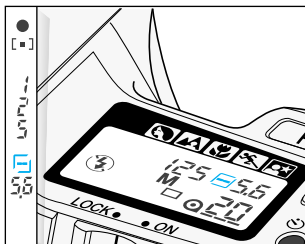

 – The exposure will over-expose your subject.



 – The exposure will under-expose your subject.

*If an exposure compensation indicator does not appear, your settings agree with the exposure determined by the camera.*

## M-Mode Flash

When the built-in flash is up or an attached accessory flash is on, it will fire each time a picture is taken. Flash exposure is controlled by the camera's TTL automatic flash metering system.

1. Press the flash-mode button to pop-up the built-in flash.

-  will appear in the data panel.

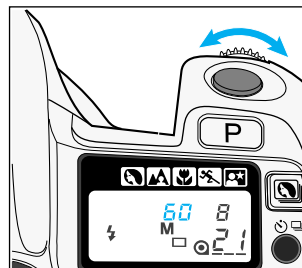

2. Turn the control dial to select any shutter speed up to 1/125th of a second.

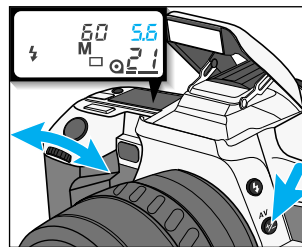

3. Press the exposure-compensation button and turn the control dial to select the aperture.

- Refer to the flash range table on page 25 to determine the aperture setting and the flash range.

## Cancelling the Flash

Push the built-in flash down or turn the accessory flash off.

-  will be displayed in the data panel.

# TAKING TIME EXPOSURES (buLb)

Set the shutter speed to bulb when you want to take time exposures. When bulb is selected, the shutter remains open as long as the shutter-release button is pressed.



1. Mount the camera on a tripod.

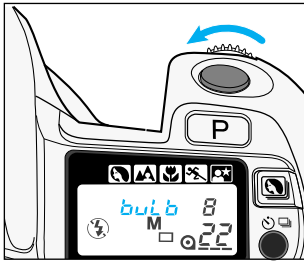

2. Set the camera to M-mode, then turn the control dial until *bulb* appears in the data panel.

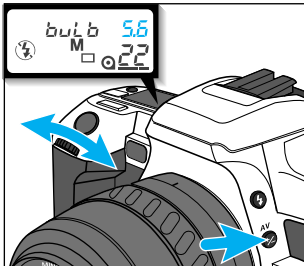

3. Press the exposure-compensation button and turn the control dial to select the aperture.

4. Compose the scene and focus on your subject.

- If the scene is too dark for autofocus to operate, press the focus-mode button and focus the lens manually (p53).

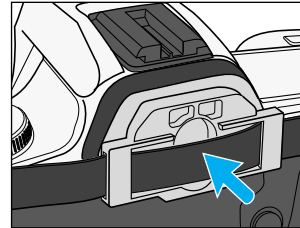

5. Firmly press the eyepiece cap into the eyepiece.

- The eyepiece cap prevents light from entering thru the viewfinder and affecting the metered exposure.

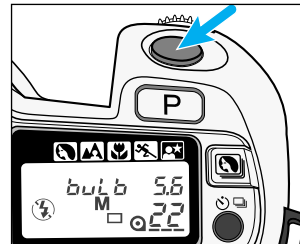

6. Press and hold the shutter-release button to take the picture.

- The shutter remains open as long as the button is pressed.

# ADDITIONAL FEATURES

Wide focus area uses the camera's three focus sensors to automatically focus on your subject. The wide focus area provides greater framing flexibility and makes it easier for the camera to focus on moving subjects. Wide focus area is the camera's standard focus mode.

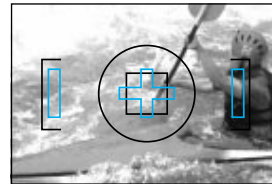

The camera determines which sensor is focusing on your subject and sets the focus accordingly.

- The focus areas are not visible in the viewfinder frame.

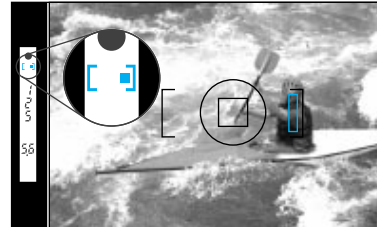

*The focus area indicator in the viewfinder tells you which sensor the camera is using.*

Spot AF uses the center focus sensor and the current metering mode (p55) to lock focus and exposure. The focus and exposure settings remain locked until the spot AF button is released.



1. Place your subject inside the spot-focus area.

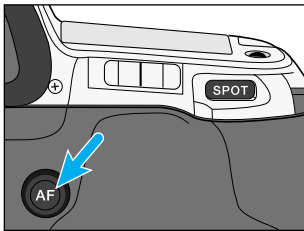

2. Press and hold the spot AF button.

- Focus is confirmed when ● appears in the viewfinder.

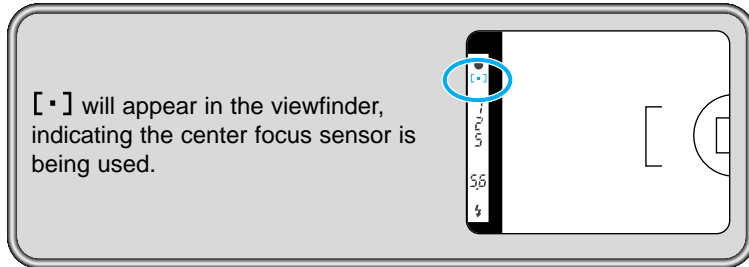

3. Press the shutter-release button all the way down to take the picture.

- Focus and exposure readings are held until the spot AF button is released.

Focus the lens manually when autofocus is not suitable and focus hold is not possible. The autofocus system will monitor focus and indicate when a subject in the focus frame is in focus.

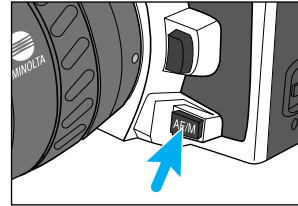

1. Press the focus-mode button. **M.FOCUS** will appear in the data panel.

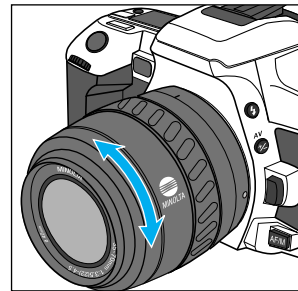

2. Turn the focusing ring until your subject appears sharp and focused.

- ● appears in the viewfinder when the subject in the focus frame is in focus.
- Press the focus-mode button again to return to the autofocus mode.

### AF Power Zoom and xi-Series Lenses

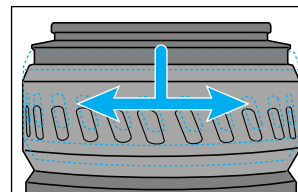

- Pull and turn the control ring until your subject appears sharp.

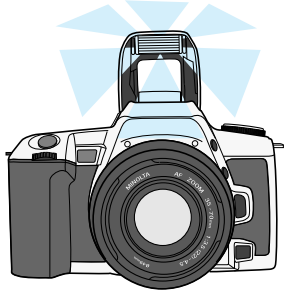

The AF Illuminator is a secondary function of the built-in flash. When the scene is too dark for the camera to focus accurately, the built-in flash fires a few short bursts when the shutter-release button is pressed partway to provide the illumination necessary for the camera to focus on your subject.

- Pressing the spot AF button also activates the AF illuminator.

- The range of the AF Illuminator flash is approximately one to five meters.
- The AF illuminator will not fire in continuous focus mode (C) or if flash cancel (⏏) is selected.
- The AF illuminator will not operate with 300mm or longer single focal length lenses.
- The AF illuminator will not operate with 3x-1x Macro Zoom.
- When an accessory flash is attached, its AF illuminator will be active in place of the camera's AF illuminator.

**Custom Function 9 (p75) lets you cancel the built-in flash's AF illuminator if it will interfere with your subject or is inappropriate.**

Fourteen-Segment Honeycomb-Pattern Metering uses information from the autofocus system to set the metering pattern according to the position of the main subject. The light metered by each applicable segment is then evaluated to determine the degree of spot-lighting or backlighting present in your scene. The focus-area indicator displays the sensor being used when the shutter release button is pressed partway down.

Fourteen-Segment Honeycomb-Pattern Metering is the camera's standard metering mode and is appropriate for most photographic situations.

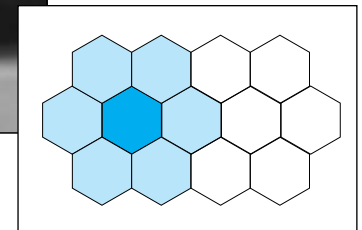
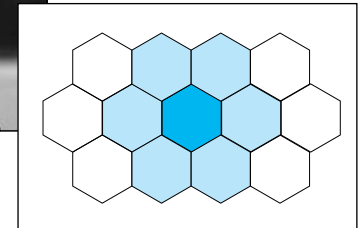

## EXPOSURE – Spot Metering



Use only the center metering segment to lock the exposure settings without locking the focus. The exposure remains locked until the spot/AE lock button is released.

- Pressing the spot/AE lock button sets the flash to slow sync mode (p66).



1. Place the spot-metering area on the subject whose exposure you want to lock.

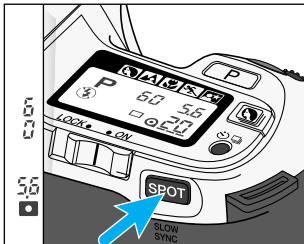

2. Press and hold the spot/AE lock button.

-  and the locked exposure will be displayed in the viewfinder.



3. Recompose the scene as desired, then press the shutter-release button all the way down to take the picture.
- The exposure is held until the spot/AE lock button is released.

## EXPOSURE – Exposure Compensation

The metering system in this camera averages the readings from each active metering segment to determine an exposure that will achieve an average middle grey tone on the film.



Compensated Exposure



Metered Exposure

Bright scenes such as snow or beach scenes are often underexposed. Dark scenes are often overexposed. Exposure compensation lets you adjust the metered exposure +/- 3 stops in 1/2 stop increments.

*This effect is most visible when slide film is being used.*

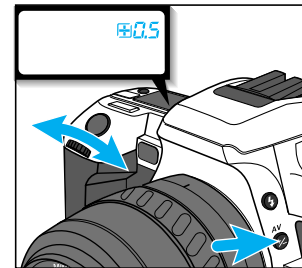

**Press the exposure-compensation button and turn the control dial until the desired compensation value appears in the data panel.**

- Exposure compensation remains until it is reset or cancelled.
- To cancel exposure-compensation, repeat the above procedure and select 0.0 or press the program-reset button.
- Exposure compensation is not available in M-mode.

## EXPOSURE – Setting the ISO Manually

Set the film speed manually when you want to override the DX-coded film speed or when using non-DX-coded film. Film speeds can be set from ISO 6 to 6400 in 1/3EV increments.

*Film must be loaded before the ISO can be changed.*

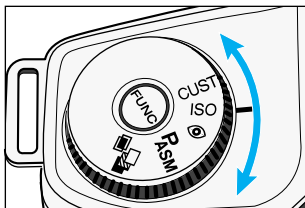

1. Turn the function dial to ISO.

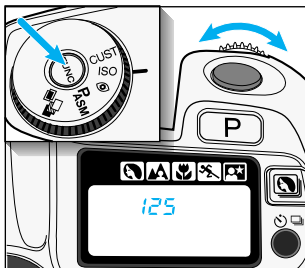

2. Press the function button and turn the control dial until the desired ISO value appears in the data panel.

## EXPOSURE – Bracketing



Metered Exposure      1/2 Stop Under      1/2 Stop Over

This function automatically exposes a 3 frame 1/2 stop increment bracketed series. The order of the exposures will be the metered exposure, 1/2-stop under the metered exposure, 1/2 stop over the metered exposure.

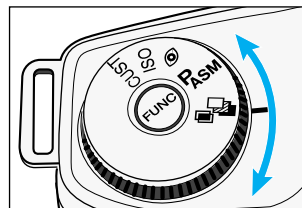

- The automatic bracketing feature cannot bracket flash exposures.

*This effect is most visible when slide film is being used.*

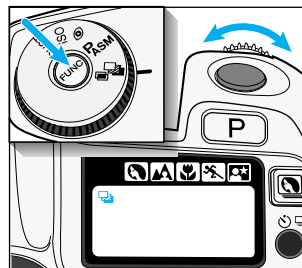

1. Turn the function dial to .



2. Press the function button and turn the control dial until  appears in the data panel.
-  *i* appears in the frame counter after the function button is released.

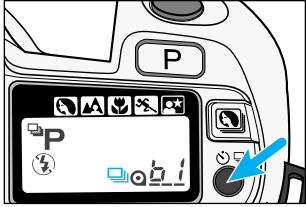

### 3. Select the desired drive mode.

- The drive mode is initially set to single (□) or continuous (□) whichever was set with exposure bracketing last.

### 4. Focus on and frame your subject, then press the shutter-release button all the way down to take the picture.

- Hold the shutter-release button down until the series is finished.
- Press the shutter-release button for each exposure.
  - Exposure is locked on the first frame of the series.
  - The exposure settings will change automatically.

## Flash Notes

- The built-in flash is set to flash cancel (⚡) when bracketing is selected.
- An attached Minolta accessory flash will be set to off when bracketing is selected.
- If an AF series flash is mounted and on when bracketing is selected, OFF FL will blink in the data panel and the shutter will lock until the flash is turned off.

## Cancelling Bracketing

1. Turn the function dial to .
2. Press the function button and turn the control dial until OFF appears in the data panel.

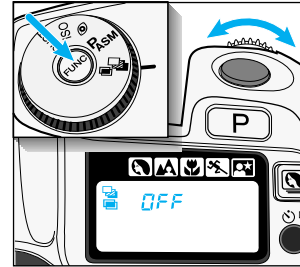

Sliding the main switch to LOCK in the middle of a bracketing series resets the bracketing series to the first frame (b i).

## Bracketing with the Exposure Compensation Button

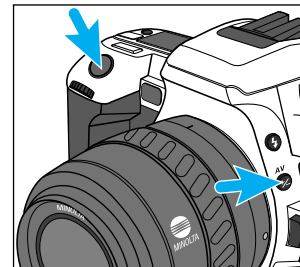

While pressing the exposure-compensation button, press the shutter release button all the way down and hold.

- The camera automatically exposes a three frame bracketed series.
- Releasing either button before the series is complete cancels the exposure series.



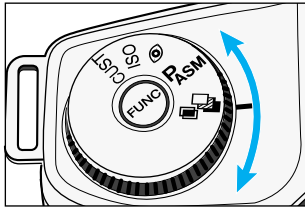

# EXPOSURE – Multiple Exposure

The multiple-exposure function makes it possible to expose two or more images on the same frame.

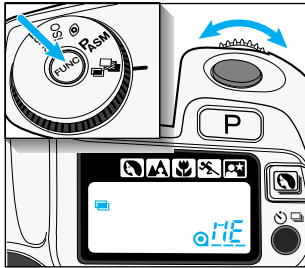

1. Turn the function dial to .



2. Press the function button and turn the control dial until  appears in the data panel.

- ME appears in the frame counter.

3. Compose the scene, then press the shutter-release button all the way down to take the first exposure.

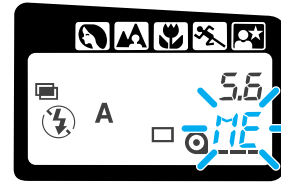

**ME** blinks in the data panel, indicating the next exposure will be the last in the series.

- To take more than 2 exposures, repeat steps 1 and 2 until ME glows in the data panel.

4. Press the shutter-release button all the way down again to take the last exposure.

- Multiple-exposure mode is cancelled after the last exposure has been taken.

## Cancelling Multiple Exposure

1. Turn the function dial to .

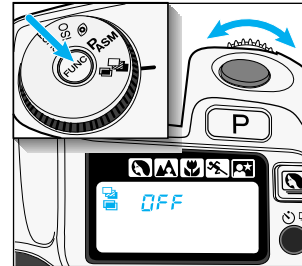

2. Press the function button and turn the control dial until OFF appears in the data panel.

Sliding the main switch to LOCK does not cancel multiple exposure mode.

## Metering Multiple Exposures

The meter in your camera determines exposure (EV) based on the assumption that only one exposure will be made on each frame. When making multiple exposures, the EV for each additional exposure needs to be reduced or over exposure will result.

- Compensation is not necessary if all of the exposures have dark backgrounds and the subjects of the exposures will not overlap.

### Compensate the exposures as follows:

Number of Exposures	1	2	3	4	6	8
Exposure Adjustment	0	-1	-1½	-2	-2½	-3

- The above corrections are intended as a general guideline. Some testing may be necessary to produce the desired results.
- Exposure can be compensated in 1/2 EV increments using the exposure compensation function (p57) and in 1/3 EV increments by changing the ISO manually (p58).



### High-speed Sync

HSS also lets you use large aperture/high shutter-speed combinations to separate your subject from the background by limiting the depth-of-field.



Conventional Fill Flash

The maximum sync speed for this camera is 1/125. However, with the 5400HS accessory flash (sold separately) shutter speeds up to 1/4000 can be used. High-speed sync (HSS) allows faster shutter speeds when fill flash is used on moving subjects outdoors.

### Attach the 5400HS flash and set it to standard mode.

- The camera will automatically switch to HSS mode and H will appear in the viewfinder and data panel.
- HSS cannot be used under fluorescent lights.
- Flash and color meters cannot meter the flash when high-speed sync is selected.

*Refer to the 5400HS instruction manual for details.*





Slow-shutter Sync

In P and A-modes, slow-shutter sync sets a slower shutter speed to increase the background or ambient lighting exposure in a flash picture. Flash output will automatically be decreased to maintain a correct exposure of your subject.

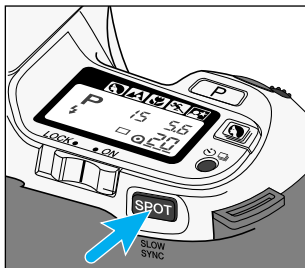

Conventional Flash



1. Frame your subject.
2. While pressing the spot/AE lock button, press the shutter-release button all the way down to take the picture.
  - If the background is bright or a large aperture is set (A-mode), the shutter speed may not be reduced.
  - Use a tripod if the shutter speed becomes too slow to allow sharp, hand-held pictures after you press the spot/AE lock button.
  -  and the locked exposure will be displayed in the viewfinder.

The Quartz-data function lets you record the date or time onto the lower-right corner of the photograph. The quartz data back has an automatic calendar through the year 2019.

- Imprinted data may be difficult to read if the lower-right corner of the photograph is bright or non-uniform.
- Imprinting size and position may differ according to printing conditions.
- Do not use the data back when temperatures exceed the operating range of 0 to 50 °C (32 to 122 °F).

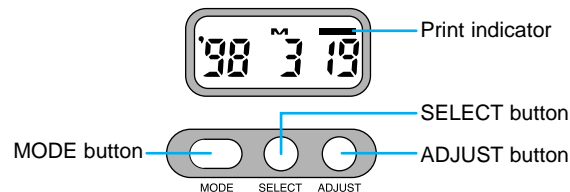

## Exposing the Date/Time

Before taking the picture...

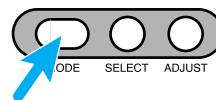

1. Press the MODE button to choose the data imprinting format.

- The display changes as follows:

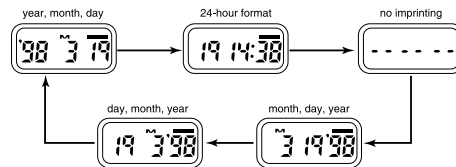

2. Take the picture.

- If the print indicator blinks after the shutter is released, the data was exposed.

## Setting the Date/Time

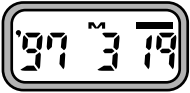

1. Press the **MODE** button to choose the data imprinting format.

- M will appear above the month.

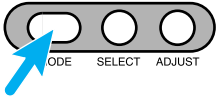

2. Use the **SELECT** button to move between different parts of the displayed data.

- The selected part will blink, indicating that it is the data to be changed.

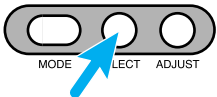

3. Press the **ADJUST** button to change the data to the correct value.

- Data continues changing as long as the button is held down.
- In time mode, pressing the ADJUST button while : is blinking resets the seconds counter to zero (not shown).

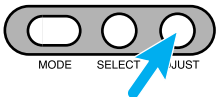

4. When all data is correct, press the **SELECT** button until the data stops blinking.

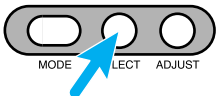

## Replacing the Battery

The quartz data back uses a CR2025 lithium battery, located on the inside of the back cover. Replace the battery if the display changes or becomes dim while the camera batteries are removed.

1. Open the back cover.

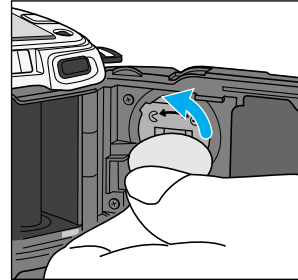

2. Using a coin or similar object, turn the battery cover counter-clockwise, then remove it.

3. Remove the old battery and replace it with a new one.

- The + side should face up.

4. Replace the battery cover, then reset the date and time.

# CUSTOM FUNCTIONS

Using the custom functions, you can tailor selected camera settings to suit your shooting style or preferences. The functions you can customize are explained on pages 71-75.

## Setting the Custom Functions

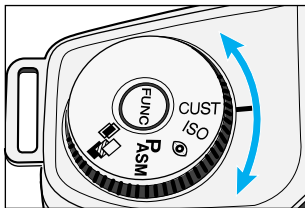

1. Turn the function dial to **CUST**.
2. Turn the control dial to select the number of the custom function you want to change.

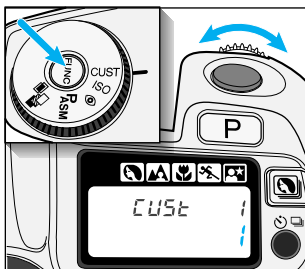

3. Press the function button and turn the control dial to select the desired setting.
4. Turn the function dial to any position other than **CUST**.
  - The shutter cannot be released if the function dial is set to **CUST**.

To reset all of the custom functions to their default setting (1) ...

1. Slide the main switch to **LOCK**.
2. Turn the function dial to **CUST**.
3. Press the function button and slide the main switch from **LOCK** to **ON**.
  - **ELC** will blink in the data panel.

# CUSTOM FUNCTIONS

## Cust 1 – AF Release Priority

### 1 – AF priority

Shutter will not release until ● or (●) appears in the viewfinder.

### 2 – Release Priority

Shutter releases even if the focus cannot be confirmed. Use Release priority when photographing moving subjects.

- When continuous-advance mode is selected, the camera will not update the focus while the shutter-release button is pressed.

## Cust 2 – Film Rewind Start

### 1 – Automatic

Film is automatically rewound at the end of the roll.

### 2 – Manual

Press the manual-rewind button to initiate rewind. (p28).

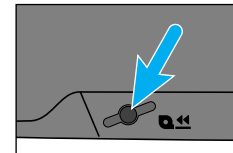

## Cust 3 – Film Tip

### 1 – Film is completely rewound into the cartridge.

### 2 – Leader is left out of the cartridge after rewind.

- Sliding the main switch to **LOCK** during rewind causes the film to be rewound into the cartridge when the power is switched back on.

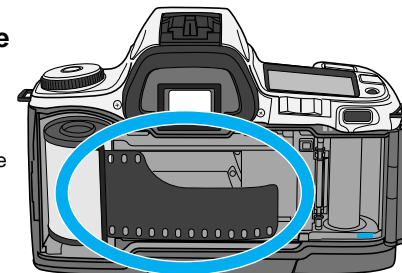

## Cust 4 – DX Memory

### 1 – DX Memory Off

Film speed is always set to the DX-coded ISO. Non-DX-coded film is set to the ISO of the previous roll.

### 2 – DX Memory On

Changes to the film speed for a DX coded roll are saved and applied to future rolls with the same DX coded ISO. Use to consistently over/under-expose a specific film type.

- Film must be loaded before the ISO can be changed.

## Cust 5 – Flash Control in P Mode

### 1 – Autoswitchover

Built-in flash pops-up when shutter-release button is pressed partway down. Flash will fire when necessary.

### 2 – Fill Flash (Manual Switchover)

Flash-mode button must be pressed to raise the built-in flash (p26). Flash will fire every time the shutter is released.

- The TTL exposure system will ensure correct exposure.
- Push the built-in flash down to select flash cancel (☒).

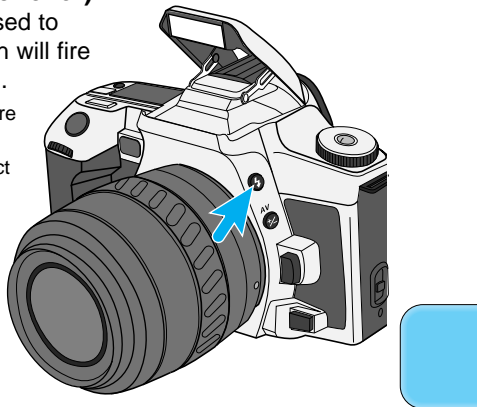

## Cust 6 – Focus-hold button (LENS)

*The mounted lens must have a focus hold button.*

### 1 – Focus Hold

Pressing the focus-hold button on the lens locks the focus.

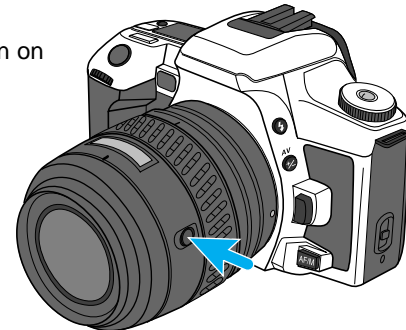

### 2 – Spot Focus

Pressing the focus-hold button on the lens selects the center focus sensor (p51).

### 3 – Continuous Focus

Select this setting when focusing on moving subjects.

Pressing the focus-hold button on the lens selects continuous focus.

## Cust 7 – Spot AF button

### 1 – Spot Focus

Press the Spot AF button to lock the focus using the center focus sensor (p52).

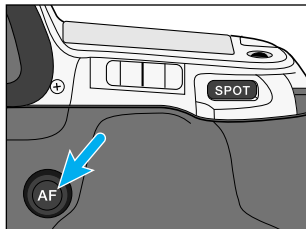

### 2 – Selectable focus area

Press the Spot AF button and turn the control dial to specify the desired local focus area.

- The selected focus area is displayed in the viewfinder data panel.
- The focus area remains selected until it is changed or CUST – 7 is returned to setting 1.
- When the RF 500mm lens or the AF Power Zoom 35-80mm lens is attached, only the center local focus area can be selected.

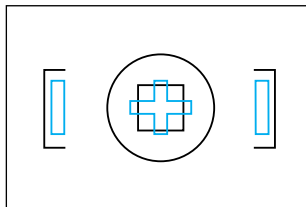

Local Focus Area Locations

The sequence is:

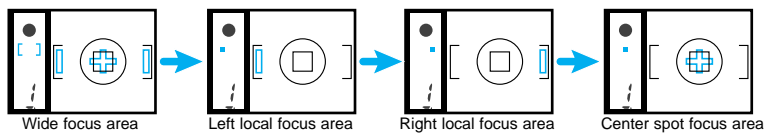

## Cust 8 – Spot/AE Lock button

### 1 – Press to activate

Spot area is used for metering until the spot button is released.

### 2 – Press once to activate, press again to cancel.

Spot metering area is used for metering until the spot/AE lock button is pressed again.

- Slow-shutter sync is set when the flash is selected.

## Cust 9 – AF Illuminator (built-in flash)

### 1 – AF Illuminator on

When the built-in flash is up, its AF illuminator will fire when necessary to assist focus.

- The AF illuminator does not fire when flash cancel (Ⓢ) is selected.

### 2 – AF Illuminator cancelled

The built-in flash's AF illuminator will not fire. Other flash functions will operate normally.

- An attached accessory flash's AF illuminator will not be cancelled.

# APPENDIX

## Program Reset Button

Press the program-reset button to return the following camera functions to their program settings.

FUNCTION	P-MODE SETTING
Exposure mode	P mode
Focus mode	Autofocus
Flash mode	Auto-on
Exposure Compensation	+/- 0
Film-drive mode	Single-frame advance
Self-timer	Cancelled
Bracketing	Cancelled
Multiple Exposure	Cancelled

- Date, red-eye reduction, ISO settings, and custom function settings will not change.
- Pressing the program-reset button will also reset an attached dedicated accessory flash's program settings. Refer to the flash instruction manual for details.



## ACCESSORY INFORMATION

This camera is designed to work specifically with lenses and accessories manufactured and distributed by Minolta. Using incompatible accessories with this camera may result in unsatisfactory performance or damage the camera and accessories.

### Compatibility of Accessories

#### Lenses

- All Minolta AF lenses can be used with this camera.
- MD and MC series lenses (manual focus) cannot be used with this camera.

#### Flashes

- All Minolta i, si, and HS series flash units, and the Vectis SF-1 flash, are compatible with this camera. The flash will always fire when the flash unit is on. (Unless Custom Function #5 is set to Autoflash (setting 1). In this case, the flash will fire only when necessary when it is on and the camera is in Full-Auto and Subject Program modes.)
- The Flash Shoe Adapter FS-1100 is required to mount AF series flash units (4000AF, 2800AF, 1800AF, and Macro flash 1200AF).
- When the FS-1100 is used...
  - The flash will fire every time the shutter is released.
  - The AF illuminator will not activate.
  - The built-in flash is set to fill flash when the accessory flash is disconnected.
- X-series flashes and flashes sold by other manufacturers cannot be used with this camera.

#### Others

- The following accessories are not compatible with this camera:

Control Grip CG-1000	Data Receiver DR-1000
Creative Expansion Cards	Anglefinder
Magnifier	Wireless Controller IR-1N

## ACCESSORY INFORMATION

### Accessory Flash Control

When using an accessory flash, the desired flash mode can be selected using the camera or the flash.

#### CAMERA

**Press the flash-mode button and turn the control dial to select the desired flash mode.**

- The camera transfers data to the accessory flash immediately.

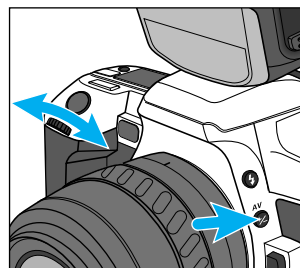

#### FLASH

**Press the flash's ON/OFF button to select the desired flash mode.**

- Data is not transferred from the flash until the shutter-release button is pressed partway down.
- Fill flash cannot be selected when the camera is set to Full-Auto or any of the Subject Program modes.

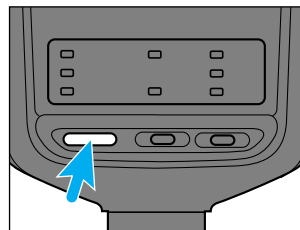

## For owners of the optional lens kits

### Lens Hood

Flare is non-image forming light that degrades image quality. A lens hood improves image quality by reducing flare.

- Remove a lens hood before using the camera's built-in flash.

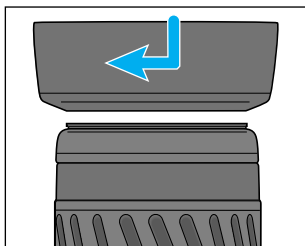

**Fit the lens hood into the mount at the end of the lens barrel, then turn the hood clockwise until it stops.**

- To store the hood, reverse it, attach it to the lens, then replace the lens cap.

### Lens Specifications

	AF Zoom 35 – 70mm f/3.5-4.5	AF Zoom 28 – 80mm f/3.5-5.6
<b>Construction:</b>	7 elements/7 groups	10 elements/10 groups
<b>Angle of View:</b>	63° – 34°	75° – 30°
<b>Min. Focus Distance:</b>	0.5m (1.6 ft.)	0.38m (1.2 ft.)
<b>Max. Magnification:</b>	0.15X	0.26X
<b>Min. Aperture:</b>	f/22–27	f/22–38
<b>Filter Diameter:</b>	49mm	62mm
<b>Dimensions:</b>	68.5 x 63mm	69 x 74mm
<b>Weight:</b>	210g (7.44 oz)	230g (8.125 oz)

- Specifications are based on the latest information available at the time of printing and are subject to change without notice.

Indicators will blink in the viewfinder or data panel when there is a problem with the exposure.

MODE	DISPLAY	CAUSE	ACTION
P A S M		Light level is beyond the range of available shutter speeds and apertures.	Bright Light: use slower speed film, a neutral density (ND) filter, or reduce the light level of your surroundings. Low Light: use higher speed film or a flash.
		Scene or subject brightness is beyond the camera's metering range.	
A		The required shutter speed is beyond the range of the camera.	Select a larger or smaller aperture until the display stops blinking.
S		The required aperture is beyond the range of the lens.	Select a faster or slower shutter speed until the display stops blinking.

## TROUBLE SHOOTING

Contact your nearest Minolta Service Facility if the following information does not cover the problem which you are experiencing or the condition continues.

PROBLEM	CAUSE
No display appears when the camera is switched on.	Batteries are loaded incorrectly.
	Batteries are exhausted.
Autofocus does not work when shutter-release button is pressed partway down.	Situation is unsuitable for autofocus.
	Camera is set to manual focus mode.
	Subject is too close.
Shutter cannot be released.	Focus cannot be confirmed.
	Camera is attached to a microscope or telescope.
Flash fires when the shutter-release button is pressed partway down.	The AF illuminator is on.
Flash picture is too dark.	Subject is beyond flash range.
Lower part of flash picture is dark.	Lens hood attached.
Err appears in the data panel.	Camera Malfunction

## TROUBLE SHOOTING

SOLUTION	PAGE
Remove and reinstall the batteries.	11
If the camera battery is exhausted, install a new battery.	11
Use focus hold or manual focus.	23
Press the focus mode button to return the camera to autofocus mode.	53
Check the minimum focus distance for your lens.	—
Use focus hold or manual focus.	23
Contact a Minolta service facility for information.	—
This is a normal camera operation.	—
Make sure the subject is within the flash range.	25
Remove lens hood.	82
Remove and reinstall the batteries. If normal camera operation does not resume or the camera malfunctions repeatedly, contact an authorized Minolta Service Facility.	11

## Operating Temp and Conditions

- This camera is designed for use from -20 to 50 °C (4 to 122 °F).
- Never leave your camera where it may be subjected to extreme temperatures such as the glove compartment of a car.
- Data panel response time will be slow at colder temperatures. The display will temporarily darken at higher temperatures, but will restore when the temperature normalizes.
- Never subject the camera to extreme humidity.
- To prevent condensation from forming, place the camera in a sealed plastic bag when bringing it from cold environment to a warm environment. Allow it to come to room temperature before removing it from the bag.
- The low-battery symbol may appear even with fresh batteries depending on the storage conditions. To restore camera power, repeat turning the camera on and off.
- Battery capacity decreases at colder temperatures. Keep your camera and spare batteries in a warm inside pocket when shooting in cold weather. Batteries will regain some of their capacity when warmed to normal operating temperature.

## Storage

When storing your camera for extended periods,

- Always attach the protective caps.
- Store in a cool, dry, and well-ventilated area away from dust and chemicals such as moth balls. For long periods, place the camera in an airtight container with a silica gel drying agent.
- Periodically release the camera's shutter to keep it operating properly.
- Before using after prolonged storage, check the camera's operation to make sure it is functioning properly.

## Cleaning

- If the camera or lens barrel is dirty, wipe it gently with a soft, clean, dry cloth.  
If the camera or lens comes in contact with sand, gently blow away loose particles - wiping may scratch the surface.
- To clean the lens surface, first brush away any dust or sand then, if necessary, moisten a lens tissue with lens cleaning fluid and gently wipe the lens in a circular motion, starting from the center.
- Never place lens fluid directly on the lens.
- Never touch the interior of the camera, especially the shutter and mirror, doing so may impair their alignment and movement. Dust on the mirror will not affect the picture quality.
- Never use compressed air to clean the camera's interior, it may cause damage to sensitive interior parts.
- Never use organic solvents to clean the camera.
- Never touch the lens surface with your fingers.

## Before Important Events

- Check the camera's operation carefully, or take test photographs.
- Minolta is not responsible for any loss that may occur due to an equipment malfunction.

## Questions and Service

- If you have questions about your camera, contact your local camera dealer or write to the Minolta distributor in your area.
- Before shipping your camera for repair, please contact an authorized Minolta Service Facility for details.

## SPECIFICATIONS

<b>Camera Type:</b>	35mm SLR with built-in flash, autoexposure (AE), and action predictive autofocus (AF)
<b>Lens Mount:</b>	Minolta A-type bayonet mount
<b>Viewfinder:</b>	SLR roof mirror type, 90% field of view, Magnification: 0.75X
<b><u>Shutter</u></b>	
<b>Type:</b>	Electronically-controlled, vertical-traverse, focal-plane type
<b>Speeds:</b>	30 sec. - 1/4000 sec., bulb
<b>Flash sync speed:</b>	1/125 or slower (synchronizes with all speeds in HSS mode).
<b><u>Focus</u></b>	
<b>Type:</b>	TTL phase-detection system, multi metering with cross hair type CCD line sensor metering cell. Autofocus and manual focus modes.
<b>AF Sensitivity Range:</b>	EV -1 to18 (ISO 100)
<b>AF Illuminator:</b>	Built-in with range of 1.0 - 5.0m. Automatically activated in low-light/ low-contrast situations.
<b>AF Control:</b>	Single-shot, continuous, automatic AF-mode selection.
<b><u>Exposure</u></b>	
<b>Modes:</b>	P, A, S, M, and 5 Subject Program modes (Portrait, Landscape, Close-up, Sports, Night Portrait)
<b>Type:</b>	TTL metering; direct TTL metering for flash
<b>Metering Cell:</b>	14-segment honeycomb pattern SPC for ambient light and flash-metering SPC for flash.
<b>Metering Range:</b>	Multi-segment metering: EV 1 - 20, Spot metering: EV 4 - 20 (ISO 100, f/1.4 lens)
<b>Film-speed Setting:</b>	Automatic: ISO 25 to 5000 for DX-coded film. Manual: ISO 6 to 6400 in 1/3 EV increments. Flash: ISO 25 - 1000.

## SPECIFICATIONS

<b><u>Film Transport</u></b>	
<b>Loading:</b>	Auto load
<b>Drive Modes:</b>	Single frame, continuous advance (2 frames/sec.), self-timer, exposure bracketing, and multiple exposure.
<b>Rewind:</b>	Auto rewind, manual start (Count-down display)
<b>Frame counter:</b>	Forward (shows number of exposures taken)
<b><u>Built-in Flash</u></b>	
<b>GN:</b>	12 (ISO 100 in meters)
<b>Coverage:</b>	28mm angle of view
<b>Recycling Time:</b>	Approx. 3 sec. (according to Minolta test methods)

### **Additional**

**Power:** Two CR2 lithium batteries

### **Battery Performance:**

Flash Use (%)	Condition A		Condition B	
	20 °C	-10 °C	20 °C	-10 °C
0	40 rolls	30 rolls	65 rolls	50 rolls
50	17 rolls	13 rolls	23 rolls	18 rolls
100	11 rolls	8 rolls	14 rolls	10 rolls

\* 24 exposure rolls

Condition A: Lens(28-80 f/3.5-5.6) focused from infinity to 2m three times and the shutter-release button held for ten seconds before each exposure.

Condition B: Lens(28-80 f/3.5-5.6) focused from infinity to 2m and the shutter-release button held for five seconds before each exposure.

- Battery performance will vary with usage conditions.
- Exposures taken at a rate of 2 rolls/month.

**Dimensions (WxHxD):** 135.0 x 90.0 x 58.5mm (WxHxD)  
QD model: 135.0 x 90.0 x 61.0mm (WxHxD)

**Weight :** 350g (w/o camera battery),  
QD model: 360g (w/o camera battery)

Specifications and accessories are based on the latest information available at the time of printing and are subject to change without notice.

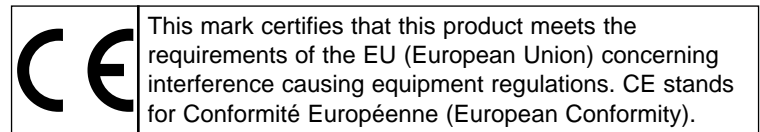

<b>Minolta Co., Ltd.</b>	<b>3-13, 2-Chome, Azuchi-Machi, Chuo-Ku, Osaka 541-8556, Japan</b>
<b>Minolta GmbH</b>	Kurt-Fischer-Strasse 50, D-22923 Ahrensburg, Germany
<b>Minolta France S.A.</b>	365 Route de Saint-Germain, F-78420 Carrieres-Sur-Seine, France
<b>Minolta (UK) Limited</b>	Rooksley Park, Precedent Drive, Rooksley, Milton Keynes, MK13 8HF, England
<b>Minolta Austria Ges. m.b.H.</b>	Amalienstrasse 59-61, A-1131 Wien, Austria
<b>Minolta Camera Benelux B.V.</b>	Zonnebaan 39, P.O. Box 6000, NL-3600 HA Maarsse, The Netherlands
<b>Belgium Branch</b>	Kontichsesteenweg 38, B-2630 Aartselaar, Belgium
<b>Minolta (Schweiz) AG</b>	Riedstrasse 6, CH-8953 Dietikon, Switzerland
<b>Minolta Svenska AB</b>	P.O.Box 9058, Albygatan 114, S-17109 Solna, Sweden
<b>Finland Branch</b>	Niittykatu 6 PL 37, SF-02201 Espoo, Finland
<b>Minolta Portugal Limitada</b>	Av. do Brasil 33-A, P-1700 Lisboa, Portugal
<b>Minolta Corporation</b>	
<b>Head Office</b>	101 Williams Drive, Ramsey, New Jersey 07446, U.S.A.
<b>Los Angeles Branch</b>	11150 Hope Street Cypress, CA 90630, U.S.A.
<b>Minolta Canada Inc.</b>	
<b>Head Office</b>	369 Britannia Road East, Mississauga, Ontario L4Z 2H5, Canada
<b>Vancouver Branch</b>	230-3771 Jacombs Road, Richmond, B.C. V6V 2L9, Canada
<b>Minolta Hong Kong Limited</b>	Room 208, 2/F, Eastern Center, 1065 King's Road, Quarry Bay, Hong Kong, China
<b>Minolta Singapore (Pte) Ltd.</b>	10, Teban Gardens Crescent, Singapore 608923
<b>Shanghai Minolta Optical Products Co., Ltd.</b>	368 Minolta Road, Songjiang, Shanghai, China

© 1998 Minolta Co., Ltd. under the Berne Convention  
and Universal Copyright Convention