

MINOLTA

E INSTRUCTION MANUAL

---

**MAXXUM<sup>®</sup>**

---

***7000i***

## DATA PANEL

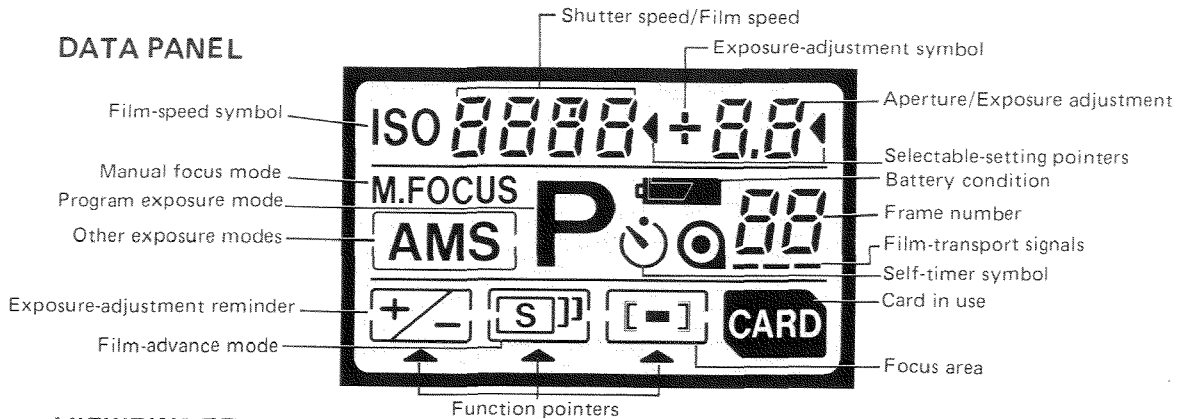

## VIEWFINDER

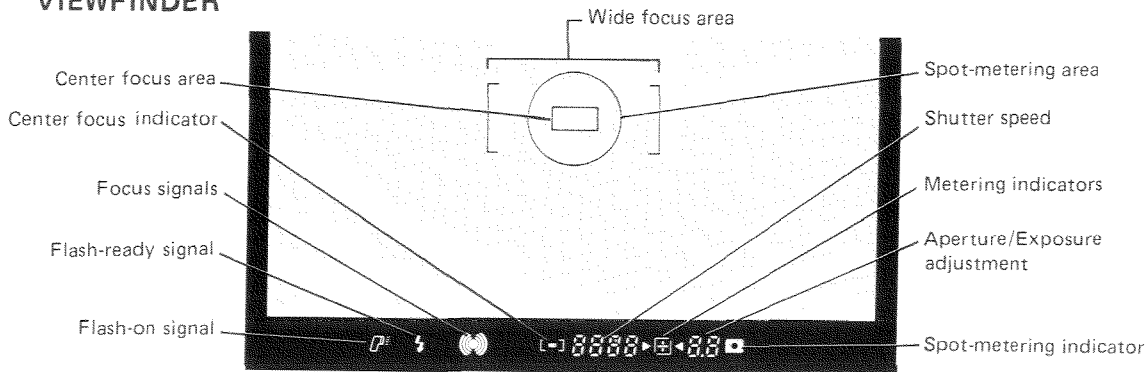

## NAMES OF PARTS

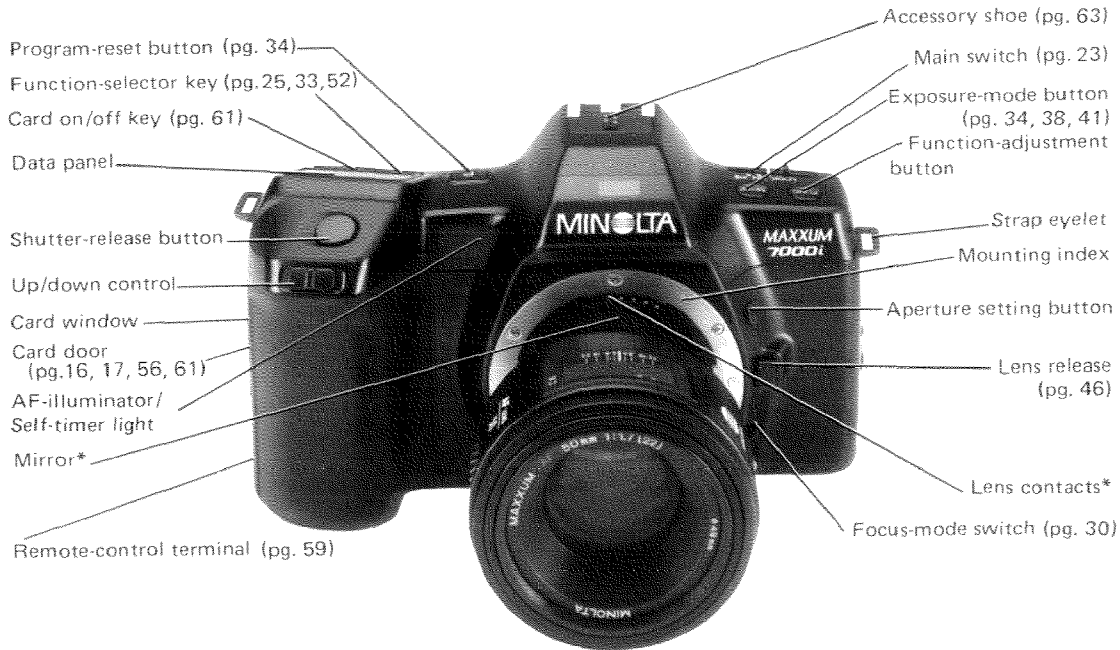

**\* Do not touch**

Page number in parentheses indicates where to locate information about the part.

Your new Maxxum 7000i camera is the world's first truly intelligent autofocus SLR camera. All of the camera's functions are integrated for unparalleled ease of operation and ultimate precision. You can take sharply focused, properly exposed pictures one after another and rely on your Maxxum 7000i to deliver outstanding results from one roll of film to the next.

The following are the Maxxum 7000i's most impressive features:

- Intelligent autofocusing with predictive focus control and multiple autofocus sensors that enable faster, more precise focusing than ever before possible.
- Intelligent automatic exposure using the world's first multi-pattern metering system coupled to the autofocus system.
- Advanced automatic multi-program selection that instantly selects the exposure program for any lens you use.
- Intelligent automatic flash control to ensure perfectly exposed pictures in daylight, low light, or no light at all.
- Automatic film transport that enables taking sharply focused pictures at up to 3 frames per second.
- World's largest selection of autofocus system accessories, including Creative Expansion Cards, Maxxum Flash units, and more than 31 Maxxum autofocus lenses.

You probably want to begin using your new camera right away. But before you start, please read through this instruction manual to learn how your Maxxum 7000i operates.

## TABLE OF CONTENTS

### BASICS

ATTACHING THE LENS . . . . .	4
ATTACHING THE NECKSTRAP . . . . .	6
PUTTING THE CAMERA IN ITS CASE . . . . .	8

### BATTERY INFORMATION

Loading the battery . . . . .	9
Battery check . . . . .	10

### FILM INFORMATION

Loading film . . . . .	12
Film speed setting . . . . .	15
Film rewind . . . . .	17

### TAKING PICTURES

Holding the camera . . . . .	19
Fully automatic operation . . . . .	20

### MAKING THE MOST OF YOUR CAMERA

MAIN SWITCH . . . . .	23
Audible signals . . . . .	23

### FOCUSING

Focus-area selection . . . . .	24
Automatic focusing . . . . .	26
How to use focus hold . . . . .	27
Manual focusing . . . . .	30

### FILM-ADVANCE MODES

Single-frame advance . . . . .	33
Continuous advance . . . . .	33

### EXPOSURE CONTROL

Program Mode . . . . .	34
Program reset button . . . . .	34
Aperture-priority mode . . . . .	38
Shutter-priority mode . . . . .	41
Manual mode . . . . .	44
Aperture and shutter-speed settings . . . . .	47
Metering system . . . . .	48
Spot measurements . . . . .	49
Exposure adjustment . . . . .	51

### FLASH INFORMATION . . . . . 54

### OTHER FUNCTIONS

Self-timer . . . . .	56
Long exposures . . . . .	58

### ACCESSORIES . . . . . 61

### TROUBLESHOOTING GUIDE . . . . . 68

### TECHNICAL DETAILS . . . . . 70

### CARE AND STORAGE . . . . . 75

## IMPORTANT INFORMATION

The Minolta Maxxum 7000i camera is designed to offer innovative functions and performance through the combination of the camera body, Maxxum AF lenses, Minolta Maxxum Flash units, and other accessories distributed by Minolta. We thus caution users that the attachment or use of incompatible lenses, flashes, and accessories may result in unsatisfactory performance or damage to the Minolta Maxxum 7000i camera. To obtain optimum performance throughout the life of your Minolta Maxxum 7000i camera, we recommend that you use only lenses, flashes, and other accessories distributed by Minolta for the Maxxum 7000i camera.

# BASICS

Lens	4
Neckstrap	6
Camera Cases	8
Battery	9
Film	12

## ATTACHING THE LENS

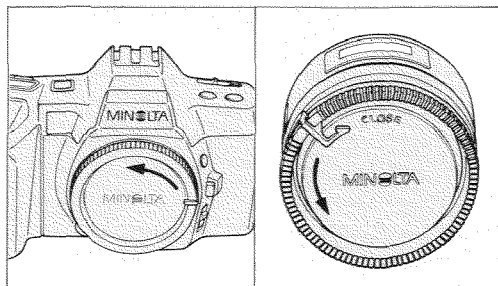

### To attach:

1. Remove body cap and rear lens cap as shown.

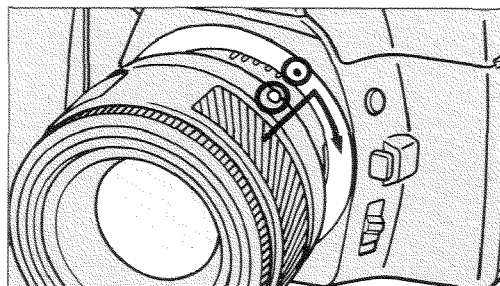

2. Align red bead on lens barrel with red dot on camera's lens mount. Insert lens bayonet into mount and turn lens clockwise until it locks in place with a click.



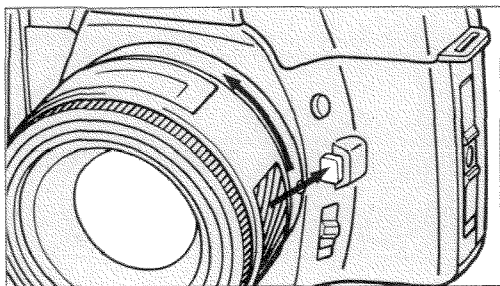

**To remove:**

1. While pressing lens release, turn lens counterclockwise as far as it will go, then lift lens out of mount.
2. Attach another lens or the body cap to prevent dust from entering the camera.

When the camera is set to A or M mode and the lens is removed, the aperture display in the data panel and viewfinder shows “- -”.

**NOTE**

- When attaching or removing lenses, never touch anything inside the camera, especially the lens contacts or mirror.
- To protect the lens contacts and the lens elements, attach the lens caps whenever the lens is not in use.

**Care Of Glass Surfaces**

- Never touch lens elements or the camera’s eyepiece with your fingers. If the lens becomes dirty, clean it gently with a lens brush. Only if necessary, moisten a sheet of lens tissue with one drop of lens-cleaning fluid. Then, starting at the center and using a circular motion, lightly wipe the surface of the lens.
- Never lift the mirror or touch its surface, as this may impair its alignment. Dust specks on the mirror’s surface will not affect exposure or picture quality. If the dust specks are annoying, the camera can be cleaned at an authorized Minolta service facility.

## ATTACHING THE NECKSTRAP AND EYEPiece CAP

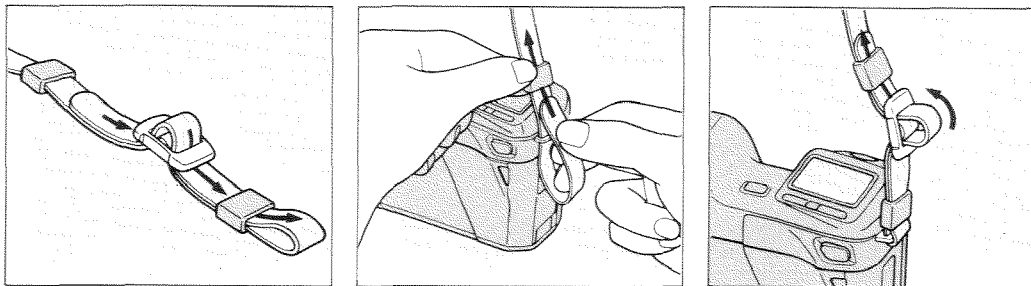

A neckstrap is supplied with your Maxxum 7000i. Attach it to the camera as shown above. An eyepiece cap is also supplied and can be slipped onto the neckstrap to keep it handy for use.

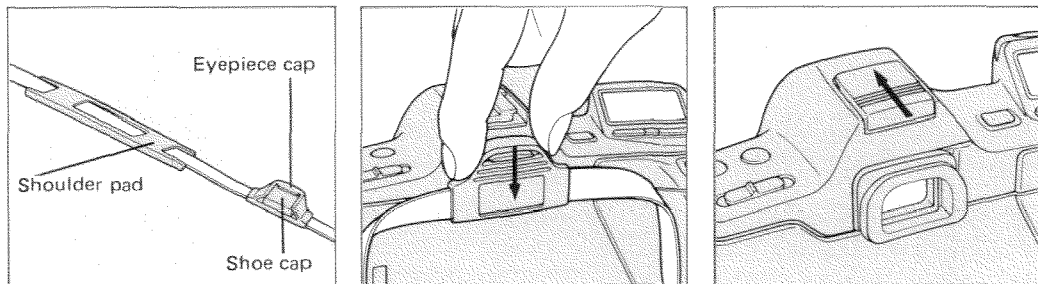

The eyepiece cap slides over the eyepiece frame to prevent stray light from entering the eyepiece and affecting exposure. It should be used whenever the eyepiece is not shielded by your head, as when using the self-timer or when operating the camera by remote control. To attach the eyepiece cap, first remove the Eyepiece Cup EC-7, then slip the cap over the frame.

An accessory shoe cap is supplied that slips into the accessory shoe to protect the contacts from dust and grime. When using a flash unit, slip the accessory shoe cap into the eyepiece cap.

## PUTTING CAMERA IN ITS CASE

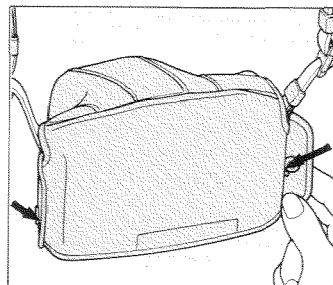
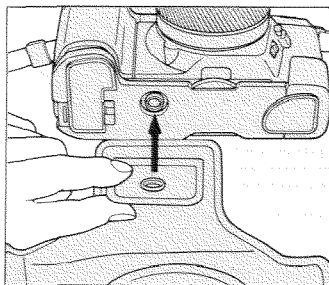
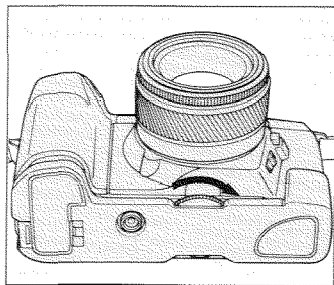

Various camera cases are available as optional accessories for the Maxxum 7000i.

**To put camera in its case:**

1. Attach lens cap.
2. If using a zoom lens, turn zoom ring until lens barrel is at its shortest position.
3. Follow the diagrams to put camera into case.

## BATTERY INFORMATION

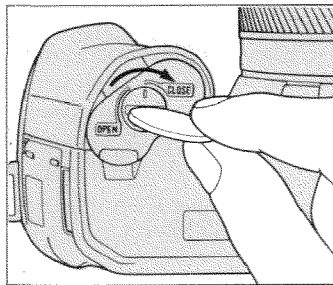
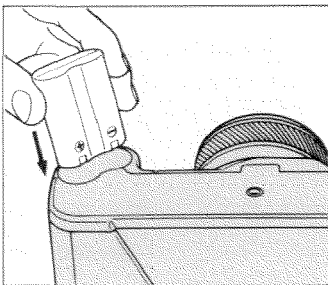
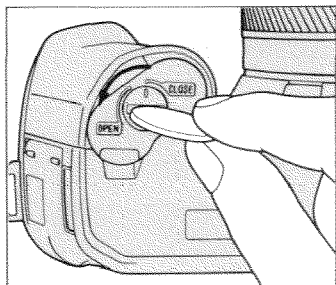

The Maxxum 7000i uses a 6-volt 2CR5 lithium battery. This battery supplies power for all camera operations, including film winding, autofocusing, and exposure control.

### Loading The Battery

1. With main switch at LOCK position, use a coin or similar object to turn the battery-cover lock to OPEN position. Remove battery cover from camera.

2. Wipe battery terminals with a dry cloth to ensure proper contact. Insert the lithium battery according to the marks in the battery compartment.

3. Replace battery cover and turn the battery-cover lock to CLOSE position to secure it.

## NOTE

- Read and follow all warnings and instructions supplied by the battery manufacturer.
- Keep battery away from young children.
- Do not attempt to disassemble, recharge, or short out the battery, or subject it to high temperatures or fire. The battery may explode and cause burns.

### Checking The Battery Condition

Each time you slide the main switch from LOCK to ON or **ON** position, the camera automatically checks the battery's condition:

Full-battery symbol appears for five seconds when power is sufficient.

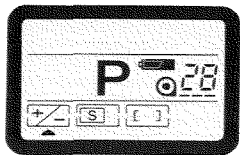

Low-battery symbol appears for five seconds: Power is getting low – keep a fresh battery handy.

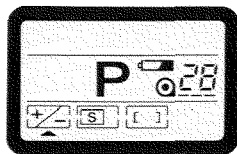

Low-battery symbol blinks: Camera can be operated, but the battery will need to be changed soon.

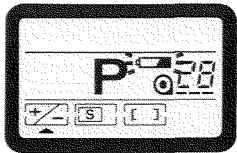

Blinking low-battery symbol appears alone or no indications appear: power is too low for normal operation — change battery immediately. (Note: in this case the shutter locks and the camera may also beep for one second as an additional low-battery signal.)

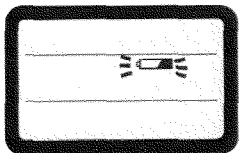

### **Cold-weather Operation**

Lithium batteries provide excellent performance in cold weather. However, if you plan to shoot many rolls of film outdoors at 32°F (0°C) or below, we recommend that you carry the camera inside your coat to keep it warm when you are not taking pictures. You may also wish to carry a spare battery in a warm pocket, so that you can change the battery, if necessary. In this case, do not discard a cold battery since its capacity may be restored when it warms up.

### **Battery Performance**

The 6-volt 2CR5 lithium battery should provide sufficient power for shooting up to 65 rolls of 24-exposure film, 50 rolls of 36-exposure film.

These figures are based on Minolta's standard test method using a fresh battery at 68°F (20°C). Actual battery performance will depend on how you use your camera.

## FILM INFORMATION

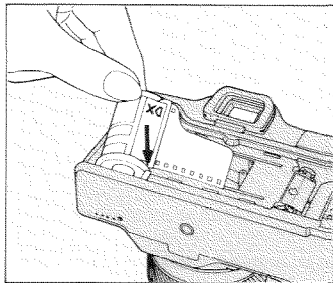
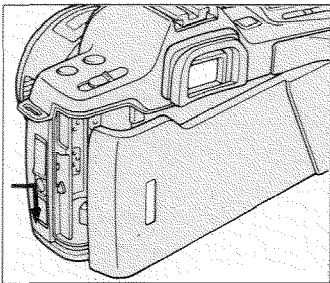
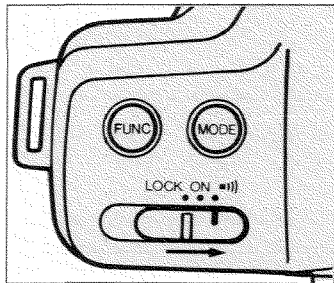

### Loading Film

1. Set the main switch to ON or  position.
2. Check the frame counter. When the frame counter shows "0" or if no number is displayed, it is safe to open the back cover.
  - The film window can also be used to check whether film is already loaded in the camera. Refer to page 17 if you want to rewind a partially exposed roll of film.

3. Open the back cover by pressing the button in the center of the back-cover release and sliding the release downward.
  - Always load film in subdued light or at least shaded from direct sunlight.
  - When you load film for the first time, remove and discard the protective plastic cover which is attached to the pressure plate.
4. Place film cartridge in film chamber as shown here.



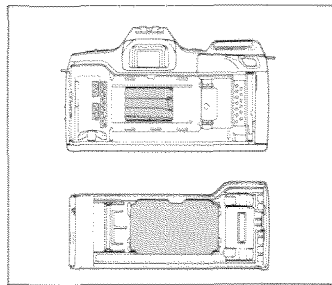
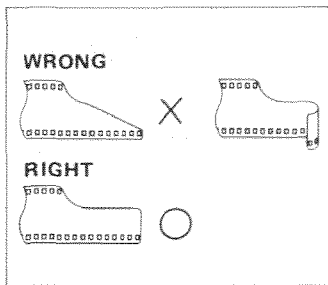
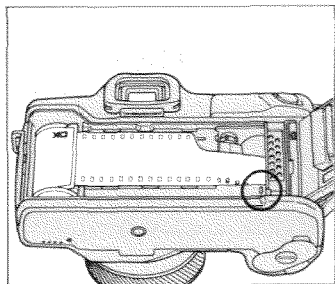

5. Extend the tip of the film past the red mark. Make sure the holes in the lower edge of the film engage the teeth on the sprocket.

- If the film extends too far or does not lie flat, gently push the excess film back into the cartridge.

- Make sure the tip of the film is shaped correctly. Otherwise, the film may not wind properly.

- Do not touch any parts or areas shown in blue.

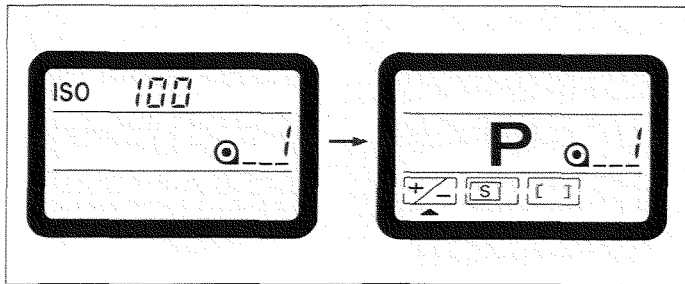
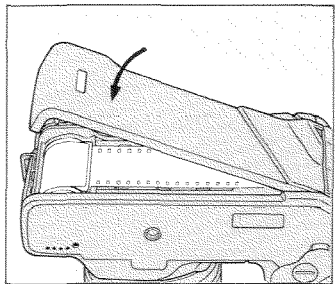

6. Close the back cover and make sure it snaps shut. The camera will automatically wind the film to the first frame. When the film is loaded correctly, the number "1" appears in the frame counter. If you are using DX-coded film, the film speed is set automatically and displayed for 5 seconds. You are now ready to start taking pictures.

- If the film is not loaded correctly, the frame number and film-transport signals "0\_0" will blink, the camera will beep for one second and the shutter cannot be released. Repeat steps 3 through 6.

## Automatic Setting Of The Film Speed

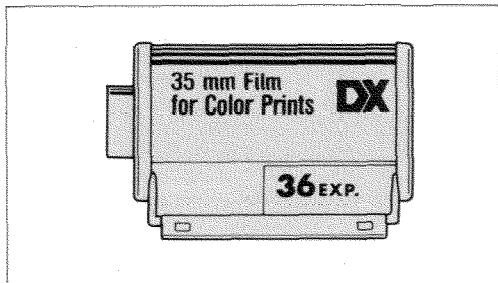

If you are using a DX-coded film, the camera sets the film speed automatically. The film-speed setting is displayed in the data panel for five seconds after the film is loaded.

- All DX-coded films have "DX" printed on their film cartridges and film boxes.

## Manual Setting Of The Film Speed

If you are not using DX-coded film (i.e., "DX" is not printed on the cartridge and film box), you must manually set the correct ISO film speed. When desired, you can override the DX-coded film speed and reset the film speed to a higher or lower value. The film speed can be set from ISO 25 to ISO 6400. To set the film speed manually, see next page.

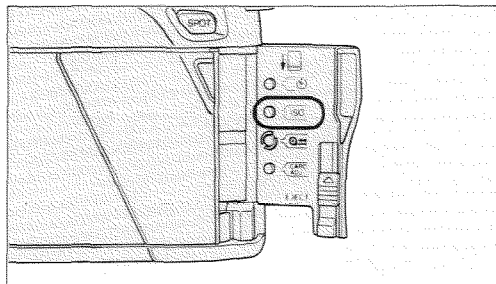

**To set the film speed manually:**

1. Open the card door on the right side of the camera.
2. Press the film-speed (  ) button. Lift your finger from the button. The current film-speed setting will be displayed in the data panel next to the "ISO" symbol.

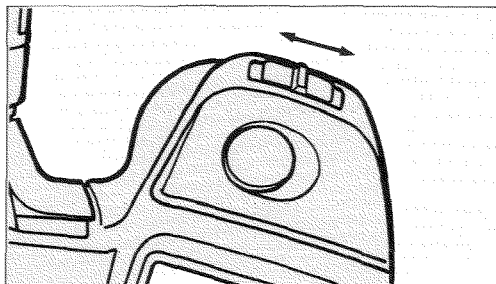

3. Move the up/down control to the left to set a lower film speed and to the right to set a higher film speed.
  - Each time you move the up/down control, the film speed changes by 1/3 of a stop. The speed changes rapidly if you hold the up/down control in either position.
4. After the desired film speed is set, press the shutter-release button lightly to return to the normal operating mode.
  - The normal display returns after 5 seconds.
  - You can check the film speed at any time by pressing the film-speed (  ) button.

## Automatic Film Rewind

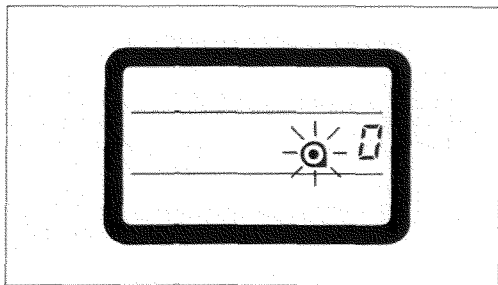

After the last frame is exposed, the camera automatically starts rewinding the film. When a fresh battery is loaded in the camera, it normally takes about ten seconds to rewind a 36-exposure film and about eight seconds for a 24-exposure film.

When the film is completely rewound, the rewind motor switches off automatically. The film-cartridge symbol blinks in the data panel to indicate that you can remove the film.

- The film leader will be wound all the way into the cartridge. If you want the film leader to be left out after the film is rewound, you can use the Customized Function Card to change this function. See page 61 for more details about this and other Creative Expansion Cards.
- If you accidentally open the camera's back cover before the film is rewound, close the back cover immediately and press the rewind button to finish rewinding the film. Light falling on the film will ruin many of the pictures; however, your quick action may save a few pictures.
- If it's necessary to change the battery before rewind is completed, press the rewind button to restart.

### Manual Start of Film Rewind

You can also rewind and remove a roll of film before the last exposure is taken. To start film rewinding, simply open the card door on the right side of the camera, and press the rewind () button.

# TAKING PICTURES

## TAKING PICTURES

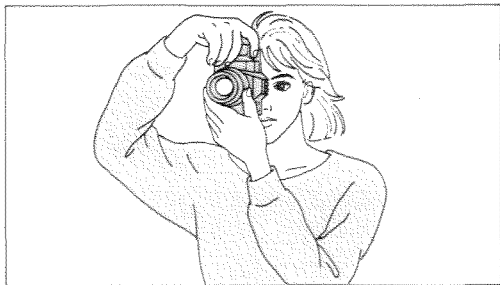

### Holding The Camera

This section explains the basic steps for using program exposure mode, autofocus, and single-frame film advance. Detailed information about each of the camera's functions begins on page 22.

To obtain sharp, blur-free photos, hold the camera as still as possible and steady it against your face or body. Press the shutter-release button gently with a slow, steady squeeze — never a quick jab.

Two recommended ways of holding the camera are shown here. If you grasp the camera firmly with your right hand on its handgrip, you can shift the camera back and forth for horizontal and vertical pictures without removing your hands from the controls. **When using autofocus, make sure you do not touch the lens' focusing ring.**

## Fully Automatic Operation

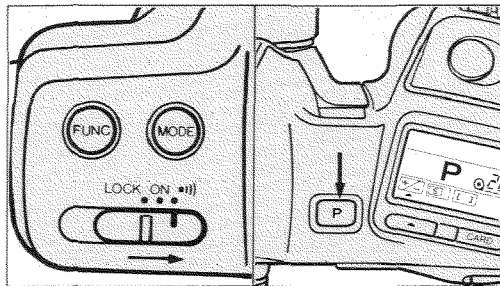

**1.** Slide the main switch to **•|||** position, then press the program-reset (P) button to set the camera for fully automatic operation.

● Whenever the program-reset button is pressed, the camera is set to program exposure mode, autofocus, single-frame film advance,  $\pm 0.0$  exposure adjustment, and wide focus area.

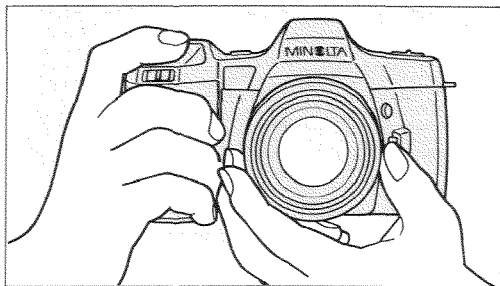

**2.** Hold the camera firmly in your right hand and support the lens with your left hand.

● Do not touch the lens' focusing ring, as this prevents the lens from focusing properly.

**3.** While looking through the eyepiece, center the focus frame on your subject and press the shutter-release button partway down. The camera will focus automatically, and the exposure settings will be displayed in the viewfinder and data panel.



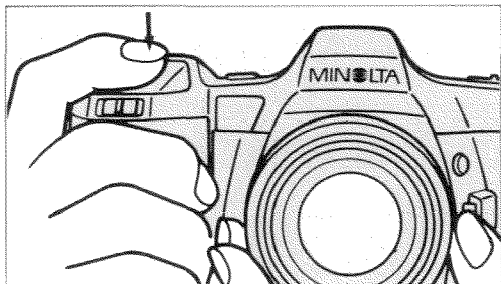

- A green focus signal in the viewfinder glows when the subject is in focus.
- If a red focus signal blinks, you should focus the lens manually or use focus hold (see page 27).
- If the camera beeps continuously, the shutter speed is too slow to ensure sharp pictures. Attach a flash unit or mount the camera on a tripod.



4. To take a picture, gently press the shutter-release button all the way down. Use a smooth, steady squeeze — never a quick jab which might shake the camera and cause a blurred picture.
- After the exposure is made, the film is automatically advanced to the next frame and the frame number increases by one.

# MAKING THE MOST OF YOUR CAMERA

Main Switch	23
Focusing	24
Film-advance Modes	33
Exposure Control	
Program mode	34
Aperture-priority mode	38
Shutter-priority mode	41
Manual mode	44

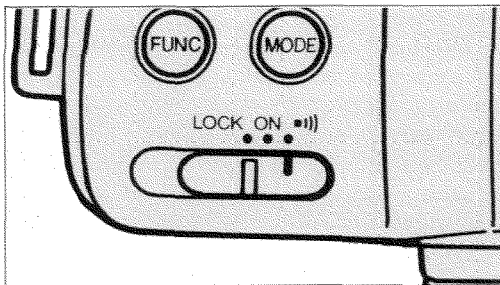

## MAIN SWITCH



The main switch has three positions: LOCK, ON, and . At ON and  positions, you can take pictures and all camera functions will operate. At LOCK position, all camera functions are switched off.

When the camera is not in use, we recommend setting the main switch to LOCK to prevent taking accidental exposures and ensure optimum battery life.

### Audible Signals

With the main switch at ON or  position, the camera beeps for one second to warn that the film has been loaded incorrectly. The camera will also beep if battery power becomes too low for continued operation. This signal will occur when the main switch is moved from LOCK to ON or  position.

With the main switch is at  position, the camera beeps when the subject comes into focus, when the shutter speed is too slow for taking hand-held pictures in program (P) or aperture-priority (A) mode, and when using the self-timer.

## FOCUSING SYSTEM



### Focus-area Selection

The Maxxum 7000i camera has three auto-focus sensors, a horizontal sensor in the center of the frame and vertical sensors on each side of the center sensor. When the camera is set to "wide" focus area, all three sensors are used to determine correct focus. When the "center" focus area is selected, only the horizontal sensor is used.

### Wide Focus Area

The wide focus area is set automatically by the camera when you load a battery or when you press the program reset (P) button. This is the camera's normal setting, and it is ideal for most situations, especially when taking pictures of fast-moving subjects. Even if the main subject is not in the exact center of the frame, the camera will focus correctly.

### Center Focus Area

If the camera is set to wide focus area, it may be difficult to focus on one person standing in a crowd, since more than one subject will fill the focus area. By selecting the center focus area, you can limit the focus area to the small area marked in the center of the viewfinder. The center focus area is also useful when you are taking close-up photographs.

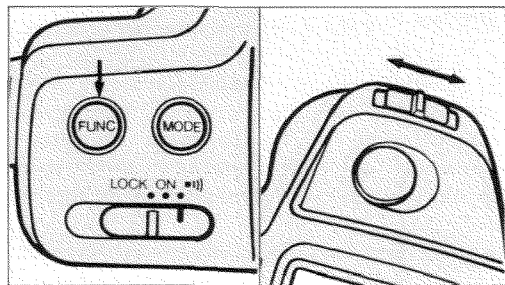
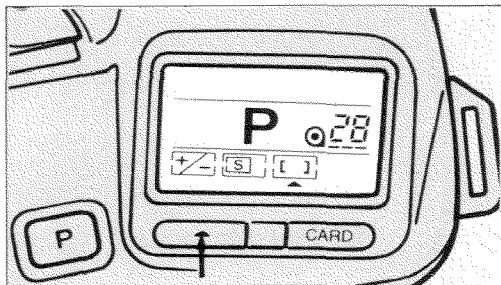

### To select the focus area:

1. Press the function-selector (↔) key to move the function pointer under the focus area indicator.
2. Hold down the function-adjustment (FUNC) button and move the up/down control in either direction to select center (⌂) or wide (⌂) focus area.

- Both focus-area settings can be used with autofocus and manual focus.
- An indication in the viewfinder appears when center focus area is selected.
- To quickly reset the wide focus area, you can press the program reset (P) button. This will also set the camera to program mode, autofocus, single-frame advance, and +/-0.0 exposure adjustment.

## Autofocusing

Autofocus is the camera's "normal" focus mode. It is automatically set when you load the battery or press the program reset (P) button. The Maxxum 7000i has a built-in AF illuminator that is triggered automatically to permit autofocusing in case of low subject contrast or low light. In total darkness the Maxxum 7000i can focus on subjects up to 30 feet (9 meters) away.

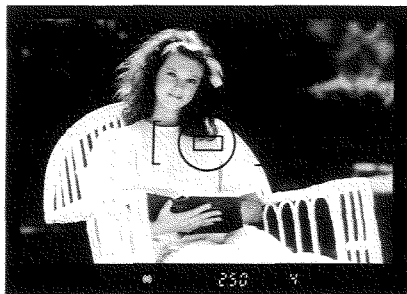

## Focusing On Still Subjects

1. Center the focus frame on the subject.
2. Press the shutter-release button partway down to focus the lens.

- The green focus signal will glow when the subject is in focus.
- If the main switch is set to  $\bullet \text{||}$ , the camera will also beep when the subject comes into focus.
- 3. Press the shutter-release button all the way down to take the picture.
- The shutter can only be released when the green focus signal glows.

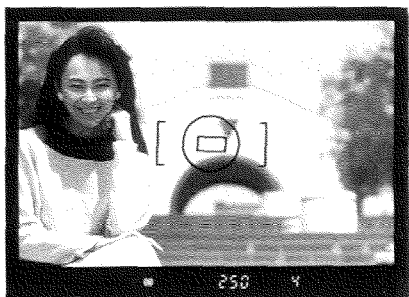

### Focus Hold

With still (non-moving) subjects, the focus remains locked on the subject as long as you keep the shutter-release button pressed partway down. If you want to take a picture with the subject at the edge of the frame, first lock the focus on your subject, then recompose the picture and press the button all the way down to take the picture.

When you use focus hold, the camera automatically locks the exposure reading for the subject on which you have focused. You do not have to adjust the exposure after recomposing the picture. A basic explanation of the metering system begins on page 48.

If when you recompose the picture another subject at a closer distance than your main subject enters the autofocus zone, focus may not be locked.

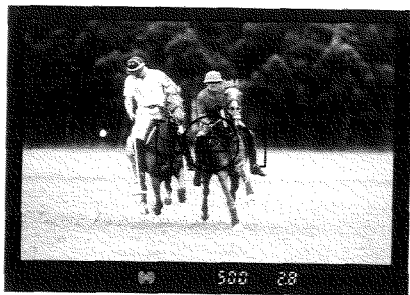
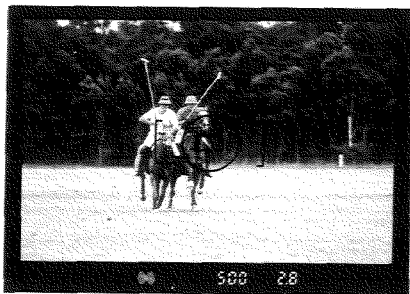

### Continuous Autofocusing

The Maxxum 7000i automatically detects when the subject is in motion and adjusts focus continuously. To focus on moving subjects:

1. Center the focus frame in the viewfinder on your subject.
2. Press the shutter-release button partway down. The camera continually adjusts the focus as your subject moves.
3. To take a picture, press the shutter-release button all the way down.



- The shutter can only be released when the subject is in focus.
- If you are using continuous film advance mode, you can take a series of pictures by holding the shutter-release button down. The camera will automatically advance the film after each exposure, then readjust the focus before the next exposure is taken.

### Autofocus Signals

Camera is focused on a moving subject. Focus will continue to be adjusted as the subject moves. Shutter can be released.



Focus is locked on a non-moving subject. You can recompose the picture and the focus will be held. Shutter can be released.

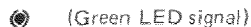

Subject is moving too fast for autofocusing. Shutter cannot be released.

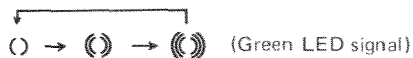

Autofocus is not possible due to very low contrast, low light, or because the subject is too close. Shutter cannot be released. Set camera to manual focus mode and turn lens' focusing ring until subject appears sharp in the viewfinder.



## Manual Focusing

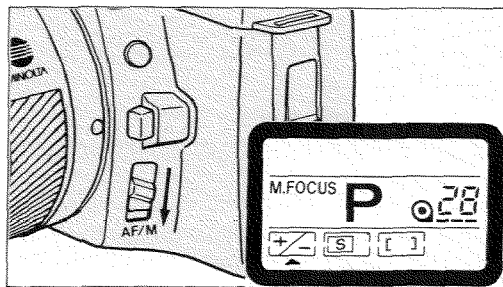

1. Slide the focus-mode (AF/M) switch downward to set the camera to manual focus mode. "M.FOCUS" will appear in the data panel. Sliding the switch again will reset the camera to autofocus mode.
2. Center the focus frame on the subject.
3. Press the shutter-release button slightly to activate the focus signals.

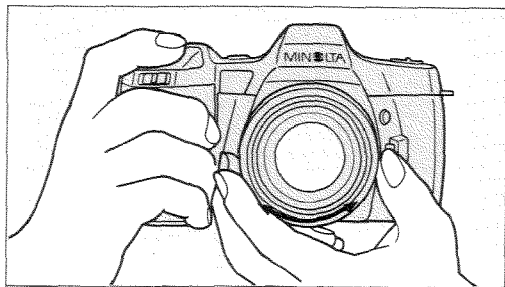

4. Turn the lens' focusing ring until the green focus signal glows and the subject appears sharp in the viewfinder. If the main switch is set to  position, the camera will emit a short beep when the subject comes into focus.

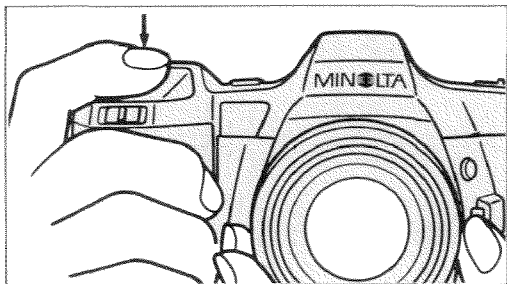

5. Press the shutter-release button all the way down to take the picture.

- When using manual focus, the shutter can be released at any time, even if the subject is not in focus.
- When you use manual focus mode, the exposure is based on center-weighted metering. For more information about the metering system, refer to page 48.

### Manual Focus Signals

Subject in focus.

- (Green LED signal)

Focus cannot be confirmed by camera. Turn focusing ring until subject appears sharp in viewfinder.

- ⚡●⚡ (Blinking red LED signal)

## Focusing In Special Situations

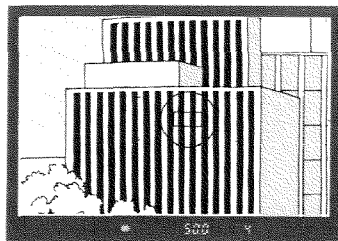
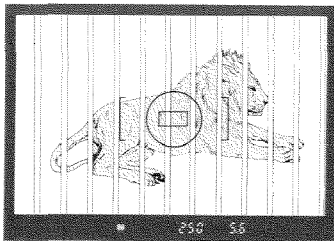
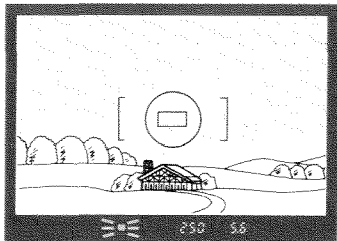

**A** The camera's autofocus system enables taking sharply focused pictures in nearly any situation. Listed here are four situations when you may need to take extra steps to ensure sharp focus.

- If subject contrast is too low (A), focus manually until subject appears sharp in viewfinder.

**B**

- For extremely bright subjects, use of a neutral-density filter is recommended.
- In cases where two subjects are at different distances within the focus frame (B) or it the subject has alternating lines within the focus frame (C), focus manually until subject appears sharp in viewfinder.

**C**

## FILM-ADVANCE MODES

The Maxxum 7000i features two film-advance modes. In single-frame mode, the film is advanced one frame after each exposure. In continuous mode, film is advanced continuously at up to 3 frames per second. In continuous mode, focus is automatically adjusted between exposures to ensure sharp pictures.

When you are using autofocus in either film-advance mode, the shutter can only be released when the subject is in focus. If you press the shutter-release button all the way down before the subject is in focus, the shutter will be released after the subject is focused.

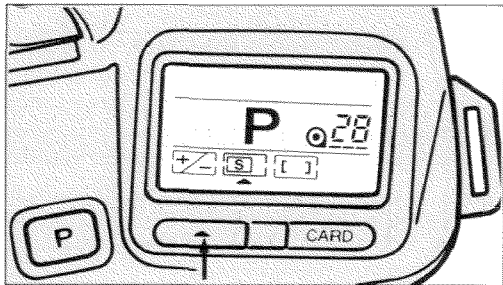

### To select the film advance mode:

1. Press the function-selector ( $\wedge$ ) key to move the function pointer under the film-advance mode symbol in the data panel.
2. Hold down the function-adjustment (FUNC) button and use the up/down control to select between single-frame ( $\boxed{S}$ ) and continuous ( $\boxed{[]}$ ) modes.

## EXPOSURE CONTROL

### Program Mode

Program mode is designed as the Maxxum 7000i's main exposure mode. Whenever the camera is set to program mode, a large letter "P" appears in the data panel.

Program mode is ideal for general photography. In this mode, you just aim the camera and press the shutter-release button to take a picture. The camera automatically sets the correct exposure, no manual settings are required.

### Program Reset Button

Whenever you want to use program mode, simply press the program-reset (P) button. Doing so sets the camera to program mode, autofocus mode, single-frame advance mode, wide focus area, and  $\pm 0.0$  exposure adjustment.

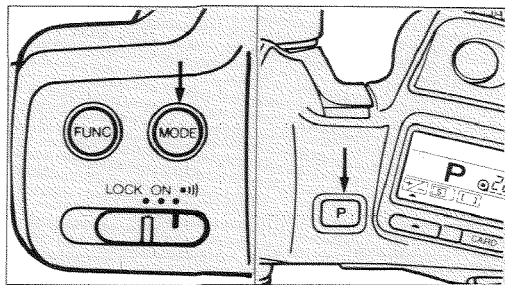

- You can also switch from A, S, or M mode to program mode by holding down the exposure-mode (MODE) button and pressing the program reset (P) button. Only the exposure mode will be change; no other camera settings will be affected.

## Automatic Multi-program Selection

The Maxxum 7000i automatically selects the exposure program that is best suited to the lens in use. Program selection is completely automatic, so no manual settings are required. With a Maxxum AF lens attached, the camera instantly selects the programmed shutter speed and aperture combination that will provide optimum results. Each program is designed to select a shutter speed that is fast enough to minimize blur caused by camera shake.

When using a Maxxum AF zoom lens, exposure program is continuously adjusted as you zoom the lens. Thus if you turn the zoom ring, you will notice that the shutter speed and aperture settings change.

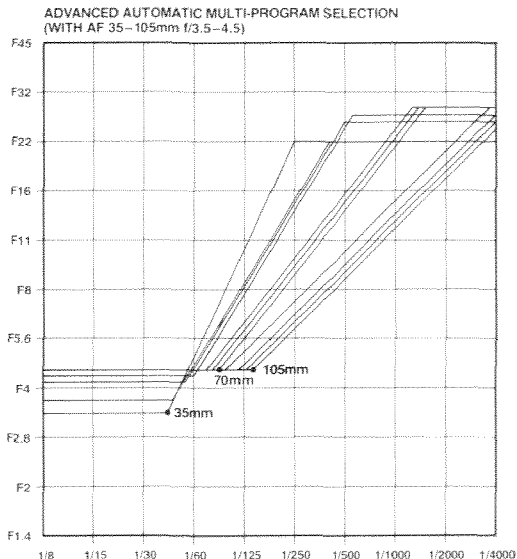

## Program Shift

Program shift lets you select other aperture-shutter combinations without changing the exposure. The program can be shifted in half-stop increments. Sliding the up/down control to the left selects slower shutter speeds with smaller apertures. A shift in this direction might be used to create a heightened sense of subject movement if the camera is panned during exposure. Sliding the up/down control to the right would shift the exposure towards faster shutter speeds and wide apertures.

## NOTE

- Shifted settings are held for five seconds, after you lift your finger from the shutter-release button (when the meter switches off). To take several pictures using program shift, keep your finger on shutter-release button.
- When using zoom lenses, shift the program after zooming. If you change the focal length, the shifted settings will also change.
- When the lighting is too bright or too dark to ensure correct exposure, the metering indicators (► ◄) blink in the viewfinder. In low light, use a Maxxum Flash unit (see pages 54 and 63).



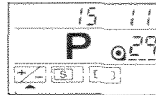
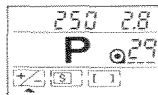
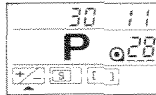
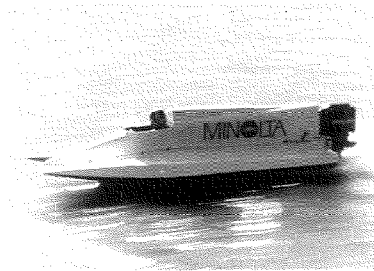
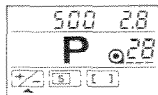
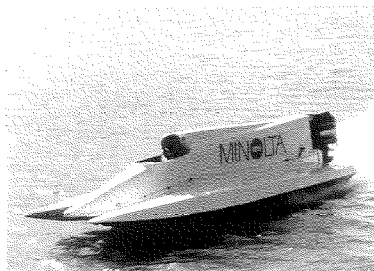

## Aperture-priority Mode

In aperture-priority (A) mode, you can set the aperture to control sharpness in the picture and the camera automatically sets the shutter speed required for correct exposure.

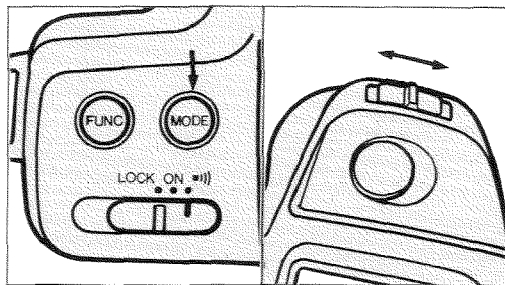

### To select A-mode:

Hold down the exposure-mode (MODE) button, and slide the up/down control in either direction until "A" is displayed in the data panel. The pointer next to the aperture indicates that it can be set manually.

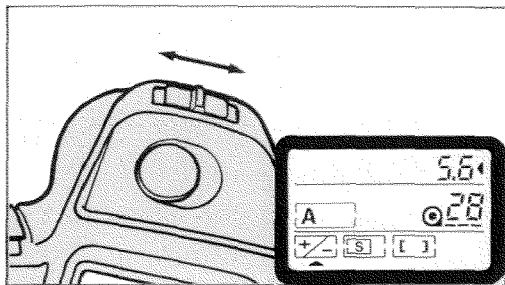

#### To set the aperture:

The aperture is displayed whenever the camera's main switch is at ON or  $\bullet$  position. Move the up/down control to the right to set smaller aperture numbers and to the left to set larger aperture numbers. Each time you move the up/down control, the aperture changes by 1/2 stop. The aperture changes rapidly when you hold the up/down control at either position.

You can set any available aperture from the aperture range indicated on the front of the AF lens you are using. For example, the AF 50mm/1.7 lens is marked 1:1.7 (22), thus the aperture range is f/1.7 to f/22.

#### NOTE

- Shutter speed blinks when the required speed is not available. If "4000" blinks, set a smaller aperture until blinking stops. If "30" blinks, set a larger aperture until blinking stops.
- When the lighting is too bright or too dark to ensure correct exposure, the metering indicators ( $\blacktriangleright$   $\blacktriangleleft$ ) blink in the viewfinder. In low light, use a Maxxum Flash unit (see pages 54 and 63).

## Creative Aperture Control

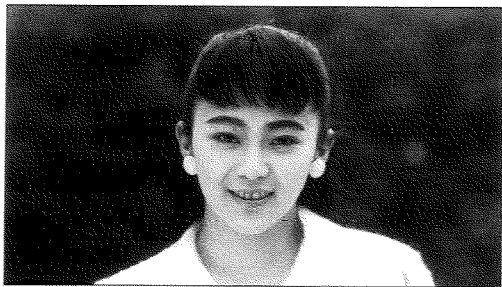

**Large aperture**

The aperture that you select determines how much of the picture will be in sharp focus. Aperture settings are also expressed as "f/numbers". Apertures such as  $f/2$  and  $f/2.8$ , for example, are used to get just a small area of the picture in sharp focus. You can select small aperture numbers when you want to isolate a subject from its background, such as when taking a portrait.

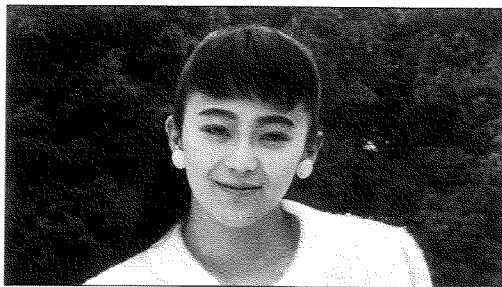

**Small aperture**

Apertures such as  $f/16$  and  $f/22$  are used when you want to make sure that a large part of the picture is in sharp focus. The larger the aperture number, the more of the scene that will be in focus. This technique is useful when you are taking pictures of large groups or landscapes and want most of the picture in sharp focus.

## Shutter-priority Mode

Shutter-priority (S) mode is most useful when you are taking pictures of moving subjects. You can use fast shutter speeds, up to 1/4000 of a second to “freeze” action, or slow speeds to intentionally blur the subject’s movement. The camera will automatically set the aperture and display it to the nearest half-stop.

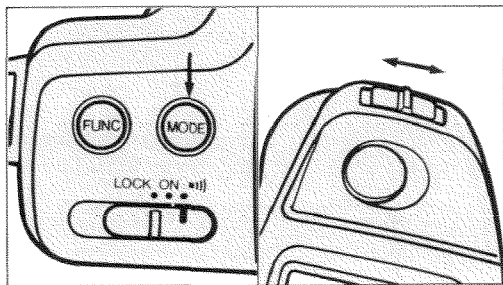

### To select S-mode:

Hold down the exposure-mode (MODE) button, and slide the up/down control in either direction until “S” is displayed in data panel. The pointer next to the shutter speed indicates that it can be set manually.

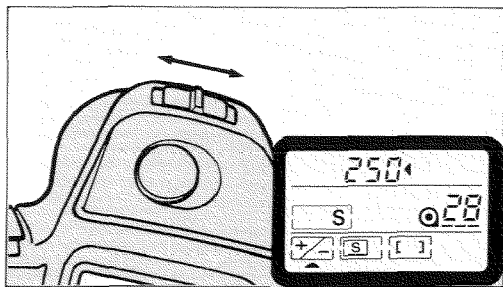

#### To set the shutter speed:

The shutter speed is displayed whenever the camera's main switch is at ON or  $\blacksquare$  position. The shutter speed can be set from 1/4000 of a second to 30 seconds. Move the up/down control to the left to set slower shutter speeds and to the right to set faster shutter speeds. Each time you move the up/down control, the speed changes by one stop. The speed changes rapidly when you hold the up/down control at either position.

#### NOTE

- If the smallest aperture available blinks, set a faster shutter speed until the blinking stops. If the largest aperture available blinks, set a slower shutter until blinking stops.
- When the lighting is too bright or too dark to ensure correct exposure, the metering indicators (► ◄) blink in the viewfinder. In low light, use a Maxxum Flash unit (see pages 54 and 63).
- Even though "bulb" setting (for long exposures) can be selected in "S" mode, this setting cannot be used. Long exposures can only be taken in manual (M) mode. See page 58 for more information.

## Creative Shutter-speed Control



**Slow Shutter Speed**

Your choice of shutter speeds affects how moving subjects will appear in the picture. Slow shutter speeds, such as  $1/30$  or  $1/15$  of a second, will make moving subjects appear to flow.



**Fast Shutter Speed**

Fast shutter speeds, such as  $1/500$  or  $1/1000$  of a second, can be used to freeze the action of a moving subject. When using telephoto lenses, fast shutter speeds should be set to prevent image blur caused by camera shake.

## Manual Mode

Manual (M) mode can be used when you want full creative control of exposure. In this mode, you can set the aperture to control sharpness (see page 40) and shutter speed to control the subject's motion (page 43). Indications in the viewfinder make it easy to set the camera for correct exposure. If desired, you can also vary the exposure based on your own experience.

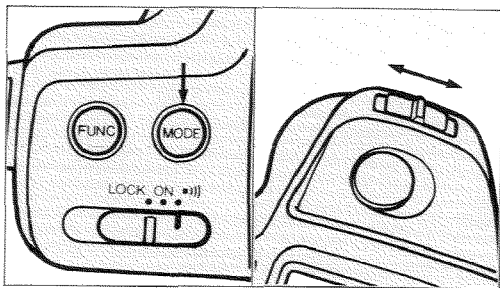

### To select M-mode:

Hold down the exposure-mode (MODE) button, and slide the up/down control in either direction until "M" is displayed in the data panel. The pointers next to the shutter speed and aperture indicate that both can be set manually.



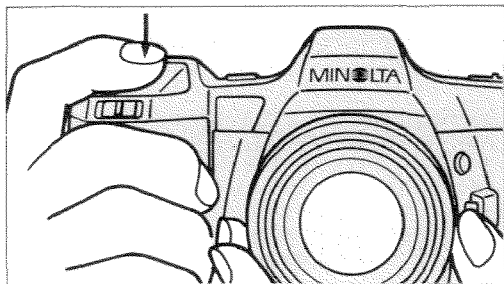

**To set the correct exposure:**

1. If you are using autofocus, press the shutter-release button partway down to focus on your subject.

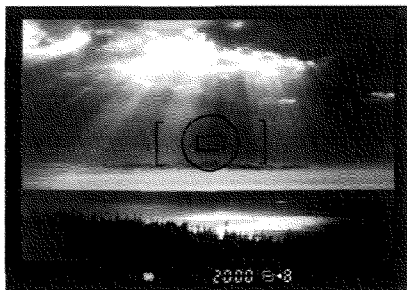

2. Hold the shutter-release button partway down to keep the meter switched on.

- The metering indicators will appear between the shutter speed and aperture settings in the viewfinder.
- Spot metering (by pressing the SPOT button) can be used to determine the exposure for a single, important area of the picture.

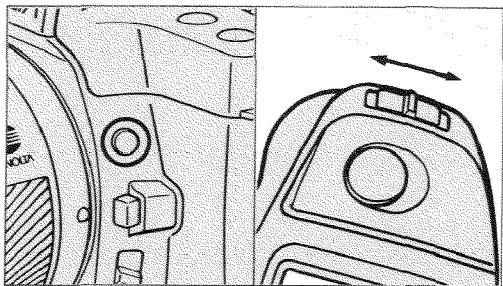

3. To change the shutter speed, slide the up/down control to the left for slower speeds, and to the right for faster speeds.

To change the aperture, hold in the aperture setting button and slide the up/down control to the left for larger aperture numbers or to the right for smaller aperture numbers.

## Metering Indications

Exposure is set correctly.



Slide up/down control to right.



Slide up/down control to left.



If both pointers blink, the light level is beyond the meter's range; correct exposure cannot be determined.



- The  $\ominus$  and  $\oplus$  symbols indicate whether the picture will be underexposed ( $\ominus$ ) or overexposed ( $\oplus$ ) if displayed shutter speed and aperture are used.

## Aperture And Shutter-speed Settings

1.7  
2  
2.4  
2.8  
3.5  
4  
4.5  
5.6  
6.7  
8  
9.5  
11  
13  
16  
19  
22

### Aperture Settings

The column at the left shows the aperture settings (also called f/stops) that appear or can be selected in each exposure mode when using the AF 50mm f/1.7 lens. Numbers such as 6.7 and 9.5 are "half-stop" settings between the standard apertures. For example, the half-stop setting between f/8 and f/11 is f/9.5.

### Shutter-speeds Settings

The first column on the right shows the standard shutter speeds that are either set automatically in (P) and (A) modes or can be set manually in (S) and (M) modes.

The second column shows the half-stop shutter speeds that are set automatically in (P) and (A) modes. Numbers such as 750 and 350 are the half-stop settings between the standard shutter speeds. For example, the half-stop setting between 1/1000 sec. and 1/500 sec. is 1/750 sec.

NOTE: The "bulb" setting should only be used in (M) mode.

4000 — 3000  
2000 — 1500  
1000 — 750  
500 — 350  
250 — 180  
125 — 90  
60 — 45  
30 — 20  
15 — 10  
8 — 6  
4 — 3  
2 — 0"7  
1" — 1"5  
2" — 3"  
4" — 6"  
8" — 12"  
15" — 22"  
30"  
bulb

## Metering Systems

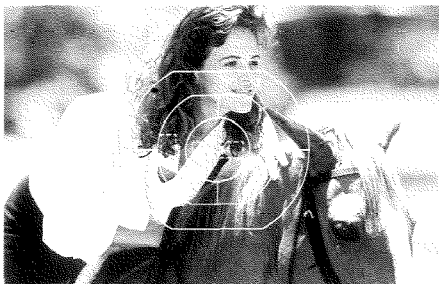

### AF-integrated Multi-pattern Metering

The Maxxum 7000i uses an "intelligent" metering system that is coupled to the camera's autofocus system. The moment your subject is brought into focus, the exposure for the subject is measured and locked. As long as you maintain pressure on the shutter-release button, you can recompose the picture and the exposure will still be correct.

The camera's six-segment metering cell automatically adjusts its sensitivity for the difference in brightness between your subject and the background. Even if your subject is spotlit or backlit, the correct exposure is calculated automatically.

### Center-weighted Metering

When the camera is set to manual focus mode, the metering automatically switches to center-weighted metering. In contrasty lighting, such as with backlit or spotlit subjects that are off center, you may want to use the spot-metering button to lock the exposure reading on your main subject.

An explanation of spot metering begins on the following page.

## Spot Metering

The spot-metering (SPOT) button is used to measure and lock the exposure for a small area of the picture. This enables you to obtain proper exposure in contrasty lighting. The spot-metering button can be used in all four exposure modes and with autofocusing and manual focusing.

When using manual focus, you can use spot metering to lock the exposure on your subject and then recompose the picture so your subject is on the edge of the frame. As long as the button is kept pressed, the exposure is locked.

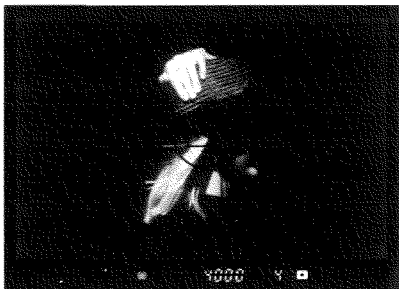

### To use the spot-metering button:

1. Focus the camera on your main subject.
  - Autofocus or manual focus can be used.
2. Aim the camera so that the area you wish to measure fills the circle in the viewfinder.

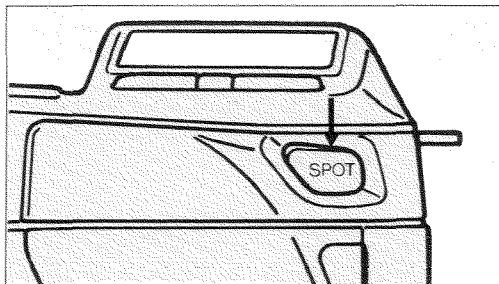

3. Press and hold the spot-metering button.
4. In program (P), aperture-priority (A), or shutter-priority (S) modes, keep the spot-metering button pressed until you release the shutter. In manual (M) mode, keep the spot-metering button pressed while you are setting the correct exposure. After you have set the exposure, you can release the button.

- If you are using a Maxxum Flash unit and the camera is set to program (P) or aperture-priority (A) mode, you can press the spot-metering button to set a slower shutter speed. Use of slow-shutter sync is explained in Maxxum Flash unit's instruction manual.

## Exposure Adjustment

The exposure-adjustment function can be used to deliberately give more or less exposure from the normal metered value. This technique is called exposure bracketing, and it is useful when shooting color-slide film. You can take several pictures of the subject and vary the exposure slightly to ensure that one of them is exposed precisely the way you want.

Exposure adjustment can also be used for flash exposures with the Maxxum Flash kits.



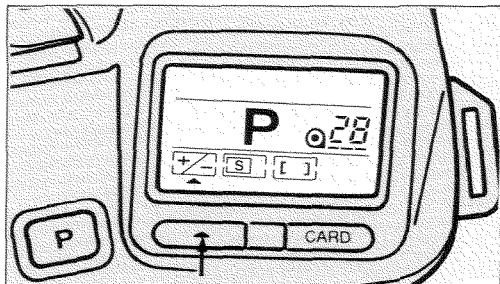

**To set the exposure adjustment:**

1. Press the function-selector ( $\leftarrow$ ) key to move the function pointer under the exposure-adjustment reminder.
2. Hold down the function-adjustment (FUNC) button and move the up/down control to the right to set plus (+) values for more exposure or to the left to set minus (-) values for less exposure.

- The adjustment range is from +4 to -4 stops in half-stop increments.
- Whenever exposure adjustment is set, “ $\oplus$ ” or “ $\ominus$ ” reminder appears in the viewfinder and data panel.
- The adjusted value can be checked at any time by pressing the function-adjustment key when the function pointer is below the exposure-adjustment reminder.
- Reset the exposure-adjustment value to “+/-0.0” after you are done. Otherwise, subsequent pictures may not be exposed properly.



# FLASH INFORMATION

## FLASH INFORMATION



The Maxxum 7000i uses an advanced flash control system for correct flash exposures anytime—in daylight, low light or total darkness.

In all flash modes, the camera's TTL (through-the-lens) flash metering system controls the flash output to ensure proper flash exposure.

When using a dedicated flash unit, such as the Maxxum Flash 3200i, two flash signals appear in the viewfinder. The flash-on signal appears whenever the flash unit is switched on. In program (P) mode, the Maxxum 7000i automatically activates and fires the 3200i when the light level is very low or if fill flash is required. A special fill-flash program lightens shadows without washing out highlight details and controls background exposure in brighter conditions. The flash-ready signal blinks slowly when the flash is charged. After you take a flash picture, the flash-ready signal blinks rapidly to confirm that the exposure was sufficient.

For complete information about using a Maxxum Flash unit, refer to the flash unit's instruction manual.

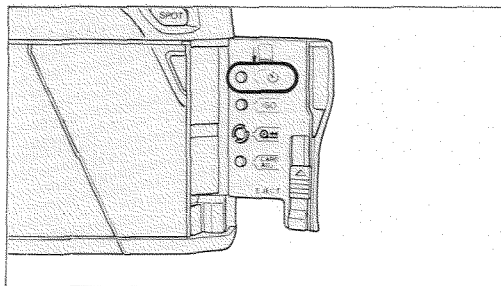

# OTHER FUNCTIONS

## Self-timer Operation



The Maxxum 7000i's electronic self-timer lets you delay shutter release for ten seconds.

### To use the self-timer:

1. Open the card door on the right side of the camera.
2. Press the self-timer (  ) button. The self-timer symbol (  ) will appear in the data panel.
  - Pressing the button again will switch off the self-timer.

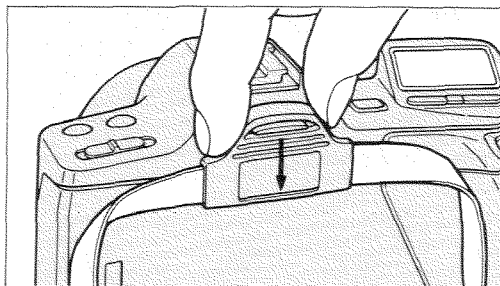

3. Focus the lens and attach the eyepiece cap.

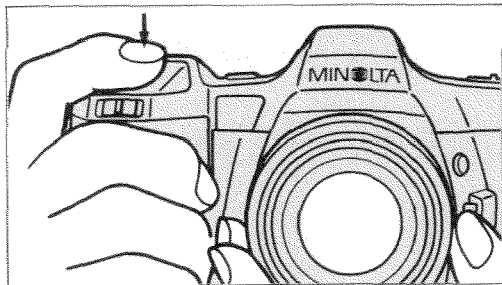

4. Press the shutter-release button all the way down to start the self-timer.

- A red light on the front of the camera will blink twice a second for 10 seconds until the shutter releases. The camera will beep twice a second if the main switch is at **•|||** setting.
- The self-timer is automatically switched off after the exposure. Repeat steps 1-4 to make another exposure using the self-timer.

#### **To stop the self-timer:**

If you have started the self-timer and want to stop it before the shutter releases, move main switch to LOCK and then back to ON or **•|||** position. You can also press the program reset button to cancel the self-timer function.

## Long Exposures

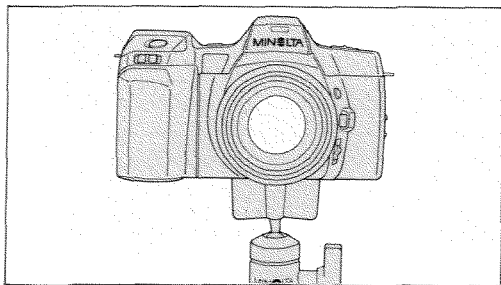

When you want to make exposures longer than 30 seconds, the “bulb” setting can be used. Long exposures can be made when you want to take pictures of fireworks, lightning storms, city skylines after sunset, etc.

### To make long exposures:

1. Mount the camera on a tripod.
  - When you attach the camera to the tripod, do not overtighten the tripod’s mounting screw. Also, make sure that mounting screw is not longer than 1/4 in. (5.4mm).

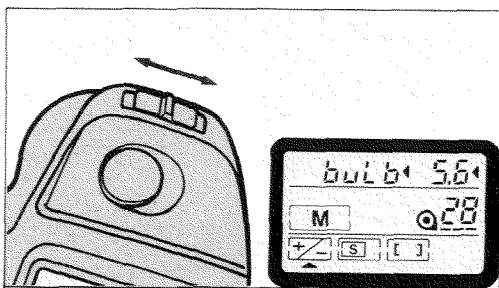

2. Set camera to manual (M) mode, then hold the up/down control to the left until “bulb” appears in the data panel and viewfinder.

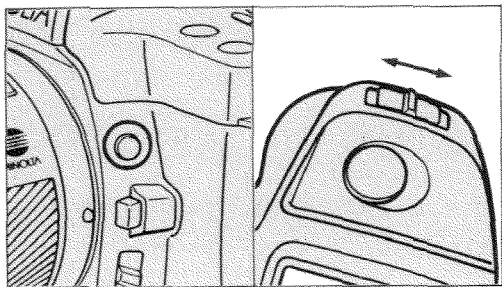

3. Set the aperture by holding in the aperture setting button and sliding the up/down control to the left or right.
4. Focus the lens. If it is too dark for autofocus, set the camera to manual-focus mode and turn the lens' focusing ring until the subject is sharp.
5. To take the picture, hold down the camera's shutter-release button for the desired amount of time.

- To avoid shaking the camera, we recommend that you use either the optional Remote Cord RC-1000S or RC-1000L. These cords have locking shutter-release buttons, so that you can leave the shutter open for extended periods of time.
- If the film does not advance after the exposure, the battery may be exhausted. In this case, set the main switch to LOCK, replace the battery, and set the main switch to ON or  position.

# ACCESSORIES



## Creative Expansion Cards

One of the Maxxum 7000i's most unique features is the system of Creative Expansion Cards that provide new ways to enjoy photography. These cards fit into the card door on the right side of the camera. The "CARD" symbol appears in the data panel whenever a card is in use.

The following Special Application Cards are available: Sports Action Card, Closeup Card, Depth Control Card, and Portrait Card. When using these cards, no manual settings are required.

Feature Cards let you add additional features to the camera. Currently available are the Exposure Bracketing Card, Highlight/Shadow Control Card, Program Shift Card, Fantasy Effect Card, and Data Memory Card.

The Customized Function card lets "personalize" your Maxxum 7000i to match your style of photography.

To learn more about the Creative Expansion Cards, visit your Minolta dealer.

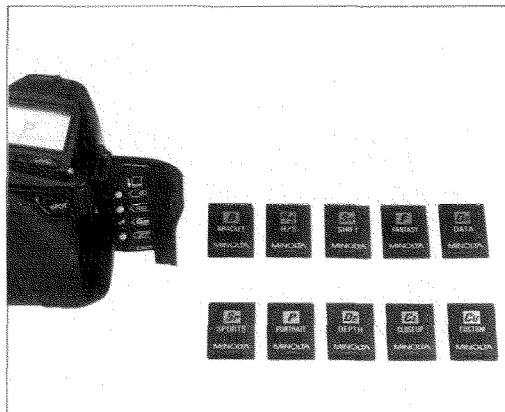

## Maxxum AF Lenses

More than 31 precision optics are available from Minolta for your Maxxum 7000i camera. Minolta offers the world's largest and most versatile system of autofocus lenses. Besides the newly designed, ultra-compact AF 35-80mm, 35-105mm, 70-210mm, AF 80-200 mm, and 100-300mm zoom lenses, a growing range of wideangle, standard, telephoto, zoom, and macro lenses are available. Your Minolta dealer has more information about the entire Maxxum AF lens system.



### **Maxxum Flash 3200i**

The Maxxum Flash 3200i is designed for fully automatic operation with your Maxxum 7000i camera. It attaches easily to the camera's accessory shoe.

This powerful unit features a maximum guide number of 105 (in feet at ISO 100). It also has a built-in zoom that automatically adjusts flash coverage for 28mm through 85mm lenses. Coverage is adjusted continuously when using zoom lenses. An advanced flash-charging system provides fast recycling, and automatic power-off circuitry helps conserve battery power.

### **Other Maxxum Flash units**

The Flash Shoe Adapter FS-1100 must be used to attach the Maxxum Flash 4000AF, 2800AF, 1800AF, or Macro Flash 1200AF to the Maxxum 7000i. TTL off-the-film flash metering controls exposure with all of these units. The instructions supplied with the Flash Shoe Adapter FS-1100 explain more about using these units with the Maxxum 7000i.



The AF illuminators in the 4000AF, 2800AF, and 1800AF do not operate when used with the Maxxum 7000i. However, the camera's built-in AF illuminator provides autofocusing of subjects from 3.2 to 30 feet (1 to 9 meters) with 50mm lens, based on Minolta's standard test method.

If you want to use Control Grip CG-1000 Set, attach Program Flash 4000AF, 2800AF or Macro Flash 1200AF. Control Grip CG-1000 Set cannot be used with Program Flash 3200i.

### Macro Flash 1200AF Set-N

The Macro Flash 1200AF Set is a specially designed flash unit that attaches to the Maxxum 7000i via the Flash Shoe Adapter FS-1100. This unit has four flash tubes that can be controlled separately for versatile lighting control. Four focusing lamps provide additional illumination for focusing, and TTL flash metering ensures accurate exposure at closeup/macro distances.

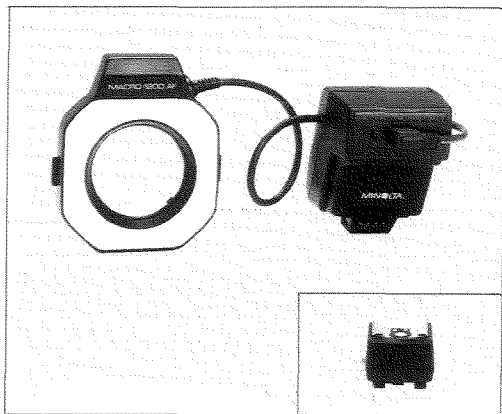

## Accessory Backs

The Data Back DB-7 enables imprinting of the year/month/day in any of three orders, day with 24-hour time, or time with indications for a.m and p.m. A single 3-volt lithium battery is installed at the factory and supplies power for data imprinting and for the automatic calendar and clock.

The Program Back PB-7 can be used to imprint the date, day with 24-hour time, consecutive numbers or fixed numbers. An intervalometer function allows you to take pictures at preset intervals and make timed long-exposures. For maximum versatility, the data imprinting, intervalometer, and long-exposure functions can be used together.

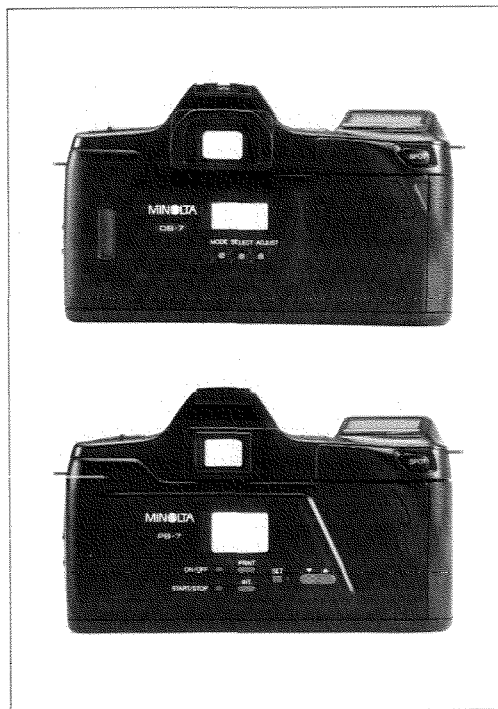

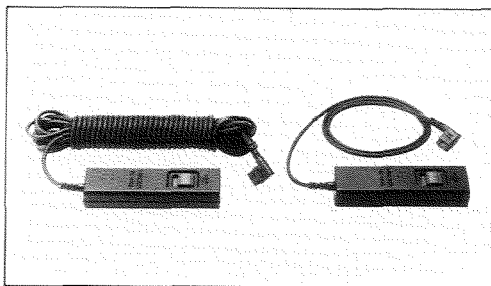

### **Remote Cord RC-1000L and RC-1000S**

A Remote Cord should be used for taking long exposures (at “bulb” setting) or anytime you want prevent shaking the camera during shutter release. Autofocusing and metering are both activated by pressing the cord’s release button. Pressing and sliding the release button locks the shutter open for long exposures. RC-1000L is 16.5 ft. (5m) long and RC-1000S is approximately 20 in. (50cm) long.



### **Wireless Controller IR-IN Set**

The Wireless Controller IR-IN Set enables cordless, remote-control photography up to approximately 200 feet (60 meters) away. Single-frame and continuous film advance are both possible. Separate receivers can be used to control up to three cameras at the same time.

### **User-changeable Focusing Screen 7**

Besides the Maxxum 7000i's standard (Type G) Focusing Screen 7, two other screens are available. Tweezers are supplied with each screen to enable quick, simple replacement.

Type L screen has a grid pattern on a matte field. This screen is useful for general and architectural photography. Type S screen has vertical and horizontal scales on a matte field and is useful for macro-, micro-, and astro-photography. Wide/center focus areas and spot-metering area are marked on each screen.

### **Eyepiece Corrector 1000**

Nine eyepiece-correction lenses are available for dioptric adjustment of the eyepiece. These lenses can be purchased separately and range from  $-4$  to  $+3$  diopters. The lenses snap into the camera's eyepiece frame.

### **Filters**

Autofocusing can be done with these Minolta filters: L37 (UV), Y52 (yellow), GO (green), O56 (orange), R60 (red), 1B (sky-light), A12 (85), B12 (80B), ND4X (two-stop neutral density), Minolta Portrayer filters, and Minolta Polarizing (Circular) filters.

#### **Use Of Other Filters:**

When using filters other than those listed here, the autofocus system may not function as desired. For best results, we recommend that you either focus manually with the filter attached or attach the filter after autofocusing.

#### **Minolta Polarizing (Circular) Filter**

To reduce or eliminate reflections and glare from glass, water, or other non-metallic surfaces, Minolta's Polarizing (Circular) Filter should be used. If a regular polarizing filter is used, metering may not function properly.

## TROUBLESHOOTING GUIDE

PROBLEM	CAUSE	SOLUTION
No display in data panel when camera is switched to <b>ON</b>	Battery exhausted Battery not installed correctly	Install fresh battery Remove battery and install correctly
"- -" appears in data panel's aperture indicator	Lens not attached correctly Contacts on camera and/or lens are dirty	Attach lens so that it locks in place with a click Clean contacts with a dry cloth
<b>HELP</b> displayed in data panel	Winding motor problem	Remove battery, then install again
Autofocus does not work or lens does not focus when operating button is pressed	Camera set to manual focus Zooming grip positioned in macro range Lens not attached correctly Subject difficult to focus	Set to autofocus mode Move zooming grip back into zoom range Attach lens so that it locks in place with a click Focus manually



PROBLEM	CAUSE	SOLUTION
Camera can't be shifted out of Program (P) mode	Creative Expansion Card in use	Switch off with Card on/off key If Customized Function Card is being used, reset program
Single frame mode can't be selected  Flash doesn't fire or $\mathcal{P}$ signal doesn't appear	Exposure Bracketing Card or Automatic Program Shift Card in use  Flash's power switch at <b>OFF</b> position  Flash not attached correctly	Switch Card off then reset film-advance mode  Switch unit on  Attach unit so that it locks in place with a click
Focus is not adjusted when using flash	Distance to subject is too close or too far  Subject's reflectivity is too low for autofocusing	Check that subject is within flash range  Focus on another subject the same distance away as main subject
Card system does not function	Card not installed correctly	Install card correctly

## TECHNICAL DETAILS

**Type:** 35mm SLR with intelligent control of autofocus (AF), autoexposure (AE), and auto film transport systems

**Lens mount:** Minolta A-type, self-lubricating stainless-steel bayonet; accepts all Maxxum AF lenses

**Autofocus system:** Minolta's through-the-lens (TTL) phase-detection type with three charge-coupled device (CCD) sensors: two sensors positioned vertically, one sensor positioned horizontally; sensitivity range: EV 0 to 18 at ISO 100 in ambient light; wide or center focus area selectable; focus-priority shutter release; automatic determination of subject position when using wide focus area; automatic selection of continuous adjustment for moving subjects or "oneshot adjustment with focus hold for still subjects; automatically calculates focus adjustment required for

moving subjects up to instant of exposure; built-in AF illuminator triggered automatically in low light or low contrast, from 3.2 to 30ft. (1 to 9m) with 50mm lens, based on Minolta's standard test method in total darkness

**Manual focusing:** By referring to focus signals in viewfinder, or visually on Acute-Matte focusing screen

**Metering:** TTL multi-pattern metering coupled to autofocus system; exposure based on area of frame in which subject is focused; center-weighted metering when using manual focus mode; six-segment silicon photocell (SPC) on pentaprism for ambient light; second SPC at bottom of mirror box for TTL flash metering with dedicated flash units

**Auto-exposure (AE) range:** EV 0 to 20 with ISO 100 film and 50/1.4 lens (e.g., 2 sec at f/1.4 to 1/4000 sec. at f/16)

**Exposure modes:**

**Program AE:** Both shutter speed and aperture set according to program which is automatically selected and continuously adjusted according to lens focal length

**Shutter-priority AE:** Any speed from 1/4000 to 30 sec. selectable in full stops, camera sets aperture from range available on lens

**Aperture-priority AE:** Any available aperture selectable in half-stops, camera sets stepless shutter speed from 1/4000 to 30 sec.

**Manual:** Any speed and aperture combination usable: correct exposure and under-/over-exposure indicated in viewfinder, "bulb" setting for long exposures

**TTL flash metering:** Operates in all flash modes with dedicated units; shutter X-sync speed set automatically when flash-on signal appears in viewfinder; in P or A modes, pressing spot-metering button sets slower shutter speed (down to 30 sec.) to balance flash with ambient lighting

**Program AE:** Automatic setting of aperture and shutter speed between 1/125 and 1/20 sec. according to focal length of lens; flash fires automatically in low light or backlit situations

**Shutter-priority AE:** Same as Program AE mode

**Aperture-priority AE:** Shutter speed automatically set to 1/125 sec.; any available aperture usable

**Manual:** Any shutter speed 1/125sec. or slower and any available aperture usable; speed automatically reset to 1/125 sec. when flash-on signal appears if shutter speed is set manually to a higher speed

**Exposure controls:** Exposure adjustment V +4 to -4 in half-stops; AE lock is coupled to focus lock; spot-metering usable in all exposure modes; program shift in half-stops for temporary selection of other programmed aperture-shutter speed settings

**Shutter:** Electronically controlled vertical-traverse focal-plane type: Automatic speeds: In program and aperture-priority AE modes, stepless 1/4000 to 30 sec. with nearest half-stop setting displayed

Manual speeds: In shutter-priority AE and manual modes, 1/4000 to 30 sec. in full-stop settings; "bulb" in manual mode for long exposures

**Controls:** Buttons to set exposure mode film advance mode, exposure adjustment, wide or center focus area, and film speed, up/down control to change shutter speed and aperture settings and to control program shift; spot-metering button; program reset button sets camera to program mode, single-frame advance, autofocus with wide-area focus, and cancels any exposure adjustment

**Shutter-release button:** Pressing button partway down activates meter, autofocus system, and both data panel and viewfinder displays which remain on for 5 sec. after finger is lifted from button; pressing button all the way down releases the shutter

**Film-speed settings:** ISO 25 to 6400 in ambient light, ISO 25 to 1000 for TTL flash metering, both in 1/3-EV steps; automatic film-speed setting for DX-coded films (ISO 25 to 5000) can also be changed manually

**Film transport:** Automatic with built-in motor drive: auto threading, auto advance to first frame, single-frame advance or continuous advance at up to 3 frames per second, automatic or manual rewind start; advancing frame counter in data panel; shutter locks and audible and visual signals warn that film is loaded incorrectly

**Viewfinder:** Eye-level fixed pentaprism shows 92% of vertical by 94% of horizontal field of view; magnification 0.84X with 50mm lens at infinity; standard Acute-Matte screen (Type G) shows wide/center focus areas and spot metering area on matte field

**Data display:**

Data panel: Liquid-crystal display (LCD) shows exposure mode, shutter speed, aperture, manual-focus mode, film speed, frame number, self-timer operation, "bulb" operation, battery condition, exposure adjustment, film-advance mode, focus area selected, card function in use; illuminated automatically in low light

Viewfinder: LCD illuminated in low light and shows shutter-speed, aperture, exposure adjustment, film speed, whether light level is within metering range, over-/underexposure warning; focus status indicated by combination of LEDs and backlit LCD

**Power:** One 6-volt 2CR5 lithium battery powers all operations; battery condition indicated by four-stage signal in data panel; shutter locks when battery is exhausted; sliding main switch with LOCK, ON, and **•••** positions

**Audible signals:** At ON or **•••** position, camera beeps if film is loaded incorrectly and when battery power is low; at **•••** position, camera beeps when subject is in focus, during self-timer operation, and as a slow shutter-speed warning in program AE and aperture-priority AE modes

**Self-timer:** Electronic with 10-second delay; cancelable; camera beeps and red light blinks twice a second during operation

**Other:** Cushioned eyepiece frame, eyepiece cap, film window, remote-control socket, carrying strap

**Size and weight:** 6 x 3-11/16 x 2-11/16 in. (153 x 93 x 69mm), 20-13/16 oz. (590g) without lens and battery

**Optional accessories:** Accepts all Maxxum AF lenses, Maxxum Flash 3200i, Creative Expansion Cards, Program Back PB-7, Data Back DB-7, dioptric eyepiece-correction lenses, flash accessories including off-camera cables and connectors, user-changeable Acute-Matte Focusing Screens 7

Specifications subject to change without notice

## CARE AND STORAGE

- Always keep your camera in its case with the lens capped when not in use, or with a body cap on when a lens is not attached.
- No part of the camera should be forced at any time.
- Never subject your camera to shock, high heat, high humidity, water, or harmful chemicals. Be particularly careful not to leave it in the glove compartment or other places in motor vehicles where it may be subjected to high temperatures.
- Never lubricate any part of the camera body or lens.
- Never touch the shutter curtains or the front inside parts of the body or clean them with compressed air. Doing so may impair their alignment and movement.
- External camera surfaces and lens barrel — but not glass surfaces — can be cleaned by wiping with a dry or silicone-treated cloth.
- We recommend that you have your camera cleaned once a year at an authorized Minolta service facility.
- If you plan to store your camera for an extended period of time, first rewind and remove the film, then remove the battery. Next, place the camera in a cool, dry place away from dust or chemicals, preferably in an airtight container with a drying agent such as silica gel.
- After prolonged storage, and especially before taking pictures at an important event, carefully check the operation of the camera and lens.
- Never touch lens or eyepiece surfaces with your fingers. Whisk away loose matter with a blower brush. To remove stubborn spots, use a sheet of photographic lens tissue. If necessary, tissue may be moistened with one drop of lens-cleaning fluid. Never place fluid directly on glass surfaces.

- The operating range for the LCD (liquid-crystal display) data panels is from  $-4^{\circ}$  to  $122^{\circ}\text{F}$  ( $-20^{\circ}$  to  $+50^{\circ}\text{C}$ ). At temperatures outside this range, response time and contrast will change, making displays difficult to read. At very high temperatures, a display may temporarily darken. If this occurs, the display should return to normal after the camera is restored to operating range conditions.
- The Maxxum 7000i contains no user-serviceable parts. Do not attempt to disassemble or repair the camera yourself.
- Save camera box and packing material. When shipping your camera, carefully repack it in the box, insure adequately, and use a reliable delivery service.
- Before shipping your camera for repairs, contact your nearest authorized Minolta service facility.
- The Maxxum 7000i's circuitry may switch off, even when a battery with sufficient power is installed. To resume operation, remove the battery and install it again.



<b>Minolta Camera Co., Ltd.</b>	<b>3-13, 2-Chome, Azuchi-Machi, Chuo-Ku, Osaka 541, Japan</b>
<b>Minolta Corporation</b>	
<b>Head Office</b>	101 Williams Drive, Ramsey, New Jersey 07446, U.S.A.
<b>Los Angeles Branch</b>	11150 Hope Street Cypress, CA 90630, U.S.A.
<b>Chicago Branch</b>	3000 Tollview Drive, Rolling Meadows, IL 60008, U.S.A.
<b>Atlanta Branch</b>	5904 Peachtree Corners East, Norcross, GA 30071, U.S.A.
<b>Minolta Canada Inc.</b>	
<b>Head Office</b>	369 Britannia Road East, Mississauga, Ontario L4Z 2H5, Canada
<b>Montreal Branch</b>	376 rue McArthur, St. Laurent, Quebec H4T 1X8, Canada
<b>Vancouver Branch</b>	105-3830 Jacombs Road, Richmond, B.C. V6V 1Y6, Canada
<b>Minolta GmbH</b>	Kurt-Fischer-Strasse 50, D-2070 Ahrensburg, West Germany
<b>Minolta France S.A.</b>	357 bis, rue d'Estienne d'Orves, 92700 Colombes, France
<b>Minolta (UK) Limited</b>	1-3 Tanners Drive, Blakelands North, Milton Keynes, MK14 5BU, England
<b>Minolta Austria Gesellschaft m.b.H.</b>	Amalienstrasse 59-61, 1131 Wien, Austria
<b>Minolta Camera Benelux B.V.</b>	Zonnebaan 39, 3606 CH Maarssenbroek, P.B. 264, 3600 AG Maarssen, The Netherlands
<b>Belgium Branch</b>	Stenen Brug 115-117, 2200 Antwerpen, Belgium
<b>Minolta (Schweiz) AG</b>	Riedhof V, Riedstrasse 6 8953 Dietikon-Zürich, Switzerland
<b>Minolta Svenska AB</b>	Brännkyrkagatan 64, Box 17074, S-10462 Stockholm 17, Sweden
<b>Minolta Hong Kong Limited</b>	Room 208, 2/F, Eastern Center, 1065 King's Road, Quarry Bay, Hong Kong
<b>Minolta Singapore (Pte) Ltd.</b>	10, Teban Gardens Crescent, Singapore 2260

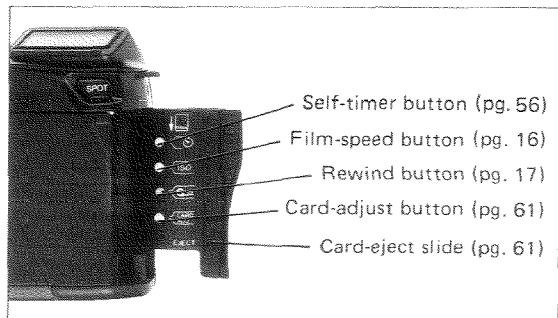
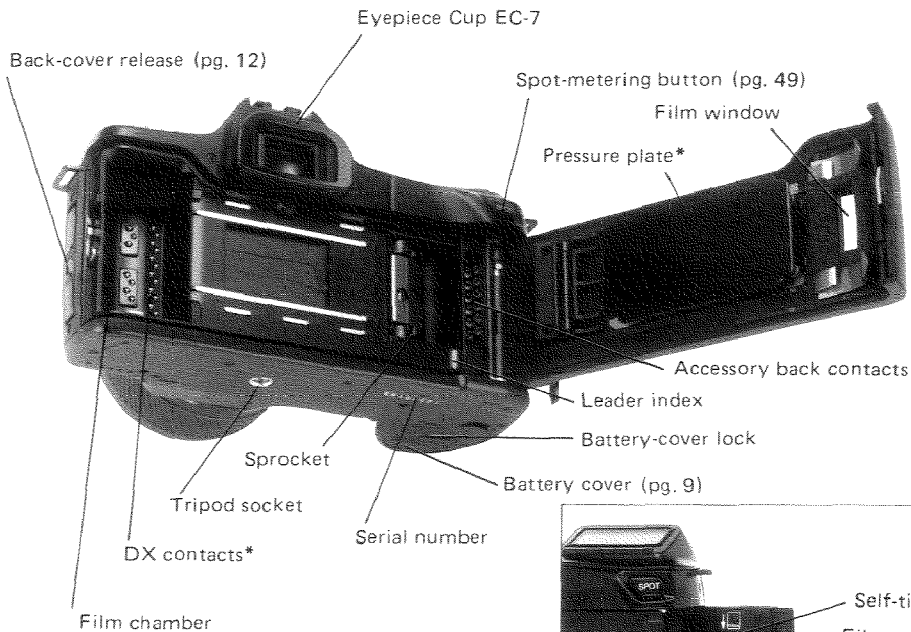

**\* Do not touch**

MEMO



MINOLTA