

E INSTRUCTION MANUAL

DYNAX
500si

MAXXUM[®]
400si
RZ430si

PREPARATIONS 

FULL-AUTO
OPERATION 

SUBJECT
PROGRAM MODE 

CREATIVE
EXPOSURE MODE 

FOCUS DETAILS 

FLASH DETAILS 

ADDITIONAL 

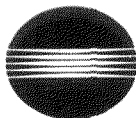

MINOLTA

IMPORTANT INFORMATION

This camera is designed to work specifically with lenses, flash units, and other accessories manufactured and distributed by Minolta. We therefore caution users of this camera that the attachment and/or use of incompatible products may result in unsatisfactory performance or damage to the camera or its accessories.

To obtain optimum performance throughout the life of your camera, we recommend that you use only those lenses, flashes, and other accessories distributed by Minolta specifically for use with this camera.

This device complies with Part 15 of the FCC Rules. Operation is subject to the following conditions: (1) This device may not cause harmful interference, and (2) this device must accept any interference received, including interference that may cause undesired operation. Changes or modifications not approved by the party responsible for compliance could void the user's authority to operate the equipment. This equipment has been tested and found to comply with the limits for a Class B digital device, pursuant to Part 15 of the FCC Rules. These limits are designed to provide reasonable protection against harmful interference in a residential installation. This equipment generates, uses and can radiate radio frequency energy and, if not installed and used in accordance with the instructions, may cause harmful interference to radio communications. However, there is no guarantee that interference will not occur in a particular installation. If this equipment does cause harmful interference to radio or television reception, which can be determined by turning the equipment off and on, the user is encouraged to try to correct the interference by one or more of the following measures:

- Reorient or relocate the receiving antenna.
- Increase the separation between the equipment and receiver.
- Connect the equipment to an outlet on a circuit different from that to which the receiver is connected.
- Consult the dealer or an experienced radio/TV technician for help.

This digital apparatus does not exceed the Class B limits for radio noise emissions from digital apparatus as set out in the Radio Interference Regulations of the Canadian Department of Communications.

FOREWORD

As you use this camera, you may find something extraordinary. You may very well find your photography improving and your interest in photography increasing.

If you are a beginning photographer, start with Full-Auto mode and observe the camera at work as you move from one subject to another. When you feel comfortable with the camera, select a Subject Program and move one step deeper into the realm of camera control. Notice how different exposure settings affect the end result and how the different effects are best suited to different subjects. The next step is for you to take full creative control of your camera by controlling the shutter speed or aperture or both to obtain the kind of image that you see only in your own mind.

Before you begin using your camera, however, take a moment to familiarize yourself with the contents of this manual. It contains all the information you will need to operate your camera for a lifetime of photography. Read it carefully, refer to it whenever necessary, and you will soon be on your way to beginning or continuing your fascinating experiences in photographing the world around you.

NOTE

In this manual, a display or indicator surrounded by radiating lines is blinking.

 Steady

 Blinking

This manual contains information regarding products introduced before August, 1994. To obtain compatibility information for products released after this date, contact the authorized MINOLTA Service Facility nearest you.

TABLE OF CONTENTS

NAMES OF PARTS

Camera Body	4
Body Data Panel	6
Viewfinder	7

PREPARATIONS

Standard Accessories	8
Neckstrap	8
Eyepiece Cap	8
Battery	9
Installation	9
Cautions	9
Indicators	10
Performance	11
Lens	12
Attaching	12
Removing	13
Care	13
Film	14
Speed	14
Loading	14
Rewind	16

FULL-AUTO OPERATION

Taking a Picture in Full-Auto Mode	18
Focus Notes	20
Flash Notes	20

SUBJECT PROGRAM SELECTION

Portrait	22
Landscape	23
Close-up	24
Sports Action	25
Night Portrait	26

CREATIVE EXPOSURE SELECTION

A Mode	28
Aperture Control	29
S Mode	30

Shutter Speed Control	31
M Mode	32
Exposure Control	33
Bulb	34
Flash and Creative Exposure Modes	35
FOCUS DETAILS	
Focus Signals	37
Special Focusing Situations	38
Focus Lock	39
Manual Focus	40
AF Illuminator	41
FLASH DETAILS	
Flash Signals	43
Built-in Flash	44
Flash Range	45
Red-Eye Reduction	46
Manual Fill-Flash	47
Wireless/Remote Flash Control	48
Wireless/Remote Ratio Flash	52
Canceling Wireless/Remote Flash	52
ADDITIONAL FEATURES	
Self-Timer	54
Program Re-Set Button	55
Continuous Film Drive	56
Exposure Compensation	57
APPENDIX	
Camera Shake Warnings	59
Exposure Warnings	60
Trouble Shooting	61
Caring for Your Camera	62
Technical Details	64
Accessory Information	66
Quick Reference Guide	67

NAMES OF PARTS

CAMERA BODY

For more information on specific parts, refer to the page number in parentheses.

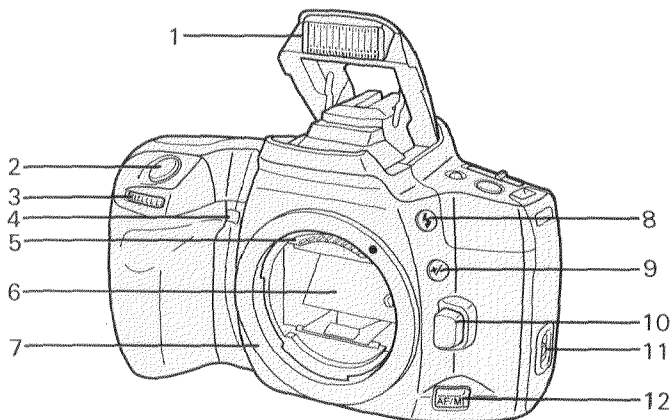

- | | |
|---------------------------|--------------------------------------|
| 1. Built-in flash (44) | 8. Flash-control button (47) |
| 2. Shutter-release button | 9. Exposure-compensation button (57) |
| 3. Control dial | 10. Lens-release button |
| 4. Self-timer lamp (54) | 11. Back cover release |
| 5. Lens contacts* | 12. Focus-mode button (40) |
| 6. Mirror* | |
| 7. Lens mount | |

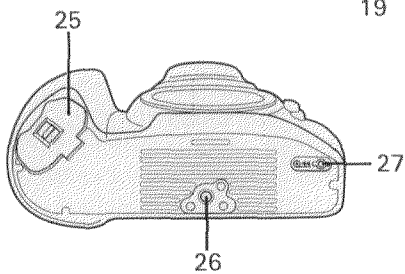
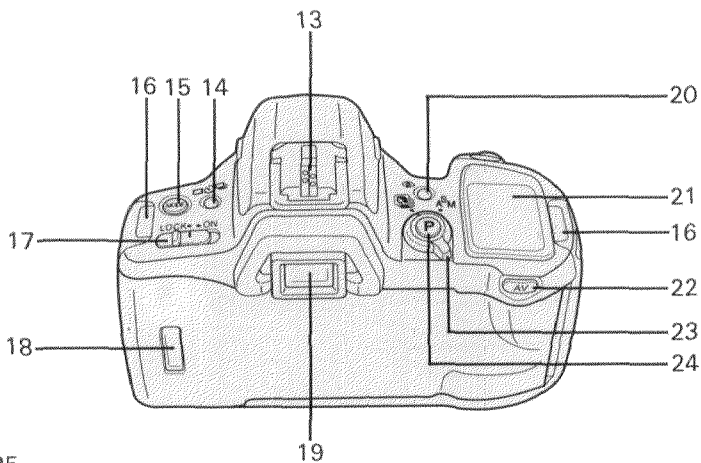

- 13. Accessory shoe
- 14. Drive-mode/self-timer button (54, 56)
- 15. Mode button
- 16. Strap eyelet (8)
- 17. Main switch
- 18. Film window

- 19. Viewfinder eyepiece*
- 20. Flash-mode button (46, 49)
- 21. Body data panel
- 22. Aperture button (32)
- 23. Command switch
- 24. Program re-set button (55)
- 25. Battery cover
- 26. Tripod socket
- 27. Rewind button (16)

*Do Not Touch

NAMES OF PARTS

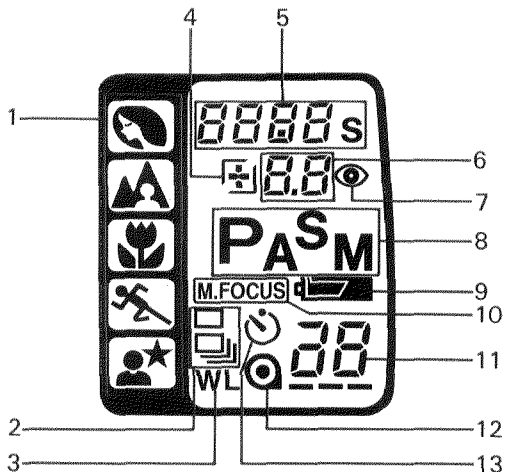

BODY DATA PANEL



1. Subject Program indicators:

-  Portrait
-  Landscape
-  Close-up
-  Sports action
-  Night portrait

2. Drive mode indicators:

-  Single-frame advance
-  Continuous drive

3. Wireless/Remote flash indicator

4. Exposure compensation indicator

5. Shutter speed display

6. Aperture/Exposure-compensation display

7. Red-eye reduction indicator

8. Exposure-mode indicators

9. Battery condition indicators

10. Manual-focus indicator

11. Frame counter

12. Film-cartridge mark

13. Self-timer indicator

VIEWFINDER

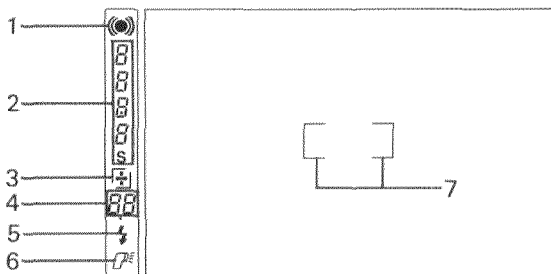

1. Focus signals
2. Shutter speed display
3. Exposure-compensation indicator
4. Aperture/Exposure-compensation display
5. Flash-ready indicator
6. Flash-on indicator
7. Focus frame

STANDARD ACCESSORIES

NECKSTRAP

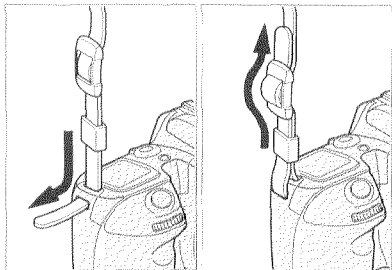

Attach the neckstrap as shown.

EYEPiece CAP

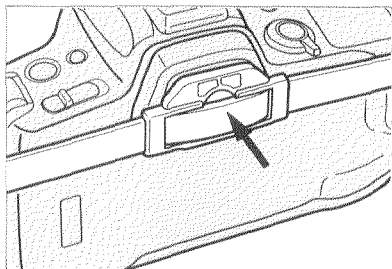

An eyepiece cap is attached to the neckstrap. When you use the self-timer or take a long exposure, snap it over the eyepiece as shown above. This will prevent light from entering the camera through the eyepiece and affecting the metered exposure.

- Kits with a wide strap do not include an eyepiece cap. See your local Minolta dealer to order an accessory eyepiece cap.

BATTERY

Your camera uses a 6-volt 2CR5 lithium battery which supplies power for all camera operations. If you are using an xi-Series lens, the camera battery also supplies power to the zoom motor in the lens.

BATTERY INSTALLATION

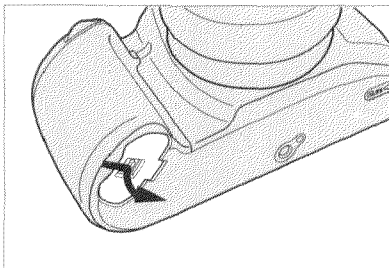

1. Set the main switch to LOCK and slide the battery-cover release in the direction indicated to open the battery cover.

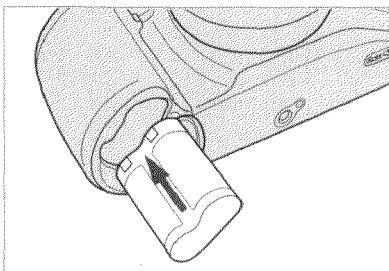

2. Insert the battery according to the marks on the inside of the cover.

3. Close the cover securely.

CAUTION

- Read and follow all warnings and instructions supplied by the battery manufacturer.
- The battery may explode and cause severe burns if you subject it to high temperatures or fire, or attempt to disassemble, recharge, or short-circuit it.
- Keep batteries away from small children.

BATTERY

BATTERY-CONDITION INDICATORS

Whenever you slide the main switch from LOCK to ON, one of the following indicators will appear in the body data panel.

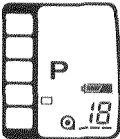
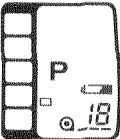
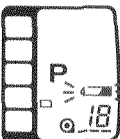
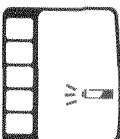
	<p>Full-battery symbol — power is sufficient for all camera operations.</p>
	<p>Low-battery symbol — power is sufficient, but getting low. Keep a fresh battery handy.</p>
	<p>Blinking low-battery symbol appears with other displays — camera can be operated, but power is extremely low. The battery will need to be changed soon.</p>
	<p>Blinking low-battery symbol appears by itself and the shutter locks — power is insufficient for operation. Replace the battery.</p>

- If no displays appear, replace the battery or check that it is inserted correctly.

BATTERY PERFORMANCE

The battery's performance will depend greatly on how often you use the built-in flash and the temperature in which you use the camera.

Flash Use	-20°C (-4°F)	20°C (68°F)
100%	5 rolls	13 rolls
50%	10 rolls	20 rolls
0%	20 rolls	50 rolls

The above figures are based on the following test conditions: Using 24-exposure rolls and AF 28-80mm f/4-5.6 lens; autofocus from infinity to minimum focus distance and back 3 times; shutter-release button held partway down for 10 seconds before shutter release.

- If you perform more operations during use, battery performance will be slightly lower.
- For performance with 36-exposure rolls, reduce above data by approximately 1/3.
- To maximize battery performance, slide the main switch to LOCK when you are not using the camera.

COLD-WEATHER OPERATION

Lithium batteries provide excellent performance in cold weather. However, if you plan to shoot many rolls of film in temperatures near or below 0°C (32°F), we recommend that you carry the camera inside your coat while you are not shooting to keep it warm. You should also carry several spare batteries in your pocket so that you can change the camera battery if necessary. Do not discard a cold battery. After it warms up, it will regain some of its charge.

LENS

ATTACHING

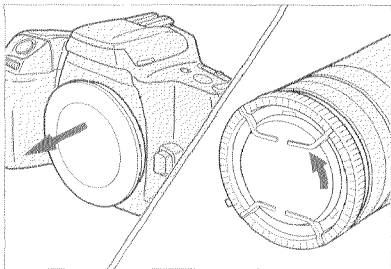

1. Remove the camera's body cap and the rear lens cap as shown.

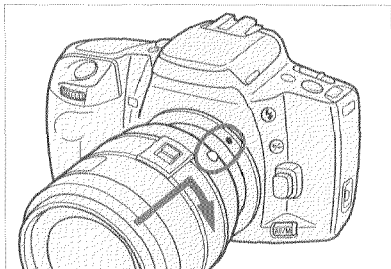

2. Align the red bead on the lens barrel with the red dot on the camera's lens mount.

3. Gently fit the lens into the mount and turn the lens clockwise until it locks firmly in place.

BE CAREFUL

- Do not force the lens if it does not turn smoothly.
- Never touch anything inside the camera, especially the lens contacts and mirror.

If two lines appear in the aperture display of the camera's body data panel when you press the shutter-release partway down, no lens data is being received by the camera. Some possible causes of this are:

- No lens is attached to the camera
- The lens is not attached properly
- The lens contacts are dirty
- You have attached a non-compatible lens

REMOVING

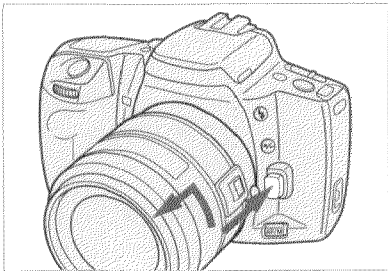

1. Press the lens release button and hold it while you turn the lens counter-clockwise until it stops.
2. Gently remove the lens from the mount.
3. Immediately attach the rear cap to the lens and the body cap or another lens to the camera.

CARE OF GLASS SURFACES

- Never touch any lens surfaces (including the viewfinder eyepiece) with your fingers. If your lens is dirty, first gently clean it with a lens brush to remove loose material. Then, if necessary, moisten a sheet of lens tissue with one drop of lens-cleaning fluid and, starting from the center of the lens, gently wipe the glass using a circular motion.
- Never lift the mirror inside the camera or touch its surface. This may impair its alignment or scratch its face. Dust on the mirror's surface will not affect meter readings or picture quality. If it is distracting, have your camera cleaned at an authorized MINOLTA Service Facility.

FILM

FILM SPEED

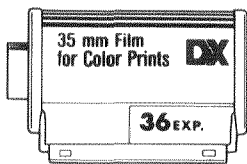

Use DX-coded films, ISO 25 - 5000. DX-coding is a system which the camera uses to automatically identify the film you have loaded. You can recognize DX-coded film by the **DX** printed on the cartridge and box and by the black-and-silver pattern on each cartridge.

The camera reads information encoded on this pattern and sets the film speed automatically each time you insert a new roll of film. If you use non-DX-coded film, the camera automatically sets the film speed to 100.

- Do not touch the contacts inside the film chamber.

LOADING FILM

Before you load film, check the film window on the back of the camera. If there is already film in the camera, **do not open the back cover**. See page 16 for instructions on rewinding an unfinished roll of film.

- Always load film in subdued light or shade.

BE CAREFUL

- **NEVER TOUCH THE SHUTTER CURTAIN WITH YOUR FINGERS OR WITH THE FILM TIP.** Its precision design makes it extremely sensitive to pressure.
- If the film tip is bent or torn, the film may not wind correctly.

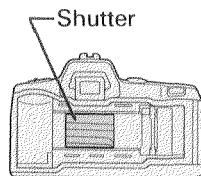

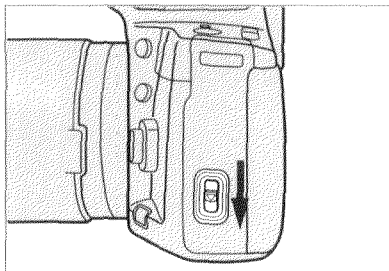

1. Open the back cover by sliding the back-cover release down.

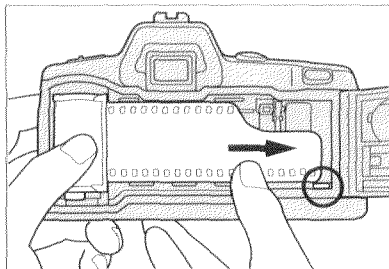

2. Place the film cartridge in the film chamber flat side up and extend the film tip to the red mark.

- If the film tip extends beyond the mark, gently push the excess film back into the cartridge.

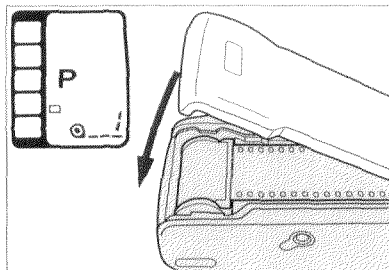

3. Close the back cover and slide the main switch to **ON**. The camera will automatically advance the film to the first frame and 1 will appear in the frame counter.

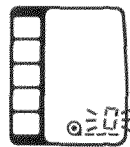

- If the film is loaded incorrectly, **0** will blink in the frame counter and the shutter will remain locked. Open the back cover and repeat steps 2 and 3.

- For flash pictures, use film between ISO 25 and 1000.

FILM

REWINDING FILM

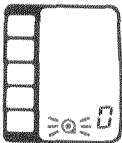

After you have exposed the last frame, the camera will automatically rewind the film. With a fresh battery, it takes about 21 seconds to rewind a 36-exposure roll, or 16 seconds for a 24-exposure roll. When the film has been completely rewound, the motor will stop and the film-cartridge symbol in the body data panel will blink to indicate that it is safe to open the back cover.

To begin film rewind manually:

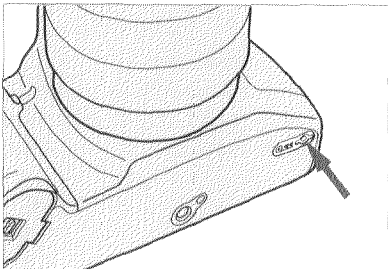

Use a coin or similar object to press the rewind button on the bottom of the camera. Wait until the motor stops and the film cartridge mark blinks before opening the back cover.

FULL-AUTO OPERATION

Full-Auto mode is the camera's standard operating mode and is suited for use in virtually any situation. In this mode, the camera will focus automatically, set the best shutter speed and aperture, and determine when flash is necessary. Use Full-Auto mode when you are just starting out, when you cannot decide which Subject Program to use, or when you are photographing in quick-changing conditions that would require you to constantly adjust the shutter speed and/or aperture.

1. TURN THE CAMERA ON, PRESS THE PROGRAM RE-SET BUTTON, AND RAISE THE FLASH.

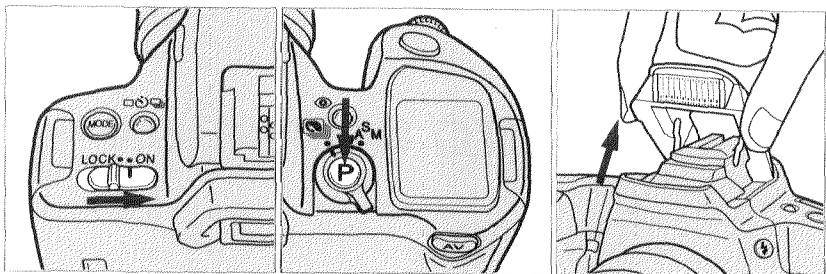

- Pressing the program re-set button restores many of the camera's functions to their standard settings. See page 55 for more information.
- When the built-in flash is up, it will fire whenever necessary in Full-Auto mode. See page 20 for more information.

2. HOLD THE CAMERA WITH BOTH HANDS.

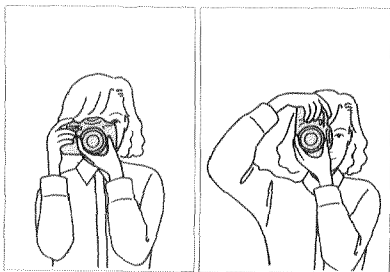

Hold the grip firmly in your right hand and use your left hand to support the camera or lens from beneath. Keep your elbows securely against your sides when shooting both horizontal and vertical pictures. This will help steady the camera and reduce blur in your pictures.

- Always keep the camera strap around your neck for safety.

3. LOOK THROUGH THE VIEWFINDER AND FOCUS ON YOUR SUBJECT.



Place your subject inside the focus frame and press the shutter-release button partway down to activate autofocus.

- Do not touch the focusing ring of an AF lens or the end of the lens barrel of an xi-Series Autozoom lens while the lens is focusing.

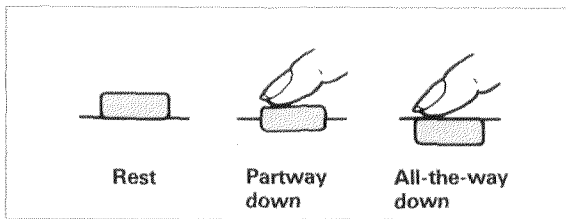

4. TAKE THE PICTURE.

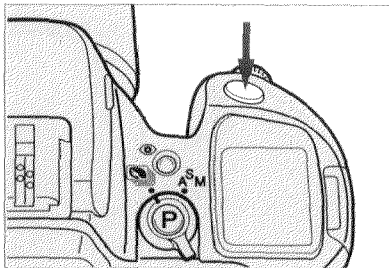

When the focus-lock signal ● appears in the viewfinder data panel, press the shutter-release button all the way down. Press the shutter-release button gently with a single, steady motion — never with a quick jab. This will prevent the camera from moving suddenly at the last moment.

FOCUS NOTES

When you press the shutter-release button partway down in STEP 3, auto-focus will activate and the viewfinder data panel will light. The camera's auto-focus system will then lock focus on the subject in the focus frame if it is stationary, or will automatically track a moving subject until you press the shutter-release. In Full-Auto mode, there are two focus signals you should know. For more information on these and other focus signals, see page 37.

- (●●) When either of these symbols appear, you can take the picture.
 - ☉ () When either of these symbols appear, the shutter will lock.
- To place your subject outside the focus area, see page 39.

FLASH NOTES

In Full-Auto mode, the following flash signals will appear in the viewfinder data panel. For more information on these signals, see page 43.



When this symbol blinks, flash is necessary. Raise the camera's built-in flash. When it lights steadily, the flash will fire the next time you take a picture.



When this symbol appears, the flash is charged and you can take a picture. The shutter will lock until it appears to prevent accidental under exposure.

SUBJECT PROGRAM SELECTION

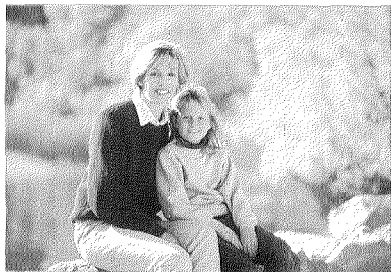

In any of the five subject programs, the camera will, as in Full-Auto mode, do everything from focus automatically to select the shutter speed and aperture which is best suited for your subject. By using Subject Program mode you take control of an important part of the automatic process and tell the camera from the beginning what kind of picture you will take: a portrait, a landscape, a close-up, sports action, or a portrait at night. For information on P mode, refer to "Full-Auto Operation" beginning on page 17.

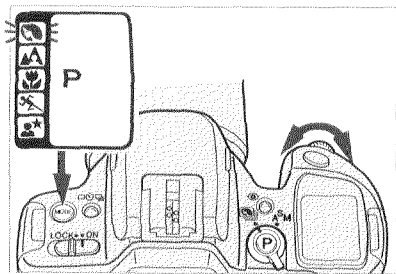

Photographs of people usually benefit from shallow depth of field (the distance in front and behind the point on which you focus which also appears sharp) to isolate the subject from the background. In portrait mode, the camera will make all the settings necessary to obtain this effect, leaving you free to concentrate on composition and capturing the perfect moment or expression.



To select Portrait mode:

1. Set the Command switch to .
2. Press and hold the Mode button and turn the control dial until  blinks.
3. Release the Mode button.

RECOMMENDED LENSES

- Use a telephoto lens or the telephoto setting on your zoom lens to enhance the separation between your subject and the background.

USING FLASH

- Raise the built-in flash only if the background is much brighter than your subject or if there are strong shadows across your subject's face. If you use flash, however, it may not be possible for the camera to obtain shallow depth of field.

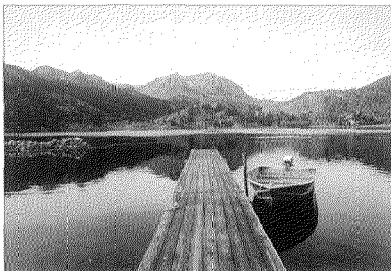

ADDITIONAL SUGGESTIONS

- Lock focus on your subject's eyes.
- Be ready to capture subtle changes in expression after you take the first picture.



In a landscape photograph, the subject generally extends from near to far. For this reason, a small aperture is necessary to provide maximum depth of field and capture as much of the scene as possible in sharp focus. When set to Landscape mode, the camera will automatically set the smallest aperture possible without introducing the blurring effects of "camera-shake" (see p.59).

To select Landscape mode:

1. Set the Command switch to .
2. Press and hold the Mode button and turn the control dial until  blinks.
3. Release the Mode button.

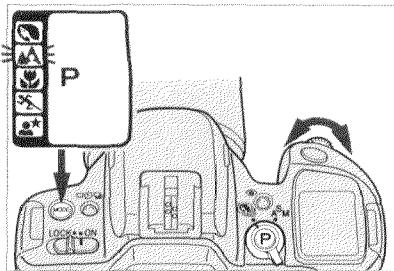

RECOMMENDED LENSES

- Use wide-angle lenses or the wide-angle setting of your zoom lens. This will help create a feeling of depth that will enhance your landscape photographs.

USING FLASH

- Flash is not recommended in Landscape mode because your subject will usually be outside of flash range.
- When you photograph a person in front of a landmark or scenic landscape, flash will help only if the sun is behind the person.

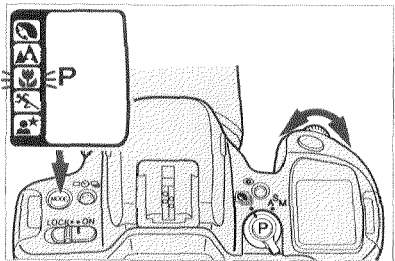

ADDITIONAL SUGGESTIONS

- Use a tripod to obtain the sharpest possible results.



When you take pictures of small objects such as flowers or models, set Close-up mode. In Close-up mode, the camera will automatically set the best possible aperture and shutter speed for the picture you are taking.

To select Close-up mode:

1. Set the Command switch to .
2. Press and hold the Mode button and turn the control dial until  blinks.
3. Release the Mode button.

RECOMMENDED LENSES

- Use a macro lens (50mm f/2.8 Macro or 100mm f/2.8 Macro) or a macro-capable zoom lens.
- Read your lens owner's manual before taking close-up photographs.

USING FLASH

- The built-in or an accessory flash may not be suitable for close-up photography. Refer to your flash manual or pp.44, 45 of this manual for more information.
- To take pictures closer than 1m (3.3 ft.), use Macro Flash 1200AF Set or Close-up Flash Diffuser CD-1000 (available separately).

ADDITIONAL SUGGESTIONS

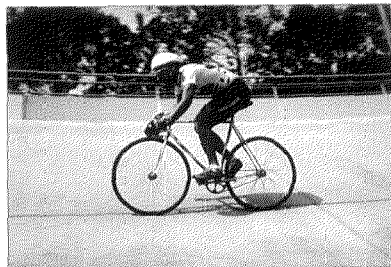

- When you attach the camera to a tripod, use the self-timer to take the picture. This will allow camera vibrations to subside before the shutter opens.

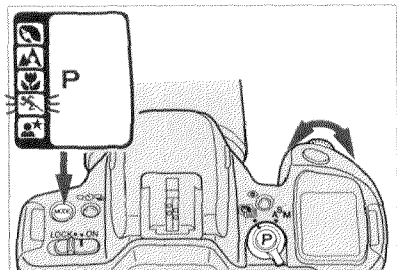

Fast action requires a fast shutter speed to stop the action. Sports mode enables you to concentrate entirely the action to capture the precise moment you want. The camera will automatically set the fastest shutter speed possible and continuously adjust focus to track fast-moving subjects.



To select Sports mode:

1. Set the Command switch to .
2. Press and hold the Mode button and turn the control dial until  blinks.
3. Release the Mode button.

RECOMMENDED LENSES

- Large-aperture lenses allow the camera to select faster shutter speeds.

USING FLASH

- Use flash only if your subject is within flash range and the light is too dark to permit handheld photography (see p.59).

ADDITIONAL SUGGESTIONS

- Fast film (ISO 400 or higher) enables the camera to set faster shutter speeds.
- Keep the focus frame centered over your subject.
- Select continuous-drive mode (see p.56) if needed.





NIGHT PORTRAIT

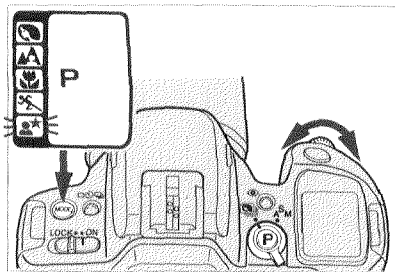

Use flash with Night Portrait mode to photograph people at night or at sunset. The camera will automatically balance the flash exposure with existing light. Also use Night Portrait mode without flash to photograph city skylines and other night scenes that are outside flash range.



To select Night Portrait mode:

1. Set the Command switch to .
2. Press and hold the Mode button and turn the control dial until  blinks.
3. Release the Mode button.

USING FLASH

- In Night Portrait mode, when the built-in flash is down or an attached accessory flash is off, the camera's flash signals will not appear in the viewfinder at any time.
- With flash, if the background is very dark, it may not appear in the photograph. This mode is best for photographing people at twilight or at night with lights in the background.

ADDITIONAL SUGGESTIONS

- With or without flash, you should use a tripod for best results.
- If your subject is not near, such as a city skyline at night, autofocus may not be able to focus accurately. You may have to lock focus on a bright point (p.39) or focus manually (p.40).

CREATIVE EXPOSURE SELECTION

When the Command switch is set to **A^SM**, you can choose any of four separate exposure modes: Aperture-priority, Shutter-priority, Manual, and, of course, Program mode. While Subject Program mode allows you to match the camera to the photographic situation, Creative Exposure mode enables you to tailor the camera's operation to your vision of the end result and the degree of camera control you desire. For information on P mode, refer to "Full Auto Operation" beginning on page 17.

A MODE: Aperture Priority

In A mode, you set the lens aperture manually and the camera selects the shutter speed which will provide a correct exposure.

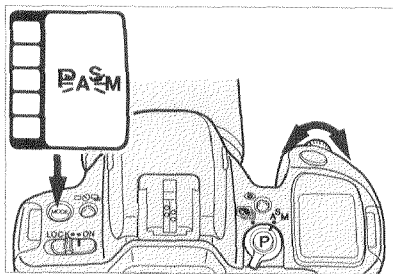

1. Set the Command switch to **A^SM**.

2. Press and hold the Mode button and turn the control dial until A blinks.

3. Release the Mode button and turn the control dial to select the aperture you want.

- The aperture setting will change in 1/2-stop increments.

4. Compose your photograph, focus, and take the picture.



If 2000 or 30s blinks, the required setting is beyond the camera's shutter speed range. Turn the control dial until the blinking stops.

- See pp.59-60 for more exposure warnings.

APERTURE CONTROL

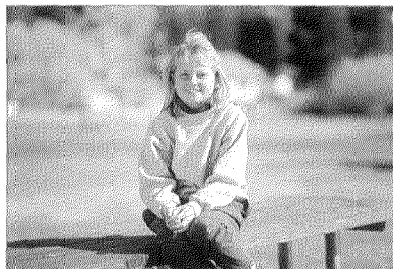

Large Aperture

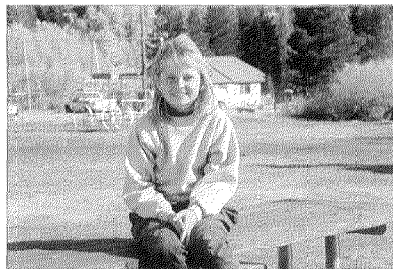

Small Aperture

The size of the aperture determines the intensity of the light falling on the film as well as the depth of field in the final image. Depth of field is the area in front of and behind the point on which the lens is focused which will also appear sharp in the final image.

Large apertures (small numbers) limit depth of field to a narrow range near the focus point. This is useful whenever you want to place greater visual emphasis on your main subject by intentionally blurring the background, such as in the case of portraits. Small apertures (large numbers) provide greater depth of field, bringing an increasingly greater range into focus. This is important when you are taking landscapes to ensure that your entire scene is sharp.

LENS APERTURES

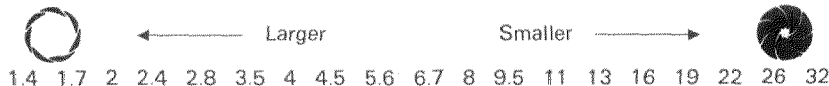

NOTE: Usable apertures will depend on the aperture range of the lens you are using.

In S mode, you set the shutter speed manually and the camera automatically selects the aperture which will provide the correct exposure.

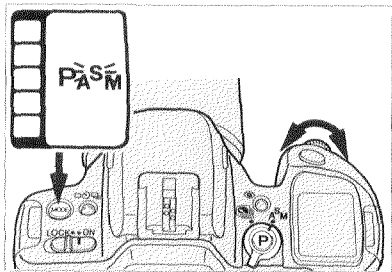

1. Set the Command switch to **A^SM**.

2. Press and hold the Mode button and turn the control dial until S blinks.

3. Release the Mode button and turn the control dial to select the shutter speed you want.

- The shutter speed will change in 1-stop increments.
- You cannot select BULB in S mode.

4. Compose your photograph, focus, and take the picture.

If the aperture display blinks, the required setting is outside the lens' aperture range. Turn the control dial until the blinking stops.

- See pp.59-60 for more exposure warnings.

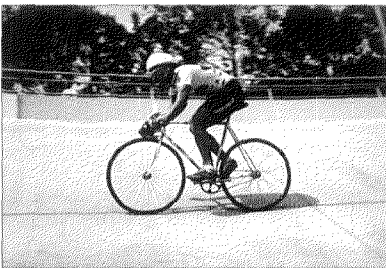

Fast Shutter Speed



Slow Shutter Speed

In addition to controlling the duration of the exposure, the shutter speed is an important factor in determining how moving subjects will appear in the final image. Depending on the speed of your subject, slow shutter speeds will make a moving subject appear to flow, creating a greater feeling of motion. Fast shutter speeds, of course, are useful to freeze fast action.

Your choice of shutter speed can also help prevent blurring caused by movement that occurs during the exposure, known as “camera shake”. For focal lengths longer than $f = 50\text{mm}$, a general rule to follow is that $1/f$ is the slowest usable shutter speed while the camera is being hand-held. For example, if you are using a 135mm lens, try to avoid using shutter speeds slower than $1/250$ sec. (next fastest shutter speed to $1/135$ sec.) if you are not using a tripod.

CAMERA SHUTTER SPEEDS (in seconds)

← Faster Slower →

1/2000 1/1000 1/500 1/250 1/125 1/60 1/30 1/15 1/8 1/4 1/2 1 2 4 8 15 30

NOTE: 1/90 sec. is the camera’s flash sync speed and can only be selected, manually or automatically, when the built-in flash is raised or an accessory flash is attached and activated. BULB can only be selected in M mode.

M MODE: Manual Exposure

M mode gives you complete control over the exposure settings. In this mode, you select any shutter speed and aperture. The viewfinder data panel will tell you if the exposure you have selected is over, under, or the same as the camera's metered exposure.

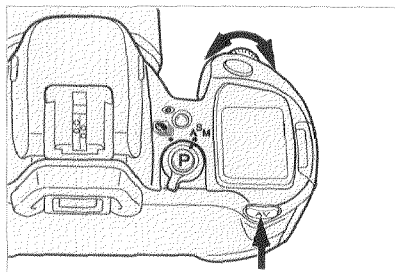
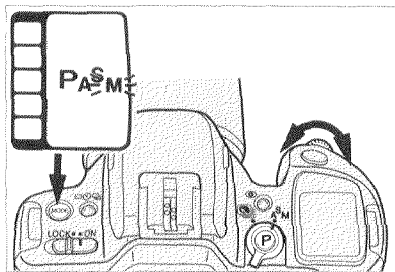

1. Set the Command switch to **A^SM**.
2. Press and hold the Mode button and turn the control dial until M blinks.
3. Release the Mode button and turn the control dial to select the shutter speed you want.
4. While pressing the aperture button, turn the control dial to select the aperture you want.
5. Focus, check the viewfinder exposure indicators, and take the picture.
 - The shutter speed will change in 1-stop increments and the aperture will change in 1/2-stop increments.

VIEWFINDER INDICATORS



Correct exposure

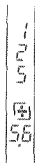

Over exposure

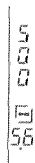

Under exposure

- See pp.59-60 for more exposure warnings.

Exposure is the quantity of light that reaches the film when you press the shutter-release button. This quantity is determined by the intensity of the light that falls on the film and the time that the film is exposed to light.

In M mode, you have full creative control over both of these variables: the aperture setting regulates the intensity of the exposure, and the shutter speed determines the time. By adjusting either of these in relation to the camera's metered exposure value, you can control the overall exposure of each image.



Over Exposure

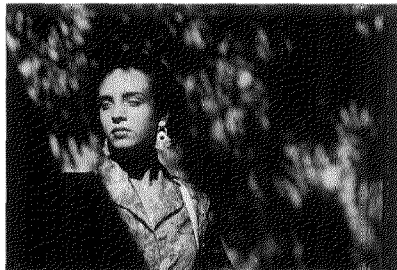

Under Exposure



Metered Exposure

When you select BULB, the shutter will remain open as long as you press the shutter-release button.

To use BULB:

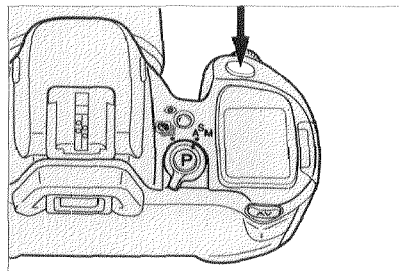
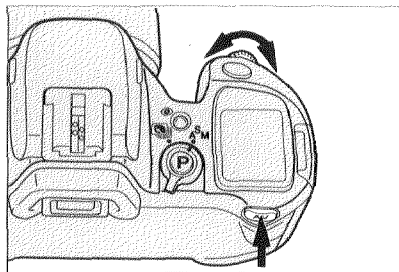
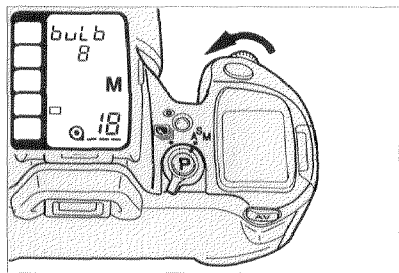

1. Attach your camera to a tripod.
2. Select M mode and turn the control dial to the left until BULB appears in the data panel.
3. Set the aperture by pressing the aperture button and turning the control dial.
4. Compose your photograph and focus the lens.
5. Attach the eyepiece cap (see p.8) to prevent light from entering the viewfinder during the exposure.
6. Press the shutter-release button to take the picture. The shutter will remain open as long as you hold the shutter-release down.

FLASHING CREATIVE EXPOSURE MODES

In A, S, and M modes, when you raise the built-in flash or attach and activate an accessory flash, the flash will fire every time you take a picture. The camera's TTL flash metering system will control the flash output to provide a *proper exposure as long as you are within flash range* (for built-in flash, see p.45). Usable shutter speeds are limited to those slower than the camera's flash-sync speed.



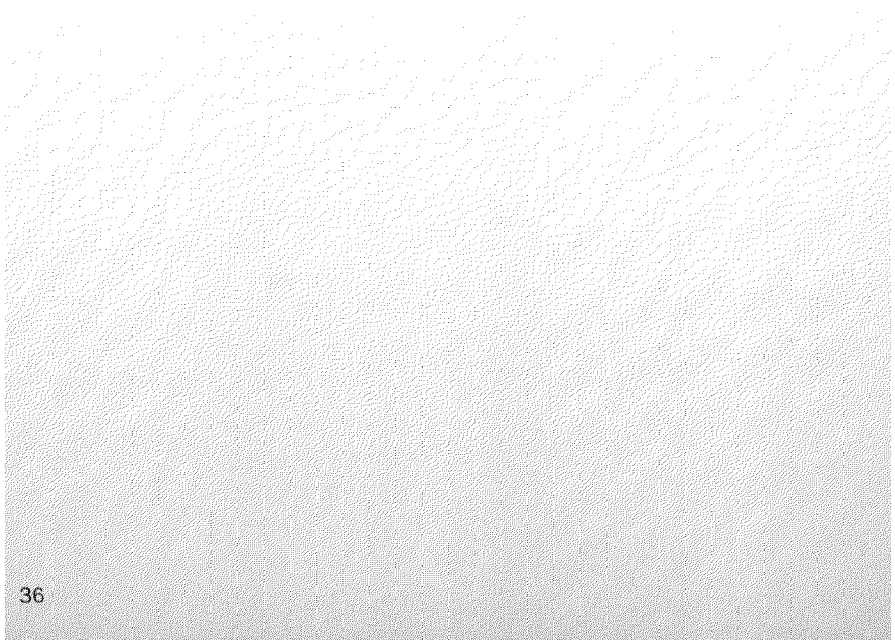

EXPOSURE MODE	USABLE SHUTTER SPEEDS WITH FLASH
A	1/90 sec. (set automatically)
S	1/90 - 1/60 sec. (set automatically)
M	1/90 - 30 sec. plus BULB (set manually)

FOCUS DETAILS



FOCUS SIGNALS

When you press the shutter-release button partway down, the camera will focus automatically and one of the signals below will appear in the viewfinder data panel. In autofocus mode, the shutter will not release until the camera confirms focus. This will help you avoid accidentally taking out-of-focus pictures. When you focus the lens manually, only the first signal described below will appear, and the shutter will release even if your subject is not focused.

	Focus is confirmed and locked
	Focus is not possible (shutter locked)*
	Continuous autofocus, focus is confirmed
	Continuous autofocus, lens focusing (shutter locked)

*The camera may not be able to focus because your subject is one of those described on the next page or because you are too close for your lens to focus. Check your lens manual for the minimum focusing distance of your lens.

SPECIAL FOCUSING SITUATIONS

In the situations described below, it may be difficult or impossible for the camera to autofocus properly — you may have to use focus lock (p.39) or manual focus (p.40).

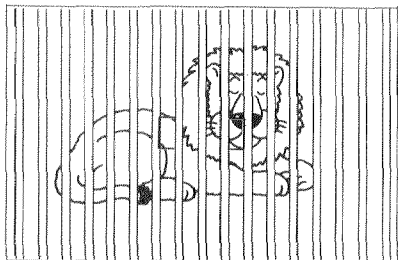

If two subjects at different distances overlap within the focus frame.

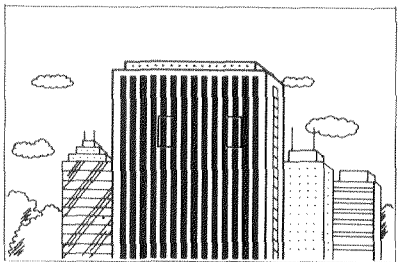

If a subject composed of alternating light and dark lines completely fills the focusing frame.

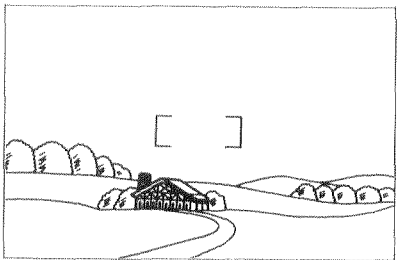

On very bright or low-contrast subjects

FOCUS LOCK

If you want to take a picture with your main subject outside the focus frame, first lock focus on your subject, then recompose the scene as you wish.



1. Place your subject in the center of the focus frame.

2. Press and hold the shutter-release button partway down.

3. Wait for the focus-lock signal ● to appear in the viewfinder data panel.

4. Recompose your picture and press the shutter-release button all the way down to take the picture.

● Focus will not lock if your subject is moving.

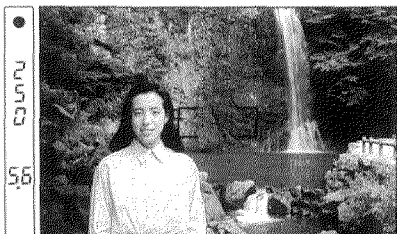

Focus Lock With The Lens Control Ring:

If you are using an xi-Series or power zoom lens, you can lock focus by pulling the lens control ring towards the camera. Hold it in this position while you recompose and take the picture. Do not turn the ring after you lock focus.

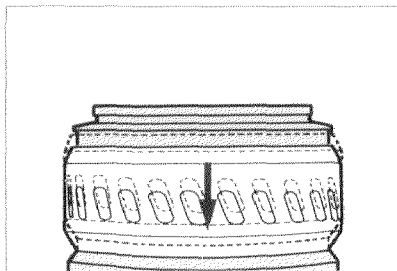

MANUAL FOCUS

To focus the lens manually:

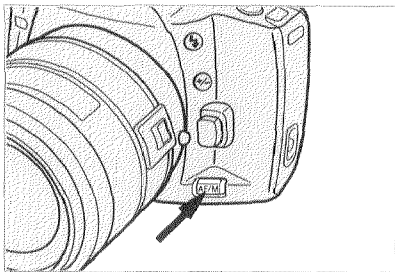

1. Press the focus-mode button to set the camera to manual focus mode.

● **M. FOCUS** will appear in the data panel.

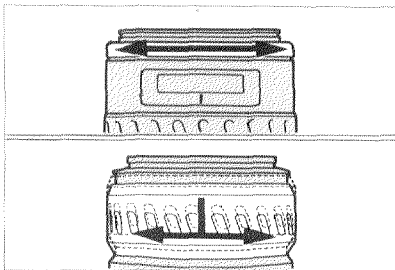

2. If you are using an AF lens, turn the focusing ring until the subject appears sharp. If you are using an xi-Series lens or AF power zoom lens, pull and turn the lens control ring.

- The focus indicator will light when the subject is in focus.
- To return to autofocus mode, press the focus-mode button again.
- The camera will return to autofocus mode if you press the program re-set button.
- In manual focus mode, you will be able to take a picture even if the subject in the focus frame is not in focus.

AF ILLUMINATOR

If the flash is raised and the camera detects that the scene is too dark to focus accurately, the flash will automatically fire a short stroboscopic burst before and after the lens focuses. This provides the light necessary for the camera to detect and focus on your subject.

To Turn the AF Illuminator On/Off:

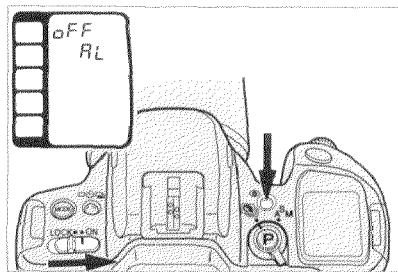





Press and hold the flash-mode button while you turn the camera on — **OFF AL** will appear in the data panel. To turn the AF illuminator on, repeat this procedure — **ON AL** will appear in the data panel.

- The range of the AF illuminator flash is approximately 1-5m (3.3-16 ft.).

FLASH DETAILS

FLASH SIGNALS

In all exposure modes, including all Subject Programs, the flash indicators in the viewfinder data panel will provide the following information about the built-in flash or an attached accessory flash.

	Lighting conditions require flash. Raise the built-in flash or attach an accessory flash.
	Built-in flash is raised or accessory flash is on and charging
	Flash is charged and will fire when the shutter-release button is pressed
	<i>(After taking picture) Flash output was sufficient to provide a correct exposure</i>

BUILT-IN FLASH

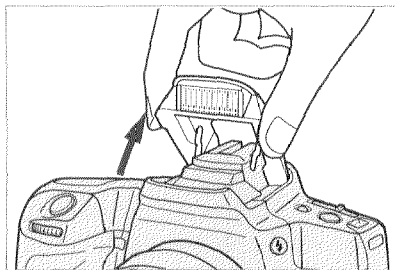

The built-in flash provides coverage for lens focal lengths as short as 28mm. The flash output is controlled automatically by the camera's flash metering system. To activate the built-in flash, gently raise it; to turn it off, press it down.

- If you use the built-in flash with lenses wider than 28mm, the edges of your pictures will be dark.
- Do not take pictures closer than 1m (3.3 ft.) with the built-in flash.
- Do not use a lens hood when you use the built-in flash.

CAUTION

- Shadowing may occur in the bottom of your pictures if you use the built-in flash with some Minolta AF lenses. Before using any of the lenses listed below, check with the nearest Minolta Service facility for the conditions of their use.

AF Zoom 28-70mm f/2.8
AF Zoom 28-85mm f/3.5-4.5

AF Zoom 28-135mm f/4-4.5
AF Zoom xi 35-200mm f/4.5-5.6

- The following lenses cannot be used under any conditions with the built-in flash:

AF 300mm f/2.8 Apo

AF 600mm f/4 Apo

FLASH RANGE

The range of the built-in flash changes depending on the film speed and lens aperture you are using. If your subject is outside the respective range given below, it may be underexposed; if inside this range, it may be overexposed.

APERTURE	ISO 100	ISO 400
f/2.8	1 - 4.2m (3.3 - 13.8 ft.)	1 - 8.4m (3.3 - 27.5 ft.)
f/4	1 - 3m (3.3 - 9.8 ft.)	1 - 6m (3.3 - 19.7 ft.)
f/5.6	1 - 2.1m (3.3 - 6.9 ft.)	1 - 4.2m (3.3 - 13.8 ft.)

RED-EYE REDUCTION

Photographs of people sometimes suffer from an effect called “red-eye”. This is caused by light from the flash reflecting off the inside of the person’s eye. To minimize the appearance of red-eye, your camera has a feature called “Red-Eye Reduction”. When you select this function and take a flash picture, the flash will fire several times before the shutter opens. The light from the pre-flash causes the pupils in your subject’s eyes to close, effectively eliminating red-eye.

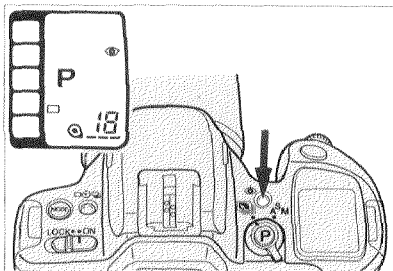

To Select Red-Eye Reduction:

Press the flash-mode button.

- The red-eye indicator  will appear in the camera data panel.
- Before you take a picture with red-eye reduction, warn your subject that the flash will fire several times before the picture is taken.

To cancel red-eye, press the flash-mode button again.

MANUAL FILL-FLASH IN P MODE

In extremely bright conditions, such as at the beach or on snow, you may find harsh shadows in and around your subject. In this case to fill-in the shadows, or whenever you want the flash to fire in P mode, use manual fill-flash.

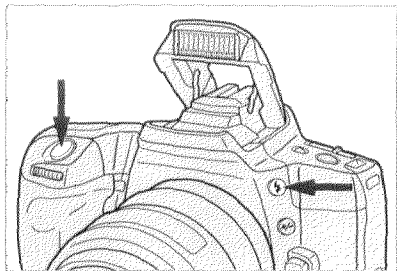

To Select Manual Fill-Flash:

Press and hold the flash control button while you take the picture.

WIRELESS/REMOTE OFF-CAMERA FLASH CONTROL (5400HS, 5400xi, 3500xi)



Normal Flash



Wireless/Remote Flash



Wireless/Remote Ratio Flash

One of the keys to creative photography is experimenting with light. Wireless/remote flash mode gives you the ability to explore the flexibility of off-camera flash control with unprecedented ease. With wireless/remote flash, you will find the freedom to create unique and exciting images without a tangle of accessory cords and connectors.

In wireless/remote flash mode with specified flash units, the off-camera flash is triggered by a coded signal from the camera's built-in flash when you press the shutter-release button. Another signal stops it once the camera's TTL flash meter detects that the proper exposure has been received.

You can also obtain a 2:1 lighting ratio automatically. When selected, the off-camera flash provides 2/3 of the full exposure and the camera's built-in flash adds the remaining 1/3.

NOTE: Because the signal that fires the off-camera flash is a small burst from the built-in flash, reduce the brightness of your surroundings as much as possible when you use wireless/remote flash.

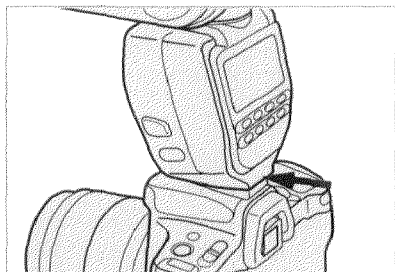

To Set Wireless/Remote Flash Mode:

1. Attach the flash (5400HS, 5400xi, or 3500xi) to the camera and turn both on.

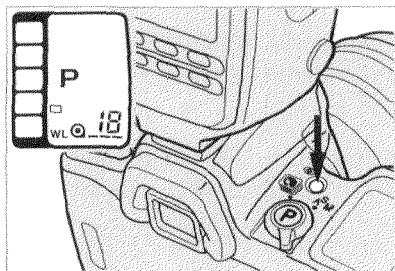

2. Press the camera's flash-mode button — **WL** will appear in the data panel and the flash will be set automatically to wireless/remote mode.

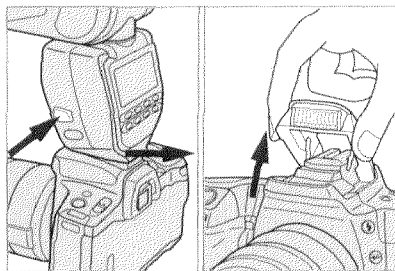

3. Remove the accessory flash and raise the camera's built-in flash.

WIRELESS/REMOTE OFF-CAMERA FLASH CONTROL

To Use Wireless/Remote Flash:

1. Position the accessory flash and the camera according to the chart and diagram in the flash manual. If you are using a 3500xi off-camera, refer to the information on page 51.

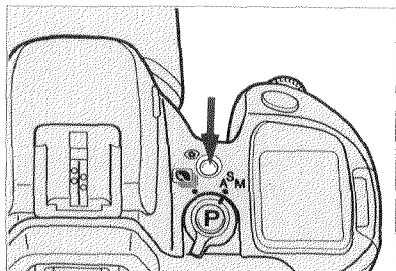

2. Wait until both the off-camera flash and built-in flash are charged, then press the flash-mode button to test-fire the off-camera flash. Wait until both flashes are fully charged.

3. Press the shutter-release button all the way down to take the picture.

● The flash's AF illuminator will blink when the flash is charged.

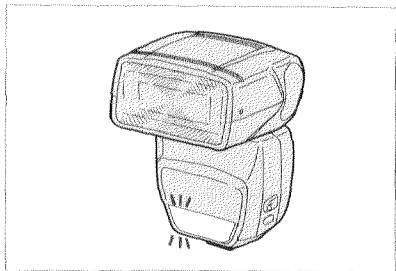

- When the 5400HS is set to modeling flash in wireless/remote flash mode, pressing the camera's flash-mode button will also activate modeling flash.
- The flash mark in the viewfinder data panel will blink if the flash output was sufficient to provide a correct exposure.
- In wireless/remote flash mode, the shutter speed is automatically set to 1/45 sec. or slower.
- An accessory flash (5400xi or 5400HS) or Wireless/Remote Flash Controller cannot be used as the on-camera control unit.

Use the information on this page to position your camera and 3500xi flash unit. If you are using another flash unit off-camera, refer to that flash unit's owner's manual.

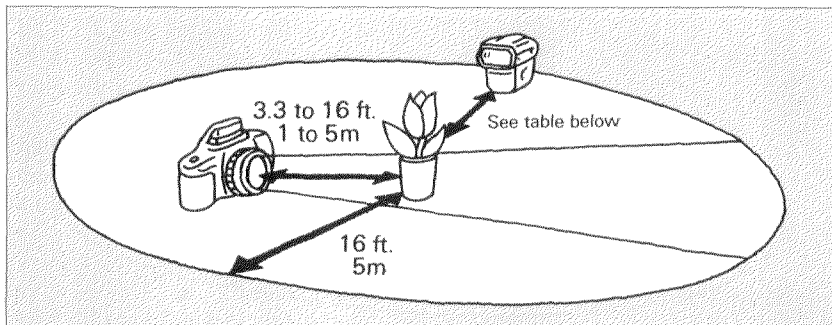

APERTURE	CAMERA-SUBJECT DISTANCE m/ft.		3500xi-SUBJECT DISTANCE m/ft.	
	ISO 100	ISO 400	ISO 100	ISO 400
f/2	2.5m / 6.6-16.4 ft.	4.5m / 13.2-16.4 ft.	1.4-5m / 4.6-16.4 ft.	2.8-5m / 9.2-16.4 ft.
f/2.8	1.4-5m / 4.6-16.4 ft.	2.8-5m / 9.2-16.4 ft.	1.5m / 3.3-16.4 ft.	2.5m / 6.6-16.4 ft.
f/4	1.5m / 3.3-16.4 ft.	2.5m / 6.6-16.4 ft.	0.7-4.5m / 2.3-14.4 ft.	1.4-5m / 4.6-16.4 ft.
f/5.6	1.5m / 3.3-16.4 ft.	1.4-5m / 4.6-16.4 ft.	0.5-3.2m / 1.6-10.6 ft.	1.5m / 3.3-16.4 ft.
f/8	1.5m / 3.3-16.4 ft. (1-3.8m / 3.3-12.5ft.)*	1.5m / 3.3-16.4 ft.	0.35-2.25m / 1.2-13.1 ft.	0.7-4.5m / 2.3-14.4 ft.
f/11	1.5m / 3.3-16.4 ft. (1-2.7m / 3.3-8.8 ft.)*	1.5m / 3.3-16.4 ft.	0.25-1.6m / 0.8-5.3 ft.	0.5-3.3m / 1.6-10.9 ft.

*Values in parentheses for wireless/remote ratio control.

● The off-camera flash may not detect the control signals if it is placed behind the subject or if the AF illuminator is not pointing at the subject.

WIRELESS/REMOTE OFF-CAMERA FLASH CONTROL

WIRELESS/REMOTE RATIO CONTROL

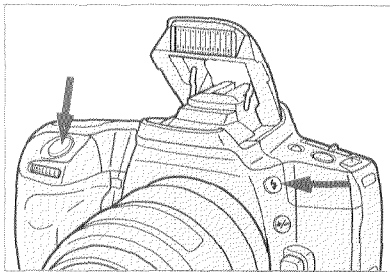

In remote/wireless mode when ratio control is selected, the output of the off-camera flash and built-in flash combine to provide a 2:1 lighting ratio. Press and hold the flash-control button, then press the shutter-release button all the way down to take the picture. The off-camera flash will provide 2/3 of the exposure and the built-in flash will add the remaining 1/3.

CANCELING WIRELESS/REMOTE FLASH MODE

- To cancel wireless/remote flash mode, attach the flash and press the flash-mode button.
- To cancel wireless/remote flash mode on the 3500xi separately from the camera, first turn the flash off. Then, press the ON/OFF button to turn the flash on and hold the button until the wireless lamp turns off.
- To cancel wireless/remote flash mode on other flash units, refer to your flash owner's manual.

ADDITIONAL FEATURES

SELF-TIMER

The self-timer will delay shutter release for 10 seconds, giving you time to get in the picture.

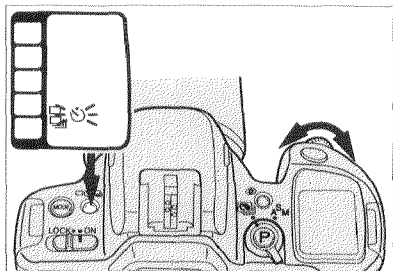

1. Press and hold the self-timer/
drive-mode button.

2. Turn the control dial until the self-
timer indicator  blinks.

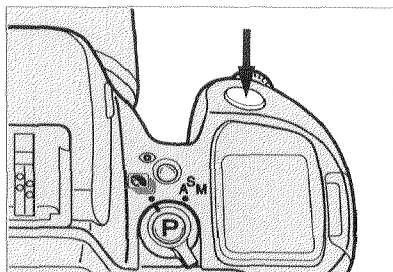

3. Compose your scene and press
the shutter-release button to start
the timer.

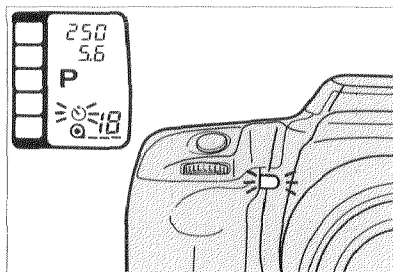

● The self-timer lamp on the front of
the camera will blink until the shut-
ter releases.

● After the picture is taken, the self-
timer is canceled.

● To cancel the self-timer at any
time, slide the main switch to LOCK.

PROGRAM RE-SET BUTTON

The program re-set button is a quick way for you to return the camera to Full-Auto Operation. Whether the Command switch is set to Subject Program mode or Creative Exposure mode, pressing the program re-set button will set the camera to the following:

FUNCTION	P-MODE SETTING
Exposure mode	P mode
Focus mode	Autofocus
Flash mode	Auto-on (if raised)
Exposure compensation	± 0
Film drive mode	single-frame advance
Self-timer	canceled
Wireless/Remote Flash	canceled

- Red-eye reduction and AF illuminator settings will not change.

CONTINUOUS FILM DRIVE

Your camera has both single-frame and continuous film advance. In continuous drive mode, the film advances at up to 1 frame per second as long as you press the shutter-release button. In addition, the camera checks and adjusts focus between each exposure so you can track moving subjects with ease.

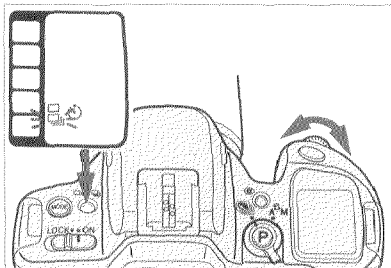

1. Press and hold the self-timer/
drive-mode button.

2. Turn the control dial until the con-
tinuous-drive indicator  blinks in
the data panel.

3. Focus on your subject and press the shutter-release button. The camera will continue to photograph and advance the film as long as you hold the shutter-release button down.

- Your camera has focus-priority shutter-release. This means it will not take a picture unless it can confirm focus. For this reason, the actual rate of advance will depend on the speed of your subject.
- If you use an AF Zoom xi lens or AF Power Zoom lens, you cannot zoom the lens while pressing the shutter-release button.

EXPOSURE COMPENSATION

This feature enables you to manually adjust the camera's meter reading up to ± 3 stops.

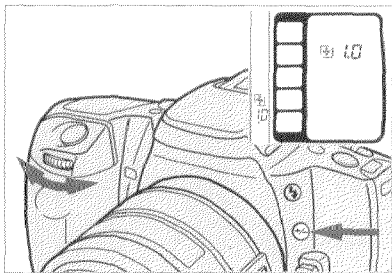

1. Press and hold the exposure-compensation button.

2. Turn the control dial until the exposure compensation value you want appears in the data panel.

● The numbers will change in increments of 0.5.

3. Release the exposure compensation button to enter the number.

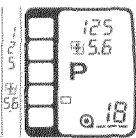

● The number will disappear, but $\frac{+}{-}$ or $\frac{-}{+}$ will remain in the data panels as a reminder that you have set exposure compensation.

● To cancel exposure compensation, perform the above procedure and select 0.0.

● In M mode, the metered "correct" exposure will be adjusted by the amount you select. In all other modes, including all Subject Programs, the camera will change the actual exposure automatically by the amount you select.

APPENDIX

CAMERA-SHAKE WARNINGS

When the shutter speed display and/or flash-on indicator blinks, refer to this table to determine the possible cause.

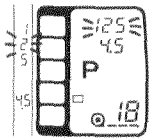
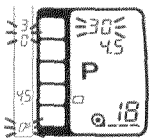
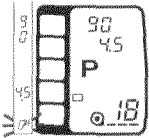
Mode	Display	Meaning	Solution
P or A	 The LCD display shows a vertical scale on the left with markings at 1/500, 1/250, 1/125, 1/60, 1/30, 1/15, 1/8, 1/4, and 1/2. The shutter speed is 1/25, which is below the 1/30 mark. The aperture is 4.5. The mode is P. A red warning icon (a square with a diagonal line) is visible. The battery level is 18%.	Shutter speed is too long for the focal length of the lens you are using; camera shake will effect the picture.	Use a tripod or steady the camera
P	 The LCD display shows a vertical scale on the left with markings at 1/500, 1/250, 1/125, 1/60, 1/30, 1/15, 1/8, 1/4, and 1/2. The shutter speed is 1/30, which is at the 1/30 mark. The aperture is 4.5. The mode is P. A red warning icon (a square with a diagonal line) is visible. The battery level is 18%.	Light level requires flash	Use flash
P	 The LCD display shows a vertical scale on the left with markings at 1/500, 1/250, 1/125, 1/60, 1/30, 1/15, 1/8, 1/4, and 1/2. The shutter speed is 1/30, which is at the 1/30 mark. The aperture is 4.5. The mode is P. A red warning icon (a square with a diagonal line) is visible. The battery level is 18%.	Subject is back-lit and flash is required	Use flash

EXPOSURE WARNINGS

When the shutter speed and/or aperture display blinks, refer to this table to determine the possible cause.

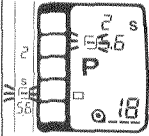
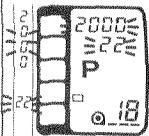
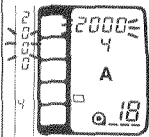
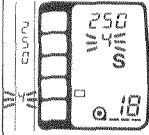
Mode	Display	Cause	Action
P / A / S / M		Scene or subject brightness is beyond the camera's metering range.	In bright light, attach a neutral-density (ND) filter, use slower film, or reduce the overall brightness of your surroundings. In low light, select M mode and use a hand-held meter, use faster film, or increase the brightness of your surroundings.
P		Light level is beyond the range of available shutter speeds and apertures.	
A		Required shutter speed beyond the range of the camera.	Select a larger/smaller aperture until the display stops blinking.
S		Required aperture beyond the range of the lens.	Select a faster/slower shutter speed until the display stops blinking.

TROUBLE-SHOOTING

Refer to this table to determine the cause of a problem with your camera. If the information here does not cover the problem you are experiencing, contact your nearest MINOLTA Service Facility.

PROBLEM	CAUSE	SOLUTION
No display in the data panel when the camera is switched on.	<ul style="list-style-type: none">● Battery exhausted	<ul style="list-style-type: none">● Install a fresh battery
-- appears in the data panel's aperture display.	<ul style="list-style-type: none">● Lens not attached correctly● Contacts on camera and/or lens are dirty	<ul style="list-style-type: none">● Attach the lens so that it locks in place with a click● Clean contacts with a clean, dry cloth
HELP displayed in the body data panel.	<ul style="list-style-type: none">● Winding motor problem	<ul style="list-style-type: none">● Remove and reinstall the battery.
Autofocus does not work or the lens does not focus when the shutter-release button is pressed.	<ul style="list-style-type: none">● Camera set to manual focus● Subject or situation difficult to autofocus● Subject is too close for the lens to focus	<ul style="list-style-type: none">● Set the camera to autofocus mode● Focus manually or use focus lock● Check the lens manual for the lens' minimum focus distance
Flash fires when shutter-release is pressed partway down	<ul style="list-style-type: none">● AF illuminator	<ul style="list-style-type: none">● Not a problem
Shutter locks	<ul style="list-style-type: none">● Camera cannot confirm focus● Camera is attached to telescope	<ul style="list-style-type: none">● Focus manually or lock focus● Contact the nearest Minolta Service Facility for information
Pictures taken with flash are dark or shadowed	<ul style="list-style-type: none">● Subject is outside flash range● Lens hood is attached to the lens● Lens is not suitable for use with built-in flash	<ul style="list-style-type: none">● Move closer to your subject (see p.45)● Do not use a lens hood with built-in flash● See p.44

CARING FOR YOUR CAMERA

PRECAUTIONS

- No part of the camera should be forced at any time.
- Do not use Polaroid instant film or infrared film with this camera.
- Never subject your camera to shock, high heat, humidity, water, or harmful chemicals. Do not leave it in the glove compartment or other places in motor vehicles where it may be subjected to high temperatures.
- Do not wipe the camera's lens mount with alcohol or benzene.
- Never lubricate any part of the camera body or lens.
- Never touch the shutter curtains, mirror, or camera interior or clean them with compressed air. Doing so may impair their alignment and movement.
- This camera is not waterproof, dust-proof or sand-proof. If you use this camera near water or at the beach, water-, dust-, or sand-damage may occur. Protect it at all time from moisture or splashes, especially saltwater spray, and be extremely careful to keep sand from both the interior and exterior of the camera and its accessories.
- If the camera is subjected to a sudden change in temperature, as when transferring it from a cold environment into a heated building, condensation may form inside. To prevent condensation, place the camera in a sealed plastic bag before transferring it from a cold place to a warm environment, and wait for it to come to room temperature before taking it out of the bag.
- The flashtube may become hot when the flash fires. Be sure to leave sufficient space around the flash tube during operation.
- The operating range for camera's data panel is from -20 to 50°C (-4 to 122°F). At temperatures outside this range, response time and contrast will change, making the display difficult to read. At very high temperatures, a display may temporarily darken. If this occurs, the display should return when the camera is restored to operating range conditions.
- This camera contains no user-serviceable parts. Do not attempt to disassemble or repair the camera yourself.
- This camera's circuitry may switch off, even when a battery with sufficient power is installed. To resume operation, remove and reinstall the battery.

CLEANING

- External camera surfaces and lens barrel — but not glass surfaces — can be cleaned by wiping with a dry or silicone-treated cloth. Never use organic solvents to clean the camera.
- Never touch the lens or eyepiece surfaces with your fingers. Whisk away loose matter with a blower brush. To remove stubborn spots, use a sheet of photographic lens tissue. If necessary, tissue may be moistened with one drop of lens-cleaning fluid; never place fluid directly on glass surfaces.
- We recommend that you have your camera cleaned once a year at an authorized MINOLTA Service Facility.
- If your camera comes in contact with water, wipe it with a clean, dry cloth and bring it to an authorized MINOLTA Service Facility. If it comes in contact with sand or if sand enters the camera, gently blow away loose particles — wiping may scratch the camera— and bring it to an authorized MINOLTA Service Facility.

STORAGE

- Always keep your camera in its case with the lens capped when not in use, or with a body cap on when a lens is not attached.
- If you plan to store your camera for an extended period of time, rewind and remove the film, then remove the battery. Place the camera in a cool, dry place away from dust or chemicals, preferably in an airtight container with a drying agent such as silica gel. Also, it is recommended that you periodically release the camera's shutter to maintain proper working condition.
- After prolonged storage, and especially before taking pictures at an important event, carefully check the operation of the camera and lens.

QUESTIONS AND SERVICE

- If you have questions about your camera, contact your local camera dealer. For more information, write to the MINOLTA distributor or subsidiary in your area (addresses listed on the back of this manual).
- To assure prompt service, please contact an authorized MINOLTA Service Facility before shipping your camera for repairs.

TECHNICAL DETAILS

Type: 35mm SLR with built-in flash and expert control of autofocus (AF) and autoexposure (AE)

Lens Mount: Minolta A-type bayonet mount

AF System: Minolta's through-the-lens (TTL) phase-detection system with one CCD sensor; activated by pressing the shutter-release button partway down; predictive focus control for moving subjects; AF sensitivity range: EV -1 to 18 (at ISO 100 in ambient light); built-in flash fires automatically when raised in low-light to aid focusing; AF illuminator range: 1-5m (based on Minolta's standard test methods); focus lock available; manual focus selectable

Metering: TTL-type; 8-segment honeycomb-pattern silicon photocell (SPC); automatically activated by pressing the shutter-release button partway down; second SPC for TTL flash metering of built-in flash or other dedicated flash unit; metering range: EV 1 - 20 (ISO 100, f/1.4 lens)

Exposure Modes: Programmed AE (P mode): Automatic control of aperture and shutter speed depending on lens specifications and scene characteristics; Subject Programs: portrait, landscape, close-up, sports, and night portrait shooting modes

Aperture-priority AE (A mode): Any available aperture in 0.5 EV increments; shutter speeds set from 1/2000 to 30 sec. automatically by autoexposure program

Shutter-priority AE (S mode): Any shutter speed from 1/2000 to 30 sec. selectable in 1 EV increments; aperture set automatically by autoexposure program

Manual (M mode): Any shutter speed/aperture combination selectable; correct and over-/under-exposure indicated in viewfinder; BULB setting also selectable

Built-In Flash: Guide number 12 (in meters at ISO 100); flash coverage for 28mm field of view; recycling time: Approx. 2 sec. (power supplied by camera); pre-flash for red-eye reduction and remote/wireless off-camera flash control available

TTL Flash Metering: Operates in all flash modes with built-in flash and dedicated flash unit; x-sync shutter speed automatically set when flash-on indicator appears in viewfinder; in Night Portrait mode slow shutter speed automatically set to balance background exposure with flash

Subject Program Modes, P and S Modes: Aperture and shutter speeds set automatically; built-in and attached accessory flash fires automatically when necessary, except Night Portrait and S mode (fires whenever activated)

A Mode: Any available aperture selectable; shutter speed automatically set to 1/90 sec.; built-in and attached accessory flash will fire when activated

M mode: Any shutter speed 1/90 or slower and any available aperture usable; built-in and attached accessory flash will fire when activated

Remote/wireless off-camera flash control: Built-in flash fires control code to trigger and stop specified accessory flashes; 2:1 flash ratio manually selectable; flash sync in remote/wireless mode: 1/45 sec.; flash sync in ratio control: 1/45 sec.; control range: 5m

Film-Speed Setting: Automatic setting for DX-coded films ISO 25 - 5000; Recommended range with flash: ISO 25 - 1000

Exposure Compensation: ± 3 EV (0.5 EV increments)

Shutter: Electronically-controlled, vertical-traverse, focal-plane type; Range: 1/2000 to 30 sec., bulb; flash sync: 1/90 sec. or slower

Film transport: Automatic with built-in motor drive; auto threading; auto advance to first frame; single-frame or continuous advance; automatic rewind or manual start of rewind; frame counter in body data panel

Viewfinder: Eye-level fixed pentaprism; field of view: 90%; magnification: 0.75 (with 50mm lens at infinity); -1 diopter

Self-Timer: Electronic with approx. 10-sec. delay; indication by blinking LED

Power: 6-volt 2CR5 lithium battery; Automatic battery check when camera is turned on; Battery condition indicated by four-stage indicator in body data panel

Dimensions: 147.5 x 92.5 x 66.5mm (5-13/16 x 3-5/8 x 2-5/8 in.)

Date model: 147.5 x 92.5 x 67.5mm (5-13/16 x 3-5/8 x 2-11/16 in.)

Weight (without lens and battery): 380g (13.4 oz.)

Date model: 385g (13.6 oz.)

Specifications and accessories are based on the latest information available at the time of printing and are subject to change without notice.

ACCESSORY INFORMATION

LENS

- All Minolta AF lenses can be used with this camera.
- Manual focus lenses (MD or MC) cannot be attached to the camera.

FLASH

- All Minolta i-, xi-, and HS-Series flash units can be used with this camera.
- To use an AF-Series flash unit, Flash Shoe Adapter FS-1100 must be attached to the camera. When the camera is set to P mode and the flash is on, the flash will fire each time you take the picture. At no time will the flash's AF illuminator activate.
- X-Series flashes cannot be used.

OTHERS

- Creative Expansion Cards cannot be used.
- Angle Finder and Magnifier cannot be used.

QUICK REFERENCE GUIDE

When you want to ...

Change camera's operating mode

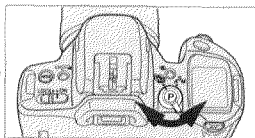

Re-set to Full-Auto mode

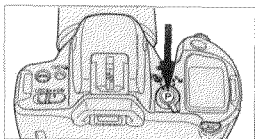

Select a Subject Program mode

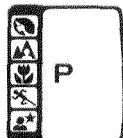
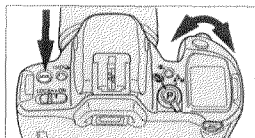
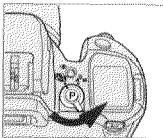

Select a Creative Exposure mode

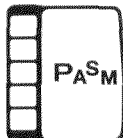
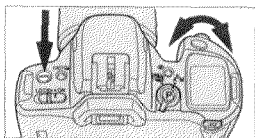
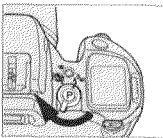

Lock focus

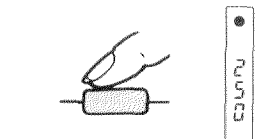
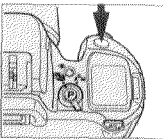

Focus manually

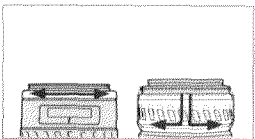
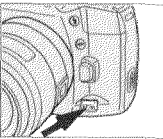

QUICK REFERENCE GUIDE

Set self-timer

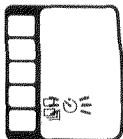
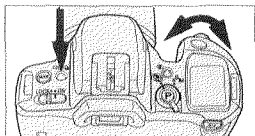

Rewind film

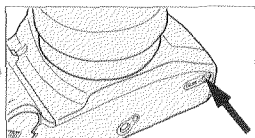

Check battery

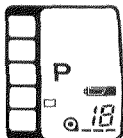
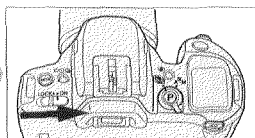

Change drive modes

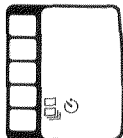
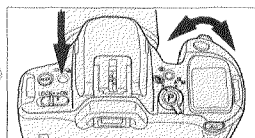

Fire flash manually in Full-Auto mode

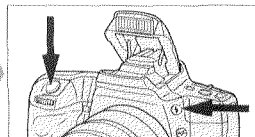

Set/cancel red-eye reduction

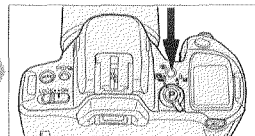

Set wireless/remote off-camera flash mode

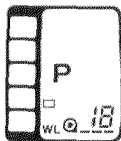
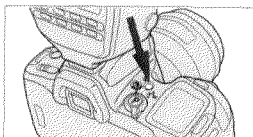

Change the shutter speed in S and M mode or aperture in A mode

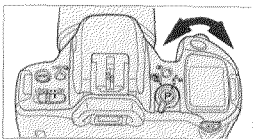

Change aperture in M mode

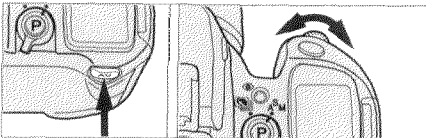

Set exposure compensation

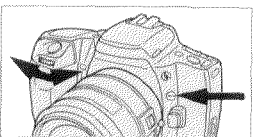

Turn AF illuminator on/off

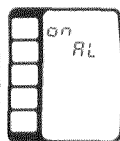
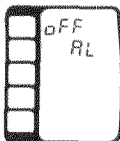
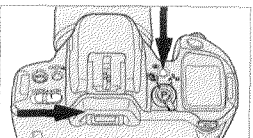

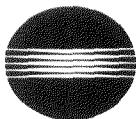

MINOLTA

Minolta Co., Ltd.	3-13, 2-Chome, Azuchi-Machi, Chuo-Ku, Osaka 541, Japan
Minolta GmbH	Kurt-Fischer-Strasse 50, D-22923 Ahrensburg, Germany
Minolta France S.A.	365, Route de Saint-Germain, F-78420 Carrières-Sur-Seine, France
Minolta (UK) Limited	Rooksley Park, Precedent Drive, Rooksley, Milton Keynes, MK13 8HF, England
Minolta Austria Ges. m.b.H.	Amalienstrasse 59-61, A-1131 Wien, Austria
Minolta Camera Benelux B.V.	Zonnebaan 39, P.O. Box 6000, NL-3600 HA Maarssen, The Netherlands
Belgium Branch	Kontichsesteenweg 38, B-2630 Aartselaar, Belgium
Minolta (Schweiz) AG	Riedstrasse 6 CH-8953 Dietlikon, Switzerland
Minolta Svenska AB	P.O. Box 9058, Albygatan 114, S-17109 Solna, Sweden
Finland Branch	Niittykatu 6 PL 37 SF-02201 Espoo, Finland
Minolta Portugal Limitada	Rua Afonso Lopes Vieira 55-B P-1700 Lisboa, Portugal
Minolta Corporation	
Head Office	101 Williams Drive, Ramsey, New Jersey 07446, U.S.A.
Los Angeles Branch	11150 Hope Street Cypress, CA 90630, U.S.A.
Minolta Canada Inc.	
Head Office	369 Britannia Road East, Mississauga, Ontario L4Z 2H5, Canada
Vancouver Branch	106-3850 Jacombs Road, Richmond, B.C. V6V 1Y6, Canada
Minolta Hong Kong Limited	Room 208, 2/F, Eastern Center, 1065 King's Road, Quarry Bay, Hong Kong
Minolta Singapore (Pte) Ltd.	10, Teban Gardens Crescent, Singapore 608923
Shanghai Minolta Optical Products Co., Ltd.	368 Minolta Road, Songjiang, Shanghai, China

© 1993 Minolta Co., Ltd. under the Berne Convention
and Universal Copyright Convention

9222-2092-41