

E INSTRUCTION MANUAL

DYNAX

300si

MAXXUM

300si

RZ330si

QUICK
OPERATION

BASIC
OPERATION

CAMERA
CONTROLS

SUBJECT
PROGRAM MODES

APPENDIX

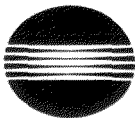

MINOLTA

Thank you for purchasing a Minolta camera and welcome to the wonderful world of autofocus SLR photography. Minolta is pleased to offer you one of the largest accessory lineups to suit your every need. Please take the time to read through this instruction manual for it contains information that is important to the use and care of your camera. Enjoy!

NAMES OF PARTS

Camera Body	2
Data Panel	4
Viewfinder	5

QUICK OPERATION	6
------------------------------	---

BASIC OPERATION

Standard Accessories	9
Installing the Battery	10
Checking the Battery Power	11
Attaching and Removing the Lens	12
Handling the Camera	13
Loading the Film	14
Taking Pictures in Program Mode	16
Rewinding the Film	18

CAMERA CONTROLS

Focusing	20
Special Focusing Situations	21
Focus Lock	22
Manual Focus	23
Built-In Flash	24

The information contained in this manual is relevant for products introduced before Dec., 1994. To obtain compatibility information for products introduced after this date, contact the authorized Minolta Service Facility nearest you.

Red-Eye Reduction	26
Self-Timer	27
Drive Mode Selection	28

SUBJECT PROGRAM MODES

Subject Program Selection	30
Portrait Mode	31
Landscape Mode	32
Close-Up Mode.....	33
Sports Mode	34
Night Portrait Mode.....	35

APPENDIX

Accessory Information	37
Optional Quartz Data Back Model	38
Optional Lens Kit	40
Accessory Flash Control.....	41
Wireless/Remote Flash	42
Trouble Shooting	45
Care and Storage	46
Technical Details	49
Quick Reference.....	51

NAMES OF PARTS

CAMERA BODY

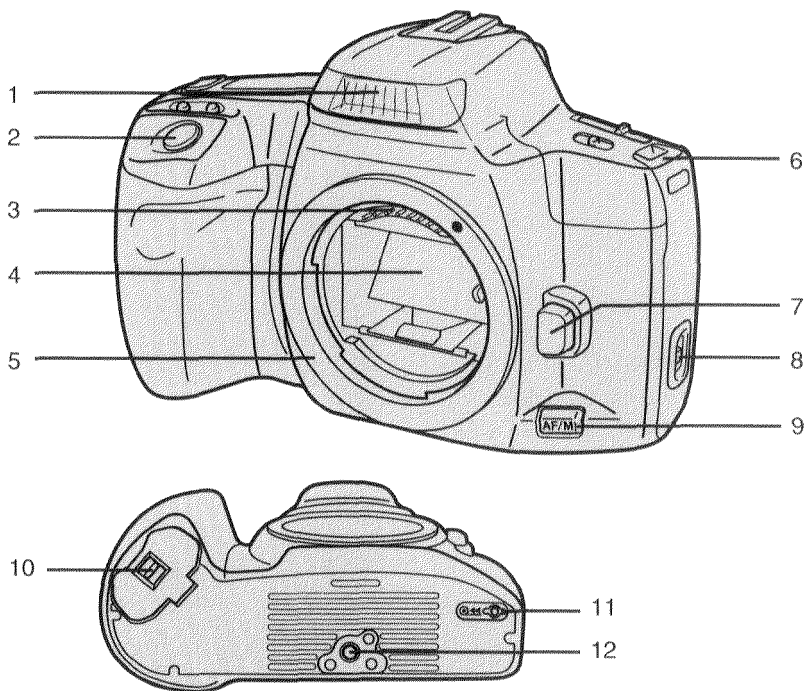

1. Built-in flash
2. Shutter-release button
3. Lens contacts*
4. Mirror*
5. Lens mount
6. Strap eyelet

7. Lens-release button
8. Back cover release
9. Focus-mode button
10. Battery cover
11. Rewind button
12. Tripod socket

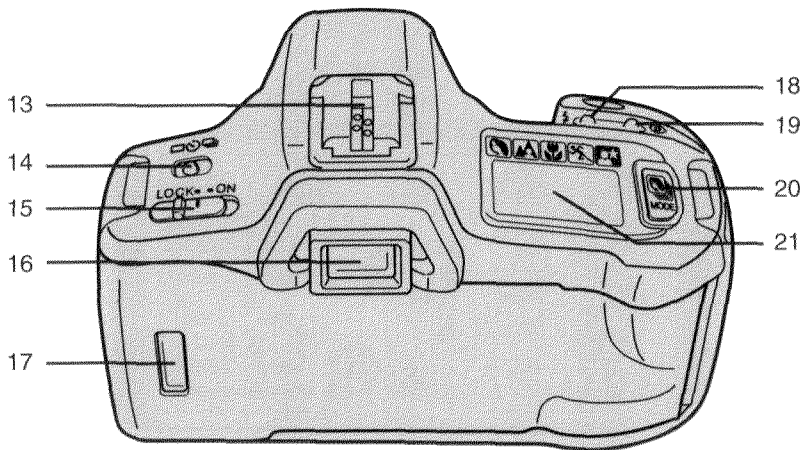

- 13. Accessory shoe
- 14. Drive-mode/self-timer button
 - Single frame
 - ⌚ Self-timer
 - 📷 Continuous frame
- 15. Main switch
- 16. Eyepiece*
- 17. Film window

- 18. Flash-mode button
 - ⚡ AUTO Flash automatic
 - ⚡ Flash always on
 - 🚫 Flash always off
- 19. Red-eye reduction button
- 20. Subject program selector
- 21. Data panel

* Do not touch

NAMES OF PARTS

DATA PANEL

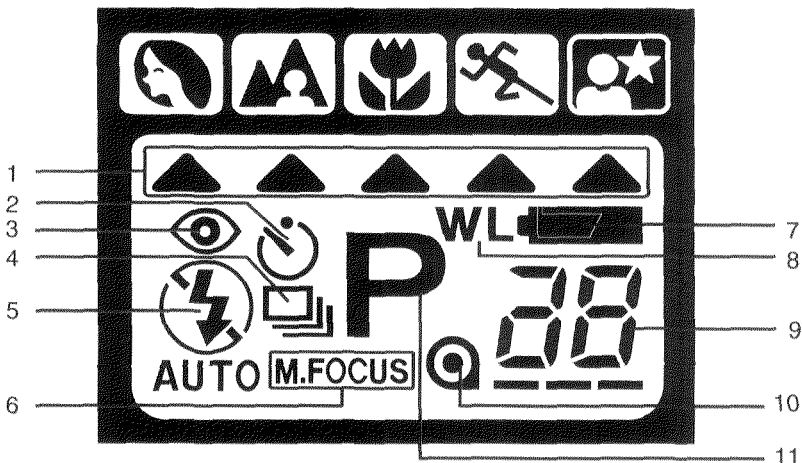

1. Subject program indicators



Portrait



Landscape



Close-up



Sports



Night Portrait

2. Self-timer indicator

3. Red-eye reduction indicator

4. Drive mode indicator

5. Flash-mode indicator

6. Manual focus indicator

7. Battery power indicator

8. Wireless/remote flash indicator

9. Frame counter

10. Cartridge indicator

11. Program mode indicator

VIEWFINDER

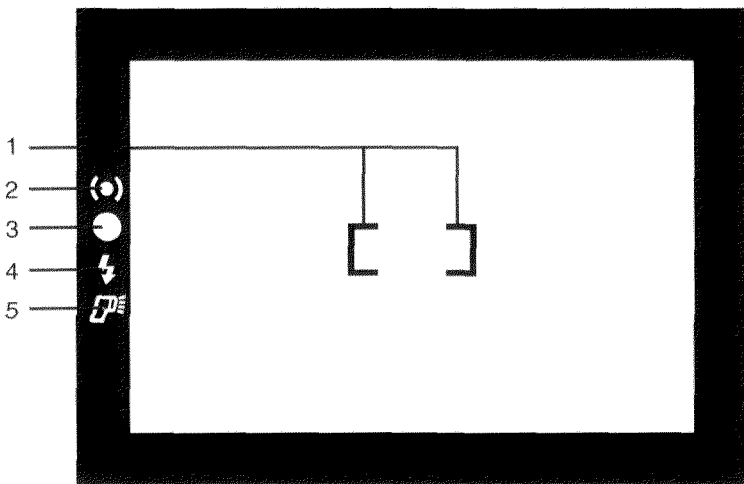

1. Focus frame
2. Continuous focus indicator
3. Focus lock indicator

4. Flash ready indicator
5. Flash on indicator

NOTE:

In this manual, glowing and blinking displays or indicators are identified as follows:



Glowing



Blinking

QUICK OPERATION

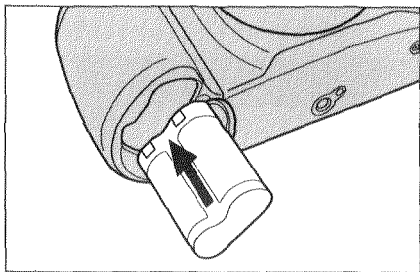

1. Insert battery

Insert one 6-volt 2CR5 lithium battery into the chamber as indicated by the + and - marks on the inside of the battery cover.

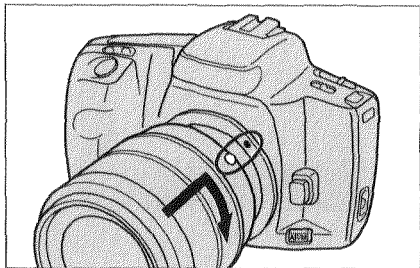

2. Attach lens

Align the red mounting index on the lens with the red mounting index on the camera. Gently insert the lens into the mount and turn it clockwise until it clicks into the locked position.

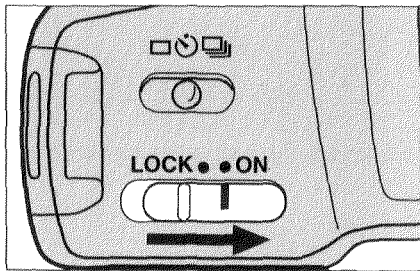

3. Turn on power

Turn the camera power on by sliding the main switch to ON.

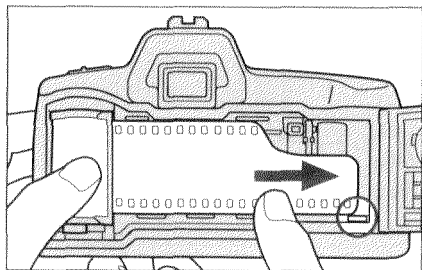

4. Load film

Insert the film and extend the film tip to the film leader index. Make sure the film is laying flat between the guide rails and close the back cover.



5. Focus on subject

Align the subject within the focus frame and press the shutter-release button partway down to activate autofocus. The focus lock indicator will glow when the subject is in focus.

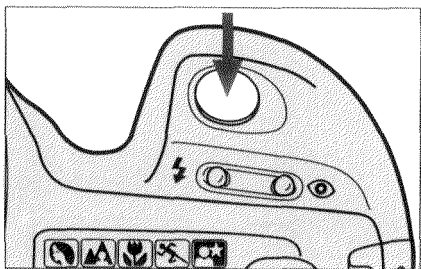

6. Take the picture

Gently press the shutter-release button all the way down to take the picture.

BASIC OPERATION

STANDARD ACCESSORIES

ATTACHING THE CAMERA STRAP

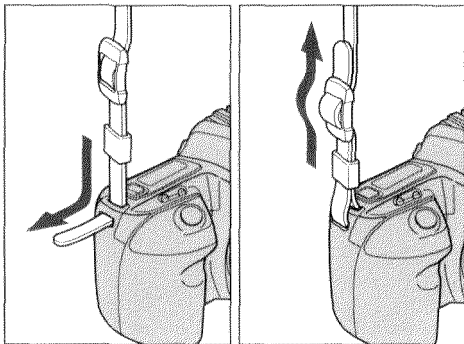

1. Undo the camera strap buckle and loop the strap through the eyelet of the camera.
2. Redo the camera strap buckle.
3. Repeat for the other side.

ATTACHING THE EYEPIECE CAP

When using the self-timer, attach the eyepiece cap to prevent stray light from entering the eyepiece and affecting the exposure.

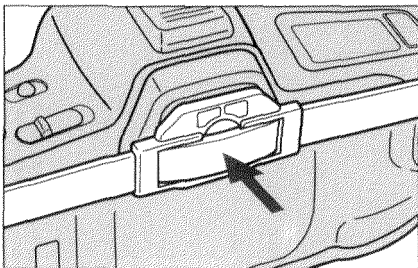

1. Align the eyepiece cap with the eyepiece.
2. Firmly press the cap until it snaps into the eyepiece.

INSERTING THE BATTERY

Your camera uses one 6-volt 2CR5 lithium battery which supplies power for all camera operations. Please read all warnings in the Care and Storage section of this manual as well as those supplied by the battery manufacturer.

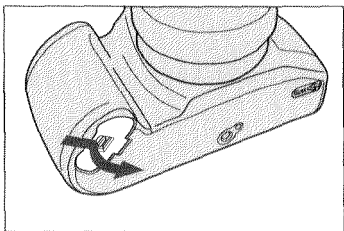

1. Open the battery chamber cover by pushing the cover release in the direction of the arrow.

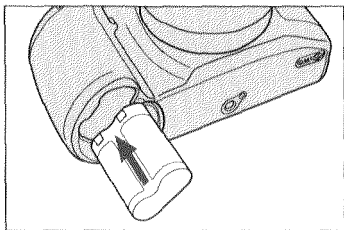

2. Insert the battery into the chamber as indicated by the + and - marks inside the battery cover.
3. Close the cover until it clicks and locks closed.

CHECKING THE BATTERY POWER

Your camera is equipped with a automatic battery power indicator. Each time the main switch is turned ON a symbol will appear in the data panel to indicate the power status of the battery. It is recommended that you always carry a spare battery in your camera bag.

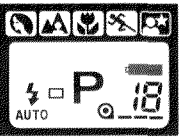
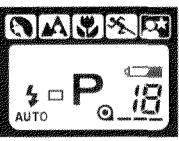
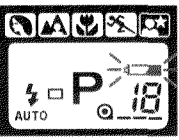
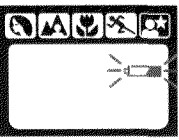
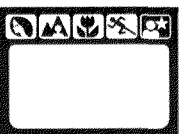
	<p>Full-battery symbol - power is sufficient for all camera operations.</p>
	<p>Low-battery symbol - power is sufficient for all camera operations, but is getting low. Keep new battery handy.</p>
	<p>Blinking low-battery symbol appears - power is extremely low but all functions are operational. Battery will have to be replaced very soon. Flash recycling time may be slow.</p>
	<p>Blinking low-battery symbol appears by itself and the shutter locks - power is insufficient for camera operation. Replace the battery immediately.</p>
	<p>No data appears in the data panel. Replace the battery or check that it is inserted correctly.</p>

ATTACHING THE LENS

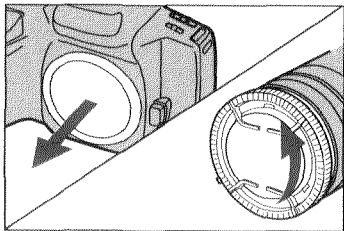

1. Remove the camera body cap and rear lens cap as shown.

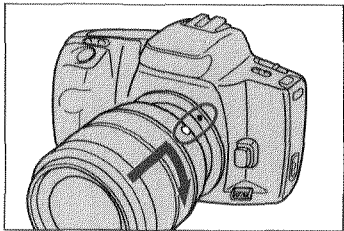

2. Align the red mounting index on the lens with the red mounting index on the camera.

3. Gently insert the lens into the mount and turn it clockwise until it clicks into the locked position.

REMOVING THE LENS

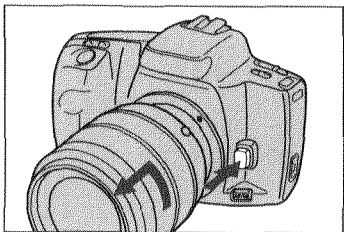

1. Press the lens-release button and hold it while turning the lens counter-clockwise until it stops.

2. Gently remove the lens from the mount and replace caps or immediately attach another lens.

Caution

- Do not force the lens if it does not turn smoothly.
- Do not touch the inside of the camera, especially the lens contacts and mirror.
- Do not attach the lens at an angle.

HANDLING THE CAMERA

HOLDING THE CAMERA

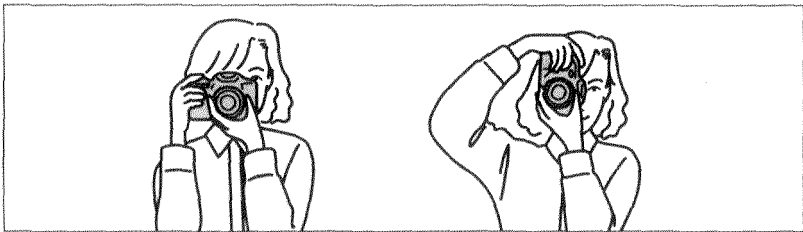

Hold the camera grip firmly with your right hand while supporting the camera or lens with your left hand. Make sure that your fingers are not blocking any of the camera's features; they should fit securely around the grip. To hold the camera steady, always keep your elbows at your side and your feet shoulder-width apart for support. Always keep the camera strap around your neck or wrist in the event that you accidentally drop it.

PRESSING THE SHUTTER-RELEASE BUTTON

The shutter-release button has three positions. To activate the camera's autofocus and autoexposure systems press the shutter-release button part way down. To take the picture, gently (never with a quick jab) press the shutter-release button all the way down.

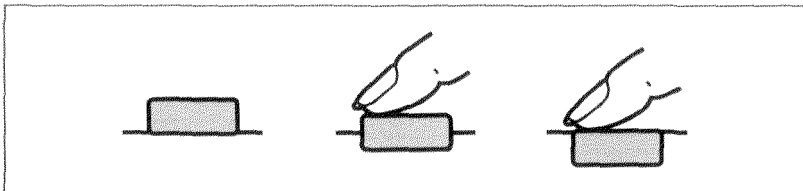

LOADING THE FILM

This camera is equipped with an automatic film transport system which automatically loads the film, sets the film speed, and advances the film after each exposure. **Before you open the back cover**, make sure that there is not a roll of film already in the camera. Always load and unload film in subdued light.

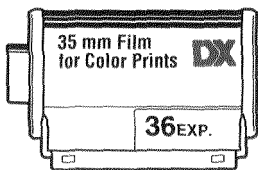

Use DX-coded negative or positive films, ISO 25 - 5000 for regular photographs or ISO 25 - 1000 for flash photographs. The camera will automatically set the proper film speed for the film you are using.

- Non-DX-coded film will be set to a film speed of 100.
- Do not use Polaroid instant film or infrared film with this camera.

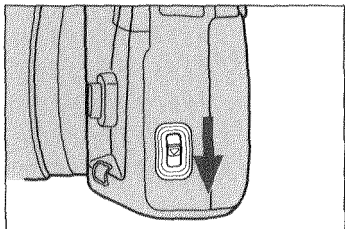

1. Slide the back-cover release down and open the back cover.

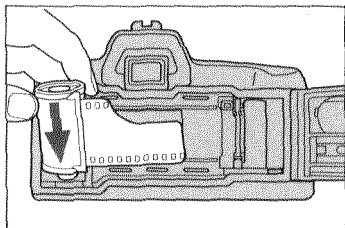

2. Place the film cartridge in the chamber making sure that it is seated properly.

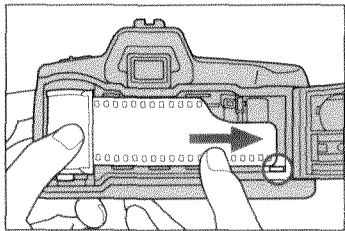

3. Extend the film tip to the film leader index making sure that it lays flat between the film guide rails.

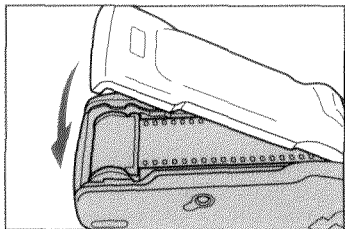
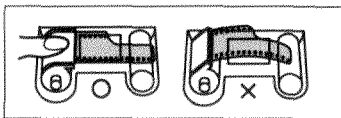

4. Close the back cover.

5. Slide the main switch ON. The film will automatically advance to the first frame.

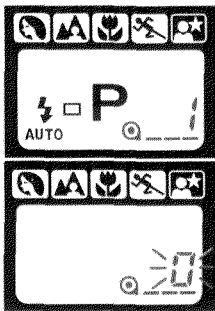

If the film has been loaded correctly, 1 will appear in the frame counter.

If the film has been loaded incorrectly, the cartridge indicator will appear and 0 will blink in the frame counter. Open the back cover and repeat the loading procedure.

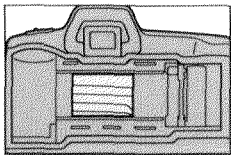

NEVER TOUCH THE SHUTTER CURTAIN WITH YOUR FINGERS OR FILM TIP.

Its precision design makes it extremely sensitive to pressure.

TAKING PICTURES IN PROGRAM MODE

Program mode is the camera's standard operating mode and is suited for use in virtually any situation. When the camera power is switched ON the camera is set to program mode and all functions will operate automatically. If desired, you may choose to use any one of this camera's many functions, please refer to the Camera Control Section of this manual for more information on the camera's features.

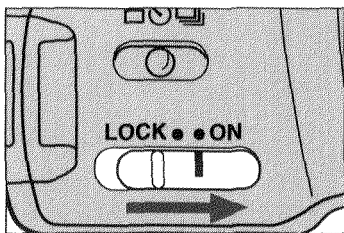

1. Slide the main switch to ON.

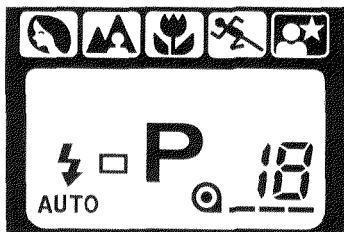

2. The camera is set to full-auto operation.

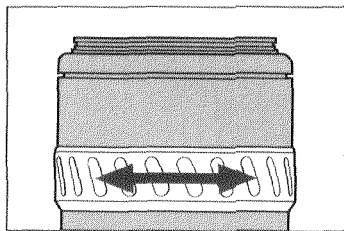

3. Rotate the zooming ring on the lens to frame your subject as desired.



4. Align your subject within the focus frame and press the shutter-release button partway down to activate autofocus. The focus lock indicator will glow when the subject is in focus.

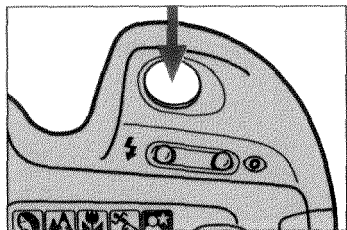

5. Press the shutter-release button all the way down to take the picture.

REWINDING THE FILM

This camera will automatically rewind the film after the last frame has been exposed. If rewinding stops before the film has been completely rewound, **DO NOT OPEN THE BACK COVER**, insert a fresh battery and wait for rewinding to finish. 0 will appear in the frame counter when the film is completely rewound.

REMOVING THE FILM

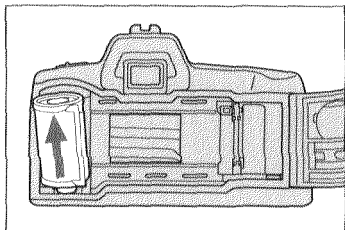

1. Wait for the film to rewind completely.
2. Open the back cover and remove the film as shown.

STARTING MANUAL REWIND

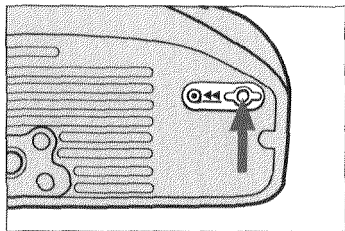

1. Slide the main switch to ON.
2. Gently press the rewind button.

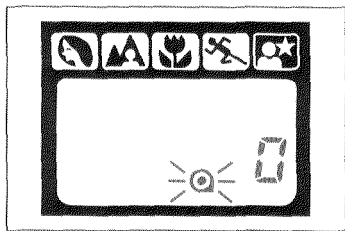

3. Wait for the film to rewind completely; 0 will appear in the frame counter and the cartridge indicator will blink.
4. Remove the film.

CAMERA CONTROLS

FOCUSING

This camera is set to autofocus (AF) mode each time the camera is switched ON. Pressing the shutter-release button partway down will activate the autofocus system and one of the signals below will appear in the viewfinder. In autofocus mode, the shutter will not release until focus is confirmed. When focusing the lens manually, only the first symbol will appear and the shutter will release even if the subject is not in focus.

FOCUS SIGNALS



The focus lock indicator will glow when focus is confirmed and locked.



The focus lock indicator will blink when focus cannot be confirmed. Your subject is too close or is one of the special focusing situations described on the next page.



The continuous focus indicator will glow when the camera is focusing on your subject or when it is tracking a moving subject.

AF ILLUMINATOR

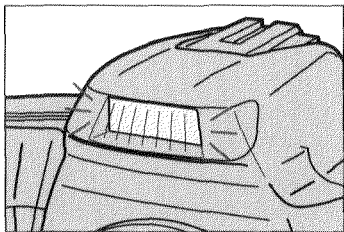

This camera is equipped with a AF illuminator which automatically fires a short series of flash bursts which provides the camera with the light necessary to focus even in complete darkness.

- The AF illuminator will not function if the built-in flash is off, or if the camera is in sports mode.
- The range of the AF illuminator is approximately 1 - 5m (3.3 - 16ft).

SPECIAL FOCUSING SITUATIONS

In the situations described below or similar situations, it may be difficult or impossible for the camera to focus accurately. In such situations, you should use focus lock or manual focus which are described on the following pages.

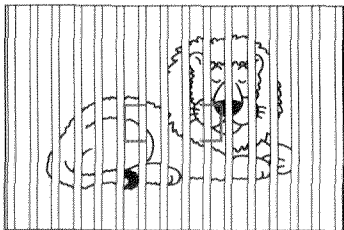

If two subjects at different distances overlap within the focus frame.

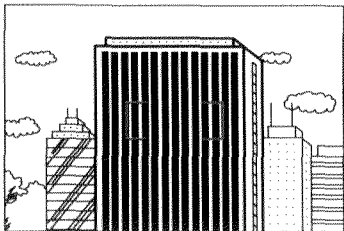

If a subject composed of alternating light and dark lines completely fills the focus frame.

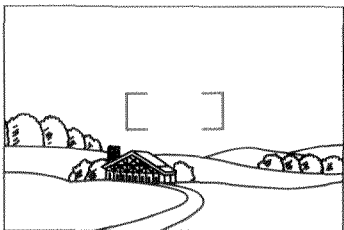

If the subject within the focus frame is very bright or low-contrast.

FOCUS LOCK

Focus lock should be used when you want to take a picture with your subject outside the focus frame or in situations where autofocus is difficult to confirm. Focus lock cannot be used with moving subjects.



1. Place your subject within the focus frame and press the shutter-release button partway down. The focus lock indicator will glow when focus is locked.



2. Continue to hold the shutter-release button partway down while you recompose your picture as desired.

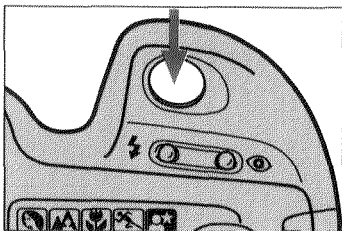

3. Press the shutter-release button all the way down to take the picture.

MANUAL FOCUS

In situations where the autofocus system is not suitable and focus lock is not possible, you may focus the lens manually. The autofocus system will continue to monitor focus and will indicate when the subject within the focus frame is in focus.

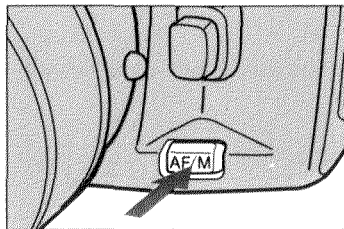

1. Press the focus-mode button so that the manual focus indicator **M.FOCUS** appears in the data display.

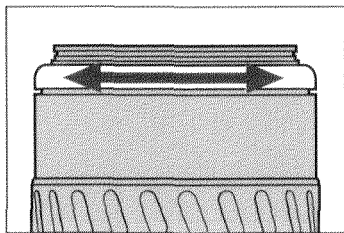

2. Look through the viewfinder and turn the lens focusing ring until your subject appears clear and sharp.

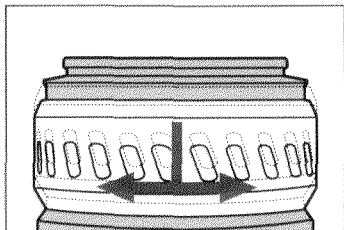

- If you are using an xi-series or power zoom lens, pull the control ring towards you and then rotate it in either direction to focus.

BUILT-IN FLASH

This camera is equipped with a built-in flash which provides coverage for focal lengths as short as 28mm. The flash output is controlled automatically by the camera using a TTL (through the lens) flash metering system.

FLASH SIGNALS



The flash on indicator will glow when the built-in or accessory flash is on and charging.



The flash ready indicator will glow when the flash is fully charged and ready to fire.



The flash ready indicator will blink after taking a picture to confirm that the flash output was sufficient for a correct exposure.

FLASH MODES



When set to AUTO mode, the flash will fire when the light level is too low or the subject is backlit.



When set to ON mode, the flash will fire every time. This is useful for manual fill-flash during the day when the auto flash would not normally fire.



When set to OFF mode, the flash will not fire. This is useful in situations where flash is not desired or not allowed.

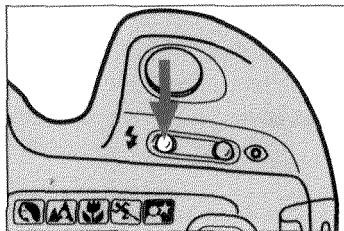

SELECTING A FLASH MODE

Repeatedly press the flash mode button until the desired flash mode is indicated in the data panel.

FLASH RANGE

The range of the built-in flash varies depending on the speed of the film and the maximum aperture of the lens being used, please take note to the working range of the built-in flash.

APERTURE	ISO 100	ISO 400
f/2.8	1-4.2m (3.3-13.8ft)	1-8.4m (3.3-27.5ft)
f/4	1-3m (3.3-9.8ft)	1-6m (3.3-19.7ft)
f/5.6	1-2.1m (3.3-6.9ft)	1-4.2m (3.3-13.8ft)

PRECAUTIONS FOR USING THE BUILT-IN FLASH

Lens shadowing may occur in the bottom of your pictures when using the built-in flash with certain Minolta AF lenses. To reduce the chance of shadowing, never use a lens wider than 28mm, never use a lens hood, and do not photograph closer than 1m (3.3 ft). The following lenses may cause shadowing:

- AF 28 - 85mm f/3.5-4.5
- AF 28 - 135mm f/4-4.5
- AF 80 - 200mm f/2.8 APO
- AF 28 - 105mm f/3.5-4.5
- AF 35 - 200mm xi f/4.5-5.6

Built-in flash should not be used with the following lenses:

- AF 28 - 70mm f/2.8
- AF 300mm f/2.8 APO TELE
- AF 600mm f/4 APO TELE
- AF 300mm f/4 APO TELE

RED-EYE REDUCTION

When photographing people or animals at night or in low-light situations, the effect called "Red-eye" may occur due to the flash reflecting off the inside of the subject's eyes. To reduce this effect and produce more natural and beautiful pictures, use the red-eye reduction mode with the built-in flash.

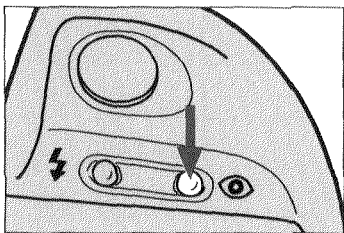

1. Press the Red-eye reduction button so that the red-eye reduction indicator  appears in the data panel.

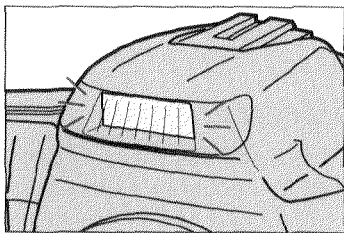

2. Warn your subject that the flash will fire a series of short flash bursts just before the picture is taken.

SELF-TIMER

The self-timer will delay the shutter-release for 10 seconds after the shutter-release button is pressed all-the-way down, this allows you time to get in the picture.

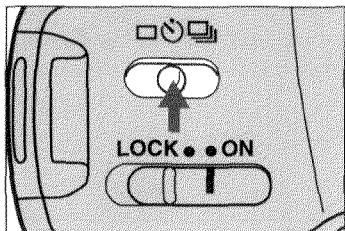

1. Press the drive-mode/self-timer button until the self-timer symbol ☹ appears in the data panel.

2. Compose the picture.

- If your subject is off center, use focus lock (p. 22) to focus on your subject.

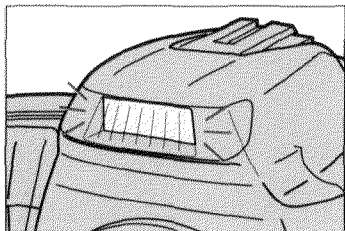

3. Press the shutter-release button all the way down to activate the self-timer. The flash will fire three short bursts just before the picture is taken unless the flash is off. The self-timer mode will automatically cancel after the exposure is made.

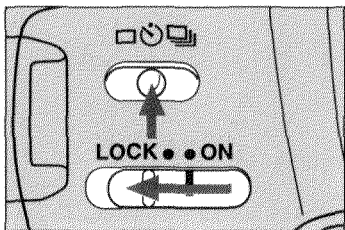

To cancel self-timer once it has been activated, slide the main switch to LOCK or press the drive-mode/self-timer button again.

- If you are not looking through the viewfinder when you press the shutter-release button, attach the eyepiece cap (p. 9) to prevent light from entering through the eyepiece and affecting the exposure reading.

DRIVE MODE SELECTION

Your camera has both single-frame and continuous-frame advance. In single-frame mode, the camera takes one exposure and automatically advances the film for the next exposure. In continuous film advance, the camera continues to take photographs up to one frame per second for as long as the shutter-release button is pressed all the way down. When using this mode with moving subjects the camera continues to make focus adjustments between exposures so actual frame rate will vary depending on the speed of the subject.

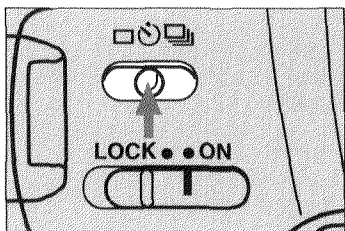

Repeatedly press the drive-mode/self-timer button until the desired drive-mode appears in the display panel.

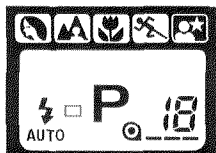

Single-frame drive

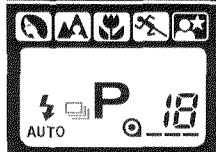

Continuous-frame drive

SUBJECT PROGRAM MODES

SUBJECT PROGRAM SELECTION

Subject program selection allows you to choose five different subject program modes: Portrait, Landscape, Close-up, Sports and Night Portrait. These program modes allow you to tell the camera what type of picture you will be taking so that it may customize the exposure settings for that type of picture.

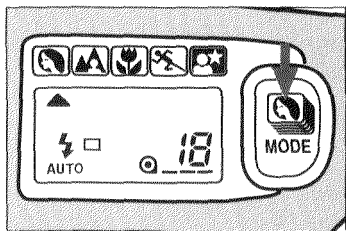

Press the subject program selector repeatedly until the desired subject program mode is indicated in the data panel.



Portrait Mode

Portrait photography



Landscape Mode

Scenic and Travel photography



Close-up Mode

Macro photography



Sports Mode

Sports and Action photography



Night Portrait Mode

Night Portrait and Night Scene photography



PORTRAIT MODE

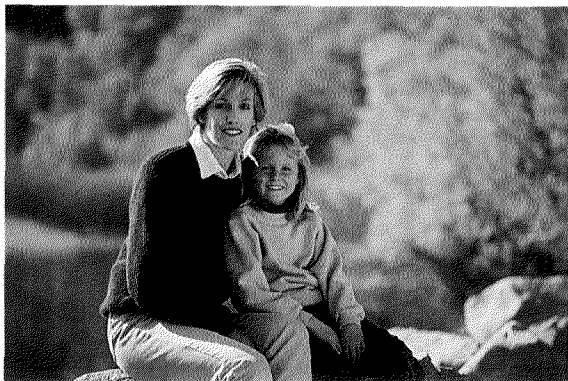

Portrait mode is best suited for photographing people. Portrait photography benefits from a shallow depth of field (the distance in front and behind your subject which will appear in focus) which isolates the person from the background. In portrait mode the camera will adjust its settings to obtain this effect leaving you free to compose the picture and capture the perfect expression.

Lens Tips:

Use a mid-telephoto lens with a large aperture for best results.

Flash Tips:

Use flash when your subject is backlit or when there are strong shadows across the face.

Additional Tips:

Lock focus on your subject's eyes and be ready to capture the perfect expression.



LANDSCAPE MODE

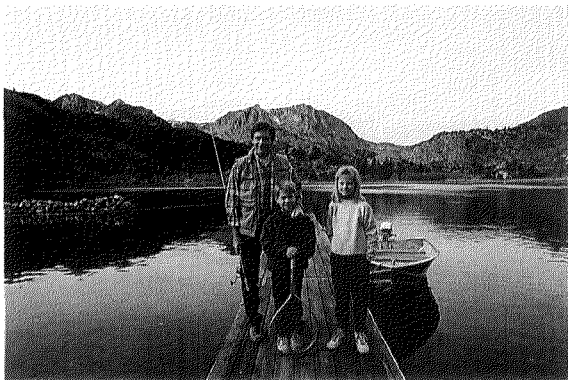

Landscape mode is suited for photographing landscape, scenic or travel photographs. Landscape photography generally requires a large depth of field to make sure that everything is in focus. In Landscape mode the camera is automatically set to the smallest aperture possible while maintaining a shutter speed fast enough to prevent blur due to camera shake.

Lens Tips:

Use wide-angle lenses to create a feeling of depth in your picture.

Flash Tips:

Flash is only needed when there is a person in your photograph who is backlit or has strong shadows across the face.

Additional Tips:

Use a tripod to get sharp pictures, especially at slower shutter-speeds.



CLOSE-UP MODE



Close-up mode is best suited for photographing small subjects such as flowers at close distances. Close-up photography requires accurate focusing, so it is recommended that you use focus lock or manual focus to make sure that main part of your subject is in sharp focus. In Close-up mode the camera will automatically set the best possible aperture and shutter speed for your subject.

Lens Tips:

Use one of Minolta's macro lenses or a macro-capable zoom lens.

Flash Tips:

Use the Macro Flash 1200AF Set.

Additional Tips:

Accurate focus is very important, make sure that you focus on the main part of your subject. Use a tripod and the self-timer to reduce camera shake.



SPORTS MODE

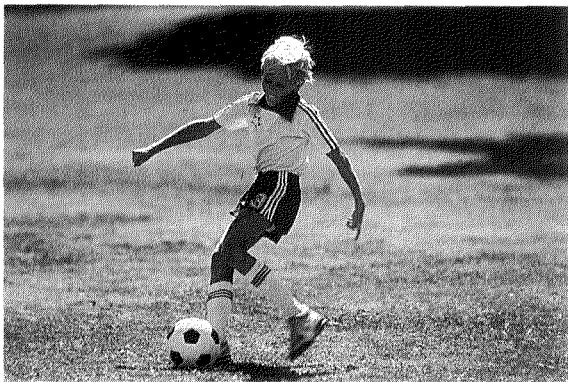

Sports mode is suited for photographing fast action events which require a fast shutter speed to stop the action. In Sports mode the camera automatically sets the fastest possible shutter speed and continuously adjusts the focus to track fast-moving subjects.

Lens Tips:

Use large aperture telephoto lenses which allow the camera to select faster shutter-speeds.

Flash Tips:

Using flash will only help if your subject is within the flash range. Powerful accessory flashes have longer ranges.

Additional Tips:

Use fast film (ISO 400 or higher) and keep the focus frame on your subject.



NIGHT PORTRAIT MODE

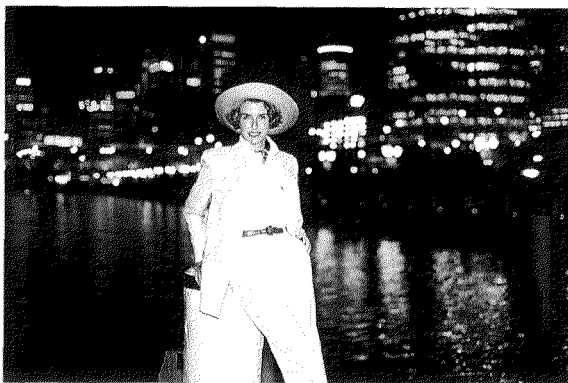

Night Portrait mode is suited for portraits and scenic photography at night. Nighttime photography requires the camera to balance the camera's flash with the background. In this mode, the camera uses the largest aperture possible with a longer shutter speed which allows the background to appear in the photograph.

Lens Tips:

Lenses with larger apertures allow more background light in your picture.

Flash Tips:

Use flash when your subject is in front of your night scene. Flash is not needed if you are only photographing a night scene.

Additional Tips:

Focus on the main part of your subject and use a tripod.

APPENDIX

ACCESSORY INFORMATION

This camera is designed to work specifically with lenses, flash units, and other accessories manufactured and distributed by Minolta. We therefore caution that using incompatible accessories with this camera may result in unsatisfactory performance or damage to the camera and accessories.

LENSES

- All Minolta AF lenses can be used with this camera.
- Manual focus lenses (MD or MC) cannot be attached to this camera.

Macro AF3X-1X Zoom lens:

- Before attaching the lens to the camera, set any lens' magnification other than 1X.

FLASHES

- All Minolta i-, xi-, and HS-Series flash units can be used with this camera.
- To use an AF-Series flash unit, Flash Shoe Adapter FS-1100 must be attached to the camera. When the flash is on, the flash will fire each time you take a picture. At no time will the flash's AF illuminator activate.
- X-Series flash units cannot be used.

OTHER ACCESSORIES

- Creative Expansion Cards cannot be used.
- Angle Finder and Magnifier cannot be used.
- Close-up Diffuser CD-1000 cannot be used.

OPTIONAL QUARTZ DATA BACK MODEL

For the owner of the Quartz Data Model, this camera is equipped with a Quartz Data Back which automatically imprints the date or time in the lower-right corner of the picture as a record of when the picture was taken. The bar in the quartz data back data panel will flash for 2 seconds after the picture is taken to indicate that the data was imprinted. The calendar and quartz-controlled clock may be switched off when imprinting is not desired.

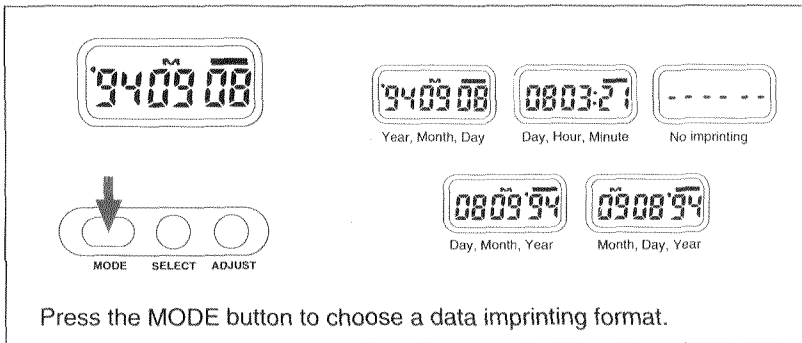

SETTING DATA

1. Press the **MODE** button to choose either Date or Time mode. M will appear above the month.
2. Use the **SELECT** button to move between different parts of the displayed data. The selected part will blink indicating it is the data to be changed.
3. Press the **ADJUST** button to change the data to the correct value. The data will continue to change if the **ADJUST** button is held down. In time mode, pressing the adjust button while the colon (:) is blinking will reset the seconds counter to 00. The seconds do not appear in the display.
4. When all data is correct, press the **SELECT** button until the data stops blinking.

REPLACING THE QUARTZ DATA BACK BATTERY

The data back uses a 3-volt lithium battery (CR2025). Change the battery when the imprinted data or data panel become dim.

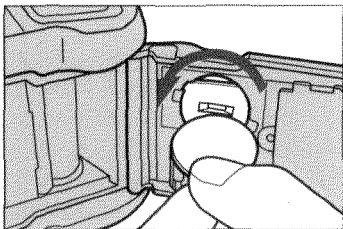

1. Open the back cover by pressing the back cover release down.

2. Using a coin or screwdriver, remove the battery cover by turning counter-clockwise as shown.

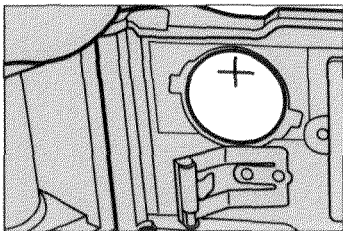

3. Remove the old battery and replace it with a new one; making sure that the + indicator is facing upward.

4. Replace the battery cover by turning clockwise. The time and date will have to be reset.

CAUTION:

- Imprinted data may be difficult to read if the printing area is bright, orange, or not uniform.
- Make sure there is no film in the camera before opening the back cover.
- Keep batteries away from children.
- Do not touch any other parts inside the camera other than the data back battery cover.
- Do not use the data back when temperatures exceed the operating temperature range of 0° - 50°C (32° - 122°F).

OPTIONAL LENS KIT (35-70mm f/3.5-4.5)

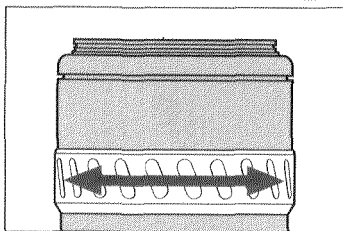

Manual Zoom

Rotate the zooming ring clockwise or counter-clockwise to adjust the lens to the desired focal length for your picture.

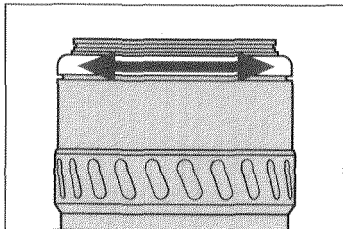

Manual Focus

Rotate the focusing ring clockwise or counter-clockwise to focus on the subject. The focus lock indicator will glow when the subject, within the focus frame, is in focus.

AF 35-70mm LENS SPECIFICATIONS

Construction:	7 element, 7 groups
Aperture:	min: 22-27 max: 3.5-4.5
Focal length:	35-70mm
Zoom angle:	63 - 34 degrees
Min. focus distance:	0.5m at all focal lengths
Max. magnification:	0.15x (70mm, 0.5m)
Filter diameter:	49mm
Dimensions:	68.5mm x 63mm
Weight:	210g

Specifications are based on the latest information available at the time of printing and are subject to change without notice.

ACCESSORY FLASH CONTROL

When using an accessory flash with your camera you may select any of the three flash modes: ON, OFF, AUTO as well as wireless flash. Please read the following instructions for selecting accessory flash modes:

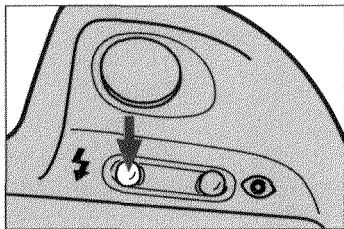

Using the Camera

Press the camera flash-mode button to select the desired mode: ON, OFF, AUTO.

- All information is transferred directly to accessory flash.

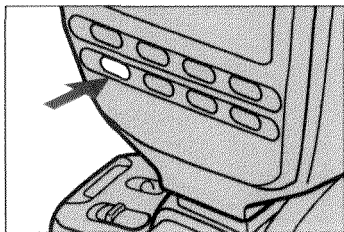

Using the Flash

Press the flash ON/OFF button to select the desired mode: OFF, AUTO.

- ON mode may only be selected by the camera flash-mode button.
- Flash data is not transferred to the camera until the shutter-release button is pressed part-way down.

Note:

If you are using an AF-Series accessory flash unit and wish to cancel the flash, you must turn off both the accessory flash ON/OFF switch and built-in flash-mode button. The camera's flash-mode button cannot control the AF-Series accessory flash unit as it does with the newer accessory flash series.

WIRELESS/REMOTE FLASH

Wireless/Remote flash allows you to experiment with accessory flashes to create beautiful, unique, and exciting images without the hassle of accessory cords and adapters. Simply position the flash almost anywhere you want and the camera will do the rest. The camera's built-in flash sends out a coded flash burst that triggers the accessory flash to fire. When the proper exposure is reached another coded flash burst turns the accessory flash off.

USING WIRELESS/REMOTE FLASH

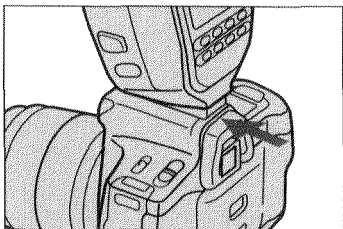

1. Attach the accessory flash (5400HS, 5400xi, or 3500xi) to the camera and turn both the flash and camera on.

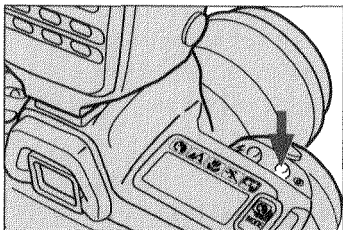

2. Press the red-eye reduction button - **WL** will appear in the data panel and the flash is now set for wireless /remote flash.

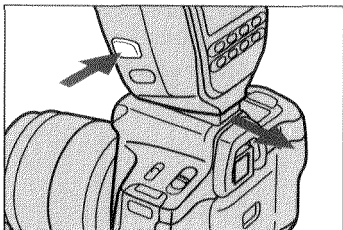

3. Remove the accessory flash. It is now ready to be positioned.

Use the information on this page to position your camera and 3500xi flash unit. If you are using a flash unit other than the 3500xi, refer to that flash manual. The camera to subject distance and the accessory flash unit to subject distance will vary depending on the speed of the film and the maximum aperture of the lens being used.

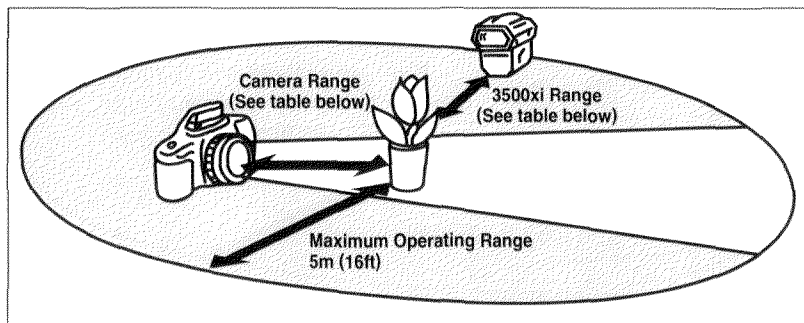

f#	CAMERA-SUBJECT DISTANCE m/ft		3500xi-SUBJECT DISTANCE m/ft	
	ISO 100	ISO 400	ISO 100	ISO 400
f/2.8	1.4-5m/4.6-16.4ft	2.8-5m/9.2-16.4ft	1-5m/3.3-16.4ft	2-5m/6.6-16.4ft
f/4	1-5m/3.3-16.4ft	2-5m/6.6-16.4ft	0.7-4.5m/2.3-14.4ft	1.4-5m/4.6-16.4ft
f/5.6	1-5m/3.3-16.4ft	1.4-5m/4.6-16.4ft	0.5-3.2m/1.6-10.6ft	1-5m/3.3-16.4ft

- The off-camera flash unit may not detect the control signals if it is behind the subject or if the AF illuminator is not pointing at the subject.

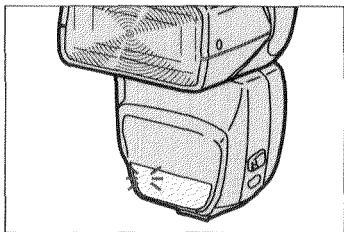

4. Wait for both the flashes to charge.
- The accessory flash's AF illuminator will blink when the flash is fully charged.

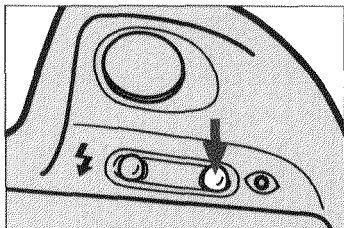

5. Press the red-eye reduction button to test fire the accessory flash. Again, wait for both flashes to charge.

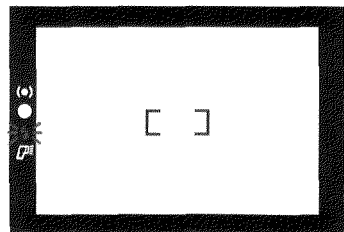

6. Press the shutter-release button all-the-way down to take the picture.
- The flash ready indicator will blink to confirm that the flash was sufficient for proper exposure.

CANCELLING WIRELESS/REMOTE FLASH

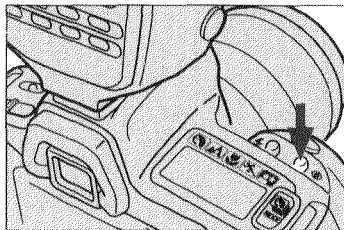

Reattach the accessory flash to the camera and press the red-eye reduction button. The **WL** symbol will disappear and wireless/remote flash is cancelled.

TROUBLE SHOOTING

Refer to this table to determine the cause of a problem you are experiencing with your camera. If the information does not cover the problem which you are experiencing or the condition continues, contact your nearest Minolta Service Facility.

PROBLEM	CAUSE	SOLUTION
Data panel indicators blink and/or camera does not function	<ul style="list-style-type: none">• Camera operation malfunction	<ul style="list-style-type: none">• Remove and reinstall the battery
No display in the data panel when the camera is switched ON	<ul style="list-style-type: none">• Battery is exhausted	<ul style="list-style-type: none">• Install a new battery
- appears in the data panel when the shutter-release button is pressed partway down	<ul style="list-style-type: none">• Lens not attached correctly• Contacts on camera and/or lens are dirty• Camera is attached to telescope	<ul style="list-style-type: none">• Reattach the lens• Clean contacts• Contact a Minolta Service Facility for information
Autofocus does not work when shutter-release button pressed part-way down	<ul style="list-style-type: none">• Camera in manual focus• Situation unsuitable for autofocus• Subject too close	<ul style="list-style-type: none">• Set autofocus mode• Use focus lock or manual focus• Check minimum focus distance for your lens
Flash fires when shutter release is pressed partway down	<ul style="list-style-type: none">• AF illuminator is on	<ul style="list-style-type: none">• Normal camera operation

CARE AND STORAGE

OPERATING TEMPERATURE AND CONDITIONS

- This camera is designed for use from -20° to 50°C (-4° to 122°F).
- Never leave your camera where it may be subjected to extreme temperatures such as the glove compartment of a car.
- At colder temperatures, the data panel response time will be slow; at higher temperatures, the display will temporarily darken but will restore when the temperature normalizes.
- Never subject your camera to extreme humidity.
- To prevent condensation from forming, place the camera in a sealed plastic bag when bringing it from the cold exterior to a warm building. Allow it to come to room temperature before removing it from the bag.

BATTERY CAUTIONS

- Read and follow all warnings and instructions supplied with the batteries.
- Keep batteries away from children.
- Do not subject the battery to high temperatures or fire; or attempt to disassemble, recharge or short-circuit it; the battery may explode causing severe burns.
- When photographing in cold weather, we recommend that you keep the camera and spare batteries inside your coat to keep them warm when you are not shooting. Cold batteries will regain some of their charge when they warm up.
- The low-battery symbol may appear even with a fresh battery depending on the storage conditions. To restore camera power, repeat turning the camera on and off.

HANDLING CARE

- Do not touch or cover the flashtube and be sure to leave sufficient space around it during operation - it may become hot when the flash fires.
- Never subject the camera to shock, especially when transporting.
- This camera is not waterproof, dust-proof, or sand-proof; take care when using at the beach or near water - costly or irreparable damage to the camera may occur.
- This camera contains high-voltage circuits; do not attempt to disassemble or repair it.

CLEANING

- If the camera or lens barrel is dirty, wipe it gently with a soft, clean, dry cloth. If it comes in contact with sand, gently blow away loose particles - wiping may scratch the surface.
- To clean the lens surface, first brush away any dust or sand and if necessary moisten a lens tissue with lens cleaning fluid and gently wipe the lens in a circular fashion from the center.
- Never place lens-fluid directly on the lens.
- Never touch the interior of the camera, especially the shutter and mirror. *Doing so may impair their alignment and movement.* Dust on the mirror will not affect the picture quality.
- Never use compressed air to clean the camera's interior, it may cause damage to sensitive interior parts.
- Never use organic solvents to clean the camera, especially the lens mount.
- Never touch the lens surface with your fingers.

STORAGE

When storing your camera for extended periods of time, please follow these guidelines:

- Always attach the protective caps.
- Store in a cool, dry and well ventilated area away from dust and chemicals such as moth balls. For very long periods, place the camera and lens in an airtight container with a silica gel drying agent.
- Periodically release the camera's shutter to keep it operating properly.
- Before using after prolonged storage, always check the camera's operation to make sure that it is functioning properly.

BEFORE IMPORTANT EVENTS

- Always check camera operation carefully or take test photographs.
- Minolta is not responsible for damages incurred by equipment malfunction.

QUESTIONS AND SERVICE

- If you have questions about your camera, contact your local camera dealer or write to the Minolta distributor in your area.
- Before shipping your camera for repair, please contact an authorized Minolta Service Facility for details.

TECHNICAL DETAILS

- Type:** Micro-processor controlled 35mm SLR with expert control of autofocus(AF) and autoexposure(AE).
- Lens Mount:** Minolta A-type bayonet mount, compatible with all Minolta AF lenses including AF Zoom xi and AF Power Zoom lenses.
- AF System:** Through-the-lens (TTL) phase-detection system with one CCD line sensor and AF Illuminator. Continuous AF/focus lock selected automatically according to subject movement; predictive and manual focus control with electronic confirmation. Sensitivity: EV -1 to 17 (ISO 100).
- Metering:** TTL, 8-segment honeycomb pattern silicon photocell (SPC); direct TTL flash metering. Programmed AE (P-Mode) exposure mode with 5 subject program modes: Portrait, Landscape, Close-up, Sports and Night Portrait. Sensitivity range: EV 1 - 20 (f/1.4).
- Shutter:** Electronically controlled, vertical traverse focal-plane type. Range: 1/2000 - 30 sec.
- Built-In Flash:** Guide Number: 12 (ISO 100); Coverage 28mm; Recycling Time: 2 sec. (according to Minolta's test method); Red-eye Reduction; Modes: ON,OFF,AUTO, auto flash in low-light or back-lit situations.
- Viewfinder:** Roof mirror type; 90% coverage; 0.75X magnification (50mm lens at infinity); -1 diopter (fixed)
- Self-timer:** 10 second delay of shutter release; flash fires three bursts just before the picture is taken.

Film: Automatic film transport, first frame setting, film advance and film rewind, manual film rewind switch. Continuous film advance at 1 frame per second. Film Speed Range: ISO 25-5000, ISO 25-1000 (w/flash) DX-coded film set automatically, Non-DX-coded film set to ISO 100.

Power: Camera: (1) 6-volt 2CR5 lithium battery;
Power Indicator: 4-stage power indicator.
Performance: Performance is based on Minolta's standard test method using 24-exposure roll film, AF 35-70mm f/3.5-4.5 lens, AF from infinity to minimum focus distance and back 3 times, shutter-release button held partway down for 10 seconds before each exposure.

Flash use	20°C (68°F)	-20°C (-4°F)
100%	15 rolls	5 rolls
50%	25 rolls	10 rolls
0%	70 rolls	25 rolls

Performance will vary depending on the number of operations performed during each exposure. For performance with 36-exposure rolls, reduce the above data by 1/3.

QD Back: (1) 3-volt CR2025 lithium battery.

Dimensions: 147 x 101 x 68mm (5^{13/16} x 4 x 2^{11/16}in)

Date model: 147 x 101 x 69mm (5^{13/16} x 4 x 2^{3/4}in)

Weight: 380g (13.4oz) (body only)

Date model: 385g (13.6oz) (body only)

*Specifications and accessories are based on the latest information available at the time of printing and are subject to change without notice.

QUICK REFERENCE

Select a Subject Program Mode

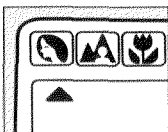
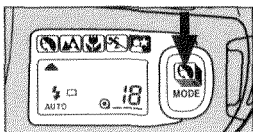

Re-set Full-Auto Mode

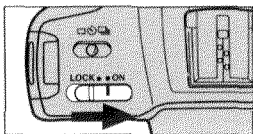

Lock Focus

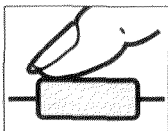
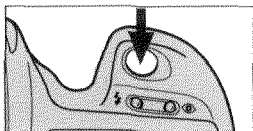

Focus Manually

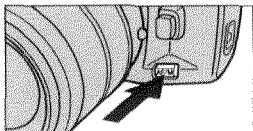

Set Self-Timer

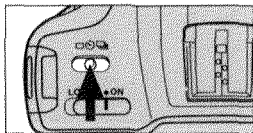

Set Fill-Flash

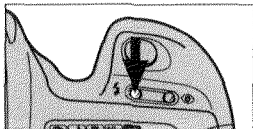

Cancel Flash

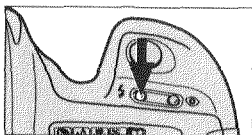

Check Battery

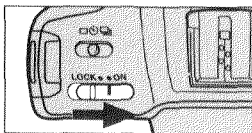

Change Drive Mode

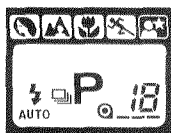
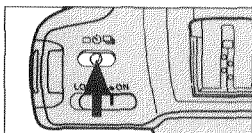

Set/Cancel red-Eye Reduction

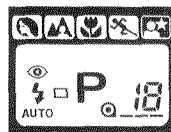
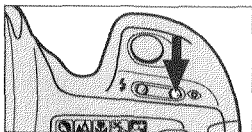

Rewind Film

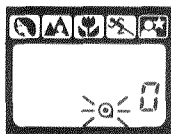
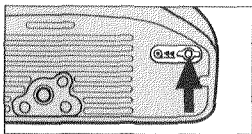

Set
Wireless/Remote
Flash

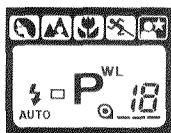

This device complies with Part 15 of the FCC Rules. Operation is subject to the following conditions: (1) This device may not cause harmful interference, and (2) this device must accept any interference received, including interference that may cause undesired operation. Changes or modifications not approved by the party responsible for compliance could void the user's authority to operate the equipment. This equipment has been tested and found to comply with the limits for a Class B digital device, pursuant to Part 15 of the FCC Rules. These limits are designed to provide reasonable protection against harmful interference in a residential installation. This equipment generates, uses and can radiate radio frequency energy and, if not installed and used in accordance with the instructions, may cause harmful interference to radio communications. However, there is no guarantee that interference will not occur in a particular installation. If this equipment does cause harmful interference to radio or television reception, which can be determined by turning the equipment off and on, the user is encouraged to try to correct the interference by one or more of the following measures:

- Reorient or relocate the receiving antenna.
- Increase the separation between the equipment and the receiver.
- Connect the equipment to an outlet on a circuit different from that to which the receiver is connected.
- Consult the dealer or an experienced radio/TV technician for help.

This digital apparatus does not exceed the Class B limits for radio noise emissions from digital apparatus as set out in the interference-causing equipment standard entitled "Digital Apparatus", ICES-003 of the Department of Communications.

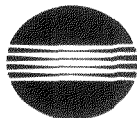

MINOLTA

Minolta Co., Ltd.	3-13, 2-Chome, Azuchi-Machi, Chuo-Ku, Osaka 541, Japan
Minolta GmbH	Kurt-Fischer-Strasse 50, D-22923 Ahrensburg, Germany
Minolta France S.A.	365 Route de Saint-Germain, F-78420 Carrieres-Sur-Seine, France
Minolta (UK) Limited	Rooksley Park, Precedent Drive, Rooksley, Milton Keynes, MK13 8HF, England
Minolta Austria Ges. m.b.H.	Amalienstrasse 59-61, A-1131 Wien, Austria
Minolta Camera Benelux B.V.	Zonnebaan 39, P.O. Box 6000, NL-3600 HA Maarssen, The Netherlands
Belgium Branch	Kontichsesteenweg 38, B-2630 Aartselaar, Belgium
Minolta (Schweiz) AG	Riedstrasse 6 CH-8953 Dietikon, Switzerland
Minolta Svenska AB	P.O.Box 9058, Albygatan 114, S-17109 Solna, Sweden
Finland Branch	Niittykatu 6 PL 37 SF-02201 Espoo, Finland
Minolta Portugal Limitada	Rua Afonso Lopes Vieira 55-B P-1700 Lisboa, Portugal
Minolta Corporation	
Head Office	101 Williams Drive, Ramsey, New Jersey 07446, U.S.A.
Los Angeles Branch	11150 Hope Street Cypress, CA 90630, U.S.A.
Minolta Canada Inc.	
Head Office	369 Britannia Road East, Mississauga, Ontario L4Z 2H5, Canada
Vancouver Branch	106-3850 Jacombs Road, Richmond, B.C. V6V 1Y6, Canada
Minolta Hong Kong Limited	Room 208, 2/F, Eastern Center, 1065 King's Road, Quarry Bay, Hong Kong
Minolta Singapore (Pte) Ltd.	10, Teban Gardens Crescent, Singapore 608923
Shanghai Minolta Optical Products Co., Ltd.	368 Minolta Road, Songjiang, Shanghai, China

© 1994 Minolta Co., Ltd. under the Berne Convention
and Universal Copyright Convention