

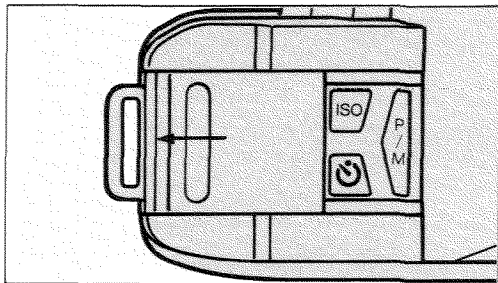

MANUAL MODE



To take pictures in manual mode:

1. Set the main switch to ON or (I) position and set focus mode switch to AF position.
2. Slide the control-key cover to the left and press the mode-selector key (marked P/M). "M" will appear in the data panel and viewfinder.
3. Look through the viewfinder and compose the picture and touch the operating button to activate the meter.

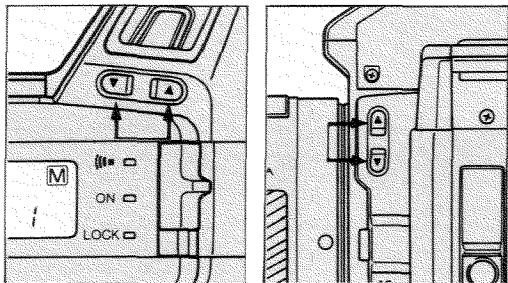

4. Adjust the exposure so that both pointers appear in the viewfinder:
 - Set the shutter speed by pressing the selector keys on top of the camera.
 - Set the aperture by pressing the selector keys on the left side of the camera.
 - Possible aperture and shutter speed settings are shown on p. 30.
5. After exposure is set correctly, focus and compose the picture, then release the shutter.

Metering indications:

When you touch the operating button, the shutter speed and aperture settings will appear along with the metering indicators:



Both pointers appear: Exposure is set correctly.



Upper pointer appears: Exposure is set 1/4 stop or more above normal. For normal exposure, set a faster shutter speed or a larger aperture number.



Lower pointer appears: Exposure is set 1/4 stop or more below normal. For normal exposure, set a slower shutter speed or a smaller aperture number.



Both pointers blink: Light level is beyond the meter's range, and exposure may not be correct.

APERTURE AND SHUTTER-SPEED SETTINGS

1.7

2

2.4

2.8

3.5

4

4.5

5.6

6.7

8

9.5

11

13

16

19

22

Aperture settings

At right are the aperture settings (also called f-stops) that appear in program and manual modes when using the AF 50mm f/1.7 lens. Numbers such as 6.7 and 9.5 are "half-stop" settings between the standard apertures (f-stops). For example, the half-stop setting between f/8 and f/11 is f/9.5.

Shutter-speed settings

At left are the shutter-speed settings that appear in program mode and can be set in manual mode. Numbers such as 750 and 350 appear only when using program mode. These are the "half-stop" settings between the standard shutter speeds. For example, the half-stop setting between 1/1000 sec. and 1/500 sec. is 1/750 sec.

Indications for speeds from 1/2000 sec. to 1/2 sec. are shown as: 2000 = 1/2000 sec., 1000 = 1/1000 sec., etc. Speeds of 0.7 sec. to 4 sec. are shown as: 1" = 1 sec., 2" = 2 sec., and 4" = 4 sec. "Bulb" appears only when using M mode.

Program mode		Manual mode
2000	— 1500	2000
1000	— 750	1000
500	— 350	500
250	— 180	250
125	— 100	125
60	— 45	60
30	— 20	30
15	— 10	15
8	— 6	8
4	— 3	4
2	— 0"7	2
1"	— 1"5	1"
2"	— 3"	2"
4"		4"
		bulb



CONTROLLING SHARPNESS



A. Aperture set at $f/2$

The aperture that you select determines how much of the picture will be in sharp focus: **A.** By using apertures such as $f/2$ or $f/2.8$, for example, just a small area in front of and behind the subject will be sharply focused. This is useful when you want to isolate a subject from its background, such as when taking a portrait;



B. Aperture set at $f/16$

B. When you want sharp focus in the entire picture, as when photographing a large group of people, $f/11$ or $f/16$ can be used.

CONTROLLING MOTION



A. Slow shutter speed

Your choice of shutter speeds affects how moving subjects will appear in the picture:

A. Slow shutter speeds, such as $1/30$ or $1/15$ of a second, will make moving subjects appear to flow;



B. Fast shutter speed

B. Fast shutter speeds, such as $1/500$ or $1/1000$ of a second, can be used to freeze the action of a moving subject. When using telephoto lenses, fast shutter speeds should be set to prevent blurred pictures caused by camera shake.

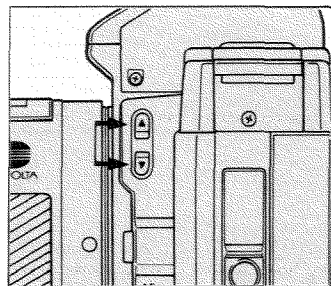
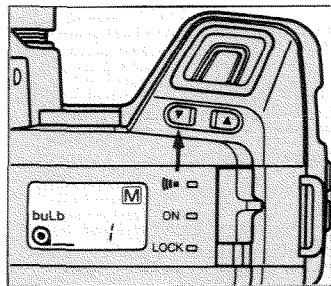
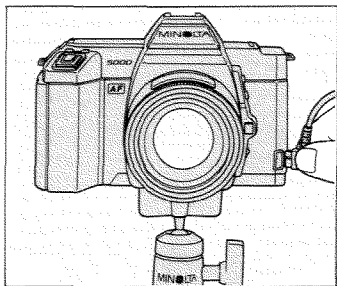

Long exposures

When you want to make exposures longer than 4 seconds, "bulb" setting can be used. The shutter will remain open as long as the camera's (or remote cord's) operating button is held down. To use "bulb" setting:

1. Mount the camera on a tripod.
2. Attach either of the optional Remote Cords RC-1000S or RC-1000L. You can then release the shutter without shaking the camera.

3. With the camera in M mode, press the left selector key on top of the camera until "bulb" appears in the data panel and viewfinder.

4. Press the selector keys on left side of camera to set the aperture desired.

5. Focus the lens. If it is too dark for auto-focusing, manually set the focus to the desired distance, using the distance scale.

6. To take the picture, press and hold down the operating button for the desired amount of time.

- Elapsed exposure time is shown in seconds in the data panel. After 99 seconds, the counter returns to "0" and counting continues.

- At normal temperatures (20°C/68°F), maximum exposure time is approx. 4 hours when using fresh AAA-size alkaline-manganese batteries. With AA-size alkaline-manganese batteries in the optional Battery Holder BH-70L, exposures up to approx. 9 hours are possible.

- If the camera's mirror locks up during the exposure, set main switch to LOCK, replace the batteries, and slide main switch to ON.

- To use eyepiece cap, refer to page 36.

SELF-TIMER OPERATION

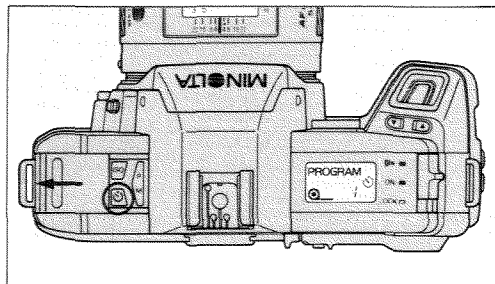

The MAXXUM 5000's electronic self-timer lets you delay shutter release for ten seconds.

To use:

1. Slide the control-key cover to the left.
2. Press the self-timer key (marked )

The self-timer symbol will appear in the data panel.

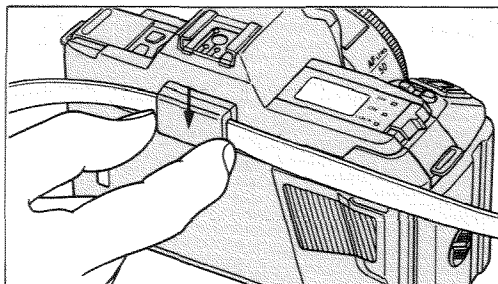

- Pressing the key again will switch off the self-timer.
3. Focus the lens and attach the eyepiece cap.

4. Press the operating button all the way down to start the self-timer.

- The number of seconds remaining before the shutter will release are displayed in the data panel.
- If the main switch is at (II) setting, the camera will beep once a second for eight seconds, very rapidly for one second, then emit a continuous tone just before the shutter is released.
- The self-timer is automatically switched off after the exposure. If you want to make another exposure using the self-timer, repeat steps 2-4.

To cancel self-timer operation:

If you have started the self-timer and want to cancel it before the shutter releases, move main switch to LOCK and back to ON position.

DISTANCE SCALE

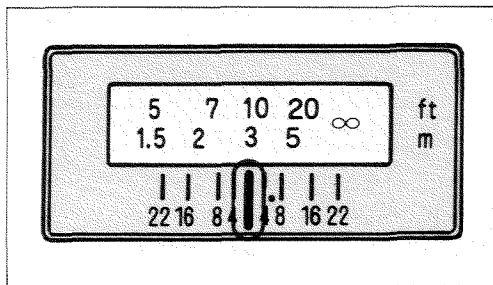

The distance scale marked on each Minolta AF lens is useful when you want to manually focus the lens to a specific distance, or when it is too dark to use autofocus. To use the scale, set the focus mode switch to M.

Estimate the distance to your subject, and turn the focusing ring align the corresponding figure on the distance scale with the index line.

USING A TRIPOD

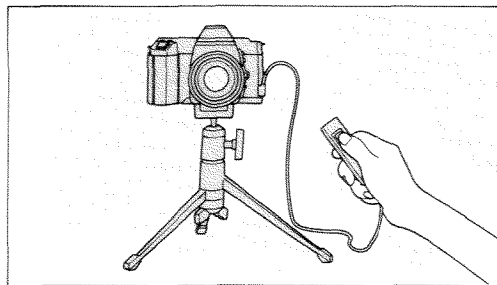

To prevent blurred pictures, the camera should be mounted on a tripod in the following situations: when making long exposures at "bulb" setting; when using slow shutter speeds; and when using the self-timer.

When you attach the camera to the tripod, do not tighten the tripod's mounting screw too much. Also, make sure that mounting screw is not longer than 5.4mm (1/4 in.).



USE OF MAXXUM AF LENSES

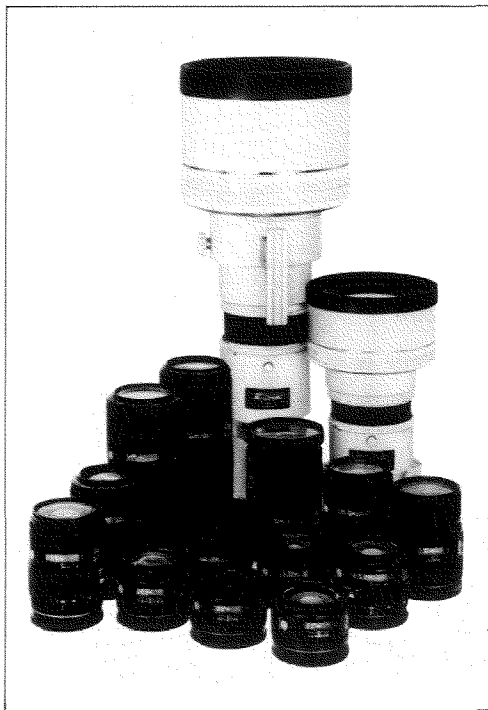

A wide range of MAXXUM AF lenses is available for your MAXXUM 5000. These can be purchased separately from your photo dealer.

The MAXXUM AF lens system now features focal lengths from 24mm wideangle to 600mm apochromat telephoto. Included are seven macro/zooms covering focal lengths from 28mm to 300mm. Among these outstanding zoom lenses are the ultra-compact 35-70mm and 100-200mm zooms, which enable photographing landscapes or portraits with equal ease.

All MAXXUM AF lenses attach to the camera in the same way as explained earlier in this manual. When using program mode, the camera instantly selects one of three exposure programs based on the lens focal length in use. This is called as Auto Multi-Program Selection (AMPS).

Auto Multi-Program Selection (AMPS)

Wide program is set for focal lengths shorter than 35mm: uses smaller apertures to obtain more sharpness (depth of field) when using wideangle lenses.

Standard program is set for focal lengths from 35mm to 105mm: Maintains optimum shutter/aperture combinations for sharp pictures when using the camera hand-held.

Tele program is set for focal lengths longer than 105mm: Faster shutter speeds are used to prevent blurred pictures caused by camera shake or subject movement.

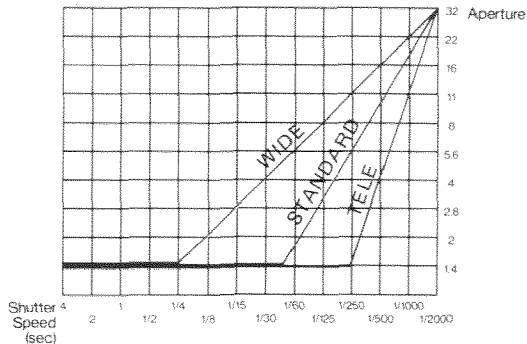

- Since selection of the program is done automatically, it is not possible to manually select a specific program.
- When using an AF zoom lens, the program automatically changes as the focal length is changed from one range to the next. With the AF 28-135mm zoom, for example, as you adjust the focal length from 28mm to 135mm, the program changes from Wide through Standard to Tele.

USE OF MAXXUM PROGRAM FLASH UNITS

When taking pictures in low light or if the *slow shutter-speed warning beeps*, a MAXXUM Flash unit can be attached to the camera's accessory shoe.

All MAXXUM Flash units feature built-in AF illuminators. When required in low light, the AF illuminator automatically projects a beam of red light onto the subject, which the camera uses for automatic focusing.

Flash exposure, in both program and manual mode, is controlled automatically by the MAXXUM 5000's flash metering system. The flash signal in the viewfinder indicates when the flash is charged and if exposure was sufficient.

In program mode: No manual settings are required; the camera sets both the aperture and shutter speed. The X-sync speed is set automatically to 1/60 or 1/100 sec. depending in the light level.

When photographing a subject in direct sunlight, flash can be used to "fill in" the dark shadows. In this case, the camera's flash program automatically adjusts flash output for correct exposure.

In manual mode: Shutter speed can be set to any speed 1/100 sec. or slower. Smaller aperture numbers can be set to obtain maximum flash range for distant subjects or larger numbers can be set for more sharpness in close-up photos.

MAXXUM FLASH UNITS

MAXXUM Flash 1800AF: This ultra-compact unit is extremely easy to use; just switch it on and you are ready to shoot. It accepts a 6v lithium battery for shortest recycling, and AAA-size alkaline batteries can also be used. Guide Number is 18 in meters (59 in feet) with 35mm coverage.

MAXXUM Flash 2800AF: This intermediate unit provides increased flash power and has a Guide Number of 28 in meters (92 in feet) with 35mm coverage. Other features include high/low power settings and sufficient-exposure confirmation.

MAXXUM Flash 4000AF: This powerful unit has a Guide Number of 40 in meters (131 in feet) with 50mm coverage. An auto-zoom/bounce head enables efficient lighting control. The LCD panel shows power level, flash coverage, and flash ranges.

Guide numbers are based on ISO 100

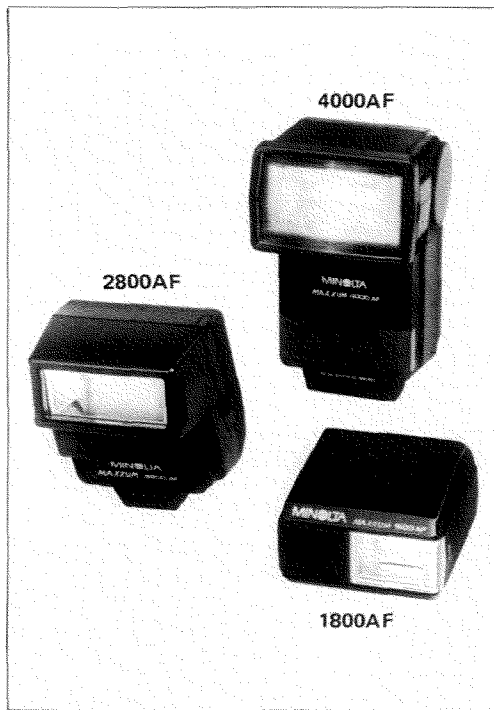

ACCESSORIES

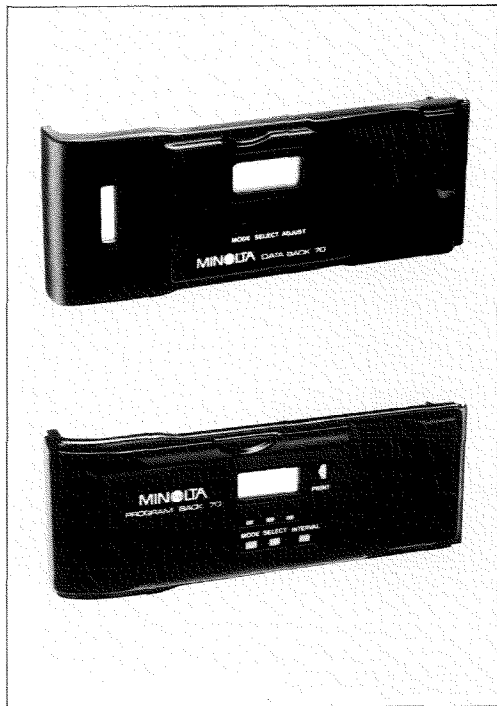

The Data Back 70 enables imprinting of the date, day with 24-hour time, or the hour and minute of exposure. A single 3-volt lithium battery is installed at the factory and supplies power for imprinting and operating the automatic calendar and clock.

The Program Back 70 enables imprinting of the date, day with 24-time, consecutive number in either ascending or descending order, fixed numbers, or a combination of consecutive and fixed numbers. For unmanned camera control, the intervalometer can be set to release the shutter at pre-selected intervals. Timed long-exposures are also possible.

Either unit attaches in place of the MAXXUM 5000's standard back. Exposure duration for data imprinting is controlled automatically according to the camera's film-speed setting.

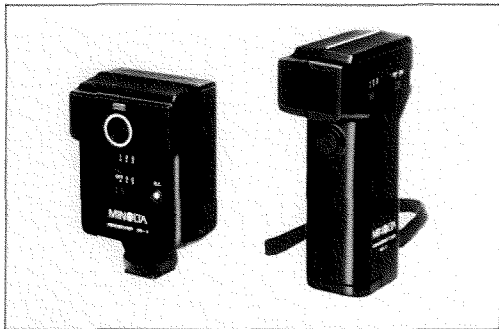

Wireless Controller IR-1N Set

The Wireless Controller IR-1N Set permits cordless, remote-control photography from up to 60 meters (approx. 200 ft.) away. The receiver senses infrared pulses from the transmitter and releases the shutter with single or continuous film advance. Separate receivers can be used for remote control of up to three cameras.

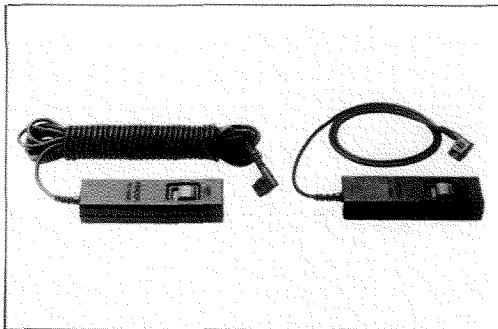

Remote Cord RC-1000L and RC-1000S

A remote cord should be used for long exposures at "bulb" setting or anytime you want to release the shutter without shaking the camera. Autofocus and meter are both activated by partially depressing the release button. Pressing and sliding the release button locks the shutter open for long exposures. RC-1000L is 5m (16-1/2 ft.) long, RC-1000S is 50cm (approx. 20 in.) long.

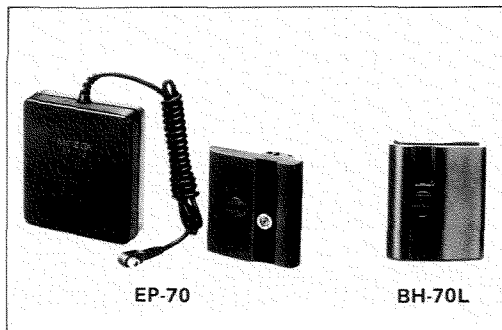

Battery Holder BH-70L and External Battery Pack EP-70

Battery Holder BH-70L replaces the standard AAA-size battery holder. The External Battery Pack EP-70 can be slipped into your pocket to keep them warm when taking pictures in cold weather. The BH-70L and EP-70 both use AA-size alkaline-manganese or nickel-cadmium batteries.

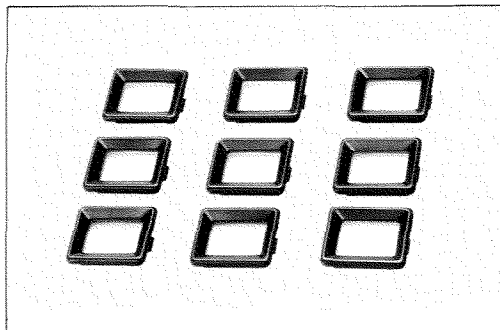

Eyepiece Corrector 1000

Nine eyepiece correction lenses are available for the MAXXUM 5000. They permit adjustments from -4 to $+3$ diopters and are very useful for near-or farsighted photographers. Correction lenses snap into the camera's eyepiece frame.



Minolta Polarizing (Circular) Filter

To reduce or eliminate reflections from glass, water, or other non-metallic surfaces, Minolta's Polarizing (Circular) Filters should be used. If a regular polarizing filter is used, autofocusing may not be accurate. (Light from regular polarizing filters is not fully transmitted by the camera's semi-silvered main mirror.)

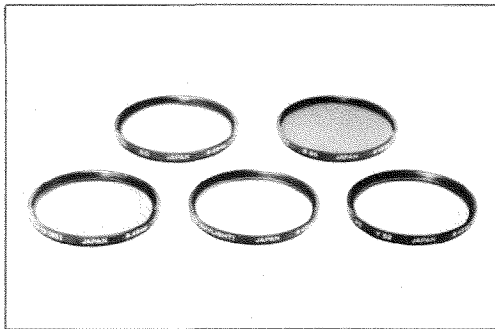

Other Filters

Autofocusing can be used with these Minolta filters: L37 (UV), Y52 (Yellow), G0 (Green), O56 (Orange), R60 (red), 1A and 1B (skylight), Minolta Portrayer

When using filters other than those listed, autofocusing may not be accurate. In this case, focus manually with filter attached or autofocus and then attach filter.

Other flash units:

All Minolta Auto Electroflash units can be used on the MAXXUM 5000; however, auto-focusing in total darkness, and certain other features are not possible:

360PX and 132PX: FDC (flash distance check) signal does not function; all other functions are the same.

280PX: FDC signal does not function; low power setting cannot be used.

Macro 80PX: FDC signal does not function; illumination lamps go out when operating button is touched.

X-series units: TTL metering and FDC signal do not function.

Other Minolta system accessories

The following Minolta System accessories can be used with the MAXXUM 5000:

Angle Finder V_N, Magnifier V_N, Cable OC, Cable EX, Cable CD, Triple Connector, Off-Camera Shoe, Wireless Controller IR-1 Set with optional Connecting Cord IR-1 (C).



TECHNICAL DETAILS

Type: 35mm SLR with autofocus, auto multi-program or manual exposure, and auto film transport

Lens mount: Minolta "A"-type bayonet; accepts all Minolta AF lenses

Autofocus system: Minolta's TTL phase-detection type; working range: EV 2 to 19 at ISO 100; focus signals in viewfinder for both manual and automatic focusing

Shutter: Electronically controlled vertical-traverse focal-plane type

Shutter-speed range: Program mode, stepless 1/2000 to 4 sec. with nearest half-stop displayed in viewfinder; manual (M) mode, 1/2000 to 4 sec. in full stops; "bulb" for long exposures in M mode

Film-speed settings: ISO 25 to 6400 in third-stop increments; automatic setting for DX-coded film; manual setting possible for non-DX film or to override DX-setting

Metering: TTL center-weighted averaging type by silicon photocell (SPC) on pentaprism for ambient light; second SPC at bottom of mirror box for TTL flash metering with dedicated flash unit

Auto-exposure (AE) range: EV -1 to 20 at ISO 100 with 50/1.4 lens (e.g., 4 sec. at f/1.4 to 1/2000 sec. at f/22)

Exposure modes:

Program: Shutter speed and aperture set according to AE program automatically selected by camera: Wide program for focal lengths shorter than 35mm, Standard for focal lengths from 35mm through 105mm, Tele for focal lengths longer than 105mm

Manual: Any available shutter speed (in full-stops) and aperture (in half-stops) can be set; settings and correct exposure indicated in viewfinder

Flash exposure modes: TTL flash metering at film speeds ISO 25-1000

Program: Automatic setting of X-sync to 1/100 sec. (or 1/60 below EV 12) and aperture; automatic fill-in flash in bright sunlight

Manual: Usable shutter speeds 1/100 sec. or slower, any aperture usable; speed automatically reset to 1/100 sec. for manually set speeds 1/125 sec. or faster

Backlight compensation button: In program mode, pressing button marked BLC increases exposure by +2 EV.

Viewfinder: Eye-level fixed pentaprism shows 94% of 24 x 36mm film-frame area; magnification 0.85X with 50mm lens at infinity

Data displays:

Top panel: Displays exposure mode, film speed, frame number, self-timer operation, "bulb" operation, low-battery warning, and film-transport status

Viewfinder: Displays exposure mode, shutter speed, aperture, low-battery warning, whether light level is within metering range, and over-/underexposure warning; display illuminated automatically in low light; LED focus signals, LED flash-ready/sufficient-exposure signal

Film transport: Automatic with built-in motor drive: auto threading, auto advance to first frame, continuous film advance with focus-priority shutter release at up to 1.5 frames per second, power rewinding,

auto rewind stop; frame number increases by one with each exposure only when film is loaded and advancing correctly

Operating button: Touch-sensitive switch activates metering and viewfinder display, metering continues for 10 sec. after finger is lifted from button; press halfway to activate autofocus and focus hold; press all the way down to release shutter

Power: Four AAA-size 1.5v alkaline-manganese batteries power all operations; built-in lithium cell for memory back-up; low power indicated by battery symbol in finder and data panel; sliding main switch with LOCK, ON, and (beep) positions

Audible signals: With main switch at beep position, camera emits audible signals: when subject is in focus; at the end of the roll; during self-timer operation; and as a slow shutter-speed warning in program mode when speed is below: 1/30 sec. with lenses shorter than 35mm, 1/60 sec. with lenses from 35mm to 105mm, and 1/125 sec. with lenses longer than 105mm.

Controls: Keys to select manual mode, set self-timer, and set film speed; selector keys to adjust aperture, shutter speed, and film speed; closing control-key cover sets camera to program mode and cancels self-timer operation.

Self-timer: Electronic with 10-second delay; cancelable; operation indicated by count-down in data panel accompanied by synchronized audible beeps.

Other: Front and rear handgrips, eyepiece cap, film window, remote shutter-release socket, carrying strap

Size and weight: 52 x 92.5 x 138mm (2-1/16 x 3-5/8 x 5-7/16 in.), 550g (19-3/8 oz.) without lens and batteries

Optional accessories: Minolta AF lenses, Program Flash units, Data Back 70, Program Back 70, Eyepiece Correctors, Battery Holder BH-70L, External Battery Pack EP-70, off-camera cables and connectors, Remote Controller IR-1N.

CARE AND STORAGE

- Always keep your camera in its case with the lens capped when not in use, or with a body cap on when a lens is not attached.
- No part of the camera should be forced at any time.
- Never subject your camera to shock, high heat, high humidity, water, or harmful chemicals. Be particularly careful not to leave it in the glove compartment or other places in motor vehicles where it may be subjected to high temperatures.
- Never lubricate any part of the camera body or lens.
- Never touch the shutter curtains or the front inside parts of the body or clean them with compressed air. Doing so may impair their alignment and movement.
- External camera surfaces and lens barrel--but not glass surfaces--can be cleaned by wiping with a dry or silicone-treated cloth.

Minolta Camera Co., Ltd.

Minolta Corporation

Head Office

Los Angeles Branch

Chicago Branch

Atlanta Branch

Minolta Canada Inc.

Head Office

Montreal Branch

Vancouver Branch

Minolta Camera Handelsgesellschaft m.b.H.

Minolta France S.A.

Minolta (UK) Limited

Minolta Austria Gesellschaft m.b.H.

Minolta Camera Benelux B.V.

Belgium Branch

Minolta (Schweiz) AG

Minolta Svenska AB

Minolta Hong Kong Limited

Minolta Singapore (Pte) Ltd.

30, 2-Chome, Azuchi-Machi, Higashi-Ku, Osaka 541, Japan

101 Williams Drive, Ramsey, New Jersey 07446, U.S.A.

3105 Lomita Boulevard, Torrance, CA 90505, U.S.A.

3000 Tollview Drive, Rolling Meadows, IL 60008, U.S.A.

5904 Peachtree Corners East, Norcross, GA 30071, U.S.A.

1344 Fewster Drive, Mississauga, Ontario L4W 1A4, Canada

376 rue McArthur, St. Laurent, Quebec H4T 1X8, Canada

1620 W. 6th Avenue, Vancouver, B.C. V6J 1R3, Canada

Kurt-Fischer-Strasse 50, D-2070 Ahrensburg, West Germany

357 bis, rue d'Estienne d'Orves, 92700 Colombes, France

1-3 Tanners Drive, Blakelands North, Milton Keynes, MK14 5BU, England

Amalienstraße 59-61, 1131 Wien, Austria

Zonnebaan 39, 3606 CH Maarssenbroek, P.B. 264, 3600 AG Maarssen,
The Netherlands

Stenen Brug 115 – 117, 2200 Antwerpen, Belgium

Riedhof V, Riedstrasse 6, 8953 Dietikon-Zürich, Switzerland

Brannkyrkagatan 64, Box 17074, S-10462 Stockholm 17, Sweden

Room 208, 2/F, Eastern Center, 1065 King's Road, Hong Kong

10, Teban Gardens Crescent, Singapore 2260

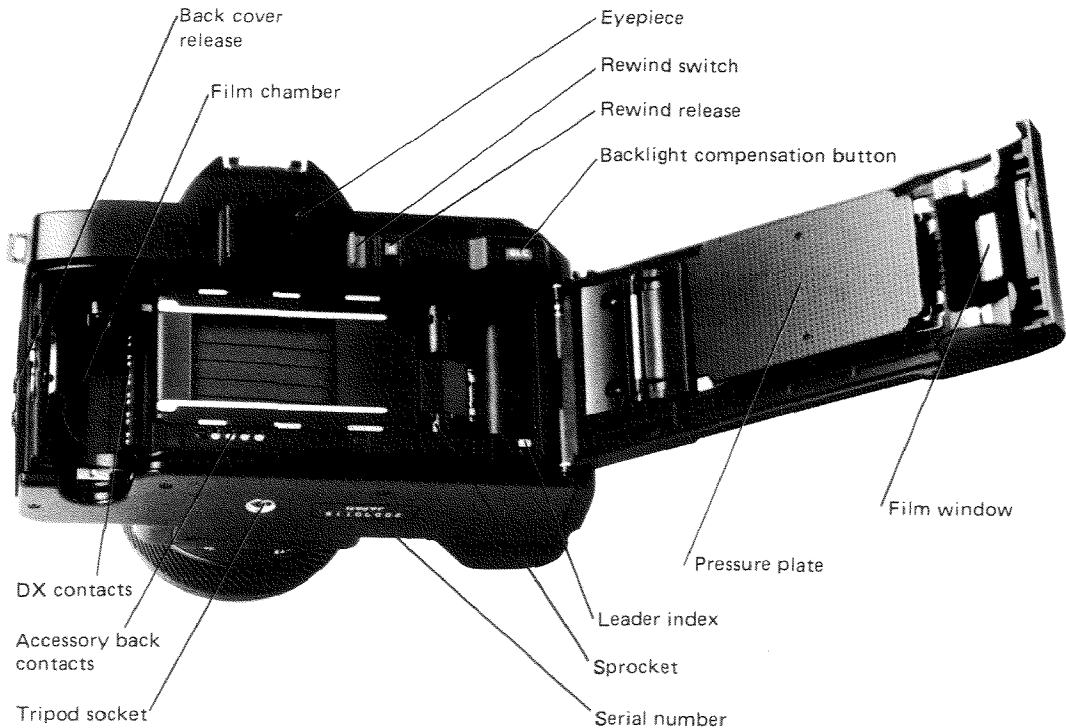

- Never touch lens or eyepiece surfaces with your fingers. Whisk away loose matter with a blower brush. To remove stubborn spots, use a sheet of photographic lens tissue. If necessary, tissue may be moistened with one drop of lens-cleaning fluid. Never place fluid directly on glass surfaces.
- It is recommended to have your camera cleaned once a year at an authorized Minolta service facility.
- When storing camera for more than two weeks, remove the batteries and keep it in a cool, dry place away from dust or chemicals, preferably in an airtight container with a drying agent such as silica gel.
- The operating range for the LCD (liquid crystal display) panels is from -20° to $+50^{\circ}$ C (15° to 120° F). At temperatures outside this range, response time and contrast will change, making displays difficult to read. At very high temperatures, display may temporarily turn black. In either case, display should return to normal after a short period of time.

- The LCD panels and the lithium battery should last approximately 10 years. The film-speed setting will blink when it is time to replace the battery. When replacement of LCD panels or battery is needed, contact an authorized Minolta service facility.

Save camera box and packing material.
When shipping your camera, carefully repack it in the box, insure adequately, and use a reliable delivery service.

Before shipping your camera for repairs, contact your nearest authorized Minolta service facility.

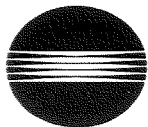

MINOLTA