

Mamiya 645E

Instructions

Name of Parts (1)

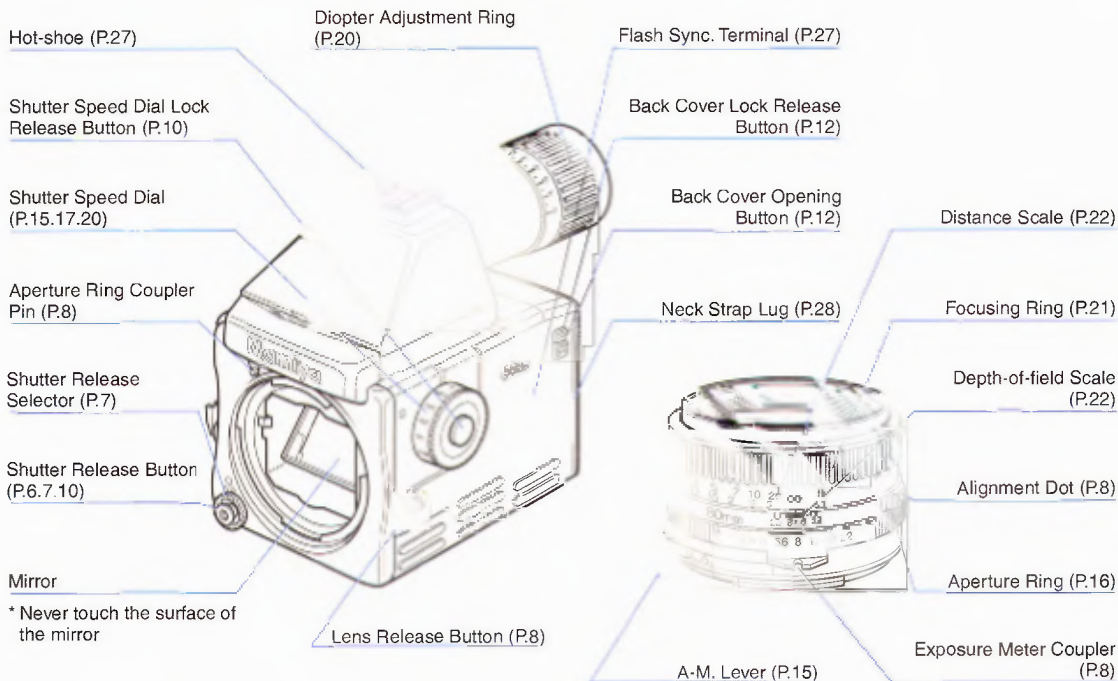

Finder LED Indicators

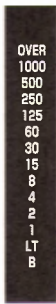
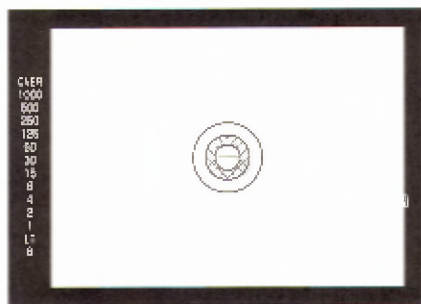

OVER — Blinks to indicate over-exposure.

1000 — Lights to indicate shutter speed that matches aperture setting.
500 —
250 — When shutter speed is between values, both value light
125 — blink to indicate exposure is between the shutter speeds.
60 —
30 —
15 —
8 —

4 — Lights to indicate a shutter speed greater than one second
2 —
1 —

LT — Lights to indicate Bulb
B —

Metering LEDs also blink to indicate low battery power, completion of winding and completion of shutter cocking.

 **CAUTION**

- Do not let the batteries' terminals ("+" and "-") come into contact with metal objects or carry or store batteries together with metal hair pins, chains, paper clips or other metal objects.
- When storing and disposing of batteries, insulate (apply tape to) the batteries' terminals ("+" and "-") so that they do not come into contact with metal objects or other batteries.
- Do not charge the batteries, take them apart, apply pressure to them, heat them or dispose of them in flames.
- Do not use new batteries together with used ones or mix batteries of different manufacturers or types.
- Remove spent batteries from the camera immediately.
- Use a tripod providing sufficient strength for the camera and lens. Also do not transport the camera with it mounted on a tripod. Doing so could damage the camera or cause you to trip, resulting in injury or other accidents.
- Be sure to fasten the neck strap securely to the camera's strap mount. Failure to do so may result in the camera falling, causing injury or damage to the product.
- Do not look directly at the sun or strong light sources through the lens. Doing so could impair your vision.
- Do not disassemble. Internal electrical circuitry may cause electric shocks if touched.
- Do not use the camera for purposes other than taking pictures.

Contents

Name of Parts (1)	1	Exposure Compensation	20
Finder LED Indicators	2	Diopter Adjustment	20
Contents	4	Focusing	21
Loading the Battery		Depth of Field	22
(The camera will not operate unless battery is loaded.)	5	Film Advance and Unloading Exposed Film	23
Battery Check	6	Mirror Lock-up Photography	24
Shutter Release Selector	7	Multiple Exposures	25
Attaching and Removing Lenses	8	Infrared Photography	26
Removing and Attaching the Film Advance Crank	9	Using a Tripod	26
Shutter Performance Test	10	Flash Photography	27
Before Film Loading	11	Attaching and Removing the Neck Strap	28
Film Loading	12-14	Holding the Camera Steady and Securely	29
Advancing the Film to the First Frame	14	System Chart	30
AE Photography (Aperture Priority AE)	15-16	Trouble Shooting	31
AEL (AE Lock) Photography	17	Mamiya 645E Specifications	32
Manual Photography	17	Common Sense Camera Care and Practice	33
LED Display in the View Finder	18-19	Name of Parts (2)	36

Loading the Battery (The camera will not operate unless battery is loaded.)

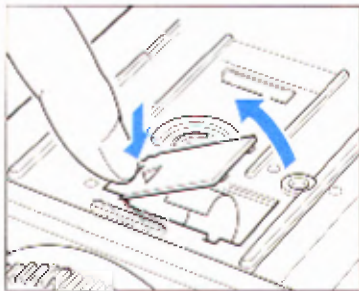

With your fingernail, slide the Battery Chamber Cover, on the bottom of the camera body, as indicated by the arrows in the illustration. Open the Battery Cover. The camera requires a 6V alkaline, silver oxide or lithium battery.

It is a good idea to wipe the battery terminals before insertion to assure proper contact. Observe polarity.

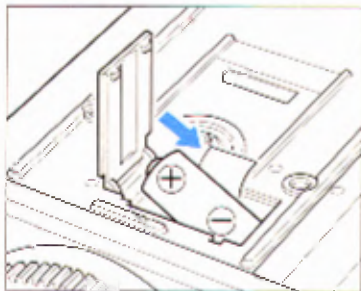

⊕ position is marked in battery cavity. Insert the ⊖ side first at a steep angle and then push entire battery into place, making sure that the lift ribbon wraps around battery. Close cover by pushing it down.

★ **Be particularly careful not to let the lift ribbon cover the ⊖ terminal.**

★ **Replacement battery is 4LR44, 4SR44 or 2CR1/3.**

Battery Check

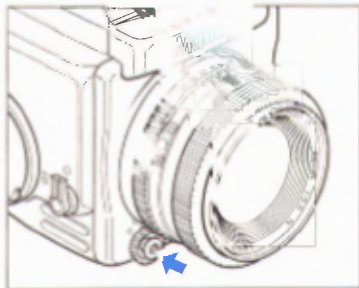

Press the shutter Release Button on lower front of the camera. Finder LED Indicators should light. Bright light indicates good condition. Blinking light means replace battery. No light means battery is dead or improperly inserted.

Important:

1. The sealed, new battery which is supplied with this camera may have been subject to storage conditions which have reduced its service life. Therefore it is desirable to replace it with a fresh battery as soon as possible.
2. Carefully wipe the battery contacts before inserting into the chamber. Failure to do so may result in poor electrical contact and consequent malfunctioning of the camera.
3. Always remove battery when camera is not used for a while. Always carry spare batteries.
4. Battery life differs, depending on type, age, storage condition, ambient temperature, frequency of use etc.

Battery strength will be indicated by whether the Finder LED Indicators:

- | | | |
|-----------------------|-----|---|
| Glows | ... | Battery strength is sufficient. |
| Blinks | ... | Battery capacity has dropped below the allowable level.
(Replace the battery.) |
| Does not light | | The camera will not work. (Replace the battery.) |

Shutter Release Selector

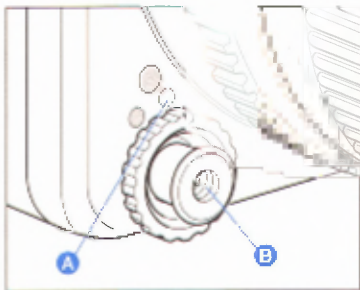

For normal operation set the White Dot of the Shutter Release Selector **A** against the White Dot . When set to the Red Dot **B**, the Release Button is locked.

★ **Select this mode if the camera will be idle for a period and to prevent accidental shutter release.**

Operating the Shutter Release Button

1. The Shutter Release Button **B** functions in two steps. Gentle pressure will light the metering information display. Continued pressure will release the electromagnetic shutter.
2. If the film is not completely advanced or if the battery is dead, the shutter will not function, even when the Shutter Release Button is pressed.
3. After releasing the shutter, the Film Advance Crank will automatically unlock and be ready to advance the film.

Attaching and Removing Lenses

Attaching the Lens

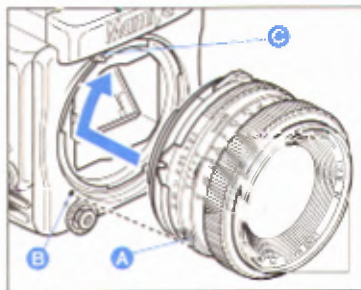

Line up red Lens Alignment Dot **A** against red Camera Alignment Dot **B** and gently insert the lens into the camera body. Then turn the lens clockwise, as indicated by arrow, until it clicks into place. Make sure that the Aperture Ring Coupler Pin **C** is engaged with the Exposure Meter Coupling Pin, which sticks out under the Mamiya name plate of the camera.

Removing the Lens

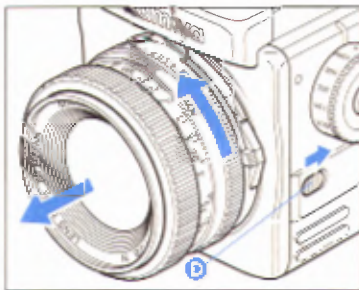

While pushing Lens Release Button **D** backwards, turn lens counter-clockwise. (Same procedure as removing body cap).

Removing and Attaching the Film Advance Crank

Removing the Crank

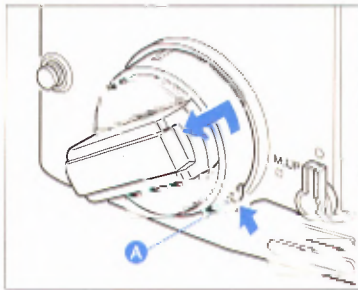

Push the Lock Lever **A** on its bottom in a forward direction as far as it will go (see illustration) and turn counter-clockwise.

Attaching the Crank

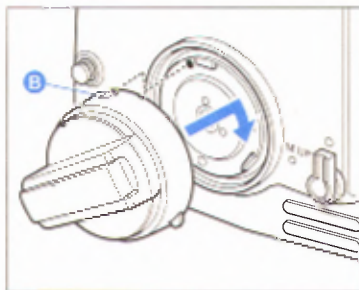

With the flat part, having a White Index Line **B** on top, line the Crank up against its mounting plate on the side of the body and turn clockwise and then counter-clockwise.

Shutter Performance Test

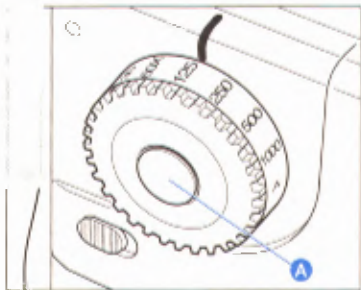

1. Set the Shutter Speed Dial to any other position than “A” or “AEL”. The shutter speed dial is automatically locked when it is moved to one of the settings marked in red (60X, A and AEL). Pushing button **A** will release the shutter speed dial allowing it to be set to any position.



2. Set the Multiple Exposure Lever on the body to the “MULTI” position.

★ **Don't forget to return the Multiple Exposure Lever to the normal position after exposures are completed.**

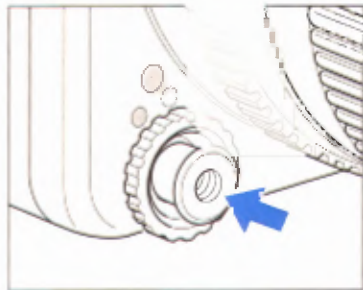

3. Set the Shutter Release Selector to “O” white circle (normal mode), and press the Shutter Release Button.

4. After the shutter has been released, advance the Film Advance Crank one complete revolution and the next frame will be ready.

★ **The empty film spool included with the camera body is supplied with a vinyl tube. When placed in the take-up compartment it engages the film sensor and makes the holder function as if it is loaded with film. Please remove the tube after your test.**

Before Film Loading

Film Speed (ISO) Dial

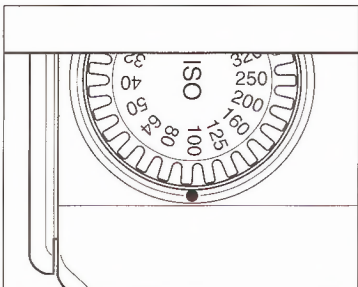

Film holder has this important feature. It electronically interfaces the film holder with the AE Finder, the focal plane shutter and the lens diaphragm, for exposure automation.

This eliminates the need to manually reset the meter. Therefore make it a routine to always set this dial with the speed of the loaded film.

Memo Clip



The Memo Clip on the Back Cover accepts the box top of the film carton and can also be used for other reminders.

Film Speed Index

ISO
25 · · 50 · · 100 · · 200 · · 400 · · 800
(32) (40) (64) (80) (125)(160) (250)(320) (500)(640)

Film Loading

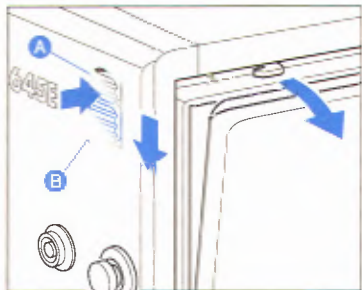

1. While pushing the Back Cover Opening Button **B** downward, press the Back Cover Lock Release Button **A** in, and the back cover will open.

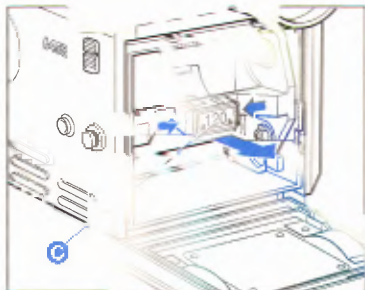

2. While squeezing in on both sides of the Release Latch **C**, pull the Roll Film Insert out of the camera body. At that time, move the empty spool in the upper part down to the lower spool compartment.

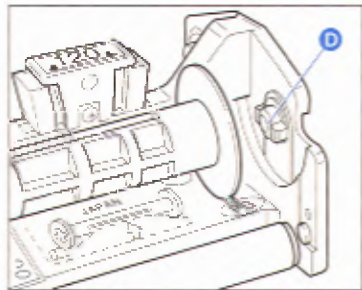

3. Align the right-hand side of this empty spool with the lower Spool Stud **D** (convex). Slide the spool into position making sure that the left-side of the spool is properly held by the Spool Clip.

When you load film for the first time, remove and discard the protective paper cover which is the film rails in the against camera body.

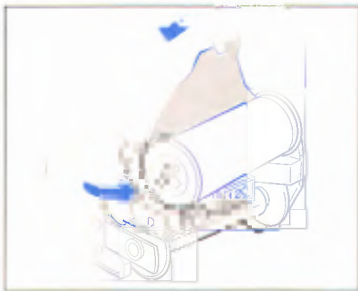

4. In the same manner, insert a roll of film in the upper compartment. At that time, check that the film leader paper is set as shown in the illustration above. (The leader paper inside is facing outward on the pressure plate. Note that the film direction is wrong if the leader paper is facing inward.)

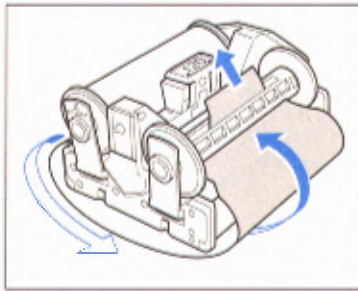
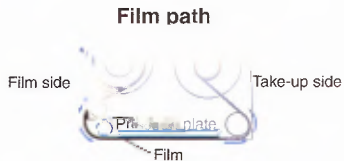

5. Pull some of the leader paper out and around the insert as shown above. Insert the tip into the slot on the lower Take-up Spool.

6. Gently rotate the take-up spool as shown in the illustration on the right until the start mark on the leader paper is aligned with the start mark (Δ) on the spool clip.

★ Correctly align the start marks with each other, making sure that the film feeds properly. When improper feeding occurs, the proper number of exposures may not be taken.

★ Avoid exposing the film to direct sunlight when inserting or removing film.

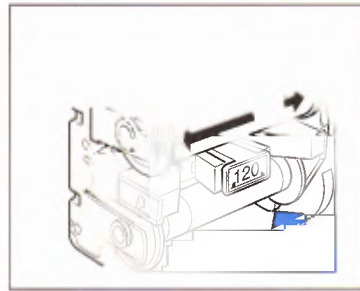

★ **220 Film Loading Caution:**
220 films have two types of Start Mark Lines across the paper leader. Always use the second one, a solid line with the legend "Start Mark for standard cameras", located about 14cm (5 1/2"), behind the first, dotted Mark line.



Do not use the dotted line for a start mark.

Advancing the Film to the First Frame

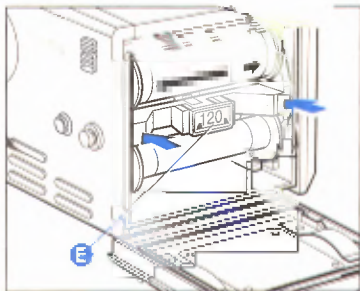

7. Insert the loaded Roll Film Insert into the camera body, the film roll on top, while squeezing on both sides of the Release Latch **E** as shown in illustration. Make sure that it is properly seated and locked in place. Then close cover by firmly pressing its top against the camera body.

★**To close the Back Cover, firmly press the top of the back cover on both sides.**

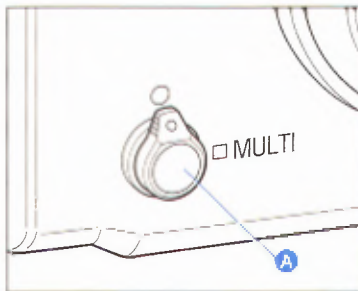

1. Set the multiple exposure switching lever **A** to the white dot (normal mode).

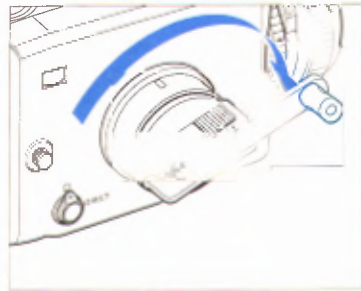

2. Wind up. Wind the crank handle forward until it stops. In the Film Counter Window, the number 1 appears, and the film and shutter are set.

AE Photography (Aperture Priority AE)

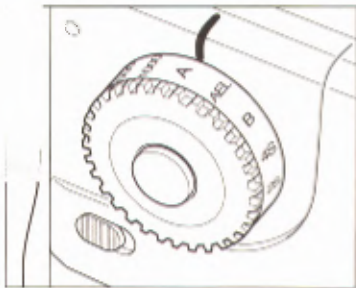

1. To switch to the AE mode, align "A" on the Shutter Speed Dial to the camera body at the index mark.

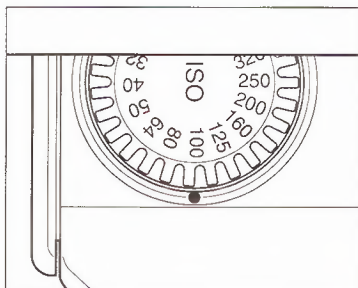

2. Make sure that you have properly set the speed of the film which you have loaded, on the ISO Dial of your camera body.

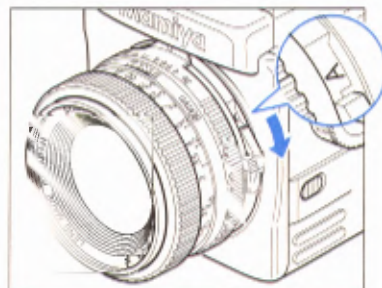

3. Before metering, make sure that the lens A-M Lever is set at "A".

★ When set at "M", correct exposure cannot be obtained. Also make sure that the Exposure Meter Coupler engages properly with the Aperture Ring coupling Pin. If they are not engaged properly, correct exposures cannot be obtained.



4. Set the desired f/stop on the Aperture Ring **A** by aligning the f/number with the Red Reference Dot **B** in the center of the Scale Ring. The Aperture Ring has a click stop for each f/stop. In-between settings can also be used.



5. After selecting the aperture, depress the Shutter Release Button half way and LEDs will illuminate in the viewfinder, and the correct shutter speed for the preselected aperture.

★ If during AE photography, two shutter speeds illuminate simultaneously in the viewfinder the shutter will make an exposure at an intermediate speed. For example, when speeds 1/60 and 1/125 sec. illuminate simultaneously, the shutter will expose at a speed between 1/60 and 1/125 sec.

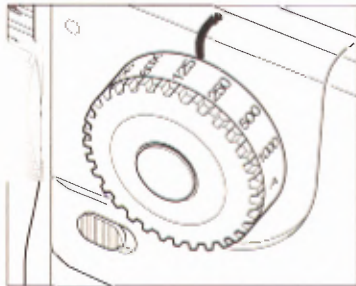
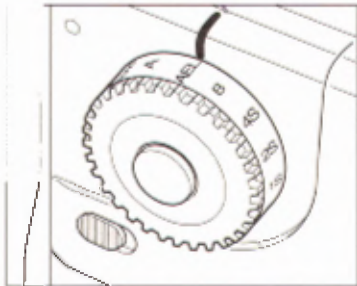

The AEL position is very useful when making selective exposure measurements of important subject areas which are not in the center of the screen.

1. Set the Shutter Speed Dial on the camera body to the AEL position.
2. While looking through the viewfinder, center the most important part of the subject in the center circle while keeping the Shutter Release Button depressed half way. In this state, the exposure reading is memorized. After adjusting for composition as desired, release the shutter by pressing the button all the way.

1. Set the Shutter Speed Dial to a position other "AE" or "AEL". When pressing the Shutter Release Button half way, the correct shutter speed for a preselected aperture will blink in the viewfinder (when two speeds blink, an intermediate speed is selected), and the shutter speed set on the body will illuminate.

2. In order to obtain a correct exposure, adjust the lens Aperture Ring or turn the Shutter Speed Dial until there is only one shutter speed illuminating in the viewfinder.

- ★ Please NOTE:
10 seconds after activation, the LEDs will go out. If they do so during metering, press the Shutter Release Button half way again.

LED Display in the View Finder

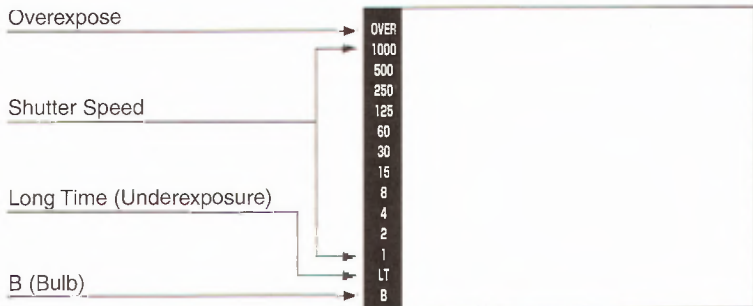

AE Photography

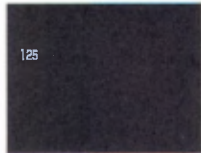

Proper speed illuminates

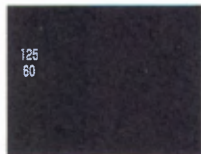

Proper speed
When two shutter speeds illuminate in the view-finder, an intermediate shutter speed will be selected as the proper speed.

AEL Photography

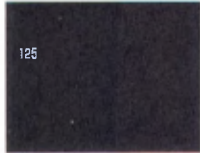

locked speed illuminates

Manual Photography



Set speed illuminates

Proper speed **blinks**



Set speed illuminates

Proper speed 1/45 sec.

Adjust the Lens Aperture Ring or turn the Shutter Speed Dial until there is only one shutter speed which is illuminated – now the shutter can be released.

Long Time Photography



LT (Long time)
illuminates

In the manual mode the shutter operates at the speed selected by the shutter speed dial. In AE mode the shutter is set automatically to give correct exposure at speeds between 4 and 1sec.

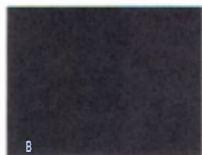

Bulb (B)
photography
illuminates



Overexposure
Blinks Quickly



Underexposure
Blinks Quickly



Battery Low
Blinks Slowly

- Proper value blinks in the AE mode



- Preset value blinks in the manual mode

Exposure Compensation Dial

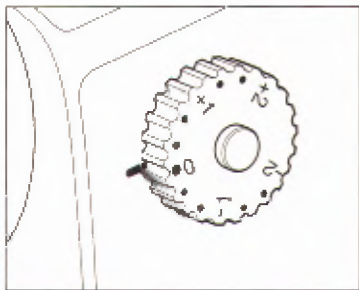

While pressing the Lock Release Button in the center of the Exposure Compensation Dial, turn the dial to select the desired compensation value. Within ± 2 EV the dial stops at 1/3 clickstop intervals. Turning the dial in the "+" direction increases exposure (OVER), while turning it in the "-" direction decreases exposure (UNDER). The Exposure Compensation Dial can be used not merely for exposure compensation under special shooting conditions, but also for special lighting techniques. (high key, low key, etc.)

Mirror Lock-up Photography in the AEL Mode

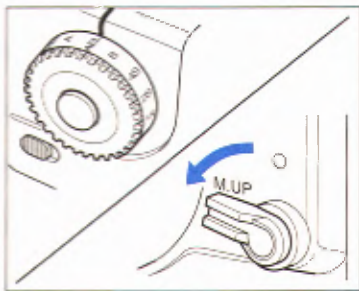

Set the Shutter Speed Dial to the "AEL" position. While pressing down on the Shutter Release Button half way, raise the Mirror Lock-up Lever and then release the shutter.

NOTE:

★ Only "AEL" in the Mirror Lock-up mode is possible.

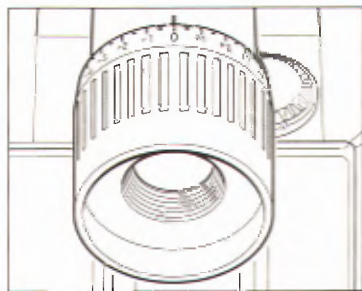

How to adjust the diopter to your eye

In order to obtain critical focusing, adjust the diopter setting for your eye sight.

1. Rotate the diopter adjustment ring until you can clearly see the lines on the camera's focusing screen.
2. Turn the lens Focusing Ring until a target appears sharp and clear and then make fine adjustment of the eyepiece diopter by rotating the diopter adjustment ring slightly.
3. Read the diopter scale and write down or remember the number for future use.

Focusing

While looking through the viewfinder, turn the lens Focusing Ring until the most important subject part appears sharp and clear.



1. The camera comes equipped with a bright, Rangefinder/Micro-prism Focusing Screen. It features a center, split-image rangefinder spot and the subject is in sharp focus when the split images combine into one.

2. The microprism ring around the split-image center further facilitates focusing. The microprisms disappear only when the subject is in sharp focus.



3. The rest of the ground glass area can also be used for focusing.

Depth of Field

Depth of field is defined as the zone of sharpness before and behind the plane of focus. It depends on camera / subject distance, focal length of lens, aperture setting and distance the lens is focused at.

Reading the Depth of Field Scale

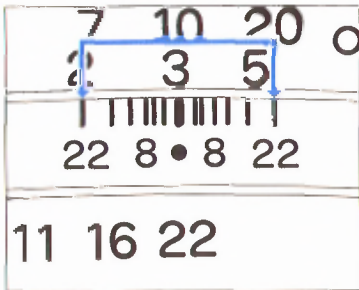

In addition to visual observation, the Depth of Field can be determined by using the Depth of Field Scale on each lens. *f/stop* numbers appear on both the right and left side of the red index mark in the center of the scale ring. Simply read the figures which appear above the *f/stop* numbers on the Distance Scale of the lens.

For example, with the 80mm *f/2.8N* lens focused at 3m and the aperture set at *f/22*, the Depth of Field Scale indicates that the zone of sharp focus will extend from about 2m to 6m.

Film Advance and Unloading Exposed Film

Film Advance

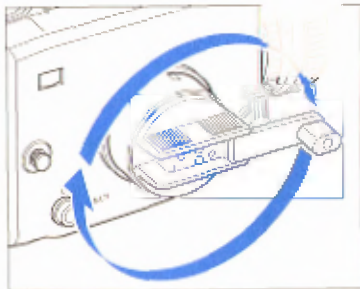

1. Giving the Film Advance Crank one complete turn, will cock the shutter and mirror and ready the camera for the next exposure.

2. When the film is completely exposed (15 exposures on 120, 30 on 220 film), the crank stop will disengage. Continue turning until the paper trailer is completely wound onto the take-up spool. (About five turns after the last exposure.)

Unloading Exposed Film

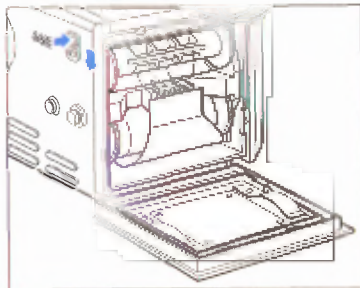

3. Open the Back Cover, and remove the Roll Film Insert. The Exposure Counter will return to S (start) automatically.

4. Pull the Spool Clip on the roll film insert out to remove the film.

5. Remove the film from the roll film insert; make sure that the film on the roll does not loosen, and seal immediately.

- ★ Move the empty spool from the top to the lower (take-up) compartment, ready for loading the next film roll.
- ★ Never load, unload or handle film in direct sunlight.

Mirror Lock-up Photography

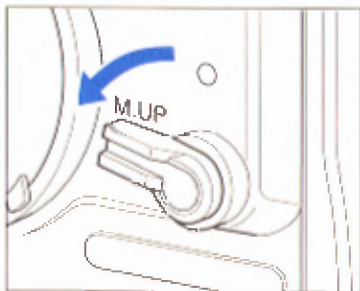

This is an important feature when the tripod mounted camera is used at slow or long exposure times and particularly also with use of long telephoto lenses. It eliminates the possibility of even the slightest “mirror bounce” which may affect image sharpness.

Move the Mirror Lock-up Lever to the white “M.UP” square, after you have composed and focused your picture. This will raise the mirror and the viewfinder image will be blacked out. After use, return lever to normal (white circle) position.

★ For AE photography, set the Shutter Speed Dial to “AEL”. Press the shutter release halfway and then lock the mirror up. If set to “A” and the mirror is locked up, “LT” (long time) will appear in the finder display and correct exposure cannot be obtained.



CAUTION

★ **When the mirror is locked in the up position.**

The Focal Plane Shutter Curtain may be damaged if the camera faces strong light sources, especially the sun. Return mirror to normal position or use lens cap to prevent such damage.

Multiple Exposures

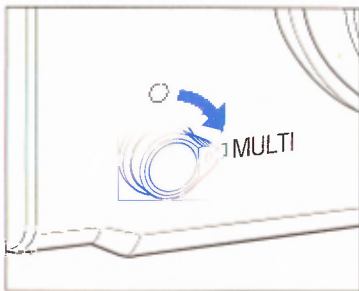

★ To override the multiple exposure mode or to return to normal operation, be sure to return the pointer against the white circle and then advance the film. (If you forget you will continue to make multiple exposures on the same frame.)

Aligning the pointer of the Multiple Exposure Lever with the "MULTI" square, disengages the multiple exposure prevention mechanism, and the film will not advance after an exposure is made and the Film Advance Crank is turned. However, the shutter will be recocked, thus making multiple exposures possible. In this mode the Exposure Counter will not advance.

Infrared Photography

Infrared light rays – being of longer wavelength – focus at a slightly different plane and require the following adjustment:

1. Note the Red Index Mark against which you read your distance scale. The red infrared index mark is slightly to its right.
2. After focusing in the usual manner, read the distance scale and move it to the right to line up with the infrared index mark.

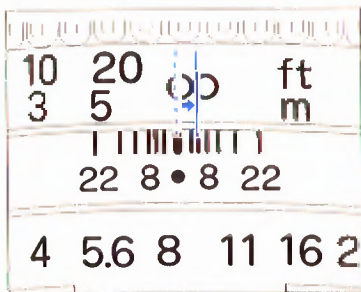

The 300mm and 500mm APO lenses for Mamiya 645 cameras, being also corrected for infrared light rays, do not need an index mark for infrared.

★ For proper filter and exposure information be sure to consult the instructions enclosed with infrared film.

Using a Tripod

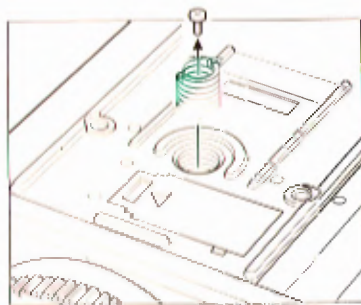

The Mamiya 645E Tripod Socket accepts a standard 1/4" tripod mounting screw. For use with tripods having 3/8" mounting screws, first unscrew the small black Philips head retaining screw in the center of the tripod socket. Then remove the 1/4" bushing with a thin coin. To re-install the 1/4" bushing, reverse the process.

Flash Photography

The bracket of a handle-mount flash unit can be attached to the camera's tripod socket. A shoe-mount flash can be attached to the camera's Hot-shoe.

★The Mamiya 645E has an X-sync terminal.

1. When using an electronic flash, plug the synchronization cord into the sync terminal and set the Shutter Speed Dial to 1/60 sec. or longer.

2. For M bulbs, set the Shutter Speed Dial to 1/15 sec. or longer.

- ★If the flash duration of an electronic flash is longer than 1/1000 sec., set the Shutter Speed Dial to 1/30 sec. or longer.
- ★When using flash, carefully read the instructions packed with the flash bulbs or flash unit to avoid making errors.

CAUTION

When using the Hot-shoe, be sure to insert the appropriate safety cover into the X-sync terminal. This procedure will prevent the possibility of receiving an electric shock while an electronic flash is attached if the terminal not being used is accidentally touched.

Flash Synchronization Chart

Sync Terminal	Shutter speeds											
	1/1000	1/500	1/250	1/125	1/60	1/30	1/15	1/8	1/4	1/2	1	2
X	Electronic flash						M Class					

Attaching and Removing the Neck Strap

Attaching the Strap to the Camera



1. While pushing down, pull out the Neck Strap Fastener **A** of the attaching clip.

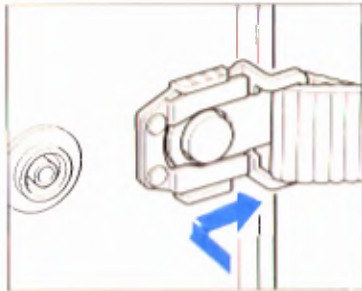

2. Place the hole of the strap fastener **A** over the Neck Strap on the camera body as illustrated, and pull until it clicks and locks into place.

Removing the Strap

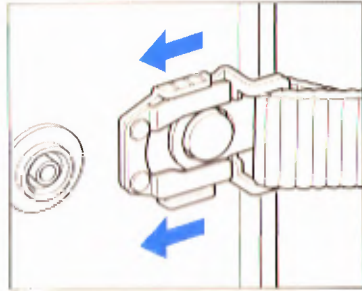

With your fingers, pull the Neck Strap Fastener **A** of the attaching clip upward and push past **B** in the direction of the arrow. The strap can now be removed.

Holding the Camera Steady and Securely

Eye-level Operation



Hold the camera as shown in the illustration, with its base resting on your left hand, the right hand supporting it from the side and top. Press both elbows against your body and activate the shutter release with a smooth, steady pressure.

System Chart

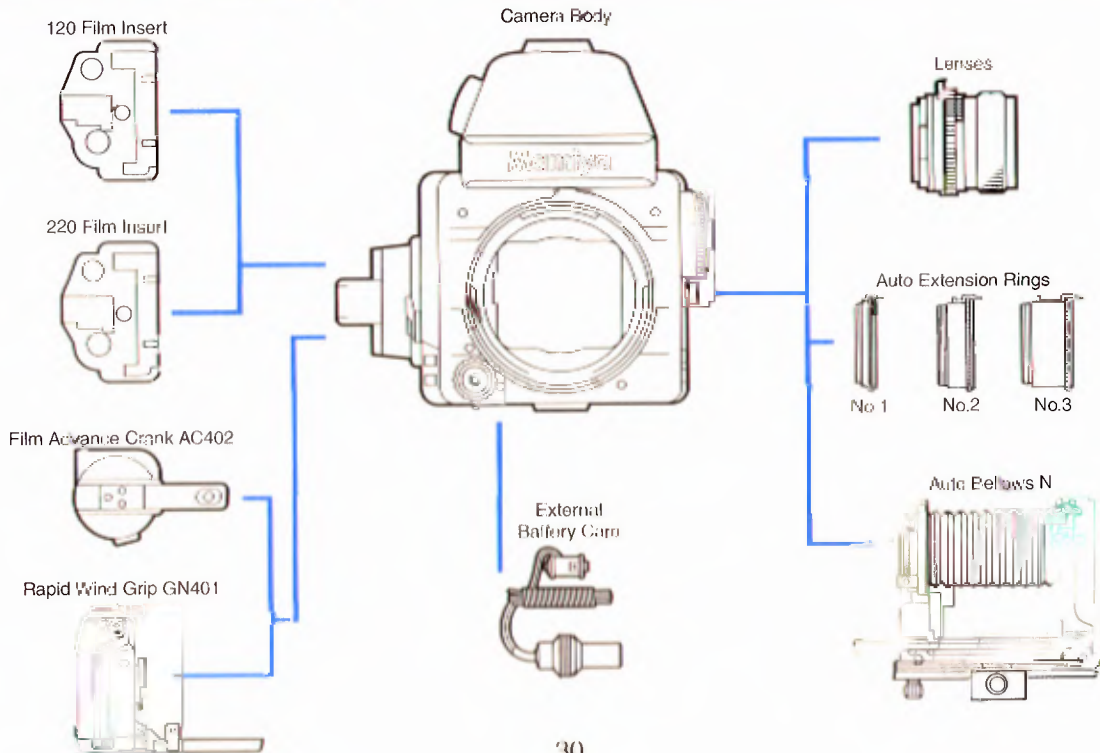

Trouble Shooting

★If the camera should fail to function properly, please check the following:

1. The Shutter Release Button cannot be depressed.

Push the Shutter Release Button.

If the LED does not light, check:

Is a Battery in the camera?

If yes, is it correctly inserted? (Polarity)

Is it dead?

2. The finder is black or very dark.

Has the Lens Cap been removed?

Is the Mirror Lock-up Lever in the "M.UP" position?

If so, turn the lever to the White Dot.

Is the "AM" setting on the lens at "M" (Depth of Field Preview)?

If so, move it to "A".

3. The developed film has fewer exposures than specified.
Most likely the Start Mark had not been aligned properly when the film was loaded. (See loading instructions page)
4. The Film Advance Crank continues to turn and does not stop.
Was the Roll Film Insert placed in the camera?
Was the empty film spool left in the upper compartment?

Mamiya 645E Specifications

Type	: Single-lens reflex camera with electronic focal-plane shutter; 6 X 4.5cm format	Exposure sensitivity:	EV 2 (f/2.8; 2 sec.) to EV 19 (f/22; 1/1000 sec.) for f/2.8 lens with ISO 100 film
Image area	: 56 X 41.5mm	Exposure compensation	: +/- 2 EV in 1/3 steps; adjustment dial
Film	: 120/220 roll film (15/30 frames)	Film speeds	: ISO 25-800 (1/3-step settings); set on film speed dial
Film insert	: 120 and 220 film types	AE lock function	: Set using AEL setting on shutter speed dial
Film winding	: Single-throw 360° crank	Shutter	: Moving coil electronic focal-plane shutter
Standard lens	: Mamiya-Sekor 80mm f/2.8 N (selection of 21 interchangeable lenses)	Shutter speeds	: 1/1000 sec. to 8 sec. in AE mode; 1/1000 sec. to 4 sec. plus B in manual mode
Lens mount	: Mamiya 645 bayonet mount	Flash synch	: X synch up to 1/60 sec. (lock function)
Finder	: Reflex eye-level finder showing 94%* of image area; built-in eyepiece correction of +/-5 diopter	Multiple exposure	: Activated by lever on camera body
Finder screen	: Micro split-image	Mirror-up	: Mirror-up lever on camera body
Finder indicators	: LED indicator of AE-adjusted shutter speed; over-exposure warning; LT shutter setting	Cable release socket	: Built into shutter release
Exposure control	: Aperture-priority auto-exposure; manual controls	Tripod mount	: U 1/4-inch and U 3/8-inch screw mounts
Incremental settings	: 1 step shutter settings; 0.5 step aperture settings	Battery requirement:	One 6-volt (4 LR 44 alkaline-manganese battery, 4 SR 44 silver-oxide battery ; 2 CR 1/3 N lithium battery) cell
Metering	: Center-weighted TTL metering in AE or manual modes; metering activated by slight pressure on shutter release button, remains on for 10 sec.	Dimensions	: 135(W) X 134.2(H) X 163.8(D)mm
		Weight	: 1,340g(w/o battery)

* This information is based on a basic horizontal/vertical measurement. Specifications and features are subject to change without notice.

Common Sense Camera Care and Practice

The Mamiya 645 E is a precision optical/mechanical instrument, built for heavy professional use and a long service life, if properly treated and maintained. Please observe these basic caveats:

- Read instructions before using camera.
- Protect camera against shocks and falls. Use neck strap supplied with it, whenever possible.
- Check the battery frequently and always carry spares. The sealed battery supplied with the camera may have been subject to storage conditions which have reduced its service life.
- Be sure to wipe battery contacts before installation and watch correct polarity.
- Battery life differs, depending on frequency of use, type, age, storage condition, ambient temperature (use External Battery Case in very cold weather), etc.
- Always remove the battery (and film) when camera is not used for a period of time.
- Always keep covers on lenses and camera body.
- Do not store the camera at temperatures exceeding 40°C (105°F) and -10°C (15°F). Also avoid humid or sea air environment.
- Prolonged disuse shortens camera life. Periodically exercise the shutter (at different speeds, lens diaphragms and focusing mounts.).
- Protect camera against rain and moisture.
- Do not touch lens surfaces. Use blower or lens tissue to remove dust particles.

Specific Suggestions:

- Operate the film advance lever with easy strokes. If moved too rapidly it may affect spacing.
- Always test your equipment before going on important assignments.

The Importance of Proper Maintenance

Your camera has mechanisms like film transport, shutter and diaphragm blades, etc. They are controlled by gears, levers, springs, and so on. All require special lubrication from time to time. Ambient conditions can also affect these mechanisms, as well as the electronic components and the optical glass of your lenses. We therefore suggest that you have your camera and lenses checked, and if necessary serviced, periodically.

Batteries Care

1. The sealed, new battery which is supplied with this camera may have been subject to storage conditions which have reduced its service life. Therefore it is desirable to replace it with a fresh battery as soon as possible.
2. Carefully wipe the battery contacts before inserting into the chamber. Failure to do so may result in poor electrical contact and consequent malfunctioning of the camera.
3. Always remove battery when camera is not used for a while. Always carry spare batteries.
4. Battery life differs, depending on type, age, storage condition, ambient temperature, frequency of use etc.
5. Be sure to match the poles of the battery with those shown in the diagram in the chamber.
6. Always keep batteries out of the reach of children and never throw used batteries into a fire or expose to excessive heat.
7. When going on trips be sure to carry spare batteries to ensure that the camera will function. Also, as batteries tend to temporarily malfunction at temperatures below freezing, when photographing in extremely cold climates, carry the External Battery Case.
8. When you carry spare batteries, leave them in the original factory packaging. If they are "unpacked", be sure to wrap them carefully in order to prevent them touching each other or any metal objects which can cause them to short circuit and become useless.

Name of Parts (2)

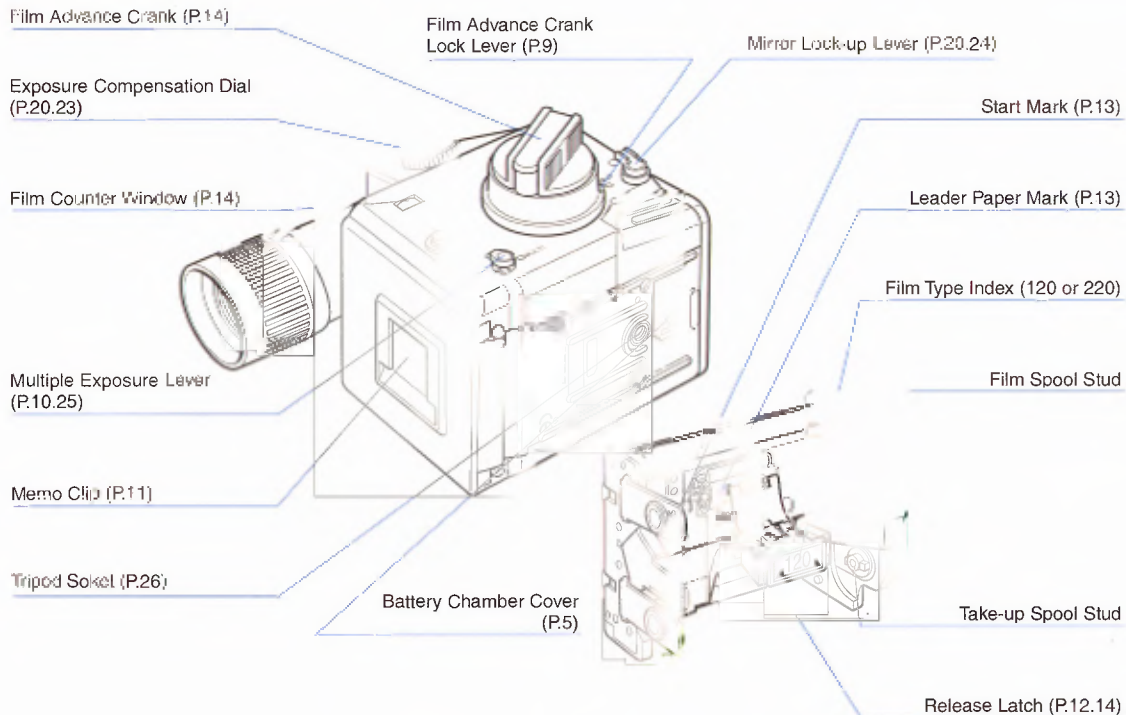

After-Sale Servicing

- ☆ Be sure to read the terms and conditions in the warranty card.
- ☆ Servicing of malfunction or damage due to dropping, impact, fire, flood, etc.
 - 1) The degree of such a malfunction or damage will be judged by the Mamiya service department.
 - 2) Such a malfunction or damage will be classified either non-serviceable or serviceable. When the product is classified to be serviceable, it will be repaired at the expense of the user, even if the malfunction or damage occurred within the warranty period.

Special Advice to Professional Photographers

Your Mamiya 645E is designed for heavy professional use and will give you a long service life if properly maintained. Your camera and lenses have many moving parts which require periodic lubrication. Its electronic components, too, are subject to wear and tear and are affected by ambient conditions like dust sand, sea air, heat and moisture.

If cameras had odometers like automobiles, it would be easier to specify servicing schedules. May we suggest that if you shoot thousands rolls per year, you send your equipment annually for servicing to the Mamiya distributor in your country.

Mamiya

Mamiya-OP Co., Ltd.