

# Mamiya 645AFD III

# Mamiya

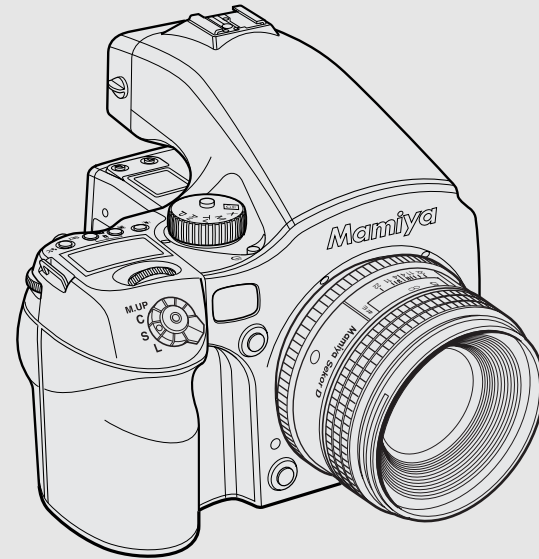

英語

Printed in Japan  
320200-HG-01E

Mamiya Digital Imaging Co., Ltd.

Instructions

## Congratulations on your purchase of the Mamiya 645 AFD III Camera.

1

Mamiya pioneered the 645 SLR system camera three decades ago and the Mamiya 645 AFD III, with its TTL auto-focus, auto-exposure, auto-flash and auto-film winding features is the latest Mamiya masterpiece and reflects its long tradition of medium format camera expertise.

2

Combining 35mm handling ease and speed but with an image size almost 3 times larger, it is a full-featured camera, utilizing many digital controls and LCD displays, deeming it appropriate for the age of digital photography.

3

Its high-tech focal plane shutter with speeds up to 1/4000 sec. permits flash sync up to 1/125 sec. and has an exclusive "Safety Retraction" feature, which protects it against accidental damage.

4

The AE Prism Finder with its many features, protected by a sturdy magnesium housing, and also the Power Drive Grip, are now integral components of the die cast aluminum camera body, designed for heavy professional use.

5

All the many features, safety interlocks and other important information are covered in detail in these instructions. It is imperative that you read them thoroughly before you put your camera to work, in order to ensure proper operation and maximum results.

### Note:

In order to acquaint yourself with the functions of the camera, you will want to practice without film. Please see the page 9 how the camera can be tested without film.

## Special Advice To Professional Photographers

Your Mamiya 645 AFD III is designed for heavy professional use and will give you a long service life if properly maintained. Your camera and lenses have many moving parts which require periodic lubrication. Its electronic components, too, are subject to wear and tear and are affected by ambient conditions like dust, sand, sea air, heat and moisture.

If cameras had odometers like automobiles, it would be easier to specify servicing schedules. May we suggest that if you shoot thousands of film rolls per year, you send your equipment annually for servicing to the Mamiya distributor in your country.

Mamiya 645 AFD III corresponds with digital backs compatible with MSCE (Mamiya Serial Communication of External) system.

# Names of Parts and Functions

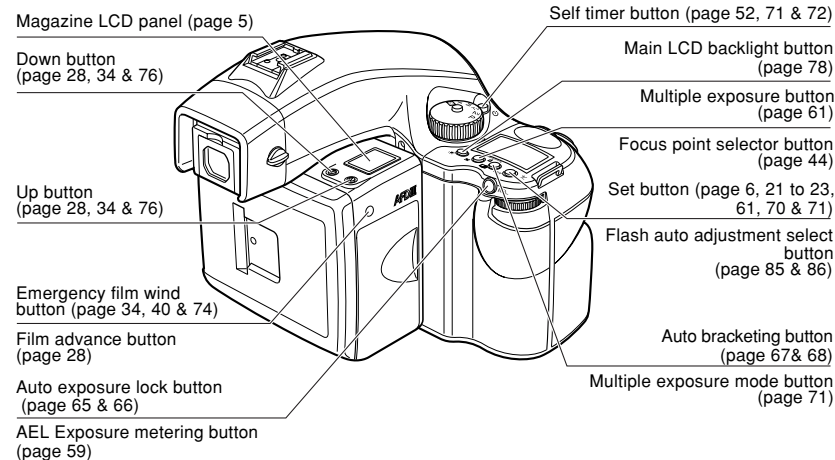
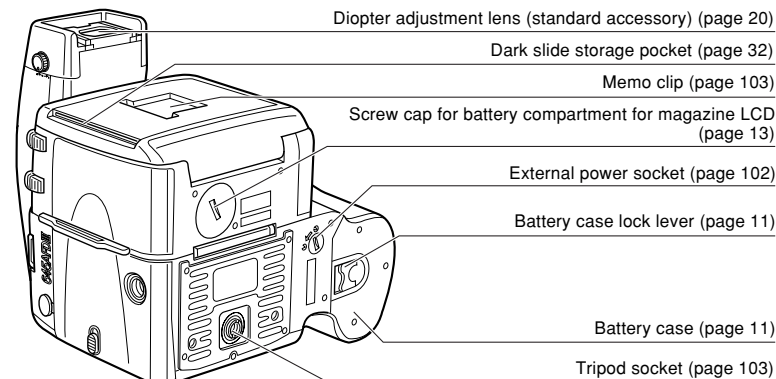
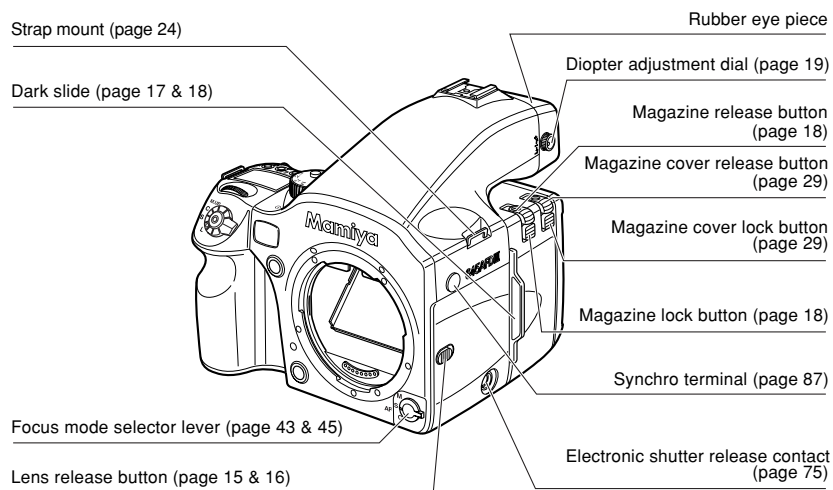
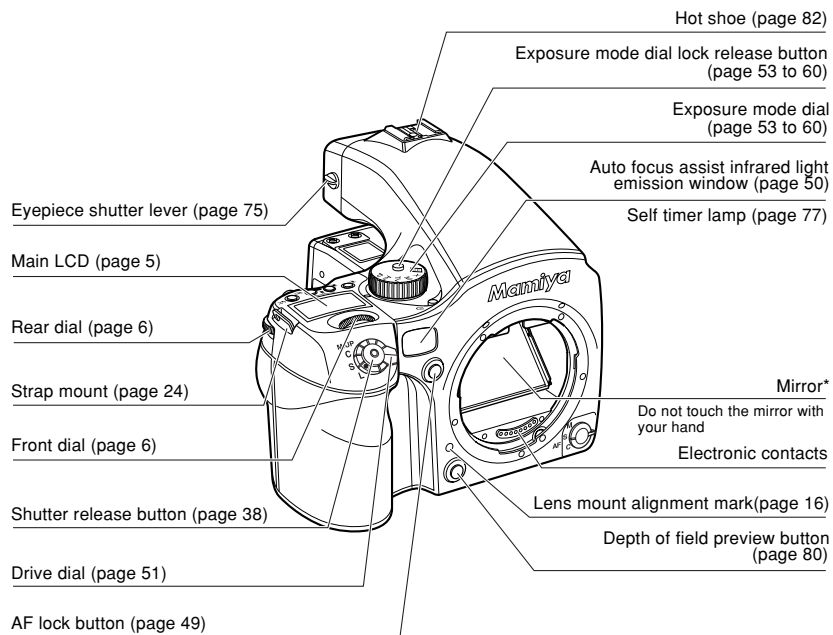

# Liquid Crystal Displays (LCD)

## Main LCD

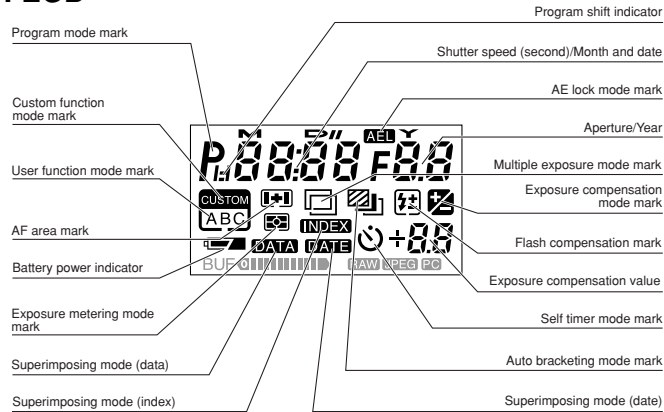

During actual use, only the relevant icons and indicators are displayed.

### Displayed when ZD Back is installed

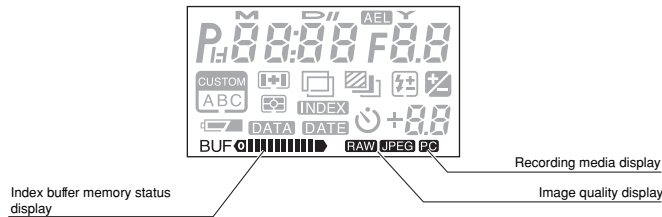

During actual use, only the relevant icons and indicators are displayed.

## Magazine LCD

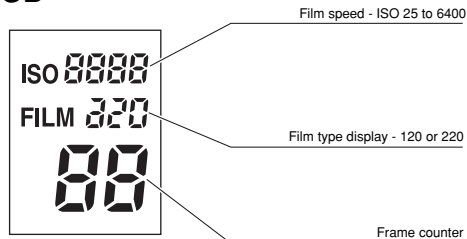

During actual use, only the relevant icons and indicators are displayed.

## Viewfinder LCD

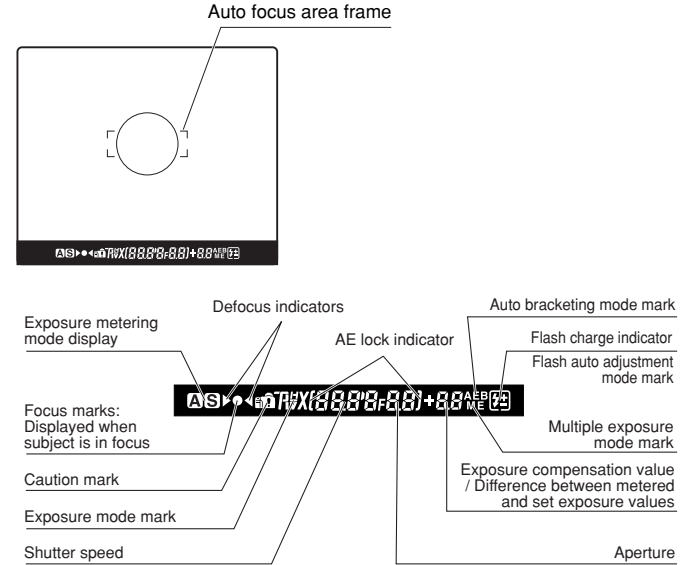

During actual use, only the relevant icons and indicators are displayed.

## Electronic Dial Operation

	Position	Front dial	Rear dial
Exposure mode	P	Program shift (PH P PL)	
	Av	Aperture adjustment	
	Tv	Shutter speed adjustment	
	M	Shutter speed adjustment	Aperture adjustment
	X	Aperture adjustment	
Multiple exposure button	[M] displayed	Number of exposures	
Auto-bracketing button	[AB] displayed	Increment for bracketing and number of frames	Turn the auto bracket ON/OFF
Flash auto adjustment select button	[FL] displayed	Flash metering compensation (when using Metz flash and SCA3952 adaptor)	

Preface .....	1 to 2	Exposure Modes .....	53 to 60
Names of Parts and Functions .....	3 to 4	Program AE (P) .....	53
Liquid Crystal Displays (LCD) .....	5	Program Shift (P <sub>H</sub> /P <sub>L</sub> ) .....	53 to 54
Electronic Dial Operation .....	6	Aperture Priority AE (Av) .....	55
Camera Operation Test .....	9	Shutter Priority AE (Tv) .....	56
Before Taking Photographs .....	10 to 24	Manual Mode (M) .....	57 to 59
Inserting the Batteries .....	11	One-push shift function .....	59
Checking the Battery Power .....	12	X Mode (X) .....	60
Installing the Battery in the Magazine .....	13	CF (Custom Function) Mode (CF) .....	60
Battery Power .....	14	<b>Exposure Metering Modes .....</b>	<b>61 to 62</b>
Battery Care .....	14	Average/spot auto exposure metering .....	61
Attaching and Removing a Lens .....	15 to 16	Center-weighted average/spot exposure metering .....	61
Attaching / Detaching a Magazine .....	17 to 18	Center spot exposure metering .....	61
Diopter Adjustment .....	19	<b>Exposure Warnings .....</b>	<b>62</b>
Replacing the Diopter Correction Lens .....	20	<b>Exposure Compensation .....</b>	<b>63 to 64</b>
Setting the Index Number .....	21 to 22	<b>AE Lock Mode .....</b>	<b>65 to 66</b>
Setting Date and Time .....	23 to 24	<b>Auto Bracketing Mode .....</b>	<b>67 to 69</b>
Strap .....	24	<b>Multiple Exposure Mode .....</b>	<b>70 to 72</b>
Basic Operation .....	26 to 41	<b>Taking Photos with the Mirror Up .....</b>	<b>73 to 74</b>
Attaching a Lens and a Magazine .....	27	<b>Electronic Shutter Release Contact .....</b>	<b>75</b>
Setting the Film Speed .....	28	<b>Eyepiece Shutter .....</b>	<b>75</b>
Loading Film in the Magazine .....	29 to 33	<b>Selecting the Number of Frames to be Shot .....</b>	<b>76</b>
Selecting the Shooting Frame Number Display .....	34	<b>Self Timer Mode .....</b>	<b>77</b>
Taking Photos in the Fully Automatic Mode .....	35 to 39	<b>Long Exposure Mode (Bulb Mode) .....</b>	<b>78</b>
Shutter Release Button .....	38	<b>Backlight Button .....</b>	<b>78</b>
Holding the Camera .....	38	<b>Front / Rear Dial Lock Function .....</b>	<b>79</b>
Removing a Partially Exposed Roll of Film .....	40	<b>Depth of Field .....</b>	<b>80</b>
Electrical Contacts .....	41	<b>Depth of Field Preview Button .....</b>	<b>80</b>
Advanced Photography and Various Functions .....	42 to 88	<b>Infrared Photography .....</b>	<b>81</b>
<b>Focus Modes .....</b>	<b>43 to 47</b>	<b>Flash Photography .....</b>	<b>82 to 87</b>
Single focus mode .....	43	<b>Rear Curtain Sync Mode .....</b>	<b>83</b>
Continuous focus mode .....	43	<b>Metz Flash SCA3952 System Functions .....</b>	<b>84</b>
<b>Focus area .....</b>	<b>44</b>	<b>Flash Compensation Settings .....</b>	<b>85 to 86</b>
Normal focus area .....	44	<b>Superimposing Data .....</b>	<b>88</b>
Spot focus area .....	44	<b>Custom Functions .....</b>	<b>90 to 96</b>
Selecting the focus area .....	44	Setting Custom Functions .....	91
<b>Manual Focus Mode .....</b>	<b>45 to 47</b>	Custom Functions of MAMIYA 645AFD III .....	92
Manual focus mode .....	45	Types of Custom Functions .....	93 to 96
Lenses with the focus mode selector .....	46	<b>Miscellaneous Operations .....</b>	<b>98 to 110</b>
Manual focusing using the focus mark .....	47	Changing the Focusing Screen .....	99 to 100
<b>When Auto Focus Fails .....</b>	<b>48</b>	Using the M645 Manual Focus Lenses .....	101
<b>Using the Focus Lock Function .....</b>	<b>49</b>	External Battery Socket .....	102
<b>AF Assist Infrared Light .....</b>	<b>50</b>	Tripod .....	103
<b>Drive Modes .....</b>	<b>51 to 52</b>	Memo Clip .....	103
Single-Frame Mode .....	51	When You Think Something Might Be “Faulty” .....	104
Continuous Mode .....	51	When Any of These Displays Appear .....	105 to 106
Mirror up Shooting .....	51	<b>Specifications .....</b>	<b>107 to 108</b>
Self-Timer Mode .....	52	<b>Common Sense Camera Care and Practice .....</b>	<b>109 to 110</b>
		<b>Maintenance and check of the camera .....</b>	<b>109</b>
		<b>After-Sales Servicing .....</b>	<b>110</b>

## Camera Operation Test

This is a simple way to test the camera and auto focus without film.



"P" Mode is the easiest.  
You may use any mode but "CF".

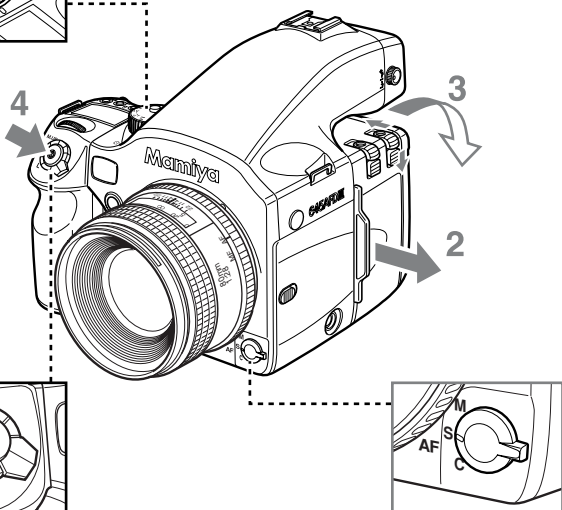

1. Set the shutter release mode selector lever to "S" (to turn the power on. See page 35).

2. Remove the Dark Slide from the magazine. (See page 32)

3. Open the back cover of the magazine. (See page 29)

4. Set the auto focus mode selector lever to "S". (See page 43)

5. Release the shutter. (See page 38)

MEMO

The camera can be set to release the shutter when the back cover is closed.

➔ Custom settings (C-30 on page 96).

## Before Taking Photographs

### Preparation before taking photographs

This chapter describes how to put in the batteries, how to install and remove the lens, and how to install and remove the magazine.

# Inserting the Batteries (The camera will not operate without batteries)

Set the drive dial to "L" to turn off the power.  
Use six "AA" alkaline or lithium batteries.

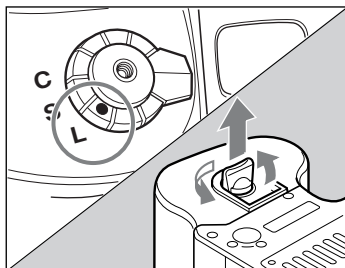

1. Lift the battery case lock lever, turn it counter clockwise and pull out the battery holder.

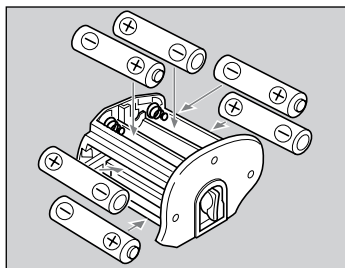

2. Install the batteries while ensuring their polarities are properly aligned with the ⊕ and ⊖ markings on the battery case.

**Be sure the batteries are placed with proper polarity**

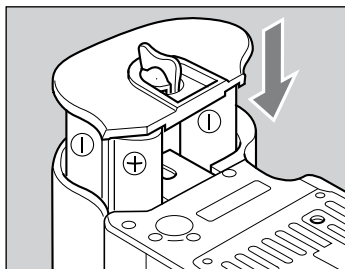

3. Return the battery holder to its case and lock it by turning the lever clockwise. Make sure it is firmly attached.

After inserting the batteries, set the date and time. (See page 23.)

**MEMO** Rechargeable nickel-metal hydride (Ni-MH) or nickel-cadmium (Ni-Cd) batteries can be used. → Custom settings (C-07 on page 93)

# Checking the Battery Power

Set the drive dial to "S" to turn on the power.  
Check the battery condition in the lower right corner of the main LCD.



The batteries are sufficiently charged.



There is little power remaining. Have new batteries on hand. Camera will still operate.



Flashing

There is very little power remaining. Camera will stop operating soon.

**Set the shutter release mode selector lever to "L" (to turn the power off) and replace the batteries with new ones.**



Flashing

**When the batteries are spent, "batt" flashes on the main LCD and the viewfinder's LCD when the shutter release button is pressed.**

**When replacing the batteries, be sure to use six new batteries of the same type. Do not mix different types of batteries or old batteries with new ones.**

## Number of rolls that can be exposed with a new set of batteries

At normal temperature (20°C) (68°F) (under our test conditions)

	Alkaline battery
120 type film	Approx. 150
220 type film	Approx. 130
Bulb time	Approx. 18 hours

10°C (14°F)

	Alkaline battery
120 type film	Approx. 25
220 type film	Approx. 25
Bulb time	Approx. 8 hours

The button battery supplies power to the magazine's LCD when the film magazine is detached from the camera.

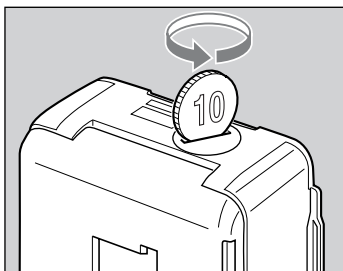

## 1. Remove the battery compartment screw cap.

Use a coin or suitable screw driver and turn it counter clockwise.

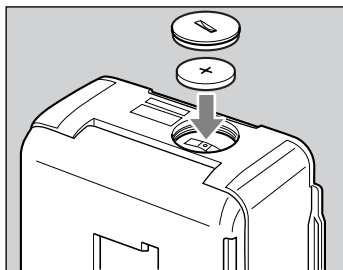

## 2. Insert a battery.

Insert the battery according to the polarity indication ⊕ in the battery compartment, and close the battery cover.

Battery used: Sony CR2032 or equivalent

**Be sure to insert the battery with the correct polarity**

When the magazine is installed onto the body, the power will be supplied to the magazine from the camera body.

You can take shots without installing the battery into the magazine. However, if you remove the magazine from the body, the magazine does not indicate film sensitivity or number of shots.

The magazine does not have a battery level indicator. When the magazine LCD panel becomes dark or disappears, replace the battery. As a rough guideline, the battery should last approx. one year.

## Battery power



Remaining battery charge display

The camera's power is turned on when the drive dial is set to "S," "C" or "M.UP." In order to prevent the camera's batteries from discharging, sleep mode is automatically established if no operations are performed for a specific period of time while the power is ON (with exposure metering status maintained).

The initial setting for the exposure metering status maintenance period is 15 seconds. It can be changed at any time to a period within a 5- to 60-second range using the custom settings. (C-04 on page 93)

In sleep mode, operating the shutter button or function setting button restores power ON status.

In sleep mode, the shutter speed and f-number among the external LCDs go off, and the marks shown in the figure are displayed. (These marks appear in program AE mode.)

**For the purpose of the descriptions and explanations provided in these instructions, it is assumed that the camera's power is on.**

## Batteries Care

1. Battery life of the originally supplied batteries is dependant on storage conditions.
2. Blots and fingerprints on terminals may cause loose connection and corrosion. Wipe them off before loading the batteries.
3. It is advised to carry spare batteries in remote or foreign locations.
4. Battery performance decreases in low temperatures. Keep them warm when in cold climates or locations.  
External battery case PE401 is available as an optional accessory.
5. Store the batteries in a cool and dry place, away from direct sunlight.
6. Remove the batteries from the camera body when they will not be used for a long time.
7. Replace the batteries with new ones as soon as they are exhausted. Liquid leakage from the battery may damage the camera.
8. Read the label warnings of the batteries for their handling.



# Attaching and Removing a Lens

## Attaching

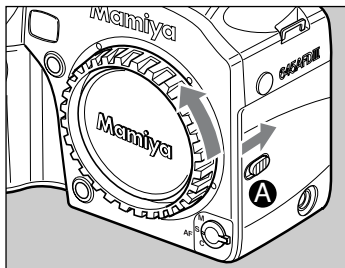

1. Remove the front body cap, just like you would remove a lens, by pushing the lens release button **A** backward and then turn the front body cap or the lens itself counter clockwise and lift out.

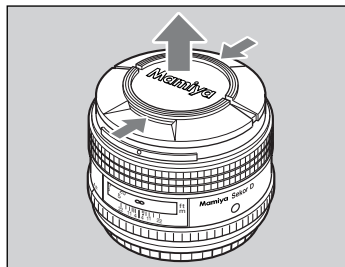

To remove the front lens cap, squeeze the shiny sections together and lift out.

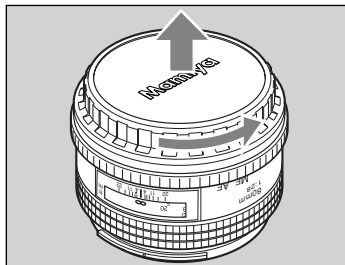

To remove rear lens cap turn it counter clockwise.

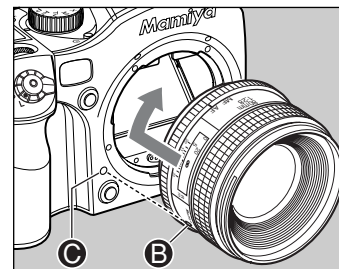

## 2. Attaching the lens

Line up the lens mount alignment mark **B** with mark **C** on the camera to fit the lens in place, then rotate it in the direction of the arrow until it clicks into place.

Do not touch the distance ring or other rotating parts when attaching the lens.

When installing a lens, do not press the lens release button **A**.

## Removing

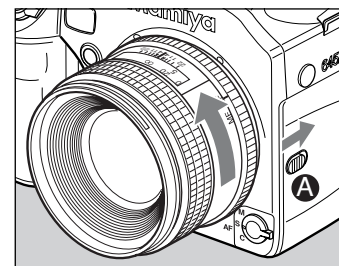

While sliding the lens release button back **A**, rotate the lens counter clockwise until it stops and lift it off.

After removing the lens from the camera body, protect both ends by attaching the caps.

Oil, dust, fingerprints or water on the electronic contacts could result in malfunction or corrosion. Wipe such impurities off with a clean piece of cloth.

# Attaching / Detaching a Magazine

## Installation and removal of the magazine and its dark slide

Unless the dark slide is inserted in the magazine, you cannot install and remove the magazine. When the camera batteries power is low, or batteries are not installed, the dark slide cannot be removed although the magazine can be mounted or removed.

**The magazine cannot be loaded in the camera unless the pull-out cover is inserted into place.**

## Before installation

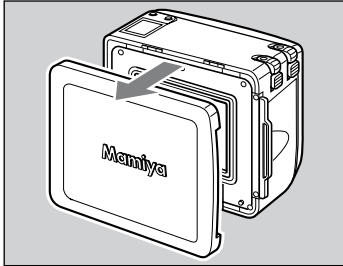

1. Remove the magazine protection cap.

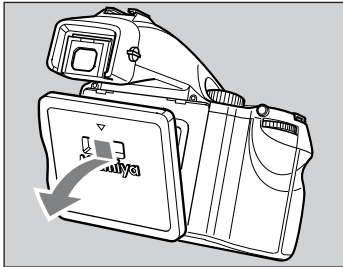

2. Remove the camera rear cap by putting a finger into the notch and sliding the cap down.

## Attaching

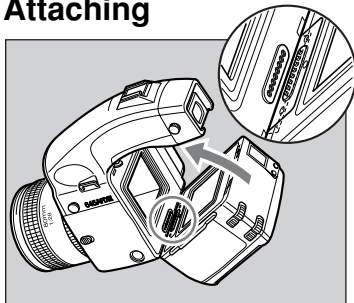

1. Fit the bracket at the bottom of the interface of the camera body with the groove on the magazine.

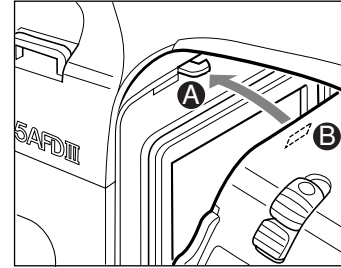

2. Press the magazine to the camera body, then the couplers on the camera body and the magazine together. You will hear the shutter and mirror click into the shooting position.

## Shutter Safety Retraction

The precision shutter blades are made of very thin hyper-duralumin and could be damaged if unprotected. When the magazine is loaded into the camera, the mirror and shutter are set to their home positions, and the camera's operation lock is released.

**The shutter auto open/close unit will not be activated when batteries have not been installed inside the camera.**

## Detaching

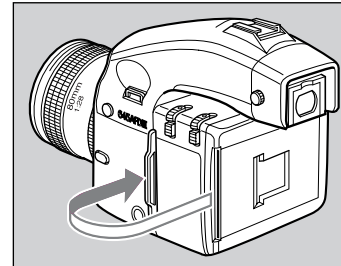

1. Insert the dark slide into the magazine.

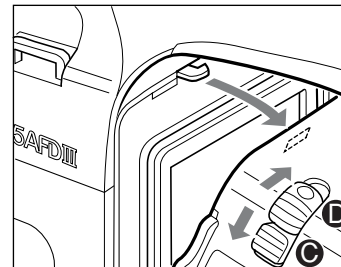

2. With your thumb first push button C down and then simultaneously button D in. The magazine will separate itself from the camera body.

**When the magazine is removed, the shutter will automatically open, as explained above, under "Shutter Safety Retraction"**

**Film winding and shutter release are also locked.**

## Dioptr Adjustment

Look through the viewfinder and make sure that the focus frame (Rectangle with Circle) is in sharp focus. If it is not, turn the diopter adjustment dial in the “-” direction if you are nearsighted, in the “+” direction if you are farsighted. If this is not sufficient you may require an optional diopter correction lens. See below.

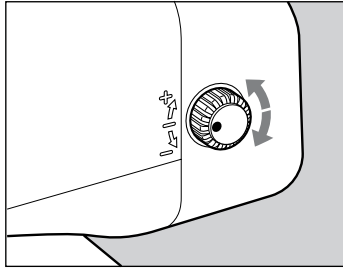

Point the camera at a bright, plain object such as a white wall when making this adjustment.

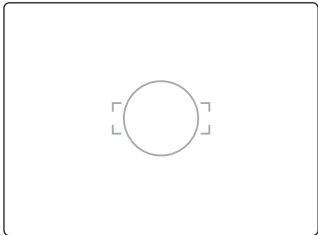

Dioptr not matching.

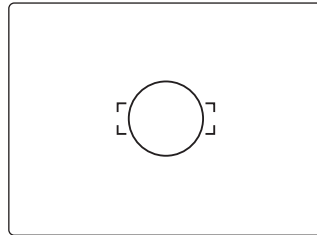

Dioptr matching.

### Range of adjustment of diopter correction lenses (Optional accessory)

Diopter correction lens	Range of adjustment
DE401 (standard)	-2.5 to +0.5
DE402 (for nearsighted users)	-5.0 to -2.0
DE403 (for farsighted users)	0 to +3.0

## Replacing the Diopter Correction Lens

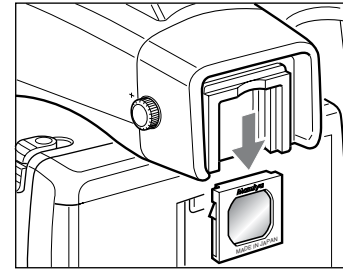

1. Remove the lens supplied with the finder by pulling it downward.

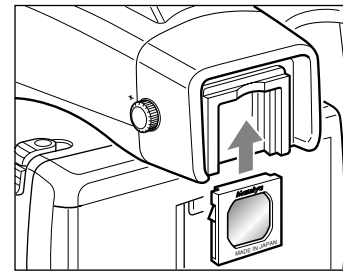

2. Push the replacement diopter correction lens upward into the viewfinder's eyepiece frame until it clicks into place.

If there is dirt or dust on the lens surface, remove it with a blower or sweep it off gently with a lens brush.

If there are fingerprints or dirt on the lens surface, wipe them off with a piece of clean, soft gauze.

Using solvents could discolor the diopter correction lens frame.

# Setting the Index Number

The index numbers are indicated in four digits (0000 to 9999). The index number is stored in the camera body so that when replacing a series of roll film holders, the camera will superimpose sequential index numbers on exposures. This is effective when exposing and managing a large number of rolls of different types of film.

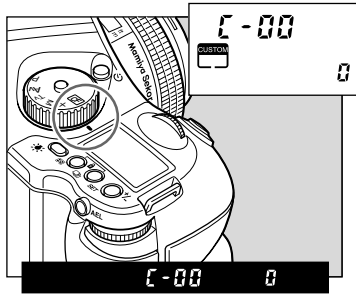

1. Turn on the power.  
Set the shutter release mode selector lever to "S" or "C."

2. Press and hold down the exposure mode dial lock-release button. Then, turn the exposure mode dial to the CF position.

3. Turn the front dial to select custom number C-35.

The display turns from "C-35" to "Id" immediately.

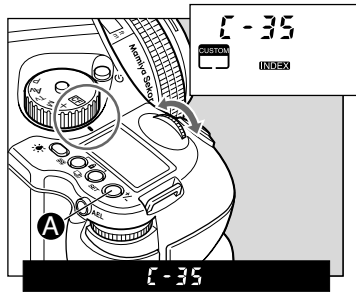

The dial can be turned either way to select the desired function number.

4. Press the set button  
After pressing the set button **A** you will see the index setting display.

5. Turn the front and rear dials to set the index number. (4 digits). Turn the front dial to select a digit in the index number (the selected digit blinks) and then change the number by turning the rear dial.

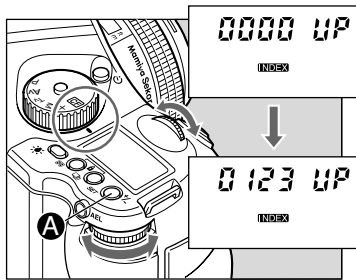

If you store the setting with "HL" blinking, the specified index number will be superimposed on every frame. Set to "UP" if you wish the index number to be increased after each shot.

6. After the index number is specified, press the set button **A** for approximately one second to store the setting.

In the default setting the index number is not imprinted. Change the setting in C-02 of the custom setting mode (see page 93). If film is not loaded, the index number will not change.

The starting index number can be set at will. For example, when shooting in different places or for different purposes, you can classify the photos by changing the starting number of any of the digits.

Once the last three digits reach 9999, they will restart from 0000 and the thousands place will be increased by one. 0000 can also be set using the index number setting procedure.

After 60 seconds, the index number setting mode is cancelled and the setting is not registered to the camera's memory unless the set button has been pressed.

Custom settings remain in the memory even when the shutter release mode selector lever is set to "L" (turning the power off).

When the exposure mode is not set to the CF position and you press the set button for approximately 2 seconds, you can check the index number for the next frame. Pressing the set button again will let you to check the "month-date-year" and "hour-minute" settings.

## How to imprint the same index number

It is possible to always imprint the same index number that has been previously set.

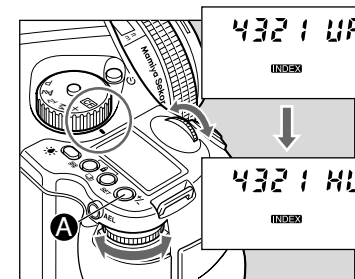

The procedure is the same as that taken up to step 4. of the index number setting procedure.

1. Turn the front dial until "UP" starts blinking.

2. Turn the rear dial until "HL" is displayed.

3. Press the SET button **A** for about 1 second to enter the setting.

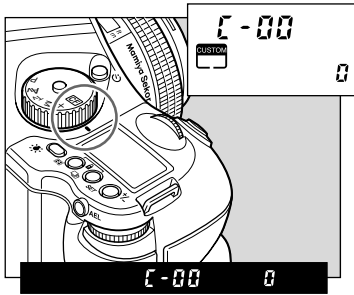

1. Turn on the power.  
Set the shutter release mode selector lever to "S" or "C."

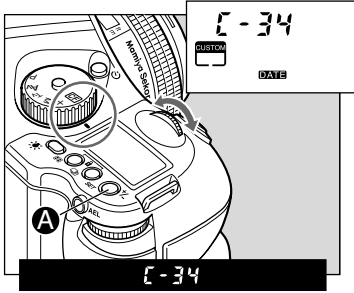

2. Turn the front dial, and select custom number C-34.

3. Press the SET button.  
When SET button **A** is pressed, the mode changes to the date setting display.

The dial can be turned either way to select the desired function number.

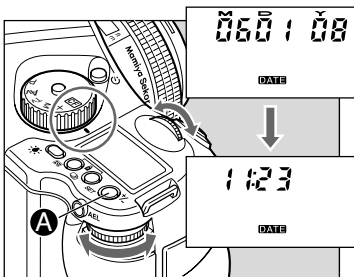

4. Press the set button  
After pressing the set button **A**, the display will change to the date setting mode.

5. Turn the front and rear dials to set the date and time.  
Turn the front dial to select "month-date-year" or "hour-minute" and change the value by turning the rear dial.

6. After the date and time are set, press the set button **A** for approximately one second to store the settings.

When the camera is set to sleep mode during the setting procedure, the flashing display is cleared, and no further settings can be performed. If this happens, press SET button **A** again.

The camera automatically cancels the date and time setting mode when it is not operated for 60 seconds, and the changes will not be saved.

When not in the CF exposure mode, if the set button is pressed for approximately two seconds the display will show the index number. Press the set button again to check the date and time.

## Strap

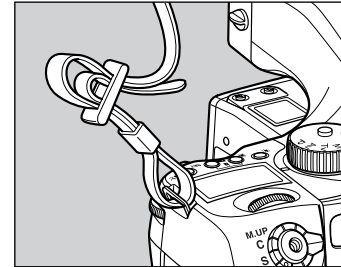

Put the neck strap through the mounts and secure it using the buckle as illustrated.

After attaching the strap, pull it and make sure it does not loosen at the buckle.



### Caution

To ensure safety, pull the ends of the strap taut, and check that they are fastened securely to the metal mounts on the camera.



# Basic Operation

**This section describes basic camera operations, how to load film and fully automatic photography.**

## Attaching a Lens

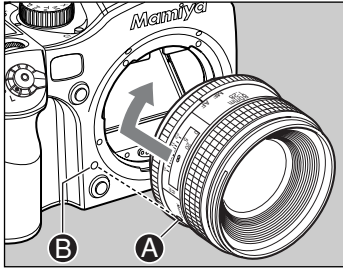

Line up the lens mount alignment mark **A** with mark **B** on the camera to fit the lens in place, then rotate it in the direction of the arrow until it clicks into place.

## Attaching a Magazine

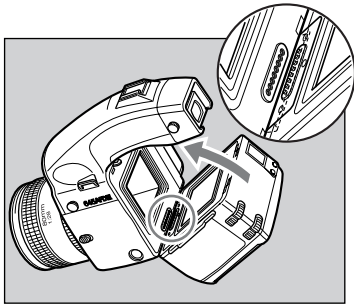

1. Fit the bracket at the bottom of the interface of the camera body with the groove on the magazine.

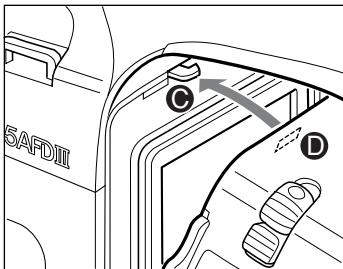

2. Press the magazine to the camera body, then the couplers on the camera body and the magazine together. You will hear the shutter and mirror click into the shooting position.

The film speed (ISO speed) is a numeric reference of the sensitivity to light, and must be set correctly. If the set value differs from the actual value of the film in use, under- or over-exposure may occur.

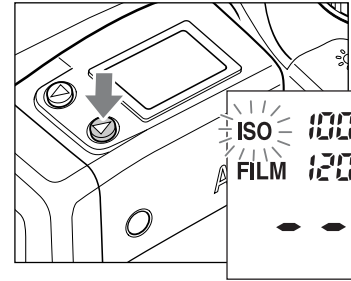

### 1. Press the **▲** (up) button.

Press and hold the **▲** (up) button on the film magazine for approximately one second. The ISO indicator will blink.

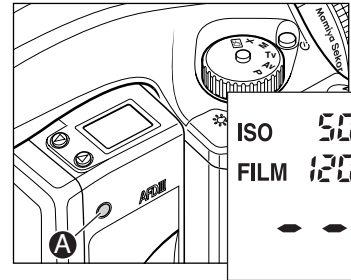

### 2. Set the film speed.

Select the desired film speed with the **▲** (up) and **▼** (down) buttons. When the correct film sensitivity is displayed, press the film advance button **A** to set it or leave the ISO icon blinking for five seconds.

The setting is not complete while the ISO indicator is blinking.

For power-saving purposes, display on the LCD panel disappears in 5 seconds, or when the magazine is detached from the camera body. The display resumes by pressing the **▲** button.

When the battery of magazine is exhausted and it is not attached to the camera body, no information will be displayed on the LCD panel. As it may cause malfunction, replace the battery with a new one.

# Loading Film in the Magazine

A roll of film can be inserted into the magazine whether the magazine is installed onto the camera body or not.

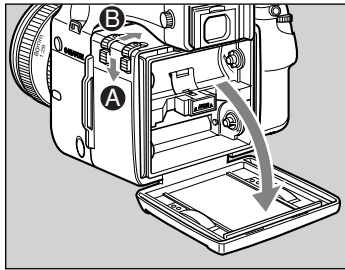

## 1. Open the back cover of the magazine.

Hold down the **A** button and press the **B** button to the right.

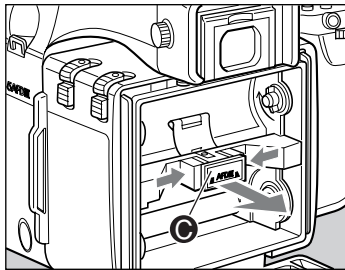

## 2. Take out the roll-film insert.

Pinch the knobs **C** of the roll-film insert in the chamber with your fingers and take out the roll-film insert.

When you load a film in the magazine for the first time, remove the protective paper which is attached to the pressure plate of the roll-film insert.

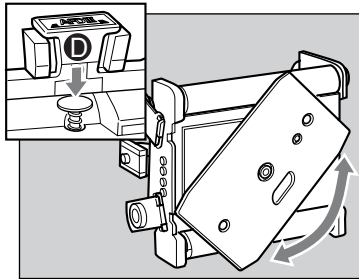

## 3. Set the film type (120 or 220).

Hold the button **D** under the knob and turn the pressure plate. This frees the pressure plate and permits it to be turned and set for either 120 or 220 film.

Be sure to align the lock pins with the holes on the pressure plate. The selected film type will be visible through the window on the pressure plate and will be displayed on the LCD of the magazine when the roll-film insert is loaded.

## ⚠ Caution: When the pressure plate (120/220) is set erroneously

When the pressure plate setting does not correspond to the loaded film a mismatch between the pressure plate setting and loaded film may result in a focusing error and/or camera malfunction. Always ensure that the pressure plate setting corresponds to the loaded film.

Plate Setting	Loaded Film	Result
120	220 type	- Inaccurate focusing. - Film winding after 16 exposures.
220	120 type	- Inaccurate focusing. - After the 16th exposure has been made, the shutter can be released a few times until the film's leader paper has run out, but the shutter blades may be damaged by the leader paper at the film end or by the film's sticker.  Insert the dark slide in the magazine and press the shutter button and the emergency film wind button simultaneously. (See page 40)

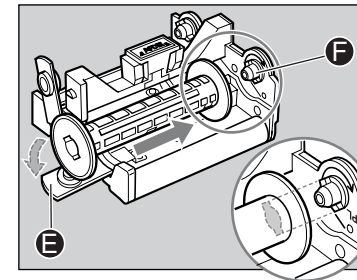

## 4. Attach the empty spool to the roll-film insert.

Flip open the backing plate **E** of the lower compartment, fit an empty spool to the bearing, and push the backing plate **F** back to the original position.

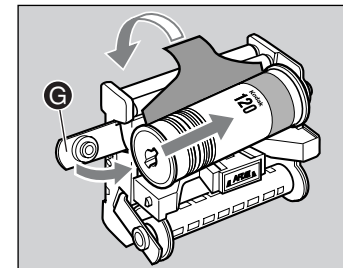

## 5. Set a film.

Flip open the backing plate **G** of the upper compartment, set a new roll of film as shown, and return the backing plate **G** to the original position.

Film path

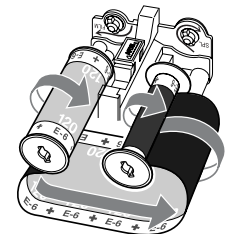



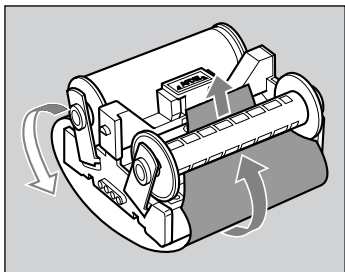

### 6. Attach the leader paper of the film to the empty spool.

Run the film as shown, and insert the tip of the leader paper into the slit of the empty spool. Wrap the leader paper around the empty spool once or twice by rotating it. Further adjustment of the film position is not necessary. The camera automatically advances the film to the first frame.

Press down gently on the loaded film, rotate the "SPL" side spool so that the film does not develop any slack, and wind the film tightly. If the film is not wound tightly, the film winding will loosen, possibly causing light fogging.

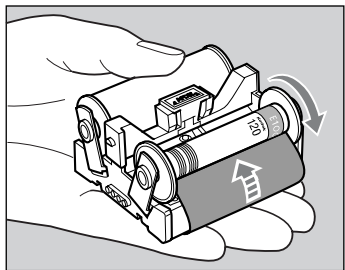

### 7. Insert the loaded film into the magazine.

Pinch the knobs **H** and place the roll-film insert in the housing. When the top of knob **H** is pushed, the left and right latches open up, and the inner frame clicks into place.

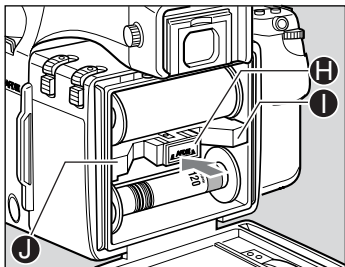

Make sure that the film insert is properly fixed. When one or both latches are out of position, press the projecting portion **I** or **H** until it clicks into place.

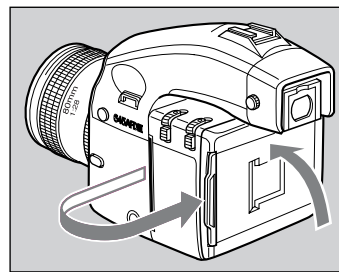

### 8. Close the back cover.

Push in the upper part of the back cover firmly to close it.

Attach the magazine to the camera body. Pull out the dark slide, and press the shutter release button halfway. This will advance the film to the first frame.

Place the dark slide in the magazine's rear storage pocket.

In this camera, the film is automatically advanced to the first frame. If it is not advanced properly, the film will continue winding for a certain period of time, after which it will automatically come to a stop. If this happens, fewer frames (about 10 frames) will be available for shooting. To be on the safe side, after taking 10 frames, take the film out following the procedure for removing the film before reaching the end of the film. (page 40)

When the film is not wound properly, the "- -" mark appears in the LCD.

If you do not operate the camera for 60 seconds, the camera will automatically enter sleep mode in order to save battery power. In sleep mode, closing the back cover does not trigger the automatic film advance, even if it is set so in the custom setting (C-31 on page 96). In this case, press the shutter release button halfway down to feed the film to the 1st frame position.









Film might be accidentally exposed. Avoid intense light when loading/ unloading film, and do not wrap too much of the leader paper into the spool.

MEMO

1. The camera can be set to wind the film to the 1st frame position automatically after the back cover is closed.  
➔ Custom settings (C-31 on page 96)
2. The camera will not release the shutter when the rear cover is closed with no film loaded. This can be changed to permit the shutter to release with or without film.  
➔ Custom settings (C-30 on page 96)
3. The number of frames available for shooting can be set to 15. Under certain shooting conditions, this may be affected by the failure of the film to straighten out. (page 76)

### Compatibility between the HM402 and HM401 120/220 magazines

The HM402 is compatible with the HM401 120/220 magazine used for the 645AF, 645AFD, and 645AFD II camera bodies in terms of its outer and inner frames, but it may not be possible to achieve its prescribed performance, depending on the camera body and the outer and inner frame combination of the magazine used.





Camera body	Magazine outer frame	Inner frame used for HM402	Inner frame used for HM401
645AFD III, 645AFD II	Inner frame used for HM402	 Wind-up speed: 2 frames/sec. Imprinting of focal length information	 Wind-up speed: 1.4 frames/sec. Imprinting of focal length information
	Outer frame used for HM401	 Wind-up speed: 2 frames/sec. No imprinting of focal length information Missing imprinted character	 Wind-up speed: 1.4 frames/sec. No imprinting of focal length information
645AFD, 645AF	Outer frame used for HM402	 Wind-up speed: 1.6 frames/sec. No imprinting of focal length information	 Wind-up speed: 1.3 frames/sec. No imprinting of focal length information
	Outer frame used for HM401	 Wind-up speed: 1.6 frames/sec. No imprinting of focal length information Missing imprinted character	 Wind-up speed: 1.3 frames/sec. No imprinting of focal length information

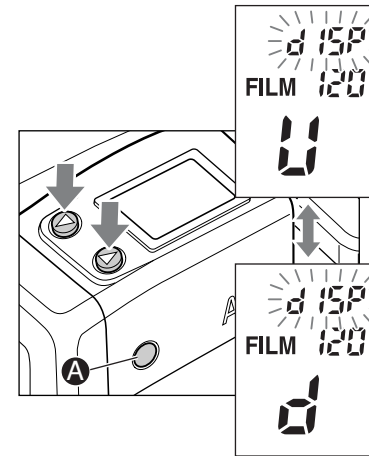

“Missing imprinted character” means that the first digit of the shutter speed is indistinct when using a shutter speed of 1/1000 or above.

Focal length information cannot be imprinted with the 645AF and 645AFD camera bodies.

Under the initial settings, the shooting frame number display advances by one frame with each picture taken (forward counting). This display can be changed to reverse counting, a system which shows the number of remaining shooting frames.



When the magazine LCD appears, press the  (up) or  (down) button until “dISP” blinks at the top of the magazine LCD panel and “U” appears in the frame number display area (in forward counting). When the  (up) or  (down) button is pressed again, “d” appears (in reverse counting).

Each time the  (up) or  (down) button is pressed, the display is switched, so after the desired display system appears, press emergency film wind button  to set the system.

Five seconds after selecting the shooting frame number display, “dISP” stops blinking and illuminates, indicating the setting has been automatically established.

**MEMO** The shooting frame number display can be switched at any point while pictures are being taken.

When the magazine has been removed from the camera body, the displays will not appear if the magazine does not have its battery installed. In such a case, load the magazine onto the camera body, and proceed with setting.

# Taking Photos in the Fully Automatic Mode

## 1. Set the drive dial to “S” (single-frame advance mode).

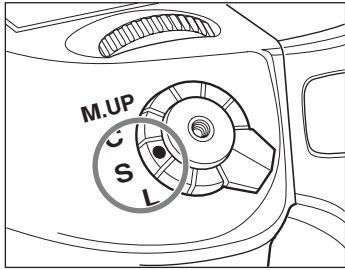

The drive dial has an “S” (single-frame advance mode) setting and a “C” (continuous advance mode) setting. (See page 51.)  
When set to “L,” the power is turned off.

## 2. Set the focus mode selector lever to “S” (single focus mode).

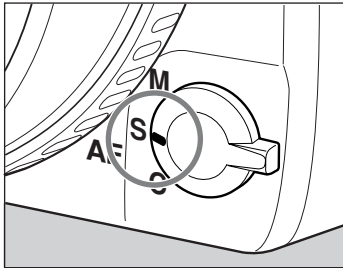

There are three focus modes: “S” (single focus mode), “C” (continuous focus mode) and “M” (manual focus mode).

Focus mode	Focusing
<b>S</b> Single focus mode	Half-press the shutter release button to focus. When the focus mark lights, the focus is fixed and the shutter can be released. (See page 43.)
<b>C</b> Continuous focus mode	The camera keeps focusing continuously while the shutter release button is half-pressed. The shutter can be released regardless of whether or not the focus mark is lit. (See page 43.)
<b>M</b> Manual focus mode	Focus manually. (See page 45.)

## 3. Set the exposure mode selector dial to “P” (program auto exposure).

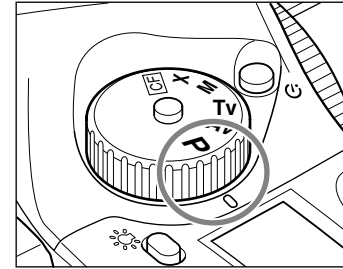

There are four exposure modes: “P” (program AE), “Av” (aperture priority AE), “Tv” (shutter priority AE) and “M” (manual mode).

Exposure mode	Features
<b>P</b> Program AE	The aperture and shutter speed are determined automatically according to the shooting conditions. This mode is best suited for general photography, since it allows you to concentrate on the shooting. You can change the shutter speed and aperture by turning the front and rear dials while the “P” (Program AE) mode is selected. (See page 53 and 54.)
<b>Av</b> Aperture priority AE	Set the desired aperture and the camera selects the correct shutter speed. Use this mode to control depth of field. (See page 55.)
<b>Tv</b> Shutter priority AE	Set the desired shutter speed and the camera selects the correct aperture. Use this mode to stop motion. (See page 56.)
<b>M</b> Manual mode	Set this mode when you want to use special combinations of the aperture and shutter speed. (See page 57 to 59.)

## 4. Exposure metering mode is automatically set to average/spot exposure metering before exposure metering is performed.

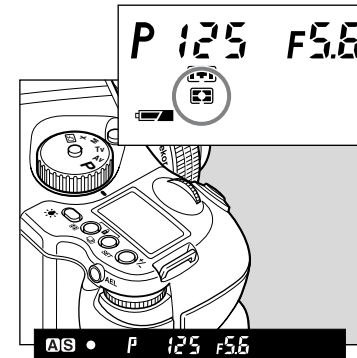

There are three exposure metering modes: In the “A” mode the average brightness in the entire frame is measured with emphasis on the center of the frame. The brightness at a specific spot in the center of the frame is metered in the “S” mode. The “A-S” mode automatically switches between these two modes depending on the contrasts in the picture. (See page 61.)

### 5. Focus

1. Aim the camera so that the subject is within the focus frame [ ].



2. Half-press the shutter release button, and focus will be adjusted automatically.



When the focus mark ● lights, the picture is in focus.

3. When ● lights, press the shutter release button further down to release the shutter.

#### Out of focus Marks

- ▶ ◀ **Flashing:** The picture is not focused and the shutter cannot be released. Either press the shutter release button again to adjust the focus or move the camera to change the position of the focus frame.

While the camera is operated in the auto focus mode, lenses not equipped with the focus mode selector ring (45, 55, and 80 mm lenses) turn their focusing rings automatically to focus. Do not touch the focus ring.

### Shutter Release Button

The shutter release button has a two-step action. When pressed lightly it stops at a certain point. In this manual this position is called the “half-press” position. When you “half-pressed” this button, camera functions are activated. When the shutter button is pressed further down, the shutter is tripped. This position is called the “release” position.

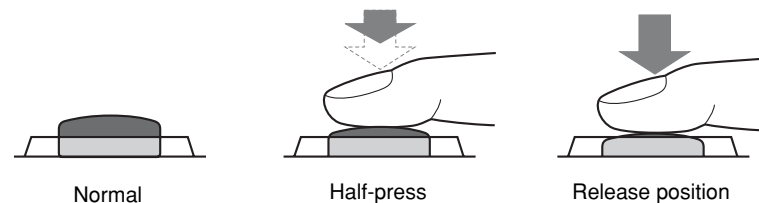

### Holding the Camera

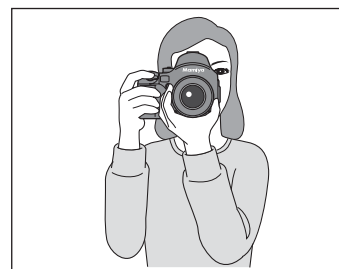

Horizontal

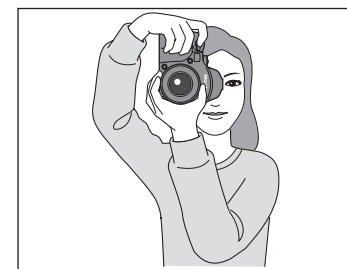

Vertical

Hold the camera still when taking photos to obtain sharp pictures.

**Grasp the grip firmly, press your both elbows against your body and support the camera at the bottom with your left hand.**

**At slow shutter speeds, or when using the self timer, it is best to use a tripod and a cable release or an electromagnetic cable release (Optional accessories).**

## 6. Unloading the exposed film.

When the roll of film is completely exposed, the camera automatically advances the film completely to the end. The LCD panel displays “End.”

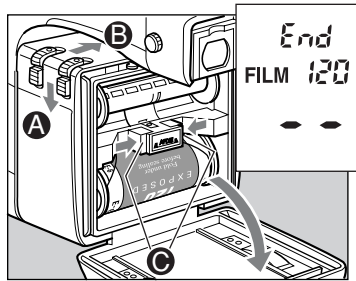

### 1. Open the back cover.

Hold down the button **A** and press the button **B** to the right.

### 2. Remove the roll-film insert.

Pinch the knobs **C** of the roll-film insert in the film chamber with your fingers and take out the roll-film insert.

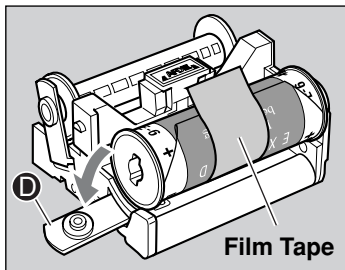

### 3. Remove the film.

Push down the backing plate **D** away from the spool, and take out the film roll.

### 4. Seal the film with the film tape.

Secure with the provided film tape so that the roll will not come loose.

You can smoothly load the next roll of film, if you move the empty spool to the lower compartment (printed “SPL”).

For the procedure to remove the film before reaching the end of the film, see page 40.

## ⚠ Caution: Checkpoints for film removal

Do not unload an exposed film in direct sunlight.

After the film has been removed from the inner frame, do not wind the film tightly. Otherwise, pressure marks may remain on the film.

Put the used film inside a light-proof bag, box or other container, and take it as soon as possible to the developer's.

Never detach the magazine from the camera body in the middle of film winding.

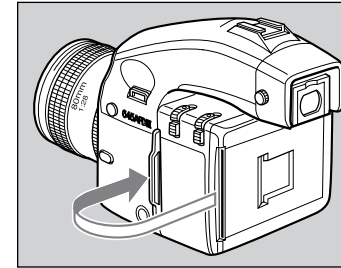

1. Insert the dark slide in the magazine.

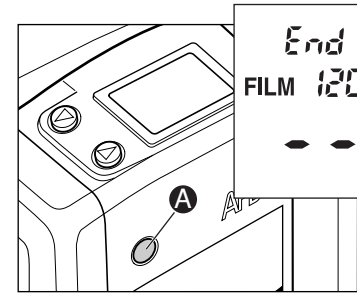

2. Press the shutter release button and the emergency film wind button **A** simultaneously. The film will be advanced to the end and the magazine's LCD panel will show “End.”

## Electrical Contacts

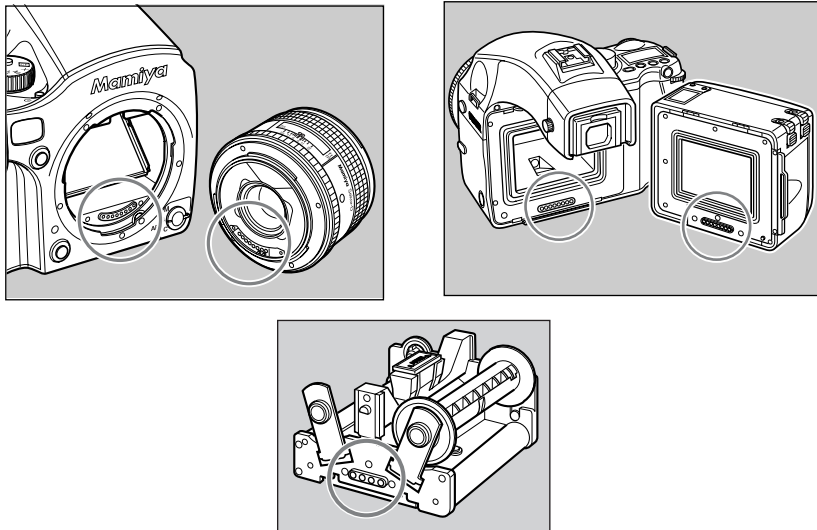

Oil, dirt, fingerprint, or moisture on the electrical contacts may cause malfunction or corrosion. Keep the contacts clean with a dry clean cloth.

# Advanced Photography and Various Functions

This chapter describes various  
functions of the camera.

## Single focus mode (S)



This mode uses the focus-priority mechanism. The shutter can be released when the focus mark ● in the viewfinder is lit. This mode is suited for still subjects. Focus is locked when the ● focus mark lights in the viewfinder's LCD.

The shutter cannot be released if the subject is not in focus (if the ● focus mark does not light).

To take another photo with a different composition, take your finger off the shutter release button then press the shutter release button again.

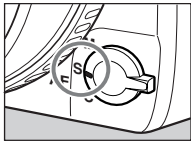

## Continuous focus mode (C)



In this mode shutter release has priority to focusing. The shutter can be released regardless of whether the ● focus mark in the viewfinder's LCD is lit. Focus is adjusted continuously while the shutter release button is half-pressed. This mode is suited for moving subjects.

Focus is not locked even if the ● focus mark is lit.

The shutter can be released even if the ● focus mark is not lit.

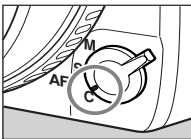

## Focus Area

With this camera, you can select the focus area that best suits the kind of pictures you intend to take. The selected focus area can be checked on the external LCD panel.

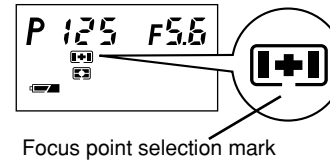

Focus point selection mark

### Inside the View-finder

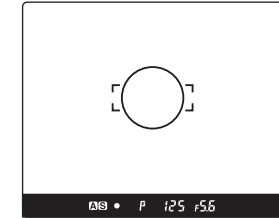

### Normal focus area

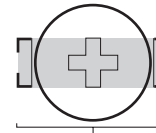

AF area

### Spot focus area

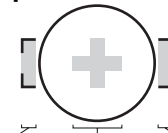

Left AF area    Center AF area    Right AF area

Bring the subject into focus inside the focus frame ○ mark on the viewfinder.

Select the frame from among the [ ], + and [ ] focus frame marks on the viewfinder, and bring the subject into focus.

## Selecting the focus area

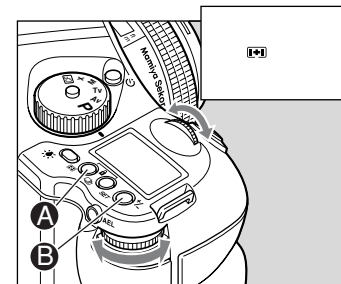

1. When focus point selector button **A** is pressed for 1 second, the focus point selection mark appears on the display.
2. Turn the front or rear dial, and select automatic selection [A], left [L], center [C] or right [R].
3. Press the SET or focus point selector button to enter the setting.

**MEMO** You can select whether or not to display the focus mark and the out-of-focus direction mark.  
 → Custom settings (C-18 on page 94)



## Manual Focus Mode (M)

The auto focus function can be cancelled, and you can focus manually.

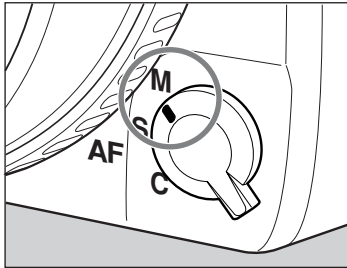

### 1. Switch to "M" (manual focus mode).

Turn the focus mode selector lever and set it to "M" (manual focus mode). **(M.F)** appears on the external LCD panel.

### 2. Manual Focus Operation for Telephoto and Zoom lenses.

All Mamiya 645 AF Telephoto and Zoom lenses can be switched from Auto Focus to Manual Focus by sliding the focusing ring on the lens FORWARD until it clicks. When this is done, the "Auto Focus" inscription on the lens barrel is covered and the lens can then be focused manually. When the FOCUSING RING is set in this position the external LCD display on the top of the camera will show **(M.F)**. It is not necessary to set the FOCUS MODE SELECTOR on the body to "M". To switch back to auto focus, simply slide the focusing ring BACK towards the camera and the "Auto Focus" inscription on top of the lens will again be visible.

This method applies to Mamiya 645 AF Telephoto and Zoom lenses only.

### 3. Adjust the focus.

Turn the lens focusing ring **A** until the subject is in focus. When it is in focus, the ● focus mark lights in the viewfinder LCD. (See page 37.)

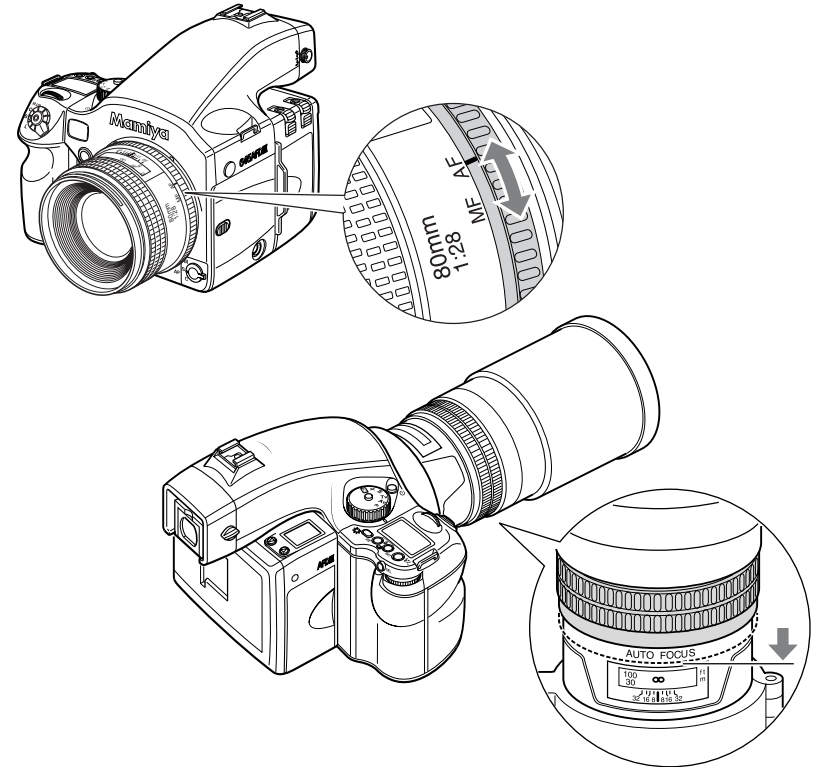
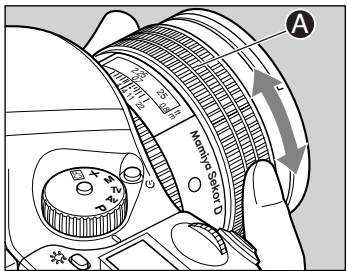

When a lens with the focus mode selector is attached and the focus mode selector lever of the camera body is set at "S" or "C", you can change focus modes between automatic and manual with the selector of the lens.

To use the auto focus function, both the camera body and the lens have to be set in the auto focus mode.

When either the camera body or the lens is set in the manual focus mode, auto focus does not function.

See the instruction manual for each lens for the way to switch focus modes on the lens.



## Manual focusing using the focus mark

(Focus confirmation method)

With this camera, the focus mark ● lights in the viewfinder's LCD when the picture is in focus. With the shutter release button half-pressed, turn the lens focusing ring to focus on the subject. When the subject is in focus, the ● focus mark lights in the viewfinder's LCD.

If ► is lit in the viewfinder's LCD, the camera is focused on a point behind the object. If ◀ is lit, the camera is focused on a point in front of the object.



In focus



Turn the focusing ring clockwise.



Turn the focusing ring counterclockwise.

Use the focus mark when taking photos in manual focus mode or using the M645 manual lens.

If you adjust focus using the focus mark with an M645 lens, make sure to open the aperture. You can use this function with a lens of f/5.6 aperture or higher.

**MEMO** You can set the camera so that only the focus mark is displayed.  
 → Custom settings (C-18 on page 94)

The Auto Focus function requires contrast on the subject. Auto Focusing may fail to achieve accurate focus with certain subjects described below. In such cases, either switch to the manual focus mode and focus manually, or bring into focus an object at the same distance as the object you want to photograph, lock the focus using the focus lock mechanism, then take the picture. (see the following page)

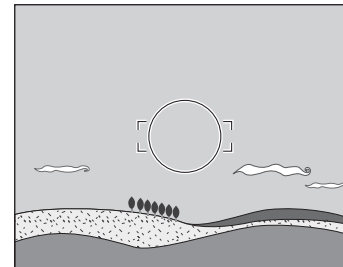

❶ Low-contrast subject (blue skies, white walls and other objects)

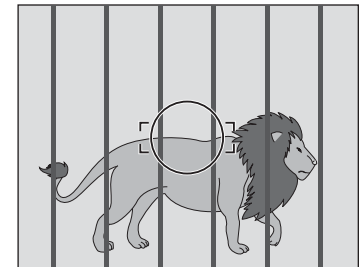

❷ Two or more objects overlapping at different distances within the focus frame : : (animals in cages, etc.)

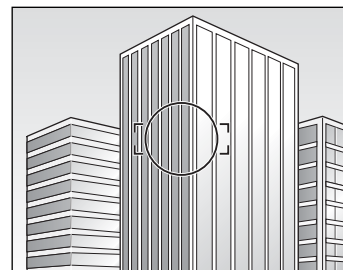

❸ Subjects with continuous repeated patterns (building exteriors, blinds, etc.)

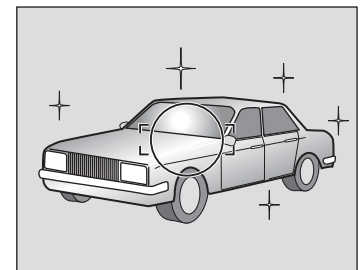

❹ Extremely backlit reflective subjects (car bodies, water surfaces, etc.)

❺ When the subject is far smaller than the focus frame

If the object that you want to focus on is not in the focus frame : ; the camera focuses on the background at the center. In such cases use the focus lock function to lock the focus before releasing the shutter.



## 1. Set the focus mode selector lever to “S” or “C.”

Put the subject in the focus frame :  and half-press the shutter release button.

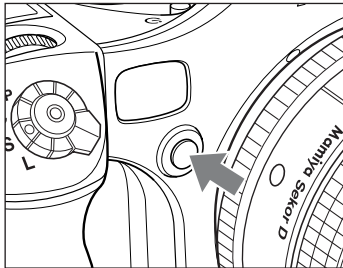

## 2. Lock the focus.

When the ● focus mark in the viewfinder LCD is lit, press the AF lock button on the front of the camera to lock the focus.



## 3. Adjust the composition.

With the shutter release button half-pressed, slide the camera to achieve the desired composition, and release the shutter.

When the focus mode is set at “S” (single focus mode) and the ● focus mark is lit, hold the shutter release button halfway down to lock the focus.

**MEMO** 1. Assignment of the AEL and AFL buttons can be swapped.

➔ Custom settings (C-15 on page 94).

2. You can set the camera so that when the AFL button is pressed, AF is activated and AF lock is performed

➔ Custom settings (C-19 on page 95)

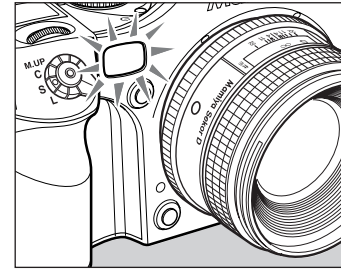

When the subject is dark or the low-key and the camera fails to auto-focus, a red lamp may light on the front of the camera when the shutter release button is half-pressed. This is a light that assists the camera's auto focus function.

The AF assist infrared light is emitted only when the focus mode is set to “S” (single focus mode).

Effective range of the AF assist infrared light is limited. It does not reach distant subjects.

Range: 9m/29.5 ft. (using 80 mm f/2.8 lens under our test conditions)

When using a lens hood or a bellows lens hood (sold as an optional accessory) that may interfere the assist light, set focus before mounting the hood.

**MEMO** The AF assist infrared light can be disabled.

➔ Custom settings (C-26 on page 95)

# Drive Modes

## Single-Frame Mode

The film is advanced by one frame each time the shutter is released.

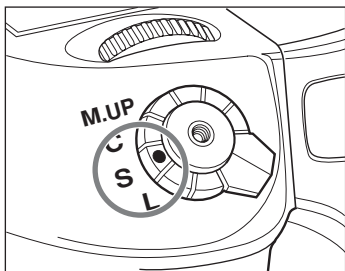

Set the shutter release mode selector lever to "S".

## Continuous Mode

Photographs are taken continuously as long as the shutter release button is pressed.

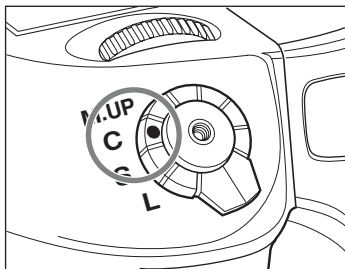

Set the shutter release mode selector lever to "C". Photographs are taken continuously at a rate of about 2 frames per second.

If you reach the end of the film when shooting in the continuous mode, "End" flashes on the LCD panel of film holder.

## Mirror up Shooting

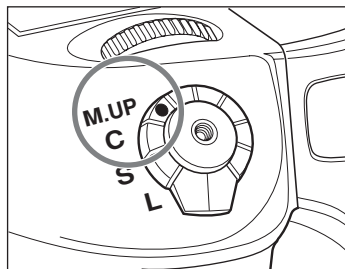

When the shutter button is half-pressed, the mirror moves up, and when the shutter button is pressed again, the shutter is tripped, and a picture is taken. For the mirror up shooting procedure, see pages 73 and 74.

## Self-Timer Mode (⏸)

In this mode, the shutter will be released 10 seconds after the shutter release button is pressed.

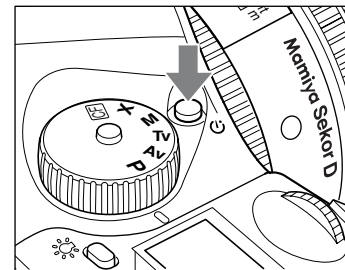

Turn the shutter release mode selector lever to the "⏸" position.

When the shutter release button is pressed, the self timer lamp will blink for 7 seconds. Then, it will blink more rapidly for 3 more seconds and the camera releases the shutter. For instructions about the self timer function, see page 77.

# Exposure Modes

## Program AE (P)

The aperture and shutter speed are determined automatically for the optimum exposure, according to the existing ambient light. This mode is best suited for general photography, allowing the user freedom to concentrate on the subject.

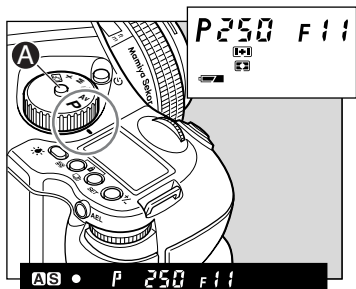

Hold down the button **A** and turn the exposure mode setting dial to “P” (program AE) position.

If a correct exposure cannot be obtained, the shutter speed and aperture value blink. In such cases, the pictures can be taken but they may turn out too bright or too dark.

## Program Shift (P<sub>H</sub>/P<sub>L</sub>)

You can change the shutter speed and aperture by turning the front and rear dials in the “P” (Program AE) mode. In order to avoid blurred images (shake while releasing the shutter), or to open the aperture, change to “P<sub>H</sub>” (high speed). For slower shutter speeds and wider depth of field, change to “P<sub>L</sub>” (low speed). This function allows you to make these changes quickly.

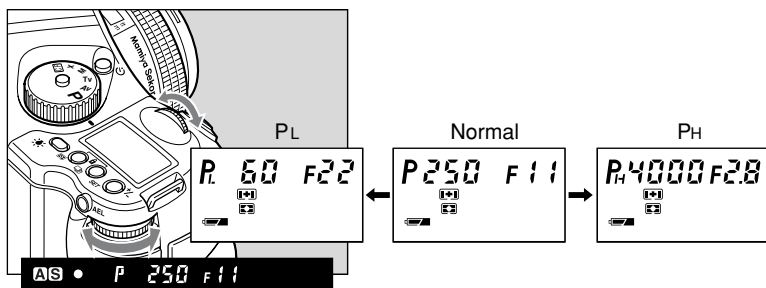

645AFDIII program shift chart

(ISO100/AF80mm F2.8 D)

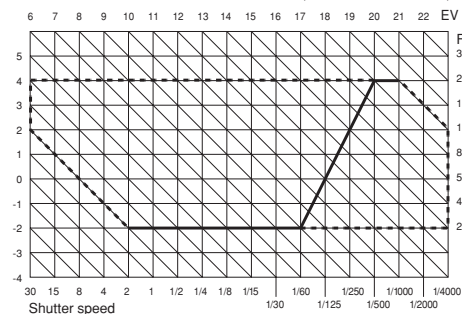

— Normal  
- - - Program shift area

When the Program line is shifted, the aperture value changes along with the shutter speed to maintain the proper exposure.

- MEMO
1. You can choose either aperture or shutter-speed to give priority in program line shift. ➔ Custom settings (C-14 on page 94)
  2. Increment of the aperture and shutter speed can be set at either 1/3 or 1/2-stop. ➔ Custom settings (C-01 on page 93)

### Aperture Priority AE (Av)

Set the desired aperture, and the camera selects the optimum shutter speed accordingly. Use the Av mode to maintain specific control over depth of field, i.e. taking portraits or landscapes.

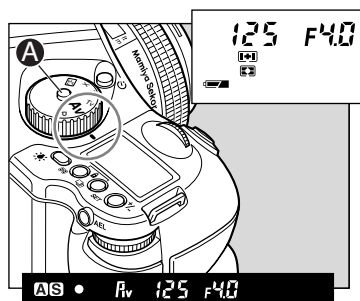

1. Hold down the button **A** and turn the exposure mode setting dial to “Av” (aperture-priority AE) position.

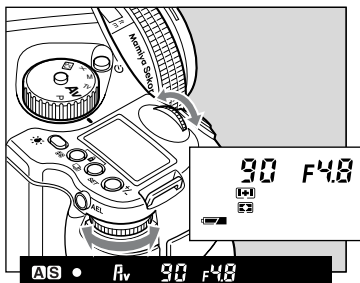

2. Turn the front or rear dial to set the desired aperture.

The shutter speed value will blink when the subject is too dark or too bright for a correct exposure. To obtain the correct aperture, adjust the aperture value until the shutter speed value stops blinking and remains lit.

- MEMO**
1. Increment of the aperture can be set at either 1/3 or 1/2-stop.
    - ➔ Custom settings (C-01 on page 93)
  2. Rotation direction of the dials to change the values can be altered.
    - ➔ Custom settings (C-13 on page 94)
  3. The selected aperture level can be locked. ➔ Page 79

### Shutter Priority AE (Tv)

Set the desired shutter speed and the camera selects the optimum aperture accordingly. Fast shutter speed can be used to freeze motion, and slow shutter speed can be used to blur motion on purpose.

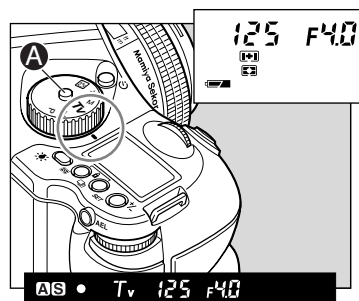

1. Hold down the button **A** and turn the exposure mode setting dial to “Tv” (shutter-priority AE) position.

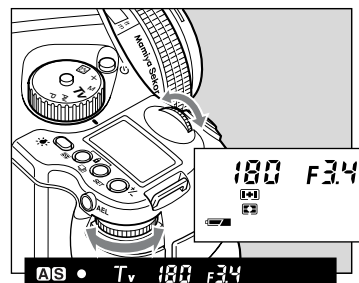

2. Turn the front or rear dial to set the desired shutter speed.

The aperture value will blink when the subject is too dark or too bright for a correct exposure. To obtain the correct aperture, adjust the shutter speed value until the aperture value stops blinking and remains lit.

- MEMO**
1. Increment of the shutter speed can be set at either 1/3 or 1/2-stop.
    - ➔ Custom settings (C-01 on page 93)
  2. Rotation direction of the dials to change the values can be altered.
    - ➔ Custom settings (C-13 on page 94)
  3. The selected shutter speed can be locked. ➔ Page 79

### Manual Mode (M)

This mode is used to set both the aperture and shutter speed for total exposure control. Shutter speeds can be selected from B (bulb), 30 seconds to 1/4000 of a second. Aperture values can be set from maximum to minimum aperture. B (bulb) can also be set in this mode.

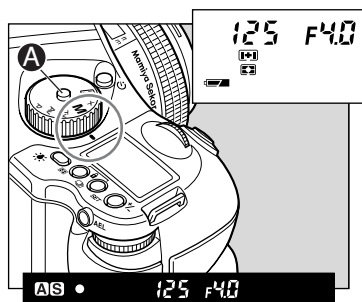

1. Hold down the button **A** and turn the exposure mode setting dial to “M” (Manual) position.

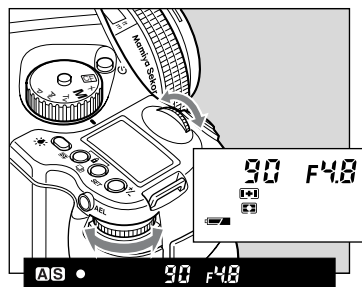

2. Turn the rear dial to set the desired aperture.

3. Turn the front dial to set the desired shutter speed.

- MEMO**
1. Increment of the aperture and shutter speed value can be set at either 1/3 or 1/2-stop. → Custom settings (C-01 on page 93)
  2. The assignments of the front and rear dials can be swapped. → Custom settings (C-11 on page 94)
  3. Rotation direction of the dials to change the values can be altered. → Custom settings (C-13 on page 94)
  4. The selected aperture and shutter speed can be locked. → Page 79



4. When the shutter release button is half-pressed, the difference between the present settings and the metered value is displayed in the viewfinder's LCD panel. The value is displayed in 1/3 stop increments within a range of  $\pm 6$  EV.



Example: “+2.3” indicates  $+2\frac{1}{3}$  EV,  
 “-5.7” indicates  $-5\frac{2}{3}$  EV.

When the chosen setting and metering values are the same, the metering difference value will be displayed as “0.0” in the viewfinder.

When the exposure is compensated in the Manual mode, the difference between the metered value and the compensated value will be displayed on the viewfinder LCD. In the B (Bulb) mode, the difference with the metered value is not displayed.

### Displays when the difference in the exposure metering values exceeds $\pm 6$ EV



When the setting and metering value exceed each other, values under  $\pm 6$ EV will be displayed as “- u -” and values over  $\pm 6$ EV will be displayed as “- □ -”.



## Exposure Modes (continued)

### One-push shift function

When difference between the set value and metered value is displayed on the viewfinder LCD in the Manual "M" mode, press the AEL button for approx. 1 second and the camera will automatically adjust the shutter speed to achieve the correct exposure based on the set aperture value.

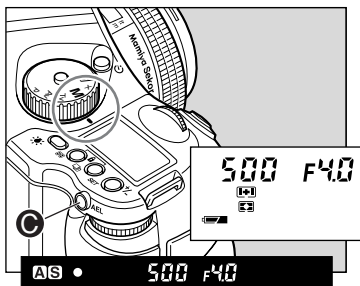
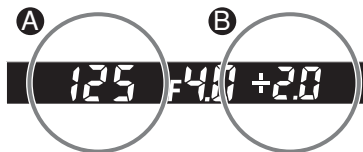
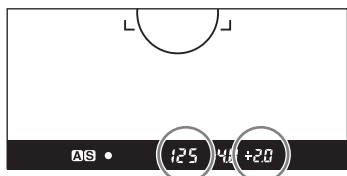

While the difference **B** between the set value **A** and the metered value is displayed on the viewfinder LCD, press the AEL button **C** for approximately one second. The camera changes the shutter speed to an appropriate level.

**MEMO** The aperture level can be selected for the parameter to shift. → Custom settings (C-20 on page 95)

### X Mode (X)

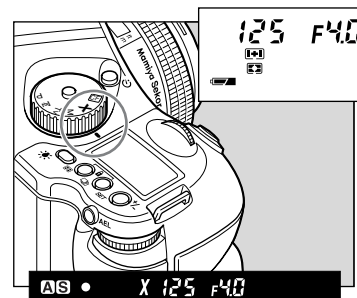

Select this mode when you use a flash. The shutter speed will be fixed at 1/125 second for synchronization.

When you take a photograph with TTL light metering with a Metz flash, see pages 82 to 84.

For flash photography, see pages 82 to 87.

When using the large flash unit for use in studios, changing the synchronizing speed is recommended. (page 87)

- MEMO**
1. The selected aperture value can be locked. → See page 79
  2. The synchronizing speed can be changed. → Custom settings (C-23 on page 95)

### CF (Custom Function) Mode (CF)

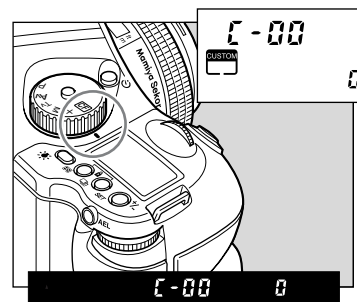

You can change the camera functions and methods for using the camera using custom functions.

For the details of the custom functions, see pages 90 to 96.

There are three exposure metering mode to select a proper exposure modes appropriate to the lighting condition of subject.

## How to select an exposure mode

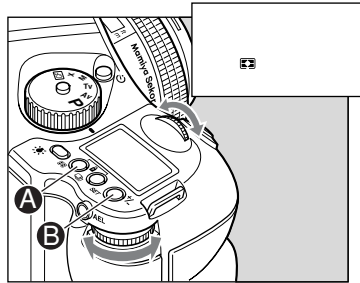

1. Exposure mode mark is displayed when the exposure mode button **A** is pressed. Since three different exposure modes are displayed sequentially when either the front or rear dial is turned, select an appropriate exposure mode.

2. Press the SET button or exposure metering mode button **A** to enter the setting.

## Exposure Metering Modes

	Average/spot auto exposure metering	Exposure metering is performed after automatically selecting average/spot exposure metering. <ul style="list-style-type: none"> <li>Depending on the subject conditions, center-weighted average/spot exposure metering is selected automatically, and the correct exposure is measured.</li> <li>Spot exposure metering is automatically selected when the brightness of the spot exposure metering range becomes darker than the brightness of the entire screen.</li> <li>If there is very little difference between the spot exposure metering value and center-weighted average exposure metering value, the correct exposure level is obtained as the intermediate value.</li> </ul>
	Center-weighted average/spot exposure metering	The average brightness of the entire screen is measured, emphasizing the center of the screen.
	Center spot exposure metering	The brightness of an area equivalent to 7.6% at screen center is measured, and the exposure is determined. The circle at screen center serves as a general guideline. This mode is suited to measuring subjects with strong contrasts or measuring only screen portions.

## Important

When a polarizing filter is used, ensure that a circular polarizing filter (circular filter: C-PL) is used. The correct exposure cannot be obtained with a normal polarizing filter (PL).

## Exposure warnings

With an inappropriate exposure setting, when shooting subjects that are too light or dark, the user is warned by the flashing external LCD or the LCD inside the viewfinder. At such times, the correct exposure cannot be obtained.

### Warnings that the exposure is outside the metering range

Program AE (P)

The shutter speed and f-number blink.



Aperture priority AE (Av)

The shutter speed blinks.



Shutter priority AE (Tv)

The f-number blinks.



Manual mode (M)

The exposure metering value difference is displayed.



The time used for the metering timer can be changed.

➔ Custom settings (C-04 on page 93)



# Exposure Compensation

In some situations, such as a great difference between the subject and background brightness or overall subject tones that will not meter correctly because they are all black or white, the resulting photograph may be under- or overexposed. When this occurs, use the exposure compensation function. Exposure compensation can also be used when you want to intentionally create overexposed or underexposed pictures.

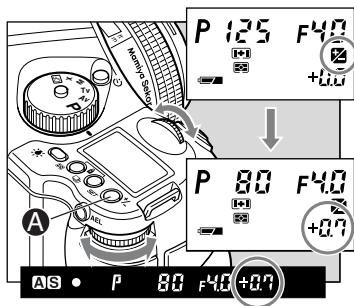

1. When exposure compensation button **A** is pressed, **±** appears on the external LCD. When the front or rear dial is turned counterclockwise, the exposure is increased; conversely, when it is turned clockwise, it is decreased. The exposure compensation value can be checked on the external LCD or LCD inside the viewfinder.

2. After taking the pictures, press exposure compensation button **A** again to return the exposure compensation value to 0. The exposure compensation value mark on the external LCD is cleared, and the exposure compensation function is released.

After taking pictures using the exposure compensation feature, be sure to return the exposure compensation dial to the "0" position.

Exposure compensation is also possible during AE lock.

The shutter speed changes with exposure compensation in manual mode ("M").

## Display of the exposure compensation of the viewfinder LCD

(When a Metz flash is not equipped.)

Exposure mode		Exposure compensation display
<b>P</b>	Program AE	The set value is displayed.
<b>Av</b>	Aperture priority AE	
<b>Tv</b>	Shutter priority AE	
<b>M</b>	Manual mode	The difference between the metered value and the set exposure value is displayed.
<b>X</b>	Synchro mode	Not displayed.



1. The width of the exposure compensation step can be changed.  
➔ Custom settings (C-01 on page 93).
2. The maximum exposure compensation step can be changed to **±5EV**.  
➔ Custom settings (C-05 on page 93).

# AE Lock Mode

Shooting with the AE lock function is useful in cases where the desired focal point differs from where the focal point is usually measured, or when it is necessary to measure the exposure using spot metering in order to bring the desired subject into focus. The AEL button will lock the Auto-exposure value as the photo is being recomposed.

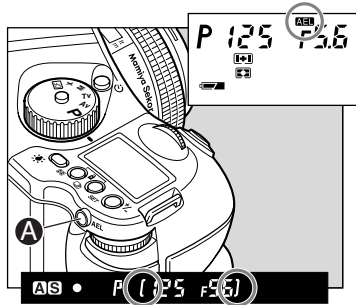

1. Turn the shutter release mode selector lever to "S" or "C."

2. Turn the exposure mode setting dial and select "P," "Av," or "T".

3. Focus on the subject for metering exposure, and press the AEL button **A** on the rear of the grip. [ ] will appear on the viewfinder LCD, indicating that the exposure value is locked.

4. Move the camera to recompose the shot, then take the picture.

[ ] on the viewfinder LCD blinks to indicate the exposure is locked, when you continue to take the next picture in the AE lock mode.

If you turn the shutter release mode selector lever to the "L" (power OFF) position, or after a lapse of one hour, the AE lock mode will automatically be cancelled.

In the Manual "M" exposure mode, you cannot use the AE lock function.

When the exposure metering value difference display appears, press AEL button **A** for about 1 second. The one-push shift function is now activated to shift to the shutter speed based on the metered result. (page 59)

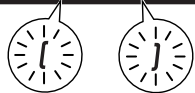

# Metered-value difference indicator



Keep pressing the AEL button **A**, and the difference between the metered exposure value and the exposure of the new composition will be displayed on the viewfinder LCD. This function can be used to see if an object of very different brightness levels can be properly photographed.



If the difference between the set value and the metered value exceeds 6EV, the viewfinder LCD blinks "- u -" for underexposure and "- o -" for overexposure.

By turning the front or rear dial in the AE lock mode, you can change the aperture and shutter speed value without changing the exposure value that is set when entered into AE lock mode.

In the "P" mode (Program AE) mode, turning either the front or rear dial shifts the program to "PH" and "PL." When in "Av" (Aperture-priority AE) or "Tv" (Shutter-priority AE), turning one of the dials changes both the aperture and shutter speed values.

Exposure compensation and auto-bracketing function can be used when the camera is in the AE lock mode in normal operation or with the mirror locked up.



1. The way to cancel the AE lock can be changed.
  - ➔ Custom settings (C-17 on page 94)
2. Half-pressing of the shutter release button can activate the AE lock mode.
  - ➔ Custom settings (C-16 on page 94)
3. The assignment of the AEL button and AFL button can be swapped.
  - ➔ Custom settings (C-15 on page 94)

# Auto-Bracketing Mode

With auto exposure bracketing, you can bracket the exposure automatically for three (or two) successive frames, when it is difficult to determine an exposure compensation value. The number of bracketed frames to be taken, the bracketed shooting sequence, bracketing margin and other settings can be selected as desired for shooting in auto bracketing mode.

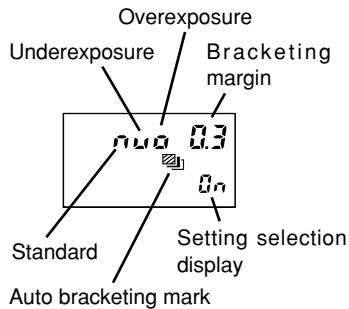
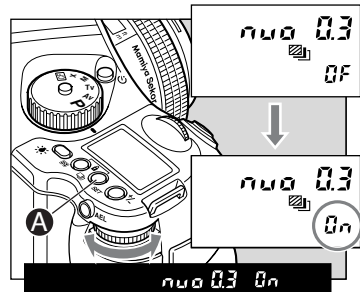

1. Turn the shutter release mode selector lever to the "S" or "C" position.

When set at the "S" position, you can shoot one frame with each press of the shutter release button. In the "C" mode, the camera takes three (or two) frames successively with one press of the shutter release button.

2. Keep pressing the auto-bracketing button **A** for approximately one second, and the auto bracketing mark will blink on the top LCD panel. Turn the rear dial before this indicator goes out, and change "0F" on the display to "0n".

3. While the auto bracketing mark is blinking, turn the front dial to change number of frames (3 or 2), sequence of the shots in 2-shot mode (shown above), and increment (1/3, 1/2, 2/3 or / 1-stop).

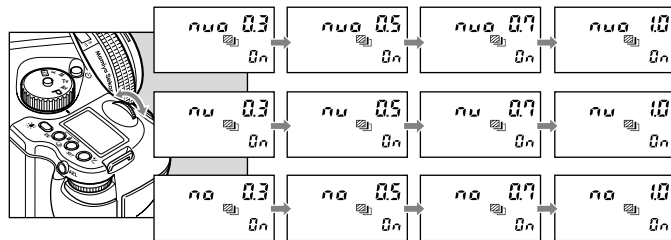

The letters (n, u, o) indicate the type of exposure ("n" for normal, "u" for under-exposure and "o" for over-exposure) and numbers indicate increment (0.3 for 1/3, 0.5 for 1/2, 0.7 for 2/3, and 1.0 for 1/1)

By pressing any other button or leaving the camera for 5 seconds, setting for the auto bracketing will be stored.

4. Press the shutter button, and take the pictures.

When the shutter button is pressed during shooting in auto bracketing mode, the shooting sequence and auto bracketing mark blink on the LCD inside the viewfinder.

Furthermore, the auto bracketing mark blinks, the bracket step width is displayed, and the shooting sequence can be checked on the external LCD.

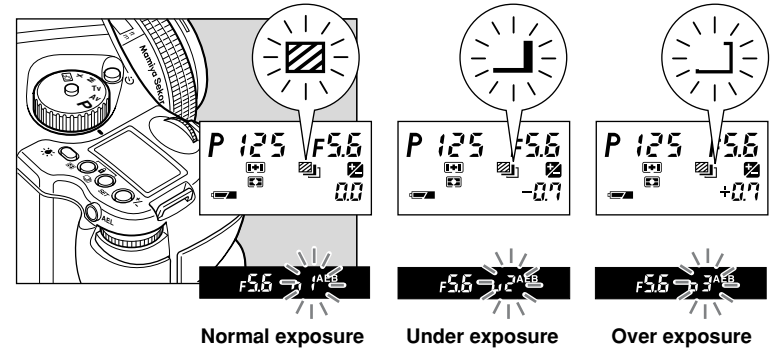

5. After taking pictures, press auto bracketing set button **A**, turn the rear dial, set auto bracketing mode to "0F," and release.

Then press the auto bracketing set button or half-press the shutter button to return to the normal display mode.

## Single-Frame Mode (S)

Press the shutter release button for each shot.

The camera meters adequate exposure value for each shot and performs auto-bracketing. The camera stays in the auto-bracketing mode until the last frame of the roll film is exposed or you cancel the auto-bracketing mode manually.

**If you turn the shutter release mode selector to the “C” position before taking three (or two) frames, the camera will restart the auto-bracketing from the initial frame (normal exposure in the default setting).**

## Continuous Mode (C)

By pressing the shutter release button once, the camera takes 3 (or 2) shots in series. With each press of the shutter release button, the camera repeats auto-bracketing. The standard (normal) exposure value will be fixed when you take the first frame.

**When the number of available frames of the current film is less than 3 (or 2) in the auto-bracketing mode, the “- 00 - 1/2” mark blinks and the camera automatically cancels the auto-bracketing mode.**



1. Order of the exposures in 3-shot auto-bracketing can be changed.  
➔ Custom settings (C-08 on page 93)
2. The way to cancel auto-bracketing mode can be changed.  
➔ Custom settings (C-09 on page 93).
3. When exposure compensation is initiated by pressing the exposure compensation button, shooting in auto bracketing mode is possible using the exposure value to which the exposure compensation value has been added.

### AE settings under auto-bracketing mode

	Exposure mode	Setting
P	Program AE	Shutter speed varies
Av	Aperture Priority AE	Shutter speed varies
Tv	Shutter Priority AE	Aperture varies
M	Manual mode	Shutter speed varies
X	X-sync mode	No setting



With “M” (Manual mode), aperture can be changed under auto-bracketing mode.

➔ custom setting (C-10 on page 94)

Using the multiple exposure mode, you can expose several shots on the same frame.

## Procedure for shooting with any number of multiple exposures

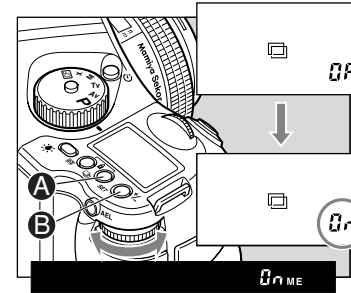

1. When the multiple exposure mode button **A** was held down awhile, the multiple exposure mode mark is displayed on the external LCD and “ME” on the LCD in the view finder.

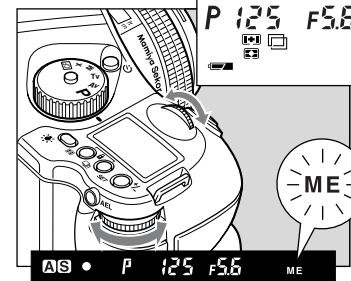

2. Turn the rear dial, and set multiple exposure to ON. Press SET button **B** or multiple exposure mode button to enter the setting.

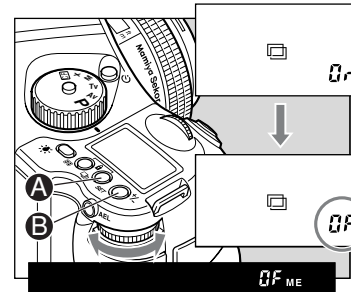

3. Take the pictures. When the shutter button is half-pressed when shooting in multiple exposure mode, the “ME” mark blinks, and the number of multiple exposures is displayed.

4. Expose the frame how many times you choose.

5. Press multiple exposure button **A** for 1 second to display the multiple exposure setting screen, turn the rear dial, and set the mode to OFF.

6. When the SET button **B** or the multiple exposure mode button is pressed, the film is wound by one frame, and multiple exposure mode is released.

When the shutter button is half-pressed at any point while shooting in multiple exposure mode, the “ME” multiple exposure mark blinks on the LCD inside the viewfinder.

### How to set the number of multiple exposures for shooting in multiple exposure mode

When "1. Number of multiple exposures" is selected using custom setting C-32, multiple exposure pictures can be taken for the number of multiple exposures selected.

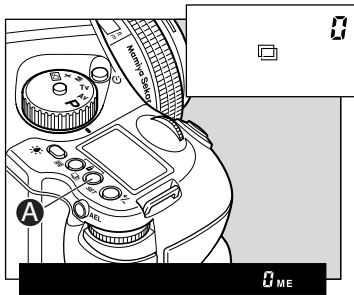

1. Set to the multiple exposure mode by holding down the multiple exposure mode button **A**. The multiple exposure mode mark "ME" and the number of multiple exposure "0" are displayed on the external LCD.

2. Set the number of multiple exposures by turning the front or rear dial. Any number from two to six multiple exposures can be set. The selected number is entered by pressing SET button **A** or the multiple exposure mode button or after 5 seconds have passed.

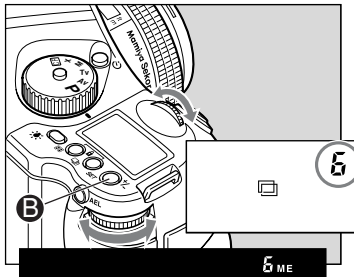

3. Press the shutter release button. Multiple exposures are made on the same frame. After completing the required multiple exposure, the multiple exposure mode is automatically cancelled.

When the shutter button is half-pressed at any point while shooting in the multiple exposure mode, the "ME" multiple exposure mark blinks on the LCD inside the viewfinder.

To check number of the remaining shots, press the multiple exposure setting button. To increase number of exposures to more than six in the middle of multiple exposures, or to decrease the number of exposures, press the multiple exposure setting button and turn the front or rear dial.

When number of the exposures is terminated in the "C" (continuous) shutter release mode, the top LCD panel shows "End", and the camera automatically cancels the multiple exposure mode.

To cancel the multiple exposure mode before taking the first shot, press the multiple exposure setting button and change the displayed number to 0.

### To cancel the Multiple Exposure Mode

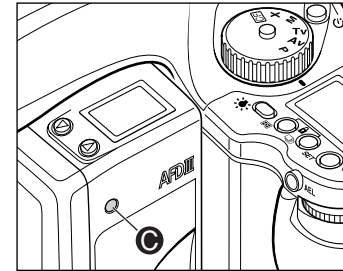

Make sure to pull the dark slide out. Then hold the emergency film winding button **C** while half-pressing the shutter release button. The camera advances the film one frame and then exits from the multiple exposure mode.

When the dark slide is inserted into the Magazine, the film will automatically wind up. If the film holder is detached in the middle of multiple exposure, "no ME" will blink on the top LCD for 3 seconds. The multiple exposure mode is now cancelled. However, as the film holder is still in the multiple exposure mode, the camera will resume the multiple exposure mode when the same film holder is attached. The multiple exposure mark "ME" will blink on the LCD, and number of the remaining exposure will be automatically set at "1".

### Guideline for exposure compensation during Multiple Exposure Mode

As in the multiple exposure mode several shots are exposed on a single frame, exposure compensation may be needed depending on the subjects and the backgrounds.

Exposure compensation in typical multiple exposures

Number of exposures	Exposure compensation
2	-1.0
3	-1.5
4	-2.0

The optimum exposure compensation value will vary depending on actual photographic conditions. We recommend taking test shots.

# Taking Photos with the Mirror Up

This function prevents mirror-caused vibrations which may blur the image in close-up photography, when shutter speed is slow, when a telephoto lens is used, or when photographing a poster or another picture.

When using the mirror-up, Electromagnetic Cable Release RE401 (optional) is recommended.

## Using auto focus and auto exposure

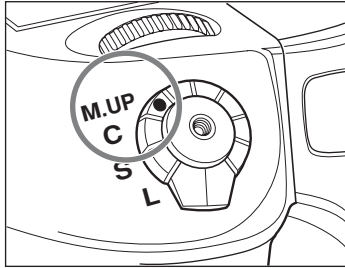

1. Set the drive dial to "M.UP."
2. Select "S" (single focus mode) by turning the focus mode selector lever.
3. Turn the exposure mode-setting dial to choose any of "P", "Av", or "Tv" exposure mode.
4. Focus the subject, and determine composition and exposure.
5. The mirror moves up when the shutter button is fully pressed.
6. Press the shutter button again to take pictures.

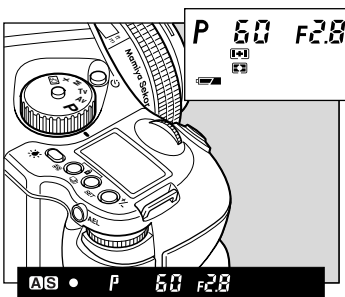

Auto bracket exposures can be made when the auto bracket mode is set before taking photos with mirror up.

The mirror goes back to the normal position in 30 seconds. This can be changed to 60 seconds or no limitation by the custom setting function. (See page 93)

Note that keeping the mirror up consumes more power.

The mirror will return to the original position if the lens is removed from the camera body.

## In the manual mode

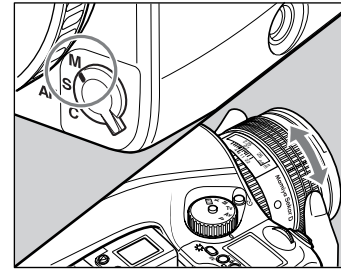

The procedure is the same as that taken up to step 3 of auto focusing.

1. Set the focus mode selector lever to "M" (manual focus mode).
2. Determine the exposure, focusing and frame structure by pressing the shutter release button halfway while looking into the view finder.
3. Mirror up by fully pressing the shutter release button.

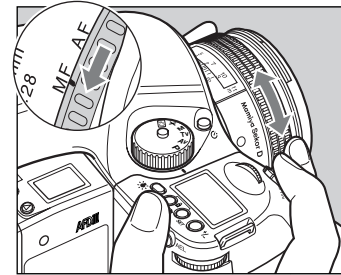

### ! Caution

Do not point the lens at the sun during the mirror up mode. The sun's intense light can scorch and damage the shutter curtain.



## Electronic Shutter Release Contact

For mirror-up, long exposure, or slow shutter shooting, use the magnetic cable release RE401 or the remote control RS402 for remote shooting.

The assisting release contact is to insert the cable. When use, take the cover off from the contact and please do not misplace the cover.

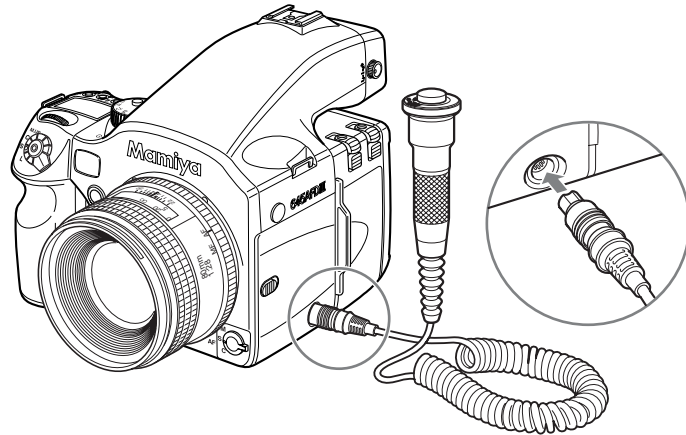

## Eyepiece Shutter

Close the eyepiece shutter when there is a strong light source behind the camera or when pressing the shutter release button without looking through the viewfinder.

(This prevents exposure error due to light entering from the viewfinder.)

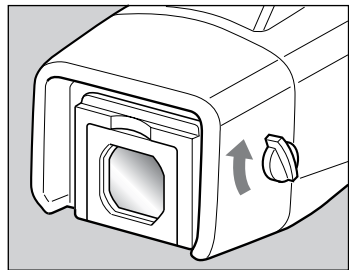

**Turn the eyepiece shutter lever in the direction of the arrow.**

Under certain shooting conditions, the failure of the film to straighten out may cause defocusing on part of the screen. When the camera has been left standing for a prolonged period (30 minutes or longer) after the film is wound up, the frame following the frame up to which the film was wound and at which the camera was left standing may be adversely affected by the failure of the film to straighten out. In cases like this, the effect can be prevented by setting the number of shooting frames to 15 frames for a 120 film or 30 frames for a 220 film. This failure of the film to straighten out differs significantly depending on factors such as the type of film used and the temperature or humidity during shooting.

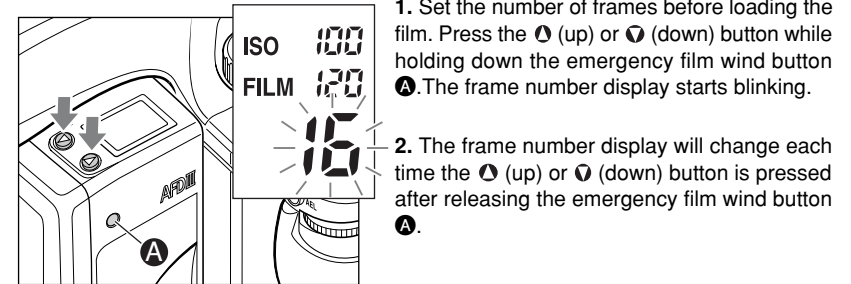

1. Set the number of frames before loading the film. Press the ▲ (up) or ▼ (down) button while holding down the emergency film wind button **A**. The frame number display starts blinking.

2. The frame number display will change each time the ▲ (up) or ▼ (down) button is pressed after releasing the emergency film wind button **A**.

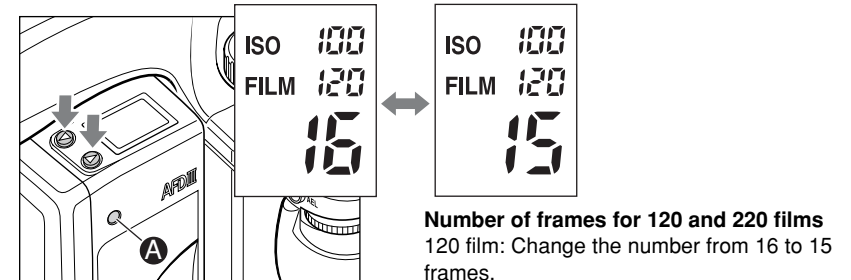

**Number of frames for 120 and 220 films**  
 120 film: Change the number from 16 to 15 frames.  
 220 film: Change the number from 32 to 30 frames.

Since the frame number display will change each time the ▲ (up) or ▼ (down) button is pressed, display the desired number of shooting frames, then press the emergency film wind button **A** to enter the setting. Five seconds after the number of shooting frames has been selected, the display stops blinking and lights up, indicating the setting has been automatically entered.

**The number of frames cannot be set while shooting.**

**When the magazine is removed from the camera body, the display will not appear if the magazine does not have its battery in place. In this case, load the magazine onto the camera body and proceed with the setting.**

## Self Timer Mode

With this function, under the default setting the shutter is released 10 seconds after the shutter release button is pressed. The self timer lamp flashes slowly for the first 7 seconds, then flashes quickly for the last 3 seconds before the shutter is released. Use this function to take group photos or to photograph yourself.

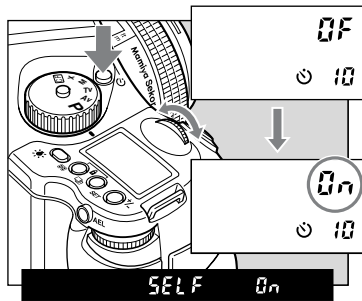

1. Mount the camera to a tripod.
2. Turn the shutter release mode selector to the "S" (self timer mode) position.
3. Turn the front dial, and set the self-timer mode to ON.
4. Check the view by looking through the viewfinder. Make sure that the focus is correct, press the shutter release button and the shutter will be released after 10 seconds.

## Change the self timer time

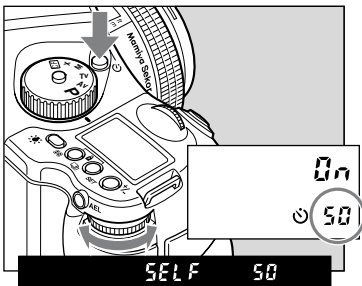

1. Press the self timer button to set the self timer mode.
2. Turn the rear dial, and change the operating time. It can be set from 2 to 10 seconds in units of 1 second and for more than 10 seconds in 10 second units.

## Releasing self timer mode

1. Press the self-timer button to set self timer mode.
2. Turn the front dial to "0F."

To release the self timer while it is operating, turn off the power (by setting the drive dial to "L").

When there is bright light source behind the camera or when you press the shutter button without looking through the viewfinder, light may enter from the viewfinder's eyepiece, adversely affecting the exposure metering. Turn the eyepiece shutter open/close knob to close the eyepiece shutter, then take the pictures. (page 75.)

## Long Exposure Mode (Bulb Mode) / Backlight Button

### Long Exposure Mode (Bulb Mode)

To expose film longer than 30 seconds, adjust the shutter speed to "B" (bulb). In order to prevent camera shake, use an electromagnetic shutter release and tripod.

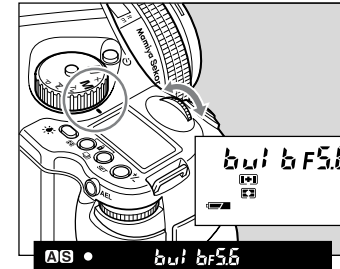

1. While pressing the unlock button, turn the exposure mode dial and set it to "M" (manual mode).
2. Turn the front dial to select "bulb", then turn the rear dial to set the aperture.
3. Determine the composition, focus, then take the picture. The shutter remains open as long as the shutter release button is pressed.

As the camera is electronically controlled even during exposures, it is recommended to replace batteries before bulb exposure. (See page 11.)

- MEMO
1. Normally the camera can take a picture with a bulb shot up to 60 minutes. However, the bulb shot time can be changed from one minute to infinity. ➔ Custom settings (C-21 on page 95)
  2. It is possible to set the camera so the shutter remains open until the button is pressed once again. ➔ Custom settings (C-22 on page 95)

### Backlight Button

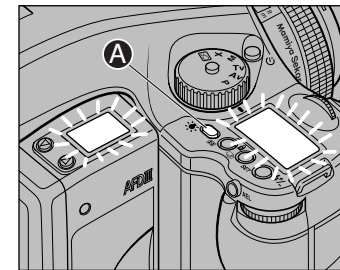

To see the main panel at night or in dark places, press the backlight button **A**/. The backlight will go on approximately 10 seconds and go off unless there is another operation.

When releasing the shutter, or pressing the backlight button **A**/ while the backlight is on, the backlight will go OFF.

When operating the camera while the backlight is on, the backlight will light on for approximately another 10 seconds.

- MEMO
- The backlight can be set to turn on during the camera's metering retention period. ➔ Custom settings (C-06 on page 93)



When the Electronic Dial Lock is “On,” all currently set values in “Av” (Aperture Priority AE), “Tv” (Shutter Priority AE) and “M” (Manual mode) cannot be adjusted with the front or rear dials. This prevents accidental change of shutter speed or aperture values.

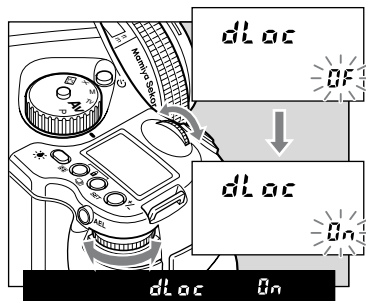

## How to set dial lock

Press the multiple exposure mode and auto bracketing mode button together for about 1 second so that “On,” flashes on the display.

## How to release dial lock

To release dial lock, press the same buttons as in “How to set dial lock” so that “DF” flashes on the display.

The setting will be stored after one second.

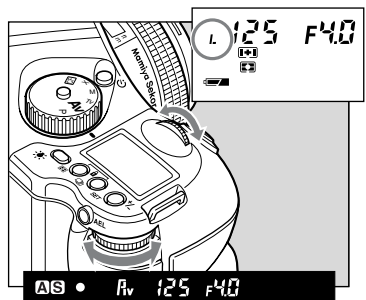

When dial lock is set, the dial lock display “L” appears on the external LCD.

When the dial lock is ON, the shutter speed and aperture will not change even if you turn the front or rear dial.

When you activate the electronic dial lock, and if you then operate the electronic dial, the dial lock indicator “L” on the main panel blinks for three seconds to show that the electronic dial lock is functioning.

Dial lock can not be set when the exposure mode is “P” (program AE).

Even while dial lock is set, the front dial or rear dial can still be used to perform the various settings. (Dial lock is temporarily released.)

## Depth of Field

Depth of field (D.O.F.) is defined as the zone of sharpness before and behind the plane of focus. It depends on distance to subject, focal length of lens, aperture setting and distance the lens is focused at.

In addition to visual observation via the depth of field preview button, the D.O.F. can be determined by using the depth of field scale on each lens. The f/stop numbers appear on both the right and left side of the white index mark in the center of the scale. Simply read the figures which appear above the f/stop numbers on the distance scale of the lens. (see illustration below)

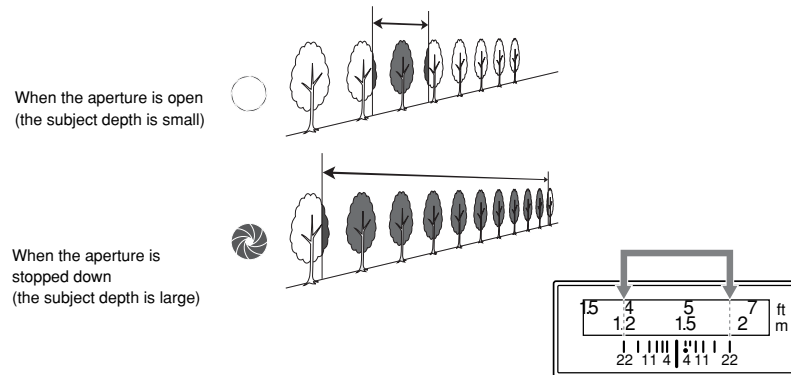

## Depth of Field Preview Button

When the preview button is pressed in, the depth of field for the aperture set on the camera can be checked by looking through the viewfinder.

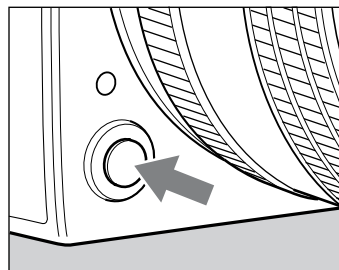

After focusing, press the preview button. The diaphragm will be stopped down to the set aperture.

While operating the preview button, you cannot release the shutter.

When taking photos using infrared film, the position at which the subject is in focus is slightly different than that of regular film. This is because the infrared rays have a longer wavelength and the image converges behind the film plane of regular film. Use the procedure described below when taking photos using infrared film.

1. Set the focus as usual. Read the point on the distance scale matching the center index of the depth scale.
2. Set the focus mode selector lever to "M" (manual focus mode). Turn the focusing ring clockwise and align the read point to the infrared index.

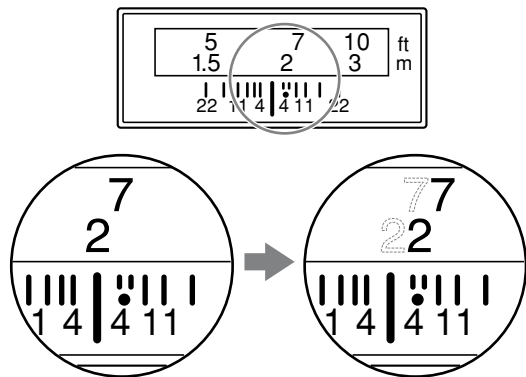

Use a red filter when taking photos using infrared film.  
 Be sure to read the infrared film's usage instructions.  
 You cannot take photos in AE modes when using an infrared film.

In addition to its standard flash sync system, the Mamiya 645 AFDIII features TTL (through the lens), off the film (OTF), electronic flash exposure metering. A flash sensor located inside the camera body reads the flash reflected off the film surface at the moment of exposure. The sensor is connected via the Mamiya 645 AFDIII's dedicated hot-shoe to a shoe- or handle-mount style Metz flash unit via the Metz SCA 3952 TTL Adapter. Maximum flash sync speed is 1/125 sec., making daytime synchronization possible.

The ISO of the flash is automatically set through the TTL connection from the camera's Film Magazine; any adjustment to this is instantly recognized after the setting is locked and the shutter release is half-pressed. Also, when Film Magazines with different ISO settings are switched on the camera body, the TTL flash connection instantly recognizes the change.

To utilize the TTL flash feature with all TTL-operable Metz flash units, a Metz SCA3952 Module is required. Please see the chart below for compatibility and/or additional adapters that may be necessary.

Metz Flash Unit	Adapter	Type of Flash	SCA3952 Module	SCA3000C Converter
Metz 44 MZ-2		Shoe-mount	x	
Metz 54 MZ-3		Shoe-mount	x	
Metz 45 CL-3 and -4		Handle-mount	x	x
Metz 60 CT-4		Handle-mount	x	x
Metz 70 MZ-5 and -4		Handle-mount	x	

The resulting flash exposure automation determines correct flash exposure and automatically adjusts the output of the flash. It also automatically corrects for exposure compensation normally required when using filters, close-up bellows or extension tubes. However, as with all TTL systems, it requires manual compensation for differences in film surface reflection characteristics. The amount of compensation is determined by experimentation and is performed on the Mamiya Film Magazine ISO setting.

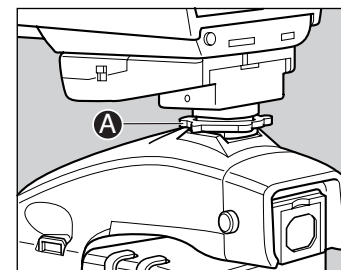

1. Mount the SCA3952 adapter onto the Metz flash, insert fully into the camera's hot shoe, then tighten with the locking knob **A**.
2. Set the exposure mode, then check the shutter speed and aperture.

Exposure mode	Shutter speed	Aperture
<b>P</b> Program AE	Automatically set by camera to 1/60 sec. when the metered shutter speed is 1/60 or slower, and 1/125 when it is 1/125 sec. or faster.	Automatically set by camera
<b>Av</b> Aperture priority AE		Any aperture
<b>Tv</b> Shutter priority AE	Automatically set by camera to 1/125 when the set shutter speed is 1/125 sec. or faster.	Automatically set by camera
<b>M</b> Manual mode		Any aperture
<b>X</b> Synchro mode	1/125 sec.	Any aperture

With TTL flash photography, the reflection of the flash is metered and the intensity of the flash is adjusted automatically, so TTL flash photography may not be able to suit to all conditions. In the cases described below, we recommend that you use a flash meter to check the intensity of the flash or to use a manual flash setting.

**For example:**

- (1) When the size of the subject you want to light with the flash is relatively small within the picture
- (2) When the background behind the subject is extremely bright or when there is a strongly reflective object in the background
- (3) When the background behind the subject is extremely dark (outdoors at night, etc.)
- (4) For flash photography with a narrow film latitude

## MEMO

1. While in the P or Av modes, the camera can be set to release the shutter at the metered value, even if the background behind the subject is dark. ➔ Custom settings (C-24 on page 95)
2. The sync. speed in the X mode can be set between 1/40 and 1/125 seconds. ➔ Custom settings (C-23 on page 95)

\* When the shutter speed is set to 1/2 increments, the sync. speed can be set between 1/45 and 1/125 seconds.

**Rear Curtain Sync Mode**

When a moving subject has been shot under this function, the flash of light appears after the moving subject.





Rear curtain sync mode



Front curtain sync mode

## MEMO

This function is set by Custom function setting.  
➔ Custom setting (C-27 on page 95)

<b>Charging completed indicator in viewfinder</b>	When charging of the flash is completed, a charging completed flash icon  will illuminate in the viewfinder's liquid crystal display panel.
<b>Automatic setting of flash synchronizing speed</b>	When exposure mode is set at "Av" or "P", the shutter speed will be automatically set to 1/60 to 1/125 sec. when charging of the flash is completed. When exposure mode is at "Tv" or "M" and the shutter speed is at faster than 1/125 sec., the shutter speed will be automatically set to 1/125 sec.
<b>Flash confirmation</b>	The flash charge mark  flashes after the shutter is released to indicate that the flash was emitted properly.
<b>Auto zoom control</b>	The power zoom reflector is linked to the lens focal length. (Excluding the Metz 32Z-2)
<b>Auto AF assist beam</b>	When the focus mode is set to "S", the auto focus assist beam is emitted automatically in low light. (Excluding the Metz 32Z-2)
<b>Display of flash range (distance)</b>	Displayed on the flash's liquid crystal display panel. (Excluding the Metz 32MZ-3 and Metz 32Z-2)
<b>Data transfer</b>	The film sensitivity data, exposure compensation data and aperture data are sent from the camera to the flash.

When using an SCA300 system flash (Metz 60CT-4, 45CL-4, etc.), use the SCA3000C converter (sold separately).

For details, refer to the operating instructions of the flash and the SCA adapter.

To use the guide number indicated on the flash fully, wait several seconds after the charging completed indicator lights.

**Cautions on using instant film**

Instant films (Polaroid 100-600 series and Fuji FP series), have a lower reflectivity rate than regular film. Exposure compensation is necessary when using the flash in the TTL mode.

In general, set the exposure compensation to about minus 1 or 1 1/3 EV.

# Flash Compensation Settings

By combined use of a Metz flash and the SCA3952 adapter, the camera adjusts for flash. It can be adjusted within  $\pm 3EV$  in increments of 1/3 steps.

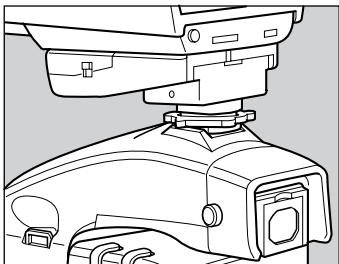

**1. Turn on the power**  
Install the SCA3952 adapter on the Metz flash, and put it on the camera then lock the flash in place using the locking knob on the flash shoe. Turn the shutter release mode selector lever to the "S" or "C" position, and turn ON the flash power switch.

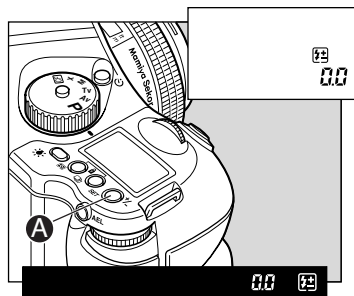

**2. When the flash charge confirmation lamp lights,** press the set button (A) in. The "0.0" display appears on the main LCD panel.

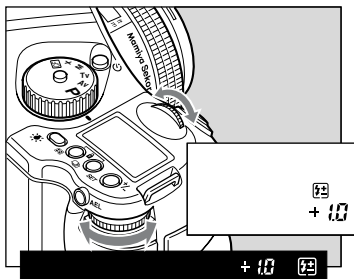

**3. Turn the front or rear dial to select the flash compensation value.**

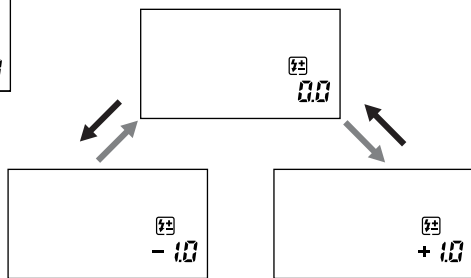

## External LCD Panel (normal display)

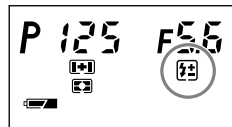

**4. When the shutter button is half-pressed,** the "0.0" display appears on the external LCD, and "0.0" appears on the LCD inside the viewfinder with a + compensation, or "0.0" appears with a - compensation.

## Viewfinder LCD read-outs.



If the flash-charge mark  $\text{⚡}$  is not displayed, the flash compensation button (A) can not be used.

Keep pressing the set button to activate the flash compensation mode. You can check the exposure compensation value.

If you turn the shutter release mode selector lever to the "L" (power OFF) position, the compensation value will be canceled.

**MEMO** Exposure compensation and flash compensation can be linked.  
➔ Custom settings (C-25 on page 95)

## Flash Photography with electronic flash models other than Metz

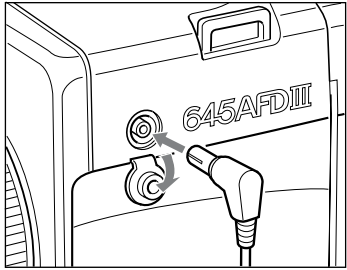

1. To use a grip type flashgun or a strobe with other electric contacts than X contact, connect the sync. cord to the camera's sync. terminal. (See note below about flashes designed exclusively for other maker's cameras.)

Remove the rubber cover when connecting the sync. cord.

After shooting, be sure to attach the rubber cover in order to protect the synchro terminal's contacts.

2. While pressing the unlock button, turn the exposure mode setting dial and set it to "X" (1/125 sec.) or "M" (manual).
- When "M" (manual) is selected, turn the front dial and set the shutter speed to 1/125 sec. or slower.
3. Turn the rear dial to set the aperture, then take the picture.

This camera's synchro contact is an X contact.

### WARNING

- Using flashes designed exclusively for other maker's cameras may damage the camera's internal mechanisms if connected to the camera's hot-shoe. In this situation, use an off-camera flash bracket and connect a sync. cord to the camera's synchro terminal.
- When using flashes with a flash duration of 1/500 sec. or longer, set the shutter speed to 1/30 sec. or less.

- MEMO**
1. The selected shutter speed and aperture level can be locked. → See page 79
  2. The sync. speed can be set between 1/40 and 1/125 seconds. → Custom settings (C-23 on page 95)

\* When the shutter speed is set to 1/2 increments, the sync. speed can be set between 1/45 and 1/125 seconds.

This is a function to allow various pieces of shooting information to be superimposed on the edge of the film. The info that is superimposed can be selected from the following three modes. To specify this function, use the Custom settings (C-02 on page 93).

This section describes the details of the information that can be superimposed.

- Exposure mode
- Aperture value
- Shutter speed
- Exposure compensation value / frame order with auto bracketing function: N, U, and O
- Metering mode\*
- Focal length of lens
- Index number

**DATA/INDEX mode** →  
(Superimpose shooting info and an index number)



**Data superimposed in manual mode** →

- Exposure mode
- Aperture value
- Shutter speed
- AE mode
- Exposure metering difference display
- Metering mode\*
- Focal length of lens
- Index number



★ When manual exposure is selected and when the exposure metering difference exceeds ±6EV, "– □ –" or "– U –" will be superimposed on .

**DATE/INDEX mode** →  
(Superimpose the date and an index number)  
Year, month, and date    Time    Index number



\* When the metering mode is selected as AUTO A-S (automatic change between average and spot), and if "A" is selected, "A" will be superimposed. If "S" is selected, "S" will be superimposed. If "AUTO A-S" is selected, "As" will be superimposed.

The data superimpose function is available with films having sensitivity from ISO25 to 1600. When using other films, even if the data superimpose function is used, data will not be superimposed.



# **Custom Functions**

**These functions allow the owner to change the camera functions and settings as they prefer.**

# Setting Custom Functions

The custom functions allow you to change the method for using or accessing the camera functions as you like. Take photographs the way you are most comfortable with. The custom functions can store separate settings for 3 users. You can preset the functions for indoor, outdoor or portrait photographs and for other conditions. When at C-00, chose 1 (A), 2 (B), or 3 (C) to store a specific set of user function selections for the group of custom settings from C-01 to C-32. However, if you set C-00 to 0, the settings used will be the default set. With this choice you can change only C-33 to 35.

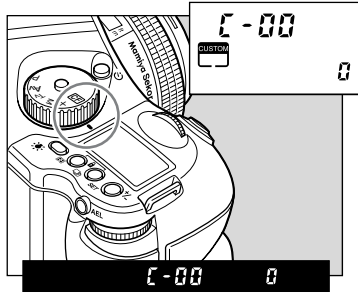

1. Turn on the power.  
Turn the shutter release mode lever to the "S" or "C" position.

2. Turn the exposure mode dial to select "CF" (Custom Function mode).

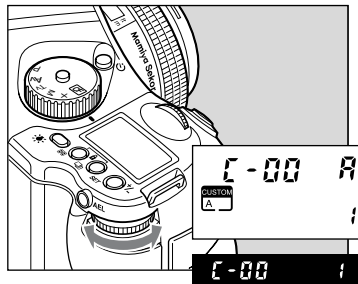

3. Turn the rear dial to select the settings for user A, B, or C.

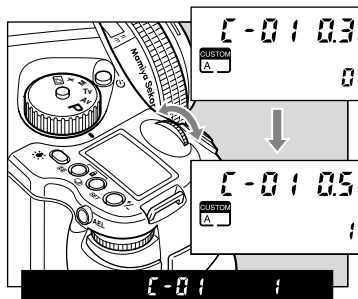
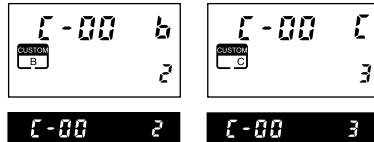

4. Turn the front dial to select the item you want to set.

There are 35 items from C-01 to C-35.

# Custom Functions of MAMIYA 645AFD III

No.	Item	(Initial setting)	1	2	3
C-00	Custom functions No		A	B	C
C-01	Steps of aperture, shutter speed, exposure compensation	1/3EV step	1/2EV step	1EV step	
C-02	Data imprinting	No	Yes (data, index)	Yes (date, index)	
C-03	Aperture setting after lens change	Yes	Open	Minimum	Number of stops
C-04	Metered value display time	15 sec.	5 to 60, on		
C-05	Range of exposure compensation	± 3EV	± 5EV		
C-06	External LCD backlight	Backlight button used	on		
C-07	Select battery	Alkaline-manganese	"Ni-CD, Ni-HM"		
C-08	Bracketing order	N-U-O	N-O-U	U-N-O	O-N-U
C-09	Cancel auto bracket	Power OFF	Until released	Released after one shot	
C-10	Manual mode bracketing	Shutter speed	F-number		
C-11	Front/Rear dial function exchange in manual mode	Front: Tv, rear: Av	Front: Av, rear: Tv		
C-12	Rear function dial enabled/disabled	No (Exposure compensation)	Yes		
C-13	Dial function direction	No switching (CCW:decrease/CW:increase)	Switched (CCW:increase/CW:decrease)		
C-14	Program shift	Program shift	F-number shift	Shutter speed shift	
C-15	AEL & AFL function button exchange	No (front: AFL /rear: AEL)	Yes (front AEL /rear: AFL)		
C-16	Half-press shutter release function mode	AF operation	AF operation/AE lock,		
C-17	AEL function lock/unlock mode	Continuous	Released after one shot	While the shutter button is pressed	
C-18	Focus indicator selection	Yes	No		
C-19	AFL function lock mode	Yes (no AF operation)	Yes (AF operation)		
C-20	M mode one-push setting	Shutter speed shift	F-number shift		
C-21	Bulb exposure time setting	60 minutes	1 to 60 minutes, on		
C-22	Bulb shutter release setting	While shutter button is pressed	Each time shutter button is pressed		
C-23	Shutter speed in X mode	1/125	1/90 (1/80)	1/60	1/45(1/40)
C-24	Automatic sync speed setting	1/60 to 1/125	Metered value (less than 1/125)		
C-25	TTL flash compensation mode	No	Yes		
C-26	AF beam setting	Fires	Does not fire		
C-27	Flash sync. timing	No	Yes		
C-28	Copy custom function	No	Yes (User A)	Yes (User B)	Yes (User C)
C-29	Custom function reset	No	Yes		
C-30	Shutter release without film	No	Yes		
C-31	Auto film loading setting	Shutter button pressed halfway	Closing rear cover		
C-32	Multiple exposure mode	Until multiple exposure button is pressed	Multiple exposure number setting		
C-33	Digital back CF configuration	No	A	B	C
C-34	Clock/calendar setting				
C-35	Index setting				



# Types of Custom Functions

## C-00 Custom functions No.

0: [Initial setting]

- 1: A
- 2: B
- 3: C

When "0" has been selected and set, none of the custom items can be set. "1," "2" or "3" must be selected and set without fail.

## C-01 Steps of aperture, shutter speed, exposure compensation

This function is used to set the shutter speed, f-number and exposure compensation value step width.

- 0: 0.3 (1/3EV step: initial setting)
- 1: 0.5 (1/2EV step)
- 2: 1.0 (1EV step)

## C-02 Data imprinting

This function is used to set whether to imprint the shooting data on the film.

- 0: No imprinting (initial setting)
- 1: Yes (data, index)
- 2: Yes (date, index)

## C-03 Aperture setting after lens change

This function is used to set the f-number display method for the previously used lens when the lenses have been changed over. The initial setting is "Yes," in which case the f-number of the lens prior to the changeover is displayed.

- 0: Yes (previous f-number: initial setting)
- 1: Aperture open
- 2: Minimum aperture setting
- 3: Number of stops from open

## C-04 Metered value display time

This function is used to set the time it should take for sleep mode to be established after the camera's power is turned on. The initial setting is 15 seconds. 5, 10, 15, 20, 25, 30, 40, 50, 60 or "on" can be selected and set.

Note that the batteries will discharge when "on" (no sleep mode) has been set.

## C-05 Range of exposure compensation

This function is used to set the maximum extent of exposure compensation. Its setting takes effect in AE shooting modes (P, Tv and Av).

- 0:  $\pm 3EV$  (initial setting)
- 1:  $\pm 5EV$

## C-06 External LCD backlight

This function is used to set the method for lighting the backlight of the external LCD panel.

- 0: Set using Backlight button (initial setting)
- 1: Always on (metering retention period)

## C-07 Select battery

This function is used to set the batteries used in the camera so that the remaining battery charge will be displayed correctly on the external LCD panel.

- 0: Primary batteries (alkaline-manganese batteries, lithium batteries: initial setting)
- 1: Secondary batteries (nickel-metal hydride batteries, nickel-cadmium batteries)

## C-08 Bracketing order

This function is used to set the shooting sequence for auto bracketing. The initial setting is "n-u-o" (normal/under/over). The shooting sequence for 2-frame bracketing is set in auto bracketing setting mode.

- 0: n-o-u (normal/under/over: initial setting)
- 1: n-o-u (normal/over/under)
- 2: u-n-o (under/normal/over)
- 3: o-n-u (over/normal/under)

## C-09 Cancel auto bracket

This function is used to set the release method of the auto bracketing shooting setting upon completion of auto bracketing shooting.

- 0: Released by turning the power OFF (initial setting)

1: Until released

2: Released after one shot

## C-10 Manual mode bracketing

This function is used to set whether bracketing is to be performed using the shutter speed or f-number during M (manual) mode auto bracketing shooting.

- 0: Shutter speed (initial setting)
- 1: F-number

## C-11 Front/Rear dial function exchange in manual mode

This function is used to change over the operations of the front and rear dials in the M (manual mode).

- 0: Front dial: shutter speed, rear dial: f-number (initial setting)
- 1: Front dial: f-number, rear dial: shutter speed

## C-12 Rear function dial enabled/disabled

In the initial setting, exposure compensation can be provided by the sub (rear) dial in P, Tv and Av modes. This function is used to set whether to allocate the operations of the front dial to the rear dial.

- 0: No (exposure compensation: initial setting)
- 1: Yes

## C-13 Dial function direction

This function is used to determine the direction in which the electronic dial is to be rotated to increase and decrease shutter speed, the f-number, and exposure compensation.

- 0: No switching (CCW: decrease, CW: increase: initial setting)
- 1: Switched (CCW: increase, CW: decrease)

## C-14 Program shift

This function is used to set the type of program shift. Under the initial setting, the shifting is performed along the program line. Av enables aperture-

priority shift within the possible metering range; Tv enables shutter speed-priority shift.

- 0: Program shift (initial setting)
- 1: F-number shift
- 2: Shutter speed shift

## C-15 AEL & AFL function button exchange

This function is used to set whether to change over the functions of the front and rear AEL and AFL buttons.

- 0: No (front: AFL, rear: AEL: initial setting)
- 1: Yes (front AEL, rear: AFL)

## C-16 Half-press shutter release function mode

This function is used to set the AE lock and AF operations when the shutter button is half-pressed.

- 0: AF operation (initial setting)
- 1: AF operation/AE lock

## C-17 AEL function lock/unlock mode

This function is used to set the method of operating the AEL button to lock AE. At the initial setting, when the AEL button is pressed, AE is locked; pressing the button again

releases the AE lock. At the "1" setting (released after one shot), after AE lock is set, it is released when the shutter is tripped. At the "2" setting, AE lock is set while the shutter button is being pressed.

- 0: Continuous: initial setting
- 1: Released after one shot
- 2: While the shutter button is pressed

## C-18 Focus indicator selection

This function is used to set whether the defocusing mark is to be displayed.

- 0: Yes (initial setting)
- 1: No (focusing mark only)



## Types of custom functions (continued)

### C-19 AFL function lock mode

This function is used to set the AF lock method when the AFL button is operated.

There is a choice between AF locking by pressing the AFL button and performing the AF operation for AF locking and AE locking.

- 0: Yes (AF lock only: initial setting)
- 1: Yes (AF operation/AE lock)

### C-20 M mode one-push setting

This function is used to set whether one-push shift operation in manual mode is to be based on the shutter speed or f-number.

- 0: Shutter speed shift (initial setting)
- 1: F-number shift

### C-21 Bulb exposure time setting

This function enables bulb shooting by setting the bulb shooting time from 1 to 60 minutes provided that the battery charge lasts. It can be used to decide on the bulb shooting time from 1 to 60 minutes.

### C-22 Bulb shutter release setting

This function is used to set how to operate the shutter button for bulb shooting. At the "0" setting, the shutter is opened and closed while the shutter button is held down; at the "1" setting, it is opened and closed each time the shutter button is pressed.

- 0: While shutter button is pressed (initial setting)
- 1: Each time shutter button is pressed

### C-23 Shutter speed in X mode

This function is used to set the shutter speed in X (synchronizing) mode. The initial setting is 1/125 sec. The kind of large flash unit for use in studios has a long firing time and so it may not synchronize at a high shutter speed setting. Take one or more test shots, then set the synchronization speed.

0: 1/125 sec. (initial setting)

1: 1/90 sec. (1/80 sec. )

2: 1/60 sec.

3: 1/45 (1/40 sec. )

When the exposure value step width has been set to 1/2 step

### C-24 Automatic sync speed setting

This function is used to set the shutter speed when using the flash unit made by Metz (with the SCA3952 adapter) in P (program) or Av mode.

- 0: 1/60 to 1/125 sec. (initial setting)
- 1: Less than 1/125 sec. (metered value)

### C-25 TTL flash compensation mode

This function is used to set whether to link exposure compensation and flash compensation when using the flash unit made by Metz (with the SCA3952 adapter).

- 0: Not linked (initial setting)
- 1: Linked

### C-26 AF beam setting

The AF auxiliary light fires automatically when the subject is too dark to perform AF, but this function can be used to prevent the AF auxiliary light from firing.

- 0: Fires (initial setting)
- 1: Does not fire

### C-27 Flash sync. timing

When a moving subject has been shot using the flash, a flash of light will appear ahead of the subject's movement under the initial setting. This function makes it possible to change this so that the flash of light comes after the moving subject as illustrated.

- 0: No (front curtain synchronization: initial setting)
- 1: Yes (rear curtain synchronization)

### C-28 Copy custom function

This function is used to group all the user symbol settings selected (custom functions that have been set) together with the other user symbols, and copy them.

- 0: No (initial setting)
- 1: Yes (copied to user A)
- 2: Yes (copied to user B)
- 3: Yes (copied to user C)

### C-29 Custom function reset

This function is used to group all the user function settings selected from C-01 to C-27 together, and initialize them (to the default settings).

- 0: No (initial setting)
- 1: Yes

### C-30 Shutter release without film

This function is used to set whether the shutter is to be tripped even when the film has not been loaded.

- 0: No (initial setting)
- 1: Yes

### C-31 Auto film loading setting

This function is used to set whether to feed the film (to the first frame) by half-pressing the shutter button or by closing the rear cover when the film has been loaded. The film can be fed to the first frame by half-pressing the shutter button even when the rear cover close has been established as the setting.

- 0: By half-pressing the shutter button (initial setting)
- 1: By closing the rear cover

When the camera is in sleep mode, the film will not start moving even when the rear cover is closed. Half-press the shutter button.

### C-32 Multiple exposure mode

This function is used to select whether, during multiple exposure shooting, the multiple exposures are to be taken by pressing the shutter button until the multiple exposure button is pressed or after the number of set multiple exposures have been taken (initial setting). When the number of multiple exposures is set, the film is wound up by one frame after the completion of the number of multiple exposures.

- 0: Until the multiple exposure button is pressed (initial setting)
- 1: Multiple exposure number is set

### C-33 Digital back CF configuration

This function is used to select the user function (A, B or C) when an MSCE-listed digital back has been loaded.

- 0: No (initial setting)
- 1: A
- 2: B
- 3: C

### C-34 Clock/calendar setting

This function is used for setting the calendar and clock. For details on the setting procedure, see page 23.

### C-35 Index setting

This function is used for setting the index numbers. For details on the setting procedure, see pages 21 and 22.



**Miscellaneous  
Operations**

# Changing the Focusing Screen

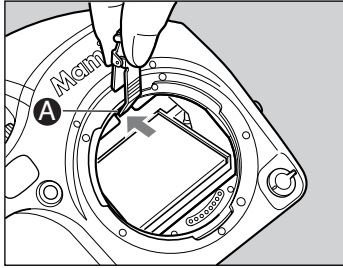

1. Remove the lens.
2. Pull the Focusing Screen Release lever **A** forward, as illustrated, with the tweezers to let the Focusing Screen down.

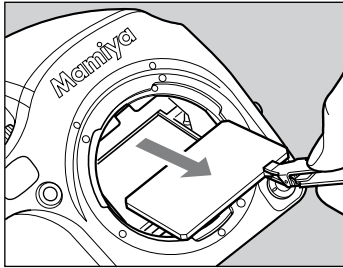

3. Remove the Focusing Screen from the Focusing Screen Frame by grasping the tab on the edge of the screen with tweezers as illustrated.

**Do not touch and damage the mirror in any way.**

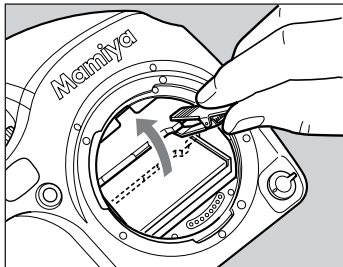

4. When installing the screen, pinch the tab of the screen with tweezers, and put the screen on the screen frame.

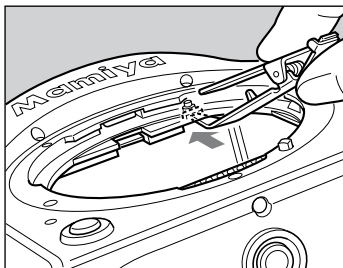

5. Push up the screen frame using the tweezers until hearing a clicking sound. The screen is now properly installed.

**Never press down on other parts as this will affect the focus function.**

## Caution

Since the Focusing Screens' surfaces are soft and easily damaged, handle them carefully.

Never touch the surface with bare fingers. Should dust settle on it, merely blow away by using a blower.

If the Focusing Screen needs cleaning, send it to the nearest authorized Mamiya service center. Do not attempt to clean the surface of the Focusing Screen, as it is very delicate.

When using the MAMIYA M645 manual focus lens, mount the focusing screen for manual focus lenses (sold separately).

1. Mount the M645 lens on the camera body, turn the A/M lever on the lens to the "M" position. Set the lens to maximum aperture, compose and focus. You may use the focus mark to adjust focus.

2. Select exposure mode and set the desired aperture on the lens.

For auto exposure, select the "Av" (aperture priority AE) and choose the spot exposure metering mode "S", you can use the lens in conjunction with stop-down metering.

3. Half press the shutter release button to show shutter speed.

### Available functions with M645 lens

	P	Av	Tv	M	X
Exposure mode	✗	☐	✗	☐	☐
Metering mode	✗	☐	✗	☐	✗
Exposure compensation	✗	☐	✗	☐	✗
Auto-bracketing mode	✗	☐	✗	☐	✗
Multiple-exposure mode	✗	☐	✗	☐	☐

✗ = not an available function

☐ = available function

You can adjust focus with assistance of the focus mark in the viewfinder LCD. When stopping down slower than f/5.6, the focus mark will be unworkable. In this case, the out of focus direction marks ► ◀ will blink and show that the picture is out of the focus adjustment range.

The AF assist beam does not emit with these lenses.

When using the camera at cold temperatures where the battery capacity may drop, use an External Battery Case PE401 (sold separately; PE401).

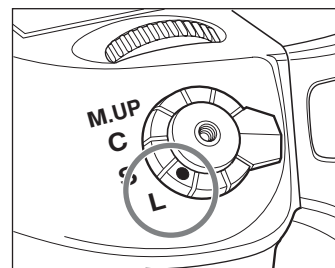

1. Turn the shutter release mode selector lever to the "L" position (power OFF).

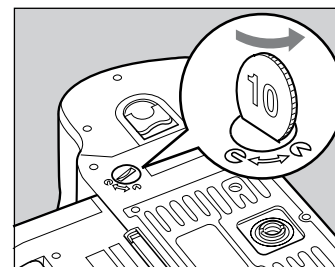

2. Use a coin or similar object to turn and remove the external battery socket cap.

3. Remove the battery case from the camera body.

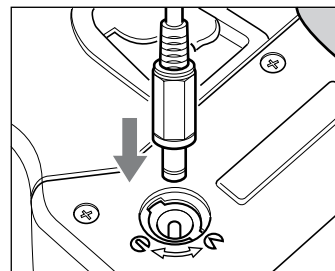

4. Connect the External Battery Case to the body. Connect the plug of the External Battery Case in which the batteries are installed, to the external battery socket.

5. Reinstall the original battery case, from which the batteries were removed, in the body. Turn the battery case lock lever to lock it in the body.

Make sure to reinstall the empty battery case into the body.

■ The empty battery cassette must be inserted into the body.

The batteries may generate heat if the external battery case is connected to the body while the batteries are loaded on the body.

### Using a Tripod

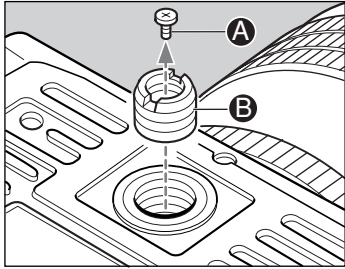

When using a tripod with 3/8" screw (instead of 1/4" screw) remove the small screw **A** from the tripod screw hole on the bottom of the body using a plus screwdriver, then use a coin to remove the tripod screw adapter bushing **B**.

### Memo Clip



The Memo Clip on the Back Cover fits the top cover of the film box and can also be used for other reminders.

In the conditions below or when the LCDs display the items listed in pages 105 and 106, they are not necessarily faults. Check the camera referring the descriptions below.

#### - Unable to release the shutter

- Check to see if the batteries are installed. Check to see if the batteries are dead.
- Check to see if the power is on (the shutter release selector lever should be set to “S” or “C” position).
- Check to see if the dark slide has been removed.
- Check to see if the film back is set to the correct ISO sensitivity (ISO indicator is not blinking).
- Check to see if the camera is advancing the film.
- Check to see if the rear door is open when film is not loaded.

#### - The viewfinder does not show LCD read-outs.

- Check to see if the batteries are installed. Check to see if the batteries are dead.
- Check to see if the power is on (the shutter release selector lever is other than in the “L” position).
- Check to see if the magazine is installed.
- If the camera has not operated for longer than 15 seconds, the viewfinder LCD read-outs will automatically disappear.

#### - The dark slide cannot be pulled out

- Check to see if the batteries are installed. Check to see if the batteries are dead.
- The magazine is not mounted onto the camera.

#### - Film cannot be wound.

- Check to see if the batteries are dead.
- Check to see if the film still has some remaining frames.
- Check to see if there is film loaded into the camera.
- Check to see if the camera is in multiple exposure mode.

This camera employs a microcomputer. It is possible that the camera may malfunction when exposed to static electricity or the like. In this case, turn OFF the camera power and then remove the batteries. Reinstall the batteries, then turn the power on. If the camera does not function properly after these steps, contact our sales office or service center.

# When Any of These Displays Appear

LCD display			Causes and remedies		Ref. page
Main LCD panel	Viewfinder LCD read-outs	Magazine LCD	Problems	Remedies	
End	End		<ul style="list-style-type: none"> <li>* When all frames have been exposed in the "C" (continuous winding) mode, this indicator will blink for three seconds.</li> <li>* When operating with multiple exposures and in shutter release "C" mode (continuous winding mode), if you keep pressing the shutter release button, and after completing the set number of multiple exposure, this indicator appears for 3 seconds and cancels the multiple exposure mode.</li> </ul>		39 71
		End	<ul style="list-style-type: none"> <li>* When there are no frames left on the film and the camera has completed winding of the film, this indicator appears.</li> </ul>	<ul style="list-style-type: none"> <li>- Take out the film and the "End" indicator will disappear.</li> <li>- Install a roll of film into the camera.</li> </ul>	39 32
		- -	<ul style="list-style-type: none"> <li>* When a roll of film is not loaded, this indicator appears.</li> <li>* When a roll of film is not rewound properly, this indicator appears.</li> </ul>	<ul style="list-style-type: none"> <li>- Press the shutter release button and emergency film winding button simultaneously.</li> </ul>	40
			<ul style="list-style-type: none"> <li>* If the camera cannot focus in the AF "S" (Single) mode, you cannot release the shutter.</li> <li>* When an M645 lens is installed and the aperture is less than f/5.6, this indicator appears.</li> </ul>	<ul style="list-style-type: none"> <li>- Try to adjust focus again, or change to the focus lock mode or manual focus mode.</li> <li>- Make the lens aperture faster than f/5.6.</li> </ul>	37 47
batt	batt		<ul style="list-style-type: none"> <li>* This indicator appears when the battery capacity is low.</li> </ul>	<ul style="list-style-type: none"> <li>- Replace with new batteries.</li> </ul>	12
-no-Fb	-no-FEB		<ul style="list-style-type: none"> <li>* This indicator will appear and auto-bracketing will be deactivated, when you try to perform auto-bracketing with less than three frame remaining in the "C" (continuous winding) mode.</li> </ul>	<ul style="list-style-type: none"> <li>- Continue to shoot in the multiple-exposure mode, or pull the dark slide and simultaneously press the film winding button and shutter release button.</li> </ul>	69
-no-	-no-ME		<ul style="list-style-type: none"> <li>* When the film magazine is removed in the multiple exposure mode, this indicator will appear and the camera will cancel the multiple exposure mode. However, the magazine does not exit from multiple-exposure mode.</li> </ul>	<ul style="list-style-type: none"> <li>- Remove the dark slide from the film back.</li> </ul>	72
-no-Fb	-no-Fb		<ul style="list-style-type: none"> <li>* The shutter will not operate when the dark slide is inserted into the magazine. If you try to press the shutter release button, this indicator will appear.</li> <li>* The shutter will not operated when the magazine is not installed onto the camera body. If you try to press the shutter, this indicator appears.</li> </ul>	<ul style="list-style-type: none"> <li>- Install the film back onto the camera body.</li> </ul>	32
			<ul style="list-style-type: none"> <li>* This symbol appears when setting the custom functions but you have not selected user A, B, or C.</li> </ul>	<ul style="list-style-type: none"> <li>- Select a user before changing the custom function settings.</li> </ul>	91
	- U - - O -		<ul style="list-style-type: none"> <li>* While in manual exposure mode, and when the difference between the set value and metered value exceeds 6EV, this indicator will appear.</li> </ul>	<ul style="list-style-type: none"> <li>- Change aperture or shutter speed.</li> </ul>	58,62,66
F- -	- -		<ul style="list-style-type: none"> <li>* This will appear when a lens is not installed.</li> <li>* When an M645 lens is installed.</li> </ul>	<ul style="list-style-type: none"> <li>- Install a lens on the camera body.</li> </ul>	101
Err-01 Err-02 Err-03 Err-04 Err-05 Err-06 Err-07			<ul style="list-style-type: none"> <li>When "Err" appears, some abnormality has been detected in the course of taking photos.</li> </ul>	<ul style="list-style-type: none"> <li>- Replace with new batteries and press the shutter release button. If the "End" indicator still does not disappear, put the dark slide into the magazine. While pressing the film-rewinding button, half press the shutter release button to rewind and take out the film. Then contact our sales office or service center.</li> </ul>	104

The camera caution mark will blink when the dark slide has not been pulled out, no film is present, or when the camera detects an abnormality.

# Specifications

Camera Type	: 6x4.5cm format, electronically controlled focal-plane shutter, TTL multiple mode AE, AF single lens reflex	Auto bracket shot	: Enable with auto bracket button (2 frame shots, or 3 frame shot with auto bracketing). Specify 1/3, 1/2, 2/3 or 1 EV steps.
Actual Image Size	: 56x41.5 mm	Flash Synchronization	: X contact point, 1/125 seconds (when 1/3 step is selected it can be set between 1/40 and 1/125 seconds).
Film Type	: 120 roll film (16 exposures); 220 roll film (32 exposures); Polaroid Land Pack Film (requires special HP402 magazine)	Flash control	: TTL direct flash control, supports Metz SCA3002 system (SCA3952 Adapter)
Lens Mount	: Mamiya 645 AF Mount, compatible with M645 Mount (manual focus confirmation, focus aid, stopped-down exposure metering)	Film transport	: Automatic via built-in motor, single or continuous exposures
Viewfinder	: Fixed prism viewfinder magnification x0.71; built-in diopter adjustment (-2.5 to +0.5, optional diopter correction lenses provide adjustment ranges of -5 to -2 diopter and 0 to +3 diopter); built-in eye-piece shutter	Film loading	: Automatic advance to the first frame when shutter release button is pressed halfway down or back cover is closed.
Focusing Screen	: Interchangeable, Matte (standard), Checker, and Microprism Type C for Non-AF M645 lenses.	Multiple Exposure	: Enable with multiple exposure button (the number of exposures can be set from 2 to 6). It can be canceled in the middle and the number of exposures can be changed, or you can switch to an arbitrary multiple exposure style.
Field of View	: 94%* of actual image	Mirror up shot	: Select by pressing the mirror up button.
Viewfinder Information	: Focus mark, defocus mark, warning mark, aperture value, shutter speed, metering mode (A, S, A/S), exposure compensation value (difference between set value and metered value) and flash ready / OK lamp with TTL Metz connection.	LCD displays	: Main LCD display: Program mode mark, custom function mode mark, AF area mark, battery level indicator, manual focus mode, superimpose mode, dial lock mark, shutter speed, AE lock mark, aperture value, multiple exposure mode mark, exposure compensation mode mark, flash compensation mark, exposure compensation value, self-timer mark, auto bracket mark, time mark (while setting the clock). Magazine LCD panel: ISO sensitivity, 120/220, number of shots.
Auto focus method	: TTL phase difference detection method; sensor: CCD line sensor (I+I type); operating range: EV0 to EV18 (ISO 100)	Data Imprinting	: 7 segment dot matrix; DATA mode: exposure mode, aperture value, shutter speed value, exposure compensation, metering mode, ID number; DAY mode: year, month, date, time, ID number; ID mode: ID number
Focus area	: Display the focus area in the viewfinder screen	Sync terminal	: X contact (sync speed 1/125 sec.)
AF assist beam	: Activates automatically under low light, low contrast. Range: 9m, Automatic switching to flash unit's built-in assist beam when Metz flash unit is attached.	Cable release socket	: On shutter button
AF Lock	: By pressing the shutter release button halfway down in the AF-S mode, or by pressing the AFL button.	Remote-control terminal	: On side of body; electromagnetic cable release
Exposure Modes	: Aperture-priority AE, shutter-priority AE, programmed AE (PH, PL setting possible), and manual	Self-Timer	: 2 to 60 sec. (standard: 10 sec., can be set in 1 sec. steps between 2 and 10 sec., and in 10 sec. steps between 10 and 60 sec.)
AE metering mode	: TTL metering, center-weighted average (AV), spot (S), and variable ratio (A-S auto)	Depth-of-field confirmation	: Preview Button on body
Increments of shutter speed and aperture	: Both the shutter speed and the aperture level can be set to 1/3 or 1/2 using the electronic dial lock function	Custom settings	: 35 items
Metering Range	: EV 2 to EV 19 (with ISO100 film, f/2.8 lens)	Tripod Socket	: U 1/4 inch and U 3/8 included
Exposure compensation	: ± 3 EV (1/3 step) Expandable to ± 5 EV	Power Requirements	: 6 AA-size batteries (alkaline-magnesium, lithium)
Film speed	: ISO 25 to 6400	External power socket	: An external battery case can be connected.
AE lock	: With AEL button; canceled by pressing the button again or shutter release	Size & Weight	: 6 "(W)X5 "(H)X7.3 "(D) / 153(W)X128(H)X184(D)mm : 3.9 pounds / 1,780 g (W/O battery)
Shutter	: Electronically controlled vertical metal focal-plane shutter. (vertical travel)		
Shutter speed	: AE 30 to 1/4000 sec. (1/8 step), manual 30 to 1/4000 sec. (1/2 or 1/3 steps), X, B (Bulb, electronically controlled), shutter curtain protection mechanism (open when magazine is removed, automatically closed when magazine is attached)		

\* This information is based on a linear (horizontal/vertical) measurement.

# Common Sense Camera Care and Practice

---

## Maintenance and check of the camera

- Read instructions before using camera.
- Protect camera against shocks and falls. Use the neck strap supplied with it, whenever possible.
- Check the batteries frequently and always carry spares. The sealed batteries supplied with the camera may have been subject to storage conditions which have reduced its service life.
- Be sure to wipe battery contacts before installation and watch correct polarity.
- Battery life differs, depending on frequency of use, type, age, storage condition, ambient temperature (use External Battery Case in very cold weather), etc.
- Always remove the battery (and film) when camera is not used for a long period of time.
- Always keep covers on lenses and camera body.
- Do not store the camera at temperatures exceeding 40°C (105°F) and -10°C (15°F). Also avoid humid or sea air environment.
- Prolonged disuse shortens camera life. Periodically exercise the shutter (at different speeds), lens diaphragms (at different apertures) and focusing mechanism.
- Protect camera against rain and moisture.
- Do not touch lens surfaces. Use blower or lens tissue to remove dust particles.
- Always test your equipment before going on important assignments.

## The Importance of Proper Maintenance

Your camera has mechanisms like film transport, shutter and diaphragm blades etc. They are controlled by gears, levers, springs, and so on. All require special lubrication from time to time. Ambient conditions can also affect these mechanisms, as well as the electronic components and the optical glass of your lenses. We therefore suggest that you have your camera and lenses checked, and if necessary serviced, periodically.

## After-Sale Servicing

- ✦ Be sure to read the terms and conditions in the warranty card.
  1. For inquiries, opinions or questions concerning the product, please contact your nearest Mamiya agent or service center.
  2. Servicing after the expiration of the period specified in the warranty card will be charged to the user. The freight and transport costs should always be paid by the user.
  3. The servicing parts for use in repair of the product will be retained at the factory for ten years from the date of discontinuation of production.
- Servicing is available for the same period as the servicing part retention period. As the product may be serviceable even after this period, please consult your dealer or nearest Mamiya service center for its serviceability.
- ✦ Servicing of malfunction or damage due to dropping, impact, fire, flood, etc.
  - 1) The degree of such a malfunction or damage will be judged by the Mamiya service department.
  - 2) Such a malfunction or damage will be classified either non-serviceable or serviceable. When the product is classified to be serviceable, it will be repaired at the expense of the user, even if the malfunction or damage occurred within the warranty period.