

EXAKTA

RTL1000

INSTRUCTION MANUAL



EXAKTA RTL1000

The EXAKTA RTL 1000, maintaining the use of the world-renowned quick-change bayonet and offering plenty of valuable innovations to up-to-date miniature photography, continues the great traditions of this high-performance camera. These innovations are based on the well-approved principle of the true single-lens reflex camera with its always parallax-free correspondence of reflex image and photograph. These are the most important features of your EXAKTA RTL 1000:

Simple arrangement of all operating controls. Interchangeable viewfinder systems: Finder Hood, Penta Prism, and TTL Penta Prism for the automatic exposure timing with internal measurement, the lens being stopped down or fully opened. Focal-plane shutter made of metal laminae and destined for the complete series of shutter speeds from 8 seconds to $\frac{1}{1000}$ second, 1 second to $\frac{1}{1000}$ second with built-in delayed-action release. B setting for any long shutter speeds. Right-hand and left-hand release. Quick tensioning with a 30° preliminary elevation for series of photographs. Instant return mirror. Synchronising switch for electronic flash units and flashbulbs: electronic flash units being synchronized with approximately $\frac{1}{125}$ second, fast burning flashbulbs with $\frac{1}{30}$ second. Automatic film loading system with free selection of film. Frame counter automatically returning to its initial position. Rewind release catching in. Interchangeable lenses with original EXAKTA quickchange bayonet and automatic diaphragm mechanism with internal release. On the left-hand release there can be employed any earlier EXAKTA lenses with automatic diaphragm mechanism. Accessories for any field of application.

We are delighted that you have chosen an EXAKTA RTL 1000 and we wish you every success with your new camera. We would like to advise you, however, to read this instruction manual carefully before you start using your camera. In this way you will obtain the greatest possible service from it, since you will eliminate from the outset the possibility of operating it incorrectly, and possibly damaging the mechanism. The EXAKTA RTL 1000 is a high-quality precision instrument which can naturally only be expected to answer all your requirements when it is always handled correctly.

Contents

	Page
Operating controls of the EXAKTA RTL 1000	4
Preparations for use	6
Film loading	7
Operating the shutter	11
Operating the lens	15
Using the Finder Hood	22
Using the Penta Prism	24
Using the TTL Penta Prism	26
Interchanging the viewfinder systems	27
Exchanging the focusing screen	27
Changing the film	28
Flash photography	30
Care of the camera and its accessories	32
Accessories	cover

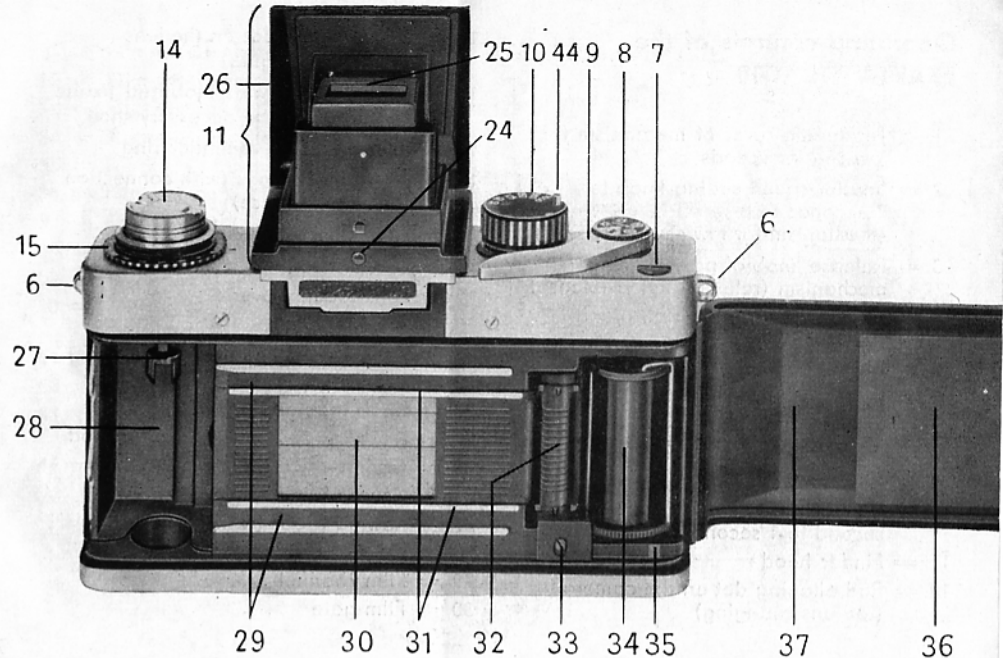
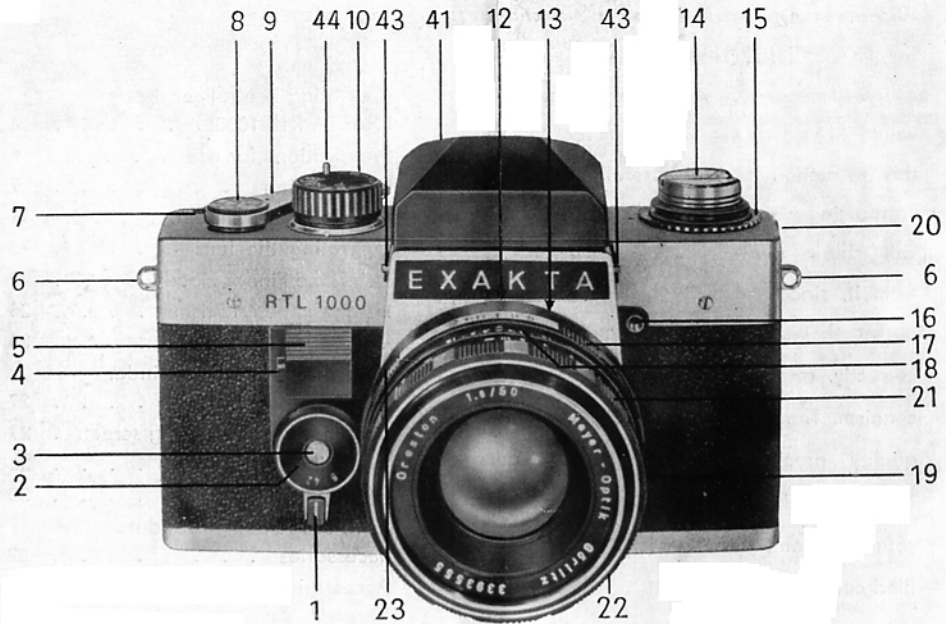

Operating controls of the EXAKTA RTL 1000

- 1 = Tensioning lever of mechanism for low shutter speeds
- 2 = Shutter-speed setting knob for 2 seconds to 8 seconds (mechanism for low shutter speeds)
- 3 = Release knob of preset timing mechanism (relayed-action release)
- 4 = Release lock on the right-hand release
- 5 = Right-hand release
- 6 = Eyelets for carrying strap or cord
- 7 = Frame counter
- 8 = Film-type reminder disc
- 9 = Rapid-wind lever
- 10 = Shutter-speed setting knob for $\frac{1}{1000}$ second to 1 second and B setting
- 11 = Finder hood
- 12 = Red aligning dot on the camera (for lens changing)

- 13 = Red aligning dot on the lens (for lens changing)
- 14 = Rewind crank with knob and fixture for attaching the accessory shoe
- 15 = Film-sensitivity reminder ring
- 16 = Left-hand release (with connection for cable release)
- 17 = Aperture-setting ring
- 18 = Depth-of-field scale
- 19 = Lens locking lever
- 20 = Flash nipple
- 21 = Distance-setting ring
- 22 = Lens
- 23 = Knob for stopping down the lens
- 24 = Knob for opening the finder hood
- 25 = (Swing-up) focusing magnifier
- 26 = Cover of finder hood
- 27 = Rewind arbor (with carrier)
- 28 = Cassette chamber
- 29 = Film channel
- 30 = Film gate

- 31 = Film-guide runners
- 32 = Film-wind sprocket
- 33 = Film rest
- 34 = Take-up spool (with catch bows)
- 35 = Mark
- 36 = Film-pressure plate
- 37 = Camera back (hinged)
- 38 = Rewind declutching button
- 39 = Tripod thread
- 40 = Diaphragm switch (for disengaging the automatic diaphragm mechanism)
- 41 = Penta Prism
- 42 = Eyepiece of Penta Prism
- 43 = Unlocking knobs for the viewfinder system
- 44 = Driver pin for the coupling of the TTL Penta Prism (page 26)

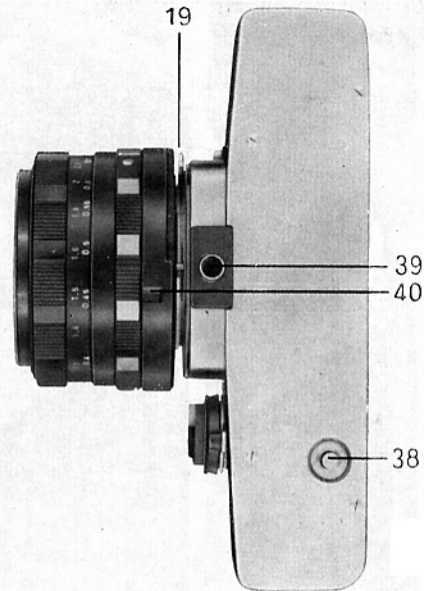

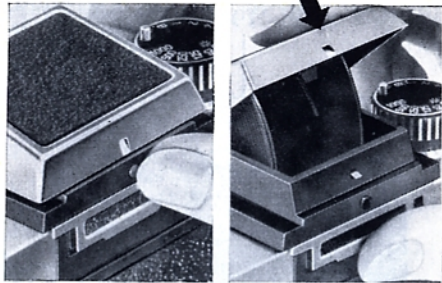

Preparations for use

The Finder Hood (11) is opened by pressing on the knob (24). To close the hood, press the cover of the Finder Hood (26) backwards until it locks in position. The focusing magnifier (25) can be swung either forward into the position of rest in the cover of the Finder Hood (26) or backwards into the working position. For further information on the use of the Finder Hood see page 22.

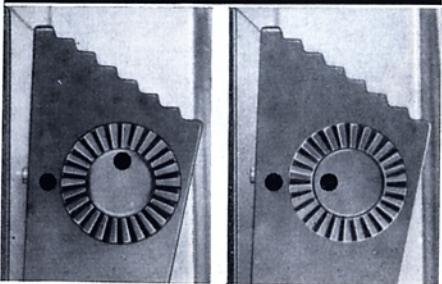

Swing the release lock (4) to the stop on the right (marking dots are staggered): the shutter can be released by pressing on the right-hand release (5). When you have finished taking pictures, swing the release lock (4) to the stop on the left (the marking dots are opposite each other): now it will be impossible to release the shutter, which means protection against unintentional exposures. (No locking in case of the left-hand release (16).)

Film loading

Loading and changing the film must not take place in direct sunlight! – The EXAKTA RTL 1000 uses standard 35 mm miniature film, in standardized, commercial cassettes of 12, 20 or 36 exposures, to make negatives 24 mm x 36 mm the beginning of the film having a shape according to the illustration. Perfect film transport requires faultless film cassettes. Daylight loading spools should only be inserted in capsules made by the same manufacturers.

1. Pull out the knob of the rewind crank (14) as far as the second stop: now the camera back (37) will open.

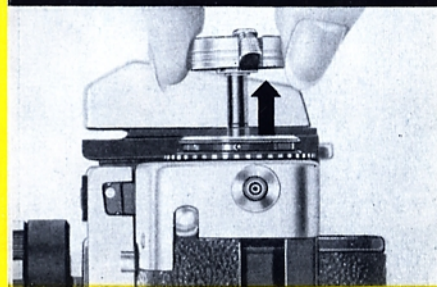
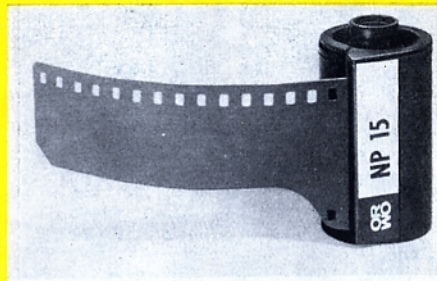

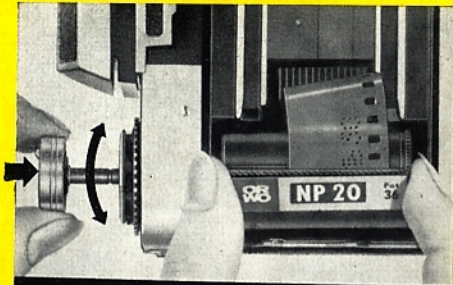

2. Place the cassette containing the unexposed film in the cassette chamber (28). Push the knob of the rewind crank (14) backwards, twisting it gently: the carrier of the rewind arbor (27) must engage with the cassette core.

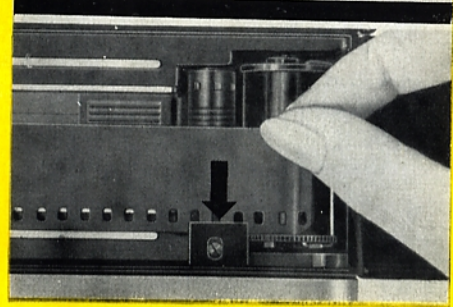

3. Pull the beginning of the film (29) as far as the green mark (35), and push it with its (lower) perforation from above under the film rest (33) and, accordingly, over the film-wind sprocket (32). The catch bow of the take-up spool (34) must not stand upwards!

4. Closing camera back (37) by pressing it lightly home, the locking taking place automatically.

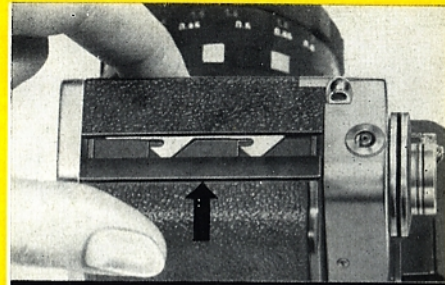



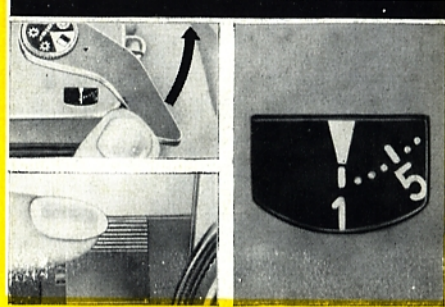

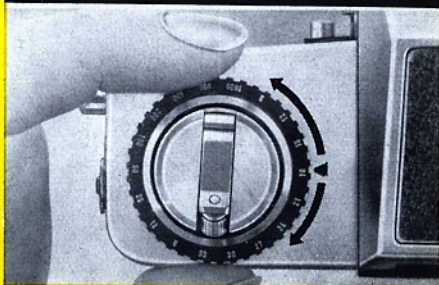
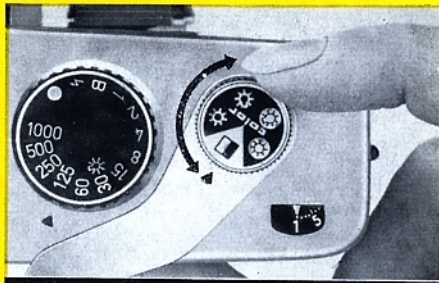
5. Now swing the rapid-wind lever (9) right up to its stop and let it return. Release the shutter by means of the right-hand release (5) or by means of the left-hand release (16). Repeat these operations until the figure "1" in the automatic frame counter (7) will be below the mark.





6. A special setting of the frame counter is not necessary since the latter, springing automatically back as soon as the camera back is opened, will begin to operate when the camera back is closed. — Afterwards the frame counter will indicate the number of photographs already taken on the film placed in the camera.

7. When film is loaded, set the film-type reminder disc (8) and the film-sensitivity reminder ring (15) as reminders of the type and sensitivity of the film that is in the camera. Turn the disc and the ring in either direction until the appropriate references will be opposite the orange-coloured triangles. On the film-sensitivity reminder disc (15) the figures from 9 to 33 are DIN values, whereas the figures from 6 to 1600 denote ASA values. The film-type symbols on the reminder disc (8) have the following meaning:

-  = black-and-white film
-  = reversible colour film for daylight
-  = reversible colour film for artificial light
-  = negative colour film for daylight
-  = negative colour film for artificial light

The EXAKTA RTL 1000 is now ready for action!

Operating the shutter

1. The shutter is tensioned and the film wound on by operating the rapid-wind lever (9). This lever should always be swung right up to its stop, and will then spring back of its own accord. — The tensioning of the shutter and the transportation of the film are coupled (avoiding unintentional double exposures and blank frames). It is impossible to release the shutter before it has been fully tensioned and the film wound on. It is also impossible to release the shutter in intermediate positions of the rapid-wind lever (9).

In order to enable users to work in quick succession (e. g. in case of series of photographs) the rapid-wind lever (9) can be employed with preliminary elevation: intermediate position at approximately 30° after the position of rest.

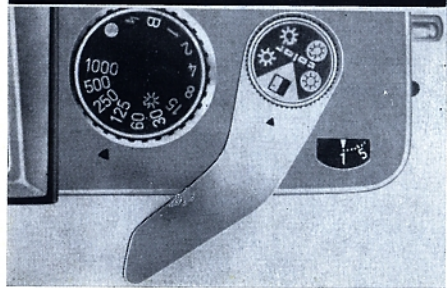
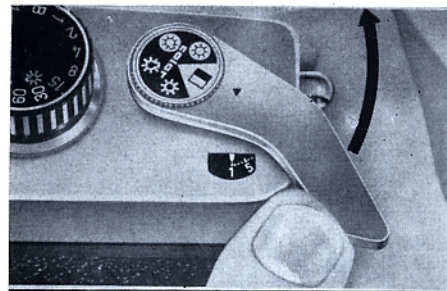

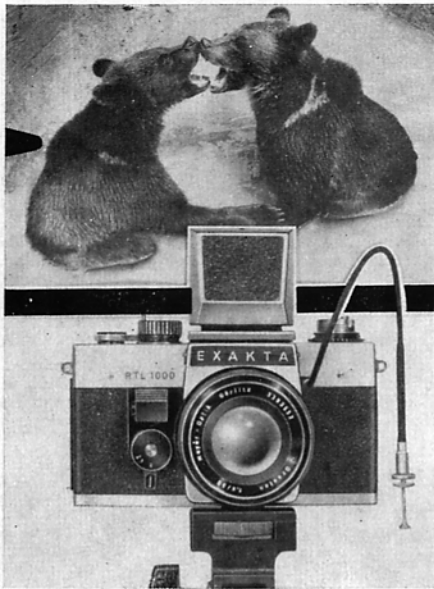

2. The image in any of the viewfinder systems (Finder Hood, Penta Prism, and TTL Penta Prism) will be visible even after the shutter has been released (instant return mirror). The red warning signal in the image in the viewfinder system indicates that the camera is not yet ready for action, and that the rapid-wind lever (9) must be cocked before the shutter is ready for release (See illustration: image seen through the Penta Prism).

3. Setting the shutter speeds

You will safely succeed in taking photographs with shutter speeds from 1/1000 second to 1/30 second (with the figures on the shutter-speed setting knob (10)) "by hand", i. e. without the use of a tripod. For any exposure times from 1/15 second to 1 second (orange-coloured figures on the shutter-speed setting knob (10)) and for still longer exposure times with the B setting, the camera should be screwed on to a tripod and a cable release be employed. Tripod thread (39) at the bottom of the EXAKTA RTL 1000, thread for the cable release in the left-hand release (16). All setting operations can be effected before and after tensioning the shutter.

Selection of exposure times from 1/1000 sec. to 1 second and B setting

Turn the shutter-speed setting knob (10) until the desired figure or the B will be at the orange-coloured triangle. The figures from 2 to 1000 represent fractions of seconds (e. g. 1/125 sec.). Intermediate speeds cannot be set. In case of the B setting the shutter will remain opened as long as the pressure on the right-hand release (5), on the left-hand release (16) or on a cable release screwed into the left-hand release (16) (important for exposure times longer than 8 seconds) continues. Accordingly, the B setting will permit any exposure times you like (e. g. for taking night and indoor exposures).

For working with the B setting a cable release with time-exposure lock can be recommended: After depressing the cable release, operate the time-exposure lock. The shutter will remain opened without having to keep one's finger constantly on the release (also eliminating camera shake) until the time-exposure lock is disengaged.

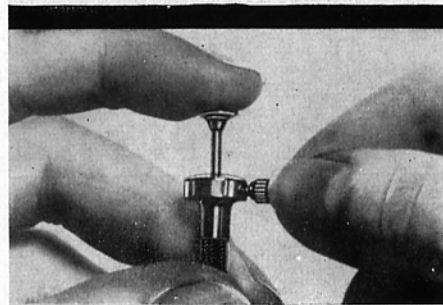
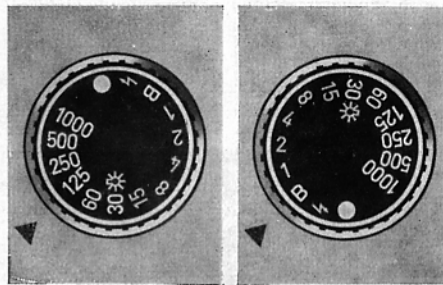

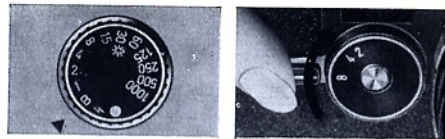

Selection of exposure times from 2 seconds to 8 seconds

Turn the shutter-speed setting knob (10) until the B is in line with the orange-coloured triangle. Swing the tensioning lever of the mechanism for low shutter speeds (1) in the clockwise direction to the stop. (This operation may be performed before or after tensioning the shutter). Turn the shutter-speed setting knob (2) of the mechanism for low shutter speeds until the desired exposure time (2 sec., 4 sec., or 8 sec.) will be opposite the mark on the tensioning lever of the mechanism for low shutter speeds (1). Release the shutter by means of the right-hand release (5) or of the left-hand release (16).

Selection of exposure times from $\frac{1}{1000}$ sec. to 1 sec. with delayed-action release

Turn the shutter-speed setting knob (10) until the desired exposure time will be opposite the orange-coloured triangle. Swing the tensioning lever of the mechanism for low shutter speeds (1) in the clockwise direction to the stop (= tension the preset timing mechanism; this operation may be performed before or after tensioning the shutter). Release the shutter only with the release knob of the preset timing mechanism (3). Exposure will take place after 8 seconds.

Operating the lens

1. The lenses of the EXAKTA RTL 1000 are equipped with internal release of the fully-automatic pressure diaphragm. Select the desired aperture number by turning the aperture-setting ring (17): the desired aperture number must be opposite the orange-coloured triangle.

The smaller aperture numbers, e. g. f 1.8, 2, 2.8, 4 indicate relatively large diaphragm openings: these permit brief exposures, but give only shallow depth of field. The larger aperture numbers, e. g. 16, 22, indicate relatively small diaphragm openings requiring longer exposure times, but giving great depth of field. Further information on the depth of field will be found on page 19.



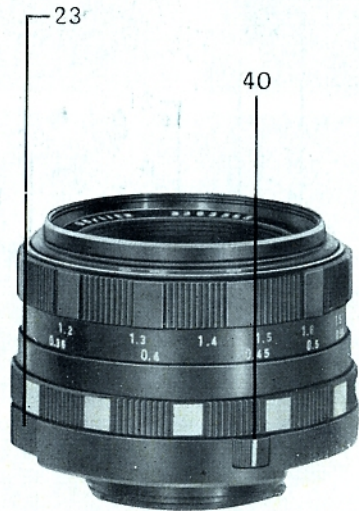

2. For critical focusing according to the image in the viewfinder system the lenses with internal release of the fully-automatic pressure diaphragm are fully opened. Owing to an energy store incorporated in the camera the automatic pressure diaphragm becomes the higher value "automatic spring diaphragm". The lens is stopped down automatically as soon as the shutter is released. In case of all the longer exposure times and of exposures taken by means of the delayed-action release the lens is also fully opened only after exposure. For focusing trials and in order to check the depth of field stop the lens down by way of trial by means of the stop-down knob (23). The automatic diaphragm mechanism is disengaged by means of the diaphragm switch (40) (with the mark = disengaged, orange-coloured mark = engaged). Then the lens is stopped down manually by operating the aperture-setting ring (17). This is important for the use of the TTL Penta Prism and for close-ups by means of extension-increasing accessories.

The lens is focused by turning the distance-setting ring (21) and by checking the definition of the image in the viewfinder system. After focusing, the correct camera-subject distance will be in line with the orange-coloured triangle. The lower values on the distance scale indicate metres, whilst the larger values possibly arranged above them represent feet. All distances are measured from the back of the camera to the subject.

Focusing for infra-red photography: When using infra-red film, first focus the image in the viewfinder system normally, then note the distance indicated by the orange-coloured triangle (either in feet or in metres or the infinity symbol), and turn the focusing ring to set this distance against the orange-coloured dot, the so-called infra-red setting mark which is to the right of the normal setting mark. By doing this, the image produced by the infra-red rays will be brought into sharp focus in the film plane of the camera and consequently will appear sharp in the negative.

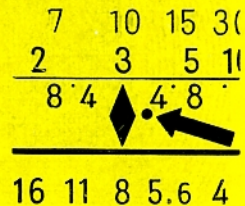



Focusing with focusing system

(Fresnel screen):

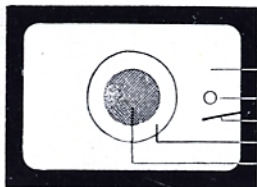

- Image-brightening Fresnel screen
- Circular mark
- Pointer of measuring device
- Annular field in the ground-glass screen
- Microprism

The EXAKTA RTL 1000 may optionally be supplied with a focusing system in all its viewfinder units. With this focusing system, a sharp image is mainly obtained using the annular field in the ground-glass screen (for moving subjects, photographs taken with a magnifier, and photomicrographs). To increase the accuracy of focusing or in case of slowly moving and stationary subjects focusing is performed by means of a microprism field. In case of incorrect focusing the microprism field will show an image which is blurred to a greater degree (the blurred image "flickers"). The lens will be correctly focused when the image in the microprism is at its sharpest (i. e. no flickers effect). It is however, absolutely necessary to focus with a large diaphragm opening (small aperture number) (this is important above all in case of lenses without internal release). With apertures

of 5.6 and smaller, the image in the microprism field will appear relatively sharp, even with the lens incorrectly focused. This, of course, will lead to unsatisfactory results. For extreme close-ups of magnifications greater than 1:1 and for photomicrography, the microprism cannot be used. The rest of the image in the viewfinder (Fresnel field) does not serve for focusing the lens.

Reading off the depth of field: When the depth of field is great, objects at widely varying distances from the camera will form a sharp image. After focusing the precise extent of this sharp zone will be indicated by the depth-of-field scale (18) on the lens: on either side of the orange-coloured setting mark (triangle) you can read off from the distance scale where the depth-of-field zone begins and ends for any specific aperture setting. If the relevant aperture number on one side of the central distance-setting mark is in line with the infinity symbol (∞) or — beginning from the centre — even beyond it, then the depth of field will extend right up to infinity.

On the right above one example:

Distance setting 3 metres, aperture f 8 = depth of field extends from something more than 2 metres to 5 metres.



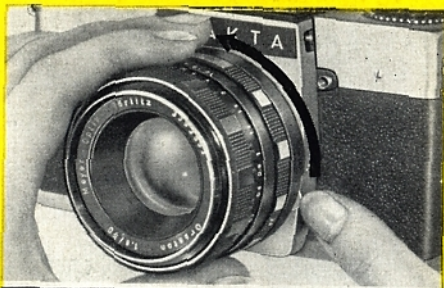

Changing the lens (22): Press the locking lever (19) towards the lens. Then turn the lens to the left until the orange-coloured dots (12 and 13) are in line. Lift the lens out towards the front. — To insert a lens, proceed in the reverse sequence: line up the orange-coloured dots, and turn the lens to the right until it locks in place.

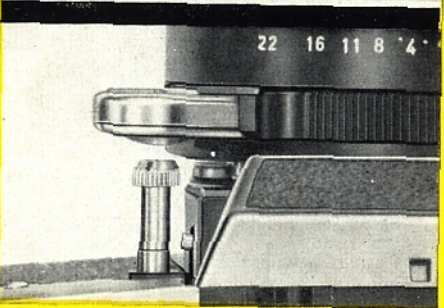

In the EXAKTA RTL 1000 there can be used special-purpose lenses with focal lengths ranging from the shortest to the longest. All lenses for the earlier EXAKTA and EXA models can be used. However, in order to be able to operate their automatic diaphragm mechanism (external release), you have to screw an adapter into the left-hand release (16).

Lenses for the EXAKTA RTL 1000

Name of lens, aperture, focal length (mm)	Diaphragm type ¹	Field angle	Front screw thread
PENTACON auto 2,8/29 internal release	APD	73°	M 55x0,75
Standard lens Oreston 1,8/50 internal release	APD	47°	M 49x0,75
PENTACON auto 2,8/100 internal release	APD	24°	M 49x0,75
Flektogon 4/20	ASD	93°	M 77x0,75
PENTACON 2,8/135	PD	18°	M 55x0,75
S 2,8/180 aus Jena	ASD	14°	M 86x1
PENTACON 4/200	PD	12°	M 58x0,75
PENTACON 4/300	PD	8°	M 95x1
PENTACON 5,6/500	PD	5°	M 118x1
Catoptric Lens 5,6/1000 aus Jena	no diaphragm	2,5°	built-in filter turret

¹ APD = automatic pressure diaphragm with internal release (in combination with the EXAKTA RTL 1000 the automatic pressure diaphragm is converted into the higher grade automatic spring diaphragm), ASD = automatic spring diaphragm with external release, PD = pre-set diaphragm.

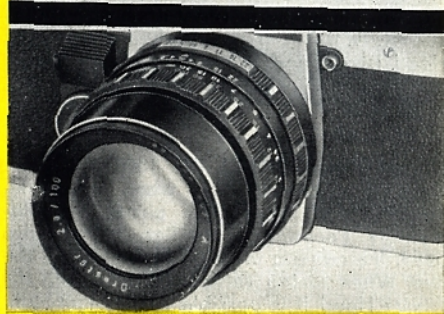
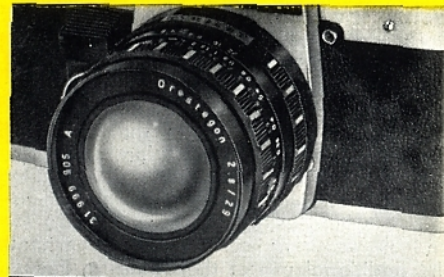

Using the Finder Hood

The image in the Finder Hood (11) of the EXAKTA RTL 1000 may be used both for selecting or framing the subject, and also for focusing and checking the depth of field, by provisionally stopping down the lens. Generally, a large enough image for normal viewfinding purposes will be obtained when using the image field; for critical focusing, however, we recommend the additional use of the Swing-up Focusing Magnifier (25). The latter will spring into its working position when the Finder Hood is opened, but can be folded back out of the way when operated as described at page 6.

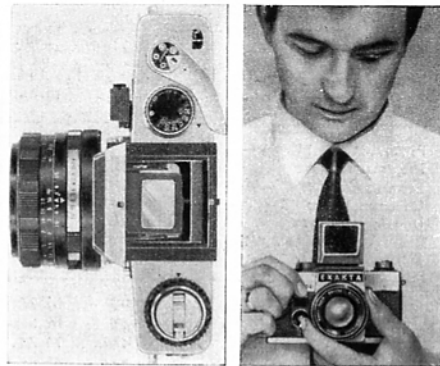

Normally, the EXAKTA RTL 1000 is held at chest or shoulder level when using the Finder Hood. When the pivoted supplementary Focusing Magnifier (25) is also used, the camera must be held close to the eye. When taking vertical pictures with the Finder Hood it is possible to shoot at right

angles. This is particularly useful for working inconspicuously since the photographer can remain in concealment. The image in the Finder Hood (11) can also be observed

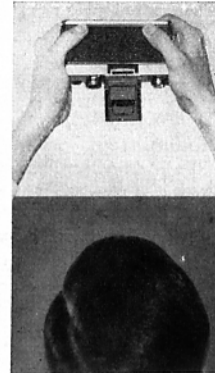
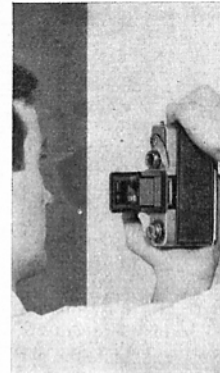

from below when the camera is held above the head. This will prove very useful when taking pictures over walls or over the heads of crowds.

Users who normally wear spectacles should use their distance glasses for focusing with the Finder Hood. For interchanging the Finder Hood, see page 27.

Using the Penta Prism

The Penta Prism (41) serves the same purpose as the Finder Hood, with the exception, that the image in the viewfinder will invariably be upright and laterally-correct no matter whether the camera is held horizontally or vertically; this is particularly useful when taking pictures of moving subjects, since the image in the viewfinder will move in the same direction as the subject itself. With very rapidly-moving subjects the camera can thus be "panned" by swinging it gently in the direction of motion of the subject, as for example, with racing cars.



When employing the Penta Prism (41) the camera should always be held at eye level. Viewing the image through the eyepiece (42) may be effected with either eye. This is the most advantageous way to use the EXAKTA RTL 1000 with Penta Prism: The camera should be focused with the thumb

and index finger of the left hand, the right index finger being used for releasing the shutter.

Photographers who normally wear spectacles should use their distance glasses for

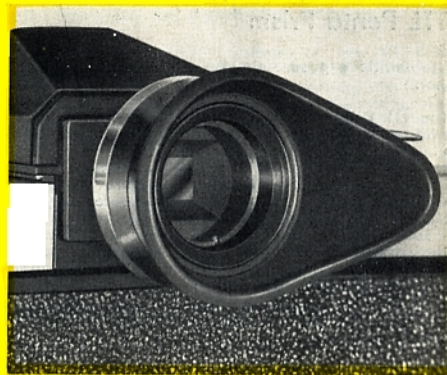

focusing with the Penta Prism. For fitting and removing the Penta Prism see page 27.

An invaluable accessory for use with the Penta Prism is the flexible eyepiece cup: this is fitted on to the eyepiece (42) of the

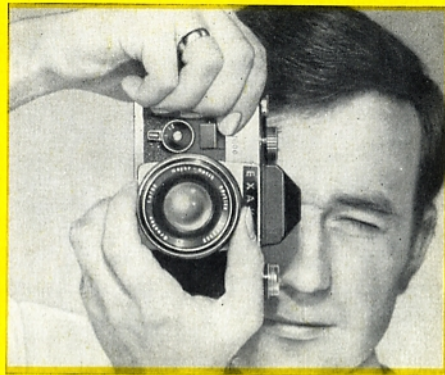

Penta Prism and shields it from distracting straylight. It is also helpful for spectacle-wearers since vision, correction lenses made by one's optician can be inserted into the revolving mount, making it possible to focus without wearing glasses.



TTL Penta Prism

(Automatic exposure timing with internal measurement)

The TTL Penta Prism provides the EXAKTA RTL 1000 with an automatic exposure timing on the basis of internal measurement through the lens (Through The Lens = TTL). This automatic system, taking into account film sensitivity, exposure time, and aperture number, will always measure only the light being effective for the photograph to be taken. This method of measurement is of greatest importance above all when employing special-purpose lenses (angle of view equal to the angle of measurement) as well as when working with extension-increasing accessories and filters (the exposure factors are automatically included in the measurements).

The use as a viewfinder unit is identical to that of the Penta Prism: always upright and laterally-correct image in the viewfinder. Photographers who normally wear spectacles should use their distance glasses. For fitting and removing the TTL Penta Prism as well as for exchanging its image field screens, see next page. — For the use of the automatic exposure timing (internal measurement) a detailed instruction leaflet is joined to the Penta Prism.

Interchanging the viewfinder systems

Each of the viewfinder systems of the EXAKTA RTL 1000 (Finder Hood, Penta Prism, and TTL Penta Prism) can be exchanged. — When any of the viewfinder units is being removed from the camera, the two unlocking knobs (43) must be pressed downwards with thumb and index finger of the left hand, and the viewfinder unit withdrawn upwards with the right hand without tilting. On replacing a viewfinder unit, it must be inserted squarely and vertically and be pressed downwards until it clicks into position. Never use force!

Exchanging the focusing screens

The focusing screen of the viewfinder units of the EXAKTA RTL 1000 can be exchanged so that, if desired, one of the special focusing screens can be used. — Remove the viewfinder unit from the camera. The focusing screen should be gripped by the long sides, and withdrawn from the viewfinder unit. To refit the focusing screen it should again be held by the long sides (do not touch the mat surface) and pressed into the frame of the viewfinder unit.

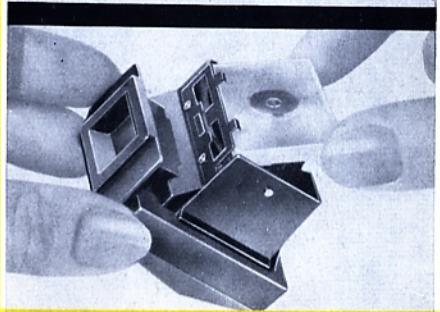

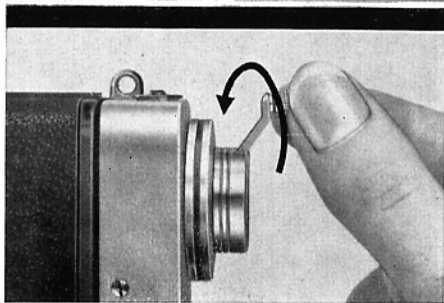
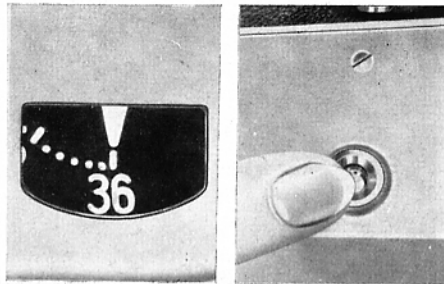

Changing the film

When the frame counter (7) indicates the maximum of exposures to be taken with the film with which the camera is loaded (12, 20 or 36), the film should now be rewound into its cassette.

1. Press the rewind declutching button (38) into the camera.

2. Swing the rewind crank (14) out, and turn it with the right hand evenly and slowly in the direction of the arrow (clockwise direction) until it is felt that it turns more easily, which means that the film has now been rewound. (If the film is rewound at too great a speed, static electricity will cause discharge marks to appear on the negatives.)

3. Swing the rewind crank (14) inwards and withdraw the knob of the rewind crank to the stop.

4. Open the camera back (37). Remove the cassette containing the rewound film from the camera. Depress the knob of the rewind crank (14) back. On the next tensioning of the shutter the rewind declutching button (38) will automatically return into its normal position.

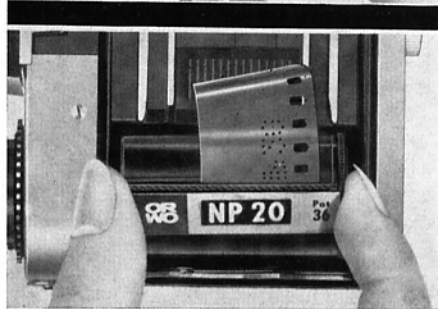
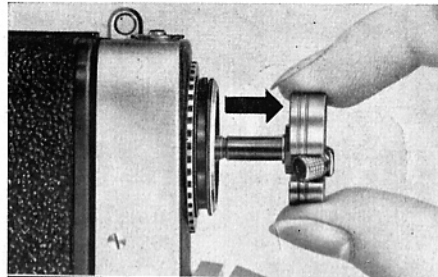

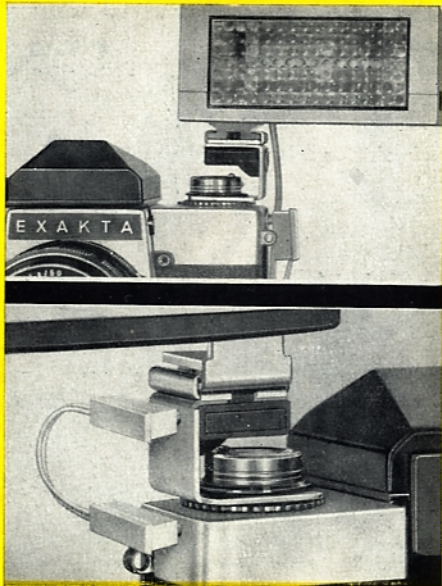

Flash Photography

The EXAKTA RTL 1000 is equipped with an X synchronization for electronic flash units and flashbulbs. The synchronizing cable of standard or electronic flashguns should be connected to the flash nipple (20). By means of an accessory shoe which has to be attached below the knob of the rewind crank (14), flashguns can be fastened directly to the camera.

The accessory shoe is also adapted for flashguns with central contact except that in this case the flash nipples of the camera and of the accessory shoe must be connected by means of the special cable delivered with the flashgun.

In case of electronic flashguns turn the shutter-speed setting knob (10) until the flash symbol ∇ will be in line with the orange-coloured triangle. The shutter speed set in this way is approximately 1/125 sec. Lower shutter speeds (1/60 sec., 1/30 sec., 1/15 sec. etc.) can also be set, for example 1/15 sec. or 1/8 sec. in case of electronic flashguns without storage condensers, designed for mains operation only.

In case of fast-burning miniature flashbulbs (for example NARVA X1, Osram AG 3 B, XM 1 B, XM 5 B as well as AG 3 B Super, PF 1 B, PF 5 B) turn the shutter-speed setting knob (10) until the flashbulb symbol and, accordingly, the fig. 30 will be in line with the orange-coloured triangle. This means that the shutter speed 1/30 sec. has been set.

In case of longer-burning flashbulbs set 1/15 sec. or any lower shutter speed. For all flashlight sources used with the EXAKTA RTL 1000 the effective exposure time will be approximately equal to the duration of the flash, and not to the time that the shutter remains open (this is important when taking photographs of moving objects).

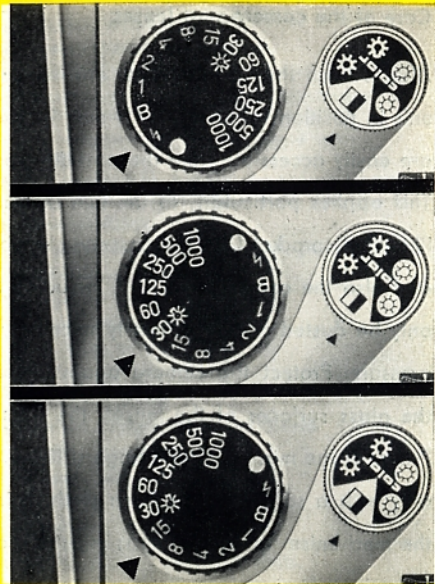

Care of the camera and lenses

Always keep the camera in its ever-ready case with the lens (or lenscap) and viewfinder unit in position; alternatively it may be kept wrapped in a fluff-free cloth. All parts which are easily accessible from the outside should be kept clean and dusted with a soft brush. This applies particularly to the film channel (29) with the film-guide runners (31) and the film-wind sprocket (32), the cassette chamber (28), the film rest (33), the take-up spool (34) and also the camera back (37) including the pressure plate (36). The reflex mirror should only be dusted when absolutely necessary, using a clean soft brush without applying any pressure. Protect the camera against moisture, dust, wind-borne sand, etc. Never touch the glass surfaces of the lenses, the focusing screens or the eyepieces of the two Penta Prisms or the mirror with the fingers. These glass surfaces should be cleaned when necessary only with a soft, fluff-free linen cloth. It is highly inadvisable to attempt to interfere with the mechanism of the camera; repairs should be undertaken only by authorized servicing agencies.

Accessories

Finder Hood

Penta Prism

TTL Penta Prism for internal measurement

Eyepiece cup for Penta Prisms

Ever-Ready Case

Counter-light Lens Hood with screw-in mount
M 49 x 0,75

Accessory shoe

Angular viewfinder for Penta Prisms

Focusing telescope for Penta Prisms

Bayonet rings and tubes as well as Two-in-one ring
for close-ups

Adapter rings with tappet 12,5 mm and 25 mm for
lenses with internal release (for close-ups)

Miniature Bellows Attachment

Autocouple Extension Release for lenses with
external release

Special ring with socket for cable release

Special adapter ring with double cable release

Multi-Purpose equipment for close-ups, reproduc-
tions and photomicrography, etc., consisting of the
following parts:

Should you want further information, we shall be pleased to send you any special leaflets.

The illustrations in this manual may differ in certain details from the actual appearance of the camera and its accessories.

Large Bellows Attachment

Transparency Copying Attachment

Copying Stand for direct fastening of the camera

Repro Unit (with Large Bellows Attachment, with
lighting equipment, if required) and others

Lighting equipment for Copying stand and
Repro Unit

Special-purpose lens T 2,8/50 from Jena, in sunk
mount for Large Bellows Attachments

Lens Reversal Rings

Adapter Rings for using photomicrographic lenses

Special Focusing Screens

Lens Magnifier insert with Top Lens

Macro-Micro Photometer

Ringflash Units RB 1 and RB 2

Kolpafot

Endoscope Attachment

Spectroscope Adapter Ring and Sleeve

Adapter for Astrophotography

Microscope Attachment

Universal tripod

Focusing slide

Original

EXAKTA

Dresden

Deutsche Demokratische Republik

Jt 926/71 III 27 28 971 5000 2477 E