

# SIGMA SD1

THE SIGMA SD1  
DIGITAL SINGLE LENS  
REFLEX CAMERA  
WITH FULL COLOR  
IMAGE SENSOR

## USER'S MANUAL

This manual explains how to use the **SIGMA SD1** digital SLR camera. For installation instructions of the supplied "**SIGMA Photo Pro**" software, please refer to the "Install Guide\_EN.pdf" file on the **SIGMA Photo Pro** disc.

For further information on how to use **SIGMA Photo Pro** and how to connect the camera to your computer, please click on Help in **SIGMA Photo Pro**.

# Thank you for purchasing the Sigma Digital Autofocus Camera

The Sigma SD1 Digital SLR camera is a technical breakthrough! It is powered by the Foveon® X3™ image sensor, the world's first image sensor to capture red, green and blue light at each and every pixel. A high-resolution digital single-lens reflex camera, the SD1 delivers superior-quality digital images by combining Sigma's extensive interchangeable lens line-up with the revolutionary Foveon X3 image sensor. You will get the greatest performance and enjoyment from your new SD1 camera's features by reading this instruction manual carefully before operating it. Enjoy your new Sigma camera!

- Please keep this instruction booklet handy for future reference. Doing so will allow you to understand and take advantage of the camera's unique features at any time.
- The warranty of this product is one year from the date of purchase. Warranty terms and warranty card are on a separate sheet, attached. Please refer to these materials for details.

---

## NOTES ON COPYRIGHT

---

This camera is intended only for personal use and should never be used in a way that infringes upon or contravenes international or domestic copyright laws and regulations. In addition, although it is intended purely for personal use, some restrictions may be applied to photographing demonstrations, performances, shows, exhibitions, or commercial properties, etc. Copyright or other legal rights should not be contravened.

- CompactFlash is a trademark of SanDisk Corporation.
- IBM PC/AT series computer is a trademark or registered trademark of International Business Machines Corporation (IBM) in the U.S.A.
- Microsoft and Windows are either registered trademarks or trademarks of Microsoft Corporation in the United States and/or other countries.
- Macintosh and MAC OS are registered trademarks or trademarks of Apple Inc. in the U.S.A. and /or other countries.
- Adobe and Photoshop are trademarks of Adobe Systems Incorporated.
- All other company or product names used in documents are trademarks or registered trademarks of their respective holders.
- Ricoh True Type Font designed by Ricoh CO., Ltd. is used for the display of the menu window of this camera.



## **Disposal of Electric and Electronic Equipment in Private Households**

Disposal of used Electrical & Electronic Equipment (Applicable in the European Union and other European countries with separate collection systems)

This symbol indicates that this product shall not be treated as household waste. Instead it shall be collected separately for the recycling of electrical and electronic equipment.

If the new products are purchased, this product might be handed over to the distributor or the collection system of waste electrical and electronic equipment eventually.

By ensuring this product is disposed of correctly, you will help prevent potential negative consequences for the environment and human health, which could otherwise be caused by inappropriate waste handling of this product or components of this product.

If this product is disposed illegally, it might cause a possibility of penalties.

For more detailed information about recycling of this product, please contact your local city office, your household waste disposal service or the shop where you have purchased the product.

## **PACKAGE CONTENTS / ACCESSORIES**

Please make sure that following standard accessories are included with your camera. If any of them are missing, contact the retailer from whom you purchased your camera immediately.

1. Camera Body (SD1)
2. Body Cap (on the camera)
3. Eyepiece Cup (on the camera)
4. Strap
5. Finder Cap
6. Li-ion Battery BP-21 (Battery Cover is included)
7. Battery Charger BC-21
8. Battery Charger Cable
9. USB Cable
10. Audio Video Cable
11. SIGMA Photo Pro Disc
12. Instruction Manual
13. Warranty Card
14. SIGMA Limited Warranty & Service Network

● No memory card is included with this camera. Please purchase this separately.

# TABLE OF CONTENTS

---

---

PACKAGE CONTENTS / ACCESSORIES .....	2
SAFETY PRECAUTIONS .....	6
HANDLING PRECAUTIONS .....	9
DESCRIPTION OF THE PARTS.....	11
CONTROL DIALS .....	13
CONNECTERS .....	13
VIEWFINDER.....	14
BASIC OPERATION AND QUICK REFERENCE .....	15
<b>PREPARATION</b> .....	<b>18</b>
ATTACHING THE CARRY STRAP .....	18
HOW TO USE THE FINDER CAP .....	18
LOADING THE BATTERY .....	19
CHECKING THE BATTERY STATUS.....	22
USING A HOME POWER SUPPLY (SOLD SEPARATELY).....	23
MOUNTING AND REMOVING THE LENS.....	24
SETTING THE LANGUAGE .....	26
SETTING THE TIME AND DATE .....	27
CAMERA SET-UP MENU .....	28
FUNCTION DISPLAY.....	35
QUICK SET MENU .....	37
CAMERA INFO PAGE.....	38
INSERTING AND REMOVING THE CARD.....	39
FORMATTING THE CARD .....	41
FRAME NUMBER COUNTER .....	42
DIOPTER ADJUSTMENT .....	43
HOLDING THE CAMERA .....	43
SHUTTER BUTTON .....	44
<b>BASIC OPERATION</b> .....	<b>45</b>
<b>SELECTING THE EXPOSURE MODE</b> .....	<b>45</b>
<b>P</b> PROGRAM AE.....	45
<b>A</b> APERTURE PRIORITY AE .....	47
<b>S</b> SHUTTER SPEED PRIORITY AE.....	48
<b>M</b> MANUAL EXPOSURE .....	49
BULB SETTING .....	50
<b>USING THE BUILT-IN FLASH</b> .....	<b>51</b>
USING THE BUILT-IN FLASH .....	51

EXPOSURE MODE AND BUILT-IN FLASH .....	52
FLASH FUNCTION SETTINGS .....	53
<b>FOCUSING</b> .....	<b>55</b>
HOW TO USE AUTOFOCUS .....	55
SELECTING THE AUTOFOCUS MODE .....	56
AF POINT SELECTION .....	57
AF AUXILIARY LIGHT .....	58
FOCUS LOCK .....	58
MANUAL FOCUS .....	59
AF DRIVE AND AF BUTTON SETTINGS .....	60
<b>OPERATION OF THE DRIVE MODE</b> .....	<b>61</b>
DRIVE-AREA .....	61
SINGLE FRAME SHOOTING .....	61
CONTINUOUS SHOOTING .....	62
SELF TIMER .....	63
MIRROR LOCK-UP .....	63
<b>ADVANCED OPERATION</b> .....	<b>65</b>
SETTING THE WHITE BALANCE (WB) .....	65
SETTING THE SENSITIVITY (ISO EQUIVALENCY) .....	67
IMAGE FILE SETTING .....	68
COLOR MODE .....	69
IMAGE PARAMETER AND COLOR SPACE .....	70
SELECTING THE METERING MODE .....	71
AE LOCK .....	72
EXPOSURE COMPENSATION .....	74
FLASH EXPOSURE COMPENSATION .....	75
AUTO BRACKETING .....	76
REMOTE CONTROLLER RS-31 .....	78
DEPTH-OF-FIELD PREVIEW BUTTON .....	81
FLASH PHOTOGRAPHY .....	81
AUTO ROTATE .....	83
CUSTOM MODE .....	84
<b>REVIEWING, DELETING AND MODIFYING IMAGES</b> .....	<b>86</b>
<b>QUICK PREVIEW</b> .....	<b>86</b>
CHANGING THE QUICK PREVIEW DURATION .....	86

<b>REVIEWING IMAGES</b>	<b>87</b>
VIEWING ONE IMAGE AT A TIME .....	88
MAGNIFYING IMAGES (ZOOMED-IN VIEW).....	89
VIEWING NINE IMAGES AT A TIME (CONTACT SHEET VIEW).....	90
VIEWING IMAGE INFORMATION.....	91
MAGNIFIED IMAGES IN IMAGE INFO SCREEN.....	92
HISTOGRAM.....	93
OVER-EXPOSURE WARNING .....	94
VIEWING IMAGES ON A TV .....	95
<b>DELETING IMAGES</b>	<b>96</b>
DELETE AN IMAGE WITH THE DELETE BUTTON .....	96
DELETE IMAGES FROM THE DELETE MENU .....	97
<b>OTHER REVIEWING FEATURES</b>	<b>98</b>
LOCKING IMAGES .....	98
MARKING IMAGES .....	100
ROTATING IMAGES .....	102
USING THE OK BUTTON SHORTCUT .....	104
SHOWING A SLIDESHOW .....	105
DPOF (DIGITAL PRINT ORDER FORMAT).....	107
<b>CHANGING OTHER SETTINGS</b>	<b>108</b>
FILE NUMBERING SYSTEM.....	108
CAPTURE SETTING DISPLAY .....	109
CUSTOMIZE THE DIAL.....	110
LCD OFF AND AUTO POWER OFF.....	111
AF MICRO ADJUSTMENT .....	112
RESET TO THE DEFAULTS.....	114
<b>REFERENCE</b>	<b>115</b>
OPTIONAL ACCESSORIES .....	115
MAINTENANCE .....	116
CLEANING THE IMAGE SENSOR.....	116
EXPLANATION OF TERMS.....	119
WARNING DISPLAYS.....	122
TROUBLESHOOTING .....	123
SPECIFICATIONS .....	125
CONNECTING YOUR CAMERA TO A COMPUTER .....	126

# SAFETY PRECAUTIONS

**To avoid causing damage or injury, please read this instruction manual carefully, before using the camera.**

**Please take special note of the following two cautionary symbols.**

 **Warning !!** Using the product and disregarding this warning sign may cause serious injury or other dangerous results.

 **Caution !!** Using the product disregarding this caution sign may cause injury or damage.

 This symbol denotes warning or point, where caution is required.

 Symbol contains information regarding the actions that must be avoided.

## **WARNING (BATTERY, BATTERY CHARGER AND AC ADAPTER)**

 Keep batteries in a safe place out of children's reach. If a battery is swallowed, call for emergency medical aid immediately.

 Do not use any battery other than the designated battery types. Doing so may cause battery explosion, battery leakage, camera damage, injury or fire.

 Do not use any battery other than that specified in this booklet. Otherwise, it might cause battery explosion, battery leakage, camera damage, injury or fire.

 Avoid any shock, shake and drop. Ignoring this warning may cause battery explosion, or battery leakage, resulting in injury or fire.

 Never disassemble, short circuit, heat, batteries or put batteries into fire. Ignoring this warning may cause battery explosion, battery leakage, injury or fire.

 Please only use charger with dedicated battery. Charging other battery types causes battery explosion, battery leakage, camera damage, injury or fire.







 If for some reason, the camera or batteries emit smoke, or if overheating or the smell of burning is detected, remove the batteries, taking care to avoid being burned, Take the camera to the retailer where you bought it, or to an authorized Sigma service station.

 Please follow all guidelines, rules and regulations of your community regarding the disposal of batteries.









 If you do not use the camera for a long period of time, remove the battery.

 Do not use any AC adapter other than the one provided with your camera. Using other brands may cause electrical shock and fire

## SAFETY PRECAUTIONS



-  The AC Adapter is designed for use with this product only. Do not use it with any other appliance. Doing so may cause overheating, fire, electric shock or injury.
-  If the adapter is emitting smoke, generating a strange odor or making an abnormal noise, while in use, disconnect the power plug from the outlet immediately. Otherwise, fire or electric shock may result.
-  If water or a foreign object gets into the adapter, unplug from the AC outlet immediately. It could cause fire or electric shock.
-  Do not attempt to modify or disassemble this product. Doing so can cause fire or electric shock.
-  Do not place any heavy objects on the power cord, or pull it, bend it unduly, or heat it. It could damage the cord, and could cause fire or electric shock.
-  Do not use this product with AC voltage other than the specified power supply voltage (AC100V - 240V). Doing so could cause fire or electric shock.
-  Use a safety approved AC power cord as is specified by each country.

### **WARNING (CAMERA)**



-  Never use your camera in an environment where flammable or burnable, gas, liquids or chemicals, such as Propane, Gasoline, etc., are present.
-  Keep the camera in a safe place that children cannot reach. Playing with the camera strap around one's neck can cause strangulation.
-  Do not disassemble the camera; Doing so can cause electric shocks and burns.
-  Do not touch internal parts of the camera that become exposed as a result of damage, it could cause fire or electric shock. Remove the batteries and contact an authorized Sigma service station.
-  After attaching a lens, do not look directly at the sun, through the viewfinder. Doing so can cause damage to the eye or loss of eyesight.
-  Do not look at the sun with the lens of your camera; otherwise you can lose your eyesight.
-  Keep the camera away from moisture or water. If you drop your camera/lens in water, please contact the retailer where you purchased the camera, or a service station immediately. If you use the camera with this condition it can cause electric shock or fire.
-  Prevent water, or metallic and other conductive objects from coming into contact with the terminals of Camera Body. This can result in electric shock, overheating and fire.







## SAFETY PRECAUTIONS

-  Do not fire the flash close to eyes. Otherwise, the bright light would damage the eye. Keep at least 1m/3feet distance between face and the camera, when taking a picture with flash.
-  Do not cover the flash with your finger or hand, it can cause skin burn.

### CAUTION (BATTERY CHARGER AND AC ADAPTER)

-  Do not pull the Battery Charger or the AC power cord, when disconnecting the AC adapter from the AC outlet. It could cause fire or electric shock due to damaged cord. Always take hold of the moulded AC plug, when unplugging it from the outlet.
-  Do not cover the Battery Charger or the AC adapter with cloth, cushions, etc. It could cause excessive heat, deform the case, and cause fire.
-  When Battery Charger is not used unplug it from the outlet.

### CAUTION (CAMERA)

-  Do not aim your lens or camera & lens combinations toward the sun; light entering through the lens could cause damage to eyes or fire.
-  Please do not carry your camera while a tripod is attached, as this could result in injury or a fall.
-  Please do not grasp the camera with wet hand, as it might cause electric shock
-  Do not leave the camera in a hot place or in a car parked in the sun. If the camera becomes hot, it might cause burns to the skin.
-  If the liquid crystal display (LCD) monitor becomes damaged, be careful of the fragments of glass, which can cause injury. If the liquid inside the LCD monitor leaks out, and you are faced with the following situations, please do as follows.
  - If the liquid adheres to clothes or the skin, wash it away with soap immediately.
  - If the liquid enters the eye, flush the affected eye with clean water immediately for 15minutes, and seek medical assistance.
  - If the liquid is swallowed, drink large quantity of water, induce vomiting and seek medical assistance.

# HANDLING PRECAUTIONS

---

---

## **Please read this section before using the camera.**

Study and familiarize yourself with the functions of your camera before using it. No compensation or guarantee is provided for unsatisfactory pictures or loss of profit, etc.

Carry spare batteries when you use the camera in a cold environment, on a field trip, or when taking many pictures at one time.

Do not use this camera with any external flash unit other than Sigma Flash EF-610/530/500 DG SUPER SA-STTL or EF-610/530/500 DG ST SA-STTL, which have special contact pins on the hot shoe. The flash units are offered as optional accessories. Other brands of external flash units may damage the camera's circuit boards or may not function properly.

---

## ENVIRONMENT

---

- Your camera is a precision instrument. Do not drop it or subject it to physical shock.
- This camera is not waterproof, and cannot be used underwater. Wipe off any water droplets with a dry cloth as soon as possible. If the camera gets really wet, promptly consult your nearest Sigma Service Center.
- Do not leave the camera in a dusty, hot, or highly humid environment for a long period of time.
- If the camera is moved from a cold place to a warm room, water droplets may appear on the camera. Please keep the camera in a bag until it is acclimatized to the ambient room temperature.
- The camera will work within a temperature range between 0°C/32°F and +40°C/104°F and humidity less than 80% (no condensation). However, in cold temperatures below 0°C, the power performance of the battery reduced. Please carry a spare battery in these circumstances, and keep the batteries warm.
- Static electricity or magnetic fields, may effect the operation of the camera. If such exposure occurs, please remove the battery from the camera and re-insert it, to reset the camera's microprocessors.

---

## HOW TO STORE THE CAMERA

---

- If you intend to store the camera for a long time, remove the battery.
- To avoid growth of fungus, store the camera and lens in a dry, cool and ventilated place, with a drying agent such as silica gel. Keep your equipment away from chemicals.

---

## NOTE ON THE TFT COLOR LCD MONITOR

---

- A few pixels may always be lit or may never light on the LCD monitor. This is not a failure or malfunction. Images recorded with the camera will not be affected.
- Because of the normal physical characteristics of the liquid crystal, the reaction of the display may become slow at low temperatures. At high temperatures, the display may become dark, but it will return to normal at room temperature.

---

## COMPACTFLASH™ (CF) CARD (SOLD SEPARATELY)

---

The SD1 camera uses CompactFlash™ (CF) card (Type 1).

- ◆ In this instruction manual, CompactFlash™ (CF) card is referred to as the 'card'.
- Do not bend or drop the card. In addition, avoid any shock to the card.
- Do not spill any liquid onto the card.
- Do not leave the card in direct sunlight or near a heating device.
- Avoid storing cards in environments of high temperature and humidity or where static electricity or electromagnetic fields may be generated
- For proper usage of the card, please refer to their instruction manuals.
- The "Delete" feature of the Camera and PC may not delete the data in the memory card completely. Some data might still remain. If you wish to remove all data from the card securely, please use third party software.

# DESCRIPTION OF THE PARTS

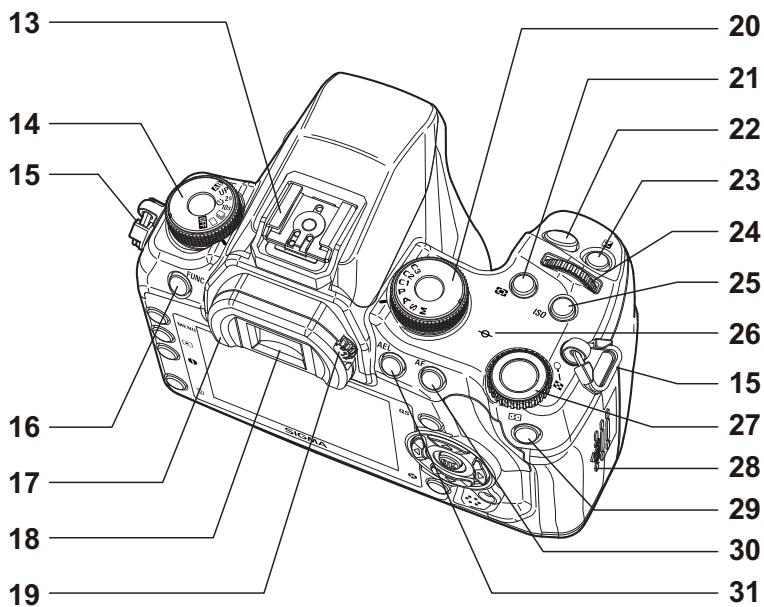
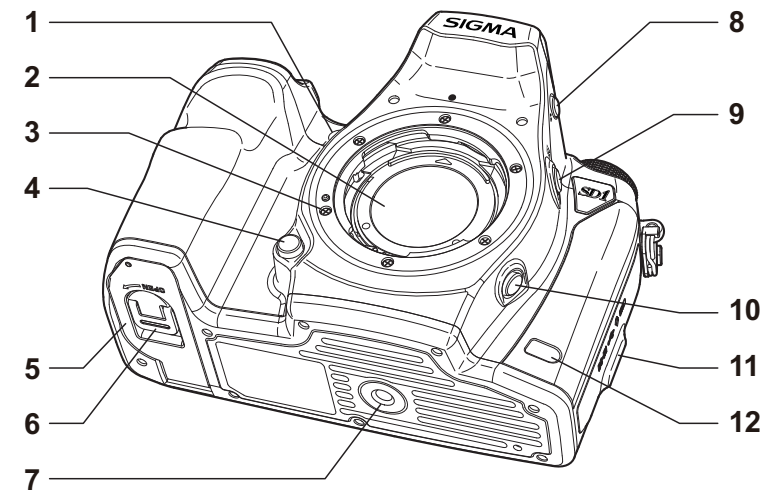

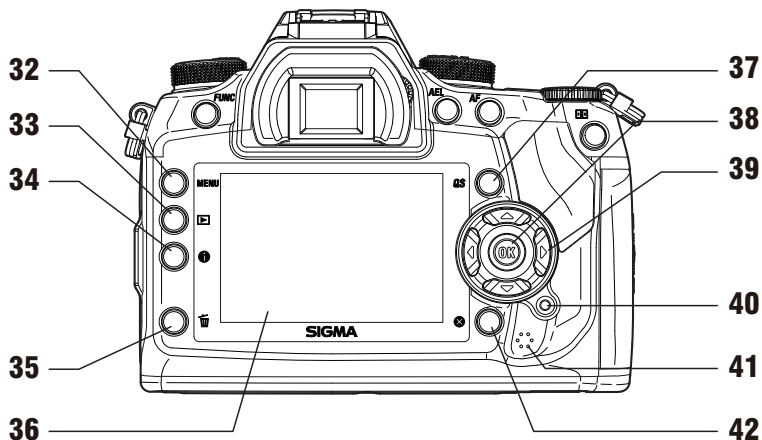

- |                                        |                                     |
|----------------------------------------|-------------------------------------|
| 1. AF AUXILIARY LIGHT                  | 23.  (EXPOSURE COMPENSATION) BUTTON |
| 2. DUST PROTECTOR                      | 24. A-DIAL ()                       |
| 3. LENS MOUNT                          | 25. ISO (ISO SENSITIVITY) BUTTON    |
| 4. LENS LOCK BUTTON                    | 26. FOCAL PLANE MARK                |
| 5. BATTERY COMPARTMENT COVER           | 27. S-DIAL ()                       |
| 6. BATTERY COMPARTMENT COVER LATCH     | 28. CF CARD COVER                   |
| 7. TRIPOD SOCKET                       | 29.  (AF POINT SELECTOR) BUTTON     |
| 8.  (BUILT-IN FLASH POP-UP)BUTTON      | 30. AF (AF) BUTTON                  |
| 9.  FLASH EXPOSURE COMPENSATION BUTTON | 31. AEL (AE LOCK) BUTTON            |
| 10. DEPTH-OF-FIELD PREVIEW BUTTON      | 32. MENU (MAIN MENU) BUTTON         |
| 11. CONNECTOR COVER                    | 33.  (VIEW) BUTTON                  |
| 12. REMOTE CONTROL SENSOR              | 34.  (INFORMATION) BUTTON           |
| 13. HOT SHOE                           | 35.  (DELETE) BUTTON                |
| 14. D-DIAL (DRIVE DIAL)                | 36. COLOR LCD MONITOR               |
| 15. CAMERA STRAP EYELET                | 37. QS (QUICK SET) BUTTON           |
| 16. FUNC (FUNCTION) BUTTON             | 38.  (OK) BUTTON                    |
| 17. EYEPIECE CUP                       | 39.  4-WAY CONTROLLER               |
| 18. VIEWFINDER EYEPIECE                | 40. BUSY LAMP                       |
| 19. DIOPTRER ADJUSTER                  | 41. SPEAKER                         |
| 20. MODE DIAL                          | 42.  (CANCEL) BUTTON                |
| 21.  (METERING MODE) BUTTON            |                                     |
| 22. SHUTTER BUTTON                     |                                     |

# CONTROL DIALS

## D-DIAL

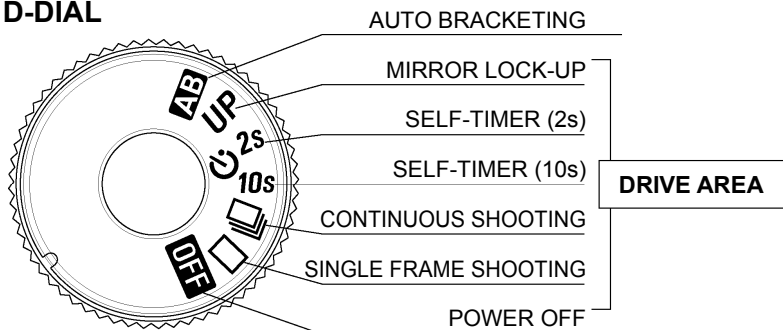

## MODE DIAL

CUSTOM MODE

PROGRAM AE

APERTURE PRIORITY AE

SHUTTER SPEED PRIORITY AE

MANUAL EXPOSURE SETTING

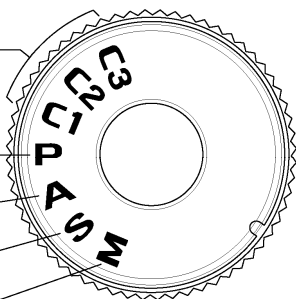

# CONNECTERS

PC SYNCHRO TERMINAL

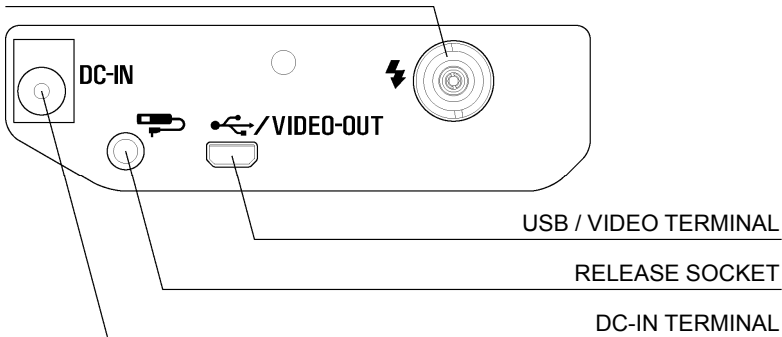

# VIEWFINDER

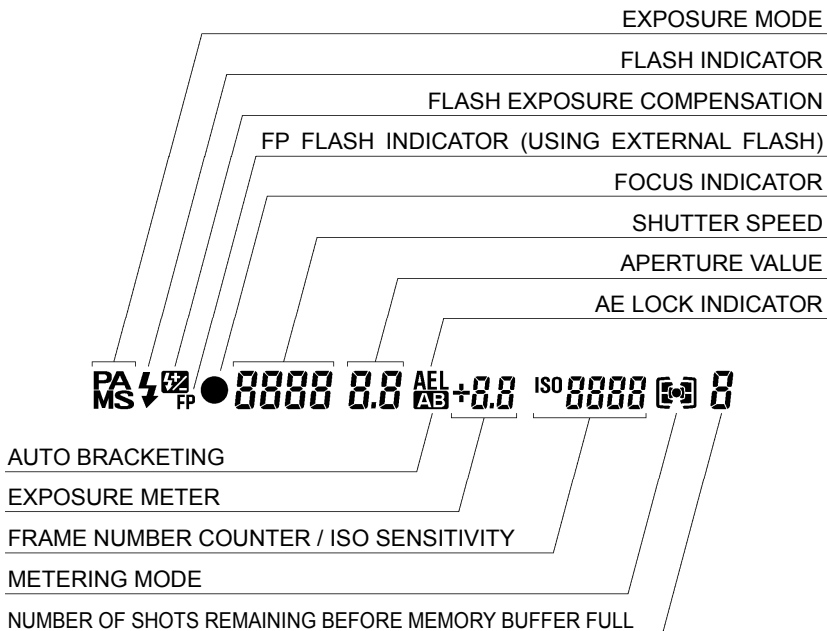
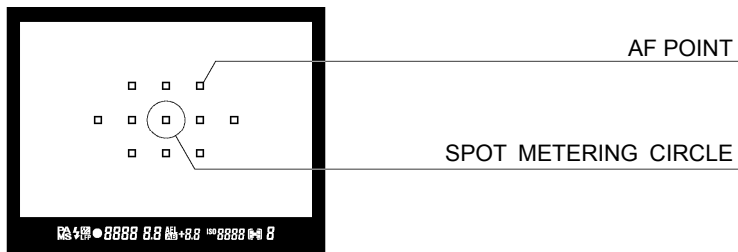

# **BASIC OPERATION AND QUICK REFERENCE**

---

The SD1 camera has many advanced features. This section, describes basic camera operation. You can find more details in later sections.

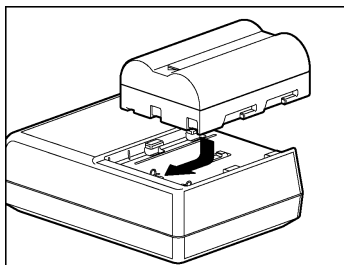

## **Charging the battery (P.19)**

Charge the supplied lithium-ion battery with the provided battery charger.

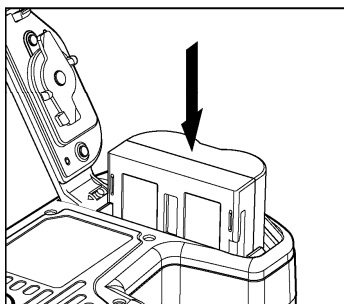

## **To insert the battery (P.20)**

Insert the battery into the chamber in accordance with the diagram.

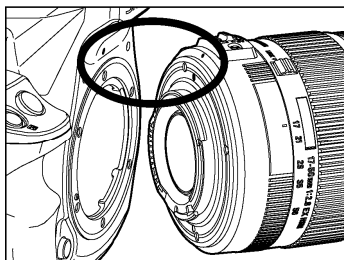

## **Mount the lens (P.24)**

Align the red mark on the camera's lens mount with the red dot on the lens. Insert the lens into the mount of the camera, and rotate the lens clockwise until it clicks into the locked position.

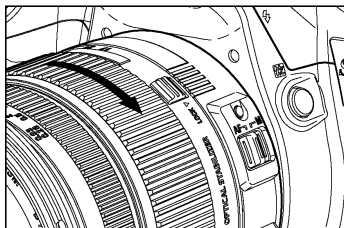





Set the language (P.26)

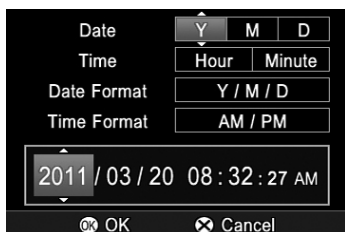

Set the date and time (P.27)

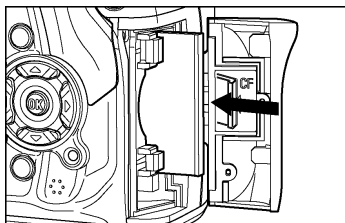

Loading the card (P.39)

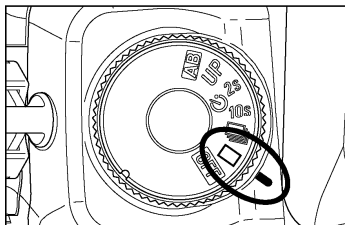

Turn the D-dial to the  (single frame shooting) position. (P.61)

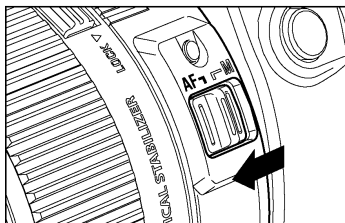

Set the AF/MF switch on the lens to the AF position. (P.55)

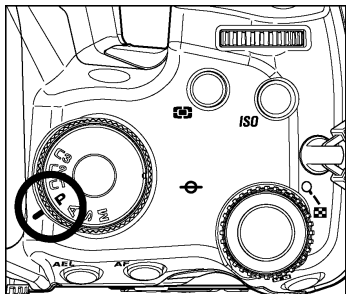

### Select the exposure mode (P.45)

Set the Mode dial to **P** (Program AE) position.



### Focus (P.55)

Determine the composition through the finder, and then press the shutter button halfway to activate exposure metering and autofocus.

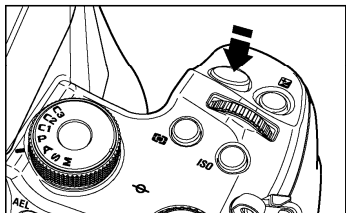
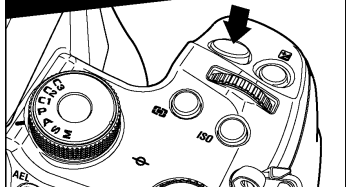

### Take a picture

Press the shutter button “All-the way-down” to take a picture.



### Review the image. (P.86)

The image is displayed for 2 seconds on the color LCD monitor.

# PREPARATION

This section describes necessary preparations before using the camera.

## ATTACHING THE CARRY STRAP

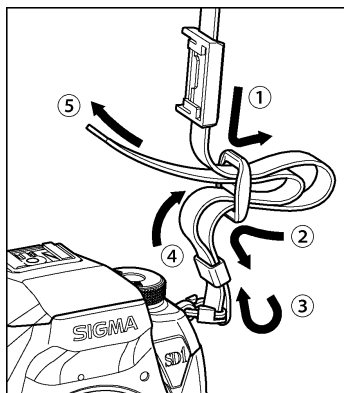

- 1**  
Undo the strap end.
- 2**  
Thread the finder cap onto the strap.
- 3**  
Attach the carry strap as shown.

## HOW TO USE THE FINDER CAP

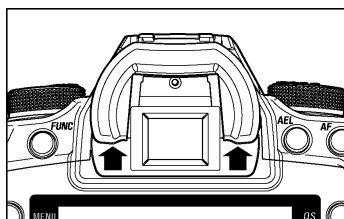

When using the self-timer or remote control, cover the viewfinder eyepiece with the finder cap to prevent stray light from entering the camera.

- 1**  
Remove the eyecup from the viewfinder.

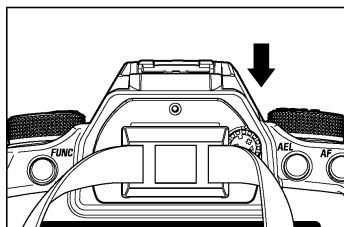

- 2**  
Attach the finder cap onto the viewfinder.

# LOADING THE BATTERY

---

A lithium-ion battery BP-21 is provided with the SD1 camera. Charge the battery fully before using the camera for the first time. Please charge the battery with the supplied battery charger BC-21 no power is left in the battery.

## TO CHARGE THE BATTERY

---

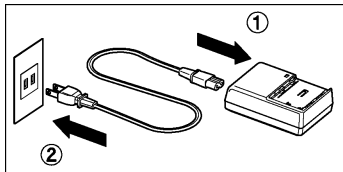

**1**

Connect the power cable to the charger and insert the plug into the wall outlet.

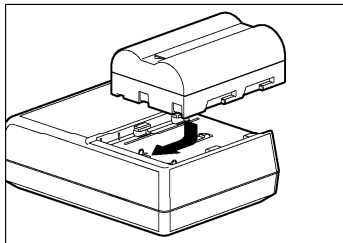

**2**

Attach the battery by sliding it in the direction of the arrow, as shown in the diagram.

- Charge lamp will be on during charging.
- It takes about 150 minutes to recharge the battery.
- Required time for recharging the battery depends on the ambient temperature and status of the recharge level.

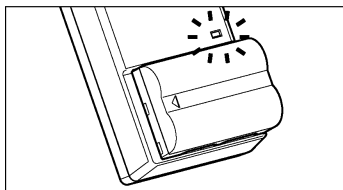

**3**

When the charge lamp goes out, charging is completed. Remove the battery from the charger and remove the power cable plug from the wall outlet.

- We recommend charging the battery before using the camera again. If it is not used for several days, battery performance decreases.
- In the case that the number of possible shots will decrease extremely after charging, it may indicate the end of the battery life. Please purchase a new battery.

## LOADING THE BATTERY

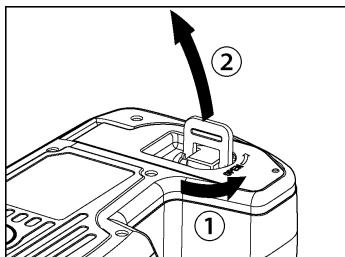

**1**

Confirm that the **D**-dial is in the **OFF** position, and open the battery compartment cover by rotating the battery compartment cover latch, as shown in the illustration.

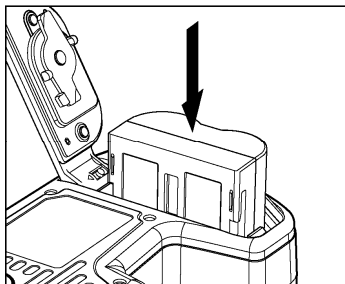

**2**

Insert the battery in accordance with the instruction inside the battery compartment.

- Insert the battery until it locks into place.

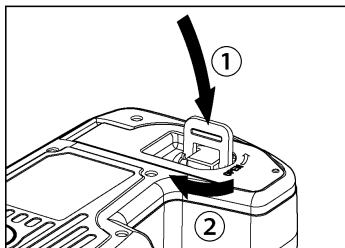

**3**

Close the battery compartment cover and lock the cover by rotating the battery compartment latch, as shown in the illustration.

## TO REMOVE THE BATTERY

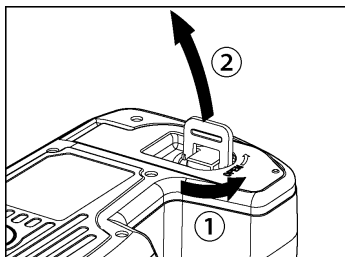

**1**

Turn the **D**-dial to the **OFF** position, and open the battery compartment cover by rotating the battery compartment cover latch, as shown in the illustration.

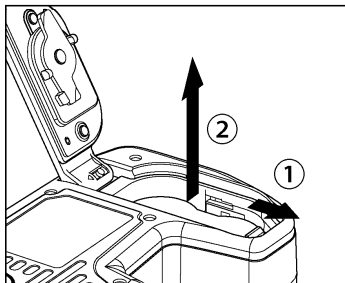

**2**

Eject the battery by sliding the battery compartment cover latch in the direction of the arrow, as shown in the illustration.





### **WARNING!!**

- While the Busy Lamp is on, please do not remove the battery. Doing so can result in data loss. Moreover, the camera and card may be damaged.

## CHECKING THE BATTERY STATUS

---

The battery icon, which shows the capacity of the battery, is shown on the left corner on the color LCD monitor. Explanations of the symbols are given as follows. Please take notice of the battery status before and when in use.

	Battery Status
 White	The battery strength is sufficient.
 White	The battery level is low and the battery will need to be changed soon.
 White	The power of the battery is insufficient, replace the battery immediately.
 Red Blinking	The power of the battery is empty; it is not possible to work. Please replace the battery.
 White	The battery is working with the connected AC adapter.

## CONSERVING BATTERY POWER

---

To conserve the battery, the display in the viewfinder will turn off after approximately 6 seconds of non-operation. When the Function Display (P.35) is displayed in the color LCD monitor, it will not be turned off.) Each button (except the depth-of-field preview button) can be operated normally.

In addition, the camera includes an Auto Power Off and LCD Off feature to conserve battery power. If not used for a predetermined amount of time, the backlight of the color LCD monitor or the camera will be turned off automatically. For further information, please refer to LCD OFF AND AUTO POWER OFF (P.111)

A small amount of power is used even when the color LCD monitor or camera is turned off. The camera may be reactivated or the shutter may be released accidentally. Therefore, if you do not intend to use the camera, please set the D-dial to the **OFF** position.

## USING A HOME POWER SUPPLY (Sold Separately)

You can power the camera from a wall outlet using the provided AC Adapter -(SAC-4). When using your camera for an extended period of time, reviewing the pictures or connecting the camera to a computer or cleaning the image sensor, we recommend that you operate the camera from a household power outlet.

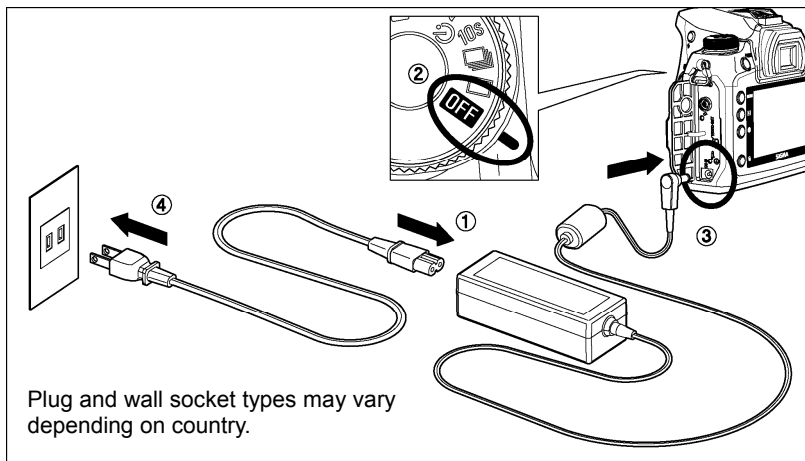

**1**

Connect the AC cable to the AC adapter. ①

**2**

Connect the plug of the AC adapter to the camera. ②, ③

**3**

Insert the plug of the AC cable into a wall outlet. ④

When you have finished using the camera, please disconnect the plug from the wall socket.

When using the SD1 with an AC power supply, the battery icon shows the full symbol, regardless of the power level of the battery. If you start to operate the camera on battery power, the display will change and show the remaining power level of the battery.

### WARNING!!

- While the Busy Lamp is on, do not change the power supply by any means. Doing so can result in data loss or damage to the camera or card.



# MOUNTING AND REMOVING THE LENS

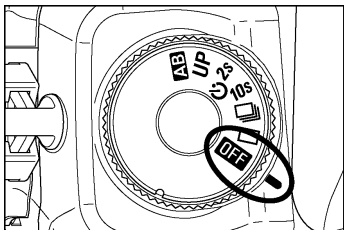

**1**

Make sure the D-dial is set to **OFF** (Power Off position).

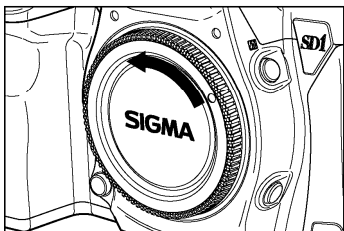

**2**

Remove the camera body cap and the rear cap of the lens'.

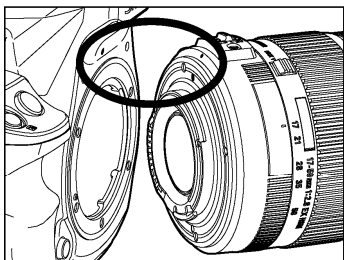

**3**

Align the red mark on the camera's mount with the red dot on the lens. Insert the lens into the mount of the camera and rotate the lens clockwise until it clicks into the locked position.

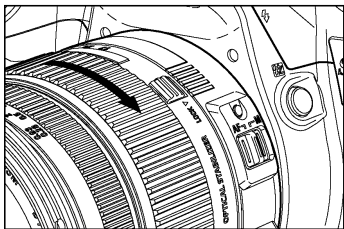

## CAUTION !!

- To ensure a proper connection, do not hold down the lens lock button while mounting the lens.

## CAUTION !!

- The SD1 camera contains a dust protector, located inside the lens mount. The dust protector is a very delicate device. Take care not to scratch its surface. Touching or pushing it with your fingers can easily damage it. If there is dirt or dust on it, please refer to the Maintenance section of your manual (P.116).

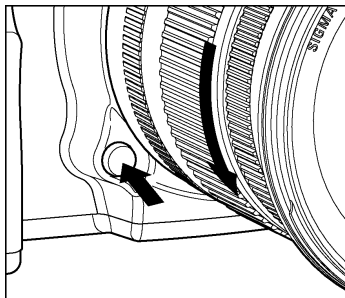

## 4

To remove the lens, press the lens lock button and turn the lens counter-clockwise until it stops. Gently remove the lens from the camera body.

## CAUTION !!

- On the mount surface of the lens, there are a number of electrical contacts. Keep them clean to ensure proper connection. To avoid damaging them, be sure to place the lens on its front end when it is off the camera.

# SETTING THE LANGUAGE

You should receive the SD1 camera pre-set to English, however, if necessary, you can change the camera language yourself.

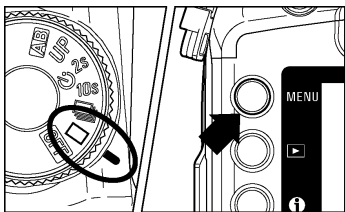

**1**  
Make sure the camera is turned on.

**2**  
Press the **MENU** button on the back of the camera to display the Camera Set-up Menu. (See P.28)

**3**  
Select [**Camera Settings (3)**] by rotating the **S-dial** ( ).

**4**  
Use the **◀▶** buttons or rotate the **A-dial** ( ) to select [**Language/言語**].

**5**  
Press the **OK** or **▶** button to open the language set-up page.

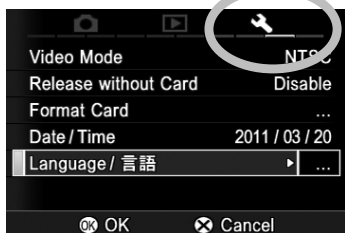

**6**  
Use the **◀▶** buttons to select the desired language.



English	English
日本語	Japanese
Deutsch	German
中文(简体字)	Chinese
Français	French
Español	Spanish
Italiano	Italian
한국어	Korean
Русский	Russian

**7**  
Press the **OK** or **▶** button to apply the setting or the **✕** or **◀** button to close the sub-menu without saving any changes.

# SETTING THE TIME AND DATE

The SD1 camera records the date and time when each image is captured and stores this information with the image. To ensure that the correct information is recorded with each image, set the camera's internal clock to the correct date and time before using the camera for the first time or after extended periods of disuse.

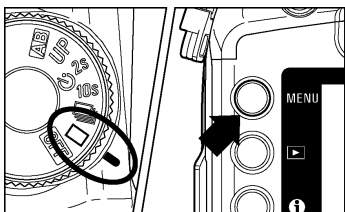

**1**

Make sure the camera is turned on.

**2**

Press the **MENU** button on the back of the camera to display the Camera Set-up Menu. (See P.28)

**3**

Select [**Camera Settings (3)**] by rotating the **S-dial** (⚙️).

**4**

Use the **⬆️** buttons or rotate the **A-dial** (🌄) to select [**Date/Time**].

**5**

Press the **OK** or **▶** button to open the date/time set-up page.

**6**

Use the **⬆️** buttons to select a setting and use the **⬆️** buttons to cycle through the setting options.

**7**

Once all changes have been made, press **OK** to save the settings and return to the main menu.

Press **✖** at any time to close the date/time set-up page without saving any of the changes.

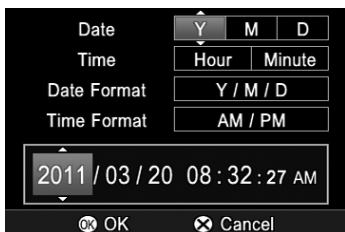
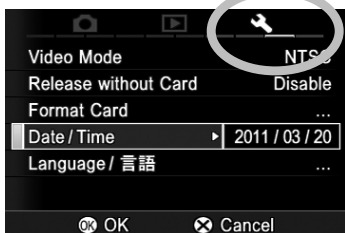

## TIP

- The date can be displayed in one of three formats: **M/D/Y** (month/day/year), **D/M/Y** (day/month/year), or **Y/M/D** (year/month/day). Select the desired format from "**Date Format**".
- The camera's internal clock is powered by a capacitor that receives its charge from the camera's battery. If the camera is left without a battery for an extended period of time, such as after prolonged storage, the internal clock will need to be reset.

# CAMERA SET-UP MENU

This section describes the various settings in the Camera Set-up menu. It is possible to set the camera functions from the Camera Set-up menu display.

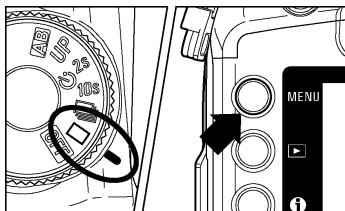

## TO DISPLAY THE SET-UP MENU

Press the **MENU** button on the back of the camera.

- Press the **MENU** button again to close the Set-up Menu and turn off the color LCD monitor. (If you reviewed images, it will return to the last previewed image.)

### Tab area



## Move to any other tab

Each time **S-dial** (⚙️) is rotated, it will move to the next tab. (When the icon in the tab area is selected, it is possible to change the setting menu by pressing the ◀▶ buttons as well.)

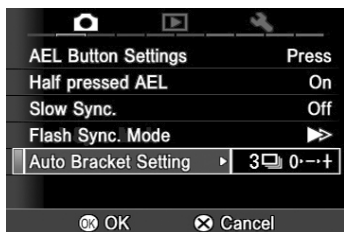

## While in the Set-up Menu:

- Use the ◀▶ buttons or rotate the **A-dial** (⚙️) to select menu items.
- Press the **OK** or ▶ button to open sub-menus or dialogs.

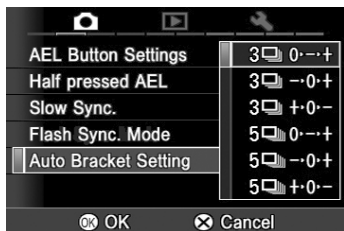

## While in set-up sub-menus:

- Use the ◀▶ buttons or rotate the **A-dial** (⚙️) to select setting options.
- Press the **OK** or ▶ button to apply new settings.
- Press the **X** or ◀ button to close sub-menu without applying changes.

- The Camera Set-up menu is divided into three groups.

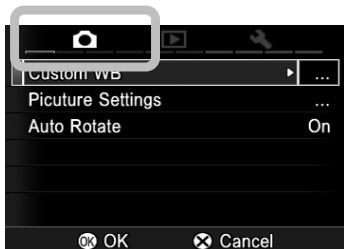

### Capture Settings

This menu relates to shooting settings.

When an exposure mode is selected and the **MENU** button is pressed [  **Capture Settings** ] will be displayed.

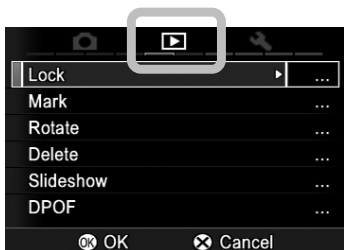

### Playback Menu

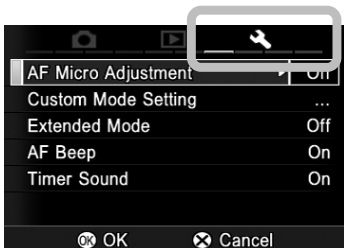

This menu is for setting the playback related functions of the still images. The settings for printing, such as DPOF setting, is included in the Playback Settings menu.

If the **MENU** button is pressed during playback mode, [  **Playback Menu** ] will be displayed.



### Camera Settings

This menu is used for camera setup such as date and language selection.

Open the Camera Set-up menu by pressing the **MENU** button and move to the [  **Camera Settings** ] menu by rotating the **S**-dial (  ).

#### TIP

- Depending on the settings of the camera, some menu items and setting options cannot be selected. They will be displayed with a gray color.

---

## LIST OF MENU FUNCTIONS

---

For more detailed information about each function, please refer to the individual pages.





### Capture Settings

---

	Menu Item	Description	Page
 <b>(1)</b>	<b>Custom WB</b>	Captures the image to be used for the custom white balance setting.	<b>66</b>
	<b>Picture Settings</b>	Sets image parameter and color space.	<b>70</b>
	<b>Auto Rotate</b>	Sets or cancels to record the vertical image information.	<b>84</b>

	Menu Item	Description	Page
 <b>(2)</b>	<b>AEL Button Settings</b>	Sets whether or not AE Lock continues when the <i>AEL</i> button is released.	<b>73</b>
	<b>Half pressed AEL</b>	Sets or cancels the exposure lock when the shutter button is pressed halfway.	<b>73</b>
	<b>Slow Sync.</b>	Sets or cancels slow synchro when using flash.	<b>54</b>
	<b>Flash Sync. Mode</b>	Sets the flash synchronization mode to Front Curtain synchronization or Rear Curtain synchronization.	<b>54</b>
	<b>Auto Bracket Setting</b>	Sets the order and number of Auto Bracket.	<b>76</b>

## Capture Settings

	Menu Item	Description	Page
 <b>(3)</b>	<b>AF Auxiliary Light</b>	Sets whether or not the AF auxiliary light is used in low light conditions.	<b>58</b>
	<b>AF Drive Setting</b>	Sets the functions of buttons related with AF drive.	<b>60</b>
	<b>Switch A/S Dial</b>	Sets whether or not the function of <b>A</b> -dial (  ) and <b>S</b> -dial (  ) is changed when the camera is in Manual Exposure Mode.	<b>110</b>
	<b>Dial Reverse Setting</b>	Sets whether or not to reverse the role of <b>A</b> -dial (  ) and <b>S</b> -dial (  ) to increase or decrease the amount against the rotation direction.	<b>110</b>

	Menu Item	Description	Page
 <b>(4)</b>	<b>UP Setting</b>	Sets the exposure timing of Mirror Lock-up photography	<b>64</b>
	<b>RC Channel</b>	Sets whether or not the Remote Controller (Optional) is used. In addition sets the channel of the Remote Control Mode.	<b>78</b>
	<b>Quick Preview</b>	Sets the duration of the Quick Preview image that is automatically displayed on the color LCD monitor after the image is captured.	<b>86</b>





## ▶ Playback Menu

	Menu Item	Description	Page
▶ <b>(1)</b>	<b>Lock</b>	Lock the image, or unlock the locked image.	<b>98</b>
	<b>Mark</b>	Mark the image, or unmark the marked image.	<b>100</b>
	<b>Rotate</b>	Rotate the image to the desired position for display.	<b>102</b>
	<b>Delete</b>	Delete the image.	<b>96</b>
	<b>Slideshow</b>	Start the slideshow (playback images automatically) or change the slideshow settings.	<b>105</b>
	<b>DPOF</b>	Select the images and set the quantity for printing.	<b>107</b>

	Menu Item	Description	Page
▶ <b>(2)</b>	<b>Exposure Warning</b>	Sets whether or not the over-exposure warning is shown on images.	<b>94</b>
	<b>OK Shortcut</b>	Sets the function that the <b>OK</b> button will perform during image review.	<b>104</b>
	<b>Applied Rotate</b>	Sets whether or not vertically orientated images are automatically rotated and displayed vertically.	<b>—</b>

## Camera Settings

	Menu Item	Description	Page
 <b>(1)</b>	<b>AF Micro Adjustment</b>	Make adjustments to the AF's point of focus.	<b>112</b>
	<b>Custom Mode Setting</b>	Register the setting of Custom Mode (C1 · C2 · C3) .	<b>85</b>
	<b>Extended Mode</b>	Sets whether or not Extended Mode is used in the Bulb setting.	<b>50</b>
	<b>AF Beep</b>	Sets or cancels electronic beeping sound.	<b>56</b>
	<b>Timer sound</b>	Sets or cancels the electric beeping sound for the timer in the self-timer or mirror lock-up.	<b>63,64</b>

	Menu Item	Description	Page
 <b>(2)</b>	<b>Capture Setting Display</b>	Sets whether or not the setting menu is displayed in the color LCD monitor when pressing the Capture Setting Button such as <i>ISO</i> and  .	<b>109</b>
	<b>File Numbering</b>	Sets the file numbering system used when a new card is inserted in the camera.	<b>108</b>
	<b>LCD Brightness</b>	Sets the color LCD monitor brightness. (Images will not be affected by this change.)	—
	<b>LCD Off</b>	Sets the delay before the backlight of the color LCD monitor turns off automatically if no operation has occurred.	<b>111</b>
	<b>Auto Power Off</b>	Sets the delay before the camera shuts down automatically if no operation has occurred.	<b>111</b>

## Camera Settings

	Menu Item	Description	Page
 (3)	Video Mode	Sets the standard to be used for video output when the camera is connected to a television or VCR.	95
	Release Without Card	Sets whether or not it is possible to release the shutter when the card is not inserted into the camera.	44
	Format Card	Formats the card. (Formatting will erase all data on the card.)	41
	Date/Time	Sets the date and time in the camera's internal clock and the format in which the date and time will be displayed.	27
	Language/言語	Sets the language in which menus and messages will be displayed.	26

	Menu Item	Description	Page
 (4)	Firmware Update	Confirm current firmware version and update the latest firmware version from card.	—
	Update Lens Information	Update the lens to the latest information from the card.	112
	Camera Reset	Restores all menu options to their default settings.	114
	Cleaning Mode	For sensor cleaning, the mirror will be raised and the shutter curtain opened.	116

# FUNCTION DISPLAY

It is possible to confirm the settings related with shooting (Aperture value, Shutter Speed, Exposure Mode, Number of shots remaining). In addition, it is possible to change the setting of following function in this display.

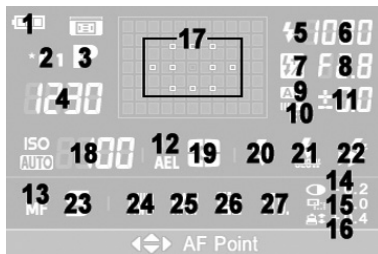

FUNC INFORMATION			
1	Battery Level Indicator	9	Auto Bracket
2	Custom Mode	10	Remote Control Channel
3	Exposure Mode	11	Exposure Meter
4	Frame Number Counter	12	AE Lock
5	Flash Indicator	13	Manual Focus
6	Shutter Speed	14	Contrast
7	Flash Exposure Compensation	15	Sharpness
8	F Number	16	Saturation

FUNC SETTING 1	
17	AF Point (P.57)

FUNC SETTING 2			
18	ISO Sensitivity (P.67)	23	AF Mode (P.56)
19	Metering Mode (P.71)	24	White Balance (P.65)
20	Flash Mode (P.53)	25	Image Quality (P.68)
21	Slow Sync (P.54)	26	Image Size (P.68)
22	Flash Sync. Mode (P.54)	27	Color Mode (P.69)

- For more detailed information about functions of 17-27 set by the **FUNC** button, please refer to the individual pages.

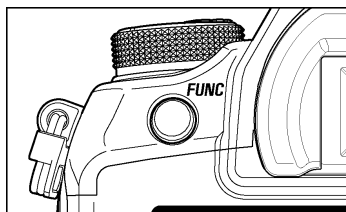

- To show the Function Display, press the **FUNC** button.
- When Function Display is on, the color LCD monitor will be turned off by pressing the **FUNC** button, the **X** button or the shutter button halfway.

Whilst the Function Display is on, it is possible to change the settings of **FUNC SETTING 1** and **FUNC SETTING 2** using the 4-way controller. The FUNC Setting display will be switched by pressing the **OK** button, whilst the FUNC Display is on. (Each time the **OK** button is pressed, **FUNC SETTING 1** and **FUNC SETTING 2** will be switched.)

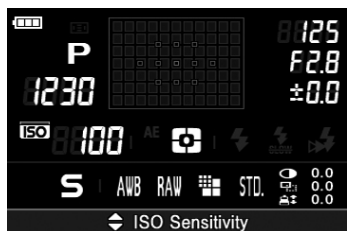

For example, if you wish to change the ISO Setting to 400, press the **FUNC** button to show the Function Display and switch the display to **FUNC SETTING 2** by pressing the **OK** button.



Use the **◀▶** buttons to select ISO Setting and set the value to **400** by pressing the **◆** buttons.

- For setting the AF Point in **FUNC SETTING 1**, please refer to **AF POINT SELECTION (P.57)**.

# QUICK SET MENU

By pressing the **QS** button, it is possible to quickly access and change the settings of the following most commonly used camera functions.

## Qs1 (Quick Set Menu 1)

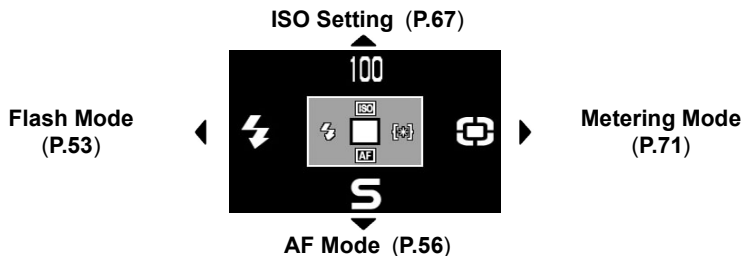

## Qs2 (Quick Set Menu 2)

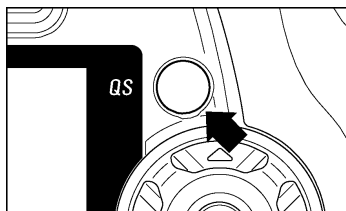
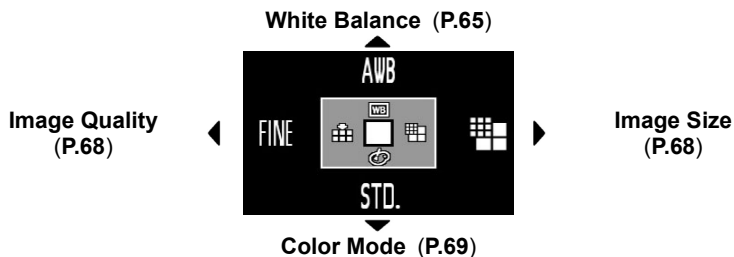

By pressing the **QS** button again, it is possible to switch to **Qs1** or **Qs2**.

Select the desired Menu by pressing the 4-way controller and change the setting.



For example, if you wish to change the ISO Setting to 400, press the **QS** button to display Qs1, then set the value to **400** by pressing the **▲** button several times.

By pressing **OK** or the shutter button halfway, the settings will be applied and the camera will return to shooting mode.



When you select  (Custom) from [White Balance], the current stored setting in [Custom WB] will be used.

It is not possible to capture a new custom white balance from  (Custom) in Quick Set Menu. Please capture a new custom white balance from [Capture Settings] (P.28) → [Custom WB].

## CAMERA INFO PAGE

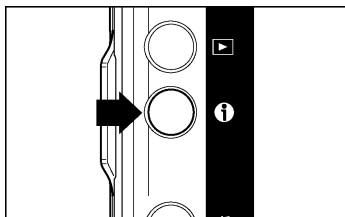
Some information such as camera firmware version and total capacity of the card is displayed in the Camera Info Page.



- By pressing the  button (except when reviewing images), the Camera Info Page is displayed.
- By pressing the  button again, pressing the  button or pressing the shutter button halfway, the color LCD monitor is turned off.

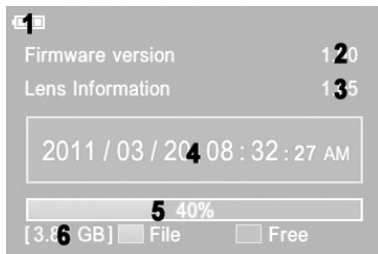
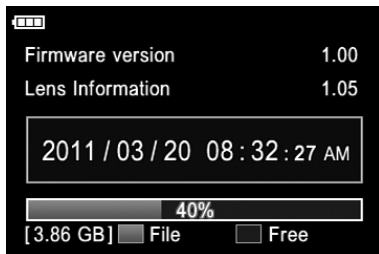

1	Battery Level Indicator
2	Current camera firmware version
3	Current lens information version
4	Date/Time
5	Used capacity
6	Total capacity of the Card

# INSERTING AND REMOVING THE CARD

The SD1 camera uses a CompactFlash™ (CF) card (Type1) to store the data. Type II CompactFlash™ and hard disk type cards cannot be used.

## TO INSERT THE CARD

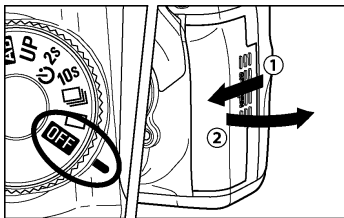

**1**  
Set the **D**-dial to the **OFF** position.

**2**  
Open the CF card cover, as shown in the illustration.

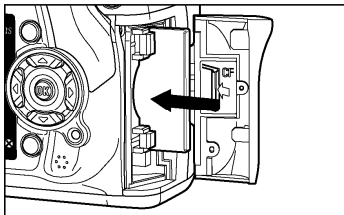

**3**  
Position the CF card with the label facing toward the CF card cover and insert the CF card smoothly, in the direction of the arrow, as far as it can go into the slot.

- The eject button will pop out slightly.

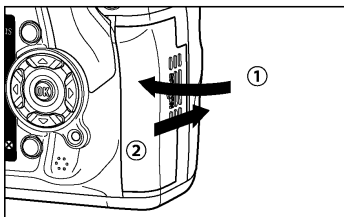

**4**  
Close the CF card cover and slide it in the direction shown by the arrow, until it clicks shut

### TIP

- It may be necessary to format the card before use. (See **P.41**)
- Ultra DMA (UDMA) or high-speed CF cards are recommended.



## TO REMOVE THE CARD

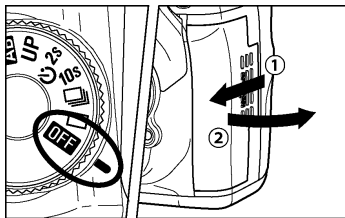

**1**

Set the **D**-dial to the **OFF** position.

• Make sure that the CF card busy light is off, before continuing.

**2**

Slide the CF card cover until it pops open.

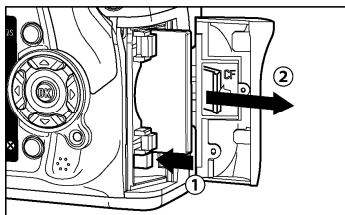

**3**

Press the Eject button to eject the CF card.

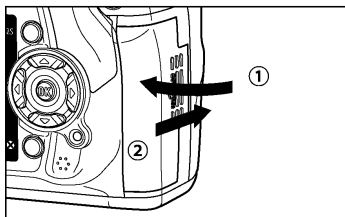

**4**

Close CF card cover and slide it in the direction shown by the arrow until it clicks shut

### CAUTION !!

• Never do any of the following while the Busy Lamp is on. (The Busy Lamp indicates when the camera is writing, reading, or erasing images from the card. Doing any of the following may cause the image data to be lost or damaged.)

1. Do not remove the card.
2. Do not remove the battery.
3. Do not apply shock or vibrations to the camera.

### TIP

• If the camera is turned off while the Busy Lamp is on, the camera will remain on until it has finished accessing the card.

# FORMATTING THE CARD

---

New cards must be formatted before use. In addition, cards with corrupt or incompatible file systems may need to be formatted before use.

## 1

Turn the **D**-dial to the "Drive-Area". Press the **MENU** button and select [**Camera Settings**] (P.28) → [**Format Card**].

## 2

Press the **OK** or **▶** button to open the confirmation dialog.



## 3

Press **OK** to format the card or **X** to close the confirmation dialog without formatting the card.

### CAUTION !!

- Formatting erases all card contents, including locked SD1 files and all non-SD1 files.

### TIP

- Cards formatted in other cameras or devices may not operate correctly in the SD1 camera or may have reduced capacity. To store the maximum number of SD1 files, format the card in the SD1 camera before use.

# FRAME NUMBER COUNTER

---

The number of images that can be recorded on the card is displayed on the viewfinder display and the Function Display.

- The number of images that can be recorded on the card depends on the settings you choose.



**For example**, in the illustration on the left, 32 pictures can be stored on the card. (The number shown in the counter is only an estimate. The actual number of images, which can be recorded, will depend on the subject, shooting conditions and shooting mode.)



Even if it is possible to record more than 9999 images on the card, the maximum number of frames that can be displayed by the counter is **9999**.



If no more space is available to store images on the card, the frame number will be "**0**" and the Shutter Speed display will show "**FULL**" and blink.



If a card is not inserted into the camera, the frame number will be "**0**".



The number on the right end of the viewfinder display is the buffer capacity. It is the maximum number of frames for continuous shooting. (If the maximum number of frames for continuous shooting exceeds 9 frames, the display will not change from 9)



During image processing, the Shutter Speed display will be changed as shown in the illustration and **busy** is displayed.

The shutter will not release when the camera is busy with processing. It is necessary to await the end of the processing before taking a picture.

## DIOPTR ADJUSTMENT

---

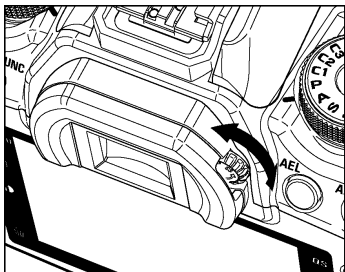

Adjust the viewfinder diopter so that you can see clearly through the viewfinder.

While looking through the viewfinder, rotate the diopter adjuster to the left or to the right, until the image appears sharp on the focus screen.

### TIP

- The camera's adjustable diopter range is  $-3$  to  $+1.5$ dpt.
- If you still cannot see the viewfinder clearly, we suggest that you purchase a viewfinder diopter adjustment eyepiece and use it together with the built-in diopter adjuster.

## HOLDING THE CAMERA

---

To avoid camera shake, which can cause blurring of your photograph, hold the camera steady.

- Firmly grasp the camera's grip with your right hand.
- Hold the camera steady with your left hand and support the bottom of the camera and the lens.
- Place your eye as close to the viewfinder as possible.
- Keep your elbow close to your body and take a half step forward for a more stable stance.

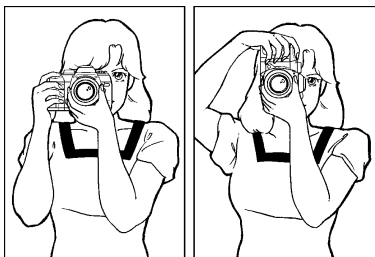

# SHUTTER BUTTON

The shutter button of the SD1 cameras has two positions. When you press the shutter button halfway, the camera's autofocus and Exposure Systems activate. When you press the button "all-the-way down", and the shutter will release to take a picture.

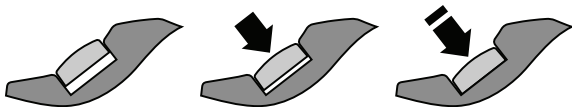

## TIP

- Before you start to take pictures, we recommend that you operate the camera, to become familiar with the halfway position and other features of the camera.
- Normally, if the card is not inserted in to the camera body, it is not possible to release the shutter. If you would like to release the shutter without a card, please set from [ **Camera Settings**] (P.28) → [**Release without Card**].

<b>Disable</b> (Default)	When the card is not inserted in the camera body, it is not possible to release the shutter.
<b>Enable</b>	It is possible to release the shutter, even if the card is not inserted in the camera body.

# BASIC OPERATION

## SELECTING THE EXPOSURE MODE

The features and the operation methods of the four different exposure modes of the camera are explained below.

### P PROGRAM AE

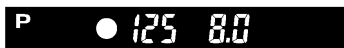
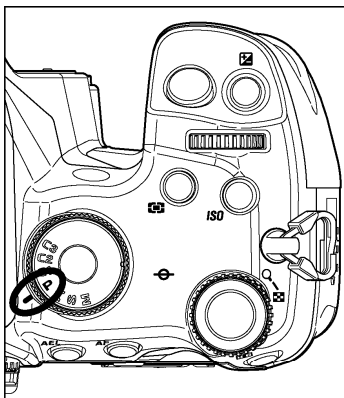

To make picture taking easier, the camera will automatically select an appropriate combination of shutter speed and aperture value, according to the brightness of the subject.

**1**  
Set the **D**-dial to the “Drive Area” (**P.13**).

**2**  
Set the Mode dial to the **P** position.

**3**  
Press the shutter button halfway to verify the focus and exposure display in the viewfinder.



If the subject is too bright or dark, both shutter speed and aperture value indicators will blink and will show the limit values. If you take a picture with these settings, the picture will be overexposed or underexposed.



⚡ When this symbol blinks, the shutter speed may be too slow and the picture may be blurred. In this case, please use a flash (P.51,81) or a tripod to prevent blurring.

---

## PROGRAM SHIFT

---

You can change the combination of shutter speed and aperture value, which were automatically selected by the camera. While turning the **A**-dial (☀️) or **S**-dial (⚙️), the combination of shutter speed and aperture value will change within the range of combinations that give the equivalent exposure.

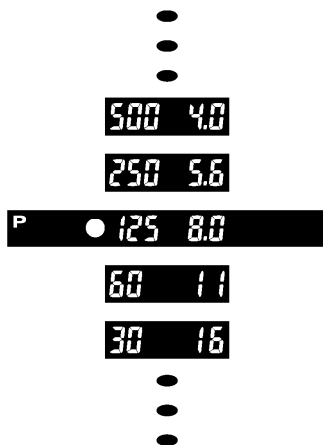
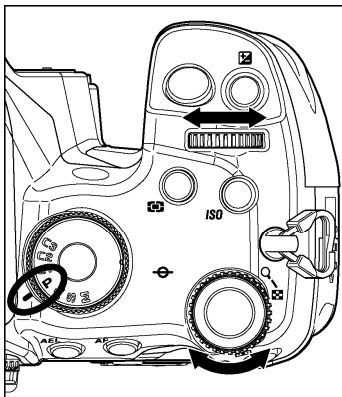

- It will be canceled automatically after taking the picture.

# A APERTURE PRIORITY AE

After you set the aperture value, the camera will determine the appropriate shutter speed. If you select smaller apertures, depth of field will be greater. Larger apertures tend to blur the background, as depth of field will be shallower.

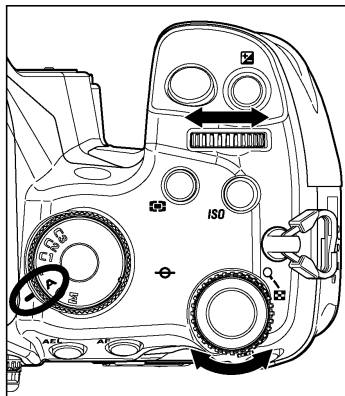

**1**

Set the **D**-dial to "Drive-Area" (P.13).

**2**

Set the Mode dial to the **A** position.

**3**

Press the shutter button halfway to verify focus, and select the desired aperture value by turning the **A**-dial (☀) or **S**-dial (⊙).

**4**

Verify the setting in the viewfinder.



If the appropriate shutter speed is outside the range of suitable combinations due to the subject being too bright or too dark, the shutter speed indicator will blink. If the subject is too bright, set the aperture value to a smaller one (larger F-number). If the subject is too dark, set the aperture value to a larger one (smaller F-number) until the indicator stops blinking.



# S SHUTTER SPEED PRIORITY AE

When you set the desired shutter speed, the camera will select the appropriate aperture value for correct exposure. You can achieve stop action effects by selecting a fast shutter speed, or give the feeling of motion to a moving subject by selecting a slow shutter speed.

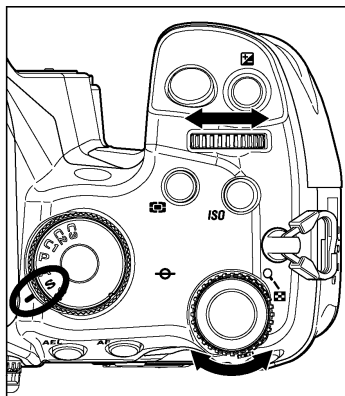

**1**  
Set the D-dial to the “Drive –Area” (P.13).

**2**  
Set the Mode dial to the “S” position.

**3**  
Press the shutter button halfway to verify the focus, and select the desired shutter speed value by turning the A-dial (☀) or S-dial (⚙).

**4**  
Verify the setting in the viewfinder.



If the appropriate aperture value is beyond the range of the lens in use, due to the subject being too bright or too dark, the aperture value indicator will blink. If the subject is too bright, set the shutter speed to a faster one, or if the subject is too dark, set the shutter speed to a slower one, until the indicator stops blinking.

# M MANUAL EXPOSURE

Set both the shutter speed and aperture value according to the indication of the exposure meter. You can change the exposure, as you desire.

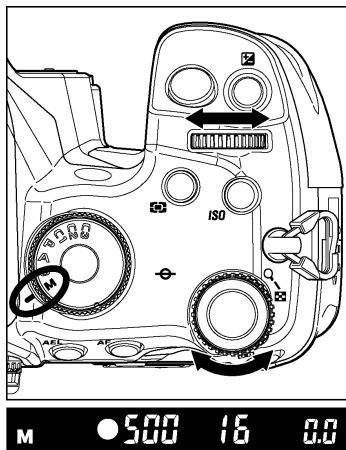

**1**

Set the **D**-dial to the "Drive-Area" (P.13).

**2**

Set the Mode dial to the "**M**" position.

**3**

Press the shutter button halfway to verify the focus, and rotate **S**-dial (☉) to select the desired shutter speed.

**4**

Rotate the **A**-dial (☀) to select the desired aperture value.

**5**

Verify the settings in the viewfinder.

## TO DETERMINE THE EXPOSURE VALUE USING THE CAMERA'S EXPOSURE METER

Set the Mode dial to the **M** position. When you press the shutter button halfway, the shutter speed and aperture value are displayed in the viewfinder, and the display indicates the difference between the manually selected exposure and the metered exposure. Such as

– **1.7** 1 <sup>2</sup>/<sub>3</sub> Step Below (under exposure)

**0.0** Correct Exposure

+ **3.0** 3.0 Over (over exposure)

The exposure meter can display an exposure error of up to ± 3 stops from the correct exposure in 1/3 steps. If the exposure error is more than three stops, the exposure meter will blink.

# BULB SETTING

When long time exposures are required (for shooting night scenes or very dark subjects) the use of the “Bulb” setting is recommended. Please use a tripod, when taking pictures with this setting.

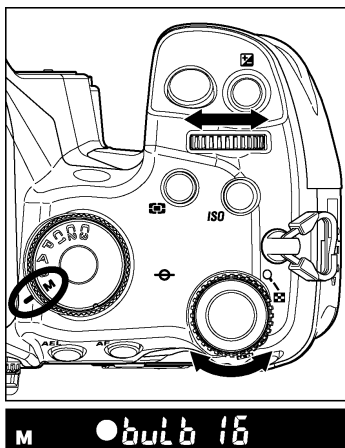

**1**

Set the **D**-dial on the “Drive Area” (P.13).

**2**

Set the Mode dial to the “**M**” position.

**3**

Rotate the **S**-dial (  ) until **bulb** is displayed in the viewfinder display.

**4**

Rotate the **A**-dial (  ) to select the desired aperture value.

**5**

Depress the shutter button fully to take the picture.

## CAUTION !!

- It is not possible to use Bulb photography for more than 30 seconds. The shutter will automatically close about 30 seconds after the shutter button was pressed.
- It is not possible to use the self-timer and Bulb photography at the same time. If you set the **D**-dial to the self-timer with setting Bulb, the shutter will be released with 1/180 second. (1/200 second will be displayed in the image information.)

- It is possible to extend the Bulb time up to 120 seconds by setting the camera to Extended Mode.

Please set from [  **Camera Settings** ] (P.28) → [ **Extended Mode** ] and select [ **On** ].

## CAUTION!!

- When using the extended Bulb time, the image quality may be lowered due to increased noise.

# USING THE BUILT-IN FLASH

The camera has a built-in flash for taking pictures at night or in low light.

## USING THE BUILT-IN FLASH

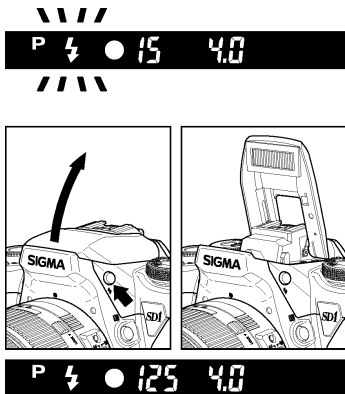

**P** mode, use this mode for automatic photography. The flash sync speed and aperture value are set automatically. If the subject is too dark, the flash indicator "⚡" in viewfinder will blink, then you can take a flash exposure by following.

**1**

Press the ⚡ button to pop up the built-in flash.

**2**

Wait for the ⚡ mark to appear in the viewfinder.

- When the built-in flash pops, it will start charging. While the built-in flash is charging, the ⚡ mark is not visible, but when the flash is sufficiently charged, the indicator in viewfinder will display the ⚡ mark.
- During the charging, the shutter cannot be released.
- After you finish using the built-in flash, close the flash head by pressing the top part of the flash down.
- When you use the built-in flash continuously, the grip of the camera will become warm. This is normal and not a defect.

### CAUTION !!

- The lens hood may intrude into the light path of the built-in flash unit, resulting in a shadow at the bottom of the picture. (The same phenomenon is possible with a lens, which has a large front lens and long length) Either remove the lens hood, or use an external Sigma dedicated flash.

## CAUTION !!

- To prevent overheating and protect the built-in flash unit after using continuous shooting with flash, please do not use your flash for a while.

## EXPOSURE MODE AND BUILT-IN FLASH

---

### **P** mode

Depending on the brightness of the subject and focal length of lens, the most appropriate shutter speed (between 1/30 - 1/180 sec) and aperture value will be selected. In bright situations, the flash will be “daylight synchronization flash”, and the camera will calculate the appropriate flash amount for the correct exposure, of both the subject and background. If the ambient light is too great, resulting in overexposure, the shutter speed and aperture value displays will blink. If the subject is too dark, the camera will proceed to take a flash exposure with the aperture fully open.

### **A** mode

Use this mode if you want to set the desired aperture value. The camera will select the appropriate shutter speed for the background. The shutter speed will operate at 1/180 or slower. In bright situation, the camera will work the same as P mode for daylight synchronization flash and it can obtain a balanced exposure between the subject and background. If the maximum synchronized shutter speed is displayed and is blinking, please set the aperture value to a smaller aperture value (large F-number).

### **S** mode

Use this mode if you want to set a specific shutter speed. The camera will select the appropriate aperture value for the background. The shutter speed will operate between 1/180 or slower. The camera will automatically correct the shutter speed to the highest synchronization speed even if you select a higher shutter speed. If the subject is too bright, the flash will be set to daylight synchronized. Then you can obtain a balanced exposure between subject and background. When the lens smallest aperture (largest F-number) value is blinking, the picture will be over-exposed.

### **M** mode

This mode enables you to set both flash synchronized speed and aperture value. If you set a synchronized speed faster than 1/180, the shutter speed will be set automatically to 1/180. If the exposure meter indicates appropriate number, you will obtain the correct exposure for the subject and background. If the exposure meter indicates minus (under), you will obtain the correct exposure for subject, but the background will be dark. If the exposure meter indicates plus (over), both the subject and the background may be over-exposed.

## CAUTION !!

- When **P** and **A** modes are showing the shutter speed as 1/200sec., the actual shutter speed value is 1/180sec. In the case of **S** and **M** modes, please select 1/200sec., if you wish to set the shutter speed to 1/180sec.



## FLASH FUNCTION SETTINGS

The built-in flash has several functions besides normal flash.

### FLASH MODE

It is possible to select Normal Flash, Red-eye reduction Flash or Wireless TTL Flash Mode.

It is possible to select the Flash Mode from the Quick Set Menu (**P.37**) or the Function Display (**P.35**).

 (Default)	<b>NORMAL FLASH</b> When you pop-up the built-in flash, you can use your camera in this mode. <ul style="list-style-type: none"><li>• Please use this mode for ordinary photography.</li></ul>
	<b>RED-EYE REDUCTION FLASH</b> When you take a picture with flash, sometimes the person's eyes reflect the flashlight and the "red-eye" phenomenon will appear in the picture. In order to avoid this effect, the red-eye reduction lamp lights for approx.1sec before the main flash fires, this reduces the effect of the "red-eye" phenomenon in the picture. <ul style="list-style-type: none"><li>• Depending on the lighting and subject conditions, the Redeye Reduction flash may not completely eliminate the redevye in all cases.</li><li>• When using the optional external flash SIGMA EF DG SUPER series, please set the red-eye reduction on the external flash unit. (It is not possible to use the red-eye reduction flash when the external flash SIGMA EF DG ST series is attached to the camera body.)</li></ul>
 C1~C3	<b>WIRELESS TTL FLASH MODE</b> It is possible to take pictures with Wireless TTL Flash Mode, if you use the optional external flash SIGMA EF DG SUPER series (only this Flash Type is compatible with wireless flash photography). Please refer to the Instruction Manual of the DG SUPER SA-STTL for more details.



---

## SLOW SYNC

---

When using the flash with **P/A** mode, the shutter speed value, which will reduce camera shake, is set automatically. The slow synchro mode changes the shutter speed up to 30 second depending on light condition. This mode is suitable for a portrait in a nightscape.

It is possible to set the slow synchro mode from [ **Capture Settings**] (P.28) → [**Slow Sync.**] or the Function Display (P.35).

<b>Off</b> (Default)		Default setting is applied. ● Please use this mode for ordinary photography.
<b>On</b>		Slow synchro mode is applied.





---

## REAR CURTAIN SYNCHRONIZATION (FLASH SYNC. MODE)

---

When you photograph a moving subject with slow synchronization, usually the furrow of the subject will be exposed in front of the subject. The ordinary flash light will fire when the front shutter curtain is fully opened, thus the subject will be exposed from the time the flash is fired to the time the shutter is closed (Front curtain synchronization). When you use rear curtain synchronization, the flash will fire just before the rear curtain begins to close and the subject will be exposed by ambient light from the time the shutter opens until the flash fires. As a result the furrow of the subject will be recorded behind the subject. This gives a more natural effect.

It is possible to set the rear curtain synchronization from [ **Capture Settings**] (P.28) → [**Flash Sync. Mode**] or the Function Display (P.35).

 (Default)		Default (Front curtain synchronization) mode is applied. ● Please use this mode for ordinary photography.
		Rear curtain synchronization mode is applied.

- When using the optional flash SIGMA EF DG SUPER series, please set this function on the flashgun. (It is not possible to use rear curtain synchronization when the external flash SIGMA EF DG ST series is attached to the camera body.)

# FOCUSING

Adjustment of autofocus and manual focus operation are explained below.

## HOW TO USE AUTOFOCUS

It is possible to use Autofocus function only with AF Lenses. Your camera is equipped with highly precise AF System and incorporates two different autofocus modes. (In the case of Mirror lenses and some specialized lenses, the camera can be use only in Manual Focus mode).

### SETTING THE AUTOFOCUS MODE

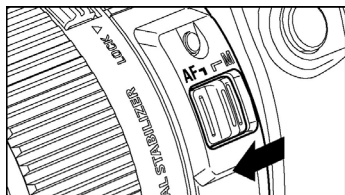

**1**

Set the focus mode switch of the lens, to **AF**.

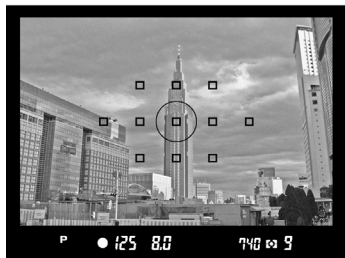

**2**

Decide the composition through the viewfinder and press the shutter button halfway (if the autofocusing is selected, the camera confirms focusing with an electronic sound and a red “in-focus” indicator appears in the viewfinder).

**Although your camera is equipped with highly precise AF system, in some cases autofocus cannot set correctly.**

- Low-contrast subjects, such as blue sky or blank wall, etc. or when the color of the subject is same as background.
- The subject is located in a very low light environment.
- Overlapping near and far objects, such as an animal behind a fence.
- A subject, which moves with a high speed.
- Subjects, which have repeated patterns such as building windows.





In such cases, please use one of the following focusing methods.

1. Use the Focus Lock function to focus on another subject, which has a similar focusing distance as your subject.
2. Set the lens to MF mode and focus manually.

## SELECTING THE AUTOFOCUS MODE

It is possible to set the Autofocus mode from the Quick Set Menu (P.37) or the Function Display (P.35).

 (Default)	<p><b>SINGLE AF MODE</b></p> <p>Depress and hold the shutter button halfway to activate the autofocus function. In order to avoid out of focus exposures, the shutter cannot be released until the subject is in focus. This is called “focus priority”. The Focus Indicator lights up in the viewfinder, when the AF Point Selection is focused on the subject and the focus is locked. Press the shutter button the rest of the way to take the picture. If the camera cannot focus on the subject properly, remove your finger from the shutter button and press again.</p> <ul style="list-style-type: none"><li>● Focus indicator will blink, if the subject is out of focus.</li><li>● Use your camera in this mode for regular photography</li><li>● It is possible to turn the electronic sound off. Please set [ <b>Camera Settings</b>] (P.28) → [<b>AF Beep</b>] → [<b>Off</b>].</li></ul>
	<p><b>CONTINUOUS AF MODE</b></p> <p>Press the shutter button halfway to activate the autofocus function. If the subject is in motion, the camera will focus continuously with motion prediction function. You can release the shutter any time, even if the subject is not precisely in focus. However, depending on the subject situation, (i.e. speed and direction of moving subject, the lens and shutter speed etc.) there is a possibility that the picture may be out of focus.</p> <ul style="list-style-type: none"><li>● Focus indicator will not appear.</li><li>● Autofocus lock does not work.</li><li>● Depending on some unusual conditions of the subject, sometimes autofocus is not possible.</li><li>● When the Automatic Selection mode of the AF Point Selection is selected, the camera automatically selects the initial focus point for tracking the subject.</li></ul>

# AF POINT SELECTION

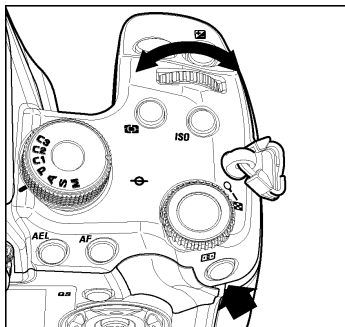

The SD1 is equipped with 11 focusing points. Selecting the AF point can be done automatically or manually by the photographer.

Press **[AF]** button and select the desired AF point by rotating the **A-dial** (🔆) displayed in the viewfinder.

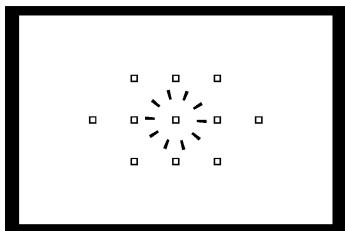

- The Selected AF point will be illuminated in red in the viewfinder.
- Automatic AF point selection can be achieved when all focusing points in the viewfinder are illuminated in red.

● When you rotate the **A-dial** (🔆) clockwise, the selection will occur in the looping sequence that follows.

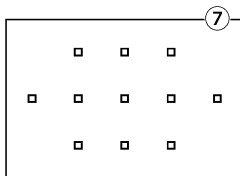
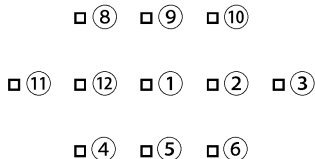

Automatic AF Selection mode  
(All AF points will be illuminated.)

AF points can be selected in the Function Display as well (**P.35**). By pressing the **FUNC** button, the Function Display will be displayed. Select the desired AF point by using the **◀▶** buttons.

- It is possible to move the AF area to up or down direction by using the **⬆** buttons and move to right or left direction by using the **⬅** buttons.
- If you press the same direction on the 4-way controller several times, it will change to Automatic AF Selection mode. After that, if you press any button of the 4-way controller, it will return to Manual AF Selection mode.

## AF AUXILIARY LIGHT

---

---

The built-in AF auxiliary light of the SD1 enables focusing in low light conditions.

- The AF auxiliary light can be used with **S** (Single AF mode) and automatic or center focus AF point selection only.
- The AF auxiliary light is effective with the center focus of the automatic AF selection only.
- The effective distance of the AF auxiliary light is 3m.

### CAUTION!!

- The lens hood must be removed when the AF auxiliary light is used. The AF Auxiliary Light may not work correctly if long and large diameter lenses are attached to the camera as they may interfere with the beam.
  - If the AF auxiliary light is continuously used, it may turn off temporarily in order to protect the lamp. The AF auxiliary light can be used again after a short pause.
  - Do not use the AF auxiliary light for other purposes (lighting etc.) as continuous use of the AF auxiliary light will cause damage .
- 
- The AF auxiliary light can be turned off. Please set [ Capture Settings] (P.28) → [AF Auxiliary Light] → [Off].

## FOCUS LOCK

---

---

This photography method is useful if a photographic subject is not positioned within the central AF frame.

### 1

Choose the AF point according to the "AF POINT SELECTION" instructions on page 57.

### 2

Position the photographic subject into the selected AF frame, and focus by pressing the shutter button halfway.

### 3

Keep the shutter button depressed halfway while you compose the picture as desired. Then press the shutter button the rest of the way to take picture.



- Focus Lock with the shutter button can be used with **S** (single AF mode) only. The AF cannot be locked in **C** (continuous AF mode).
- Focus Lock can be done by pressing the AF button. After focusing, keep the AF button fully depressed. (For more detailed information, please refer to **P.60** “AF Drive and AF Button Setting”.)
- AF Focus Lock with the AF button can be used in **C** (continuous AF mode) as well.

## MANUAL FOCUS

---

In situations, where autofocus or focus lock is not effective, you can focus manually.

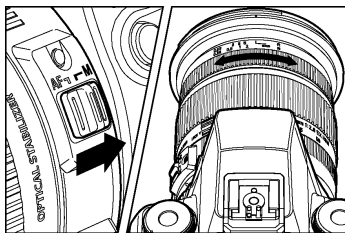

### 1

Set the focus mode switch, on the lens to the **M** position. (“MF” will be displayed in the Function Display.)

### 2









While looking through the viewfinder, turn the focusing ring on the lens until you get a clear sharp image.

- When you use a lens, which has maximum aperture value of F6.3 or faster, the focus indicator in the viewfinder will appear, when correct focus is attained.

# AF DRIVE AND AF BUTTON SETTINGS

The SD1 is equipped with the **AF** button. It is possible to allocate the function of AF Lock or AF drive to the **AF** button.

Please set from [ Capture Settings] (P.28) → [AF Drive Setting].

<p> <b>Off /</b>  <b>AF-On</b></p>	<p>If you would not like to allocate any function to the <b>AF</b> button, please select this mode.</p> <ul style="list-style-type: none"><li>● Auto Focus will work by pressing the shutter button halfway.</li><li>● The <b>AF</b> button will not be functional.</li></ul>
<p> <b>AFL /</b>  <b>AF-On</b>  (Default)</p>	<p>Please use this mode for ordinary photography.</p> <ul style="list-style-type: none"><li>● Auto Focus will work by pressing the shutter button halfway.</li><li>● The <b>AF</b> button is allocated the function of Focus Lock.</li><li>● After focusing by pressing the shutter button halfway, the focusing point will be locked when you keep the <b>AF</b> button fully depressed.</li><li>● Whilst keeping the <b>AF</b> button fully depressed, Auto Focus will not work even if you press the shutter button halfway.</li></ul>
<p> <b>AF-On /</b>  <b>Off</b></p>	<p>This mode separates the driving of auto focus from the shutter button.</p> <ul style="list-style-type: none"><li>● Auto Focus will work by pressing the <b>AF</b> button. Even if you press the shutter button halfway, Auto Focus will not work.</li><li>● When the AF mode is set to  (Single AF mode), after focusing the Focus Indicator will remain indicating even if you remove your finger from the <b>AF</b> button. It is only possible to release the shutter when the Focus Indicator is indicated in the viewfinder display. (The focus indicator will keep indicating until you operate one of the following. "Press the button again", "Turn the camera off" or "Switch the Focus Mode switch on the lens body to "M".)</li><li>● When the AF mode is set to  (Continuous AF mode), Auto Focus will work whilst keeping the <b>AF</b> button fully depressed. The shutter can be released only when the <b>AF</b> button is kept pressed.</li></ul>

# OPERATION OF THE DRIVE MODE

Operation of the self-timer, and other functions of the camera are explained by the following:

## DRIVE-AREA

Some of the important operations and settings of the camera can be activated by the drive area of the **D**-dial. Such as single frame shooting, continuous shooting, self-timer, and mirror lock-up.

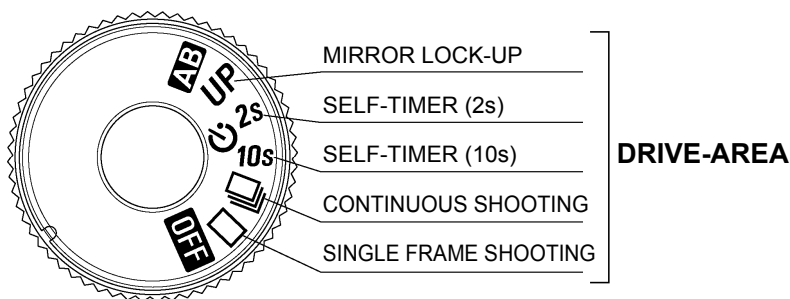



## □ SINGLE FRAME SHOOTING

When you press the shutter button in the single frame-shooting mode, only one frame will be exposed. Then the camera will be ready for the next shot by advancing one frame. Single frame shooting mode is recommended for ordinary photography.

## CONTINUOUS SHOOTING



In this mode, when you keep the shutter button fully depressed, the camera will take pictures continuously. At the time of continuous shooting the number of frames per sec. is given below.

The maximum number of frames and speed of continuous shooting are as follows:

		Image Size (Resolution mode)		
		 (HI)	 (MED)	 (LOW)
Image Quality	JPEG	7	14	14
		5.0	6.0	6.0
	RAW	7	14	14
		5.0	6.0	6.0
	RAW+JPEG	7	14	14
		5.0	6.0	6.0

The upper rows show the maximum number of frames, the lower rows show the maximum shooting speed in continuous mode (frames per second).

### CAUTION !!

- When AF mode is set to AF  (Single AF mode) mode and the focus indicator in the viewfinder is on, focus distance and exposure value are fixed at the setting for the first picture. It is possible that focus and exposure could be incorrect, if subject moves or the brightness changes. When AF mode is set to AF  mode (Continuous AF mode), then camera will focus on the subject continuously. However, depending on the subject situation, since the shutter release has the first priority there is a possibility that the picture may be out of focus.
- When you use the continuous shooting mode with external flash, the camera may be slow, because the camera will not take pictures, while the flash is re-charging.
- Images taken in rapid succession, such as during Continuous shooting, are initially stored in the camera's internal memory buffer. This allows you to continue shooting without having to wait for images to be recorded to the card. Once the memory buffer is full, the shutter will be disabled until some images have been transferred to the card.

## SELF TIMER

---

When you want to include yourself in the picture or avoid camera shake, please use the self-timer.

When you set the self-timer to **10s**, then the shutter will be released 10seconds after you fully press the shutter button.

When you set the self-timer to **2s**, then the shutter will be released 2seconds after you fully press the shutter button.

After composing the picture, press the shutter button halfway and adjust the focusing. Then, press the shutter button the rest of the way and the self-timer will activate.

- If [Timer sound] in [ **Camera Settings**] (P.28) is set to [On], an electric beep will sound during the self-timer operation. If you would like to cancel electronic the beeping sound, please set it to [Off].
- If you want to cancel the self-timer operation, turn the **D**-dial to another position.
- When you start the self-timer and do not look through the viewfinder, attach the finder cap to the viewfinder eyepiece to prevent light entering (P.18).

## UP MIRROR LOCK-UP

---

If you want to reduce the camera's vibration such as during Macro Photography or when using long telephoto lenses, use the Mirror Lock-up function.

### 1

Set the **D**-dial to the "UP" position. When you press the shutter button halfway the camera will set the focus and exposure. As you press the shutter button further, the mirror will move up and the exposure value will be memorized.

### 2

Remove your finger from the shutter button and then press it halfway to release the shutter.

Mirror lock-up function can be cancelled manually by turning the **D**-dial away from the "UP" position.



- It is possible to change the exposure timing of mirror lock-up photography. Please set from [ **Capture Settings**] (P.28) → [**UP setting**].

<b>Shutter button</b> (Default)	After the mirror is raised, exposure will be measured by pressing the shutter button halfway.
<b>after 2 sec</b>	Exposure will be measured 2 seconds after the mirror is raised.
<b>after 10 sec</b>	Exposure will be measured 10 seconds after the mirror is raised.

- When [**after 2 sec**] or [**after 10 sec**] is set and [**Timer sound**] in [ **Camera Settings**] (P.28) is set to [**On**], an electric beep will sound during the self-timer operation. If you would like to cancel the electronic beeping sound, please set it to [**Off**].

### CAUTION !!

- Mirror lock up will cancel automatically, and mirror will return to its original position, after 30 seconds. You can reactivate the mirror lock-up function by pressing the shutter button halfway again.

### WARNING !!

- If you are using this function in a strong light source, the shutter curtain may become particularly hot by light entering through the lens. It could cause damage or fire. Please refrain from using the mirror lock-up function in such an environment.

### TIP

- It is possible to use Mirror Lock-up with remote control (Sold Separately). Please refer to page **78-80**.







# ADVANCED OPERATION

This section explains the application of the more advanced functions of your camera, when composing the expressions of your picture.

## SETTING THE WHITE BALANCE (WB)

The color of light reflected by an object can vary depending on the color of the light source illuminating it. For example, a neutral colored object will reflect reddish light under incandescent lighting, and greenish light under fluorescent lighting. The human brain is able to compensate for differences in the color of a light source, allowing us to see white objects as white independent of the lighting condition. Film cameras rely on special color-correcting filters and film types to adjust for these differences in lighting. Digital cameras, however, are able to use software to mimic the adjustments made by the brain, so that colors that appear white to the human eye also appear white in your photographs.

### WHITE BALANCE OPTIONS

	OPTION	COLOR TEMP.	DESCRIPTION
<b>AWB</b>	<b>Auto</b> (Default)	—	Select this setting to allow the camera to automatically determine the appropriate white balance adjustments.
	<b>Daylight</b>	Approx. 5400 K	Select this setting when taking pictures in full sunlight.
	<b>Shade</b>	Approx. 8000 K	Select this setting when taking pictures in the shade under sunny skies.
	<b>Overcast</b>	Approx. 6500 K	Select this setting when taking pictures under cloudy, overcast skies.
	<b>Incandescent</b>	Approx. 3000 K	Select this setting when taking pictures indoors under incandescent (tungsten) lighting.
	<b>Fluorescent</b>	Approx. 4100 K	Select this setting when taking pictures indoors under fluorescent lighting.
	<b>Flash</b>	Approx. 7000 K	Select this setting when taking pictures with the Sigma EF-610/530/500 DG flash.
	<b>Custom</b>	—	Select this setting when using a custom white balance. Use the <b>[Custom WB]</b> menu option to create a custom white balance setting. The "Custom" option will not be available if no custom white balance has been set.

It is possible to select the white balance options from the Quick Set Menu (P.37) or the Function Display (P.35).

- If Custom White Balance (☑) is selected, the white balance data which you captured from [Custom WB] in [📷 Capture Settings] (P.28) last time will be applied.

---

## SETTING A CUSTOM WHITE BALANCE

---

For more precise control of the white balance setting or when photographing under unusual lighting conditions, the [Custom WB] option can be used to capture a sample of neutral object in a scene to be used for color correction.

**1**

[📷 Capture Settings] (P.28) → [Custom WB] → Open the confirmation dialog.

**2**

Under the lighting conditions that will be used for the final photograph, frame a white or neutral color object, such as a sheet of white paper or a white wall, so that it fills the area inside the viewfinder highlighted with gray color in the illustration.

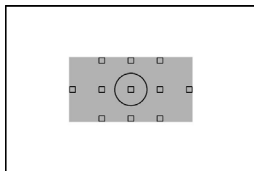

**3**

Press the shutter button to release the shutter and capture a custom white balance setting.

**4**

If a valid white balance setting was captured, a message will appear indicating that the white balance image was captured successfully. If the capture was not successful, "Failed!" will be displayed on the color LCD monitor. Repeat steps **2** and **3** to capture a valid white balance setting or press **X** to dismiss the dialog.

### CAUTION !!

- When a custom white balance setting is successfully captured, "Custom" will automatically become the selected item in the White Balance menu.
- It is recommended that an automatic exposure mode such as **P**, **A**, or **S** be used when capturing a custom white balance setting to ensure proper exposure.
- It may be necessary to set the lens to manual focus (P.59) when capturing a custom white balance setting since auto focus may not work properly when photographing low contrast subjects.

## SETTING THE SENSITIVITY (ISO EQUIVALENCY)

The photosensitivity of digital cameras is described in terms of “ISO equivalent” like silver-halide film cameras. (ISO sensitivity **P.120**)

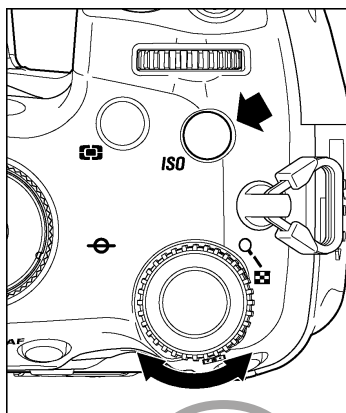

While pressing the **ISO** button, rotate **S**-dial (  ) to set the desired ISO sensitivity.

● It is possible to select the ISO sensitivity from following.

**Auto** (Auto), **100**, **200**, **400**, **800**, **1600**, **3200**, **6400**

● ISO sensitivity is set from the Quick Set Menu (**P.37**) or the Function Display (**P.35**).

### TIP



● If [**ISO Auto**] is selected, the ISO value will automatically change to ISO 100, 200, 400 or 800 depending on the light condition.

### CAUTION !!

● When Exposure Mode is set to **M** mode, it is not possible to select “**Auto**”. When **AUTO** is selected in **S**, **A**, **P** mode and then change to **M** mode, ISO100 will be applied.

# IMAGE FILE SETTING

The file size changes depending on resolution mode and recording quality selected.

		Image Size (Resolution mode)		
		 (HI) 4704×3136	 (MED) 3264×2176	 (LOW) 2336×1568
Image Quality	RAW (RAW)	45 MB	24 MB	12 MB
	FINE (JPEG)	10 MB	5 MB	2.5 MB
	NORM (JPEG)	5.6 MB	2.7 MB	1.4 MB
	BASIC (JPEG)	4.2 MB	2 MB	1 MB

\* The file sizes change depending on subjects.

## Image Quality

It is possible to record images in the widely used JPEG or RAW formats.

The RAW images are recorded without digital processing in the camera body and require post-processing with the supplied software, which can convert RAW images to JPEG or TIFF format.

# IMAGE SIZE SETTING

Image Size Setting is set from the Quick Set Menu (P.37) or the Function Display (P.35).

 (HI) (Default)	 (MED)	 (LOW)
--------------------------------------------------------------------------------------------------	-----------------------------------------------------------------------------------------	-----------------------------------------------------------------------------------------

# IMAGE QUALITY SETTING

Image Quality Setting is set from the Quick Set Menu (P.37) or the Function Display (P.35).

<b>FINE</b> (JPEG) (Default)	<b>NORM</b> (NORMAL)(JPEG)
<b>BASIC</b> (JPEG)	<b>RAW</b> (RAW)
<b>RAW+JPG</b> (RAW+FINE)(JPEG) simultaneous)	







## TIP

- When **RAW+JPG** is selected, the Image Quality of JPEG will be **FINE**.
- When **RAW+JPG** is selected, the selected Image Size will be applied to both the RAW and JPEG files.

## COLOR MODE

It is possible to select the desired Color Mode depending on the shooting conditions. In addition to the above settings, it is also possible to select Sepia and Monochrome (B&W) photography modes.

Color Mode is set from the Quick Set Menu (P.37) or the Function Display (P.35).

 <b>STD.</b> <b>Standard</b> (Default)	Standard color mode for various situations.
 <b>VIVID</b> <b>Vivid</b>	Saturation and contrast are enhanced for making pictures appear vivid.
 <b>NTR.</b> <b>Neutral</b>	Subdued saturation and contrast makes images natural.
 <b>Portrait</b>	This color mode makes skin tone soft. It is ideal for portraits.
 <b>Landscape</b>	This mode makes blue and green more vivid and emphasizes pictures.
 <b>B/W</b> <b>B&amp;W</b>	It is possible to take Monochrome pictures.
 <b>SEPIA</b> <b>Sepia</b>	It is possible to take Sepia and monotonous pictures.

## CAUTION !!

- It is possible to select the Color Mode to **B&W** or **Sepia**, only when the Image Quality is set to JPEG (**FINE**, **NORM**, **BASIC**).
- When the Color Mode is set to B&W or Sepia and Image Quality is changed to **RAW** or **RAW+JPG**, the Color Mode will be automatically changed to **STD.**(Standard).

## TIP

- It is possible to make pictures according to your intention by the combination of Color Mode and Picture Settings. For example, when Color Mode is set to Vivid and the cursor of Saturation in Picture Settings is set to + side, pictures will be made more vivid.

## IMAGE PARAMETER AND COLOR SPACE

It is possible to adjust the recording image parameter (contrast, sharpness and saturation) and select the color space.

### 1 Contrast

Contrast can be increased by moving the cursor to + side or decreased, preserving image detail, by moving the cursor - side.

### 2 Sharpness

It is possible to make the pictures appear sharper, by moving the cursor to + side, or softer by moving the cursor to - side,.

### 3 Saturation

It is possible to increase saturation thus making pictures appear vivid, if the cursor is moved to + side. Moving the cursor to - side, decreases saturation and makes images less vivid.

### Color Space

It is possible to select sRGB, which is a common color space or Adobe RGB, which is mainly used for commercial printing, and other industrial purposes.

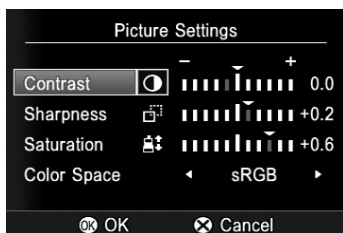

### 1

[ Capture Settings] (P.28) → [Picture Settings] → Open Picture Settings display.

### 2

Use the buttons to select the desired parameter from the sub-menu.

### 3

Use the buttons to select the desired value. (In the case of the color space, use the buttons to select sRGB or Adobe RGB).

### 4



Press the button to confirm the setting.

- JPEG is compressed after parameter adjustment. In the case of RAW format, parameter information is recorded without adjustment. It is possible to re-adjust RAW images using the supplied **Sigma Photo Pro** software.
- Please set color space to sRGB for regular usage. If you select Adobe RGB, please be sure to use the supplied Sigma Photo Pro software or another image processing software supporting DCF 2.0.
- When images taken with Adobe RGB are reviewed, their Folder numbering / File numbering will be underlined.

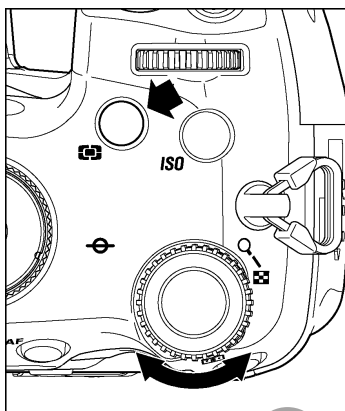
## SELECTING THE METERING MODE



The camera has 4 advanced metering modes.

While pressing the  button, rotate the S-dial () to select the desired metering mode.

- Metering mode is set from the Quick Set Menu (P.37) or the Function Display (P.35)

### EVALUATIVE METERING

The camera measures the brightness of the scene by independently measuring each segment of the focusing screen and analyzing the correct exposure for the main subject under any lighting situation.

Even under strong back lighting or complex lighting situations, the camera will give you the correct exposure.

### [ ] CENTER-WEIGHTED AVERAGE METERING

The camera will measure the average brightness of the entire scene with additional emphasis on the center area. It will determine the most suitable exposure with respect to lighting conditions.

### [■] CENTER AREA METERING

The camera will measure the brightness of the center of the frame (The area with gray color in the illustration) only. This mode is suitable when you wish to set exposure for a portion of the scene and ignore the influence of rest of the scene.

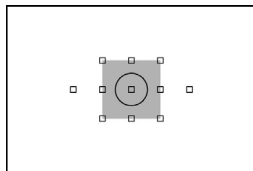



## [•] SPOT METERING

The camera will measure the brightness of only the Spot Metering Circle.

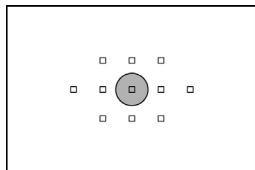

## AE LOCK

The camera will fix and memorize the exposure value whilst the “AE” Lock button is depressed. When you wish to lock the exposure of a subject off-center, AE lock is very useful. Use of this function with Spot Metering Mode is recommended.

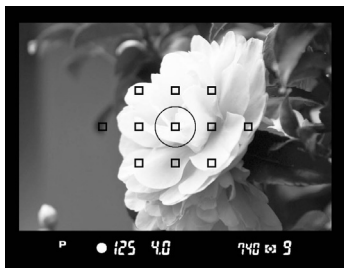

**1**

Center the subject inside the viewfinder, then press the shutter button halfway.

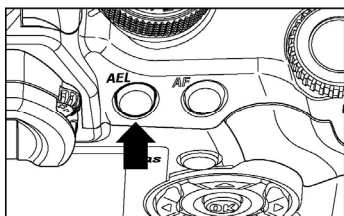

**2**

Keep shutter button halfway depressed, and then push the **AEL** button. (While operating the AE lock, the displays of the shutter speed and aperture value in the viewfinder are locked and “**AEL**” is visible). You can release the shutter button.

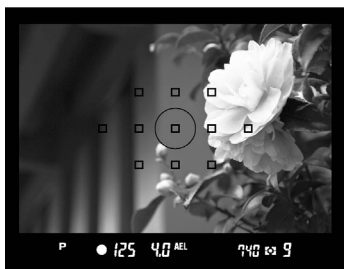

**3**

Hold the **AEL** button while you compose the picture. Then press the shutter button to take the picture.

- When the subject is out of focus during AE lock operation, remove your finger from shutter button and press the shutter button halfway again, or remove your finger from the AE lock button and restart from the beginning.
- It is possible to continue AE Lock even if the finger is released from the **AEL** button. Please set from [ **Capture Settings**] (P.28) → [**AEL Button Settings**].

<b>Continuous</b>	AE Lock will continue until the <b>AEL</b> button is pressed again or the camera is turned off.
<b>Press</b> (Default)	AEL will be dismissed upon releasing the finger from the <b>AEL</b> button. AE Lock will continue while pressing the <b>AEL</b> button.

---

## HALF PRESSED AEL



---

It is possible to set the exposure lock when the shutter button is pressed halfway or cancel the exposure lock.

Please set from [ **Capture Settings**] (P.28) → [**Half Pressed AEL**].

<b>Off</b>	The exposure will not be locked while pressing the shutter button halfway. The exposure will be determined when depressing the shutter button.
<b>On</b> (Default)	The exposure will be locked when the shutter button is pressed halfway. While pressing the shutter button is halfway, the exposure will not change.



### CAUTION !!

- Only when the AF mode is set to , [**Half Pressed AEL**] will function. When the AF Mode is set to  or the camera is in Manual Focus mode, it is not possible to lock the exposure by pressing the shutter button halfway even if [**Half Pressed AEL**] is set to **ON**.

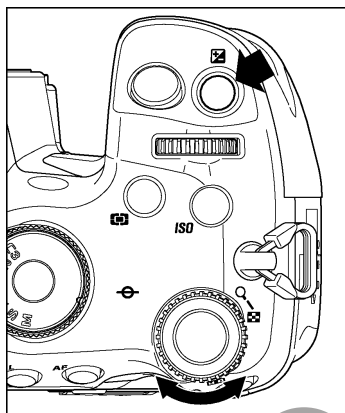
# EXPOSURE COMPENSATION



If you want to intentionally overexpose or underexpose the picture, use this function.

While pressing  button, turn the **S**-dial () to set the desired compensation value. Then, release the Exposure Compensation button.

- “0.0” will be shown in the color LCD monitor and viewfinder display when you initially press the exposure compensation button. The “+” indicates overexposure, and “-” indicates underexposure.



- Exposure compensation can be set in 1/3EV increments from +3.0 to -3.0 stops.
- For example, if you set +1.0 then the shutter speed will be one stop slower in Aperture Priority mode. In Shutter Speed Priority mode, the aperture value will be one-stop larger (smaller F-number). In the case of Program mode, it will be adjusted by the shutter speed and the aperture value.
- After setting the exposure compensation, the compensated amount will be displayed with blinking on the viewfinder display.

## CAUTION !!

- Once you set the Exposure Compensation, the camera will continuously hold this mode, until the compensation amount is set to 0.0 value.
- Exposure compensation function cannot be used with Manual Operation mode.



## TIP

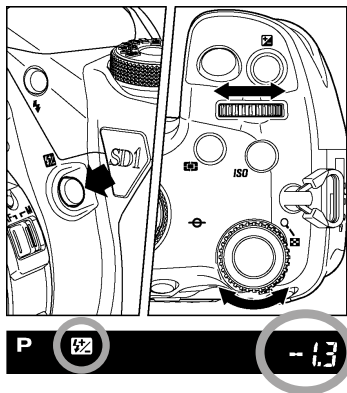

- During flash photography, if exposure compensation is performed, background exposure and flash output both will be compensated. If it is used together with flash exposure compensation, it is possible to adjust the balance of background exposure and the flash output amount (please refer to next page).



# FLASH EXPOSURE COMPENSATION



It is possible to compensate the flash output level without changing the background's exposure.

While pressing the  button, turn the **A**-dial () or **S**-dial () to set the compensation amount.

-  mark and "0.0" will be displayed in the color LCD monitor and viewfinder display when you initially press the  button. "+" indicates over exposure "-" indicates underexposure.

- Exposure compensation can then be set in 1/3 increments from +3.0 to -3.0 stops.
-  mark will be displayed on the viewfinder display after setting the compensation amount has been set. The compensation amount will not be displayed. The exposure amount can be confirmed by pressing the  button.
- It is possible to use the camera for flash exposure compensation of the external flashgun. If the setting is done by both camera and flashgun, then the camera's setting will have priority over the flash's setting.

## WARNING!!

- Once you set the flash Exposure Compensation, the camera will continuously hold this mode, until the compensation amount is reset to 0.0 value.

## Combination of Exposure Compensation and Flash Exposure Compensation

It is possible to make adjustments by using the exposure compensation together with the flash exposure compensation, such as making the background brighter and preventing unwanted flash reflections from the subject.

For instance, set the exposure compensation to +2 and the flash exposure compensation to -2, and the background exposure will be 2 stops over exposed and the flash exposure be 0 (appropriate).

- If exposure compensation and flash exposure compensation are set,  will be displayed in the viewfinder display, only the exposure compensation amount will be displayed.

# AUTO BRACKETING

This function of the camera lets you take a sequence of pictures of the same subject at three different exposure levels; Appropriate Exposure, Under Exposure and Over Exposure. If it is difficult to determine the proper exposure, please use this function.

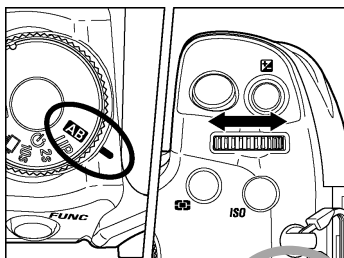

**1**

Set the **D-dial** to **AB** position.

**2**

Turn the **A-dial** (☀️) to set the bracketing amount. (It can be set in 1/3 EV step increments up to  $\pm 3$  EV).

**3**

Set the **D-dial** to drive area (**P.14**).

- The camera will take three pictures in the following sequence; Appropriate exposure, under exposure and over exposure.
- The number of Auto Bracket exposures will be displayed in the viewfinder display as follows. (The value of the Auto Bracketed exposure and exposure counter will be displayed together.) (When the Function Display is on, the number of Auto Bracket exposures is displayed in the Function Display as well.)

First Frame	Second Frame	Third Frame
<b>AB 0.0 Ab-3</b>	<b>AB-2.0 Ab-2</b>	<b>AB+2.0 Ab-1</b>

- For example: If you set the bracketing amount to 2.0, the indicator in the viewfinder will show as follow.







	<b>P,A,S</b> mode	<b>M</b> mode
First Frame	<b>0.0</b>	* Measured Value
Second Frame	<b>-2.0</b>	-2.0 EV deviation from Measured Value
Third Frame	<b>+2.0</b>	+2.0 EV deviation from Measured Value

(\* Measured value is the difference between the correct exposure value of the camera and your setting value).

- The exposure bracketing can be used with 4 different modes.
  - P** Mode ; Both shutter speed and aperture value will be changed.
  - A** Mode ; Only shutter speed will be changed.
  - S** Mode ; Only aperture value will be changed.
  - M** Mode ; Only shutter speed will be changed.

## WARNING !!

- Once you set the auto bracketing mode, the camera will continuously hold that auto bracketing mode until you set the bracketing amount to "0.0".
  - Auto Bracketing function cannot be used with the flashgun. When the built-in flashgun is active, Auto Bracketing will be turned off.
  - While the D-dial is set to the **AB** position, the function for conserving battery power, such as Auto Power Off and LCD Off, will not work. To benefit from this function, please set the D-dial to the drive area.
- When you set the self-timer mode, the camera will automatically take three consecutive pictures.
  - It is possible to change the drive mode during the Auto Bracketing operation. But if you set the self-timer mode, the camera will take three continuous pictures.
  - It is possible to change the Auto Bracket order and the number of possible frames. Please set from [**Camera Capture Settings**] (P.28) → [**Auto Bracket Setting**].

<b>3</b>  <b>0▶-▶+</b> (Default)	Three frames appropriate exposure → under exposure → over exposure
<b>3</b>  <b>-&gt;0▶+</b>	Three frames under exposure → appropriate exposure → over exposure
<b>3</b>  <b>+▶0▶-</b>	Three frames over exposure → appropriate exposure → under exposure
<b>5</b>  <b>0▶-▶+</b>	Five frames appropriate exposure → under exposure → over exposure
<b>5</b>  <b>-&gt;0▶+</b>	Five frames under exposure → appropriate exposure → over exposure
<b>5</b>  <b>+▶0▶-</b>	Five frames over exposure → appropriate exposure → under exposure

- When Five frames is selected on Auto Bracketing mode, the shift value can be set up to ±1.7.

## Auto Bracketing mode can be used in combination with Exposure Compensation.

You can take pictures with Auto Bracketing mode based on a compensated exposure, which you set. To do so, please set both the Auto Bracketing mode and Exposure Compensation mode as desired. The combined value (Exposure Compensation and Auto Bracketing) will be indicated on the viewfinder display.

### Example

Exposure Compensation +1.7 with Auto Bracketing amount 1.0

First Frame	<b>+1.7</b> (Exposure compensation +1.7 & no shift value)
Second Frame	<b>+0.7</b> (Exposure compensation +1.7 & shift value -1.0)
Third Frame	<b>+2.7</b> (Exposure compensation +1.7 & shift value +1.0)

## REMOTE CONTROLLER RS-31

This accessory permits releasing the camera's shutter from up to 16 feet (5m) away from in front of the camera, or up to 9.8 feet (3m) away if you are 30 degrees to either side. (Depending on the lens, there may be some restrictions when using it from the left side of the camera.) All without wires or cables.

### Description of Parts

- ① Transmit Button
- ② Time Delay Selector
- ③ Transmitting diode
- ④ Channel Selector

### OPERATION

#### SETTING OF THE REMOTE CONTROLLER

##### 1

Select the delay time.

- Shutter will be released immediately after the transmit button is pressed.
- Shutter will be released 3 second after the transmit button is pressed.

##### 2

Select the channel.

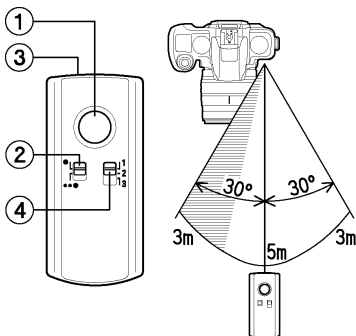

## SETTING OF THE CAMERA

### 3

Please set from [📷 Capture Settings] (P.28) → [RC Channel] and select the same channel number as the remote controller.

### 4

Check that the subject is framed correctly. After you set the focus, we recommend setting the lens switch to MF position.

### 5

Point the transmitting diode at the camera and press the transmit button.

### 6

After taking the picture, please cancel the Remote Control Mode following the above procedure from number **3**, and then choose **OFF** to cancel the remote control function.

- The Remote Control Mode cannot be used together with continuous shooting mode. If the **D**-dial is set to the continuous shooting mode, the camera will expose only one frame for each activation by the remote controller.
- The remote controller may not work properly if strong sunlight is shining directly on the camera's remote control sensor.
- The light entering the viewfinder can affect the exposure system of the camera. To prevent this, use the finder cap while using the remote controller.

#### WARNING !!

- When the Remote Control Mode is set to ON, Auto Power Off will not function. If you are not using Remote Control please cancel the remote control mode by choosing **OFF**.
- It is not possible to use the remote controller with Bulb photography. If you press the Transmit Button with the camera set to Bulb, the shutter will be released with 1/180 second. (1/200 second will be displayed in the image information.)



---

## USING THE MIRROR LOCK-UP WITH REMOTE CONTROL

---

When using mirror-up mode with the remote controller, we recommend that after adjusting the focus, fully depress the shutter button of the camera once, to lock-up the mirror, and then release the shutter by remote control. This procedure saves your time.

**1**

Set the **D**-dial to "**UP**" position, and set the remote control mode.

**2**

Press the shutter button halfway to focus on the subject, and set the desired exposure. Then press the shutter button "all-way down" to raise the mirror-up and retain the focus and exposure.

**3**

To take the picture, point the remote controller's transmitting diode at the camera and press the transmit button.

---

## REPLACING THE REMOTE CONTROLLER BATTERY (RS-31)

---

The remote controller is powered by 1pc CR 2032 3V Lithium -- battery.

**1**

Use a coin or a similar subject to open the battery cover in the direction of the arrow.

**2**

Open the bottom cover and replace the battery.

**3**

Use a coin or similar object to close the battery cover by rotating clockwise.

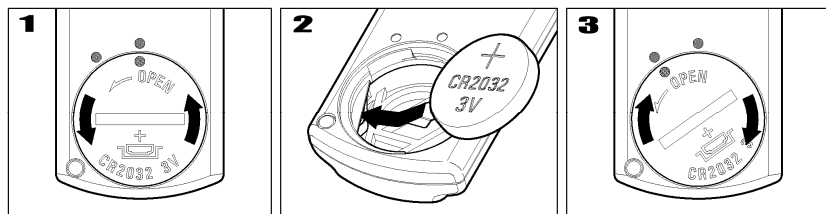

- Check controller operation after replacing the battery.

## DEPTH-OF-FIELD PREVIEW BUTTON

---

Normally, the lens' aperture is always fully opened, except at the time the picture is actually taken, for looking through the viewfinder under maximum brightness conditions.

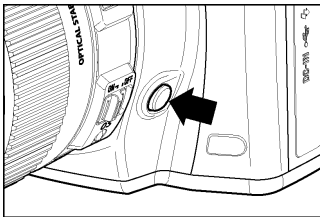

However, by pressing the depth-of-field preview button, the aperture can be closed down to the selected shooting aperture before the picture is taken, enabling you to check depth of field through the viewfinder before shooting.

---

## DEPTH OF FIELD

---

When you set the focus for a particular subject, there is an area in front of and behind your subject, which will also be in focus. This is called the Depth-of-Field.

*Depth of Field will increase when*

### **Using a smaller aperture value (Larger F-number)**

i.e. When you photograph the subject under the same conditions but change the aperture value from F8 to F22, F22 will show more area in focus (more depth of field).

### **Using shorter focal length (wide-angle) lens.**

i.e. When you photograph the subject under the same conditions, changing only focal length from 50mm to 28mm, the 28mm lens will show more area in focus (more depth of field).

### **Photographing the subject at greater distance**

When you photograph the subject with same focal length lens and aperture value but change the camera-to-subject distance, the subject at the greater distance shows more area in focus (more depth of field) compared to subject at the shorter distance.

---

## FLASH PHOTOGRAPHY

---

---

### **ELECTRONIC FLASH EF-610 DG SUPER SA-STTL (SOLD SEPARATELY)**

---

### **ELECTRONIC FLASH EF-610 DG ST SA-STTL (SOLD SEPARATELY)**

---

Optional Sigma Electronic Flashes EF-610 **DG** SUPER SA-STTL and EF-610 **DG** ST SA-STTL with the STTL system allow you to use features such as Auto Flash with the SD1. The EF-610 **DG** SUPER SA-STTL lets you do even more, such as use Multi Flash and other advanced features.

## EF-610 DG SUPER SA-STTL, EF-610 DG ST SA-STTL

- **High light output.** Maximum guide number of 61 (200ft) (ISO100, 105mm zoom head position) .
- **Easy to use.** The flash automatically sets the zoom position according to the focal length of the lens in use (from 24 to 105mm). A built-in wide panel can provide the ultra-wide-angle coverage of a 17mm lens.
- **Flexible.** For bounce flash, the flash head can be tilted up or down, or swiveled to the left or right. Additionally, the flash head can be tilted 7° downward for close-ups.
- **High-speed.** For stop action photography, shutter speeds up to 1/8000 of a second can be used with the high-speed sync FP flash (EF-610 DG Super SA-STTL only).
- **Versatile.** Both flash models can be used with other SD series cameras, SA300n, SA-5, SA-7 and SA-9 cameras.

### WARNING !!

- SD1 is compatible only with the **DG** series clip-on type flashguns. Non-**DG** type Sigma flashguns or flashguns for the other camera brands made by Sigma, or flashguns made by other manufacturers, cannot be used with Sigma SD1 camera.

To get the maximum performance from the SD1 with flash photography, please use the EF-610 **DG SUPER SA-STTL** or EF-610 **DG ST SA-STTL** flashguns. Previous flashgun models for digital SLR cameras also can be used with the SD1, however, some functions and performance will be limited. Please refer the following table.

### Flashguns can be used with the SD1 camera

EF-610 <b>DG SUPER SA-STTL</b>	○	EF-610 <b>DG ST SA-STTL</b>	○
EF-530 <b>DG SUPER SA-STTL</b>	*1	EF-530 <b>DG ST SA-STTL</b>	○
EF-500 <b>DG SUPER SA-STTL</b>	*1	EF-500 <b>DG ST SA-STTL</b>	○
EF-500 <b>DG SUPER SA</b>	*2,*3	EF-500 <b>DG ST SA</b>	*2
EM-140 <b>DG SA-STTL</b>	*1	EF-140 <b>DG SA-STTL</b>	○

### Limitation

○	There is no limitation.
*1	<b>S-TTL AUTO FP</b> flash function cannot be used. If you use FP flash function, it is necessary to set it manually.
*2	AF auxiliary light may not be powerful enough, and focusing may not work properly depending on the distance or photographic subjects. In such a case, please use manual focus.
*3	Sometimes, the exposure display of the camera and the exposure display of the flash may not match exactly. Wireless flash function of the EF-500 <b>DG SUPER SA</b> cannot be used (Slave Flash can be used).

The SD1 is equipped with a PC Synchro Terminal, which accepts a cable connection from external/studio flash units.

### CAUTION!!

- S-TTL auto flash does not work, if PC Synchro Terminal is used.
- Set the camera's exposure mode to M and set to flash synchronized speed **Sync** (1/180) or a shutter speed of 1/160 or lower. See the instruction manual of the particular flash used for additional information.
- The SD1's PC Synchro Terminal is compatible with plugs that have a positive (+) polarity on the central pin and a negative (-) polarity on the shield. If the plug has reverse polarity, use a commercially-available polarity conversion cord.

### WARNING!!

- The PC terminal cannot accept flashes that use a voltage of more than 250V. Higher voltage will damage the camera. Please ask the manufacturer of the flash about the voltage and compatibility with the PC terminal.

## AUTO ROTATE

It is possible to record the vertical image information to images.

Please set from  **Capture Settings** (P.28) → **[Auto Rotate]**.

<b>Off</b>	The vertical image information will not be recorded.
<b>On</b> (default)	The vertical image information will be recorded.

- When vertically orientated images are reviewed, they will automatically rotate and be displayed vertically.
- When vertically orientated images are reviewed in Sigma Photo Pro, they will automatically rotate and be displayed vertically.
- When vertically orientated images are rotated by pressing  **Playback Menu** (P.28) → **[Rotate]**, the rotated orientation will be stored.

- If [Applied Rotate] in [ Playback Menu] (P.28) is set to [Off], the vertically oriented images are displayed horizontally.

## WARNING !!

- If the images are taken while the camera is pointed up or down, the vertical position information may not be recorded properly.

## CUSTOM MODE

It is possible to customize the Custom Mode Setting. (Up to three patterns can be stored.)

- The following settings are available.

### Functions for shooting

Exposure Mode (P.45) AF Point (P.57) Exposure compensation (P.74)	Flash Exposure Compensation (P.75) Auto Bracket (P.76)
-------------------------------------------------------------------------	-----------------------------------------------------------

### Quick Set Menu

ISO Sensitivity (P.67) AF Mode (P.56) Flash Mode (P.53) Metering Mode (P.71)	White Balance (P.65) Color Mode (P.69) Image Quality (P.68) Image Size (P.68)
---------------------------------------------------------------------------------------	----------------------------------------------------------------------------------------

### Capture Settings

Picture Settings (P.70) Auto Rotate (P.84) AEL Button Settings (P.73) Half pressed AEL (P.73) Slow Sync. (P.54) Flash Sync. Mode (P.54)	Auto Bracket Setting (P.76) AF Auxiliary Light (P.58) AF Drive Setting (P.60) Switch A/S Dial (P.110) Dial Reverse Setting (P.110) [UP] Setting (P.64) RC Channel (P.78)
--------------------------------------------------------------------------------------------------------------------------------------------------------	--------------------------------------------------------------------------------------------------------------------------------------------------------------------------------------------

### Camera Settings

Extended Mode (P.83)
----------------------

---

## SAVE THE CUSTOM MODE SETTING



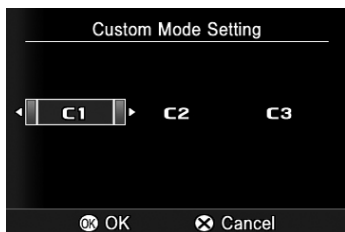

---





**1**

Set the above settings to your desired combination.

**2**

In [  **Camera Settings**] (P.28) → [**Custom Mode Setting**], select from **C1**, **C2** or **C3** by using   buttons. After selecting, press the  button. A confirmation dialog will appear.

**3**

Press the  button to save the settings or  to close the confirmation dialog without saving the settings.

### WARNING !!

- When the new setting is saved, the previous stored setting will be overwritten.

---

## LOAD THE CUSTOM MODE SETTING

---

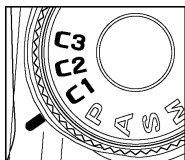

Set the Mode dial to **C1**, **C2** or **C3**.



In custom mode, it is possible to change the above settings temporarily (except Exposure Mode).

If the setting is changed, ★ mark will appear in Function Display.

Return to original registered setting by doing the following.

- Turn the camera off (this includes the camera turning off automatically with the Auto Power Off function)
- Set the Mode dial to another position.

# REVIEWING, DELETING AND MODIFYING IMAGES

This section explains how to review, delete, and modify images after they have been captured.

## TIP

- The SD1 may not be able to display images captured by other cameras, or “SD1” images that have been renamed or moved from the **DCIM** folder on the card. For more information on SD1 file names, see File Numbering System (See **P.108**).

## QUICK PREVIEW

The SD1 camera can be set to automatically display a preview of each image immediately after it is taken. This is useful for instantly checking exposure and framing.

## CHANGING THE QUICK PREVIEW DURATION

The Quick Preview image can be completely disabled, if you select 'Off', or displayed for 2, 5, or 10 seconds.

Please set from [ **Capture Settings**] (**P.28**) → [**Quick Preview**].

### QUICK PREVIEW OPTIONS

<b>Off</b>	No preview image is displayed.
 <b>2 sec.</b> (Default)	Preview image is displayed for 2 seconds. (color LCD monitor shuts off automatically after 2 seconds.)
<b>5 sec.</b>	Preview image is displayed for 5 seconds.
<b>10 sec.</b>	Preview image is displayed for 10 seconds.

-  icon is the recommended setting for conserving the electronic power.

## TIP

- To manually turn off the Quick Preview image, press the **X** button or the shutter button halfway.
- It will not be possible to zoom in to the preview image, each of the [**▶** **Playback Menu**] (P.28) settings, or change to another image while the Quick Preview is displayed.
- The format of Quick Preview will use the last saved setting of [**VIEWING ONE IMAGE AT A TIME**] of P.88 or [**VIEWING IMAGE INFORMATION**] of P.91.

# REVIEWING IMAGES

The pictures captured by the SD1 can be reviewed in various ways.

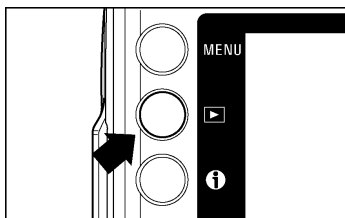

To review images captured by the SD1 camera press the **▶** button on the back of the camera. The last image recorded on the card will be displayed on the color LCD monitor in Single-Image View.

Press **▶** button on the back of the camera to turn on the color LCD monitor and display image.

- By pressing **▶** again or **X** button, the color LCD monitor will be turned off.

## TIP





- If no new images have been captured in the meantime, the last reviewed image will be displayed instead.
- If there are no images on the card an error message will be displayed.
- Since the SD1 camera does not have a separate "playback mode" for looking at captured images, it is always ready to take pictures, even while displaying captured images.



# VIEWING ONE IMAGE AT A TIME

Press  button on the back of the camera to see recorded images in Single-Image View.

## While in Single-Image View:

- Rotate the **A**-dial () to the right to see the next image.
- Rotate the **A**-dial () to the left to see the previous image.
- Press  button to see next image.
- Press  button to see previous image.
- Press  buttons to change the indicated information. It is possible to change the information bar from the following two patterns or view the image without the information bar.

Battery Level Indicator

Image Size

Folder numbering / File numbering

Image Quality



file number/total files recorded

Date

Time



file number/total files recorded

Shutter speed

Aperture

ISO sensitivity

## TIP

- To scroll through images more quickly, press and hold the  buttons. Images will advance automatically until the button is released.
- Images in the first and the last page are linked. The image in the first page is displayed after the image in the last page.

## MAGNIFYING IMAGES (ZOOMED-IN VIEW)

Reviewed images can be magnified, making it possible to check image details and focusing.

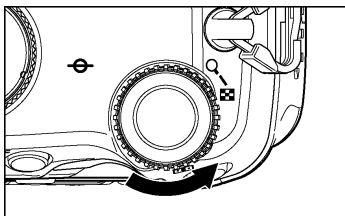

While reviewing images, rotate the **S-dial** (⚙️) to the **Q** position.

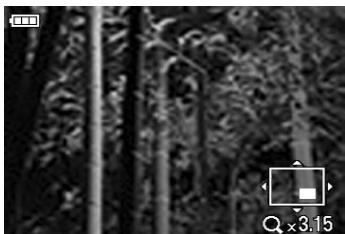

The magnification ratio will be changed as follows.

Original→**X1.25**→**X1.6**→**X2.0**→**X2.5**→**X3.15**  
→**X4.0**→**X5.0**→**X6.3**→**X8.0**→**X10.0**

### WHILE IN ZOOMED-IN VIEW:

- Rotate the **S-dial** (⚙️) to the **Q** position to increase magnification.
- Rotate the **S-dial** (⚙️) to the **⊠** position to decrease magnification.
- Rotate the **A-dial** (➡️) to the right to see the next image.
- Rotate the **A-dial** (⬅️) to the left to see the previous image.
- Press the **⬆️** buttons or the **⬇️** buttons to pan around the image.
- Press the **⊗** button to return to the original ratio.
- Press the **OK** button to return to the original ratio.

### CAUTION!!

- While magnifying an image, the **⬅️** buttons cannot be used to change images. Rotate the **S-dial** (⚙️) to the **⊠** position or press the **⊗** button to return to the original ratio (Single-image View), then use the **⬅️** buttons to change images.

## VIEWING NINE IMAGES AT A TIME (CONTACT SHEET VIEW)

Images can be viewed in a "contact sheet" of nine thumbnail images.

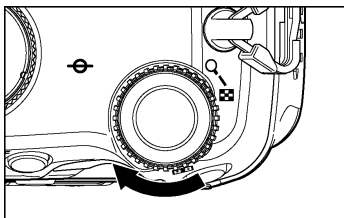

While reviewing images, rotate the S-dial (⚙) to the 🚩 position.



### WHILE IN CONTACT SHEET VIEW:

- Press the ⬅➡ buttons to change the thumbnail image selection.
- Rotate the A-dial (☀) to the right to select the next thumbnail image.
- Rotate the A-dial (☀) to the left to select the previous thumbnail image.
- Rotate the S-dial (⚙) to the 🚩 position, the selected thumbnail image will be reviewed.
- Press the ✖ button to return to Single-image View.

### TIP

- The first and last page are linked. The first page is displayed after the last page.

# VIEWING IMAGE INFORMATION

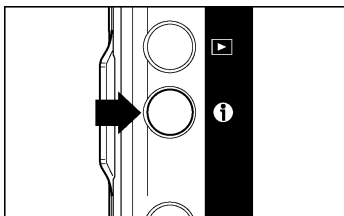

The Image Info Screen contains additional information about each image.

Press the **i** button from Single-Image or Contact Sheet View.

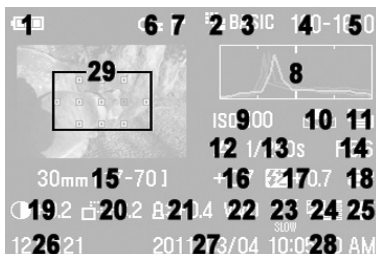

1	Battery Level Indicator
2	Image Size
3	Image Quality
4	Folder numbering
5	File numbering
6	Lock *1
7	Mark *1
8	Histogram
9	ISO Sensitivity
10	White Balance
11	Drive Mode
12	Exposure Mode
13	Shutter Speed
14	F Number
15	Focal Length

16	Exposure Compensation Value
17	Flash Exposure Compensation Value *1
18	Metering Mode
19	Contrast
20	Sharpness
21	Saturation
22	Color Mode
23	Flash Mode *1
24	Auto Bracket *1
25	Focus Mode *2
26	File Number / total files recorded
27	DATE
28	TIME
29	Focus Point *3

\*1 If these features are set, the icon will be displayed.

\*2 If the picture was taken in Manual Focus mode, the icon will be displayed.

In AF mode, the AF point which was used to achieve focusing will be illuminated in red. If the picture was taken without focusing, the AF points will not be illuminated in red.

In MF mode, if the picture was taken with a focus indicator lit, that AF point will be illuminated in red. If the picture was taken while no focus indicators were lit, no AF points will be illuminated in red.

### While in Image Info Screen:

- Use **A**-dial (☀), to change the image selection the same way as in Single-Image View.
- Use ◀▶ buttons to change the image selection the same way as in Single-Image View. (See next section for the exception.)
- Press **i** again to close the Image Info Screen and return to the previous view.
- Press **X** button to turn off the color LCD monitor.

## MAGNIFIED IMAGES IN IMAGE INFO SCREEN

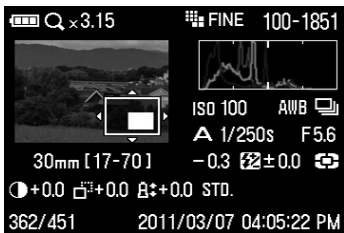

While the Image Info Screen is displayed, it is possible to magnify the image by rotating the **S**-dial (⦿) to the **Q** direction. It is possible to obtain detailed histogram information for a particular section of an image.

- For more information on the histogram see the next section.

### While magnifying the image in the Image Info Screen:

- Press the ◀▶ buttons to pan to another part of the image. (Histogram will update automatically to reflect the new values.)
- **Rotate the S-dial (⦿) to the Q position to increase magnification.**
- **Rotate the S-dial (⦿) to the ̄ position to decrease magnification.**
- Press **X** to cancel magnification and view the Image Info Screen for full image. (Press **X** again to disable the color LCD monitor.)

# HISTOGRAM

The histogram is a graph depicting the distribution of brightness values in the image for each of the three color channels (Red, Green, and Blue). The horizontal axis shows the brightness level, with darker pixels towards the left side and brighter pixels toward the right. The vertical axis shows the proportion of pixels at each level of brightness.

By examining the histogram of the full image, you can gauge the over-all exposure of that image. You can also use the histogram to determine if zoomed-in sections of an image are over or under exposed.

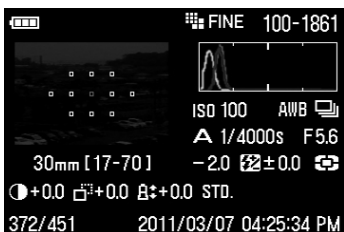

This histogram shows that the higher pixel values are never used in the image, indicating that the image is underexposed, and therefore will appear dark. In general, when the histogram is higher on the left side, the image is mostly composed of dark pixels, causing it to appear dark—either because the image is underexposed or because it is a dark scene such as night shot or sunset.

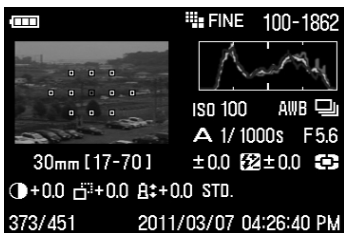

This histogram shows a fairly even distribution of pixel values, indicating that the image is well exposed, with good contrast. However, the histogram distribution of a well exposed image will vary greatly depending on the subject.

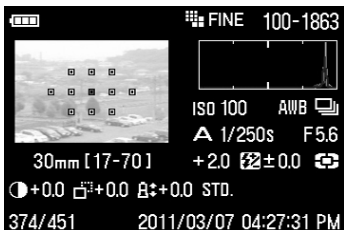

This histogram shows that many of the pixel values are at their brightness limit, indicating that some areas of the image may be blown out. In general, when the histogram runs off the right side, the image will have many white pixels—either because the image is overexposed or because it is a bright scene such as the beach or snow.

## CAUTION!!

- The histogram displayed in the Quick Preview is the distribution of tones in the image.
- When JPEG files taken with **B&W** or **Sepia** Color Mode are shown, the histogram displayed is the distribution of tones in the image.

## OVER-EXPOSURE WARNING

---

It is possible to indicate the over-exposed areas by highlighting them in red.

Please set [▶ Playback Menu] (P.28) → [Exposure Warning] → [On].

## TIP

- The **OK** button can be used as a shortcut key to temporarily toggle the over-exposure warning overlay on or off. Using the shortcut key will not change the Exposure Warning setting in the Set-up Menu. (See **P.104** to set OK key shortcut.)

# VIEWING IMAGES ON A TV

The SD1 camera can be connected to a television or a video/DVD recorder using the provided AV cable, allowing the recorded images to be viewed on the television monitor or recorded on videotape/DVD.

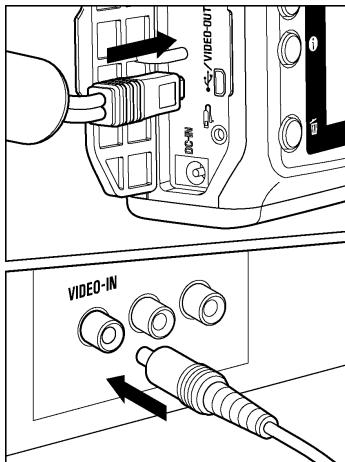

## TO CONNECT THE CAMERA TO A VIDEO DEVICE

**1**

Open the connector cover.

**2**

Connect the AV cable to the < **USB / VIDEO- OUT** > terminal on the camera and to the video input terminal on the television or video recorder. (Please connect the yellow plug to the video input terminal.)

**3**

Turn on the camera and the video device.

## WARNING !!

- Please do not use any AV cable other than provided with your Sigma SD1 camera, when connecting a video input terminal. Using other brands may cause damage.

## TIP

- It is recommended that the camera be powered with the AC adapter (optional) during television playback to avoid draining the battery.
- The default mode for the video signal is NTSC. When connecting the camera to a PAL device, the [Video Mode] must be changed to [PAL] in [  Camera Settings ] (P.28).





# DELETING IMAGES

This section describes how to delete the image(s) recorded on a card.

Images recorded on the card can be deleted one at a time or several at once using the Delete Menu.

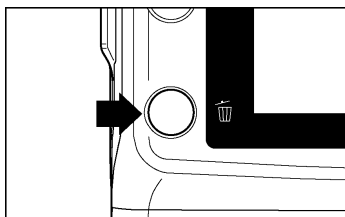
## DELETE AN IMAGE WITH THE DELETE BUTTON



A single image that is displaying can be deleted by pressing the  button.



### 1

Select the image that you wish to delete.

### 2

Press the  and a confirmation dialog **[Delete current file?]** will be displayed.

### 3

Press the  button to delete the image or  to close the confirmation dialog without deleting.

## WARNING !!

- If the image is locked, a confirmation dialog **[This file is locked.]** will come up and protect from deletion. If you wish to delete the image, it is necessary to unlock it first. (See **P.98 - 100** for information on locking and unlocking images.)
- Images stored as **RAW+JPG**, both the RAW and JPEG files will be deleted.

# DELETE IMAGES FROM THE DELETE MENU

It is possible to delete a single image or multiple images from the Delete menu.

## 1

Press the **MENU** button and open [▶] **Playback Menu** (P.28) to select [Delete].

## 2

Select from the following options from the sub-menu.

<b>Current File</b>	Delete the currently selected image only.
<b>All Marked</b>	Delete all marked images on the card. (See P.100 - 102 for information on marking images.)
<b>All</b>	Delete all images on the card. (Locked images are not deleted) (See P.98 - 100 for information on locking images.)

## 3

Press the **OK** or ▶ button to confirm your selection. A confirmation dialog will appear.

## 4

Press **OK** to delete all the images or press **X** to return to reviewing images without deleting.

### WARNING !!

- When [**All Marked**] or [**All**] is done, it may take time to finish them depending on the number of files in the card.

### TIP

- Marked images that are also locked will not be deleted with the [**All Marked**] menu item. The locked images must be unlocked first. Marked images are not protected from deletion unless they are also locked.
- To erase all files from the card, including locked images as well as all non-SD1 files, use the "**FORMATTING THE CARD**" menu item in the camera Set-up Menu (see P.41).

# OTHER REVIEWING FEATURES

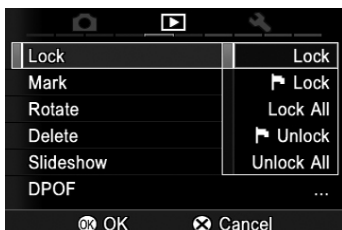

This section explains how to use Slideshow, Lock, Mark, Rotate and so on.

## LOCKING IMAGES



Locking protects images from being accidentally deleted. Locked images must be unlocked before they can be deleted by the Delete Menu functions.

### LOCK MENU

Lock/Unlock	Lock the currently selected image only. If the image is already locked, the menu item changes to "Unlock".
 Lock	Lock all marked images on the card. (See P.100 - 102 for information on marking images.)
Lock All	Lock all images on the card.
 Unlock	Unlock all marked images on the card. (See P.100 - 102 for information on marking images.)
Unlock All	Unlock all locked images on the card.

### CAUTION !!

- Locking does not prevent images from being erased when the card is formatted. Review card contents carefully before formatting.

### TIP

- Locked images have a "read-only" status when viewed on a computer.

---

## TO LOCK A SINGLE IMAGE

---

**1**

Display the image that you wish to lock.

**2**

Press the **MENU** button and open [**▶** **Playback Menu**] (P.28) to select [**Lock**]. ( [**Lock**] in the sub-menu is already selected.)

**3**

Press the **OK** button or **▶** button.

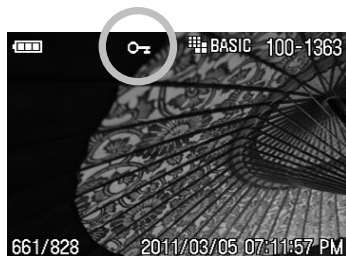

- A key icon  will appear in the image indicating that the image is locked.

### TIP

- To unlock a locked image, select the locked image and follow the same steps as above.

---

## TO LOCK MULTIPLE IMAGES

---

**1**

Press the **MENU** button and open [**▶** **Playback Menu**] (P.28) to select [**Lock**].

**2**

Select [**▶** **Lock**] or [**Lock All**] from the sub-menu.

**3**

A confirmation dialog will be displayed by pressing the **OK** or **▶** button.

**4**

Press **OK** to lock the images or press **X** to return to reviewing images without locking.

- A key icon  will appear in all locked images.

## TIP

- To unlock multiple images, select the [Unlock All] or [Unlock] in the Lock Menu.
- The **OK** button can be used as a shortcut key for locking images. (See P.104)

## WARNING !!

- When [Lock] or [Unlock] is done, it may take time to complete this depending on the number of files in the card.

## MARKING IMAGES



Images can be marked for various reasons, such as to identify favorites, to select images for a Slideshow, or to select images to be deleted with the “All marked” menu item in the Delete Menu (P.96-97).

## MARK MENU

<b>Mark/Unmark</b>	Mark the currently selected image only. If the image is already marked, the menu item changes to “Unmark”.
<b>Mark All</b>	Mark all images on the card.
<b>Unmark All</b>	Unmark all marked images on the card.

## TIP

- Images marked on the camera will retain their marked status when viewed in **SIGMA Photo Pro**.

---

## TO MARK A SINGLE IMAGE

---

**1**

Display the image that you wish to mark.

**2**

Press the **MENU** button and open [▶] **Playback Menu** (P.28) to select [Mark]. ([Mark] in the sub-menu is already selected.)

**3**

Press the **OK** or ▶ button.

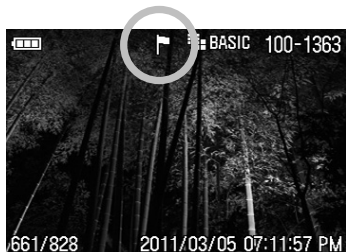

- A flag icon  will appear in the image indicating that the image is marked.

### TIP

- To unmark a marked image, select the marked image and follow the same steps as above.
- The **OK** button can be used as a shortcut key for marking images. (See P.104)

---

## MARKING ALL IMAGES

---

**1**

Press the **MENU** button while displaying an image and open [▶] **Playback Menu** (P.28) to select [Mark].

**2**

Select [Mark All] from the sub-menu.

**3**

A confirmation dialog will be displayed by pressing the **OK** or ▶ button.

**4**

Press **OK** to mark the images or press **X** to return to reviewing images without marking.

- A flag icon  will appear in all marked images.

### TIP

- Select [**Unmark All**] from the Mark Menu to unmark all marked images on the card.

### WARNING !!

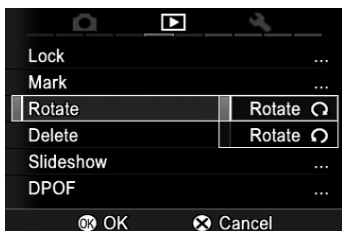

- When [**Mark All**] or [**Unmark All**] is done, it may take much time to finish them depending on the number of files in the card.

## ROTATING IMAGES



It is possible to rotate the displayed image.

### ROTATE MENU

<b>Rotate</b> 	Rotate the currently selected image 90 degrees to the right (clockwise).
<b>Rotate</b> 	Rotate the currently selected image 90 degrees to the left (counterclockwise).

### 1

Display the image that you wish to rotate.

### 2

Press the **MENU** button to open [ **Playback Menu**] (P.28), and select [**Rotate**].

### 3

Select the rotation direction: [**Rotate** ] or [**Rotate** ] in the sub-menu.

## 4

Press **OK** to rotate the image and close the Modification Menu or **X** to return to reviewing images without rotating.

### TIP

- To rotate an image 180 degrees, rotate it twice in the same direction.
- To get an image back into its original orientation, rotate it in the opposite direction.
- The **OK** button can be used as a shortcut key for rotating images. (See **P.104**)
- Images rotated on the camera will be displayed in their rotated orientation in **SIGMA Photo Pro**.

### WARNING !!

- When [**Applied Rotate**] in [**▶ Playback Menu**] (**P.28**) is set to [**Off**], it is not possible to select the Rotate Menu.



# USING THE OK BUTTON SHORTCUT

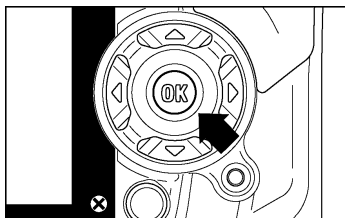

It is possible to allocate a function from the Playback Menu to the **OK** button. The allocated function can be changed by pressing the **OK** button.

Please set from [**▶** Playback Menu] (P.28) → [OK Shortcut].

## Available functions to allocate to the **OK** button.

<b>Lock/Unlock</b>	Lock the currently selected image by pressing the <b>OK</b> button. If the current image is already locked, the image will be unlocked.
<b>Mark/Unmark</b>	Mark the currently selected image by pressing the <b>OK</b> button. If the current image is already marked, the image will be unmarked.
<b>Rotate</b> ↻	Each time the <b>OK</b> button is pressed, rotate the currently selected image 90 degrees to the right (clockwise).
<b>Rotate</b> ↻	Each time the <b>OK</b> button is pressed, rotate the currently selected image 90 degrees to the left (counterclockwise).
<b>Exp. Warning</b>	Each time the <b>OK</b> button is pressed, toggle the exposure warning on or off.

- To dismiss the allocated function, set to [**None**].

## WARNING !!

- Even if the [**Rotate**] function is allocated to the **OK** button, it is not possible to rotate the image when [**Applied Rotate**] in [**▶** Playback Menu] (P.28) is set to [**Off**].

# SHOWING A SLIDESHOW

---

---

All images on the card, or only selected images, can be shown in an automatic playback mode using the SD1 camera's Slideshow feature.

## SLIDESHOW MENU

<b>All Images</b>	Start an automated slideshow of all images on the card.
<b>Locked Images</b>	Start an automated slideshow of all locked images on the card.
<b>Marked Images</b>	Start an automated slideshow of all marked images on the card.
<b>Slideshow Settings</b>	It is possible to set the length of time that each picture will be displayed and the availability of Repeat.

---

## TO START A SLIDESHOW

---

### 1

Press the **MENU** button while displaying an image and open [▶] **Playback Menu** (P.28) to select [**Slideshow**].

### 2

Select [**All Images**], [**Marked Images**] or [**Locked Images**] in the sub-menu.

### 3

The Slideshow starts by pressing the **OK** or ▶ button.

- To terminate the slideshow, press the **OK** or ✕ button.

## WARNING !!

- When [**Marked Images**] is selected, it may take time to start the Slideshow depending on the number of files to be displayed.

## NOTE

- When the slideshow is stopped, the last image will continue to be displayed.

## CHAGING SLIDESHOW SETTINGS



Select the [**Slideshow Settings**] in Slideshow Menu and then press the **OK** button to open the setting display.

### SLIDESHOW SETTING MENU

<b>Duration</b>	<b>2 sec.</b> <b>5 sec.</b> <b>10 sec.</b>	Set the length of time that each image in a slideshow is displayed.
<b>Repeat</b>	<b>No</b> <b>Yes</b>	Set whether the slideshow loops continuously or stops on the last image.

#### Duration

Select [**Duration**] using the **◆** buttons, then select the desired number of seconds by pressing the **◀▶** buttons.

#### Repeat

Select [**Repeat**] using the **◆** buttons, then select [**No**] or [**Yes**] by pressing the **◀▶** buttons.

Press **OK** to confirm the Slideshow settings or **X** to close the confirmation dialog without any change.

# DPOF (DIGITAL PRINT ORDER FORMAT)

When printing images at a photo lab, it is possible to specify which photos and quantity to print in advance, using the DPOF menu. This is also available when making prints using a DPOF compatible printer.

## WARNING !!

- In the case of RAW images (files with X3F extension), DPOF printing is not possible.

## 1

Press the **MENU** button to select [**DPOF**] in [**▶ Playback Menu**] (P.28) while displaying an image.

## 2

Select the desired option using the **OK** or **▶** button.

(When ([**Select / Quantity**] or [**Select All Images**] is selected, a confirmation dialog will appear. Press the **OK** button to continue the process or the **X** button to stop the process.)

## DPOF MENU

<b>Select / Quantity</b>	Set the print quantity by pressing the <b>◆</b> buttons. To set number of copies from multiple images, select the image that you wish to print by pressing the <b>◀▶</b> buttons and then set the print quantity for each image by pressing the <b>◆</b> buttons. Press the <b>OK</b> button to apply the setting.
<b>Select All Images</b>	This option selects all still images on the card for printing. Set print quantity by pressing the <b>◆</b> buttons and press the <b>OK</b> button to apply the setting.
<b>Cancel All Selections</b>	Reset all print quantity settings. Press the <b>OK</b> button to cancel all print quantity settings.

## TIP

- Total number of print quantity (the total sum of print quantity for each image) is displayed at the lower right of the monitor.

# CHANGING OTHER SETTINGS

This section explains how to change the setting of basic camera operation to your desired settings.

## FILE NUMBERING SYSTEM

Stored data is automatically assigned file numbers from 0001 to 9999. When data is being reviewed, the file number of each image is displayed in the right corner on the color LCD monitor (see **P.88, 91**). The file number is also incorporated into the filename of the image. The filename consists of "SDIM" followed by the 4-digit file number and extension. For example: image number 0023 will be stored in the file SDIM0023.X3F.

All SD1 image files will be stored to ###SIGMA folder of the DCIM folder in the card.

- When [ **Capture Settings**] (**P.28**) → [**Picture Settings**] → [**Color Space**] is set to [**Adobe RGB**], the filename will consist of "\_SDI" instead of "SDIM".
- File numbering can be continuous, or can be reset every time an empty card is detected. Use the Camera Set-up Menu (**P.28**) to set the file numbering system.

File numbering system can be set in [ **Camera Settings**] (**P.28**) → [**File Numbering**].

### FILE NUMBERING OPTIONS

<b>Continuous</b> (Default)	Numbering is continuous. The first file number assigned on an empty card will be one higher than the last assigned number. (If the inserted card contains SD1 images with file numbers greater than the last assigned number, file numbering will continue with one higher than the highest file number on the card.)
<b>Auto Reset</b>	Each time an empty card is inserted, or all images on the current card are deleted, the file number will reset to its default value of 0001. (If the inserted card already contains SD1 images, the file number will not be reset.)





## WARNING !!

- When Folder numbering / File numbering has reached “999-9999”, even if the card has greater capacity, the message [**Cannot allocate file or folder number. Please replace a card.**] will be displayed and it will not be possible to take any more pictures. Please replace the card to continue taking pictures.
- It is not possible to continue using the card which has reached “999-9999”. In this case, please do the following.
  1. Transfer all files on the card to your PC.
  2. Format the card.



## CAPTURE SETTING DISPLAY

If you wish to change the settings through the viewfinder display only, it is possible to hide the capture setting display on the color LCD monitor.

It is possible to set whether or not the Capture Settings are shown in the color LCD monitor by pressing the following Capture Setting buttons. (it is not possible to select these separately)

 EXPOSURE COMPENSATION	 METERING MODE	<i>ISO</i> ISO SENSITIVITY
 AF POINT SELECTOR	 FLASH EXPOSURE COMPARTMENT	

Please set from [ **Camera Settings**] (P.28) → [**Capture Setting Display**].

 (Default)	Capture Setting will be displayed by pressing the button. It is possible to change the setting through the view finder display and the color LCD monitor.
	Capture Setting will not be displayed even if the button is pressed. It is possible to change the setting through the view finder display only.

## WARNING !!

- When [Capture Setting Display] is set to [  ] and Function Display or Quick Set Menu are on, the color LCD monitor will be turned off if one of the Capture Setting buttons is pressed.





## CUSTOMIZE THE DIAL

It is possible to switch the functions of the dials and reverse their rotation direction for exposure settings.

### SWITCH A/S DIAL

In manual exposure mode, **A-dial** (  ) is used for setting aperture value and **S-dial** (  ) for shutter speed. These allocations can be switched.





Please set from [  Capture Settings ] (P.28) → [Switch A/S Dial].

<b>Original</b> (Default)	A-dial (  ) : aperture value S-dial (  ) : shutter speed
<b>Switch</b>	A-dial (  ) : shutter speed S-dial (  ) : aperture value

### DIAL REVERSE SETTING

It is possible to reverse the rotation direction of dials when setting up the aperture value and shutter speed.

Please set from [  Capture Settings ] (P.28) → [Dial Reverse Setting].

	Aperture Value	Shutter Speed
<b>Original</b> (Default)	Open  Stop down	Slow  Fast
<b>Reverse</b>	Stop down  Open	Fast  Slow

# LCD OFF AND AUTO POWER OFF

The SD1 has [LCD Off] and [Auto Power Off] functions in order to conserve battery power. If not used for a predetermined amount of time, the color LCD monitor or power will be turned off automatically.

## LCD Off

If not used for a predetermined amount of time, the backlight of the color LCD monitor will be turned off automatically. Although the color LCD monitor is turned off, the camera power remains ON, therefore, each button (except the depth-of-field preview button) can be operated normally. It is possible to change to shooting mode, upon pressing the shutter button halfway.

## Auto Power Off

If not used for a predetermined amount of time, the camera will be turned off automatically. While the camera is in Auto Power Off, each button will not function. It is necessary to press the shutter button halfway to terminate Auto Power off. It is possible to change to shooting mode upon pressing the shutter button halfway.

Set the Auto Power Off from [ Camera Settings] (P.28) → [LCD Off] and [Auto Power Off].

### LCD Off Option

Off
 10 sec.
30 sec.
1 min. (Default)
5 min.
10 min.

### Auto Power Off Option

Off
30 sec.
1 min.
5 min. (Default)
10 min.

-  icon is the recommended setting for conserving the electronic power.

## TIP

- To disable LCD Off, set [LCD Off] to [Off].
- To disable Auto Power Off, set [Auto Power Off] to [Off].



## WARNING !!

- It is not possible to set [LCD Off] for a longer time than [Auto Power Off]. For example, when [LCD Off] is set to [5 min.] and [Auto Power Off] is set to [1 min.], the [LCD Off] setting will be changed to [1 min.] automatically.

## AF MICRO ADJUSTMENT

It is possible to make micro adjustments to the focusing point.

## WARNING !!

- Normally, AF Micro Adjustment is not required. As it may be impossible to focus correctly if AF Micro Adjustment is set, please only use the AF Micro Adjustment if needed.
- It is necessary to use a tripod to prevent blurring and camera shake when testing and setting up AF Micro Adjustment.
- It is not possible to set up AF Micro Adjustment on older designed lenses as the camera cannot obtain lens information.
- It may be impossible to set up lenses which were released after the SD1 camera was released. In that case, updating Lens information is required. Please confirm the latest information from our website.

## AF MICRO ADJUSTMENT OPTIONS

<b>Off</b> (Default)	AF Micro Adjustment is not reflected when mounting a registered lens on the SD1 .
<b>On</b>	AF Adjustment is reflected when mounting a registered lens on the SD1.
<b>Setting...</b>	Set up AF Micro Adjustment for the lens currently mounted on the SD1.

---

## SETTING THE AF MICRO ADJUSTMENT

---



### 1

Mount the desired lens to your camera.

### 2

Select [**AF Micro Adjustment**] from [ **Camera Settings**] (P.28).

### 3

Select [**Setting...**] in the sub-menu and open AF Micro Setting Display by pressing the  or  button..

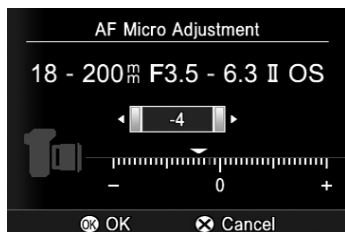

### 4

Adjust the value using the   buttons.

Adjust to the front focus position by using  button.
---------------------------------------------------------------------------------------------------------------------------------------

Adjust to the rear focus position by using  button.
--------------------------------------------------------------------------------------------------------------------------------------

### 5

Set the adjustment by pressing . (When the adjustment is set, [**AF Micro Adjustment**] turns on automatically.)

## WARNING !!

- Only one value can be stored for each type of lens. If you attach other lenses of the same type, it will be recognized as the same lens which has already been stored.

# RESET TO THE DEFAULTS

---

It is possible to reset the settings to the defaults.

## 1

Press the **MENU** button to select [**Camera reset**] in [**Camera Settings**] (P.28).

## 2

Use the **OK** or **▶** button to display a confirmation dialog.

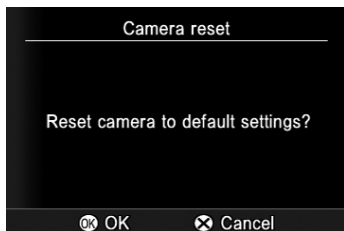

## 3

Press **OK** to reset the settings to default or **✕** to close the confirmation dialog without resetting.

- The following settings are not reset by the above steps.
  - **Language setting**
  - **Custom mode setting**
  - **AF Micro Adjustment setting**

If you want to reset all the camera settings, including those listed above, you will have to reset the camera to factory defaults. When displaying the confirmation dialog in step **2**, press **⏏** to show the message [**Reset all camera settings to factory defaults?**].

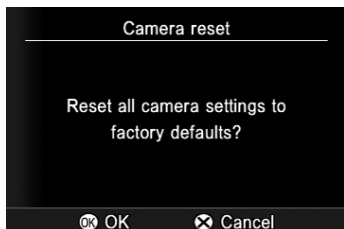

Press **OK** to reset all camera settings to factory defaults or **✕** to close the confirmation dialog without resetting.

# REFERENCE

## OPTIONAL ACCESSORIES

---

---

### REMOTE CONTROLLER RS-31

Wireless remote control, permits releasing the shutter from a place away from the camera. Time for a shutter release can be set up in two stages. Moreover, a setup of a channel is also possible, to avoid interference with other cameras and remote controls. (For detailed information please refer page **78 - 80**)

### POWER GRIP PG-31 (Launch: Summer 2011)

This battery pack extends power capacity of the SD1 two times and can also be used as a vertical position grip. Two BP-21 Lithium-ion batteries can be used in Power Pack SD. In addition, it is equipped with a vertical shutter release to hold the camera steady in the vertical position.

### ELECTRONIC FLASH EF-610 DG SUPER SA-STTL

Auto zoom flash with abundant light and STTL Automatic Exposure with the maximum guide number 61/m (200/ft) (ISO100). EF-610 DG SUPER SA-STTL allows you to use many advanced flash techniques such as "STTL system Auto Flash" or Multi Flash etc. (Please refer to page **81 - 82** for details).

### ELECTRONIC FLASH EF-610 DG ST SA-STTL

Auto zoom flash with abundant light and STTL Automatic Exposure with the maximum guide number 61/m (200/ft) (ISO100). It provides a proper flash exposure under any lighting conditions and it is equipped with bounce flash function, same as EF-610 DG Super. (Please refer to page **81 - 82** for details.)

### CABLE RELEASE SWITCH CR-21

It can connect with release socket, on the camera body, and the shutter can be released, without touching the camera. This accessory minimizes the camera shake, which can result in blurriness of your photograph, especially when using Mirror up and a super-telephoto lens. (It is connected to release socket of the camera. Since it is not equipped with halfway operation. Please press the shutter button halfway and check the exposure. Please adjust the focus manually.)

### EYEPIECE DIOPTRIC CORRECTION LENSES

The SD1 has a built-in type "Diopter Adjuster" and its range is  $-3 \sim +1.5$ dpt, if you still cannot see the viewfinder clearly, then please purchase a viewfinder diopter adjustment eyepiece. These are series of seven optional accessory lenses, which adjust the camera's viewfinder to accommodate the vision requirements (near-sightedness or far-sightedness) of different photographers. They attach to the camera's eyepiece frame. The dioptic correction values of these lenses range from  $-4$  to  $+3$ .

## AC ADAPTER SAC-4

This is used to provide a constant electricity supply when shooting in the studio, or taking indoor shots. It is also recommended for use when connecting the camera to your computer to transfer data. (Please refer to page 23 for details)

## MAINTENANCE

---

---

- Do not use chemicals or other cleaning agents such as thinners or benzene for cleaning the camera and lens. Use a clean, soft cloth and blower to clean the camera and lens. Lens cleaners can be used for removing fingerprints.
- Do not lubricate the camera, lens or lens contacts.
- Use a blower to remove dust and dirt from the color LCD monitor. To remove fingerprints or other stains from the color LCD monitor, wipe the surface gently with a soft, clean cloth. Do not apply excessive force, as this could damage the color LCD monitor.
- The Sigma SD1 camera contains a dust protector located inside the lens mount. The dust protector is a very delicate device and care must be taken not to scratch its surface. Use a blower to remove dirt and dust from the dust protector. Do not use a blower brush, as the bristles could scratch the dust protector surface. To avoid damage, do not apply pressure to the dust protector.

## CLEANING THE IMAGE SENSOR

---

---

Although the SD1 is equipped with a dust protector to prevent dust or dirt entering the camera, in rare circumstances, dust or dirt may adhere to the image sensor, causing black spots to appear on images. If this occurs, it may be necessary to clean the image sensor.

- The image sensor is extremely delicate and can easily be damaged. We recommend that you contact an authorized Sigma Service Station to have the sensor cleaned. We do not advise attempting the procedure yourself, especially if you have no previous experience cleaning delicate optical components.

### **WARNING!!**

- The image sensor is a very important part of your camera. Please take all necessary precautions to avoid damaging the sensor.
- Do not use an aerosol compressed air cleaner. Liquid may leak from the cleaner and damage the image sensor or other electronics inside the camera.

## WARNING!!

- After cleaning the image sensor, please ensure the dust protector is correctly attached. If the dust protector is not properly attached, it may move and damage the image sensor of the camera or the lens.
- Please do not use the blower with the brush for cleaning the image sensor. If the brush is attached, it may scratch the image sensor of the camera.
- We recommend using the AC adapter (sold separately) to clean the image sensor. If the AC adapter is not used, please be sure to fully charge the battery. If the battery voltage is less than the normal level, the camera will warn you with an electronic “beep”. In such cases, stop the cleaning process immediately and fully charge the battery. Failure to do so can result in damage.

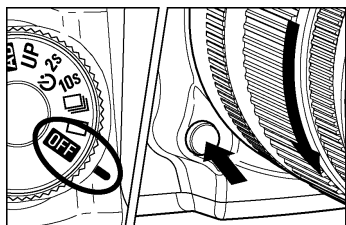

**1**

Turn the **D**-dial to the **OFF** position and remove the lens.

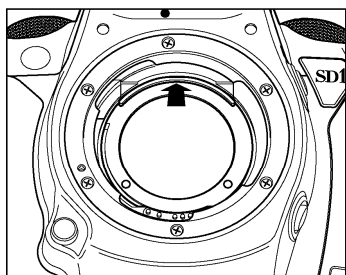

**2**

To detach the dust protector, slide it upwards from its projecting lip with your fingernail. Be careful not to touch the glass on the dust protector.

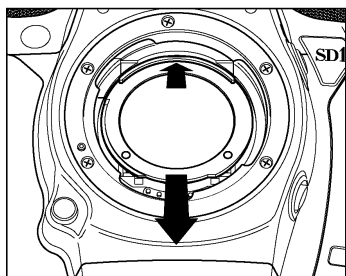

**3**

Once the dust protector slides upwards, the lower part of the dust protector is released. Grasp it and remove the dust protector. (Be careful not to touch the glass on the dust protector.)

## 4

Set the **D**-dial to the Drive Area and press the **MENU** button to select **[Cleaning Mode]** in **[Camera Settings]** (P.28).

## 5

A confirmation dialog will appear by pressing the **OK** or **▶** button.

## 6

By pressing **OK** again, the shutter will open and you will be able to see the image sensor.

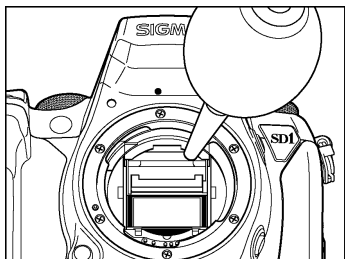

## 7

Carefully blow away any dust from the image sensor using the blower.

Make sure that the tip of blower does not protrude inside the lens mount. If the power supply should suddenly shut off, the shutter curtain and mirror will close. These delicate parts could hit the blower and damage the camera.

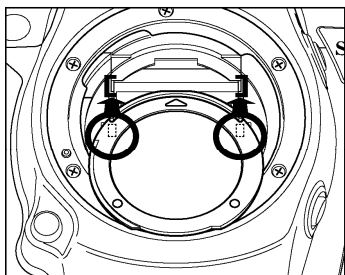

## 8

Once you are done cleaning the image sensor, turn the **D**-dial to the **OFF** position. Check that there is no dust or dirt on the dust protector.

Insert the upper tabs on the back of the dust protector into the two holes as shown in the illustration.

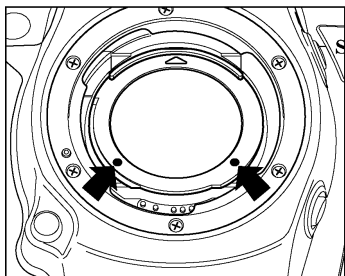

## 9

Push the lower section of the dust protector, as shown in the illustration, with your finger until it clicks into position. In order to avoid any damage, please ensure that the dust protector is correctly positioned.

- If the dust or dirt cannot be removed with the above-mentioned procedure, consult with Sigma- authorized service personnel. If you see fingerprints on the glass portion of the dust protector, first use a blower to remove any dust, then gently wipe it with a soft, clean cloth.

## **EXPLANATION OF TERMS**

---

### **AE**

Auto Exposure; by using a built-in exposure meter, camera determines the correct exposure value, which is combinations of shutter speed and/or aperture value.

### **AE Lock**

The camera will fix and memorize the exposure value with AE lock. For example, if a photographic subject is placed in the center and exposure value of the composition is fixed, the brightness of the background will not influence the exposure, even if the composition changes and the subject is moved from the center of a screen. (AE lock button must be used).

### **AF**

Auto Focus; by using a built-in sensor, camera adjusts the focusing automatically.

### **AF Lock**

In AF shooting mode, you can lock the focus on the main subject. For instance, compose the desired subject in the center of the viewfinder. With the focus fixed at the same setting, you can re-compose the picture with the subject off-center and take shots. (Please press the shutter button halfway to use this feature with Sigma SD1).

### **Aperture**

The lens opening of the iris diaphragm inside the lens. The amount of light, which strikes the image sensor, is adjusted by the iris diaphragm. The f-number (Focal Length/Diameter of the Aperture Opening) describes the size of this opening, the size of the hole can be made larger or smaller. Large aperture (low f-number) gives bright results and, small aperture (high f-number) gives darker results.

### **Auto Power-Off**

For saving the battery power, the SD1 camera can automatically turn itself off, if you do not operate it.



## **CMOS**

Complementary Metal Oxide Semiconductor (CMOS) can perform signal amplification on a per-pixel basis. Significant current flows only during the switching operation. Therefore a CMOS image sensor can scan data rapidly, sustain high-speed operation and consume less energy. Recent technological and production improvements in digital imaging systems are making CMOS more and more competitive in terms of image quality and cost.

## **Color Temperature**

The numerical expression of the tone of the light, produced by a light source. The standard unit for color temperature is degrees Kelvin (K). The sunny daylight used as a standard near 5600 K. Low color temperature implies warmer more yellow/red light while high color temperature implies a colder more blue light. The typical color temperature of Tungsten light is 3200 K grade, a personal computer is 9300 K.

## **Exposure.**

The amount of light reaching the image sensor's surface. The exposure is controlled by the combination of aperture value and shutter speed.

## **EV**

Exposure Value (EV) is a numerical value that expresses the amount of light for a given exposure, and depends on brightness of the photographic subject and sensitivity of the film. If a photographic subject is bright, then this numerical value will be large, and if the subject is dark then this numerical value will be small. If two-times of light reaches the film surface then the difference in exposure value will be +1, and if the amount of light is reduced by half, the exposure value changes by -1.

## **Histogram**

The histogram function is a graphic representation of how bright and dark pixels are distributed in an image. The histogram function enables a precise check on the exposure of the photo.

## **ISO Sensitivity**

ISO (International Organization for Standardization) ; refers to the number assigned to each silver halide film, which indicates film speed or the film's relative sensitivity to light, the higher the number, the greater photosensitivity and vice versa. Digital cameras also use standard ISO sensitivity ratings like silver halide films.

## **JPEG**

Joint Photographic Experts Group has established a standard method for compressing and decompressing the digitized images. If the rate of compression is high the file size will be small but picture quality will be decreased.

## **NTSC**

National Television Standards Committee (NTSC) video format is primarily used in the United States, Japan, Canada etc. The NTSC is a standard for television and videos, which defines a composite video signal with a refresh rate of 60 half-frames (interlaced) per second. Each frame contains 525 lines and can contain 16 million different colors.

## **PAL**

Phase Alternating Line (PAL), video format primarily used in Europe, excluding France, as well as Australia and parts of the Far East. PAL delivers 625 lines at 50 half-frames per second.

## **RAW**

The RAW image format is the data as it comes directly from the image sensor of the camera. No in-camera processing is performed before transferring the image to computer.

## **Shutter Speed**

The camera's shutter opens for a length of time to control the amount of light that reaches the imaging element. The length of time that shutter blinds are open allowing light to strike the image sensor is called as shutter speed.

## **White Balance**

The human eye and brain adapt to changes in lighting conditions, not only to intensity, but also to the color characteristic of the light source, so that colors of the objects look normal or accurate. For example, a white object will appear white whether it is viewed under sunlight, tungsten or fluorescent illumination. However, color film or digital camera must be adjusted, so that colors will be represented accurately, under different types of illumination. This adjustment is called white balance. The function to adjust a white balance automatically is called automatic white balance.

# WARNING DISPLAYS

---

---

## COLOR LCD MONITOR MESSAGES

---

### “No Memory Card”

---

- ▶ Please Insert the card. (P.39)

### “Card Error”

---

- ▶ Format card. If the error persists, replace with new card. (P.41)
- ▶ The card may be damaged.

### “Card Full”

---

- ▶ Delete unwanted photos, choose a lower resolution setting, or use a different card. (P.39-40) (P.96-97)

### “No images on Memory card”

---

- ▶ To review images, insert a card with valid SD1 images, capture new images onto the card, or press  button again to turn off display.

### “Cannot preview this image”

---

- ▶ It may have been taken by another camera or the image data may have collapsed.

### “Cannot magnify this image”

---

- ▶ It may have been taken by another camera or the image data may have collapsed.

### “Cannot save this image!”

---

- ▶ The card may be damaged. Please transfer the data to another hardware such as a PC and then format the card in the PC. If the same message is displayed, the card may have collapsed. Please use a new card.

### An error has occurred! Error code # # #.

---

- ▶ Turn the camera off and back on. If the problem persists, call Technical Support and give them the error number.

# TROUBLESHOOTING

---

If you have a problem with your camera or cannot take good pictures, consult the list below as you check the camera before requesting repairs.

## Nothing is displayed on the color LCD monitor.

---

Battery is exhausted.

- ▶ Replace the battery. (P.19-22)

Battery is improperly installed.

- ▶ Insert the battery in the proper direction. (P.20)

Auto Power Off is activated.

- ▶ Press the shutter button halfway to reactivate the camera. (P.111)

## The shutter does not release

---

Battery is exhausted.

- ▶ Replace the battery. (P.19-22)

D-dial is set outside of the Drive Area.

- ▶ Set the D-dial to the Drive Area to take a picture. (P.61)

Camera is unable to get a focus lock when set to AF-S mode.

- ▶ Try focusing on a different subject or focus the camera manually. (P.55-59)

Card is not inserted or is inserted improperly.

- ▶ Insert the card correctly. (P.39)

The camera is busy writing to the card.

- ▶ Please wait until the card busy light goes off. (P.42)

Card is full.

- ▶ Insert a new card or delete unwanted images. (P.39-40)(P.96-97)

## Autofocus does not operate



---

The AF/M switch on the lens body is set to **M**.

- ▶ Set the AF/M switch on the lens to **AF**. (P.55)

Lens is not properly mounted to the camera body.

- ▶ Mount the lens to the camera body correctly. (P.24)

The AF drive setting is set to [AF  **AF-ON** /  **OFF**]

- ▶ Autofocus is driven by pressing the AF button. It is possible change this setting to drive AF by pressing the shutter button halfway. (P.60)

## **The buttons on the back of the camera don't work**

---

Auto Power Off is activated.

- ▶ Press the shutter button halfway to reactivate the buttons.
- ▶ Disable Auto Power Off in the Set-up Menu. (P.111-112)

## **Difficulty seeing the images on the color LCD monitor.**

---

Dust or dirt has adhered to the color LCD monitor.

- ▶ Clean the color LCD monitor with a blower or eyeglass cloth. (P.116)

The color LCD monitor is worn out.

- ▶ Please consult the retailer from which you purchased the camera or contact the nearest Sigma Service Center.

## **Pictures are coming out blurred**

---

The AF/M switch on the lens body is set to **M**.

- ▶ Set the AF/M switch on the lens to **AF**. (P.55)

Hand movement or camera shake occurred when the shutter button was pressed.

- ▶ To prevent blurring, press the shutter button more gently or use remote controller, cable release switch or a tripod.

## **Cannot use the card**

---

Image data on the card is corrupted.

- ▶ Format the card. (P.41)

## **Cannot delete images**

---

Images may be locked.

- ▶ Unlock the images. (P.98-100)

## **Incorrect date and time is shown**

---

Date and time setting may be incorrect.

- ▶ Enter the correct date and time in the Set-up Menu. (P.27)

## **No image appears on the TV monitor**

---

Video cable is not correctly inserted.

- ▶ Insert the video cable correctly. (P.95)

# SPECIFICATIONS

Camera Type	Interchangeable Lens SLR Type Digital Camera
Storage Media	CompactFlash™ (Type I, UDMA compatible)
Image Sensor Size	23.5 x 15.7mm
Lenses Used	SIGMA SA mount interchangeable lenses
Picture Angle	Equivalent to approx.1.5 times the focal length of the lens (for 35mm cameras)
Lens Mount	SIGMA SA bayonet mount
Imaging Element Type	Foveon X3® direct image sensor(CMOS)
Color Photo Detectors	Total Pixels : 48MP Effective Pixels : 46MP (4,800×3,200×3 layers)
Aspect Ratio	3 : 2
Still Image Format	Exif 2.3, DCF 2.0
Image Recording Format	Lossless compression RAW Data (12-bit), JPEG
Resolution	HI : 4704 x 3136 MED : 3264 x 2176, LOW : 2336 x 1568
Image Quality Modes	RAW, JPEG (Fine, Normal, Basic), RAW+JPEG(Fine)
Interfaces	USB 2.0, Video Out (NTSC/PAL)
White Balance	8 Type (Auto, Sunlight, Shade, Overcast, Incandescent, Fluorescent, Flash, Custom white balance)
Viewfinder Type	Pentaprism SLR Viewfinder
Viewfinder Frame Coverage	98% horizontal, 98% vertical
Viewfinder Magnification	0.95x (50mm F1.4 at infinity)
Eyepoint	18mm
Diopter Adjustment Range	-3dpt to +1.5dpt
Auto Focus Type	TTL phase difference detection system 11 points twin cross sensor
AF Operating Range	EV -1 to 18 (ISO100)
Focus Modes	Single AF, Continuous AF (AF Predict function), MF
Metering Systems	Evaluative Metering, Center-Weighted Average Metering, Center Area Metering, Spot metering
Metering Range	EV 1 to 20 (with 50mm F1.4 at ISO100)
Exposure Modes	(P) Program AE, (A) Aperture Priority AE, (S) Shutter Speed Priority AE, (M) Manual
ISO Sensivity	ISO 100, 200, 400, 800, 1600, 3200, 6400
Exposure Compensation	±3EV (in 1/3steps)
AE Lock	AE lock button is pressed or shutter release button is pressed halfway
Auto Bracketing	Three or five frames (in 1/3steps, Appropriate Exposure – Under Exposure – Over Exposure)

Shutter Type	Vertical-travel metal focal plane shutter, electronically controlled through entire speed range
Shutter Speeds	1/8000sec to 30sec, Bulb up to 30 (120) sec *( ) Extended Mode Flash Synchronization at 1/180sec.
Continuous Shooting	Up to approx. 5.0 fps (Image Size is set to HI) Up to approx. 6.0 fps (Image Size is set to MED or LOW)
Built-in Flash	S-TTL Auto Flash, Manual Pop-up Built-in flash, GN11 (ISO100/m), 17mm lens angle covered
External Flash Synchronization	Hot shoe (contact X, with dedicated flash linking contact)
LCD Monitor Type	Aspect ratio3:2, 3.0" wide viewing angle TFT color LCD monitor, approx. 460,000 pixels, Coverage area 100%
Reviewing Images	Single-Image display, Zoom-in display, 9 segments thumbnail display, Slide Show
Language	English / Japanese / German / Chinese (Simplified) / French / Spanish / Italian / Korean / Russian
Power Source	lithium ion battery BP-21
	AC Adapter SAC-4 (Optional)
Dimensions	145.5mm/5.7"(W) X 113.5mm/4.4"(H) X 80.0mm/3.1"(D)
Weight	700 / 24.7oz (without battery)

## CONNECTING YOUR CAMERA TO A COMPUTER

The SD1 camera can be connected directly to a computer using the provided USB cable. Make sure that the camera is off before connecting it to the computer. Data transfer rates will vary depending on the computer and operating system used. For further information, please refer to Help within SIGMA Photo Pro.

### CONNECTING THE CABLES

- The shutter button and the color LCD monitor will be disabled while the camera is connected to the computer via a USB cable.

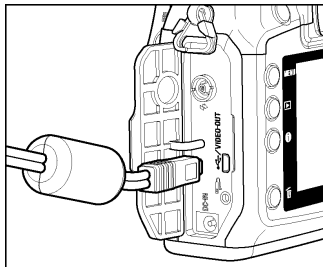

### WARNING!!

- Please use only the USB cable supplied with your camera.

This device complies with Part 15 of the FCC Rules. Operation is subject to the following two conditions:  
(1) This device may not cause harmful interference, and  
(2) this device must accept any interference received, including interference that may cause undesired operation.

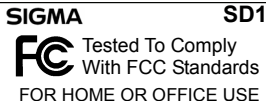

**SIGMA CORPORATION OF AMERICA**  
15 Fleetwood Court, Ronkonkoma,  
NY 11779, U.S.A.  
TEL: 631 585 1144

## **For customers in the U.S.A.**

### **Federal Communications Commission (FCC) Radio Frequency Interference Statement**

This equipment has been tested and found to comply with the limits for class B digital devices, pursuant to Part 15 of the FCC Rules. These limits are designed to provide reasonable protection against harmful interference in a residential installation. This equipment generates, uses and can radiate radio frequency energy and, if not installed and used in accordance with the instructions, may cause harmful interference to radio communications. However, there is no guarantee that interference will not occur in a particular installation. If this equipment does cause harmful interference to radio or television reception, which can be determined by turning the equipment off and on, the user is encouraged to try to correct the interference by one or more of the following measures:

- Reorient or relocate the receiving antenna.
- Increase the separation between the equipment and receiver.
- Connect the equipment into an outlet on a circuit different from that to which the receiver is connected.
- Consult the dealer or an experienced radio/TV technician for help.

Use of interface cable is required to comply with class B limits in Subpart B of Part 15 of FCC Rules.

Any changes or modifications to this equipment not specified in this manual may void your warranty.

## **For customers in the Canada**

This Class B digital apparatus complies with Canadian ICES-003.

Cet appareil numérique de la classe B est conforme à la norme NMB-003 du Canada.



The CE Mark is a Directive conformity mark of the European Community (EC).

### **SIGMA (Deutschland) GmbH**

Carl-Zeiss-Str. 10/2, D-63322 Roedermark, Germany

Verkauf: 01805-90 90 85-0 Service: 01805-90 90 85-85 Fax (Service): 01805-90 90 85-35

---

## **SIGMA CORPORATION**

2-4-16 Kuriki, Asao-ku, Kawasaki-shi, Kanagawa 215-8530 Japan

Phone : 044 - 989 - 7430 Fax : 044 - 989 - 7451



**お詫びと訂正**

日本語

24 ページ「**レンズを取り付ける**」の項目におきまして、「カメラのマウントにある赤い丸…」とありますが、実際は白い丸です。(15 ページも同様です。) お詫びして訂正させていただきます。

**CORRECTION NOTICE**

ENGLISH

The text on P.24 for information regarding **[MOUNTING AND REMOVING THE LENS]** is currently as follows: "Align the red mark on the camera's mount with the red dot on the lens". However, the mark on the camera's mount is actually white in color and not red.

**KORREKTURHINWEIS**

DEUTSCH

Der Text im Benutzerhandbuch auf S.24 mit den Informationen über **[ANSETZEN UND ABNEHMEN DES OBJEKTIVS]** lautet im Moment wie folgt: "Richten Sie den roten Punkt am Objektiv auf die rote Markierung am Kamerabajonett aus". Die Markierung am Kamerabajonett der SD1 ist indessen weiß und nicht rot.

**修正通告**

簡体中文

在用户手册之第 24 页 **[安装及拆卸镜头]**，现更改如下：“在镜头接环上之红点与相机上的红色标记对齐”。但是在相机接环上之标记是白色，而并非红色。

**修正通告**

繁體中文

在用戶手冊之第 24 頁 **[安裝及拆卸鏡頭]**，現更改如下：“在鏡頭接環上之紅點與相機上的紅色標記對齊”。但是在相機接環上之標記是白色，而並非紅色。

**CORRECTIONS DU MODE D'EMPLOI**

FRANÇAIS

**MISE EN PLACE ET RETRAIT DE L'OBJECTIF (P.24)**

Alignez le repère blanc placé sur la baïonnette de l'appareil avec le point rouge situé sur l'objectif.

**AVISO DE CORRECCIÓN**

ESPAÑOL

El texto de la P.24 con la información acerca del **[MONTAR Y DESMONTAR EL OBJETIVO]** es actualmente el siguiente: "Alinear la marca roja en la cámara con el punto rojo en el objetivo". Sin embargo, la marca de la cámara en realidad es de color blanco y no rojo.

**ATTENZIONE, TESTO VARIATO**

ITALIANO

Il testo a pag.24 circa il **METTERE E TOGLIERE L'OBBIETTIVO** va cambiato in: "Allineare il segno rosso sull'innesto della fotocamera con il punto rosso dell'obiettivo". Attualmente il segno sulla fotocamera è bianco e non rosso.

**매뉴얼 내용의 수정 공지**

한국어

**[렌즈 교환]**에 관한 정보는 24 페이지에 “카메라의 빨간색 점에 렌즈의 빨간색 점을 정렬합니다.” 라고 되어 있습니다. 그러나, 카메라에는 빨간색 점이 아니라 흰색으로 되어 있습니다.”

**УВЕДОМЛЕНИЕ ОБ ОШИБКЕ В ИНСТРУКЦИИ.**

РУССКИЙ

На странице 24 инструкции, в описании установки объектива на камеру, ошибочно указано: «Совместите красную точку на байонете камеры с красной точкой на объективе». На самом деле, точка на байонете камеры белого цвета.