

**6x6(2-1/4-square)  
single-lens  
reflex  
camera**

**66**

***Kowa*/SIX**

Welcome to the exciting and rewarding world of Kowa/SIX 2-1/4-square single-lens reflex photography.

Although you are probably anxious to start shooting with your new Kowa/SIX, we suggest that you take the time to carefully study this instruction manual. As you go through the pages, try to understand—not just memorize—the operations of the camera. In this way, you will quickly realize the full potential of this superb instrument and its accompanying lens and accessory system. If you have any questions, your Kowa dealer will be glad to answer them.



# CONTENTS

	Page
Parts Description .....	4
Film Loading .....	6
Settings for 120 or 220 Film.....	8
Operating the Kowa/SIX .....	10
Interchanging Lenses .....	14
Interchanging Viewfinders, Viewing Screens .....	18
How To Use Kowa/SIX Accessories .....	20
Close-up Photography With Extension Tubes .....	22
The Kowa/SIX System .....	23
Depth-of-Field Table, Kowa/SIX Lenses .....	24
Shutter Mechanism Operation.....	26
Kowa/SIX Specifications .....	27

- ① Viewing magnifier
- ② Strap stud, front
- ③ Strap stud, rear
- ④ Film & shutter knob/flip-out crank (film advance)
- ⑤ 12/24 frame counter selection knob
- ⑥ Automatic zero-reset 12/24 frame counter
- ⑦ Depth-of-field preview lever
- ⑧ Removable finder hood
- ⑨ Distance scale
- ⑩ Depth-of-field scale
- ⑪ Aperture scale
- ⑫ Aperture selection ring
- ⑬ Shutter speed scale
- ⑭ Standard 85mm F/2.8 lens
- ⑮ Focusing ring
- ⑯ Shutter speed selection ring
- ⑰ Shutter release button lock ring

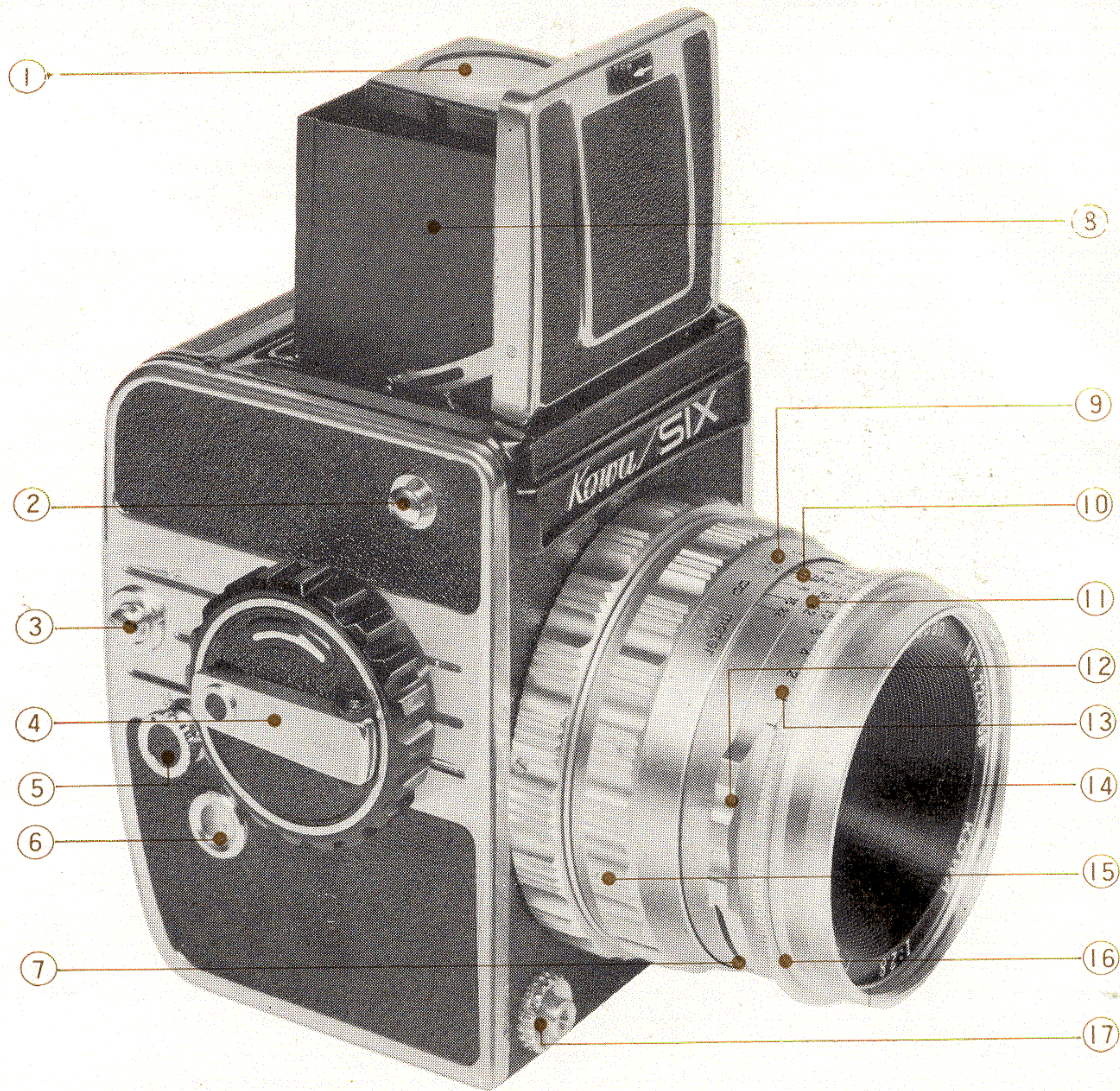

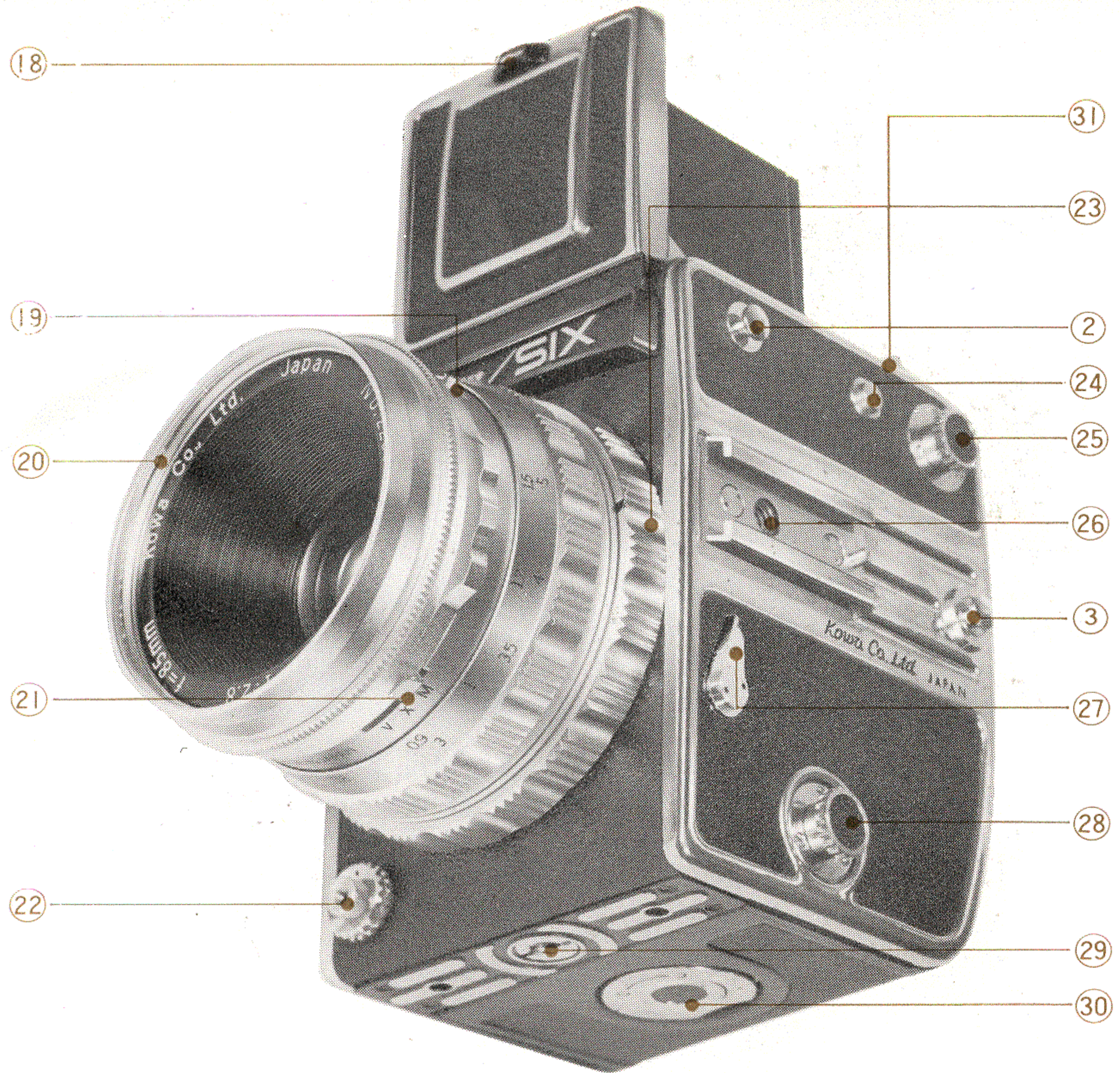

# Parts Description

- ⑱ Finder hood/viewing magnifier release button
- ⑲ Flash synchro terminal
- ⑳ Filter mount threads
- ㉑ M/X flash synchronization selection and self-timer selection lever
- ㉒ Shutter-release button
- ㉓ Lens locking collar
- ㉔ Interchangeable finder hood release button
- ㉕ Take-up spool knob
- ㉖ Accessory shoe
- ㉗ Lens locking lever
- ㉘ Feed spool knob
- ㉙ Tripod mount
- ㉚ Camera back locking knob
- ㉛ Camera back locking lever

# FILM LOADING

- ※ Avoid direct sunlight when loading or unloading film. A relatively dark place — especially with higher speed film — is best.
- ※ Remember whether you are using 120 (12 exposure) or 220 (24 exposure) film loads.

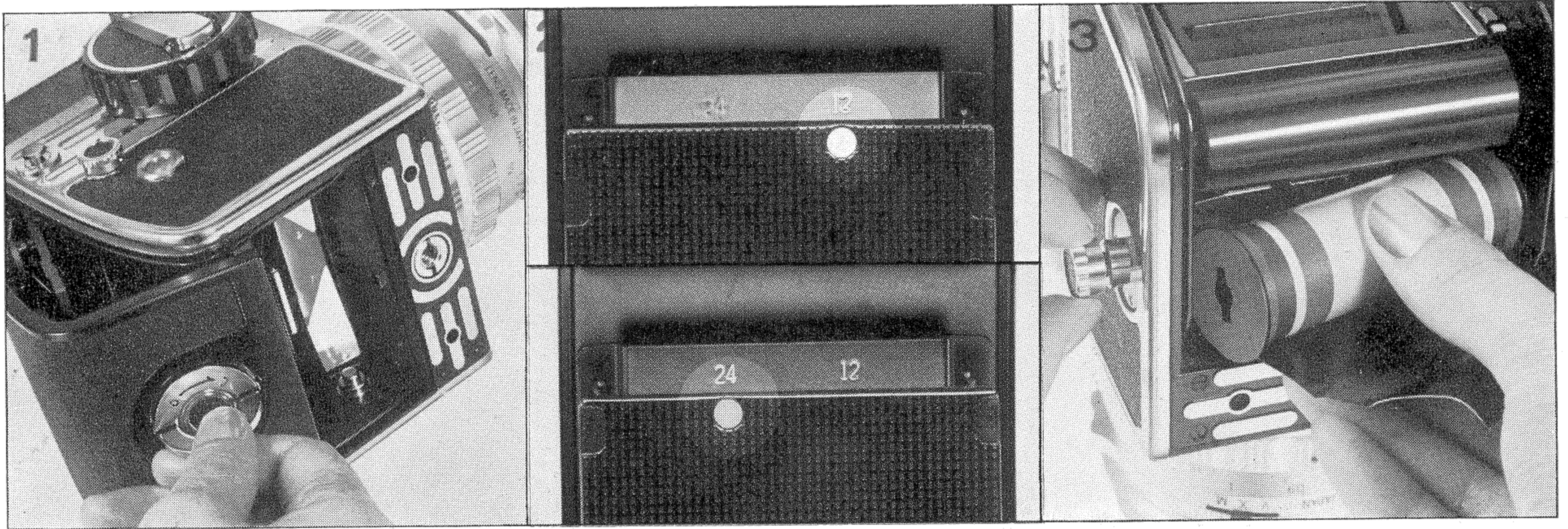

## 1. Open the camera back

Flip up the camera back-locking knob on the bottom of the camera. Turn the knob toward "0" until it comes to a stop. Pull it out gently. The camera back will now open.

## 2. Set film pressure plate and frame counter, if necessary

The film pressure plate and frame counter must be set for the type of film you are using, 120 or 220. See the directions on Pages 18 and 19.

## 3. Load the film

Insert an empty spool into the top of the film chamber and a loaded film spool into the bottom of the chamber. To facilitate loading of the spools, first pull out the take-up spool knob and the feed spool knob. Both will remain in the pulled-out position. When you have placed both spools into the camera, twist the knobs. A spring will return them to their normal positions. See that the take-up and feed spools are moving freely.

※ If you do not plan to shoot immediately, it is advisable to lock the shutter-release button according to the directions on Page 12. This will prevent you from wasting a frame due to accidental exposure.



#### 4. Advance the film to the "start" markings

Insert the film leader tip into the slit in the take-up spool. Slowly advance the film, making certain that take-up is smooth, taut, and straight. Continue to advance the film until the "start" markings on the film (usually arrows) line-up with the index points (red dots) on the camera's film guides.

#### 5. Close the camera back

Close the camera back and turn the camera back locking knob in the direction of the "C" until it comes to a stop. At the same time, press in on the camera back. Check to be certain that it is properly locked.

#### 6. Advance the film to the first frame

Advance the film until the number "1" appears in the frame counter window. The automatic mechanism will stop the film from advancing further when you reach the first frame. The shutter is now wound and you may take your first picture.

# SETTING FOR 120 OR 220 FILM

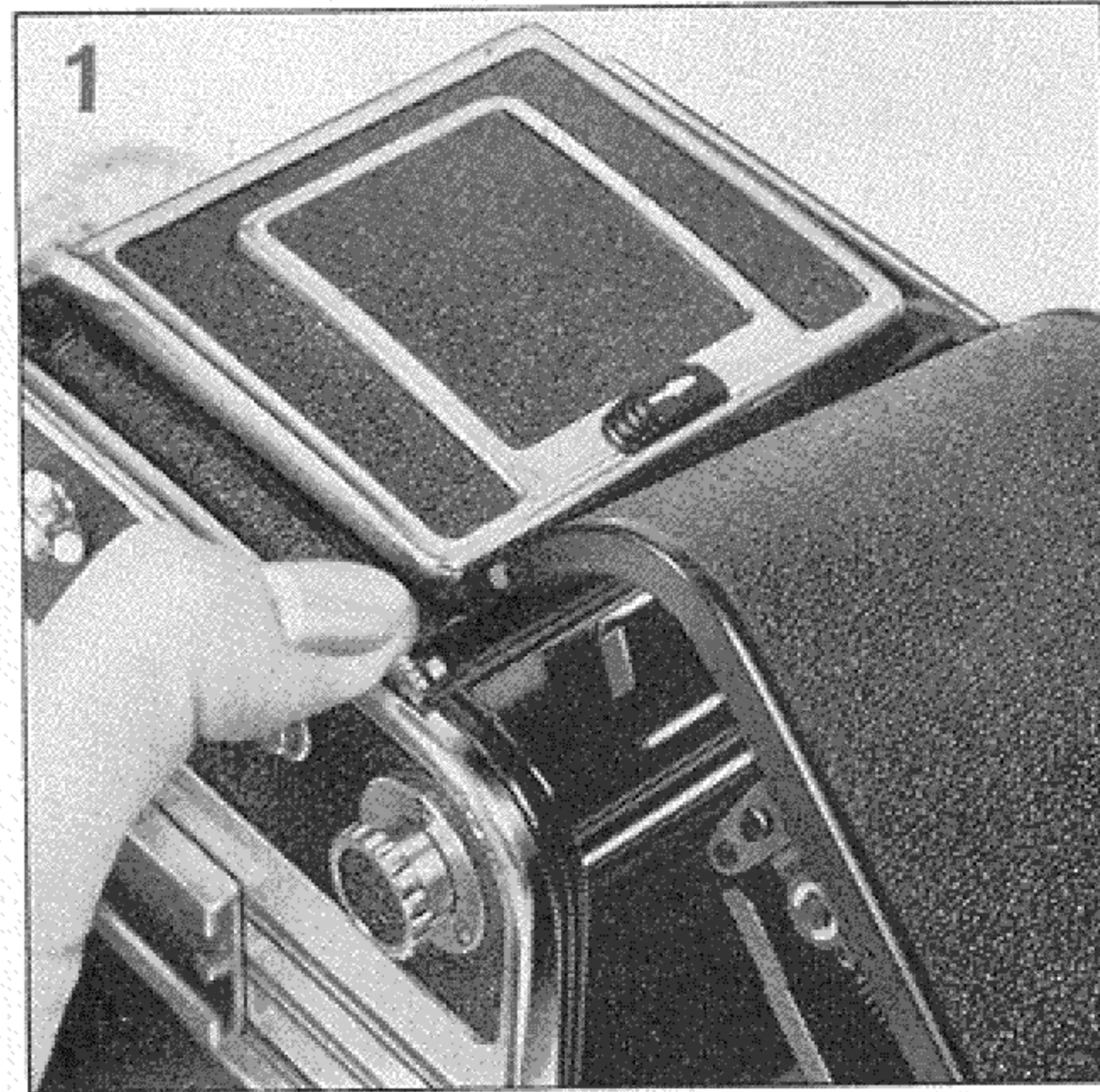

## 1. Remove the back cover

Open the back cover and move the camera back locking lever (located at the hinged top of the camera back) toward the back of camera. Detach the camera back. Reverse the order to replace the camera back.



## 2. 120 and 220 roll films

120 roll film provides 12  $2\frac{1}{4} \times 2\frac{1}{4}$  exposures; 220 roll film provides 24 exposures of the same size. 120 type film has backing paper running its full length. 220 has paper leaders attached to the beginning and end of the film, thus saving space and allowing 24 exposures to fit the spool. Other than the number of exposures, however, a given film type will be identical in all ways, be it 120 or 220.



※ If the film you are using does not have an "end of roll" warning, make your own indication (a crease or fold) on the film so that you will not accidentally re-expose the film.

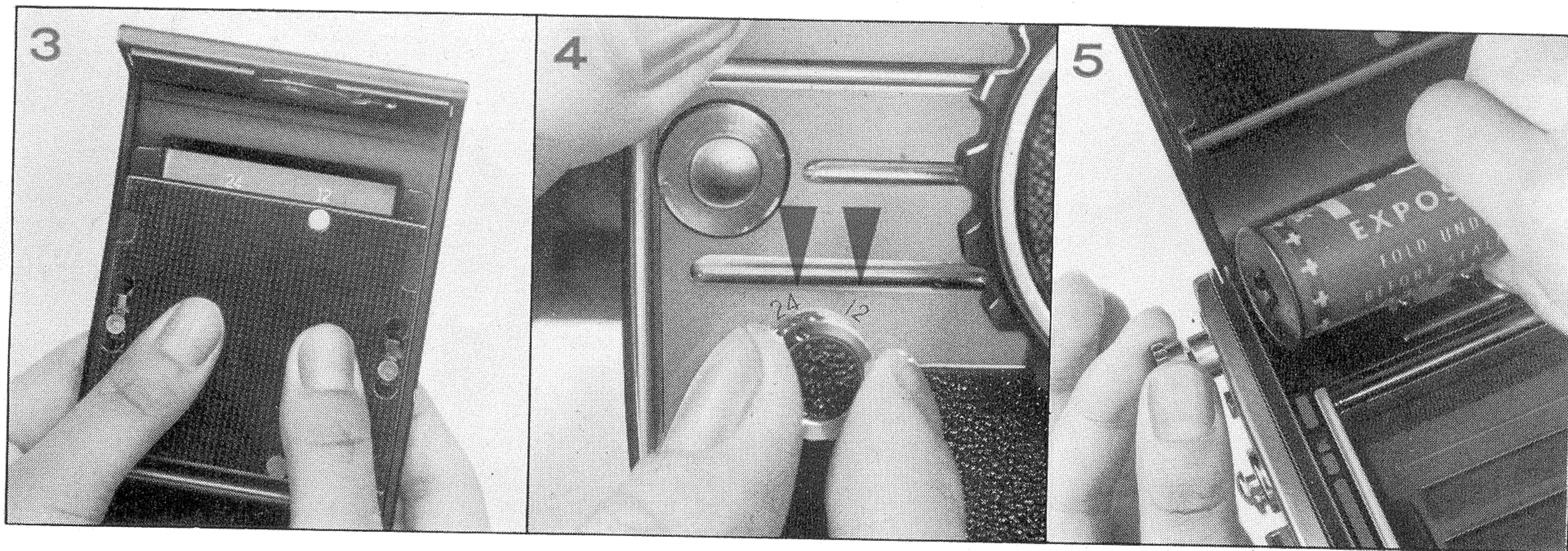

### 3. Position the pressure plate for 120 or 220 film

To remove the plate, press it in, slide it down and lift it out.

For 120 film, align the yellow dot with the yellow "12". For 220 film, align the red dot with the red "24". Then replace the plate.

### 4. Set the frame counter for 120 or 220 film

Pull out the 12/24 frame counter selection button, align the dot with the "12" or the "24" depending on the type of film in the camera, push the button back into position. With the 12/24 frame counter properly set, the winding knob will be automatically released when you have completed the film roll.

### 5. Removing exposed film

When you have made the last exposure (the 12th for 120 film; the 24th for 220 film), the film advance mechanism automatically releases and you can wind the remaining film onto the take-up spool. Be sure this is completed before opening the camera back. Open the camera back and carefully remove the exposed film.

Move the empty feed spool into the take-up position (top) of the film chamber. It will now serve as the take-up spool.

# OPERATING THE KOWA/SIX

\*The panel-type finder hood supplied with the Kowa/SIX allows you to take pictures at about chest level. Instructions on interchanging viewfinders are on Page 18.

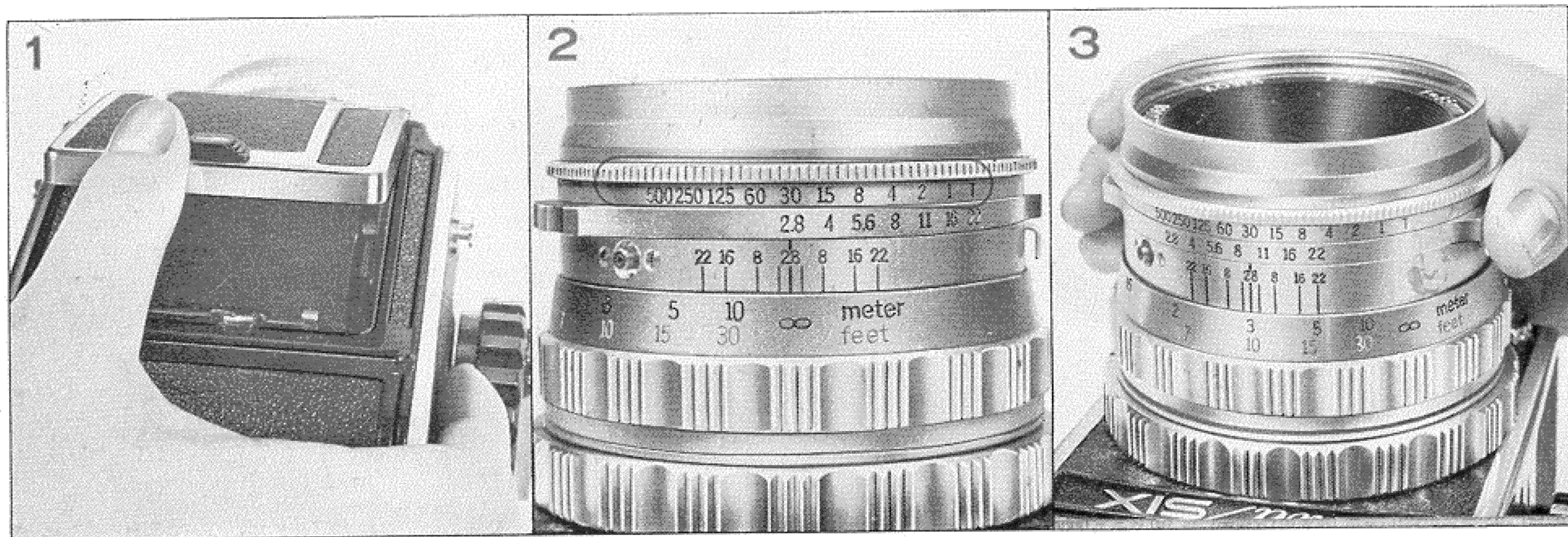

## 1. Open the finder hood

Push the finder hood/viewing magnifier release button in the direction of the arrow. The finder hood will automatically flip open. A second push of the button releases the viewing magnifier.

To close the finder hood, depress the viewing magnifier until it locks into position. Next, fold the right and left finder panels, then the rear panel. Finally, depress the front cover until it locks into position.

## 2. Set the shutter speed

Align the desired shutter speed with the index mark. The scale is geometrically calibrated and provided with a clickstop for each setting. Shutter speed may be set before or after the film is advanced.

**Note:** Do not set an intermediate (between click-stops) shutter speed. An intermediate setting may not be accurate, and there is the additional possibility of camera damage.

## 3. Set the aperture

Turn the aperture selection ring until the desired F/stop is lined-up with the index mark. Click-stops are provided at full and half F/stops.

The lens will automatically stop-down to the selected F/stop when the shutter is released.

\*It is advisable to use small apertures in infra-red photography. In most circumstances, the added depth-of-field will compensate for possible focusing error. Depth of field increases as the lens is stopped down (aperture selection ring moved to higher numbered F/stops).

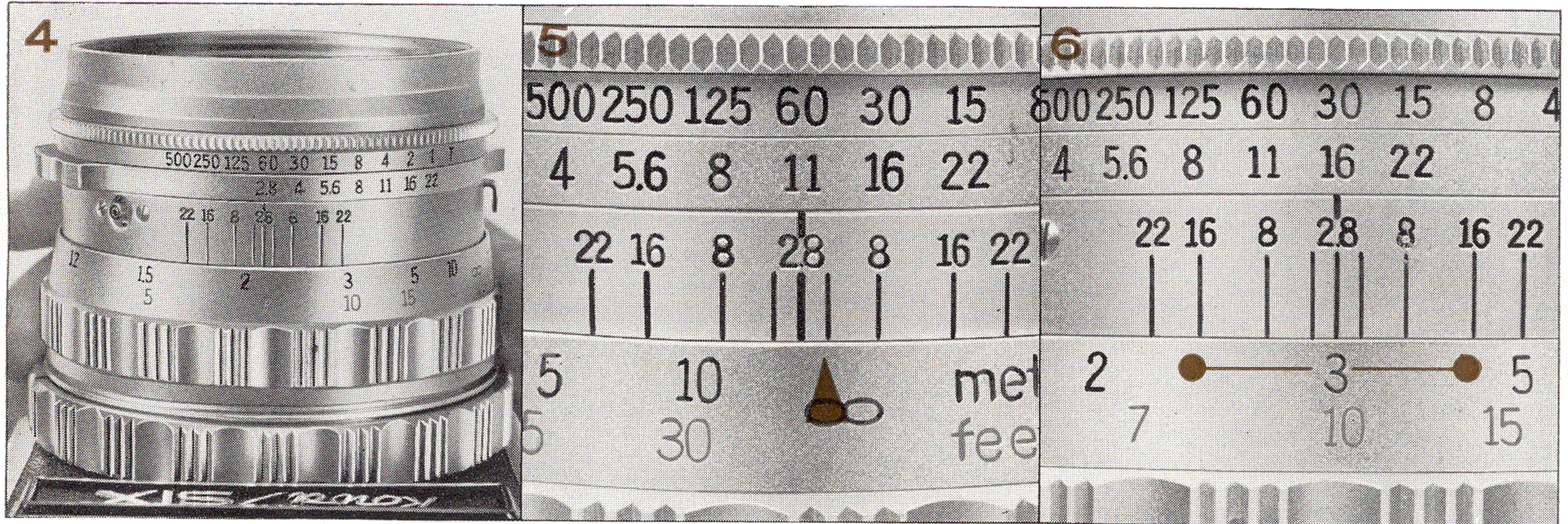

#### 4. Focusing

Turn the focusing ring until the image on the viewing screen appears sharp. With all viewing screens (unless instructions for a specific screen state otherwise), critical focusing should be done with the center spot.

For less critical focusing, the distance may be estimated and set on the distance scale. To measure film to subject distance (applicable in some close-up applications) measure from the  $\phi$  mark on the camera. This mark indicates the film plane.

#### 5. Focusing for infra-red photography

It is always necessary to compensate for the different wavelength sensitivity of infra-red film. To do this, focus as usual. Then move the distance indication which has been aligned with the index mark to the red line on the depth-of-field scale (as shown in the above picture). Generally, an R2 or O2 filter is used for infra-red work.

#### 6. Depth of Field Scale

You can make an approximate check by looking at the depth-of-field scale on the lens barrel. For an approximate check, use the depth-of-field scale on the lens barrel. The picture shows depth-of-field at F/16, 3 meters (10 feet 2 inch).

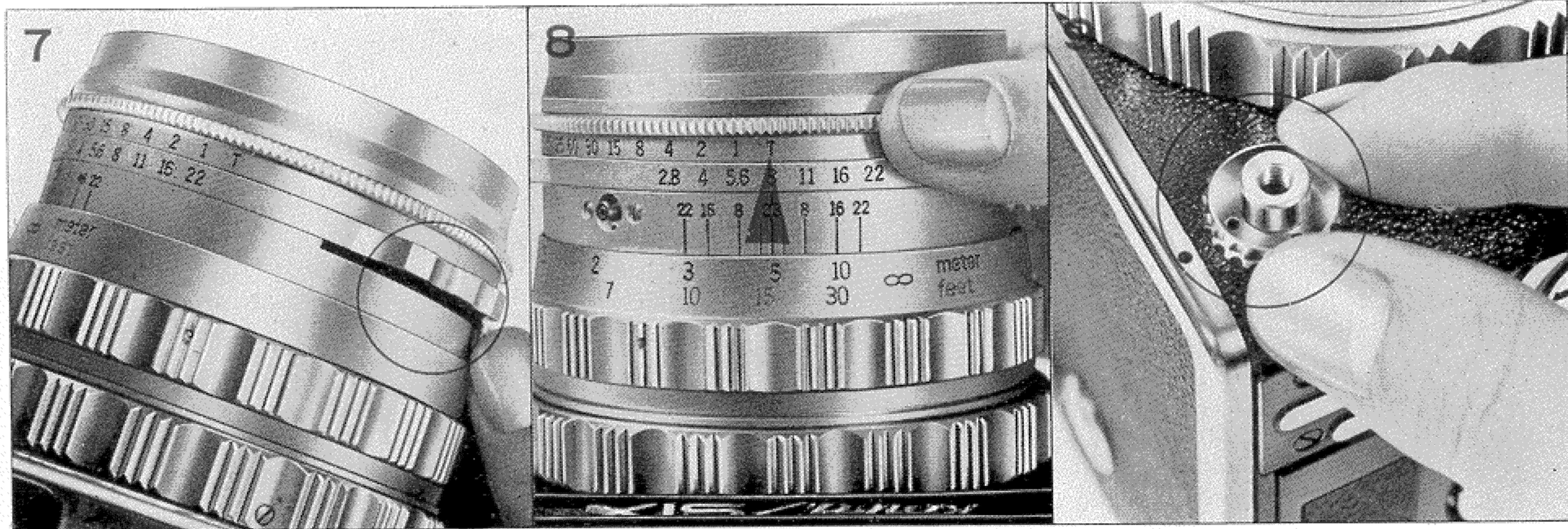

### 7. Depth-of-field previewing

Because your Kowa/SIX is a single-lens reflex camera, you can visually check depth-of-field at taking aperture on the viewing screen. To accomplish this, depress the depth-of-field preview lever after you have selected the  $F$ /stop you will shoot with. The diaphragm will close down to that  $F$ /stop. The image on the viewing screen will give you a good indication of your depth-of-field.

### 8. Time exposure (T)

For a time exposure of whatever duration you wish, align the "T" on the shutter speed selection ring with the index mark. When the shutter-release button is pressed, the shutter will remain open until you turn the shutter speed ring to the "1" position. The shutter will then close-down.

### 9. Shutter-release button lock

To lock the shutter-release button, turn the shutter-release lock ring, aligning the red dot on the ring with the red dot on the camera. To unlock the shutter, align the green dot on the shutter-release lock ring with the red dot on the camera.

It is advisable to lock the shutter-release button whenever the camera is loaded with film and not being used.

# Flash Synchronization Settings

Type of Flash	Setting	M	X (V)
M Class Bulbs		Synchronized at all shutter speeds.	Synchronized at shutter speeds of 1/30 sec. or less.
Electronic Flash		Not synchronized	Synchronized at all shutter speeds.

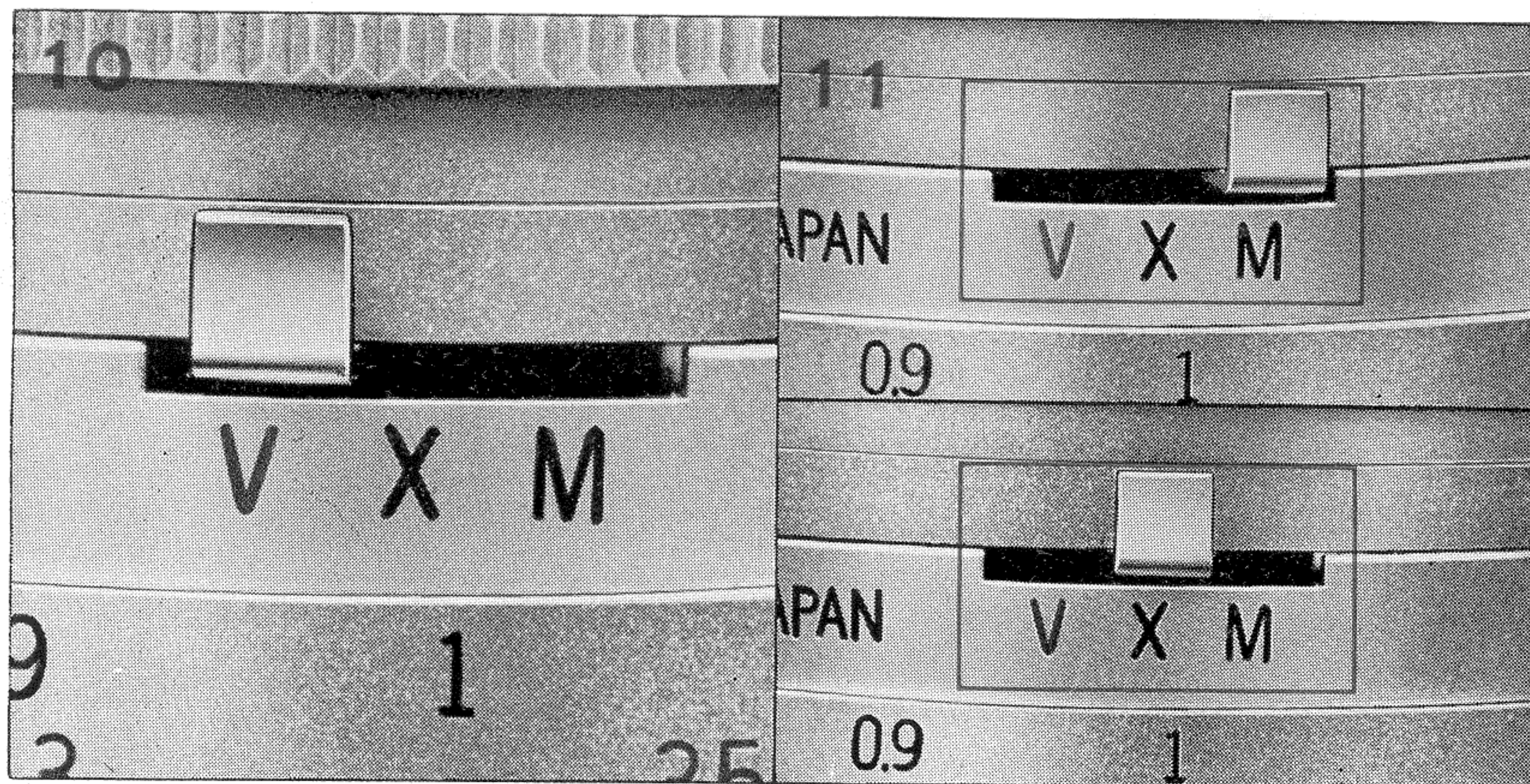

## 10. Self-timer

For a delayed shot, place the M/X flash synchronization and self-timer lever in the "V" position, make appropriate settings, and press the shutter. The self-timer will release the shutter in about 10 seconds.

**Note:** When the lever is released, the diaphragm automatically reopens.

## 11. Flash synchronization setting selection

The Kowa/SIX, because of its between-the-lens leaf-type shutter, provides M and X flash synchronization at all shutter speeds. Selection is made by setting the M/X flash synchronization and self-timer lever according to the above table. Full synchronization for electronic flash is also provided at the self-timer ("V") setting.

\*While focal-plane shutter cameras synchronize with electronic flash only at lower shutter speeds (usually 1/60 of a second), your Kowa/SIX employs a leaf-shutter that synchronizes at all shutter speeds. Therefore, by using higher shutter speeds when shooting with electronic flash, you can eliminate "ghost" images.

\*You can also set the proper exposure for a combined indoor/outdoor exposure by setting the F/stop according to your electronic flash-to-subject distance, and your shutter speed according to the outdoor light reading. Therefore with the Kowa/SIX, you can shoot in a dimly lit room with electronic flash, while properly exposing a view through a window.

\*Shutter speed and aperture scales are calibrated in geometric progression. This means that a done position increase in shutter speed combined with a one F/stop increase in exposure (a lower F/stop number) would produce no change in exposure. As an example, 1/30 at F/8 is the same exposure as 1/60 at F/5.6.

\*Fine exposure adjustments are made with the aperture scale. You will find a click-stop at every half F/stop on all lenses for the Kowa/SIX.

\*Controls and couplings are in the same position on all lenses for the Kowa/SIX.

# INTERCHANGING LENSES

To remove a lens .....

To mount a lens .....

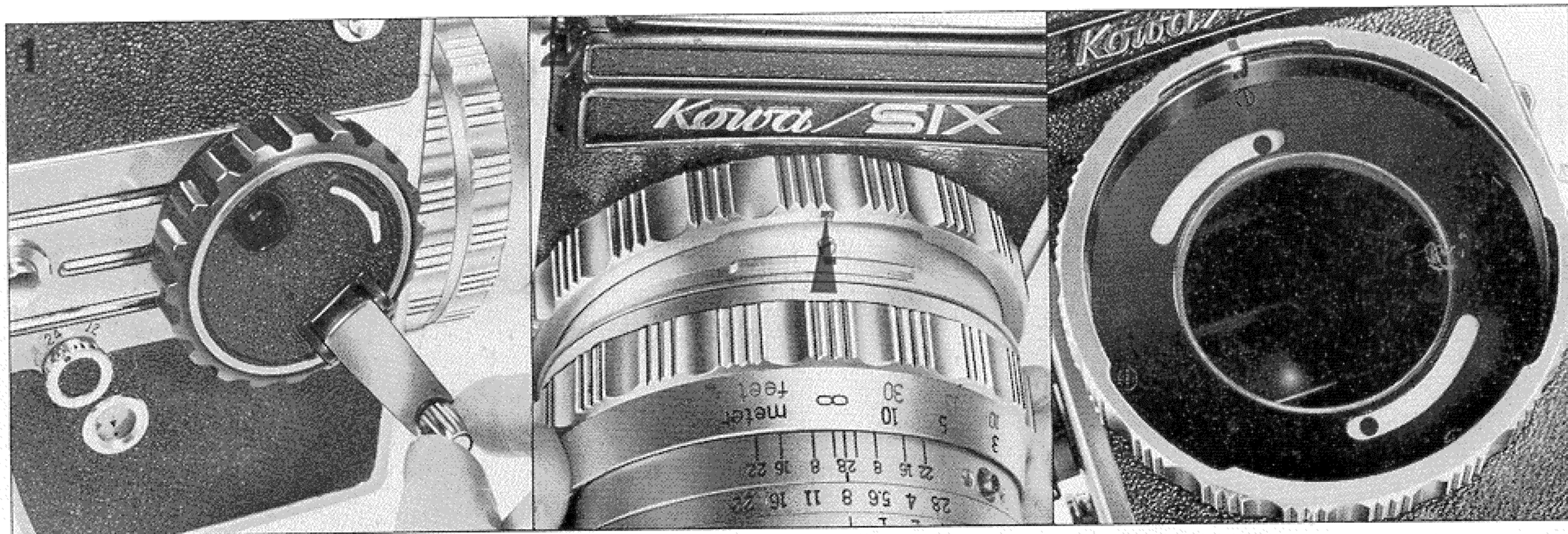

## 1. Wind the film advance

When you wind the film advance, you move the mirror and light-baffle into the viewing position and automatically disengage the lens locking collar safety. This safety system prevents removal of the lens with the mirror and light-baffle in the up position, thereby eliminating the chance of ruining a frame.

## 2. Remove the lens

Push in the lens locking lever and turn the lens locking collar counter-clockwise (with the camera facing you) until the index mark comes to a stop in a vertical position. Pull the lens straight out of the camera.

## 1. Wind the film advance

Be certain that the film advance is fully wound and that the index mark on the lens locking collar is in a vertical position.

※ The lens locking lever will automatically move to its locked position when you mount the lens. Do not block the action of the lens locking lever.



## 2. Be sure the lens is opened

When the shutter blades are open and the two pins are aligned with the red dots as shown above, the lens can be mounted. To bring the pins in line with the red dots, turn the pins as indicated by the arrow **until they click into place.**

Lenses cannot be-mounted or dismounted without properly following all described steps.

## 3. Align the lens and locking collar index marks

With the index mark on the lens barrel aligned with the index mark on the locking collar, slip the lens completely into the camera.

Be careful not to touch the small pin on the back of the lens. If you do, the shutter blades will close and the lens will not mount. If this happens, realign the pins with the red dots on the rear of the lens barrel.

## 4. Tighten the locking collar

With the lens seated in its mount, turn the lens locking collar in a clockwise position (with the camera facing you) until it stops.

Since the shutter has already been wound, you are now ready to shoot.

150mm F/3.5 telephoto

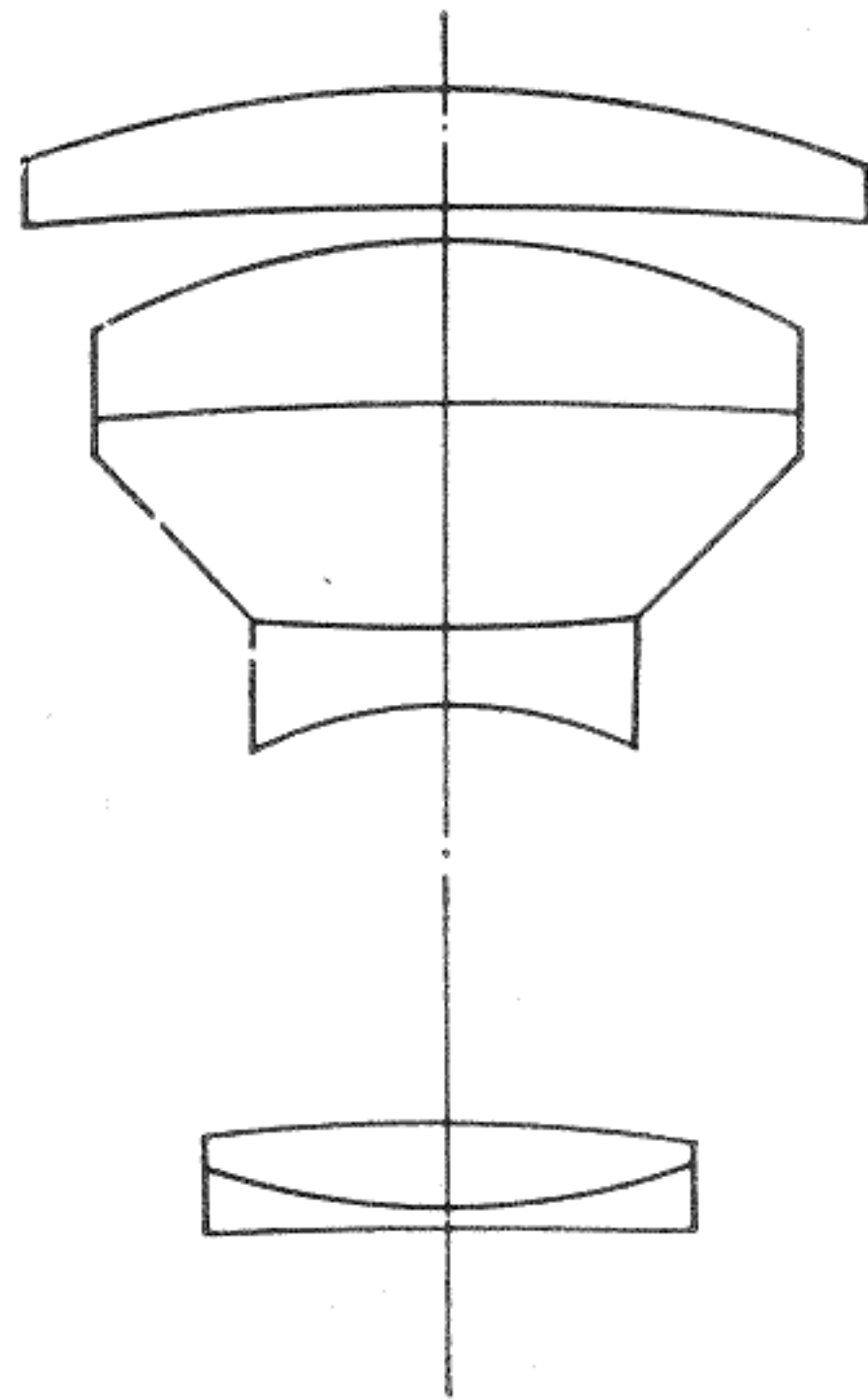
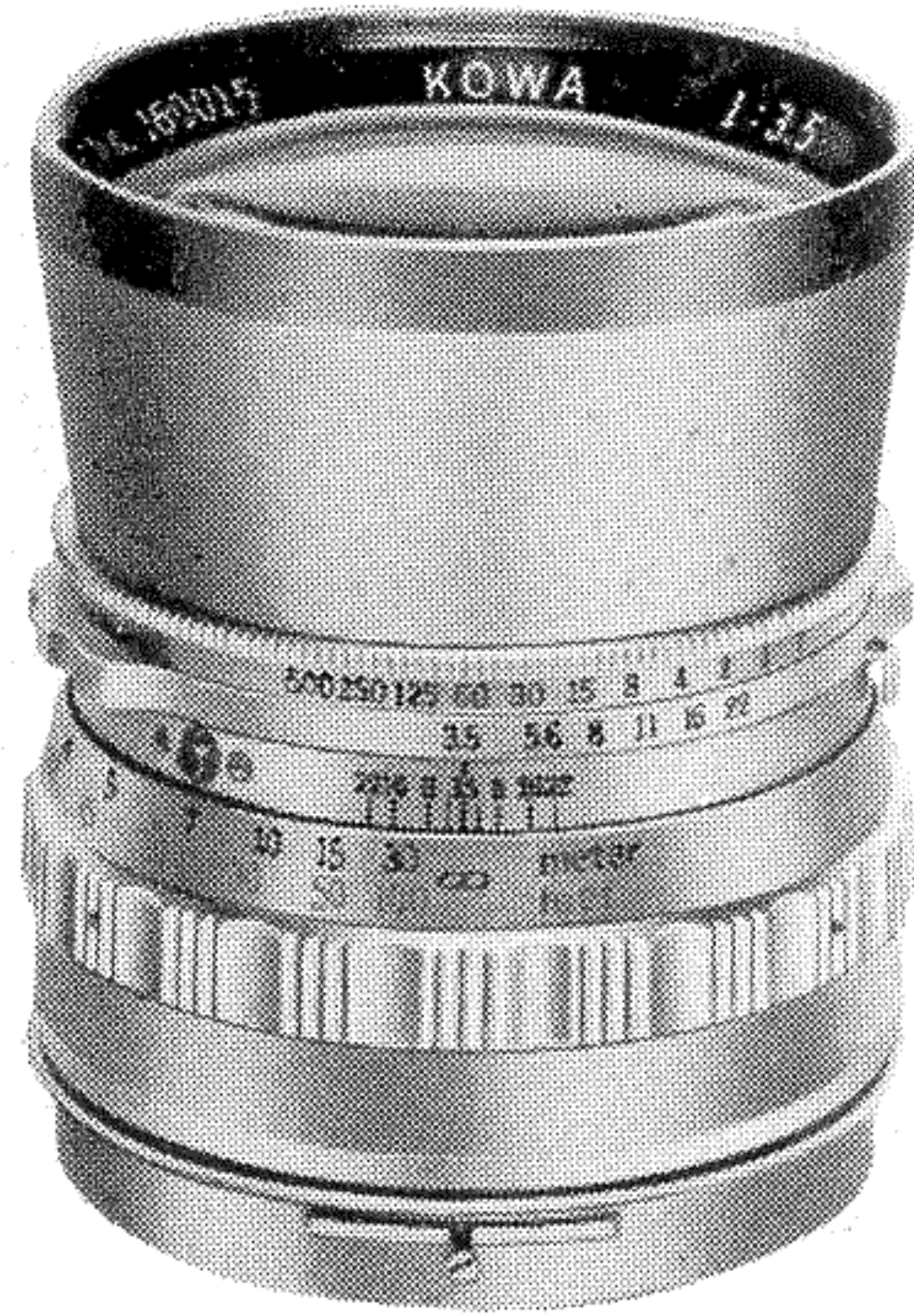

85mm F/2.8 standard

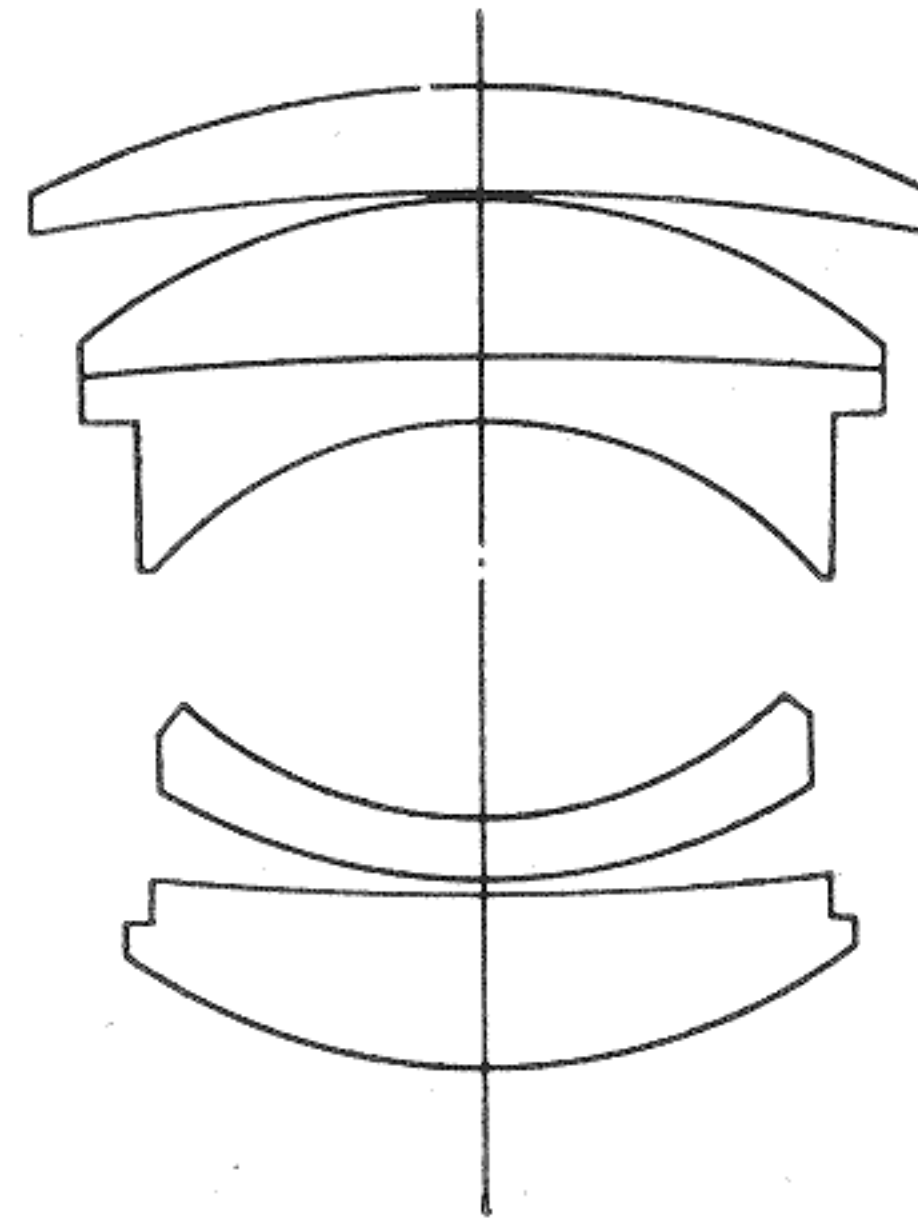

55mm F/3.5 wide-angle

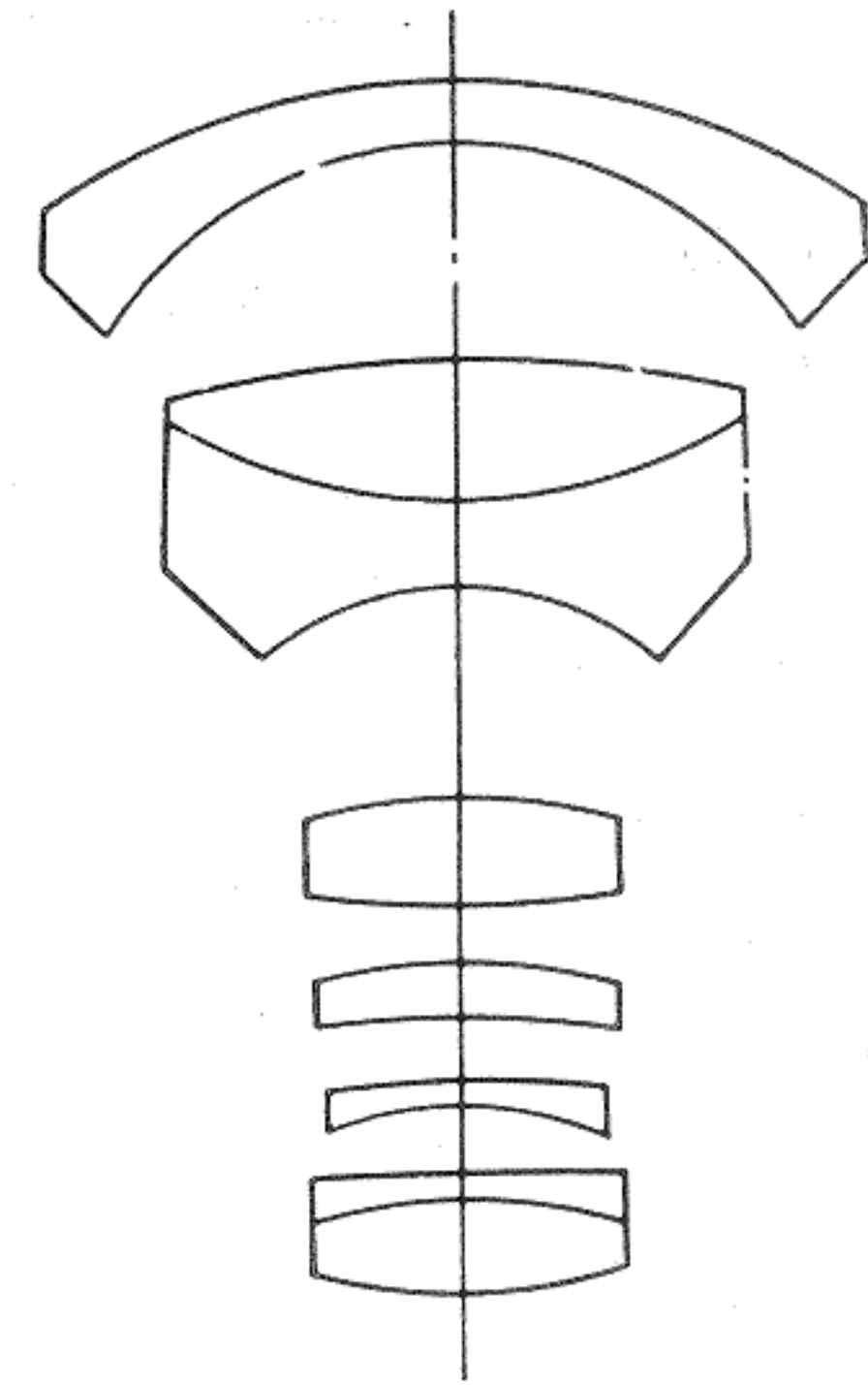
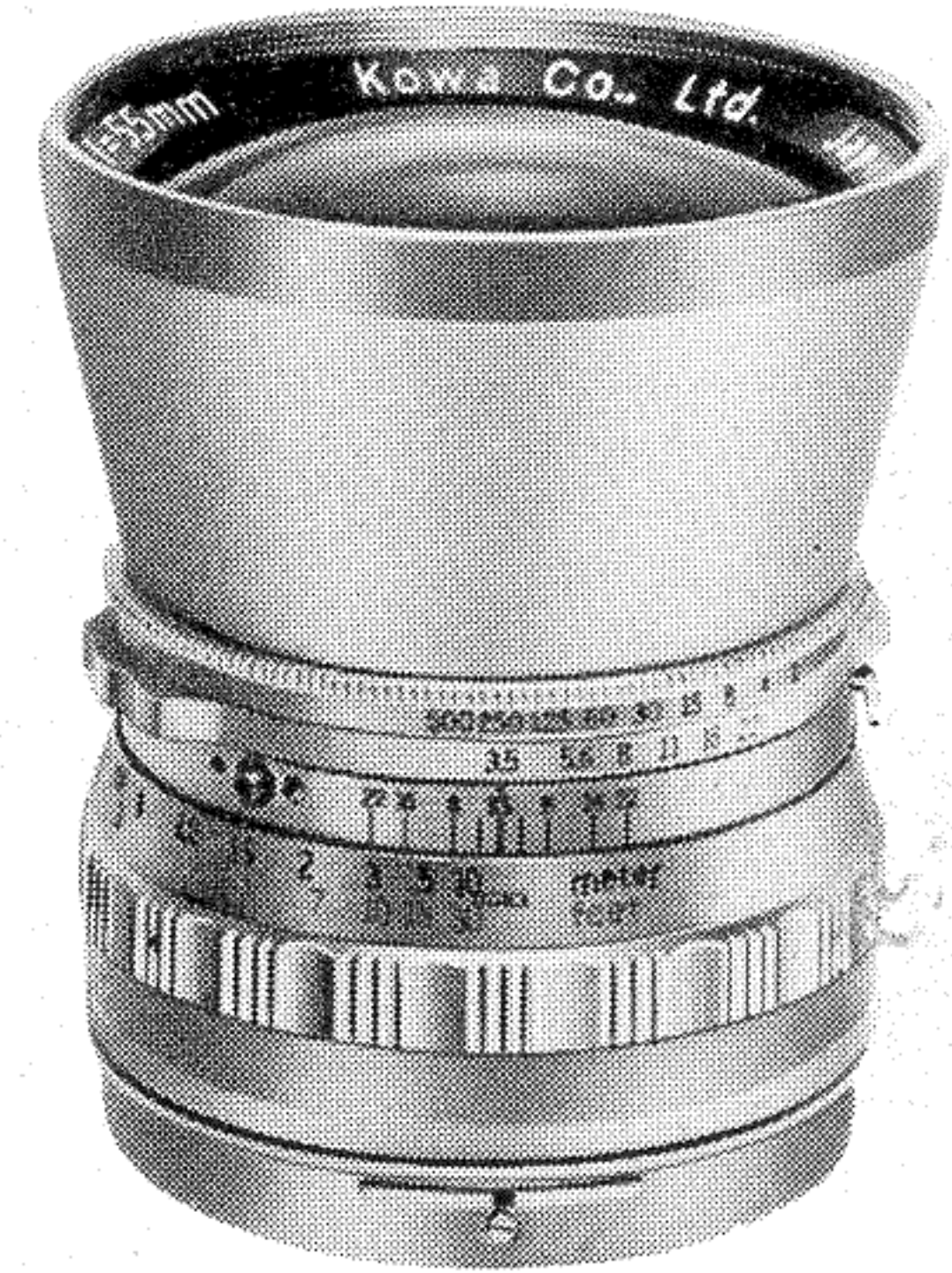



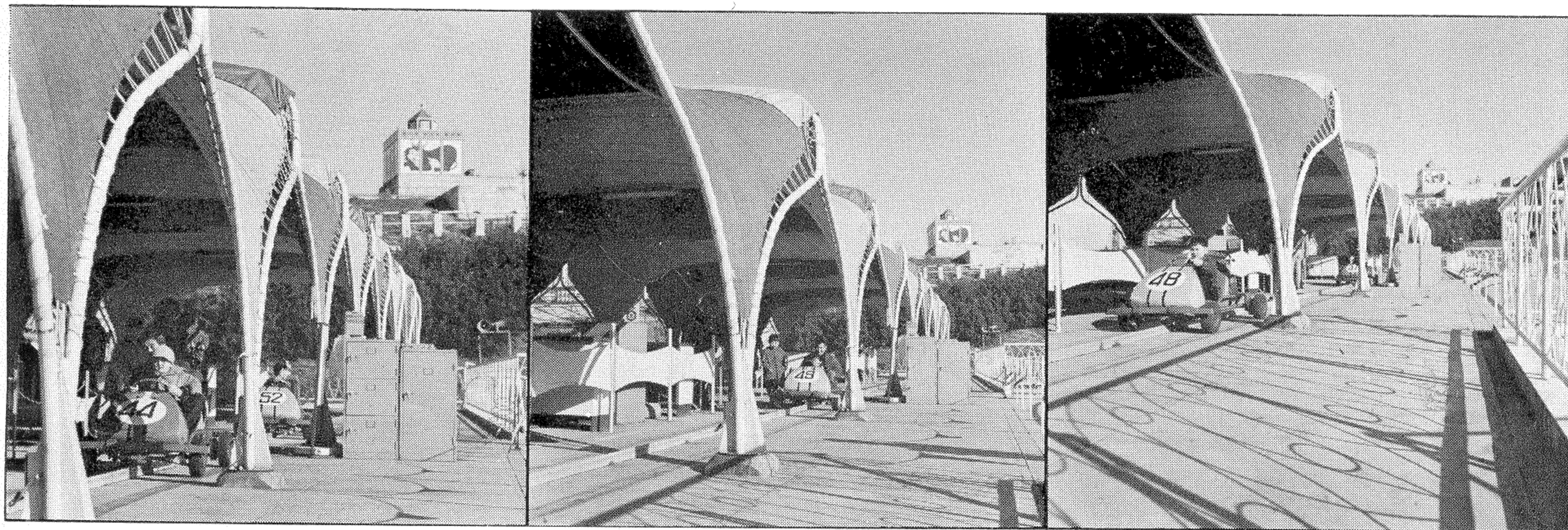

150mm

85mm

55mm

## LENS SPECIFICATIONS

Kowa Lens	Taking Angle	Minimum Aperture	Minimum Focus	Diaphragm Operation	Screw-In Filter Size	Weight
55mm F/3.5 wide angle	71.5°	F/22	1.5 ft.	fully automatic	86mm	850 gms
85mm F/2.8 standard	50°	F/22	2.5 ft.	fully automatic	67mm	530 gms
150mm F/3.5 telephoto	29.5°	F/22	5.0 ft.	fully automatic	77mm	920 gms

\* Additional lenses for your Kowa/SIX are in the development stage.

\* Each lens employs a between-the-lens leaf-type shutter, depth-of-field preview lever, and identical scale and control configuration. All have speeds from 1 to 1/500 sec., plus T, self-timer, M and X flash synchronization at all shutter speeds.

# INTERCHANGING VIEWFINDERS

All viewfinders and viewing screens for your Kowa/SIX attach and detach in seconds. To remove a viewfinder, press the button indicated in the above picture, then slide the viewfinder out toward the front of the camera. To attach a viewfinder, reverse the order.

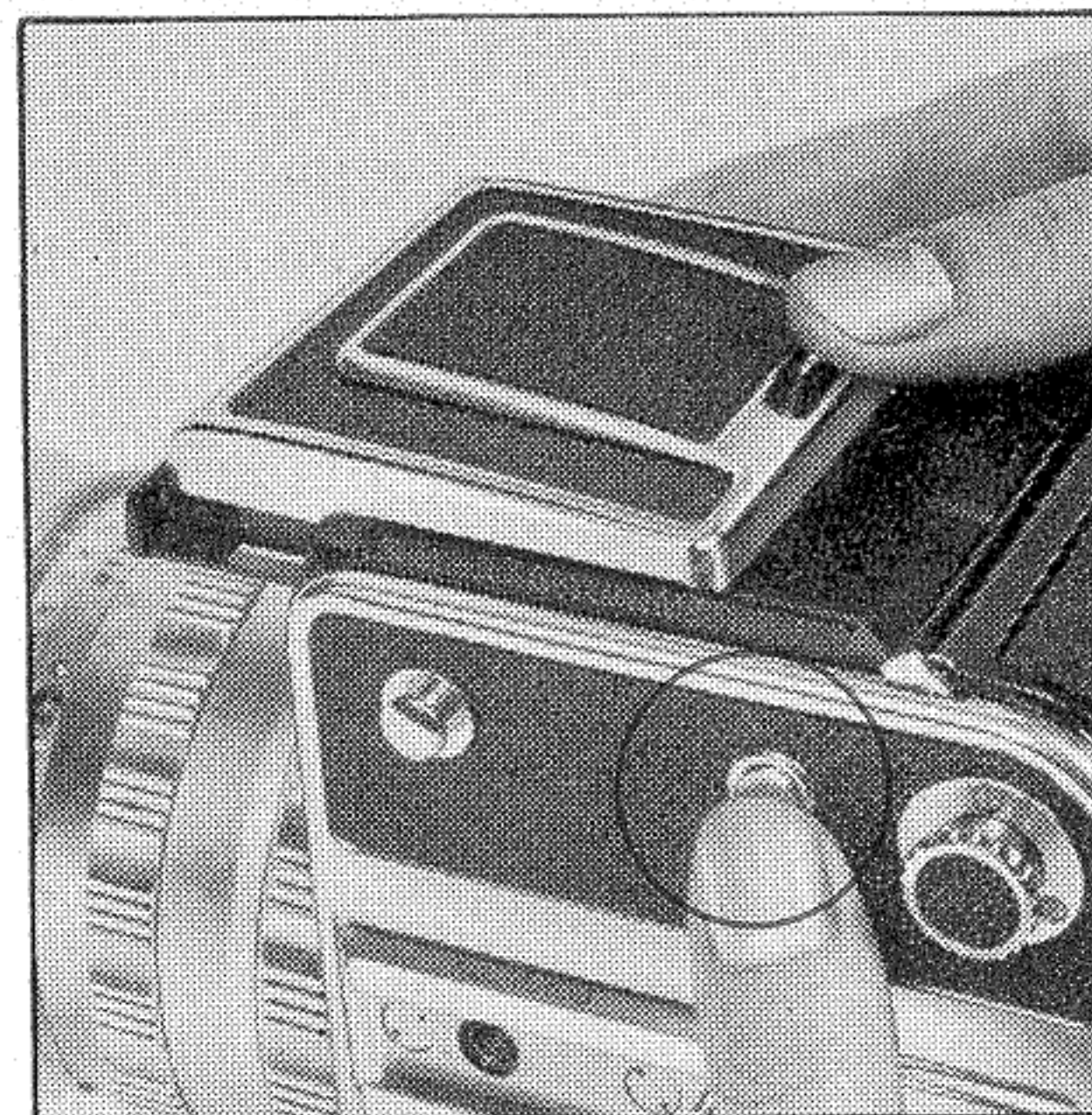

Panel-type waist-level finder hood

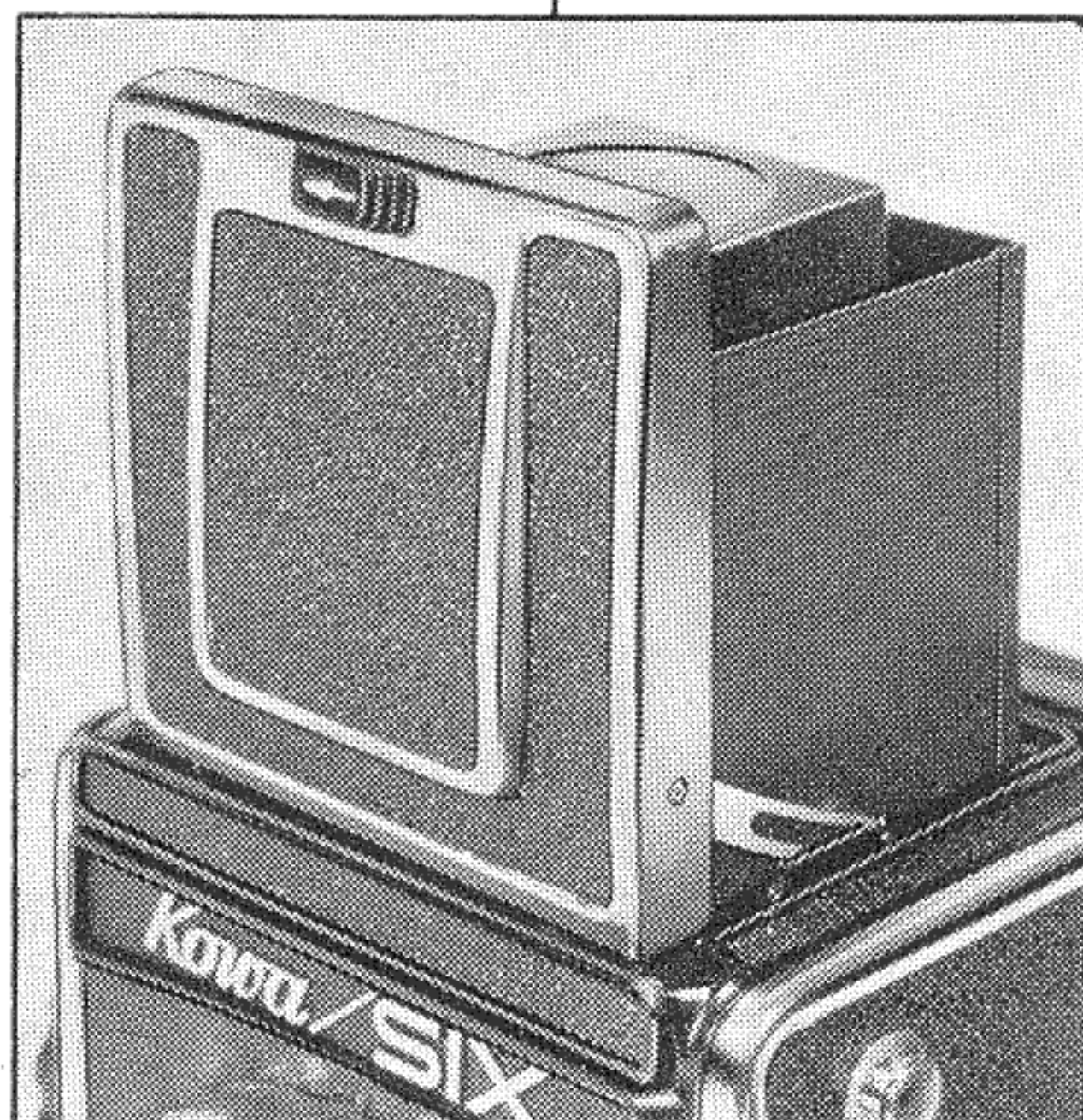

This is the panel-type waist-level finder hood supplied with the Kowa/SIX. Magnification of the image on the viewing screen is 1.2X. The light shading plates and viewing magnifier conveniently flip into place by pressing one button.

Eye-level Prism Finder, horizontal viewing

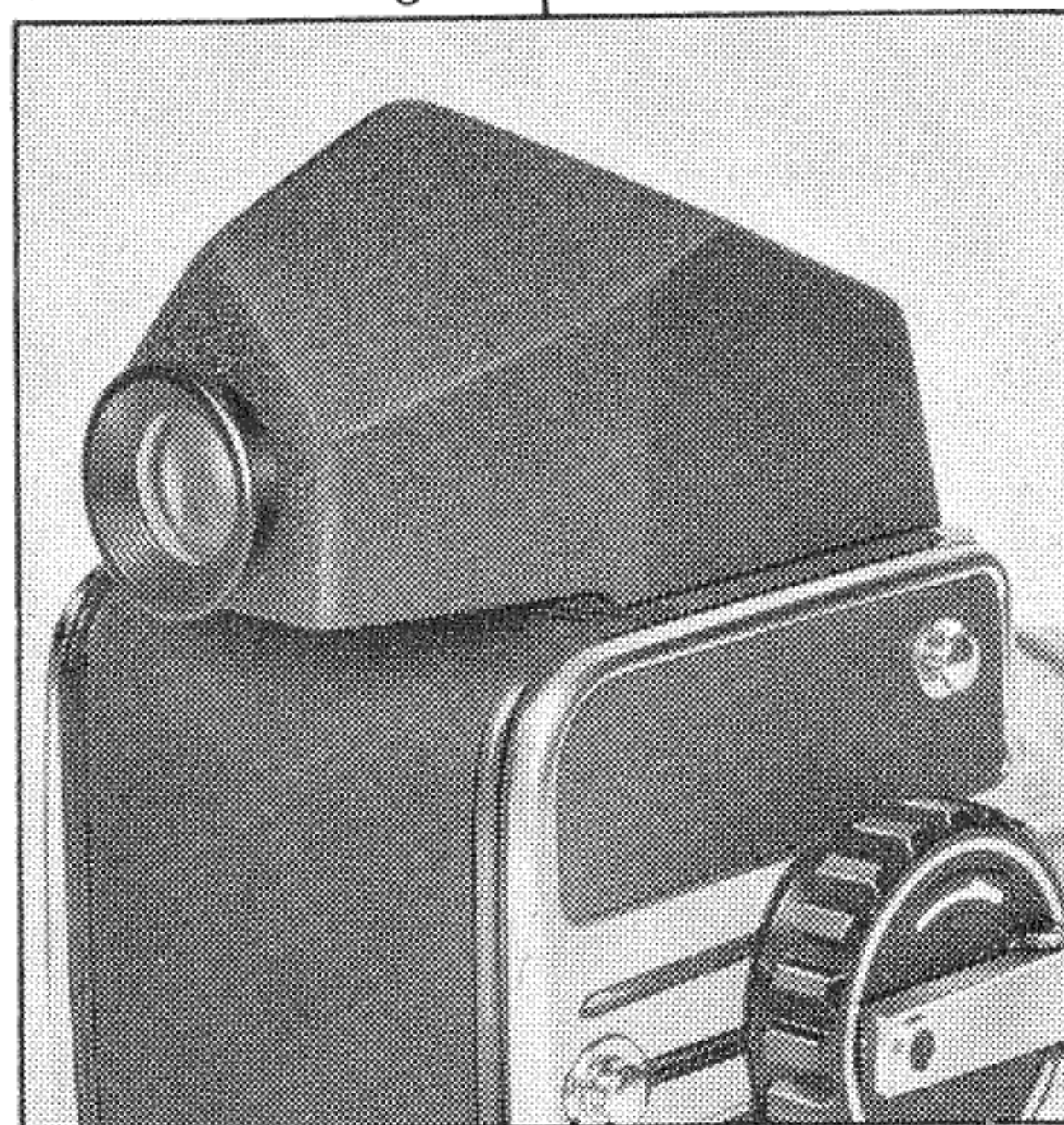

This viewfinder provides an erect, unreversed image with a magnification of 0.7X. The field-of-view ratio is 90%.

Eye-level Prism Finder, 45° viewing

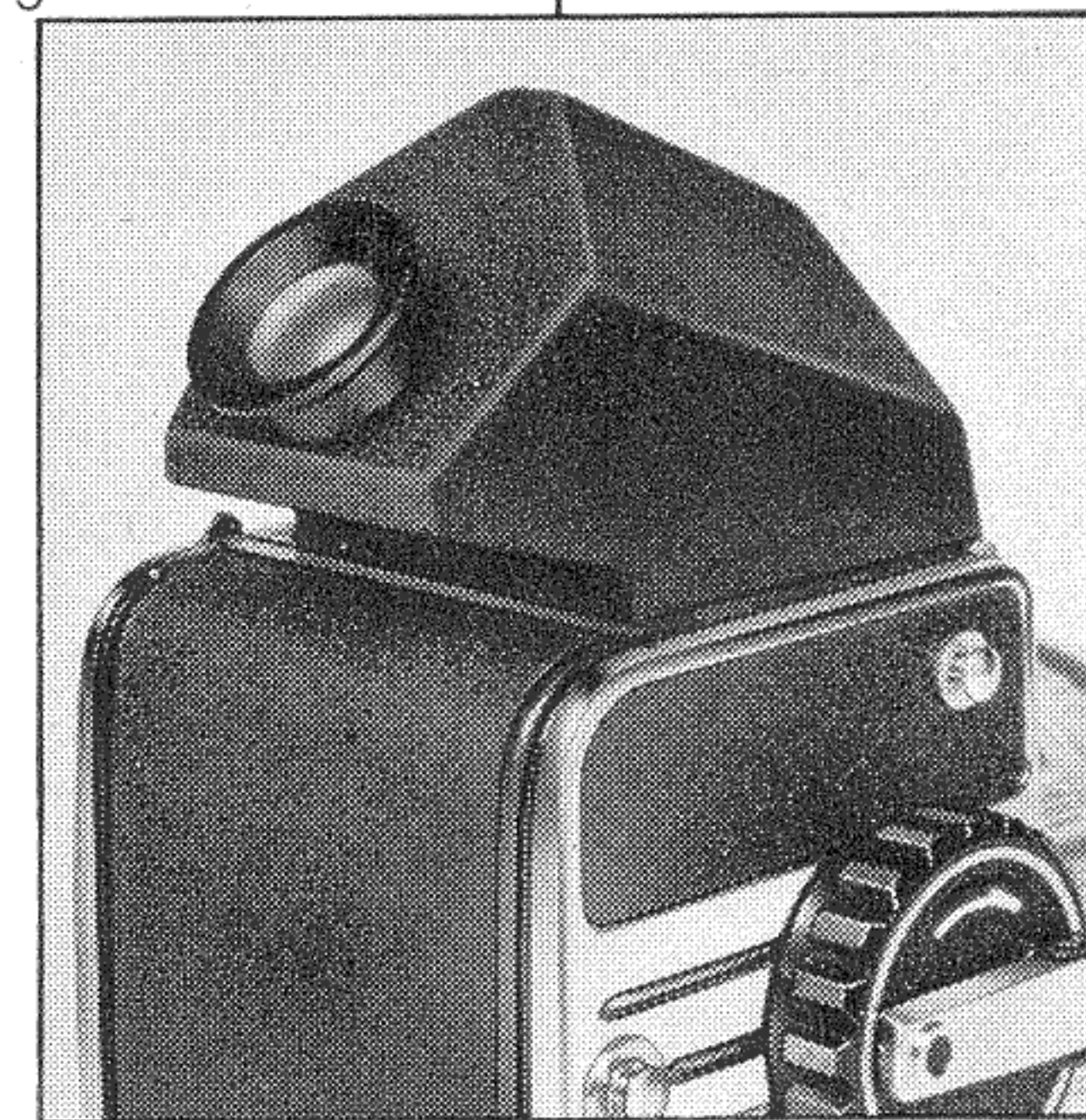

Especially useful for low-angle viewing, this viewfinder provides an erect, unreversed image with a magnification of 0.8X. The field-of-view ratio is 90%.

## Interchanging Viewing Screens

To remove a viewing screen, first remove the viewfinder (see Page 18). Then, with the camera in an over-turned position, press the interchangeable finder hood release button and the viewing screen will drop out.

It is advisable to let it drop into your cupped hand or onto a soft cloth to prevent scratching or marring of the surface.

To insert a viewing screen, hold the camera in an upright position. Bring the dot on the viewing screen in line with the dot on the camera. Then, while depressing the finder hood release button, drop the viewing screen into position.

### Standard All-purpose Viewing Screen

Supplied with your Kowa/SIX, the matte fresnel viewing screen has a 10mm fine-ground plate focusing spot in the center.

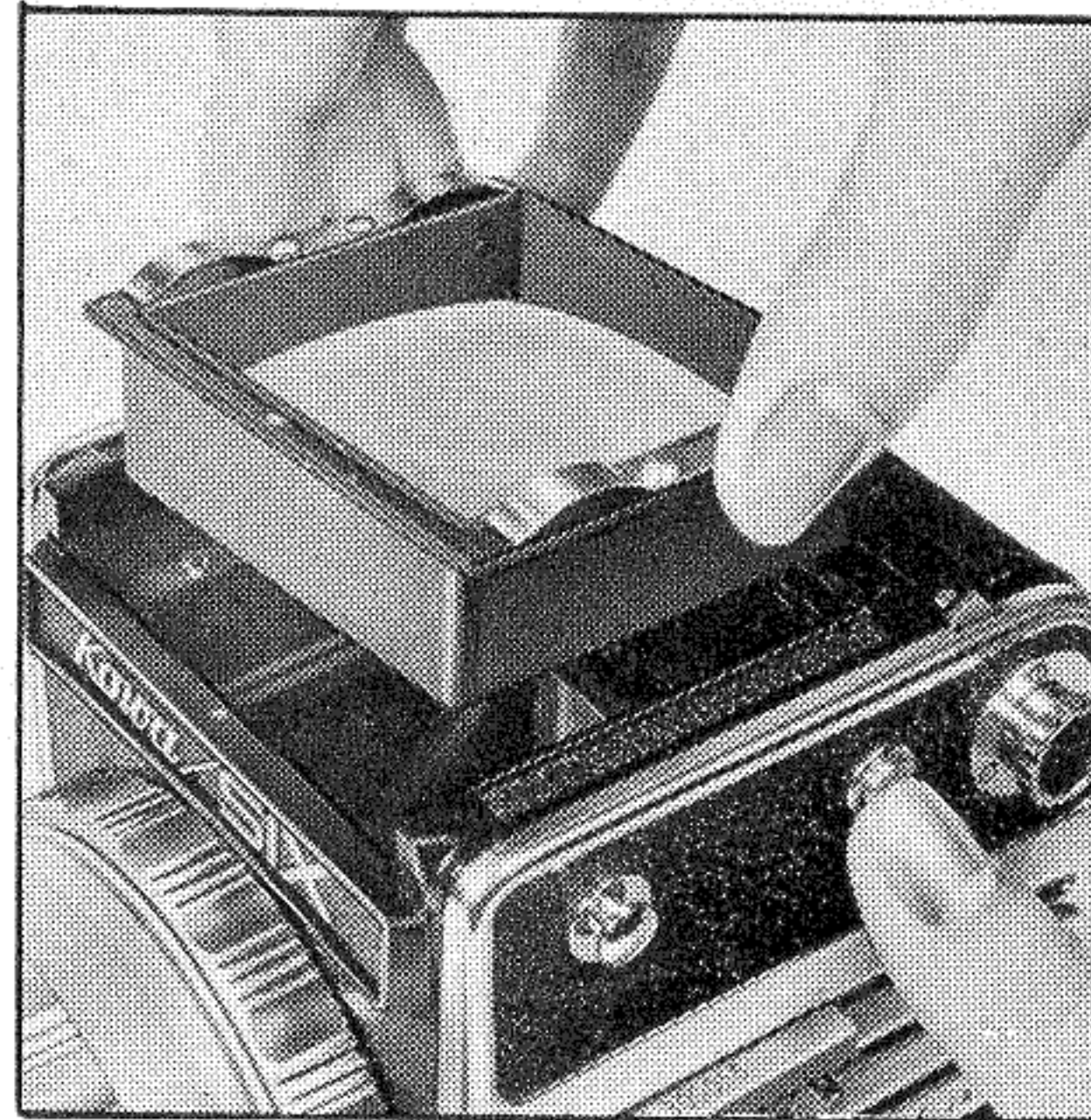

Sports Finder

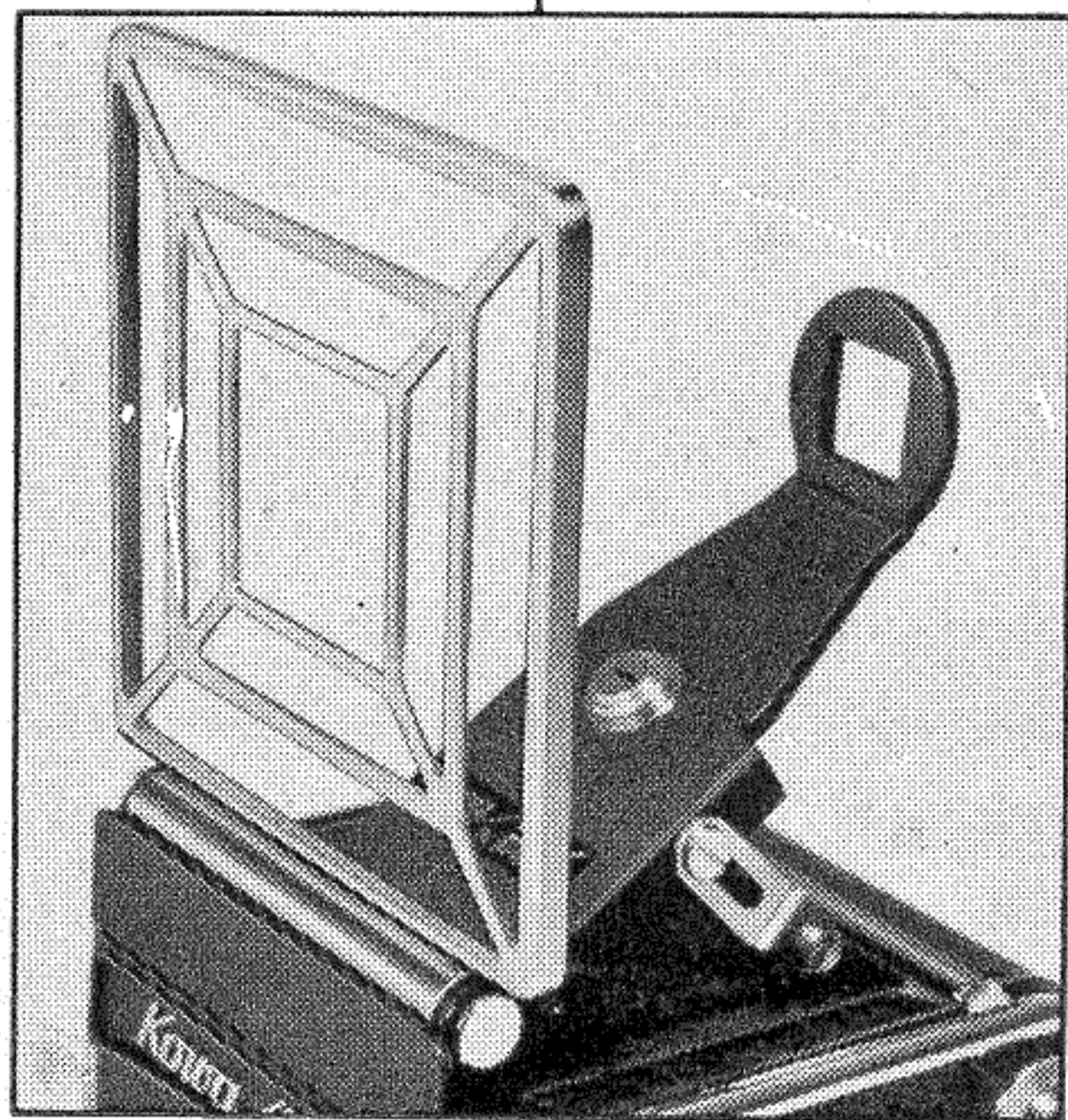

Split-image

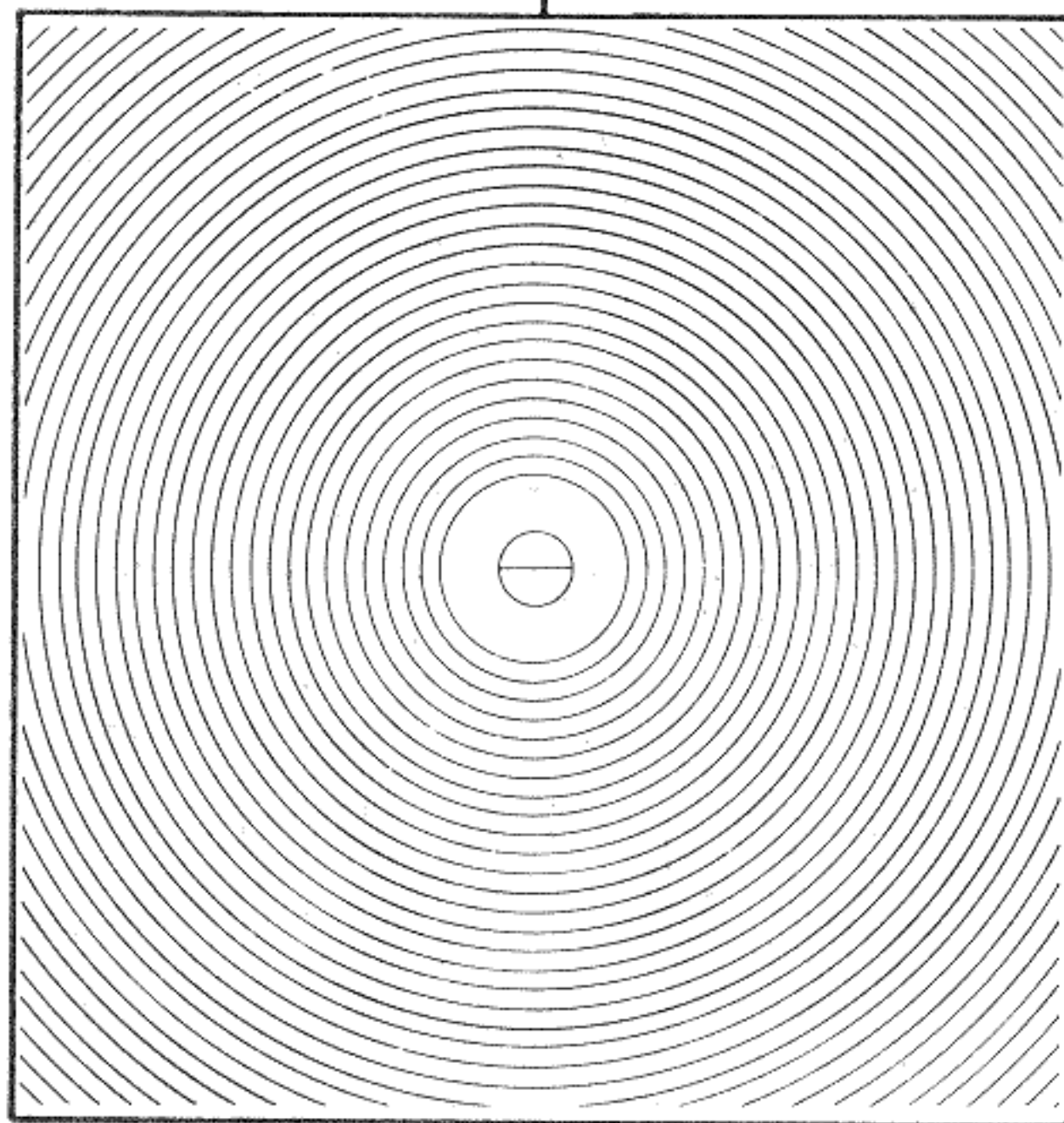

Checker-board lines

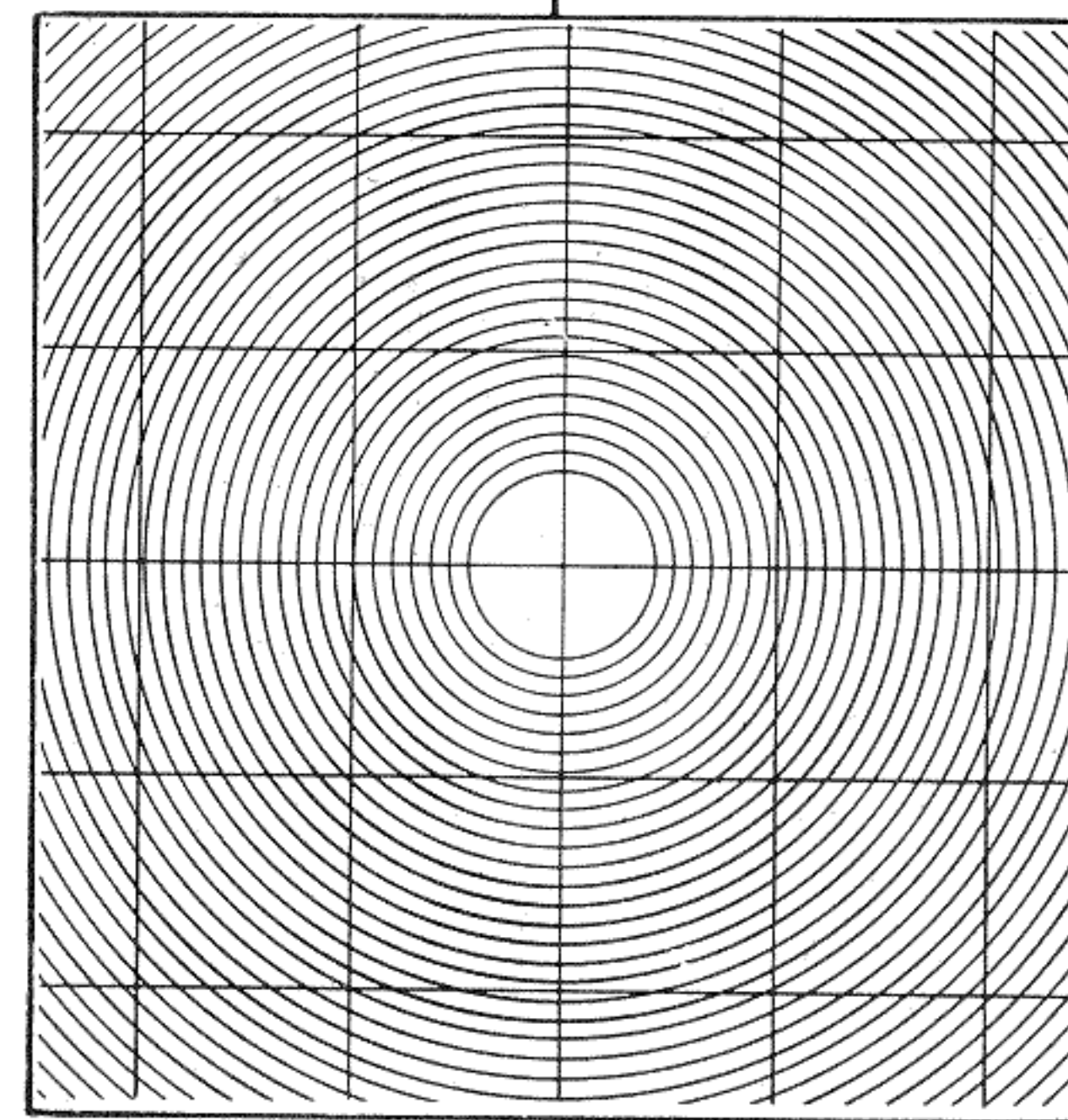

This is an open-frame flip-up type finder. It incorporates three frames for the taking angles of the 150mm telephoto, 85mm standard, and 55mm wide-angle Kowa lenses.

This is a fresnel matte viewing screen with a split-image center focusing spot.

This fresnel matte viewing screen has engraved vertical and horizontal reference lines and a fine-ground plate focusing spot in the center.

# HOW TO USE KOWA/SIX ACCESSORIES

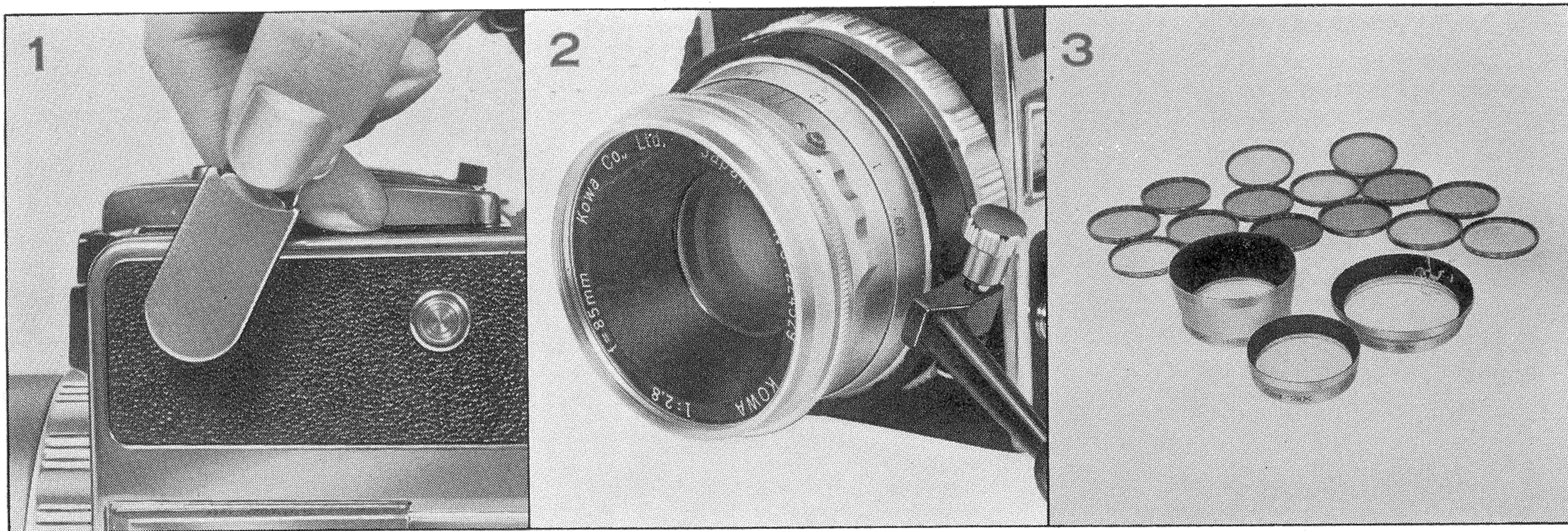

## 1. Attaching and detaching neck straps

Front and rear strap studs are provided on your Kowa/SIX. To attach a strap, place the eye of the strap tip over the stud and pull the strap. To remove the strap, press the spring plate on the strap tip, push it out and pull the strap out.

## 2. Focusing Handle

The Focusing Handle is a lever used when fast focusing action is important. It attaches to all Kowa/SIX lenses around the focusing ring.

## 3. Lens Hoods and Filters

A snap-on lens hood with a retaining screw is provided for each type of lens. Color, black and white, and special purpose filters are also available. Sizes of the screw-in filters are 67mm for the standard lens, 77mm for the telephoto, and 86mm for the wide-angle.

#### 4. Hand Grip

Ideal for extra steadiness in hand-held shooting, the Sports Grip attaches to the accessory shoe on the camera. It has its own accessory shoe, a cable release which attaches to the shutter release button on the camera, and a shutter release button with a lock.



#### 5. Tripod Head

The Tripod Head gives you added camera stability. It attaches to the base of the camera and the combined camera/Tripod Head is then attached to a tripod. With the Tripod Head, you can change film with the camera still mounted on the tripod.

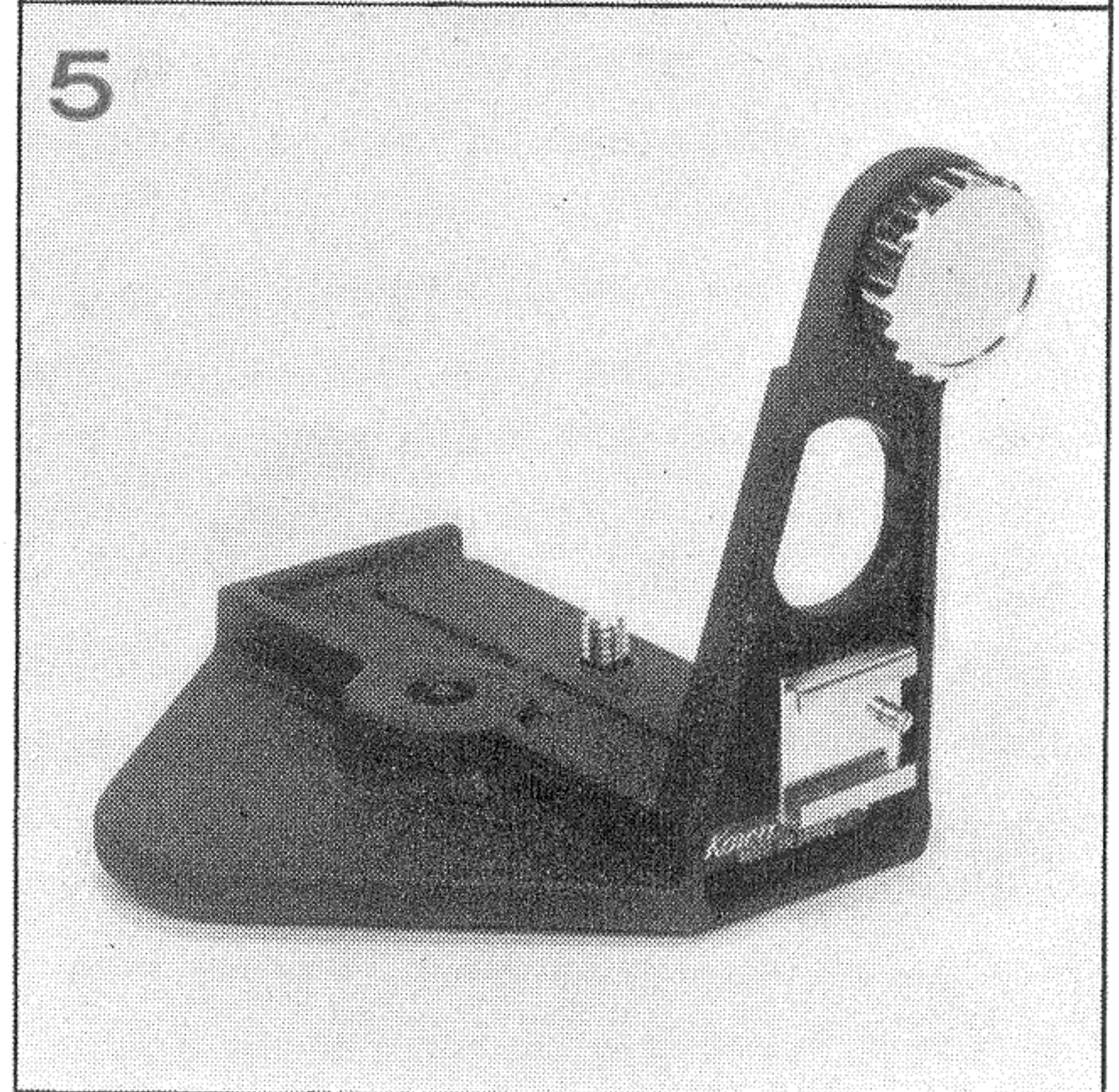

# CLOSE-UP PHOTOGRAPHY WITH EXTENSION TUBES

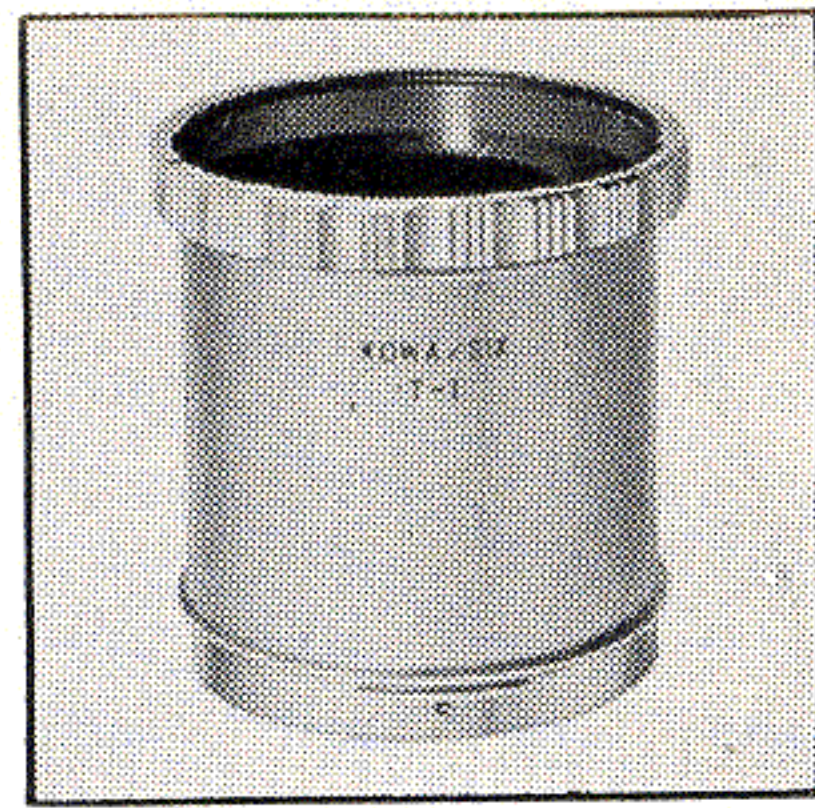

Kowa extension tubes T1, T2, and T3 may be used separately or in any combination. Full automatic lens operation is not affected by the extension tubes.

When using extension tubes, the speed of the lens is effectively reduced because of the greater distance the light must travel within the camera to reach the film plane. This effective F/stop reduction increases as more extension tubes are added. To compensate for this effect, increase exposure according to the exposure factors given in the table.

When using the Exposure Finder, no compensation is required since the meter is effectively reading the same light that reaches the film plane.

For details on image magnification with the extension tubes, use the table at the right.

- NOTE:**
1. When using extension tubes, depth-of-field becomes extremely shallow. Focusing, therefore, becomes very critical. It is advisable to use as small an F/stop (larger F/stop number) as possible for added depth-of-field.
  2. In close-up photography, the effect of camera or subject movement is greatly magnified. Therefore, to obtain maximum sharpness, it is important to use a tripod or other support for the camera.
  3. The self-timer is an important aid in close-up photography. With the self-timer, the mirror and light-baffle flip up about ten seconds before exposure. The slight vibration of the mirror/baffle mechanism, therefore, is not present when the exposure is made.

Extension Tubes		Minimum Taking Distance			Image Magnification		
Combinations	Flange Length	55 <sup>mm</sup>	85 <sup>mm</sup>	150 <sup>mm</sup>	55 <sup>mm</sup>	85 <sup>mm</sup>	150 <sup>mm</sup>
T <sub>1</sub>	75 mm	28 <sup>cm</sup>	33 <sup>cm</sup>	63 <sup>cm</sup>	1.6 ×	1.0 ×	0.6 ×
T <sub>2</sub>	32 mm	27	37	78	0.8	0.5	0.4
T <sub>3</sub>	16 mm	30	44	95	0.5	0.3	0.2
T <sub>2</sub> + T <sub>3</sub>	49 mm	27	34	69	1.1	0.7	0.5
T <sub>1</sub> + T <sub>3</sub>	91 mm	29	34	61	1.8	1.2	0.7
T <sub>1</sub> + T <sub>2</sub>	107 mm	30	34	60	2.1	1.4	0.8

Image Magnification	0	0.2	0.4	0.6	0.8	1.0	1.2	1.4	1.6	1.8	2.0	2.2
Exposure Factor		1.4	2.0	2.6	3.2	4.0	4.8	5.8	6.8	7.8	9.0	10.2

# THE KOWA/SIX SYSTEM

---

1. Camera body only
  2. Leather case
  3. Neck strap
  4. 85mm F/2.8 standard lens
  5. 150mm F/3.5 telephoto lens with case
  6. 55mm F/3.5 wide-angle lens with case
  7. Leather case for standard lens
  8. Leather case for telephoto and wide-angle lenses
  9. Eye-level Prism Finder, horizontal viewing
  10. Eye-level Prism Finder, 45° viewing
  11. Exposure Finder
  12. Sports Finder
  13. Standard Panel-type Finder Hood
  14. Viewing Screens: plain matte, split-image, checker-board lines
  15. Extension Tubes
  16. Focusing Handle
  17. Tripod Head
  18. Hand Grip
  19. Lens Hood for standard lens
  20. Lens Hood for telephoto lens
  21. Lens Hood for wide-angle lens
  22. Filters 67mm for standard lens (for monochrome)
  23. Filters 67mm for standard lens (ND4 and for color)
  24. Filters 77mm for telephoto lens (for monochrome)
  25. Filters 77mm for telephoto lens (ND4 and for color)
  26. Filters 86mm for wide-angle lens (for monochrome)
  27. Filters 86mm for wide-angle lens (ND4 and for color)
  28. Lens cap for standard lens
  29. Lens cap for telephoto lens
  30. Lens cap for wide-angle lens
  31. Rear lens cap (fits all Kowa/SIX lenses)
  32. Lens mount cap (for camera body)
-

# DEPTH OF FIELD TABLES

## 150mm F 3.5 TELEPHOTO

Apert.(F) \ Dist. (m)	3.5	4.0	5.6	8.0	11.0	16.0	22.0
∞	∞	∞	∞	∞	∞	∞	∞
	131.17	114.78	81.98	57.39	41.74	28.69	20.87
30.00	38.79	40.49	47.09	62.35	104.94	∞	∞
	24.47	23.84	22.03	19.79	17.55	14.78	12.43
15.00	16.90	17.21	18.28	20.18	23.20	30.92	51.62
	13.49	13.30	12.72	11.95	11.10	9.94	8.83
10.00	10.80	10.92	11.34	12.04	13.04	15.15	18.80
	9.31	9.22	8.94	8.56	8.12	7.48	6.84
7.00	7.38	7.43	7.62	7.93	8.34	9.15	10.35
	6.66	6.61	6.47	6.27	6.03	5.68	5.31
5.00	5.19	5.21	5.30	5.45	5.64	5.99	6.47
	4.83	4.80	4.73	4.62	4.50	4.30	4.09
4.00	4.12	4.13	4.19	4.28	4.39	4.60	4.87
	3.89	3.88	3.83	3.76	3.68	3.54	3.40
3.00	3.06	3.07	3.10	3.15	3.21	3.31	3.45
	2.94	2.93	2.90	2.87	2.82	2.74	2.66
2.50	2.54	2.55	2.57	2.60	2.64	2.71	2.80
	2.46	2.45	2.43	2.41	2.37	2.32	2.26
2.00	2.03	2.03	2.04	2.06	2.09	2.13	2.18
	1.97	1.97	1.96	1.94	1.92	1.89	1.85
1.50	1.51	1.52	1.52	1.53	1.55	1.57	1.59
	1.49	1.48	1.48	1.47	1.46	1.44	1.42

## 85mm F 2.8 STANDARD

Apert.(F) \ Dist. (m)	2.8	4.0	5.6	8.0	11.0	16.0	22.0
∞	∞	∞	∞	∞	∞	∞	∞
	51.62	36.14	25.81	18.07	13.14	9.03	6.57
10.00	12.36	13.75	16.18	22.06	40.48	∞	∞
	8.40	7.87	7.25	6.49	5.74	4.81	4.04
5.00	5.52	5.77	6.16	6.84	7.94	10.86	19.59
	4.57	4.41	4.21	3.95	3.66	3.27	2.90
3.00	3.17	3.26	3.37	3.56	3.83	4.39	5.32
	2.84	2.78	2.70	2.60	2.47	2.29	2.10
2.00	2.07	2.11	2.15	2.23	2.33	2.52	2.79
	1.93	1.90	1.87	1.82	1.76	1.67	1.57
1.50	1.54	1.56	1.58	1.62	1.67	1.76	1.89
	1.46	1.45	1.43	1.40	1.36	1.31	1.25
1.20	1.22	1.24	1.25	1.27	1.30	1.36	1.43
	1.18	1.17	1.15	1.14	1.11	1.08	1.04
1.00	1.02	1.02	1.03	1.05	1.07	1.10	1.15
	0.98	0.98	0.97	0.96	0.94	0.92	0.89
0.90	0.91	0.92	0.93	0.94	0.95	0.98	1.02
	0.89	0.88	0.88	0.86	0.85	0.83	0.81
0.80	0.81	0.81	0.82	0.83	0.84	0.86	0.89
	0.79	0.79	0.78	0.77	0.76	0.75	0.73



# 55mm F3.5 WIDE-ANGLE

Apert.(F) Dist. (m)	3.5	4.0	5.6	8.0	11.0	16.0	22.0
∞	∞	∞	∞	∞	∞	∞	∞
10.00	17.72	15.51	11.08	7.75	5.64	3.88	2.82
5.00	22.71	27.78	97.33	∞	∞	∞	∞
3.00	6.43	6.11	5.30	4.41	3.65	2.85	2.25
2.00	6.91	7.31	8.99	13.70	40.19	∞	∞
1.50	3.92	3.80	3.47	3.07	2.69	2.23	1.85
1.20	3.59	3.69	4.07	4.80	6.22	12.30	∞
1.00	2.58	2.53	2.38	2.19	1.99	1.73	1.50
0.90	2.24	2.28	2.41	2.65	3.02	3.96	6.32
0.80	1.81	1.78	1.71	1.61	1.50	1.35	1.21
0.70	1.63	1.65	1.72	1.83	2.00	2.36	3.02
0.60	1.39	1.38	1.33	1.27	1.21	1.11	1.01
0.50	1.28	1.29	1.33	1.40	1.49	1.68	1.98
0.45	1.13	1.12	1.09	1.05	1.01	0.94	0.87
0.40	1.05	1.06	1.09	1.13	1.19	1.30	1.48
0.35	0.95	0.95	0.93	0.90	0.86	0.82	0.76
0.30	0.94	0.95	0.97	1.00	1.05	1.14	1.26
0.25	0.86	0.86	0.84	0.82	0.79	0.75	0.71
0.20	0.83	0.84	0.85	0.88	0.91	0.98	1.07
0.15	0.77	0.77	0.75	0.73	0.71	0.68	0.64
0.10	0.72	0.73	0.74	0.76	0.78	0.83	0.89
0.05	0.68	0.67	0.66	0.65	0.63	0.61	0.58
0.02	0.62	0.62	0.63	0.64	0.66	0.69	0.73
0.01	0.58	0.58	0.57	0.56	0.55	0.53	0.51
0.005	0.51	0.51	0.52	0.53	0.54	0.56	0.58
0.002	0.49	0.49	0.48	0.48	0.47	0.45	0.44

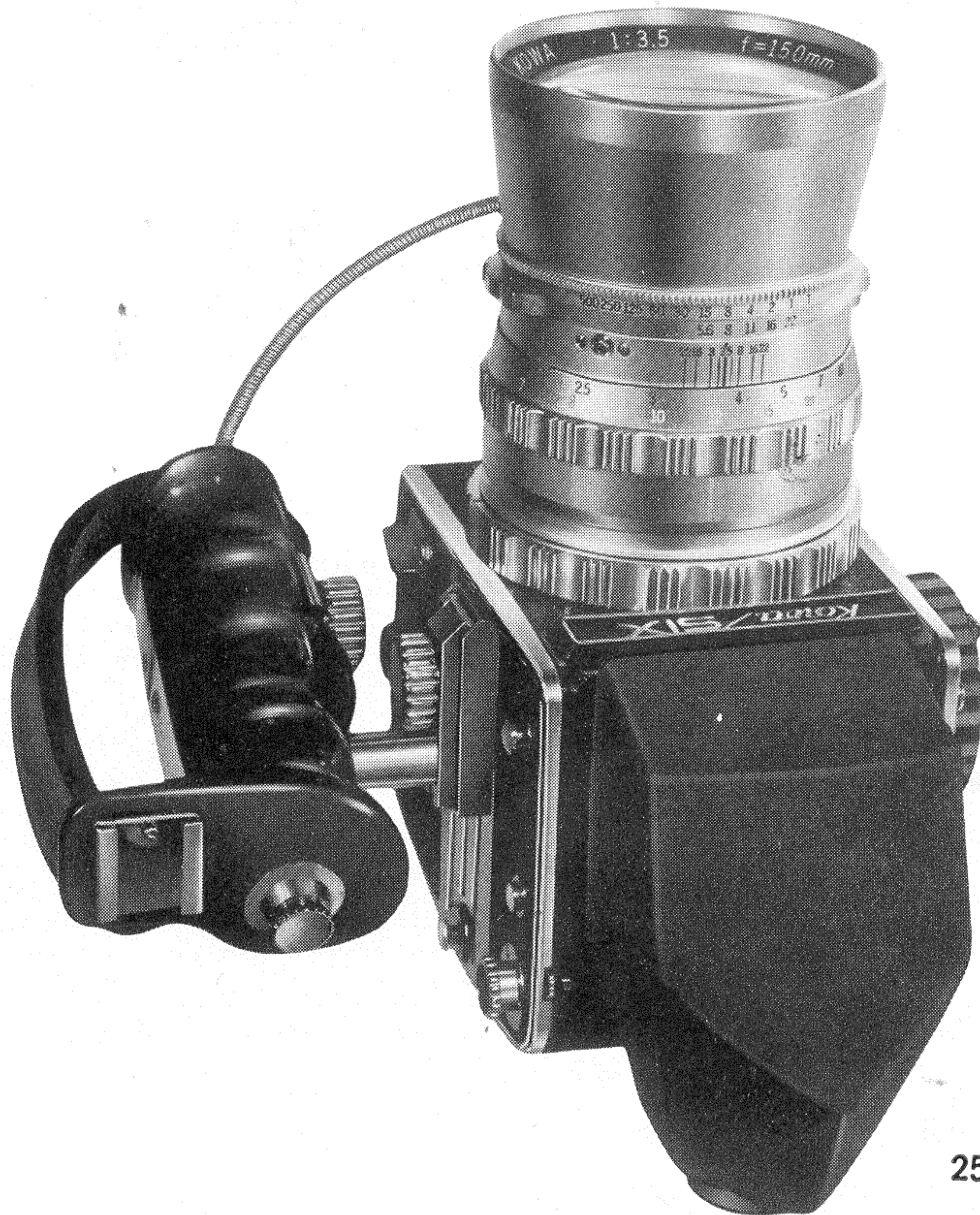

# SHUTTER MECHANISM OPERATION

When you press the shutter-release button on your Kowa /SIX, a complex series of events occur with incredible precision. The mirror and light-baffle swing out of the light path while the diaphragm closes to the F/stop you selected. The leaf shutter then exposes the film at the speed you chose. All of this happens in an instant, and with virtually no vibration at the moment of film exposure.

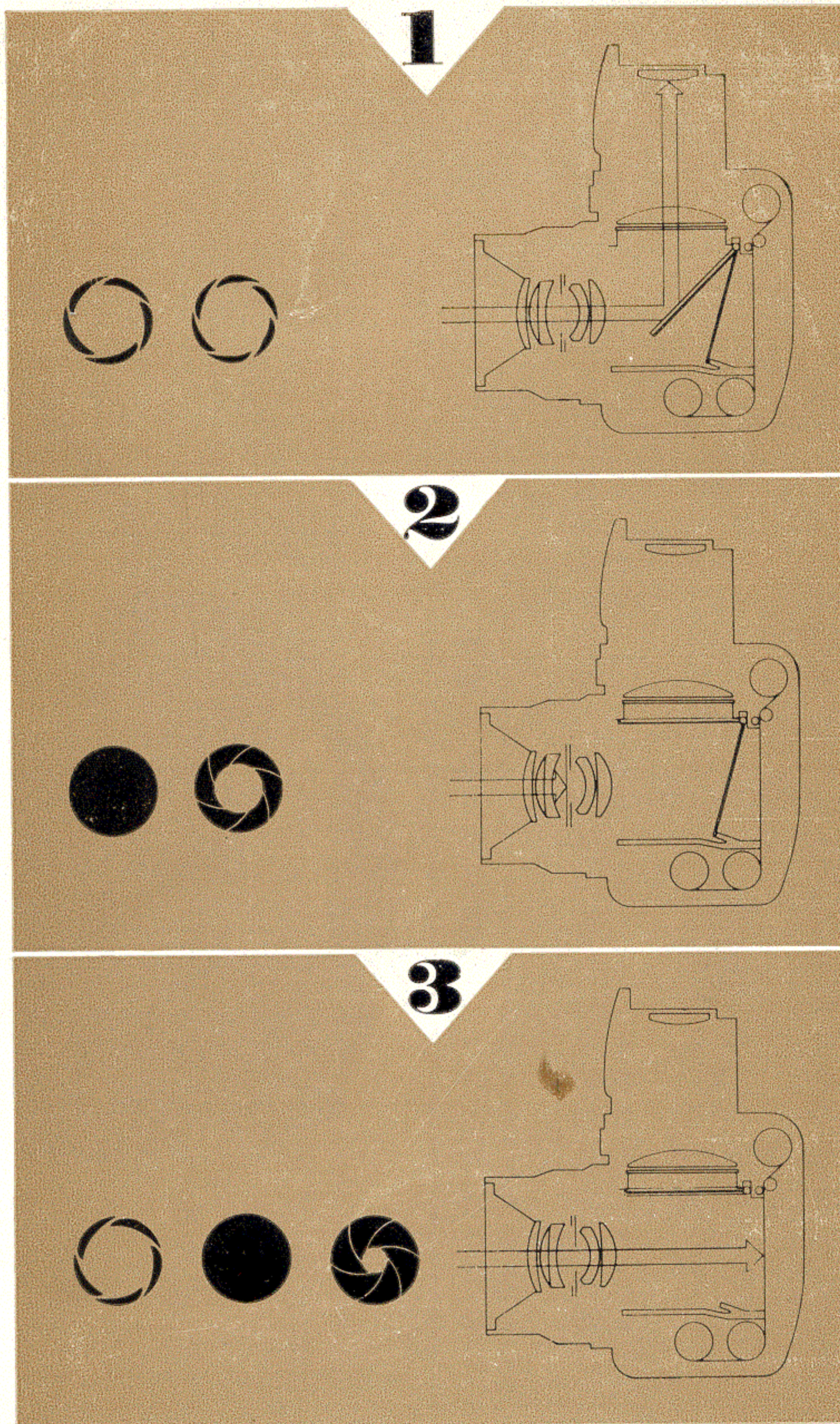

**1** Before the shutter-release button is pressed .....

the shutter and diaphragm are open; the mirror and light-baffle are in viewing position.

**2** When the shutter-release button is pressed .....

the shutter closes; the diaphragm begins to close-down; the mirror and light-baffle begin to swing up.

**3** Then .....

with the diaphragm closed-down to the selected F/stop, and the mirror and light-baffle in the up position, the shutter exposes the film.

# KOWA/SIX SPECIFICATIONS

- Type:** Leaf-shutter 2-1/4-square (6 × 6) single-lens reflex camera.
- Film Acceptance:** 120 (12 exposure) or 220 (24 exposure) roll film; flip-over 12/24 pressure plate.
- Standard Lens:** Kowa 85mm F/2.8.
- Lens Mount:** Positive Kowa bayonet with locking-collar; mount/dismount lever.
- Shutter:** # 0 Seiko SLV between-the lens leaf-shutter; 1-1/500sec. plus T; self-timer; M and X flash synchronization at all speeds. Same for all lenses.
- Focusing:** Direct helicoid type.
- Viewing System:** Interchangeable through-the-lens system. Standard system includes waist-level finder hood with pop-up magnifier; matte fresnel viewing screen with fine-ground plate focusing spot.
- Diaphragm:** Fully automatic; depth-of-field preview lever. Same for all lenses.
- Film Wind:** 360° knob with flip-out crank advances film and winds shutter; stops automatically on first frame; automatic double-exposure prevention.
- Frame Counter:** Automatic zero-reset; 12/24 selection.
- Camera Back:** Hinged and removable.
- Dimensions:** 132 × 116 × 157mm. (5-3/16 × 4-9/16 × 6-3/16 inch)
- Weight:** 1,700grams. (3 lb 12 oz)
- Accessories:** Eye-level Prism Finders (horizontal and 45° viewing types), Sports Finder, Exposure Finder, Standard Waist-level Finder Hood, Close-up Extension Tubes (T1, T2, T3), Hand Grip, Tripod Head, Viewing Screens (with fresnel and condenser lens; three types: plain matte, split-image, checker-board lines), Lens Hoods, Filters, Focusing Handle, Leather Cases.