

DIGITAL CAMERA

FinePix S1 Pro

**OWNER'S MANUAL**

This manual will show you how to use your FUJIFILM DIGITAL CAMERA FinePix S1 Pro correctly.
Please follow the instructions carefully.

Basic Photography

1

Setup

2

Advanced Photography

3Advanced Photography
(Playback)**4**

Preference

5

Warning

To prevent fire or shock hazard, do not expose the unit to rain or moisture.

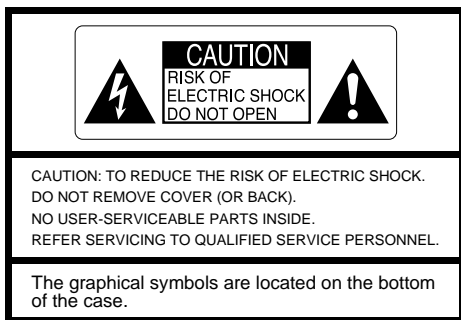

This symbol is intended to alert the user to the presence of uninsulated “dangerous voltage” within the product’s enclosure that may be of sufficient magnitude to constitute a risk of electric shock to persons.



This symbol is intended to alert the user to the presence of important operating and maintenance (servicing) instructions in the literature accompanying the appliance.

For customers in the U.S.A.

FCC Statement

This device complies with part 15 of the FCC Rules. Operation is subject to the following two conditions:(1) This device may not cause harmful interference, and (2) this device must accept any interference received, including interference that may cause undesired operation.

CAUTION

This equipment has been tested and found to comply with the limits for a Class B digital device, pursuant to Part 15 of the FCC Rules. These limits are designed to provide reasonable protection against harmful interference in a residential installation. This equipment generates, uses, and can radiate radio frequency energy and, if not installed and used in accordance with the instructions, may cause harmful interference to radio communications. However, there is no guarantee that interference will not occur in a particular installation. If this equipment does cause harmful interference to radio or television reception, which can be determined by turning the equipment off and on, the user is encouraged to try to correct the interference by one or more of the following measures:

- Reorient or relocate the receiving antenna.
- Increase the separation between the equipment and receiver.
- Connect the equipment into an outlet on a circuit different from that to which the receiver is connected.
- Consult the dealer or an experienced radio/TV technician for help.

You are cautioned that any changes or modifications not expressly approved in this manual could void your warranty.

For customers in Canada

CAUTION

This Class B digital apparatus complies with Canadian ICES-003.

EC Declaration of Conformity

We

Name : Fuji Photo Film (Europe) G.m.b.H.
Address : Heesenstrasse 31
40549 Dusseldorf, Germany

declare that the product

Product Name : FUJIFILM DIGITAL CAMERA FinePix S1 Pro
Manufacture's Name : Fuji Photo Film Co., Ltd.
Manufacture's Address : 26-30, Nishiazabu 2-chome, Minato-ku,
Tokyo 106-8620, Japan

is in conformity with the following Standards

Safety : EN60065
EMC : EN55022 : 1998 Class B
EN55024 : 1998
EN61000-3-2 : 1995 + A1:1998 + A2:1998

following the provision of the EMC Directive (89/336/EEC, 92/31/EEC and 93/68/EEC) and Low Voltage Directive (73/23/EEC).



Dusseldorf, Germany

June 1, 2000

Place

Date

Signature/Managing Director



Bij dit product zijn batterijen geleverd. Wanneer deze leeg zijn, moet u ze niet weggooien maar inleveren als KCA

Please read the Safety Notes (P.129) and make sure you understand them before using the camera.

Contents

Warning	2
Contents	4
Preface	8
Camera Features and Accessories.....	9
Features	9
Accessories	9
Nomenclature	10
Rear Display Panel Screens.....	13
Top Display Panel	14
Viewfinder Display	15

1 Basic Photography

1 Attaching the Shoulder Strap.....	16
Using the Shoulder Strap	16
2 Loading the Camera Batteries	17
Loading the Lithium Batteries	17
Loading the Button Cell	17
Loading the AA Batteries	18
Using the AC Power Adapter AC-5VH (optional)	19
3 Mounting the Camera Lens	20
4 Switching the Camera On and Off	22
5 Setting the Date and Time	23
6 Loading Media	24
7 Removing Media.....	25
8 Exposure Modes on the FinePix S1 Pro.....	26
9 Setting the Exposure Mode Dial	27
10 Holding the Camera and Focusing	28
11 Releasing the Shutter	30
12 Playing Back Photographed Images	31
To View Images (Playback).....	31
Playback Zoom.....	32
Multi-frame Playback	33
Erasing Single Recorded Images	35
Viewing Images on a TV.....	36
Background: A Brief Guide Focusing and Exposure	37

2 Setup

Setup Functions	38
Rear Display Panel	40
Setting the White Balance	40
Setting the Sensitivity.....	42

Setting the Image Quality	43
Setting the Image Size (Number of Pixels)	44
Setting the Color	45
Setting the Tone	46
Setting the Sharpness	47
Setting Multi-exposure.....	48
SET-UP Menu Part 1	49
Preview	49
Specifying a Custom WB Setting.....	50
Hi MODE/MEDIA	51
Hi MODE	51
MEDIA	51
SELF TIMER/AUTO POWER OFF	52
SELF TIMER	52
AUTO POWER OFF	52
SET-UP Menu Part 2	53
FRAME No.	53
PC MODE/BEEP	54
PC MODE	54
BEEP	54
LANGUAGE/RESET	55
LANGUAGE	55
RESET	55
Camera Reset	56
Camera Reset	56

3 Advanced Photography

Focusing Modes	57
When the Focusing Mode is Set to AF (auto focus)	57
Auxiliary AF Light.....	57
When M (manual focus) is Selected.....	58
Focus Lock Photography	59
Shooting Using Exposure Modes	60
 : AUTO	60
P : Programmed Auto	61
S : Shutter-priority Auto	62
A : Aperture-priority Auto	63
M : Manual.....	64
Shooting Using 5-Vari Programs	66
5-Vari Programs	66
Taking Pictures Using 5-Vari Programs	66
5-Vari Program Types and Features	67

1







2

3

4

5

Contents - continued

 : Portrait mode	67
 : Landscape mode.....	67
 : Close-up mode.....	67
 : Sport mode (continuous shooting)	68
 : Night scene mode	68
Metering Modes	69
Multi-pattern Metering and 3D 6-zone Multi-pattern Metering	69
Center-weighted Metering	69
AE Lock Photography	70
Exposure Compensation	71
Self-timer Photography.....	72
Dioptr Adjustment Function/Eyepiece Cap	73
Flash Photography	74
Built-in Flash and TTL-BL Flash Control	74
Flash Control Range (Effective Flash range)	74
Synchro Mode Types and Features	75
 : Red-eye reduction mode	75
 : Slow synchro mode.....	75
Taking Pictures Using the Built-in Flash.....	76
Flash Intensity	77
Lenses that Can Be Used with the Built-in Flash	77
Nikon Flash Units that Can Be Used	78
Notes on Using Nikon Flash Units.....	79
Combining Modes	80
Shooting and Recording Previews.....	81
Standard Chart Display.....	82
Histogram Display.....	83
Multi-exposure.....	84

4 Advanced Photography (Playback)

Playback Functions.....	85
Erase/Format	86
Erase All/Format	86
Protection Settings	88
Protecting and Unprotecting Individual Image	88
Protecting and Unprotecting All Images	89
DPOF Settings	91
DPOF.....	91
Setting or Cancelling Date/Time Imprinting	92
Specifying DPOF Settings for Single Frame	93
Checking and Cancelling DPOF Settings for Single Frame (REVIEW/CANCEL)	95
Setting DPOF Settings for All the Images (SET ALL).....	97
Cancelling DPOF Settings for All Frames (CANCEL ALL)	99

Auto Play (Automatic Playback)	101
Auto Play Settings	101
Adjusting the Color LCD Monitor Brightness	103

5 Reference

System Expansion Options	105
Lenses that Can Be Used with this Camera	106
Types of Nikkor Lenses with a Built-in CPU and Other Lenses that Can Be Used..	107
Optional Accessories Guide	108
Explanation of Terms	110
Using the USB Cable and the Software Included	111
Notes on Using the FinePix S1 Pro	113
Cleaning the CCD	114
Determining Whether Cleaning is Required	115
Cleaning the CCD.....	116
Power Supply Notes	117
Batteries that Can Be Used	117
Notes on Handling the Batteries	117
Notes on Using the AC Power Adapter (AC-5VH) (sold separately)	118
Notes on Media	119
Warning Displays	121
Troubleshooting	124
Specifications	126
Standard Number of Available Shots (Recorded Images).....	128
Compatible Media.....	128
Batteries Uses and Symptoms When Batteries are Depleted	128
Safety Notes	129

Preface

■ Preparatory Trial Shots

When you are taking particularly important photographs (at a wedding or on holiday, for example), always take a trial photograph first to check that the camera is functioning normally.

* Fuji Photo Film Co., Ltd. accepts no liability for any incidental losses (including any costs incurred in the course of the photography and any loss of income obtained from the photography) incurred as a result of any fault in this product.

■ Notes on Copyright

Images recorded using your digital camera cannot be used in ways that infringe copyright laws without the consent of the owner, unless intended only for personal pleasure. Note also that some restrictions apply to the photographing of stage performances, entertainments and exhibits, even when intended purely for personal use. Users are also asked to note that the transfer of memory cards (SmartMedia or microdrives) containing images or data protected under copyright laws is only permissible within the restrictions imposed by those copyright laws.

■ Liquid Crystal

If the LCD panel is damaged, take particular care with the liquid crystal contained in the panel. If any of the following situations arise, take the urgent action indicated.

- If liquid crystal comes in contact with your skin
Wipe the area with a cloth and then wash thoroughly with running water and soap.
- If liquid crystal gets into your eye
Flush the affected eye with clean water for at least 15 minutes and then seek medical assistance.
- If liquid crystal is swallowed
Flush your mouth thoroughly with water. Drink large quantities of water and induce vomiting. Then seek medical assistance.

■ Notes on Electrical Interference

If the camera is needed be used in hospitals or aircrafts, please note that this camera may cause interference to other equipment in the hospital or aircraft.

For details, please check with the applicable regulations in that place.

■ Handling Your Digital Camera

This camera contains precision electronic components. To ensure that images are recorded correctly, do not subject the camera to impacts or shocks while image data is being recorded.

■ Trademark Information

- iMac and Macintosh are registered trademarks of Apple Computer, Inc.
- Windows is a trademark of the Microsoft Corporation of the U.S. registered in the USA and other countries.
Windows is an abbreviated term referring to the Microsoft Windows Operating System.
- SmartMedia is a trademark of Toshiba Corporation.
- All other company or product names used in this document are trademarks or registered trademarks of their respective holders.

■ Explanation of Color Television System

NTSC: National Television System Committee, color television telecasting specifications adopted mainly in the U.S.A., Canada and Japan.

PAL: Phase Alternation by Line, a color television system adopted mainly by European countries and China.

Camera Features and Accessories

Features

- The newly developed large-size 3.4 million "Super CCD" built into the FinePix S1 Pro provides ultra-high resolution of 6.13 million output, high sensitivity, a wide dynamic range and an excellent signal-to-noise ratio.
- Quick, responsive operation with only 0.7 seconds between shots (6.13-million output pixels)
- 5-vari programs and an AUTO photography mode that make it easy to select the right camera settings for your subject
- Exposure programs and manual photography modes let you fine tune your photography settings
- Built-in flash and support for external flash units
- Dot-matrix LCD panel (backlit) lets you to check your camera settings as you shoot
- Equipped with 2 different recording media slots (slot 1: SmartMedia, slot 2: CF type II)
- Select any of 3 image recording resolutions as needed (6.13 million, 3.54 million or 1.38 million recorded pixels)
- Histogram display function lets you check the image exposure right after you shoot
- Allows you to set the ISO sensitivity, tint, tone and sharpness individually just as if you were selecting the film
- 2-inch 200,000-pixel low-temperature polysilicon TFT LCD monitor
- Color and grayscale screen display function for checking colors and highlights/shadows
- USB connection lets you take pictures from your PC and transfer image data quickly and easily (supplied accessory)
- Supports DPOF (Digital Print Order Format) for simple print ordering
- Conforms to the Design rule for Camera File system.

Accessories

● SmartMedia (1) (16MB, 3.3V)

Supplied with:

- Anti-static case (1)
- Index labels (1 set)



● AA-size Alkaline Batteries (4)

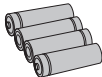

● Lithium batteries CR123A (2)



● Button Cell Lithium Battery CR2025 (1)



● Shoulder Strap (1)



● Video Cable (approx. 1.5 m (4.9ft.), mini-plug (3.5 mm-dia.) to pin-plug cable) (1)



● Camera Body Cap (1)



● Battery Adapter (1)

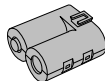

● Eyepiece Cap (1)

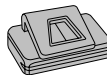

● CD-ROM (1)

● USB Cable (1)

● Manuals

- Owner's Manual (this document) (1)
- Quick Start Guide (1)
- Quick Start Guide for Camera Shooting Software (1)

Nomenclature

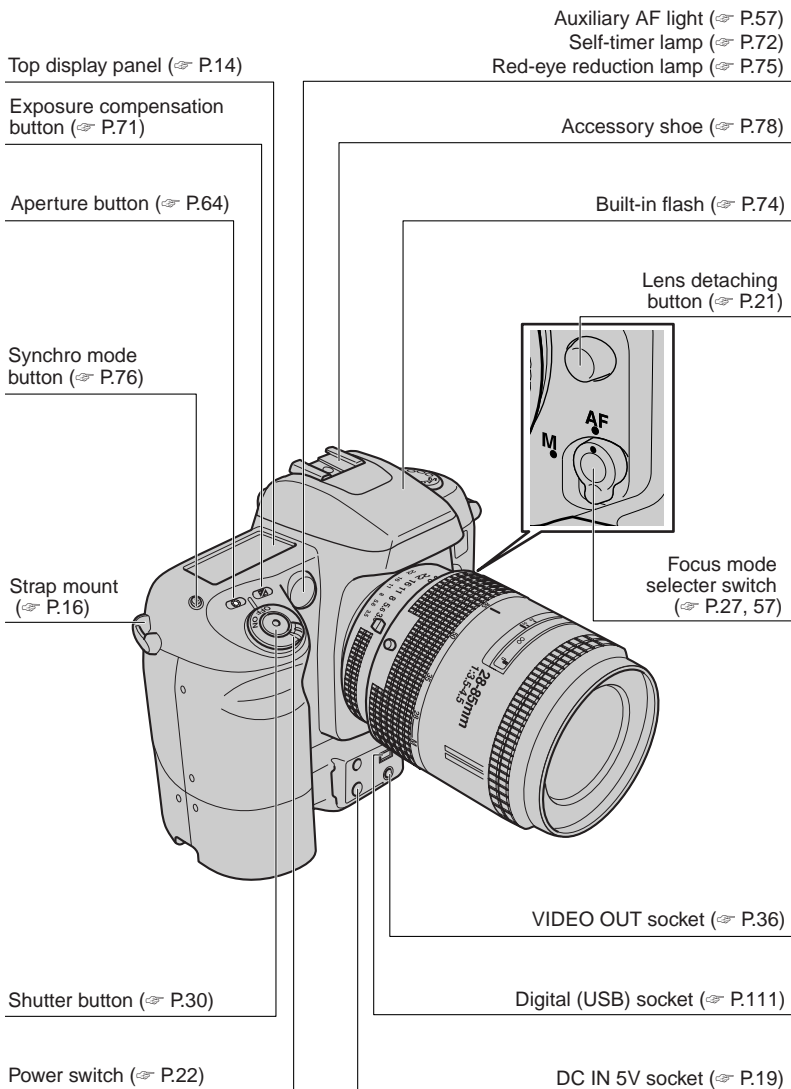

Self-timer button (⇨ P.72)

Viewfinder window (⇨ P.73)

Flash lock release button
(⇨ P.76)

Diopter adjustment
knob (⇨ P.73)

AE lock button (⇨ P.70)

Strap mount
(⇨ P.16)

AA battery compartment
cover release catch (⇨ P.18)

Exposure mode dial (⇨ P.60)

Command dial
(⇨ P.61)

Eyepiece surround
(⇨ P.73)

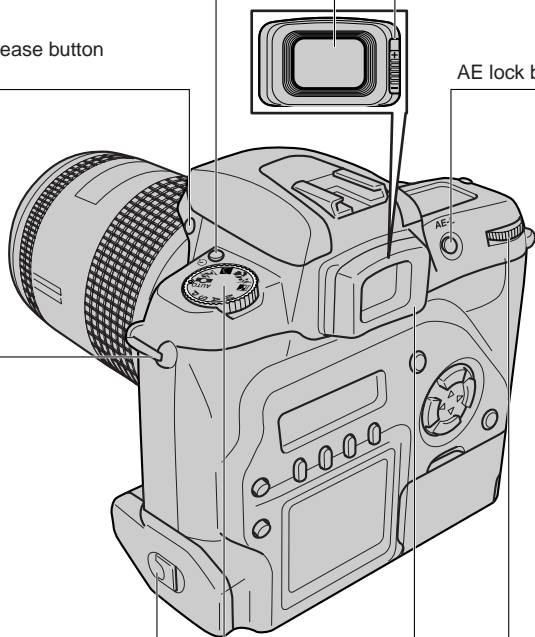

Nomenclature - continued

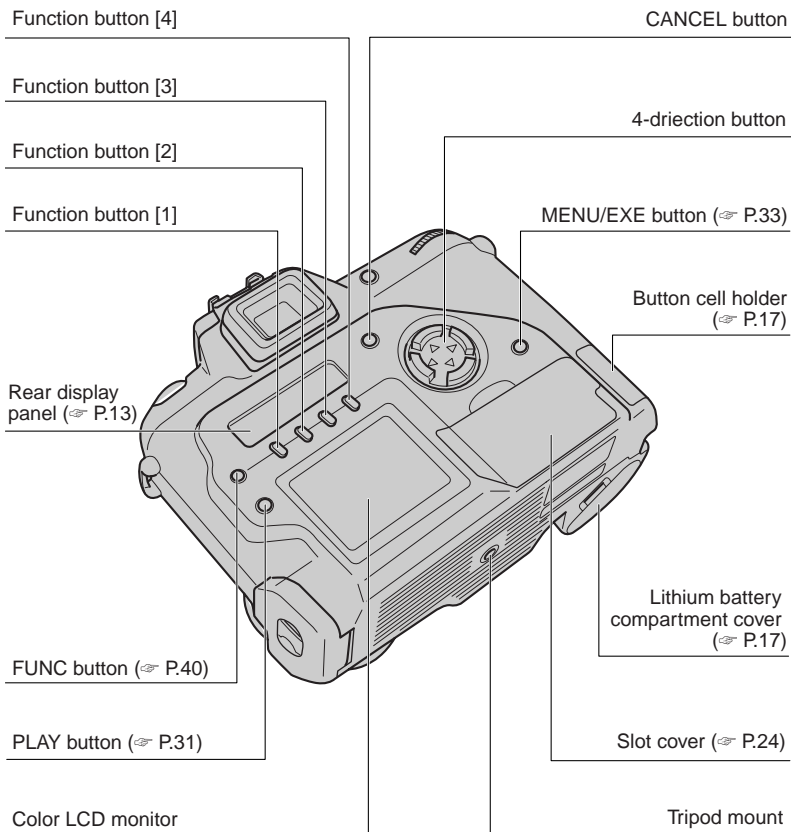

Rear Display Panel Screens

• Display during photography

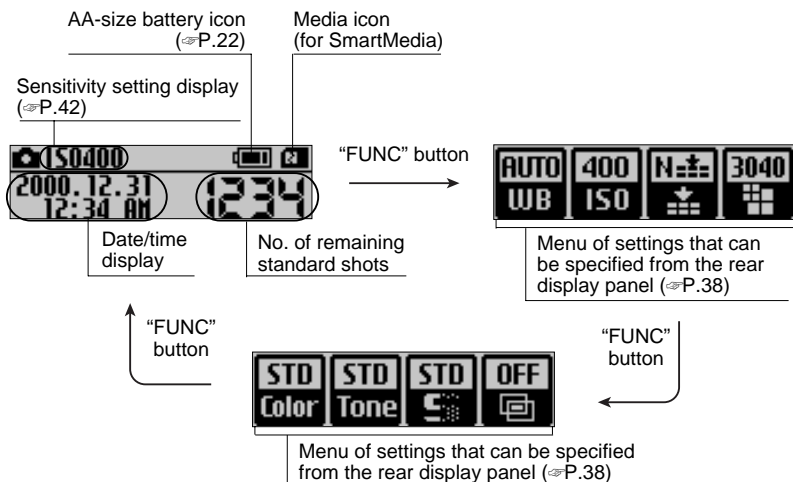

• Display during playback

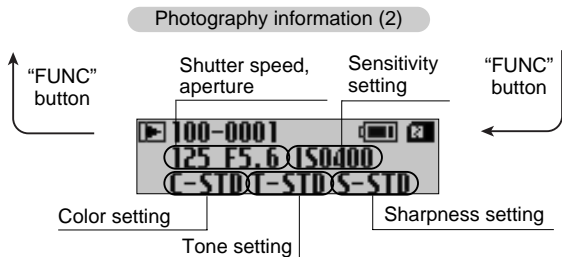
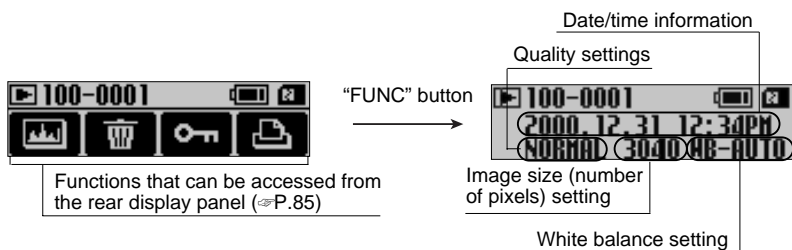

Top Display Panel

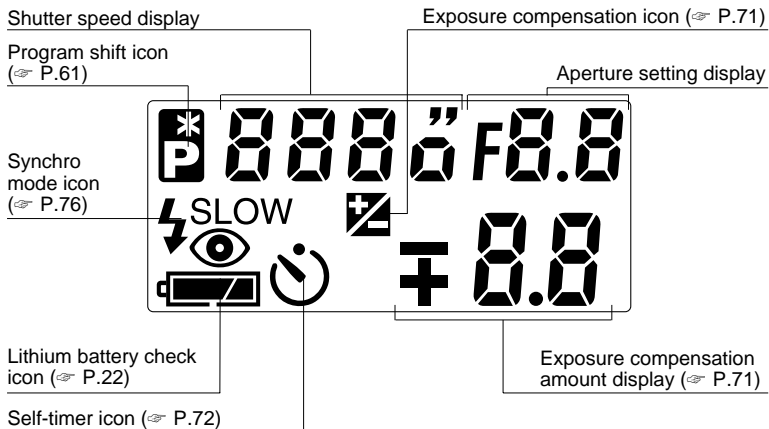

Note

Liquid crystal in the display panels and viewfinder display

The LCDs (liquid-crystal displays) used in the display panels and viewfinder display darken at high temperatures. At low temperatures the display responses slow down slightly. In either case, the display will return to normal at room temperature.

Viewfinder Display

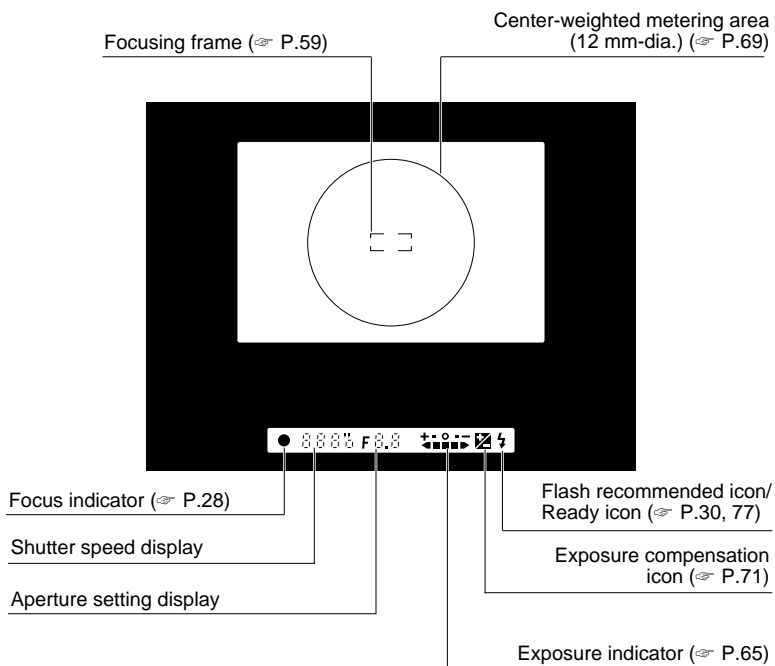

1 Attaching the Shoulder Strap

- Use the shoulder strap to ensure that you do not drop the camera while taking pictures.

1 Pass the end of the shoulder strap through the strap mount on the camera body.

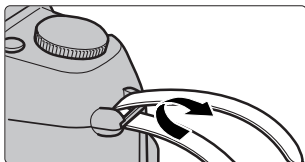

2 Pass the end of the strap through the fastener A and loop B as shown in the figure below.

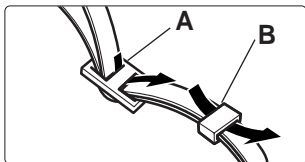

- Check that the strap is pulled tight after it is attached.

Using the Shoulder Strap

1 Put the shoulder strap over your shoulder.



- To ensure that you do not drop the camera while taking pictures, slip the strap over your shoulder before you grip the camera body.

2 Loading the Camera Batteries

- The FinePix S1 Pro Digital Camera uses 2 lithium batteries (CR123A type), 1 button cell and 4 AA batteries. It can also be run from an ordinary power socket using the optional AC power adapter AC-5VH. (See P.128 for information on using the batteries.)

Loading the Lithium Batteries

- 1** Switch the camera “OFF”, slide the open/close catch on the lithium battery compartment cover in the direction indicated and open the cover.

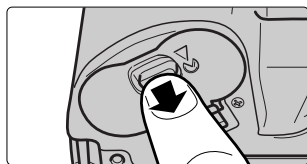
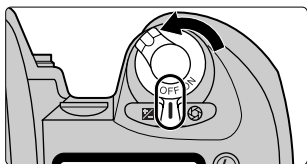

- 2** Load the lithium batteries in the direction indicated by the \oplus and \ominus labels on the battery compartment cover. Then firmly close the battery compartment cover.

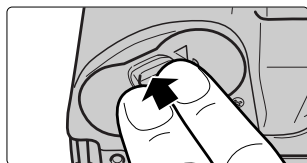
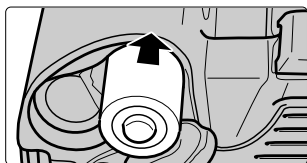

- Loading the batteries in the wrong direction could cause a camera fault.

Loading the Button Cell

- 1** Switch the camera “OFF” and then use a coin to pull out the button cell holder.

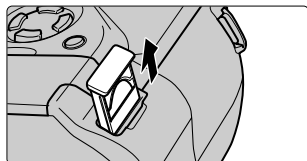
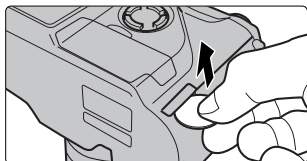

1

Loading the Camera Batteries - continued

- 2** Load the button in the direction indicated by the ⊕ and ⊖ labels on the button cell holder. Then firmly close the holder.

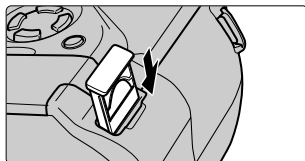
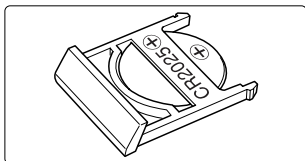

- Loading the button cell in the wrong direction could cause a camera fault.

Loading the AA Batteries

Batteries

- AA-size alkaline batteries (provided), AA-size Ni-Cd batteries or AA-size nickel metal hydride (Ni-MH) batteries can be used.

- 1** Switch the camera “OFF”, lift up the AA battery compartment cover release catch and open the cover downwards.

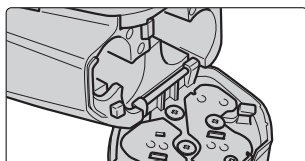
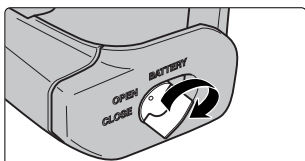

- 2** Load the AA batteries in the direction indicated by the ⊕ and ⊖ labels on the battery compartment cover. Then firmly close the battery compartment cover.

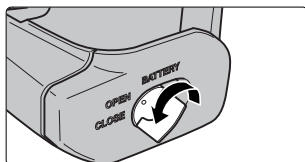
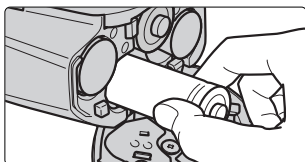

- Loading the batteries in the wrong direction could cause a camera fault.
- If you switch the camera “ON” without loading AA-size batteries, the “Err” warning appears on the top display panel and the camera will not take pictures.

Using the AC Power Adapter AC-5VH (optional)

1 Open the lithium battery compartment cover as described in step 1 in “Loading the Lithium Batteries”.

- When the camera is connected to a personal computer or you are viewing recorded images on a TV so that the camera is switched on for an extended period, you should use the AC-5VH. When you use the AC-5VH, you can load the battery adapter (supplied) instead of the lithium batteries to prevent the lithium batteries being depleted. However, bear in mind that you cannot use the built-in flash when you are using the battery adapter.

2 Insert the battery adapter as shown in the figure and firmly close the battery compartment cover.

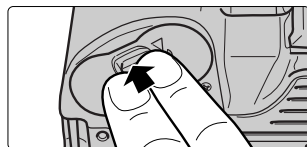
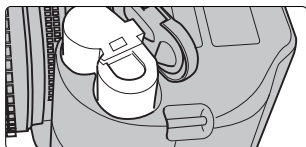

Note

Notes on using the battery adapter

When you use the battery adapter, use the AC-5VH or AA-size Ni-MH batteries.

3 Insert the connection plug for the AC-5VH into the DC IN 5V socket on the camera and plug the AC-5VH into the power socket.

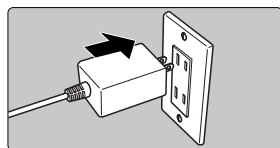
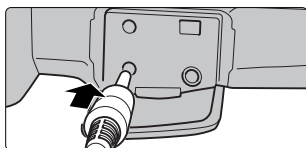

- To remove the battery adapter, grasp the catch with your fingers and lift the adapter out.
- The socket-outlet shall installed near the equipment and shall be easily accessible.
- The shapes of the AC-5VH, plug and socket-outlet depends on the country of use.
- You cannot charge the batteries by connecting the AC-5VH.

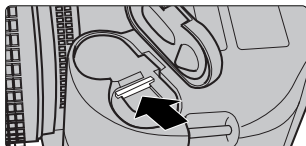

3 Mounting the Camera Lens

- Switch the camera “OFF” to mount the camera lens. Always leave the aperture ring set to the smallest aperture (the aperture setting with the highest number).

1 Switch the camera off and mount the camera lens.

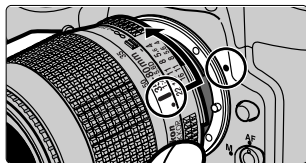
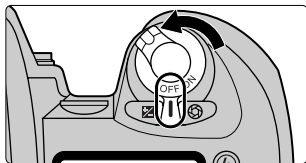

- Align the mounting marks on the lens and the camera body and then turn the lens slowly in the direction of the arrow until it clicks into place. (Do not press the lens detaching button.)
- If you switch the camera on when there is no lens mounted or when the lens mounted is not a Nikkor lens with a built-in CPU (⇨ P.107), the “F--” warning appears blinking on the top display panel and in the viewfinder display and the shutter will not release (If the exposure mode is set to Manual, the shutter will release when the “F--” warning is displayed.) (⇨ P.121).

Note

Notes on Changing the Lens

- Take care not to mount the lens when it is at an angle to the camera as this can damage the lens mount on the camera.
- Always change the lens in an area free of dirt and dust.

2 Set the aperture ring to the smallest aperture and lock the aperture ring.

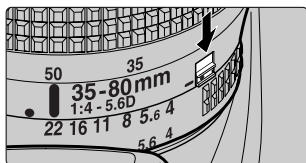
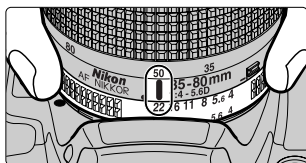





- If you switch the camera “ON” when the aperture ring is not set to the smallest aperture, “FEE” appears blinking on the top display panel and in the viewfinder display and the shutter will not release (⇨ P.121).
- Always lock the aperture ring. If the aperture ring slips, the shutter may not release when you press the shutter button.

4 Switching the Camera On and Off

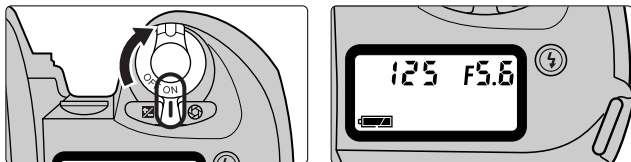
- 1** To switch the camera on or off, set the power switch to “ON” or “OFF” respectively. When you switch the camera on, the battery check icon “” appears.



- Top display panel display

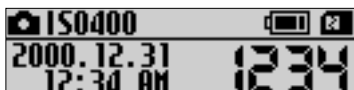

-  (lit): Ample charge in the CR123A lithium batteries
-  (lit): Charge in the CR123A lithium batteries is low. Have replacement batteries ready.
-  (blinking): Replace the CR123A lithium batteries.
The battery check icon blinks for about 3 seconds and then the Auto Power Off function switches the camera off. The battery icon then stops blinking and remains lit. The viewfinder display switches off and the shutter will not release.
If this occurs when you are using the battery adapter, replace the AA-size batteries.

- Rear display panel display



-  (lit): Ample charge in the AA-size batteries
 -  (lit): Charge in the AA-size batteries is low. Have replacement batteries ready.
 -  (blinking): Replace the AA-size batteries.
The battery check icon blinks for about 3 seconds and then the Auto Power Off function switches the camera off.
- If the date and time are not set, the date/time display on the rear display panel blinks.

Note

Notes on the Batteries

- Do not use depleted batteries.
- If you take pictures or play back images when the battery charge is low, you may find that you can no longer take pictures or play back images regardless of which battery check icon is lit. If this occurs, switch the camera “OFF” and replace the batteries.

5 Setting the Date and Time

■ Use the procedure below to set the date and time.

- 1 Press the “MENU/EXE” button. The “SET-UP” menu appears on the color LCD monitor.

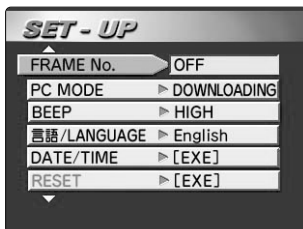
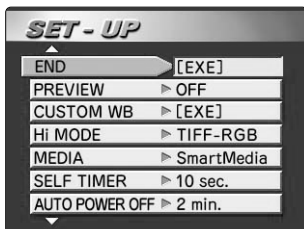

- 2 Press “▲” or “▼” on the 4-direction button to select “DATE/TIME” and press the “MENU/EXE” button.
- 3 Press “▲” or “▼” on the 4-direction button to select the desired setting and then press the “◀” or “▶” button.



- Select “DATE TYPE” to set “MM/DD/YYYY” (month/day/year), “DD/MM/YYYY” (day/month/year) or “YYYY.MM.DD” (year.month.day) as the display format for the date.
- You can also set the “YEAR”, “MONTH”, “DAY”, “HOURL” and “MINUTE”. Press “▶” on the 4-direction button to increase the number and “◀” to decrease the number.
- Default setting
USA/Canada model: MM/DD/YYYY
Europe model: DD/MM/YYYY

- 4 Press the “MENU/EXE” button.
- 5 Press “▲” or “▼” on the 4-direction button to select “END” and then press the “MENU/EXE” button.

6 Loading Media

- 1** Switch the camera “OFF”, open the slot cover and insert the media. Load a Microdrive or a CompactFlash card into the upper slot and a SmartMedia into the lower slot.

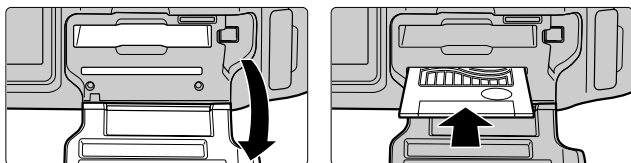

For a SmartMedia

- Insert a SmartMedia with the contact area (gold-colored area) facing upwards.
- Insert a Microdrive or a CompactFlash card in the correct direction and push it smoothly all the way into the slot.

- 2** Close the slot cover.

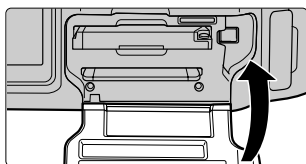

- If there is a write-protect sticker on the SmartMedia, data cannot be recorded onto or deleted from the SmartMedia.
- Compatible Media (☞ P.128).
- Back up your data at regular intervals. Fuji Photo Film Co., Ltd. accepts no liability for any losses incurred as a result of data being erased or corrupted.

Note

Notes on Taking Pictures

You can release the shutter of the FinePix S1 Pro when there is no media installed in the camera. In this event, the image appears on the color LCD monitor but is not recorded. Always check that there is a media card installed in the camera before taking pictures.

7 Removing Media

1 Switch the camera “OFF” and open the slot cover.

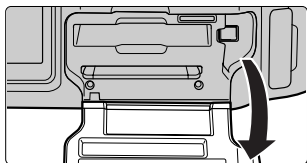

- If you open the slot cover when the camera is switched on, the “Err” warning appears on the top display panel. Switch the camera “OFF” first.
- Do not open the slot cover while data is being recorded as this can result in data loss or corruption.
- If you open the slot cover during a shot taken with a long shutter speed, the top display panel continues to operate until the picture is taken.

2 Eject the media.

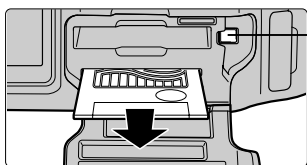





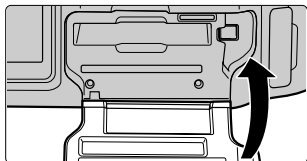

Microdrive eject button

- To remove a SmartMedia, push the SmartMedia in gently. The SmartMedia then pops out slightly for easy removal.
- To remove a Microdrive or a CompactFlash card, press the eject button beside the slot.

3 Close the slot cover.



8 Exposure Modes on the FinePix S1 Pro

Symbol	Name	Features and Typical Uses	
 P.60	AUTO mode	Exposure is controlled entirely by the camera. This mode is ideal for snapshots and other situations where you need to take the picture quickly to avoid missing the moment.	
P P.61	Programmed Auto	The camera controls the exposure but the photographer can also influence the outcome using the program shift (⇌ P.61) and exposure compensation (⇌ P.71) features.	
S P.62	Shutter-priority Auto	You set the shutter speed and the camera controls the exposure. This mode lets you set fast shutter speeds to freeze fast-moving subjects or slow shutter speeds to emphasize the subject's motion.	
A P.63	Aperture-priority Auto	You set the aperture and the camera controls the shutter speed. This mode is ideal for shots where you want to control the depth of field (the range of focus in front of and behind the subject) for focusing, such as shots where you want the foreground and background both in clear focus or shots where you want the background deliberately out of focus.	
M P.64	Manual	This mode lets you set both the shutter speed and the exposure. Use this mode when none of the other modes give quite the effect you are looking.	
5-Vari Programs P.66	 P.67	Portrait mode	This mode uses a shallow depth of field (the range of focus in front of and behind the subject) to give portrait shots that have a soft, blurred backdrop and a feeling of depth.
	 P.67	Landscape mode	This mode uses a very large depth of field (the range of focus in front of and behind the subject) to give landscape shots in which both nearby and distant scenery is in focus.
	 P.67	Close-up mode	This mode uses a relatively shallow depth of field to make the subject stand out and give a soft, blurred background for beautiful close-up shots.
	 P.68	Sport mode	This mode uses a fast shutter speed to freeze the action, allowing you to take sports shots that capture the feeling of rapid motion.
	 P.68	Night Scene mode	This mode uses exposure control specially tailored to dimly lit subjects to allow you to take pictures in the evening or at night. (When you take a picture of a subject against a night scene background, you can use the flash to capture both your subject and the background as they appear naturally.)

9 Setting the Exposure Mode Dial

- By setting the exposure mode dial to **AUTO** (AUTO mode), you can leave the exposure settings to the camera when you take pictures.

1 Switch the camera “ON”.

2 Set the exposure mode dial to “**AUTO**” (AUTO mode).

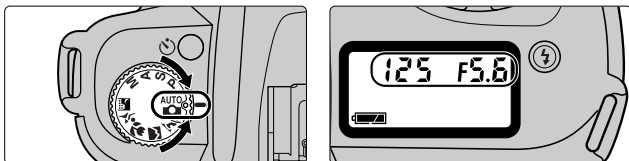

- The shutter speed and aperture settings are shown on the top display panel.

3 Set the focus mode selector switch to “**AF**” (auto focus).

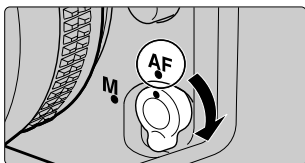

- Make sure that the focus mode selector switch clicks when you select the setting.
- To focus on your subject, hold the shutter button halfway (⇨ P.28).

10 Holding the Camera and Focusing

- Hold the shutter button halfway to focus the camera. When your subject is in focus, the focus indicator “●” appears in the viewfinder.

1 Hold the camera correctly.



- Hold your body straight and brace your elbows lightly against your sides.
- Put one foot forward slightly to keep your upper body steady.
- Hold the camera so that your right hand is firmly around the grip and use your left hand to support the lens.

Important

Camera shake and shutter speed

Camera shake is something to be avoided when taking pictures. As a general guide when taking pictures, the shutter speed should be faster than $[1/\text{focal length of the lens mounted}]$ seconds. For example, with a 50 mm lens, you should use a shutter speed faster than 1/50 sec. Use a tripod for slow shutter speeds.

Note

Notes on Composing Your Shot

As a percentage of the actual image photographed, the image area visible through the viewfinder of the FinePix S1 Pro (the viewfinder coverage) is about 90% vertically and about 93% horizontally. In other words, the picture actually taken is slightly larger than the field of view in the viewfinder.

2 Compose your shot and press the shutter button halfway to set the focus.

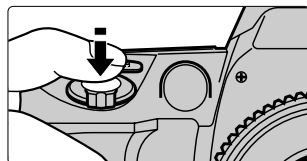
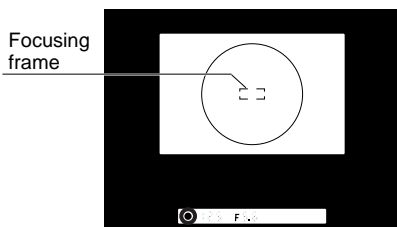

- When you position the focusing frame on the object you want to focus on and press the shutter button halfway, the camera automatically focuses on the object and one of the following appears in the viewfinder:

- ☀ Lit The camera has focused on the subject. If the subject is moving, the camera adjusts the focus so that it follows the movements of the subject.
- ☀ Blinking The camera cannot focus on the subject.

If the subject is dark, the auxiliary AF light automatically operates so that the camera can focus. See P.57 for more information on focusing.

- If the object you want to focus on is outside the focusing frame, use focus lock to take the picture (☞ P.59).

11 Releasing the Shutter

- Check that the focus indicator “●” is lit and then slowly press the shutter button down fully to release the shutter.

1 Press the shutter button halfway and check the viewfinder display.

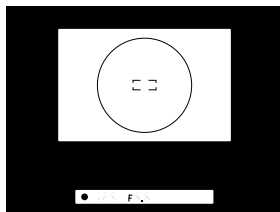
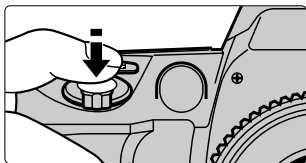

- If the flash recommended icon “4” is flashing in the viewfinder display, use the built-in flash (⇨ P.74, 76).
- If a warning is displayed on the top display panel or viewfinder display, refer to P.121 and P.122 for information on how to respond.

2 Check that the focus indicator “●” is lit and then gently press the shutter button fully.

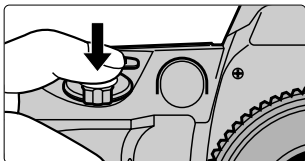
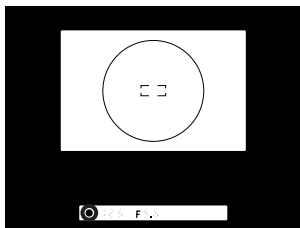

- The “REC” icon flashes on the rear display panel while the image is being recorded.



- The shutter does not release during recording when Preview mode is set to ON.
- If the number of prints display is highlighted, the shutter will not release even when the focus indicator “●” is lit.
- When there is no media loaded, you can display and review an image but you can not record it.

12 Playing Back Photographed Images

- Use the procedure below to play back images you have shot and recorded.

To View Images (Playback)

Play back recorded images as follows:

- 1** Press the “PLAY” button. The recorded image is played back on the color LCD monitor.

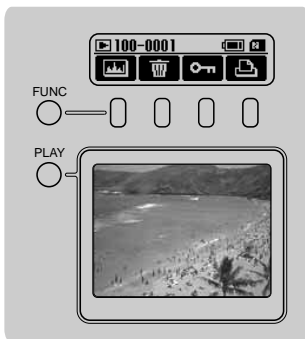
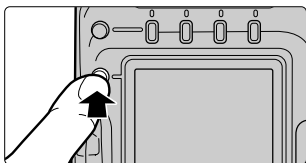

- 2** To view another image, use “▶” (scan forwards) or “◀” (scan backwards) on the 4-direction button.

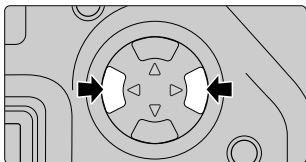

- Pressing the “PLAY” button again (twice when multi-frame playback is selected) returns the camera to photography mode.
- Press the shutter button down halfway to return to shooting mode.

Playing Back Photographed Images - continued

Playback Zoom

Use playback zoom to view details of the image being played back enlarged.

1 Display the recorded image. (See “To View Images (Playback)”.)

- You cannot use this method in “4-MULTI” or “9-MULTI” display mode. Switch back to single-frame display first (☞ P.33).

2 Press “▲” on the 4-direction button. The displayed image is enlarged.

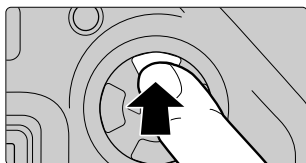

- Pressing “▼” on the 4-direction button returns enlarged image to its original size.
- Press “◀” or “▶” on the 4-direction button to play back another image.
- Press the “CANCEL” button to return to viewing images at normal size.
- The maximum playback magnification varies depending on the image file size.

3 To zoom in on another part of the enlarged image, press the “PLAY” button to display the cursor and then press “▲”, “▼”, “◀” or “▶” on the 4-direction button to display the area you want to view.

- To remove the cursor and return to the normal enlarged display screen, press the “PLAY” button again or press the “CANCEL” button.

Multi-frame Playback

In multi-frame playback, image display can be set to “4-MULTI”, which displays 4 image frames at one time, or “9-MULTI”, which displays 9 image frames at one time.

Multi-frame playback provides a convenient way of selecting images for frame erase, frame protect and DPOF frame settings.

If you press the “PLAY” button after you have pressed the button to erase a frame from multi-frame playback or the button to protect a frame, you can review a single frame playback.

1 Press the “PLAY” button to display the recorded image on the color LCD monitor.

2 Press the “MENU/EXE” button to display the menu.

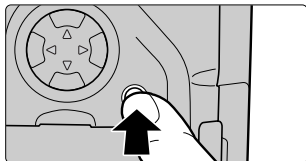

3 Press “◀” or “▶” on the 4-direction button to display the “MULTI PLAY” menu.

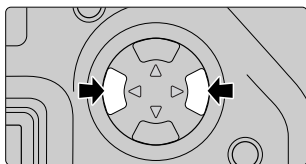

Playing Back Photographed Images - continued

- 4** Press “▲” or “▼” on the 4-direction button to select “4-MULTI” or “9-MULTI”.

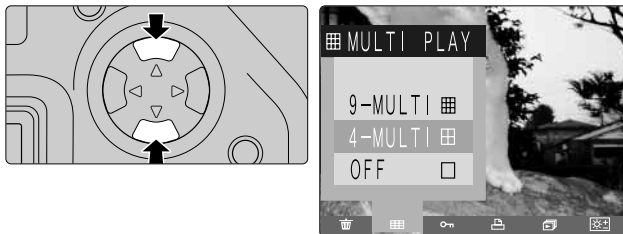

- 5** Press the “MENU/EXE” button to begin multi-frame playback.

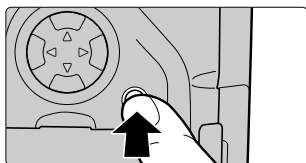

- The display shows the selected multi-frame playback display.



- To return to single-frame playback, select “OFF” in the “MULTI PLAY” menu.

Erasing Single Recorded Images

Use the procedure below to erase recorded images.

To erase all the recorded images, see P.86.

1 Display the image to be erased. (See “To View Images (Playback)”.)

2 When you press function button [2], the image is displayed on the rear display panel for erase confirmation.

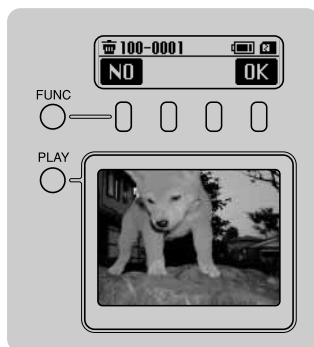
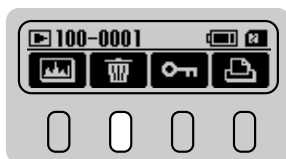

- If the image is protected (☞ P.88), the error tone sounds and an error message is displayed for about 3 seconds.
- If DPOF settings have been specified for the image, the error tone sounds and an erase confirmation message is displayed. Check the image and then proceed to step 3.

3 Press function key [4] to erase the selected image. The next recorded image then appears.

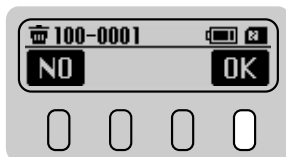

- To cancel the procedure, press function key [1].
- To continue erasing images, repeat steps 2 and 3.

Playing Back Photographed Images - continued

Viewing Images on a TV

- 1** Switch the camera and the TV off. Plug the enclosed video cable into the VIDEO OUT socket on the camera.

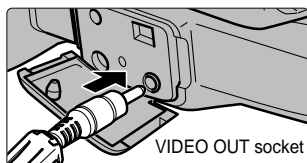

- If there is a power outlet handy, the optional AC Power Adapter AC-5VH should be connected.

- 2** Plug the pin-plug end of the video cable into the video input socket on the TV and switch on the camera and the TV. You can then take pictures and play back images in the usual way.

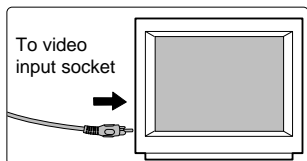

- Refer to the instructions for your TV for information on the video input socket.

Background: A Brief Guide Focusing and Exposure

Focusing, exposure and exposure metering are key factors in taking photographs. By understanding these aspects of photography, you can achieve a wider range of photographic effects.

■ Focus and Depth of Field

When you focus the camera on a point, an area in front of and behind that point is also in focus. This area is referred to as the depth of field and varies depending on factors such as the distance to the subject, the focal length of the lens and the aperture setting. In particular, narrowing the lens aperture (selecting a higher f-stop) increases the distance over which objects are in focus, giving what is referred to as a large depth of field. Conversely, widening the lens aperture (selecting a lower f-stop) decreases the distance over which objects are in focus, giving a shallow depth of field (☞ P.67).

■ Exposure

Exposure refers to the process by which light from the subject (the person or object being photographed) passes through the camera lens, hits the film (CCD) and is recorded. During this process, it is important that the sensitivity of the CCD in the camera is matched to the brightness of the subject and that the shutter speed and aperture are adjusted so that the correct amount of light reaches the CCD (correct exposure).

To ensure optimum exposure, the FinePix S1 Pro is provided with a number of exposure modes. These include the AUTO, programmed auto and image program modes, in which the camera sets both the focus and the aperture setting, the shutter-priority auto mode, in which the photographer sets the shutter speed and the camera sets the exposure, the aperture-priority auto mode, in which the photographer sets the exposure and the camera sets the shutter speed, and manual mode, in which the photographer sets both the shutter speed and the aperture setting by referring to the camera's exposure meter (☞ P.64).

■ Exposure Metering

The action of measuring the brightness of the subject (the person or object being photographed) is referred to as exposure metering. Exposure metering is an important source of information for determining the exposure. This information is used to determine the combination of shutter speed and aperture settings that will allow the optimum amount of light to hit the CCD. Because the distribution of light in the image that includes the subject is not necessarily uniform, the FinePix S1 Pro divides the image into 6 sections and provides 2 types of exposure metering. These are "multi-pattern metering", in which the optimum exposure is determined using independently measured light information for each section, and "center-weighted metering", in which the exposure metering information for the central part of the image is emphasized in determining the optimum exposure.

If a D-type AF Nikkor lens is mounted on the camera, and additional metering mode called "3D 6-zone multi-pattern metering" is available in which distance information is also considered (☞ P.69).

Settings available from the rear display panel

Setting	Display	Factory Default	Description	Ref. Page
White balance	AUTO, Sunny, Shade, Fluorescent 1, Fluorescent 2, Fluorescent 3, Incandescent, Custom	AUTO	Specify this setting to take pictures with the white balance fixed to match the ambient light (indoor or outdoor) when the picture is taken.	P.40
Sensitivity	320, 400, 800, 1600	400	Specify this setting when you want to shoot using a fast shutter speed (to prevent camera shake) or when you want to take bright pictures indoors without using the flash.	P.42
Quality	Basic, Normal, Fine, Hi	Normal	Use this setting to specify the image quality.	P.43
Image size (number of pixels)	3040, 2304, 1440	3040	Use this setting to specify the number of pixels in the image (the image size).	P.44
Color	STD, HIGH, ORG, B/W	STD	Use this setting to specify the density of the colors in the image.	P.45
Tone	STD, HARD, ORG	STD	Use this setting to specify the image contrast.	P.46
Sharpness	STD, HARD, OFF	STD	Use this setting to specify the image sharpness.	P.47
Multi-exposure	OFF, ON	OFF	Use this setting to specify whether multi-exposure photography is performed.	P.48

- If you switch the camera off when the data and time have not been set (⇒P.22), the settings specified from the rear display panel and from the “SET-UP” menu on the color LCD monitor revert to the factory default settings.

Settings that can be specified in the "SET-UP" menu on the color LCD monitor

Setting	Display	Factory Default	Description	Ref. Page
PREVIEW	OFF, MANUAL REC, AUTO REC	OFF	Use this setting to specify whether previews of photographed images are displayed for checking.	P.49
CUSTOM WB	EXE	—	Use this setting to specify an independent white balance setting.	P.50
Hi MODE	TIFF-RGB, TIFF-YC	TIFF-RGB	When "Hi" is specified as the Quality setting, use this setting to specify whether the TIFF format used is "RGB" data or "YC" data.	P.51
MEDIA	SmartMedia, CF Type II	Smart Media	Use this setting to specify the type of media used.	P.51
SELF TIMER	2 sec., 10 sec.	10 sec.	When you take pictures using the self-timer, use this setting to specify the interval between the shutter button being pressed and the picture being taken.	P.52
AUTO POWER OFF	2 min., 5 min., OFF	2 min.	Use this setting to specify whether the camera automatically switches off when it is not used and, if so, the interval after which it switches off.	P.52
FRAME No.	ON, OFF	OFF	Use this setting to specify whether the frame number memory function is used.	P.53
PC MODE	DOWNLOADING, SHOOTING	DOWN-LOADING	Use this setting to specify PC mode.	P.54
BEEP	OFF, HIGH, LOW	HIGH	Use this setting to specify the setting for the camera tone.	P.54
LANGUAGE	JAPANESE, ENGLISH	ENGLISH	Use this setting to specify the language used for "SET-UP" menu display.	P.55
DATE/TIME	EXE	—	Use this setting to specify the date and time.	P.22
RESET	EXE	—	Use this setting to reset the settings specified from the color LCD monitor and rear display panel.	P.55, 56

- By setting the optimum white balance for a variety of light sources, pictures can be taken that show the natural colors of the subject while also capturing the atmosphere of the shot.

1 Press the “FUNC” button.

2 The **WB** icon for the white balance setting appears on the rear display panel. Press function button [1].

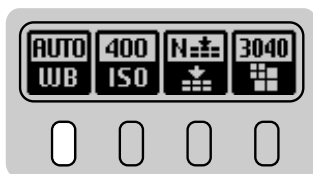





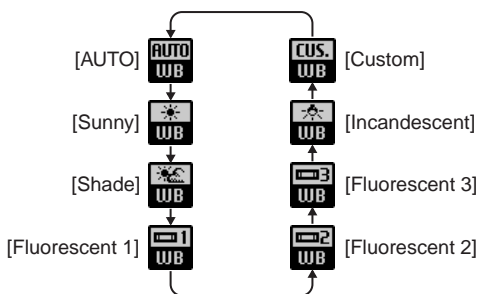



With the white balance set to “AUTO”

- The display changes in the cycle shown below each time function button [1] is pressed.



- The same settings can also be selected by holding down function button [1] and pressing “▲” on the 4-direction button. You can select settings in the reverse order by holding down function button [1] and pressing “▼” on the 4-direction button.

Display	Name	Description
	AUTO (default)	The camera automatically determines the amount of light and the color information for the shot and takes the picture with a natural white balance.
	Sunny	Select this setting for outdoor shots in fine weather when the light source for the shot is the sun.
	Shade	Select this setting for shots taken in shade or on cloudy days.
	Fluorescent 1	Select this setting for shots taken under "Daylight" fluorescent lamps.
	Fluorescent 2	Select this setting for shots taken under "Warm White" fluorescent lamps.
	Fluorescent 3	Select this setting for shots taken under "Cool White" fluorescent lamps.
	Incandescent	Select this setting for shots when the light source is incandescent bulbs or lights.
	Custom	This setting uses the white balance setting specified by the photographer in the "SET-UP" menu (⇒P.50).

- Because white balance settings other than "Custom" are disabled when the flash is used, do not use the flash if you want to achieve a particular effect in your shot.

- The ISO sensitivity (film speed) can be set to 320, 400, 800 or 1600.

1 Press the “FUNC” button.

2 The **ISO** icon for the ISO sensitivity setting appears on the rear display panel. Press function button [2].

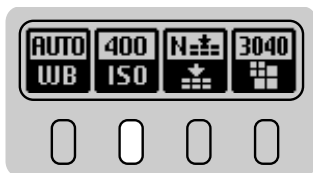

With the ISO sensitivity set to “ISO400”

- The display changes in the cycle shown below each time function button [2] is pressed.

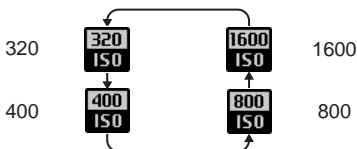

- The same settings can also be selected by holding down function button [2] and pressing “▲” on the 4-direction button. You can select settings in the reverse order by holding down function button [2] and pressing “▼” on the 4-direction button.

Display	Name	Description
	ISO320	Sets the ISO sensitivity to 320.
	ISO400 (default)	Sets the ISO sensitivity to 400.
	ISO800	Sets the ISO sensitivity to 800.
	ISO1600	Sets the ISO sensitivity to 1600.

- Use the procedure below to set the image quality.
Selecting a high image quality decreases the number of images that can be saved. Conversely, selecting a low image quality increases the number of images that can be saved.

1 Press the “FUNC” button.

2 The  icon for the quality setting appears on the rear display panel. Press function button [3].

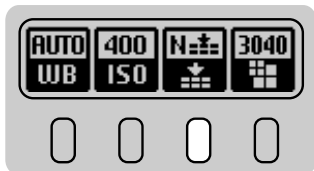



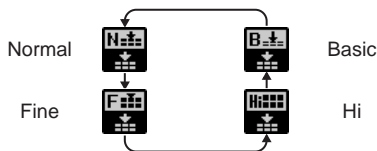

With the quality set to “Normal”

- The display changes in the cycle shown below each time function button [3] is pressed.



- The same settings can also be selected by holding down function button [3] and pressing “▲” on the 4-direction button. You can select settings in the reverse order by holding down function button [3] and pressing “▼” on the 4-direction button.

Display	Name	Description
	Basic	This setting records images at the lowest image quality but also allows the largest number of images to be recorded.
	Normal (default)	This setting records images at the 3rd highest image quality. This setting allows more images to be saved than is possible with the “Fine” setting.
	Fine	This setting records images at the next highest image quality after “Hi” and allows more images to be saved than is possible with the “Hi” setting.
	Hi	This setting records images uncompressed at the highest image quality. With this setting, the fewest images can be recorded.

- Use the procedure below to set the number of pixels (image size) used to record photographed images.

1 Press the “FUNC” button.

2 The  icon for the image size (number of pixels) setting appears on the rear display panel. Press function button [4].

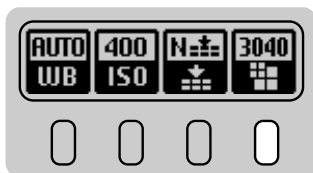

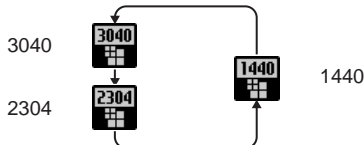

With the image size (number of pixels) set to “3040 × 2016 pixels”

- The display changes in the cycle shown below each time function button [4] is pressed.



- The same settings can also be selected by holding down function button [4] and pressing “▲” on the 4-direction button. You can select settings in the reverse order by holding down function button [4] and pressing “▼” on the 4-direction button.

Display	Name	Description
	3040 (default)	This setting sets the image size to 3040 × 2016 pixels. At this setting, the smallest number of images can be recorded.
	2304	This setting sets the image size to 2304 × 1536 pixels.
	1440	This setting sets the image size to 1440 × 960 pixels. At this setting, the largest number of images can be recorded.

- Use the procedure below to set the density of the color used when images are shot.

- Press the “FUNC” button twice.
- The **Color** icon for the color setting appears on the rear display panel. Press function button [1].

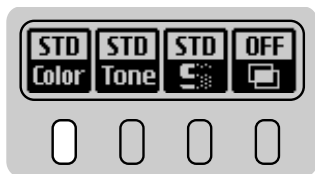

With the color set to “STD”

- The display changes in the cycle shown below each time function button [1] is pressed.

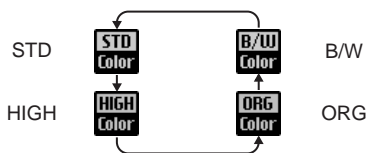

- The same settings can also be selected by holding down function button [1] and pressing “▲” on the 4-direction button. You can select settings in the reverse order by holding down function button [1] and pressing “▼” on the 4-direction button.

Display	Name	Description
STD Color	STD (default)	This setting sets the standard color density.
HIGH Color	HIGH	This setting provides a higher color density than the “STD” setting.
ORG Color	ORG	This setting specifies a lower color density than the “STD” setting. Use this setting for images that will undergo image processing for use in commercial printing.
B/W Color	B/W	This setting converts the colors in the photographed image to black and white.

- If you want to view or print the image data directly, do not select “ORG”.

- Use the procedure below to set the contrast when images are shot.

1 Press the “FUNC” button twice.

2 The **Tone** icon for the tone setting appears on the rear display panel. Press function button [2].

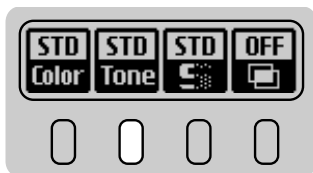

With the tone set to “STD”

- The display changes in the cycle shown below each time function button [2] is pressed.

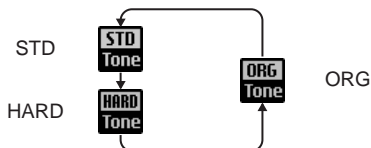

- The same settings can also be selected by holding down function button [2] and pressing “▲” on the 4-direction button. You can select settings in the reverse order by holding down function button [2] and pressing “▼” on the 4-direction button.

Display	Name	Description
	STD (default)	This setting sets the contrast for photographed images to the standard level.
	HARD	Use this setting for images that will undergo image processing for use in commercial printing. This setting provides a higher level of contrast than the “STD” setting.
	ORG	This setting specifies a lower contrast than the “STD” setting. Use this setting for images that will undergo image processing for use in commercial printing.

- If you want to view or print the image data directly, do not select “ORG”.

- Use this setting to soften or sharpen the outlines in an image and to adjust the quality of the photographed image.

- Press the “FUNC” button twice.
- The  icon for the sharpness setting appears on the rear display panel. Press function button [3].

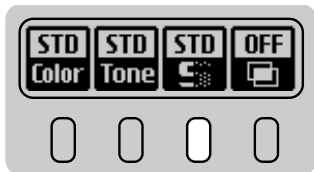

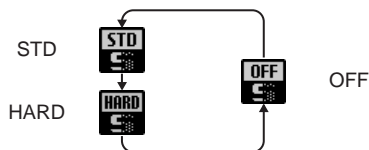

With the sharpness set to “STD”

- The display changes in the cycle shown below each time function button [3] is pressed.



- The same settings can also be selected by holding down function button [3] and pressing “▲” on the 4-direction button. You can select settings in the reverse order by holding down function button [3] and pressing “▼” on the 4-direction button.

Display	Name	Description
	STD (default)	This setting applies the optimum level of sharpness for normal shots.
	HARD	This setting sharpens the outlines in an image and is best for images of subjects such as buildings or text where clarity is important.
	OFF	Sharpness processing is not applied in this setting. Use this setting for images that will undergo image processing for use in commercial printing.

- If you want to view or print the image data directly, do not select “OFF”.

- Use this setting to specify whether to use multi-exposure photography (☞ P.84).

1 Press the “FUNC” button twice.

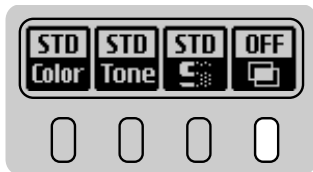

2 The  icon for the multi-exposure setting appears on the rear display panel. Press function button [4].



With multi-exposure photography set to “OFF”

- The display changes in the cycle shown below each time function button [4] is pressed.



Display	Name	Description
	OFF (default)	Select this setting when you do not want to use multi-exposure photography.
	ON	Select this setting when you want to use multi-exposure photography.

- This setting specifies whether or not a preview image is displayed after you take a picture.

1 Press the “MENU/EXE” button. The “SET-UP” menu appears on the color LCD monitor.

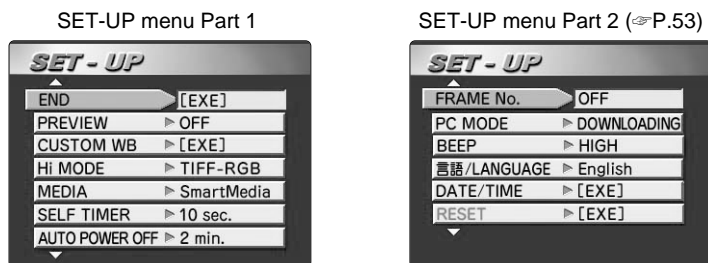

2 Press “▲” or “▼” on the 4-direction button to select “PREVIEW” and then use “◀” or “▶” on the 4-direction button to select the “PREVIEW” setting.

Name	Description
OFF (default)	Images are automatically recorded with no preview image displayed.
MANUAL REC	A preview image is displayed and you can select whether to record the image. <ul style="list-style-type: none"> • To record the image, press function button [1]. • To proceed without recording the image, press function button [2].
AUTO REC	A preview image is displayed for about 1 second and the image is automatically recorded.

- If you record images with preview image display specified, you cannot operate the shutter again until recording is completed.

3 When you have selected the setting, select “END” and press the “MENU/EXE” button.

Note

Preview “MANUAL REC” Function

- The preview “MANUAL REC” function is convenient as a way of checking the exposure and aligning the angle of view, but the image is not recorded unless you instruct the camera to do so. For normal photography, you should use the “OFF” or “AUTO REC” setting.

■ Use the procedure below to specify a custom white balance setting.

1 Press the “MENU/EXE” button.

2 Press “▲” or “▼” on the 4-direction button to select “CUSTOM WB” and then press the “MENU/EXE” button or “◀” or “▶” on the 4-direction button.

- The “SET OK?” message appears on the color LCD monitor.
- Set the focus mode selector switch to “M” (manual focus) (☞ P.58).

3 Photograph a reference white image, such as a sheet of white paper, that occupies an area larger than the center-weighted metering area (☞ P.15). A message then appears indicating whether the photographed image is valid.

- If the photographed image is not valid, respond to the message displayed as follows:

OVER EXPOSURE : The subject is too bright. Apply exposure compensation in the negative (-) direction, select a darker subject or reduce the light level. Then repeat the procedure from step 3.

UNDER EXPOSURE : The subject is too dark. Apply exposure compensation in the positive (+) direction, select a brighter subject or increase the light level. Then repeat the procedure from step 3.

OUT OF RANGE : The image exceeds the compensation range for the custom WB setting. The maximum compensation value is set. To reset the value, press the “CANCEL” button and repeat the procedure from step 3.

- The color temperature range within which the white balance can be matched is approximately 2800K to 9500K.

4 When the photographed image is valid (when **GOOD!** is displayed), press the “MENU/EXE” button.

If the image is not valid, use one of the solutions given in step 3.

- To cancel the setting procedure, press the “CANCEL” button.

5 When you have finished setting the custom white balance, use “▲” or “▼” on the 4-direction button to select “END” and then press the “MENU/EXE” button.

Hi MODE

This setting specifies the TIFF data format when “Hi” is selected as the image quality setting.

- 1** Press the “MENU/EXE” button.
- 2** Press “▲” or “▼” on the 4-direction button to select “Hi MODE” and then press “◀” or “▶” on the 4-direction button to select the “Hi MODE” setting.

Name	Description
TIFF-RGB (default)	This setting selects RGB data as the TIFF format (⇨ P.110)
TIFF-YC	This setting selects YC data as the TIFF format (⇨ P.110)

- To use a TIFF-YC image on your personal computer, you must have an application that supports the TIFF-YC format (such as the USB software supplied).

- 3** When you have selected the setting, use “▲” or “▼” on the 4-direction button to select “END” and then press the “MENU/EXE” button.

MEDIA

This setting specifies whether images are recorded on to a SmartMedia (default setting) or a Microdrive/CompactFlash (CF Type II).

- 1** Press the “MENU/EXE” button.
 - 2** Press “▲” or “▼” on the 4-direction button to select “MEDIA” and then press “◀” or “▶” on the 4-direction button to select the media type.
 - 3** When you have selected the media type, use “▲” or “▼” on the 4-direction button to select “END” and then press the “MENU/EXE” button.
- When only one media is loaded into the camera, images are recorded onto that media regardless of the setting selected here.

SELF TIMER

Use this setting to select either 2 seconds or 10 seconds (default setting) as the interval after which the shutter is released during self-timer photography. See P.72 for information on self-timer photography.

- 1** Press the “MENU/EXE” button.
- 2** Press “▲” or “▼” on the 4-direction button to select “SELF TIMER” and then press “◀” or “▶” on the 4-direction button to select the time interval (2 sec. or 10 sec.).
- 3** When you have selected the time interval, use “▲” or “▼” on the 4-direction button to select “END” and then press the “MENU/EXE” button.
 - Setting a 2-second delay in self-timer photography is useful as a way of avoiding camera shake when using a tripod.

AUTO POWER OFF

Use this setting to specify whether the camera automatically switches off when it is not being used.

- 1** Press the “MENU/EXE” button.
- 2** Press “▲” or “▼” on the 4-direction button to select “AUTO POWER OFF” and then press “◀” or “▶” on the 4-direction button to select the “AUTO POWER OFF” setting.

Name	Description
2 min. (default)	The camera automatically switches off after 2 minutes when left unused.
5 min.	The camera automatically switches off after 5 minutes when left unused.
OFF	The Auto Power Off function is cancelled.

- Regardless of the setting selected here, the Auto Power Off function does not operate during automatic playback or when a USB connection is used.

- 3** When you have selected the setting, use “▲” or “▼” on the 4-direction button to select “END” and then press the “MENU/EXE” button.

- The frame number memory function stores the last file number saved onto a media (SmartMedia or Microdrive) so that when a new media is loaded, file numbers are assigned beginning from that stored file number. The “FRAME No.” setting specifies whether this function is used.

- 1 Press the “MENU/EXE” button.
- 2 Press “▲” or “▼” on the 4-direction button to select “FRAME No.” and then press “◀” or “▶” on the 4-direction button to select the frame number memory setting.
- 3 When you have selected the setting, select “END” and press the “MENU/EXE” button.

Name	Description
OFF (default)	Images are stored starting with file number 0001 on each media.
ON	Images are stored starting with the last file number on the last media used.

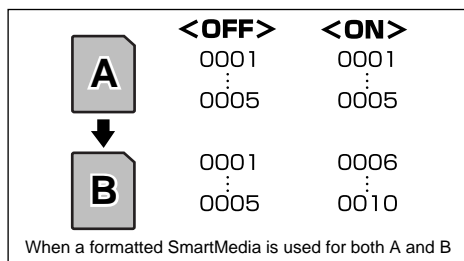

- When a new media already contains an image with a file number higher than the last file number stored by the frame number memory function, new images are stored beginning from the higher file number.

PC MODE

When the camera is connected to a personal computer, this setting specifies whether images are downloaded from the camera to the computer or photography using the camera is controlled from the computer.

- 1** Press the “MENU/EXE” button.
- 2** Press “▲” or “▼” on the 4-direction button to select “PC MODE” and then press “◀” or “▶” on the 4-direction button to select the “PC MODE” setting.
- 3** When you have selected the setting, use “▲” or “▼” on the 4-direction button to select “END” and then press the “MENU/EXE” button.

Name	Description
DOWNLOADING (default)	Select this setting to download images from the camera to the personal computer.
SHOOTING	Select this setting to control photography using the camera from the computer.

- See P.111 for information on connecting the camera to a personal computer.

BEEP

Use the procedure below to set the camera beep to “HIGH” (default setting), “LOW” or “OFF”.

- 1** Press the “MENU/EXE” button.
- 2** Press “▲” or “▼” on the 4-direction button to select “BEEP” and then press “◀” or “▶” on the 4-direction button to select the beep setting.
- 3** When you have selected the setting, use “▲” or “▼” on the 4-direction button to select “END” and then press the “MENU/EXE” button.

LANGUAGE

Use the procedure below to select the language used only in the “SET-UP” menu display. (Menus other than the “SET-UP” menu are shown only in English (default setting) and cannot be set to Japanese-language display.)

- 1** Press the “MENU/EXE” button.
- 2** Press “▲” or “▼” on the 4-direction button to select “LANGUAGE” and then press “◀” or “▶” on the 4-direction button to select the language setting.
- 3** When you have selected the setting, use “▲” or “▼” on the 4-direction button to select “END” and then press the “MENU/EXE” button.

RESET

This setting resets the settings specified on the color LCD monitor and rear display panel.

- 1** Press the “MENU/EXE” button.
- 2** Press “▲” or “▼” on the 4-direction button to select “RESET”.
- 3** To reset the settings you have selected in the menu, press the “MENU/EXE” button. The “RESET OK?” message appears.
 - A list of the items that are reset is given on P.56.
- 4** Press the “MENU/EXE” button to reset the settings. To retain the current settings, press the “CANCEL” button.
- 5** When you have selected the setting, use “▲” or “▼” on the 4-direction button to select “END” and then press the “MENU/EXE” button.

RESET - continued/Camera Reset

Items reset by the “RESET” setting

- Items set from the rear display panel



Item	After Reset
White balance	AUTO
Sensitivity	400
Quality	Normal
Image size (number of pixels)	3040
Color	STD
Tone	STD
Sharpness	STD
Multi-exposure	OFF

- Items set from the color LCD monitor menu

Item	After Reset
PREVIEW	OFF
Hi MODE	TIFF-RGB
MEDIA	SmartMedia
SELF TIMER	10 sec.
AUTO POWER OFF	2 min.
FRAME No.	OFF
PC MODE	DOWNLOADING
BEEP	HIGH
LANGUAGE	ENGLISH
MULTI PLAY (Multi-frame Playback Mode)	OFF

Camera Reset

Use the procedure below to reset the settings specified on the top display panel.

- 1 Hold down the exposure compensation button “” and aperture button “” for 2 or more seconds.**

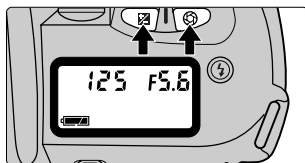

Functions reset from the camera

Function	After Reset
Program Shift	Cancelled.
Exposure Compensation	Cancelled.
Synchro Mode	Slow synchro used when the exposure mode is Night Scene (5-vari program). Normal Synchro otherwise.
Self-timer	Cancelled.

- See P.80 for the initial function statuses and function combinations.

When the Focusing Mode is Set to AF (auto focus)

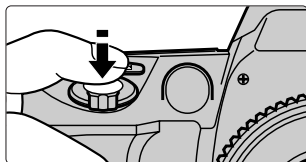
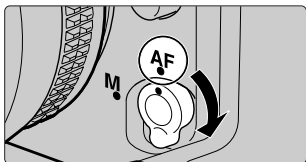

- If you set the focus mode selector switch to AF and hold the shutter button halfway, the camera automatically focuses on the subject and the focus indicator “●” appears in the viewfinder display to notify you that the camera has focused on the subject.

Auto AF servo (AF-A):

In this mode, the camera automatically determines whether the subject is moving and, if so, in which direction the subject is moving, and then selects either single AF servo (AF-S) or continuous AF servo (AF-C) accordingly.

- **Single AF Servo (AF-S):**
The camera focuses on the subject and then fixes the focus (focus lock).
- **Continuous AF Servo (AF-C):**
Focusing tracks the movements of the subject.
- In either mode, the shutter does not release unless the focus indicator appears.
- When you select Sport mode (5-vari program) as the exposure mode, focusing is set to continuous AF servo from the outset and focusing tracks the movements of the subject.

Auxiliary AF Light

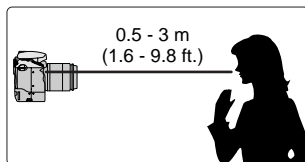
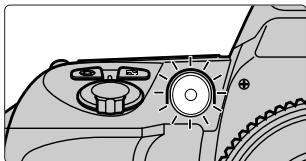

- If the subject is dark, the auxiliary AF light automatically switches on when the shutter button is pressed halfway to illuminate the subject and enable auto focusing. The auxiliary AF light operates under the following conditions:
 1. **When the focusing mode is AF, an AF Nikkor lens is mounted on the camera and the subject is dark.**
 2. **When an exposure mode other than Landscape mode or Sport mode is selected.**

Focusing Modes - continued

When these conditions are met, the auxiliary AF light operates automatically. This function cannot be cancelled. The auxiliary AF light can be used with AF Nikkor lenses that have focal lengths between 24 and 200 mm. In general, the effective range of the auxiliary AF light is 0.5 to 3 m (1.6 to 9.8 ft.).

Note

Continuous use of the auxiliary AF light

If you use the auxiliary AF light continuously, the illuminating lamp temporarily switches off to protect the lamp. You can continue using the lamp after a slight delay.

Important

Nikon flash units and active auxiliary flash

If you use a Nikon flash equipped with active auxiliary flash and take pictures using TTL mode, the active auxiliary flash on the Nikon flash is automatically used. See P.78 for information on the Nikon flash models that can be used.

When M (manual focus) is Selected

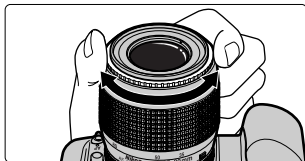
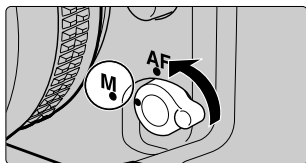

- Set the focus mode selector switch to M and focus the camera by turning the focusing ring on the lens until the image can be seen clearly in the matt surface of the viewfinder screen. The shutter can be released regardless of whether the focus indicator "●" lights. Use manual focus for subjects that are not suitable for auto focusing or when a lens other than an AF Nikkor lens is mounted on the camera (☞ P.107).

Important

Focus Aid

If the lens mounted has an f-step setting brighter than $f/5.6$ when the focusing mode is set to M (manual focus), the "focus aid focusing" feature allows the focus to be checked using the focus display in the viewfinder. Turn the focusing ring on the lens so that the focus indicator "●" lights. The shutter button can be released at any point.

Focus Lock Photography

- If you are using AF (auto focus) to focus the camera, use the focus lock feature when you are composing a picture in which your main subject (the object or person you are focusing on) is not inside the focusing frame. This technique can also be used to focus on subjects that are not suitable for auto focusing.

1 Position the focusing frame over the object or person on which you want to focus and press the shutter button halfway.

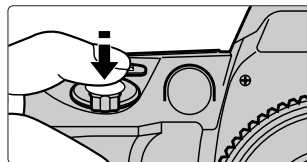
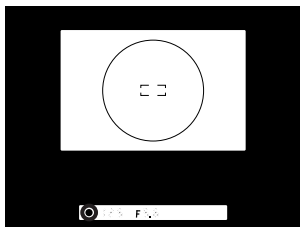

- When the camera is focused, the focus indicator “●” lights and the focus stays locked as long as the shutter button is held halfway.
- If the selected exposure mode is Sport mode (5-vari program), focus lock photography cannot be used.
- If you want to use focus lock when a moving subject stops moving (when the focusing mode changes from continuous AF to single AF servo), release the shutter button and then press the shutter button halfway again.

2 When the focus indicator “●” lights, keep the shutter button held halfway as you compose the picture and then take the picture.

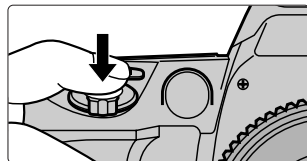
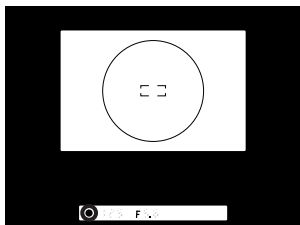

- Once the focus indicator “●” lights, do not change the distance between the camera and the main subject. If you keep your finger on the shutter button and keep the button held down after the shutter has released, you can take any number of shots with the focus fixed at the same setting.

Shooting Using Exposure Modes

AUTO



This exposure mode is the easiest to use for taking pictures since the photographer can leave the exposure settings to the camera. This exposure mode is recommended for people using an SLR camera for the first time.

See P.80 for information on using this mode with other functions.



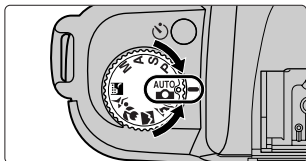

1 Set the exposure mode dial to “”.



- When you select  (AUTO mode), the following function statuses apply:
Metering mode : Multi-pattern metering (⇨ P.69)
Flash :  Normal synchro mode (⇨ P.74)
- The program shift, exposure compensation and slow synchro functions cannot be selected.

2 Check that the focus indicator “●” is lit and take the picture.

- If one of the following warnings appears on the top display panel or viewfinder display, the subject is too bright or too dark and is beyond the camera control range.
 -  : Use an ND (light volume adjustment) filter.
 -  : Use the flash.

Important

Differences between AUTO and Programmed auto

Both modes use the same exposure control method, but the programmed auto mode allows greater flexibility in the photography settings since program shift (⇨ P.61), exposure compensation (⇨ P.71) and slow synchro (⇨ P.75) can also be set.

P: Programmed Auto

In this mode, the camera automatically controls the exposure to give the optimum exposure for the photography conditions. This mode can be used in combination with program shift or exposure compensation (⇨ P.71) for better quality pictures. See P.80 for information on using this mode with other functions.



1 Set the exposure mode dial to “P”.

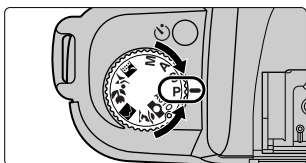

2 Check that the focus indicator “●” is lit and take the picture.

- If one of the following warnings appears on the top display panel or viewfinder display, the subject is too bright or too dark and is beyond the camera control range.
 - H : Use an ND (light volume adjustment) filter.
 - L : Use the flash.

Important

Program Shift

By turning the command dial during programmed auto mode photography, you can change the combination of shutter speed and aperture while maintaining the same exposure, providing operation that is equivalent to the shutter-priority auto and aperture-priority auto modes. During program shift, “P” is displayed on the top display panel. To cancel program shift, reset shutter speed and aperture settings to their original values, select another exposure mode, switch the camera off, use the built-in flash (⇨ P.74) or perform a camera reset (⇨ P.56).

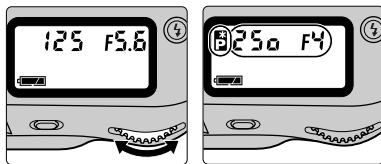

Shooting Using Exposure Modes - continued

S: Shutter-priority Auto

In this mode, the photographer sets the shutter speed (1/2000 to 30 sec.) and the camera automatically controls the aperture setting. This mode is best for photographs where the shutter speed is the main priority, such as subjects in sports scenes where you want a fast shutter speed to freeze one moment of the action, or where you want a slow shutter speed to emphasize the sense of movement.



See P.80 for information on using this mode with other functions.

- 1** Set the exposure mode dial to “S” and set the shutter speed on the command dial (1/2000 to 30 sec.).

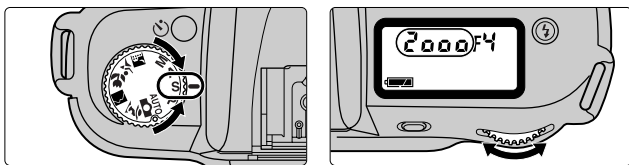

- 2** Check that the focus indicator “●” is lit and take the picture.

- If one of the following warnings appears on the top display panel or viewfinder display, the subject is too bright or too dark and is beyond the camera control range.
 - $H \downarrow$: Set a faster shutter speed. If the warning still appears with the faster shutter speed, use an ND (light volume adjustment) filter.
 - $L \uparrow$: Set a slower shutter speed. If the warning still appears with the slower shutter speed, use the flash.
- Pressing the “CANCEL” button during a long-exposure shot does not interrupt the shot.

A: Aperture-priority Auto

In this mode, the photographer sets the aperture (narrowest aperture to widest aperture) and the camera automatically controls the shutter speed. This mode is best for photographs where the depth of field is the main priority, such as shots where you both near and distant objects in clear focus or where you want the background out of focus. You can also use this mode to vary the flash control range by changing the aperture when you are taking pictures with the flash (☞ P.74).
See P.80 for information on using this mode with other functions.



- 1** Set the exposure mode dial to “A” and set the aperture setting (narrowest aperture to widest aperture) on the command dial.

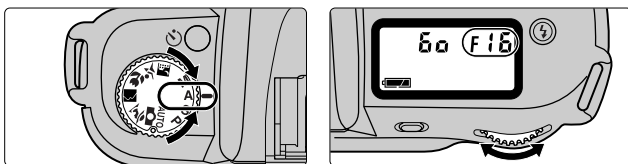

- 2** Check that the focus indicator “●” is lit and take the picture.

- If one of the following warnings appears on the top display panel or viewfinder display, the subject is too bright or too dark and is beyond the camera control range.
 - H : Set a higher aperture setting. If the warning still appears with the higher aperture setting, use an ND (light volume adjustment) filter.
 - L : Set a lower aperture setting. If the warning still appears with the lower aperture setting, use the flash.

Shooting Using Exposure Modes - continued

M: Manual

In this mode, the photographer can set any shutter speed (1/2000 to 30 sec.) and any aperture setting (narrowest aperture to widest aperture). This allows the photographer to determine the exposure to suit the conditions and the desired goals while watching the exposure indicator in the viewfinder.

See P.80 for information on using this mode with other functions.



1 Set the exposure mode dial to “M” and compose the picture.

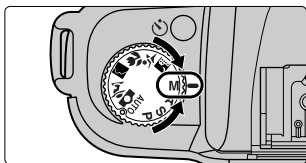

- M: In manual mode, the metering mode is automatically switched from multi-pattern metering to center-weighted metering (⇨ P.69).

2 Set the shutter speed and aperture setting while watching the exposure indicator in the viewfinder.

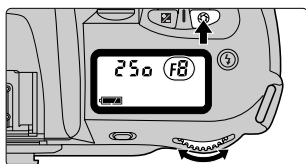
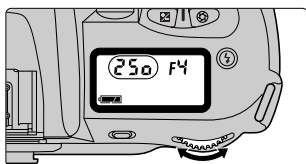

- Set the shutter speed (1/2000 to 30 sec.) on the command dial.
- Set the aperture setting (narrowest aperture to widest aperture) by using the command dial while holding down the aperture button “□”.
- Either setting (shutter speed or aperture) can be set first.

Important

Exposure Indicator

The figures at right show how to read the exposure indicator. The icons show the difference between the value given by the combination of shutter speed and aperture setting and the exposure value measured by the camera.

Correctly exposed or over- or under-exposed by less than 0.5 EV steps



Under-exposed by 0.5 EV steps or more but less than 1.5 EV.



Over-exposed by 1.5 EV or more



3 Check that the focus indicator “●” is lit and take the picture.

- Lenses other than a Nikkor lens with a built-in CPU can only be used in this mode. However, the camera's exposure meter cannot be used and the aperture cannot be set using the aperture button and command dial. See “Lenses that Can Be Used with this Camera” on P.106 for details.

Shooting Using 5-Vari Programs

5-Vari Programs

The 5-vari programs provide programs for each mode that make it easy for you to take pictures that capture your desired image. The programs tailor the camera settings to particular scenes or subjects by selecting shutter speeds matched to the subject's movement and aperture settings that allow for the depth of field (focusing depth) and even the focusing characteristics of the lens.

See P.80 for information on using 5-vari programs with other functions.

Taking Pictures Using 5-Vari Programs

Set the exposure mode dial to the desired 5-vari program, check that the focus indicator “●” is lit, and then take the picture.

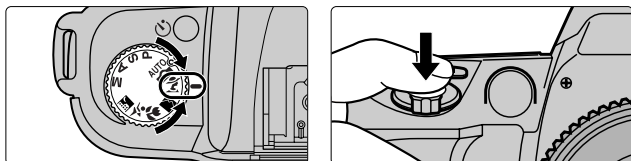

- If one of the following warnings appears on the top display panel or viewfinder display, the subject is too bright or too dark and is beyond the camera control range.
 - H f : Use an ND (light volume adjustment) filter.
 - L a : Use the flash.

Note

Points to note when using 5-vari programs

Program shift (☞ P.61) and exposure compensation (☞ P.71) are both cancelled in the 5-vari program modes. If you use the flash, the synchro mode is automatically switched according to the mode (☞ P.76).

5-Vari Program Types and Features

Portrait mode

By using exposure control with a wide aperture (a low aperture number), this mode keeps a shallow depth of field (restricting the range of focus in front of and behind the subject). This allows you to take pictures in which your subject stands out clearly against a softly blurred background, giving a feeling of depth in the shot.

Recommended lens: The most effective lenses for this mode are bright telephoto lenses in the 50 to 135 mm range.



Landscape mode

By using exposure control with a narrow aperture (a high aperture number), this mode gives a large depth of field (extending the range of focus in front of and behind the subject) to allow you to take pictures of scenery in which the both near and distant objects are in sharp focus.

Lenses from wide-angle through to telephoto can be used in this mode.

- In some photography conditions care is needed to avoid camera shake since a slow shutter speed may be used. (A tripod should be used in such situations.)



Close-up mode

This mode uses exposure control with a wide aperture to give a relatively shallow depth of field so that you can take close-up shots in which your subject stands out clearly against a softly blurred background.

Recommended lens: The most effective lenses for this mode are the Micro Nikkor lenses.

- In some photography conditions care is needed to avoid camera shake since a slow shutter speed may be used. (A tripod should be used in such situations.)



Shooting Using 5-Vari Programs - continued

Sport mode (continuous shooting)

This mode uses exposure control with a fast shutter speed setting to freeze your subject in a moment of rapid movement and allow you to take shots of sporting events that capture the feeling of fast-paced action. Recommended lens: The most effective lenses for this mode are telephoto lenses in the 80 to 300 mm range.



- In Sport mode, the focusing mode switches to continuous AF servo without focus lock so that the camera focus tracks the movements of your subject. Also, if "PREVIEW" (P.49) is set to "OFF", the camera shoots pictures continuously for as long as the shutter button is held down. The maximum number of continuous frames is 5.
- The shutter will not release if the number of available shots is highlighted.

Note

Using continuous shooting when the number of remaining frames displayed is small

If you use continuous shooting when the number of remaining frames displayed is small, a warning beep may sound and the number of remaining frames displayed may show 0 even when the number of shots taken is fewer than the number of shots displayed when continuous shooting began.

Night scene mode

This mode uses exposure control that is tailored to dimly lit subjects and allows you to effectively capture beautiful evening or night scenes.

Also, when you are shooting people against an evening backdrop, you can use the flash to capture both your subjects and the background as they appear naturally. Lenses from wide-angle through to telephoto can be used in this mode.



- In some photography conditions care is needed to avoid camera shake since a slow shutter speed may be used. (A tripod should be used in such situations.)

Metering Modes

- The FinePix S1 Pro normally uses multi-pattern exposure metering. However, when the exposure mode is set to Manual or the AE lock (⇨ P.70) is used, exposure metering automatically switches to center-weighted metering.

Multi-pattern Metering and 3D 6-zone Multi-pattern Metering

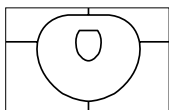

In multi-pattern metering, the image is divided into 6 zones as shown in the figure above. Each of the 6 zones is measured independently and that information is then used to determine the optimum exposure. When a D-type AF lens is mounted on the camera, 3D 6-zone multi-pattern metering is used. In this mode, information on the maximum brightness in the image and the differences in brightness is also included, along with information on the distance from the lens to the subject, to give heightened metering precision. Except where the exposure mode is set to Manual or AE lock (⇨ P.70), multi-pattern metering is used for all shots.

Center-weighted Metering

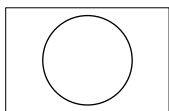

In center-weighted metering, emphasis is placed on the central area of the viewfinder (a circle roughly 12 mm in diameter) when the exposure is measured to determine the exposure setting. Consequently, this mode is best for shots where you want the area inside that 12 mm circle to be the exposure reference. When the exposure mode is set to Manual (⇨ P.64) or AE lock (⇨ P.70) is used, metering is automatically switched to this mode.

AE Lock Photography

■ AE lock allows you to set the exposure for a part of the image that you want to be correctly exposed, and then lock in that exposure setting when you take the picture. This technique is useful when you want to store an exposure setting in the camera (by pressing the “AE-L” AE lock button) and then keep the same exposure setting as you change your subject’s pose or the composition of the shot. Regardless of the selected exposure mode, the exposure metering mode is automatically switched to center-weighted metering.

- 1** Position your subject in the center of the image, hold the shutter button halfway and press the “AE-L” AE lock button.

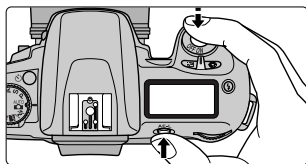
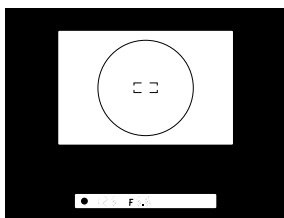

- 2** With the “AE-L” button held down, return to the shot composition you want to photograph, focus the shot and then take the picture.

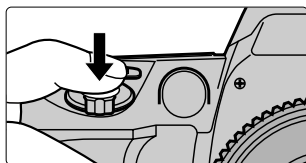
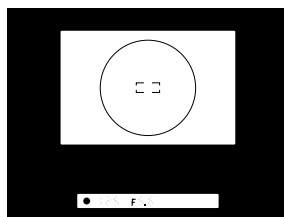

Exposure Compensation

- Exposure compensation is a procedure in which you can intentionally change the correct exposure setting displayed by the camera. For example, this mode can be used to shift the exposure in small steps when the subject has high levels of contrast. On the FinePix S1 Pro, exposure compensation can be performed to ± 3 EV in increments of $1/3$ of an EV step. (Note that exposure compensation cannot be used in AUTO mode or in the 5-vari program modes.)

1 Hold down the exposure compensation button “” and set the amount of compensation on the command dial.

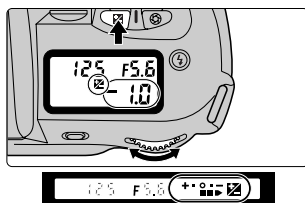

- Example of exposure indicator display

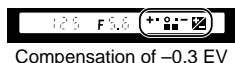

- When you set the amount of compensation, the exposure compensation icon “” appears on the top display panel and in the viewfinder display. Simply press the exposure compensation button to confirm the compensation amount. (The exposure indicator is also displayed.)
- When the built-in flash or an external Nikon flash is used, the amount of light emitted by the flash is also adjusted by the same amount. However, the restrictions described below apply.

- Maximum flash compensation values for flash units used with exposure compensation

ISO	320	400
+ compensation	3 EV	3 EV
- compensation	approx. 1.5 EV	approx. 1 EV

- As a general guide, when the subject (eg. a person) is set against a bright background, positive exposure compensation should be used. Against a dark background, negative exposure compensation should be used.

2 Compose the picture, focus and shoot.

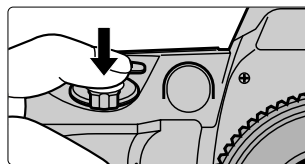
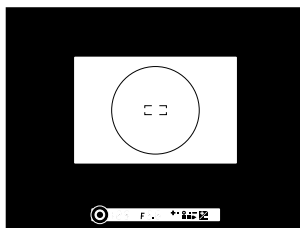

- To cancel exposure compensation, hold down the exposure compensation button and use the command dial to set the compensation amount to 0, or reset the camera (⇨ P.56). (Switching the camera off does not cancel exposure compensation.)

3

Self-timer Photography

- This mode is useful for shots such as commemorative pictures where the photographer also wants to be in the shot. Use a tripod or otherwise ensure that the camera is stable before using the self-timer.

1 Press the self-timer button “⌚”. The “⌚” icon appears on the top display panel.

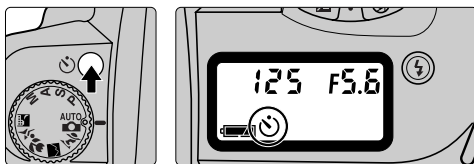

- The self-timer will not operate if the camera shutter cannot release, such as when the camera cannot focus using AF (auto focus).
- If you are not using the M (manual) exposure mode to take the shot, cover the eyepiece with your hand or with the eyepiece cap provided (⇨ P.73) before you press the shutter button to prevent interference to achieve correct exposure from stray light.
- If you are using AF (auto focus) to focus the camera, take care not to stand in front of the lens when you operate the self-timer.

2 Compose the shot, focus and then press the shutter button.

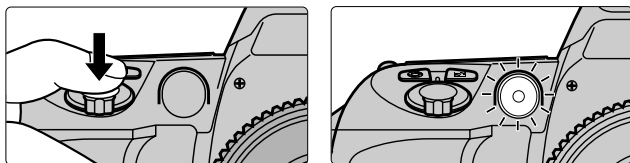

- When the self-timer setting is “10 sec.”, the “⌚” icon flashes for 10 seconds on the top display panel when the self-timer starts running. The self-timer lamp flashes for 8 seconds and then remains lit for the last 2 seconds before the shutter releases. If you have selected red-eye reduction mode (⇨ P.75), the self-timer lamp lights for the last 2 seconds at the brightness used for red-eye reduction mode shooting.
- To cancel self-timer mode, press the self-timer button “⌚” again either before or during self-timer operation, or switch the camera off. You can also cancel self-timer mode by performing a camera reset (⇨ P.56).

Dioptr Adjustment Function/Eyepiece Cap

- The diopter adjustment function makes it easier for you to check your shots by looking at the image through the viewfinder.

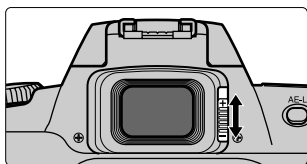

- While you are looking through the viewfinder, slide the diopter adjustment knob to the position in which you see the focusing frame in the viewfinder most clearly. The setting can be adjusted between -1.5 and 1.0 dpt (near-sighted to far-sighted). Also, 9 types of Nikon diopter adjustment lens are also available ranging from -5.0 to +3.0 dpt.

Note

Points to watch when sliding the diopter adjustment knob

When you are sliding the diopter adjustment knob as you look through the viewfinder, because your fingers are very close to your eye, take care not to injure your eye with your fingertip or fingernail.

- Attaching viewfinder accessories such as the eyepiece cap and diopter adjustment lenses

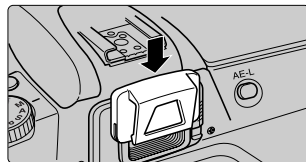
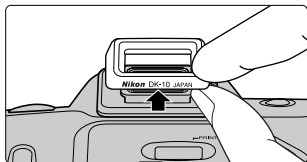

- To attach the eyepiece cap or a diopter adjustment lens to the viewfinder eyepiece, remove the eyepiece surround and fit the accessory onto the viewfinder eyepiece starting from the top. To remove eyepiece cap or diopter adjustment lens and re-attach the eyepiece surround, fit the eyepiece surround so that the "Nikon DK-10 JAPAN" lettering on the surround is on the lower edge.

Flash Photography

Built-in Flash and TTL-BL Flash Control

The built-in flash in the FinePix S1 Pro covers the field of view for a 28 mm lens and has a guide number of 15 (ISO 100·m). The flash also features TTL-BL flash control that uses brightness information obtained using multi-pattern exposure metering to effectively control and balance the amount of flash so that both the main subject and the background are correctly exposed. This allows you to take natural looking pictures using the flash (when a Nikkor lens with built-in CPU is used). As well as in low-light conditions, you can use the flash as a supplementary light source to reduce shadowing on your main subject in outdoor shots taken in daylight or when you want to add catch lights to your subject's eyes.

The FinePix S1 Pro also provides 4 synchro modes: Normal synchro, red-eye reduction, slow synchro and red-eye reduction slow synchro.

- When the lens used is not a Nikkor lens with built-in CPU, TTL flash control is used in which allowance is not made for exposing the background.
(Wherever possible, use a Nikkor lens with a built-in CPU.)

Flash Control Range (Effective Flash range)

The flash control range (effective flash range) varies depending on the selected ISO sensitivity and aperture settings. Refer to the table below for the flash control range details when the built-in flash is used.

ISO	320	400
Guide number	27	30
f-stop (aperture)	Flash control range	Flash control range
2.8	2.2-10.3m (7.2 - 33.8 ft.)	2.5-11.5m (8.2 - 37.7 ft.)
4	1.8-8.7m (5.9 - 28.5 ft.)	2.0-9.7m (6.6 - 31.8 ft.)
5.6	1.3-6.3m (4.3 - 20.7 ft.)	1.5-6.8m (4.9 - 22.3 ft.)
8	0.8-4.3m (2.6 - 14.1 ft.)	1.0-4.8m (3.3 - 15.7 ft.)
11	0.8-3.2m (2.6 - 10.5 ft.)	1.0-3.6m (3.3 - 11.8 ft.)

- If you are shooting at distances as close as 1 meter, select the aperture-priority exposure mode ("A") and use an f-stop of number of at least 8.
- When the sensitivity is set to ISO 800 or ISO 1600, the built-in flash will fire but flash control may not be performed correctly.
Shoot in preview mode so that you can check the exposure.

Synchro Mode Types and Features

: Red-eye reduction mode

If you select red-eye reduction mode and then take a picture using the flash, the red-eye reduction lamp lights for about 1 second before the flash fires, thereby reducing the tendency for people's eyes to appear red in pictures taken in low-light conditions.



: Slow synchro mode

In flash photography, the shutter speed is normally set automatically to 1/125 sec. However, in slow synchro mode, a slower shutter speed is used to allow the background to be exposed also. This allows you to take pictures that capture the full atmosphere of an evening or night scene.



- You can set red-eye reduction mode and slow synchro mode concurrently by selecting the modes so that red-eye reduction slow synchro mode icon  appears in the top display panel.
- The synchro modes that can be set may vary depending on the exposure mode. See "Combining Modes" on P.80 for information on the possible combinations of synchro modes and exposure modes.

Note

Notes on the Synchro Modes

- In red-eye reduction mode and slow synchro red-eye reduction mode, because there is a 1 second delay for the red-eye reduction lamp to operate before the flash fires, care must be taken that the subject does not move until the shutter actually releases. (These modes should not be used in situations such as snapshots where you need the camera to respond immediately.)
- Depending on which lens is mounted on the camera, the light from the red-eye reduction lamp may be obstructed by the lens so that the effect of red-eye reduction is lost for people in some positions in the shot.
- In slow synchro mode and slow synchro red-eye reduction mode, take care to avoid camera shake since a slower than usual shutter speed is used. (A tripod should be used.)

Taking Pictures Using the Built-in Flash

- 1** Press the flash lock release button so that the flash pops up. Then hold down the synchro mode button “ $\frac{1}{2}$ ” and turn the command dial to set the synchro mode.

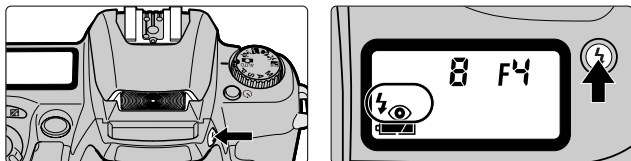

- When the flash pops up, it starts charging. When charging is complete, the Ready icon “ $\frac{1}{2}$ ” appears in the viewfinder display.
- When normal synchro mode “ $\frac{1}{2}$ ” is selected, the “ $\frac{1}{2}$ ” on the top display panel disappears when you take your finger off the synchro mode button “ $\frac{1}{2}$ ”.
- To stow the flash, push it down gently by hand.
- The built-in flash cannot be used when the battery adapter is used.

2 Set the exposure mode and check the shutter speed and aperture setting.

- The table below shows the shutter speeds and aperture settings that can be specified in each of the exposure modes.

Exposure Mode	Valid Shutter Speeds	Valid Apertures	Ref. Page
AUTO mode Programmed auto 5-vari program	Automatically set by the camera	Automatically set by the camera	☞ P.60 ☞ P.61 ☞ P.66
Shutter-priority auto	1/125 to 30 sec. *1		☞ P.62
Aperture-priority auto	Automatically set by the camera	Any aperture *2	☞ P.63
Manual	1/125 to 30 sec. *1		☞ P.64

*1: If a shutter speed faster than 1/125 sec. is selected, the shutter speed is automatically reset to 1/125 sec. when the flash unit pops up. (When a Nikon flash unit is used, the shutter speed is reset when you switch the flash unit on.)

*2: The flash control range is determined by the ISO sensitivity and aperture settings. When you set the aperture in aperture-priority auto or manual mode, allow of the flash control range shown on P.74.

3 Check that the Ready icon “ - If the Ready icon “Flash Intensity

The intensity of the flash varies depending on the composition of the shot and can detract from the intended exposure for the main subject. If this occurs, take the shot using exposure compensation (➡ P.71).

Lenses that Can Be Used with the Built-in Flash

Nikkor lenses with built-in CPUs from 28 to 200 mm can be used with the built-in flash.

- The AF 300 mm f/4 can be used.
- The AF-S 17-35 mm f/2.8 and AF 20-35 mm f/2.8 lenses cannot be used.
- Remove the lens hood.
- Zoom lenses with macro settings cannot be used for macro photography.
- The table below lists the lenses on which vignetting occurs and reduces the amount of light around the periphery of the image. Restrictions apply to the focal lengths and distances at which these lenses can be used.

AF Zoom Lenses Affected by Vignetting	Notes
AF24-50mm f/3.3-4.5	Can be used at 35 mm or higher.
AF24-120mm f/3.5-5.6	Can be used at 35 mm for 1.5 m or higher and at 50-70 mm for 1 m or more.
AF-S ED 28-70mm f/2.8	Can be used at 70 mm for 1.2 m or higher.
AF28-85mm f/3.5-4.5	Can be used at 35 mm for 1.5 m or higher.
AF28-200mm f/3.5-5.6	Can be used at 35 mm or higher.
AF35-70mm f/2.8	Can be used at 50 mm or higher.
AF70-180mm f/4.5-5.6	Can be used at 70 mm for 1.5 m or higher and at 85 mm for 1 m or more.
AF-S ED 80-200mm f/2.8	Can be used at 105 mm or higher. However, this lens cannot be used at 105 mm at 2 m or less.

Flash Photography - continued

Nikon Flash Units that Can Be Used

The table below shows the Nikon flash units that can be used with the FinePix S1 Pro and the types of photography they can be used for. (Note that the built-in flash and a Nikon flash unit cannot be used together.) This explanation assumes that the lens mounted on the camera is a Nikkor lens with a built-in CPU. (Lenses other than Nikkor lenses with a built-in CPU should not be used.)

Available Photography Modes Flash Model	TTL-BL flash control (*1)	Automatic external flash control	Manual	Multi-flash	Slave flash
SB-28	○	○	○	○	—
SB-27	○	○	○	—	—
SB-26	○	○	○	○	○
SB-25					
SB-24	○	○	○	○	—
SB-23	○	—	○	—	—
SB-21B (*2)					
SB-22					
SB-22s					
SB-20	○	○	○	—	—
SB-16B					
SB-15					
SB-11 (*3)					
SB-14 (*3)	○	○	○	—	—
SB-140 (visible light)(*3)					

○: Usable

—: Not usable

*1: If the exposure mode is set to Manual, simple TTL-BL flash control (⇨ P.74) is used.

*2: When the SB-21B is used, auto focus can only be used to take pictures when the AF micro lens (60, 105, 200 or 70-180 mm) is mounted on the camera.

*3: If TTL mode is used with the SB-11, SB-14 or SB-140, the flash unit must be connected using the Nikon SC-23 TTL flash control cord.

If these flash units are used in A mode or M mode, the Nikon Sensor Unit SU-2 is used with the SC-13 for the SB-11 and SB-14, and the Nikon Sensor Unit SU-3 is used with the SC-13 for the SB-140. Alternatively, the SC-11 or SC-15 can be connected with the Nikon Sync Terminal Adapter AS-15.

● For details, refer to the instructions provided with your flash unit.

If your Nikon flash unit has instructions which include a table of camera types and it is capable of TTL mode, refer to the section for D group cameras.

Notes on Using Nikon Flash Units

- The synchronized shutter speeds when using the flash are 1/125 sec. and slower.
In TTL mode, the ISO sensitivity linked settings are ISO 320 or ISO 400.
- * When the sensitivity is set to ISO 800 or ISO 1600, the TTL flash control may not be performed correctly.
- Red-eye reduction is performed using the red-eye reduction lamp on the camera.
- If the Nikon flash unit is equipped with an active auxiliary flash function, the active auxiliary flash on the flash unit automatically fires instead of the auxiliary AF light on the camera. However, if the selected mode is not TTL, the auxiliary AF light on the camera automatically lights.
- To use the flash to take pictures in modes other than TTL, set the exposure mode to A or M.
- When the exposure mode is set to AUTO or P, the widest aperture setting that can be automatically set by the camera is controlled by the selected sensitivity, as shown in the table below.

Selected Sensitivity (ISO)	320	400
Widest aperture setting (built-in flash)	4	4
Widest aperture setting (Nikon flash)	5.6	5.6

- * If the widest aperture is darker than the aperture setting permitted by the sensitivity, the aperture is determined by the widest f-stop setting for the lens mounted on the camera.
- For close-up or wide-angle photography, a flash unit with automatic external flash control should be used.
 - When a synchro terminal is required, use the Nikon Sync Terminal Adapter AS-15 (sold separately).
 - Do not use flash units not manufactured by Nikon (flash units that apply 250 V or more to the X contact on the camera or that make contact at multiple points on the small contacts on the accessory shoe). This could not only result in camera malfunctions but could also damage the synchronizing circuits in the camera and the flash.

Combining Modes

- The table below shows the permitted combinations of exposure modes and functions. This explanation is based on the FinePix S1 Pro used with an AF Nikkor lens (excluding the AF-S, AF-I, IX Nikkor and F3AF lenses).

Function	AF mode	Auxiliary AF light	Program shift	Exposure compensation	Metering mode (*1)	Normal synchro	Red-eye reduction	Red-eye reduction slow synchro	Slow synchro
Exposure Mode	P.57	P.57	P.61	P.71	P.69	P.76	P.75	P.75	P.75
AUTO	AF-A	○	—	—	Multi-pattern	⊙	○	—	—
P Programmed auto	AF-A	○	○	○	Multi-pattern	○	○	○	○
S Shutter-priority auto	AF-A	○	—	○	Multi-pattern	○	○	—	—
A Aperture-priority auto	AF-A	○	—	○	Multi-pattern	○	○	○	○
M Manual (*2)	AF-A	○	—	○	Center-weighted	○	○	—	—
Portrait	AF-A	○	—	—	Multi-pattern	⊙	○	—	—
Landscape	AF-A	—	—	—	Multi-pattern	⊙	○	—	—
Close-up	AF-A	○	—	—	Multi-pattern	⊙	○	—	—
Sport	AF-C	—	—	—	Multi-pattern	⊙	○	—	—
Night scene	AF-A	○	—	—	Multi-pattern	—	—	○	⊙

AF-A: Auto AF servo

AF-C: Continuous AF servo

○: Can be set.

⊙: This mode is automatically set when you set the exposure mode. (However, other synchro modes can be selected.)

—: Cannot be set.

*1: Whichever exposure mode is set, center-weighted exposure metering is selected when AE lock is used (⇨ P.70).

*2: If the lens mounted on the camera is not a Nikkor lens with a built-in CPU, pictures can only be taken in the M (manual) exposure mode. However, the camera's exposure meter cannot be used and the aperture cannot be set using the aperture button and command dial. (Use the aperture ring on the lens to set the aperture.) See also "Lenses that Can Be Used with this Camera" on P.106.

● The synchro modes are controlled by the TTL-BL flash control (⇨ P.74), but if the exposure mode is set to M (manual), simplified TTL-BL flash control is used in which only approximate allowance is made for background exposure.

Shooting and Recording Previews

- This section describes how to display a preview image of the shot you have taken on the color LCD monitor and then record that image.

Note

Preview Setup

In order to display a preview image and then record or erase the image, you must first set the “PREVIEW” setting to “MANUAL REC”, as described in “Preview” (P.49) in Setup. This function will not work if any other setting is selected. Also, to record the image in this mode, you must take the steps described below after taking the shot.

- 1 Take a picture in the normal way.



- 2 To record the image displayed on the preview screen, press function button [1] or press the “MENU/EXE” button.
If you do not take this step, the image is not recorded.

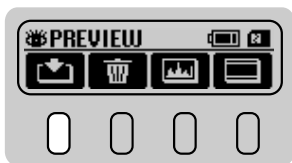

If you do not want to record the image, press function button [2] or press the “CANCEL” button, or press the shutter button halfway (the image is cleared from the preview screen).

Standard Chart Display

- Standard chart display is a feature that allows you to check the color tones and brightness of a photographed image by comparing the preview image with a color bar or grayscale indicator.

1 Display the preview image (⇨ P.49, 81).

2 Press function button [4] to display the Standard chart.

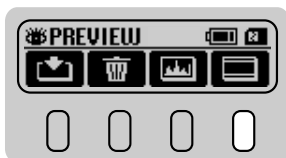

- You can clear the display by pressing function button [4] again.

Histogram Display

- A histogram is a graph that classifies the light and dark portions of an image and shows the statistical distribution of brightness in that image. This section describes how to display the histogram for an image. Histograms can be displayed for both playback images and preview images.
- To view the preview image histogram

1 Display the preview image (⇐ P.49, 81).

2 Press function button [3] to select the histogram you want to view.

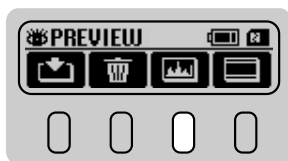

"Brightness"

- The histogram icon displayed on the rear display panel changes in the cycle shown below each time function button [3] is pressed.

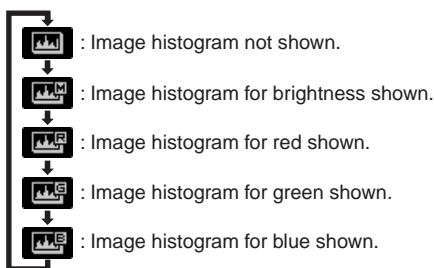

- The same procedure can be used when you are viewing a playback image. In that situation, press function button [1].

Multi-exposure

- Multi-exposure is photography method in which other images can be overlaid on top of an existing image. Any number of images can be overlaid in this way.

Note

Multi-exposure Setup

To use multi-exposure photography, you must first set the multi-exposure setting to "ON" as described in "Setting Multi-exposure" in Setup (P.48). If "OFF" is selected, this function will not work. Note that if multi-exposure is set to "ON", the preview image is displayed on the color LCD monitor regardless of whether the "PREVIEW" setting is selected in the "SET-UP" menu.

1 Take a picture in the normal way.

- The preview image is displayed.

2 Press function button [2].



3 Locate the image to be overlaid in the viewfinder and press the shutter button fully.

- You can overlay any number of images by repeating steps 2 and 3.
- If you do not want to overlay an image onto the photographed image, locate the subject in the viewfinder and press the shutter button down fully without pressing function button [2].

4 To record the overlaid images, press function button [1] or press the "MENU/EXE" button.



- If you do not want to record the image, press function button [3] or press the "CANCEL" button.

Functions available from the rear display panel

- Functions that can be used with images played back

Function	Description	Ref. Page
Histogram display	Classifies light and dark areas in the image and displays their statistical distribution.	☞ P.83
Erase frame	Erases the displayed image.	☞ P.35
Protect frame setting	Protects the displayed image to prevent accidental erasing.	☞ P.88
DPOF frame setting	Sets DPOF information for the displayed image.	☞ P.93
Playback zoom	Displays the current image enlarged.	☞ P.32

Functions available from the playback menus on the color LCD monitor

- Functions that can be used by pressing the "MENU/EXE" button when the image is displayed on the color LCD monitor

Function	Description	Ref. Page
ERASE/FORMAT	Can be used to erase all the images on a media or format the media.	☞ P.86
MULTI PLAY setting	Can be used to set the number of images displayed when multiple frames are displayed on the color LCD monitor.	☞ P.33
PROTECT setting	Protects all the images to prevent accidental erasing.	☞ P.89
DPOF settings	Can be used to set DPOF information for all the images and to display only those images for which DPOF information is set and then delete the settings. When the images are printed, these settings can specify that the date and time of shooting are also shown.	☞ P.91
AUTO PLAY setting	Can be used to specify sequential playback of the recorded images.	☞ P.101
Color LCD monitor BRIGHTNESS adjustment	Adjusts the brightness of the color LCD monitor.	☞ P.103

Erase/Format

Erase All/Format

When you select the Erase All option, all the unprotected images are erased. If you select the Format option, all the images are erased, including any protected images, and the media is initialized for the FinePix S1 Pro. To erase only one of the recorded images, see P.35.

- 1** On the rear display panel, check the media type from which the images are to be erased.



For a "SmartMedia"

- To select a different media type, select "MEDIA" in the "SET-UP" menu (⇨ P.51).

- 2** Press the "PLAY" button to display the image.

- 3** Press the "MENU/EXE" button to display the "ERASE" menu.

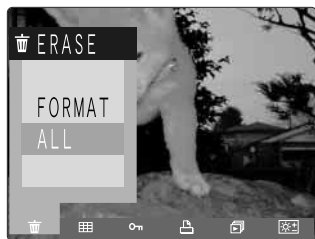
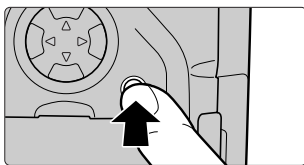

- 4** To erase all the unprotected frames, use "▲" or "▼" on the 4-direction button to select "ALL". To format the media, select "FORMAT".

5 Press the “MENU/EXE” button and then select “YES” to execute “(ERASE) ALL” or “FORMAT”.

- To cancel the procedure, use “▲” or “▼” on the 4-direction button to select “NO” and then press the “MENU/EXE” button.

6 Press the “MENU/EXE” button. The “(ERASE) ALL” or “FORMAT” procedure ends and the “NO IMAGES” message is displayed. Press the “PLAY” button or press the shutter button down halfway to return to photography mode.

- If you try to erase all the images when DPOF settings have been specified for any of the images, an erase confirmation message appears. Check the images and then press the “MENU/EXE” button.

Protection Settings

Protecting and Unprotecting Individual Image

- 1 Press the “PLAY” button and then press “◀” or “▶” on the 4-direction button to display the image for which you want to set or remove the protection.

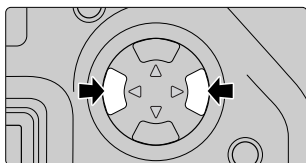

- 2 Press function button [3].

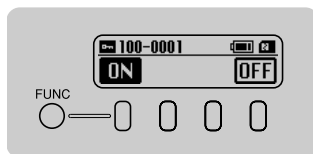
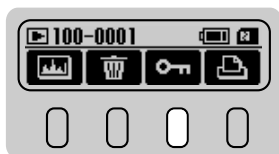

With the Protection setting set to “OFF”

- 3 Press function button [1].

- When you press function button [1], protection is specified for the selected image.
- A key icon appears in the top-right corner of the protected images.
- To protect another image, use “◀” or “▶” on the 4-direction button to select the image.
- To cancel the procedure, press the “CANCEL” button.
- When you press function button [4], protection is removed from the selected image.

Protecting and Unprotecting All Images

Use this setting to prevent images from being accidentally erased. This procedure can be used to set the protect attribute for all the images on the media.

- 1** On the rear display panel, check the media type containing the images for which protection is to be set or removed.



For a "SmartMedia"

- To select a different media type, select "MEDIA" in the "SET-UP" menu (⇨P.51).

- 2** Press the "PLAY" button to display the image.

- 3** Press the "MENU/EXE" button to display the menu.

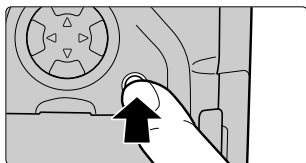

- 4** Press "◀" or "▶" on the 4-direction button to display the "PROTECT" menu.

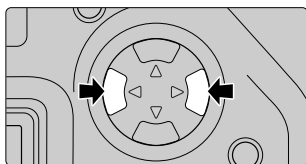

- 5** Press “▲” or “▼” on the 4-direction button to select “ALL” if you want to protect the images or “UNPROTECT ALL” if you want to remove the protection and then press the “MENU/EXE” button.

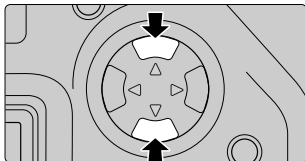

“ALL” is selected

- 6** Check the confirmation message and then press the “MENU/EXE” button.

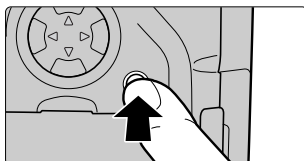

Set protection

- When you press the “MENU/EXE” button, protection is either set or removed for all the images.
- To cancel the procedure, press the “CANCEL” button.
- A key icon appears in the top-right corner of the protected images.

DPOF Settings

DPOF

DPOF stands for Digital Print Order Format and refers to a format that is used for recording print specifications for images shot using a digital camera on a SmartMedia or Microdrive/CompactFlash. The recorded print specifications include the image that are to be printed and the number of prints of each image.

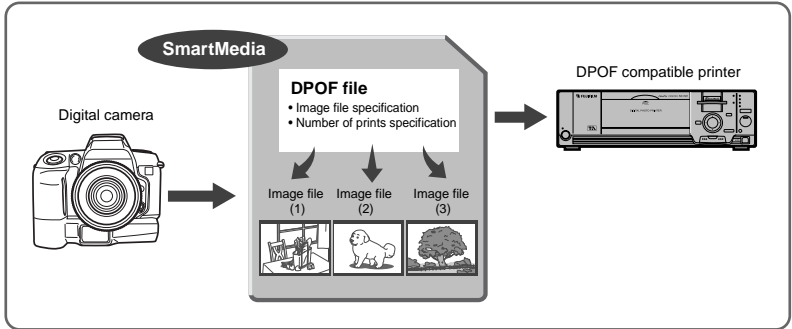

- On a DPOF-compatible digital camera (the FinePix S1 Pro), the above information can be recorded onto a SmartMedia or Microdrive/CompactFlash using the camera controls.
- If DPOF information is recorded on the media, the specified number of prints of the specified frames (image files) can also be printed on a DPOF-compatible printer.

DPOF Settings - continued

Setting or Cancelling Date/Time Imprinting

Use the procedure below to specify whether the date and time of shooting are included on the image prints.

- 1** Press the “PLAY” button and then the “MENU/EXE” button to display the menu.

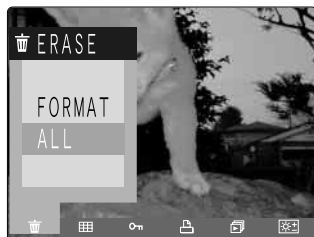
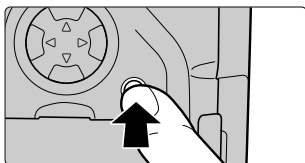

- 2** Press “◀” or “▶” on the 4-direction button to display the “DPOF” menu.

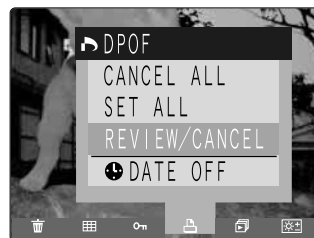
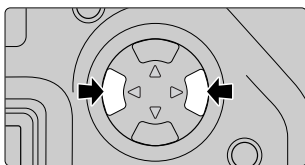

- 3** Press “▲” or “▼” on the 4-direction button to select “DATE OFF”.

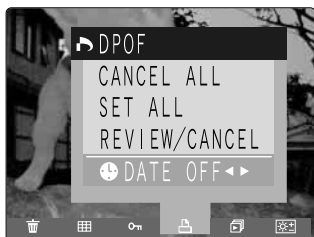
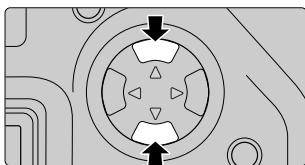

- 4** Press “◀” or “▶” on the 4-direction button to select either “DATE ON” or “DATE OFF”. The selected setting then remains valid for all images until the camera is switched off.

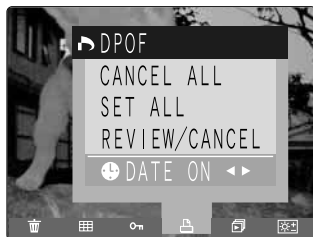
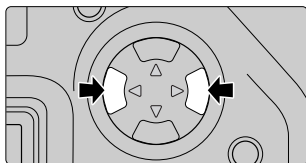

- Pressing the “CANCEL” button clears the menu display.
- Always specify “DATE ON” or “DATE OFF” before specifying other DPOF settings.

Specifying DPOF Settings for Single Frame

Use the procedure below to specify DPOF settings (specify the number of prints) for the selected image.

- 1** Press the “PLAY” button and then press “◀” or “▶” on the 4-direction button to display the image for which you want to specify the DPOF settings.

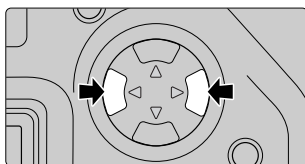

- 2** Press function button [4].

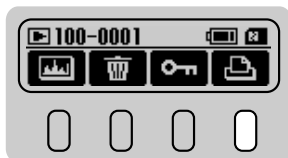

3 Press function button [1] or [3] to specify the number of prints for the image.

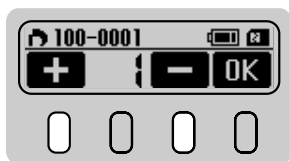

- Press function button [1] to increase the number of prints and function button [3] to decrease the number of prints.

■ To specify trimming (steps 4 to 5)

4 Press “▲” on the 4-direction button. The trimming settings screen appears. Press “▲” on the 4-direction button to further enlarge the image.

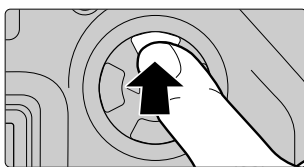

- Press “▼” on the 4-direction button to return the enlarged image to its original size.
- Press “◀” or “▶” on the 4-direction button to display (play back) another image.
- Press the “CANCEL” button to return to normal image display.

5 If you want to trim another part of the image, press the “PLAY” button to display the cursor and then use “▲”, “▼”, “◀” and “▶” on the 4-direction button to display the part of the image you want to trim.

- The table below lists the magnifications at which trimming can be performed.

Image Size	Magnification
3040 × 2016	4.52×
2304 × 1536	3.6×
1440 × 960	2.14×

- To cancel the cursor and return to the normal enlarged display screen, press the “PLAY” button again or press the “CANCEL” button.

6 Press function button [4].

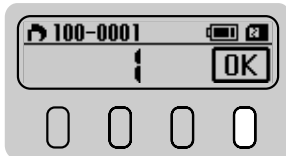

- Pressing function button [4] sets the DPOF information.
- To cancel the procedure, press the “CANCEL” button.

Checking and Cancelling DPOF Settings for Single Frame (REVIEW/CANCEL)

You can use the procedure below to display only images for which DPOF settings are specified and then cancel the settings for each image.

- 1 Press the “PLAY” button to display the image.
- 2 Press the “MENU/EXE” button to display the menu.
- 3 Press “◀” or “▶” on the 4-direction button to display the “DPOF” menu.

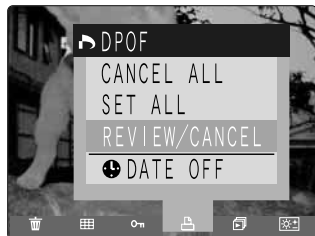
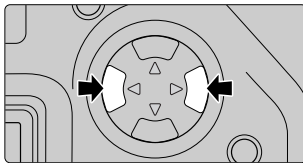

- 4** Press “▲” or “▼” on the 4-direction button to select “REVIEW/CANCEL”.

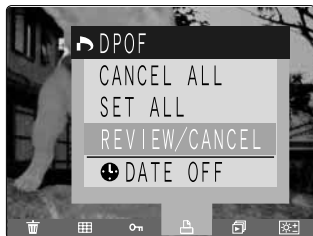
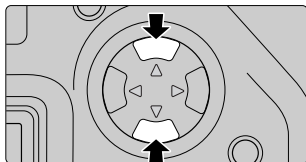

- 5** Press the “MENU/EXE” button.

- 6** You can check only the frames for which prints are specified by pressing “◀” or “▶” on the 4-direction button. To cancel the DPOF settings, display the image and then press the “MENU/EXE” button.

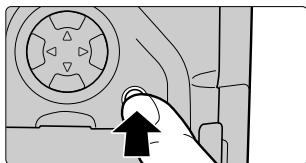

- If there are no images with DPOF settings, no images are displayed.
- Images are arranged in the order in which the DPOF settings were specified.
- If an image with DPOF settings contains an error or if the DPOF settings were specified on a different device, a confirmation message appears. Check the message and then press the “MENU/EXE” button to cancel the settings or the “CANCEL” button to cancel the procedure.
- Pressing the “MENU/EXE” button cancels the DPOF settings for the specified image.
- To cancel the procedure, press the “CANCEL” button.

Setting DPOF Settings for All the Images (SET ALL)

Use the procedure below to set DPOF information for all the images on a media.

- 1 Use the rear display panel to check the media type on which you want to store DPOF information.



- 2 Press the "PLAY" button and then the "MENU/EXE" button to display the menu.

- 3 Press "◀" or "▶" on the 4-direction button to display the "DPOF" menu.

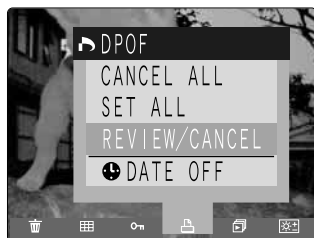
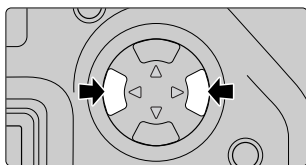

- 4 Press "▲" or "▼" on the 4-direction button to select "SET ALL".

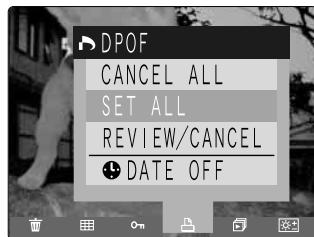
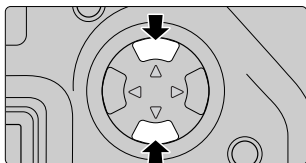

- 5 Press the "MENU/EXE" button.

6 Check the number of stored DPOF prints and then press the “MENU/EXE” button.

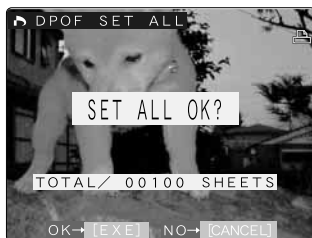
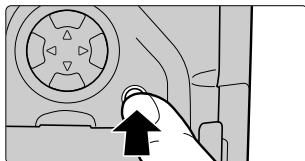

- The total number of prints appears on the color LCD monitor and the display then reverts to the menu screen.
- If an image for which DPOF settings are specified is damaged or if DPOF settings were specified on a different device, the error tone sounds and a confirmation message appears. Check the message and then press “MENU/EXE” button to reset the DPOF settings or press the “CANCEL” button to cancel the procedure.
- To cancel the procedure, press the “CANCEL” button.

Canceling DPOF Settings for All Frames (CANCEL ALL)

Use the procedure below to cancel the DPOF information for all the images on the media.

- 1 Use the rear display panel to check the media type on which you want to cancel the DPOF information.

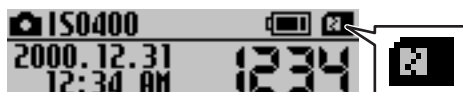

- 2 Press the “PLAY” button and then the “MENU/EXE” button to display the menu.

- 3 Press “◀” or “▶” on the 4-direction button to display the “DPOF” menu.

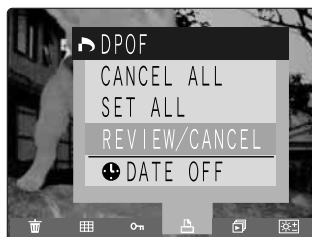
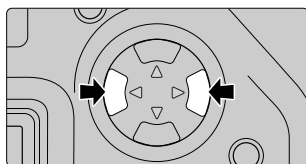

- 4 Press “▲” or “▼” on the 4-direction button to select “CANCEL ALL”.

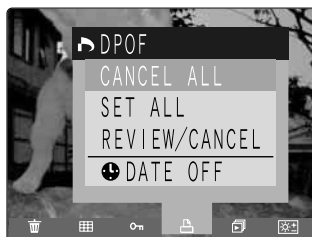
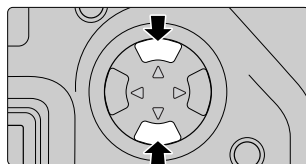

- 5 Press the “MENU/EXE” button.

- 6** Check the number of prints for which DPOF settings are to be canceled and then press the “MENU/EXE” button.

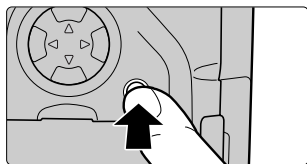

- To cancel the procedure, press the “CANCEL” button.

Auto Play (Automatic Playback)

Auto Play Settings

Use the procedure below to select the Auto Play (automatic playback) method for photographed images.

The Auto Play settings are as follows:

WIPE-OFF: Images are displayed without scrolling.

WIPE-1: Images are switched (wiped) on an angle.

WIPE-2: Images are switched (wiped) in a swirling pattern.

WIPE-3: Images are switched (wiped) in a mosaic pattern.

Display time: Display times of 0.3, 1, 2, 3, or 5 seconds can be selected.

- The display times are provided as a guide only. Actual times will vary depending on factors such as the quality and image size settings for the image. (Higher image quality settings and larger file sizes take longer.)

- 1** Press the “PLAY” button to display the image.
- 2** Press the “MENU/EXE” button to display the menu.
- 3** Press “◀” or “▶” on the 4-direction button to display the “AUTO PLAY” menu.

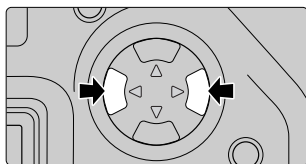

Auto Play (Automatic Playback) - continued

- 4** Press “▲” or “▼” on the 4-direction button to select the Auto Play time setting and then press “◀” or “▶” to set the time. Then press “▲” or “▼” on the 4-direction button to set the Auto Play method.

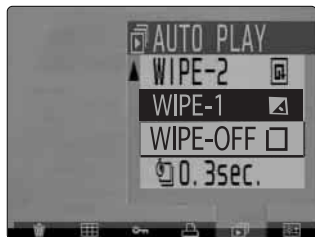
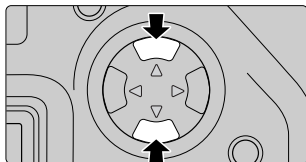

- 5** Press the “MENU/EXE” button.
Automatic playback begins.

- Automatic playback does not begin until you set the Auto Play method.
- To cancel automatic playback, press the “CANCEL” button.

Adjusting the Color LCD Monitor Brightness

- The brightness of the color LCD monitor can be adjusted through 11 levels.

1 Press the “PLAY” button and then the “MENU/EXE” button to display the menu.

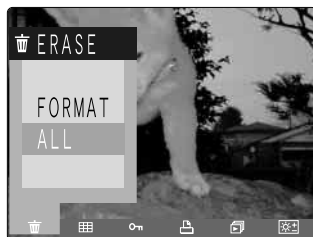
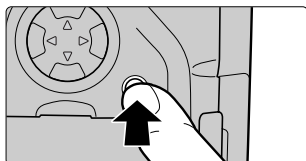

2 Press “◀” or “▶” on the 4-direction button to display the “BRIGHTNESS” menu.

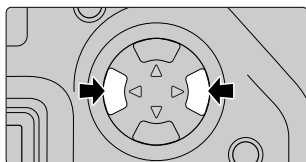

- To cancel the procedure, press the “CANCEL” button.

3 Press the “MENU/EXE” button.

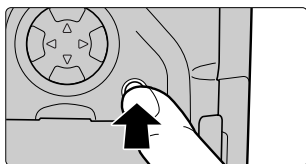

Adjusting the Color LCD Monitor Brightness - continued

- 4** Press “◀” or “▶” on the 4-direction button to adjust the brightness.

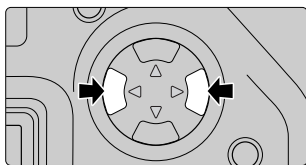

- Press “▶” on the 4-direction button to increase the brightness of the color LCD monitor and “◀” to decrease the brightness.
- To cancel the procedure, press the “CANCEL” button.

- 5** Press the “MENU/EXE” button to confirm the setting.

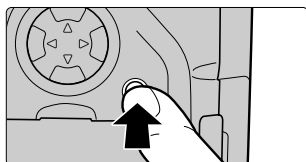

- Pressing the “CANCEL” button clears the menu display.

System Expansion Options

- By using the FinePix S1 Pro together with other optional FUJIFILM products, your system can be expanded to fill a wide range of uses. See pages 108-109 and 111-112 for details.

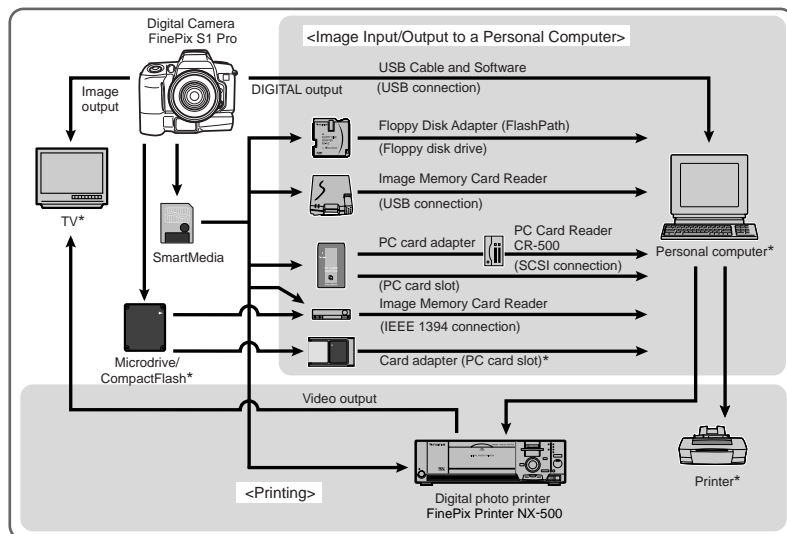

* commercially available

Lenses that Can Be Used with this Camera

- Use Nikkor lenses with built-in CPUs (excluding the IX Nikkor lenses) with this camera. In particular, the full range of functions can be accessed when a D-type AF Nikkor lens is mounted on the camera.

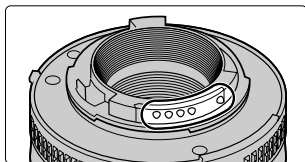

There are CPU signal contacts on Nikkor lenses with a built-in CPU.

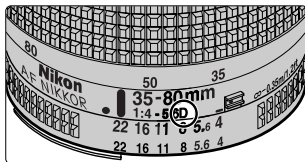

Distinguishing feature of D-type AF Nikkor lenses

When lenses other than Nikkor lenses with a built-in CPU are mounted on the camera

- Restrictions apply to the exposure modes that can be used. Lenses other than Nikkor lenses with a built-in CPU can only be mounted on the camera and used to take pictures when the exposure mode is set to M (manual). (In other modes, the shutter will not release.) However, the camera's exposure meter cannot be used and the aperture cannot be set using the aperture button and command dial. The "F--" warning appears in the aperture display on the top display panel and in the viewfinder display. Use the aperture ring on the lens to check and set the aperture.

Note

Lenses other than Nikkor lenses with a built-in CPU that cannot be used

The lenses other than Nikkor lenses with a built-in CPU listed below cannot be used with this camera. Any attempt to forcibly mount one of these lenses on the camera could damage the camera and lens.

- AF Teleconverter TC-16AS
- Non-Ai Nikkor lenses (lens types with a connecting bayonet that precede the Ai system)
- Lenses that require the Focusing Unit AU-1 (400 mm f/4.5 and 600 mm f/5.6)
- Fish-eye lenses (6 mm f/5.6 and OP 10 mm f/5.6)
- ED 180-600 mm f/8 (product no. 174166 and earlier)
- ED 360-1200 mm f/11 (product no. 174087 and earlier)
- 200-600 mm f/9.5 (product no. 300490 and earlier)
- For F3AF (80 mm f/2.8 and 200 mm f/3.5, Teleconverter TC-16S)
- PC28 mm f/4 (product no. 180900 and earlier)
- PC35 mm f/2.8 (product no. 906200 and earlier)
- Reflex 1000 mm f/11 (product no. 142361-143000)
- Reflex 2000 mm f/11 (product no. 200310 and earlier)
- Medical Nikkor 200 mm f/5.6 (This lens can be used if used together with the Sync Terminal Adapter AS-15.)

Types of Nikkor Lenses with a Built-in CPU and Other Lenses that Can Be Used

Lenses	Modes	Focusing Mode			Exposure Mode		Metering Mode		
		Auto focus	Focus aids	Manual	Other	M	Multi-pattern metering		Center-weighted metering*1
							3D 6-zone	6-zone	
Nikkor lenses with a built-in CPU *2	D-type AF lenses	○	○	○	○	○	○	—	○
	AF-S, AF-I lenses (D-type lenses)	—	○	○	○	○	○	—	○
	PC micro 85 mm f/2.8D *3	—	○*4	○	—	○	○	—	○
	AF-I Teleconverter	—	○*5	○	○	○	○	—	○
	AF Nikkor lenses other than D-type (excluding lenses for F3AF)	○	○	○	○	○	—	○	○
	Ai-P Nikkor	—	○*6	○	○	○	—	○	○
Lenses other than Nikkor lenses with a built-in CPU *7	Ai-S, Ai series E lenses, modified Ai Nikkor	—	○*6	○	—	△*8	—	—	—
	Medical 120 mm f/4	—	○	○	—	△*8	—	—	—
	Reflex lenses	—	—	○	—	△*8	—	—	—
	PC Nikkor	—	○*4	○	—	△*8	—	—	—
	Ai-S, Ai Teleconverter	—	○*5	○	—	△*8	—	—	—
	Bellows PB-6 (used with K ring 1, 3, 4 or 5)	—	○*5	○	—	△*8	—	—	—
	Auto close-up rings (PK-11A, 12, 13 and PN-11)	—	○*5	○	—	△*8	—	—	—

○ : Usable

△ : Usable subject to conditions

— : Not usable

*1 When the M (manual) exposure setting or AE lock is used, the light metering mode is automatically switched to center-weighted metering.

*2 IX Nikkor lenses cannot be mounted on this camera.

*3 The camera's light metering modes and flash control functions do not operate correctly when camera movements are performed (both shift and tilt) or when the aperture is set to any setting other than fully open.

*4 Only possible when camera shift or tilt are not performed.

*5 Can only be used when the combined aperture value is f/5.6 or brighter.

*6 Can only be used when the widest aperture value is f/5.6 or brighter.

*7 Some lenses cannot be mounted on this camera (☞ P.106).

*8 Set the exposure mode to M. Note that the exposure meter cannot be used.

Optional Accessories Guide

■ This section introduces some of the key products in the range of optional accessories available for the FinePix S1 Pro. Many other optional accessories are available to further expand your selection of photographic options. Refer to the catalog for details.

● SmartMedia™

The following types of SmartMedia can be used with the FinePix S1 Pro:

- MG-4S : 4 MB, 3.3 V
- MG-8S : 8 MB, 3.3 V
- MG-16S : 16 MB, 3.3 V
- MG-32S : 32 MB, 3.3 V
- MG-64S : 64 MB, 3.3 V

* Some 3.3 V SmartMedia are labelled as "3V" or "ID" cards.

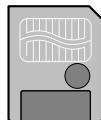

● AC Power Adapter AC-5VH

Use this adapter when you want to take pictures over an extended period or when the camera is connected to your personal computer.

Can be used with voltages of 100-240 V AC at 50/60 Hz.

* The shapes of the AC power and plug depends on the country of use.

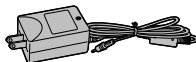

● FUJIFILM Rechargeable Battery 2HR-3UF

The 2HR-3UF includes 2 pieces of high-capacity AA-size Nickel Metal Hydride (Ni-MH) batteries.

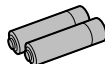

● FUJIFILM Rechargeable Battery 4KR-3UF

The 4KR-3UF includes 4 pieces of high-capacity AA-size Ni-Cd batteries.

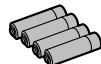

● FUJIFILM Battery charger with Battery BK-NH (220V AC only)

The BK-NH includes the quick battery charger BCH-NH and 2 Ni-MH batteries.

The BCH-NH can charge 2 Ni-MH batteries in approximately 110 minutes.

Up to 4 Ni-MH or Ni-Cd batteries can be charged simultaneously.

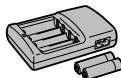

● Floppy Disk Adapter (FlashPath)

This adapter is the same size and shape as a 3.5-inch floppy disk. You can copy the images on a SmartMedia to your PC simply by loading the SmartMedia into the floppy disk adapter and then inserting the adapter into your floppy disk drive.

	Compatible OS	Compatible SmartMedia
FD-A1/A1S/A1N	Windows95/98, NT 4.0	5V/3.3V, 2 MB to 32 MB
FD-A2	Macintosh	5V/3.3V, 2 MB to 64 MB



● PC Card Adapter

The PC Card Adapter allows the SmartMedia to be used as a PC Card Standard ATA-compliant (PCMCIA 2.1) PC card (Type II).

- PC-AD2 : Compatible with SmartMedia of 5V/3.3V, 2MB to 8MB.
- PC-AD3 : Compatible with SmartMedia of 5V/3.3V, 2MB to 64MB.



● Image Memory Card Reader SM-R1/R2

The SM-R1/R2 allows images to very easily be read and written from an image memory card (SmartMedia) to a personal computer. Its USB interface provides high-speed data transmission.

- Windows98, Windows 2000 Professional (SM-R2 only) or Power Macintosh with USB interface.

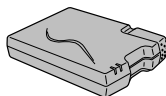

● Image Memory Card Reader DM-R1

This device allows image data shot on the camera to be handled in essentially the same way as files on an external disk drive for a personal computer.

- IEEE 1394 interface
- Dual slot for SmartMedia and CompactFlash Type II (Microdrive-compatible)

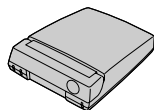

● Carrying Case LC-S1

This is a specially designed carrying case for the FinePix S1 Pro. This case holds the camera body, optional accessories (battery charger, AC power adapter, etc.), the compact flash unit and replacement lenses.

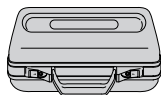

Explanation of Terms

- AF/AE Lock:** On the FinePix S1 Pro, pressing the shutter button halfway locks the focus and exposure settings (AF/AE lock). If you want to focus on a subject that is not centered in the frame or change the picture composition after the exposure is set, you can obtain good results by changing the composition after the AF and AE settings are locked.
- Auto Power Off Function:** If the camera is not used in any way for a set period, the Auto Power Off function switches the camera off to prevent battery depletion and to avoid wasting power when the camera is connected to the AC power adapter. On this camera, the period can be set to either 2 minutes or 5 minutes.
- The Auto Power Off function does not operate during automatic playback, when a USB connection is being used, or when the Auto Power Off function is switched off during setup.
- Color Temperature:** There is a set relationship between the surface temperature of a substance such as coal and the color of the reflected light. Substances with low color temperatures reflect a reddish light, while substances with high color temperatures reflect light in which blue tones are stronger. The color of the light for these temperatures is expressed as a color temperature (K = Kelvin). The light of the sun at midday in a completely clear sky is taken to be 5500K.
- EV:** A number that denotes exposure. The EV is determined by the brightness of the subject and sensitivity (speed) of the film or CCD. The number is larger for bright subjects and smaller for dark subjects. As the brightness of the subject changes, a digital camera maintains the amount of light hitting the CCD at a constant level by adjusting the aperture and shutter speed. The EV number increases by 1 if the amount of light hitting the CCD doubles and decreases by 1 if the amount of light halves.
- JPEG:** Acronym for the Joint Photographic Experts Group. JPEG is a file format for the compression and storage of color images. The compression ratio can be selected, but the higher the compression ratio, the poorer the quality of the expanded (restored) image.
- TIFF-RGB:** A format for saving image data in which a tag indicating the file format is attached to each item of data. Files stored in this format can be opened on a personal computer.
- TIFF-YC:** A storage format for image data. To open an image stored in this format, an application that supports the TIFF-YC format is required. We recommend the FUJIFILM USB Interface Set IF-UB/S1. The size of TIFF-YC data is 2/3 that of TIFF-RGB data.
- White Balance:** Regardless of the type of lighting, the human eye adapts so that a white object still looks white. On the other hand, devices such as digital still cameras register a white subject as white by first adjusting their internal color balance to match the color of the ambient light around the subject. This adjustment process is referred to as matching the white balance. A function that automatically matches the white balance is called an automatic white balance function.

Using the USB Cable and Software Included

- By connecting the camera to a personal computer with the cable provided, you can download image data from the camera to the computer. However, you cannot upload data from the computer to the camera. You can also control the camera, specify the photography settings and take pictures from the computer.

Note

Notes on Using the USB Cable

On some large lenses, the way in which the lens tripod is attached may be such that lens and tripod obstruct the USB cable and could cause USB cable connection faults.

Important

Compatible personal computers

PCs running Windows 2000 Professional, Windows 98 (including the Second Edition) and Macintosh computers running Mac OS 8.5.1 to Mac OS 9.0 can be used.

Note that the computer must be equipped with a USB port. (Operation is not guaranteed on home-made personal computers.)

- 1 Load the Media (SmartMedia or Microdrive/ CompactFlash) into the camera (☞ P.24).**
 - When you control picture taking on the FinePix S1 Pro, it is not necessary to load the media.
- 2 Switch the camera on, press the “MENU/EXE” button and use the “▲” or “▼” button to set the camera to PC mode.**
 - To control picture taking on the FinePix S1 Pro from your PC, select “PC MODE ► SHOOTING” and use the “Camera Shooting Software” application.
 - To download image data from the FinePix S1 Pro to your PC, select “PC MODE ► DOWNLOADING”.
 - Refer to the User’s Guide (PDF File) included CD-ROM for information on using the software.
- 3 When you have selected the mode, press “▲” or “▼” on the 4-direction button to select “END” and then press the “MENU/EXE” button.**

- 4** Plug the small plug on the cable provided into the digital (USB) socket on the camera and then plug the other end of the cable into the USB port on the computer. When you switch on the computer, the “” icon appears on the camera’s rear display panel.

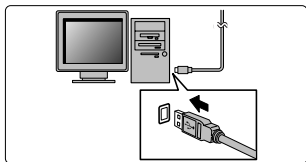
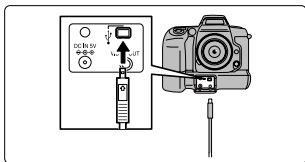

- Use only the special cable provided.
- When the “!BUSY” message appears on the rear display panel, this indicates that the camera is being accessed. Never open the slot cover or disconnect the cable while the camera is being accessed. This can prevent correct data downloading and cause camera malfunctions.



Downloading mode

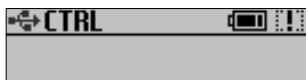

Shooting mode

■ Replacing Media (Downloading mode)

- On Windows 98
Check that the camera is not being accessed, switch the camera off and replace the media.
 - On Windows 2000 Professional
Check that the camera is not being accessed, click on the Eject button in the taskbar, and then switch the camera off and replace the media.
 - On a Macintosh
Drag the removable disk icon on the desktop to the Trash. Once the “REMOVE OK” message has appeared on the rear display panel, switch the camera off and replace the disk.
- If you open the slot cover without switching the camera off, the “Err” warning appears on the top display panel. If this occurs, switch the camera off and then on again.
 - You should use the optional AC Power Adapter AC-5VH (sold separately) and the battery adapter. Data cannot be downloaded if the power fails during downloading.
 - The Auto Power Off function does not operate when the camera is connected to a PC.

Notes on Using the FinePix S1 Pro

■ Places to Avoid

Do not store or use the camera in the following types of locations:

- Very humid, dirty or dusty places
- In direct sunlight or in places subject to extreme temperature rises, such as in a closed car in summer. Extremely cold places
- Places subject to strong vibrations
- Places affected by smoke or steam
- Places subject to strong magnetic fields (such as near motors, transformers or magnets)
- For long periods in contact with chemicals such as pesticides or next to rubber or vinyl products

■ Do not expose the camera to sand.

The FinePix S1 Pro is particularly adversely affected by sand. In sandy locations such as beaches or deserts, or in locations where there is windborne sand, ensure that the camera is not exposed to sand. This can cause faults that may be irreparable.

■ Notes on Condensation

If the camera is carried suddenly from a cold location into a warm place etc., water droplets (condensation) may form on the inside of the camera or on the lens. When this occurs, switch the camera off and wait until water droplets are gone. Condensation may also form on the SmartMedia or Microdrive/CompactFlash. In this event, remove the SmartMedia or Microdrive/CompactFlash and wait a short time before using it again.

■ When the Camera is Unused for Long Periods

If you do not intend to use the camera for a long period, remove the batteries and any SmartMedia or Microdrive/CompactFlash before storing the camera.

■ Cleaning Your Camera

- Use a blower brush to remove dust from the lens, LCD color monitor and viewfinder and then wipe lightly with a soft, dry cloth. If any soiling remains, apply a small amount of lens cleaning liquid to a piece of lens cleaning paper and wipe gently.
- Do not scrape the lens, LCD monitor or viewfinder with hard objects as the surface scratches easily.
- Clean the body of the camera with a soft dry cloth. Do not use volatile substances such as thinners, benzene or insecticide, as these may react with camera body and cause degeneration or deformation or cause the coating to peel off.

■ Using the Camera Overseas

- When travelling overseas, do not place your camera in the check-in baggage. Baggage handling at airports may subject baggage to violent shocks, and the camera may be damaged internally even when no external damage is visible.

Cleaning the CCD

- This camera is equipped with a CCD photosensitive element. This CCD is located behind the shutter screen.

If dust or other soiling attaches to the surface of the CCD and pictures are then taken, this soiling may appear as spots in the image, depending on the camera settings and the type of subject. If this occurs, the CCD must be cleaned. Because the surface of the CCD is extremely fragile, wherever possible the camera should be returned to an authorized FUJIFILM dealer for cleaning (for a charge).

Any repairs carried out by an authorized FUJIFILM service facility to CCDs that were scratched or damaged during cleaning by the customer will be charged to the customer. Note that such repairs will probably involve replacing the CCD and will be expensive.

Note

Dust inside the camera and on the surface of the CCD

- Before a FUJIFILM digital camera is shipped from the factory, it is carefully checked for dust inside the camera and on the surface of the CCD to ensure that it conforms to FUJIFILM standards.
- Bear in mind also that some types of soiling on the CCD surface cannot be removed even by an authorized FUJIFILM service facility. Should this occur, you can use features such as the despeckling function provided in the image processing software to remedy the problem.

Note

Preventing Soiling of the CCD

- Change the lens in an area free of soiling and dust.
- While the lens is detached from the camera, always fit the camera body cap provided onto the camera. Check that the body cap and lens are free of any soiling or dust.

Determining Whether Cleaning is Required

- 1** Connect the AC power adapter (sold separately) and load the battery adapter.
 - During cleaning, always use the AC power adapter and battery adapter to ensure that a power failure does not cause the mirror to drop down or the shutter to close and damage the camera.
- 2** Remove the camera lens.
- 3** Set the exposure mode dial to M.
- 4** Hold down both the self-timer button “⌚” and the AE lock button “AE-L” and switch the camera on.

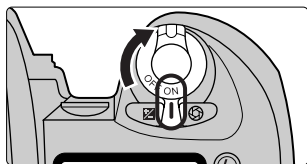
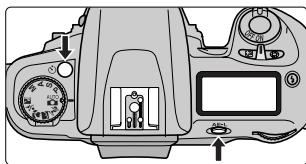

- 5** Press the shutter button. The mirror swings up and the shutter opens and remains open.

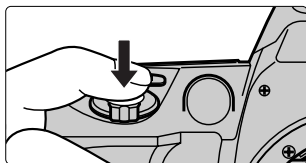

- 6** Hold the camera so that the light shines on the CCD and check the CCD surface.
 - If there is soiling on the CCD surface, contact an authorized FUJIFILM dealer to request cleaning or clean the CCD yourself as described on the next page.
 - If there is no soiling on the CCD surface, proceed to step 3 in “Cleaning the CCD” on the next page to drop the mirror back down.

Cleaning the CCD

1 Perform steps 1 to 5 in “Determining whether cleaning is required” to swing the mirror up.

- Never disconnect the AC power adapter during cleaning as this can result in damage to the camera shutter.

2 Use a blower to remove any soiling on the CCD surface.

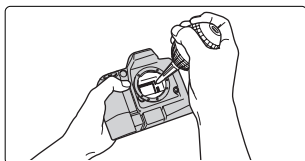

Note

Points to Note when Cleaning the CCD

- Use a blower that does not have a brush attached. Using a blower brush to clean soiling from the CCD can scratch the CCD surface.
- If there is soiling on the CCD that cannot be removed using a blower, such as oil or fingermarks, take the camera to an authorized FUJIFILM dealer for cleaning. Never attempt to clean the CCD by wiping it as the CCD is extremely fragile.

3 Check that all the soiling has been removed and then hold down both the self-timer button “☺” and the AE lock button “AE-L” as you switch the camera off. Then disconnect the AC power adapter from the camera.

- When you switch the camera off, the mirror drops down and the shutter closes at the same time. Ensure that your fingers are not caught inside the camera.

Power Supply Notes

Batteries that Can Be Used

- Use AA-size nickel-metal hydride (Ni-MH), AA-size Ni-Cd or AA-size alkaline batteries, CR123A lithium batteries and a CR2025 button cell with the FinePix S1 Pro.
Do not use AA-size manganese or AA-size lithium batteries as these battery types emit heat that can cause camera faults or malfunctions.
- The capacity of alkaline batteries varies depending on the brand. The life of some batteries may be considerably shorter than others.

Notes on Handling the Batteries

Incorrect use or handling of batteries can cause them to leak fluid, emit heat, emit sparks or burst. Observe the following precautions:

- Do not heat batteries or throw them into a fire.
- Do not allow metal objects such as pins to come into contact with the positive ⊕ and negative ⊖ poles on a battery and do not carry or store batteries with metal objects such as necklaces or hairpins.
- Do not get water or seawater on batteries and keep the battery terminals dry.
- Do not attempt to deform, disassemble or modify a battery.
- Do not attempt to remove or damage the battery casing.
- Do not drop, strike or otherwise subject batteries to strong impacts.
- Do not use batteries that are leaking fluid, are deformed or discolored or are in any other way abnormal.
- Do not store batteries in very warm or humid places.
- Store batteries out of the reach of small children.
- When loading the batteries into the camera, ensure that the positive ⊕ and negative ⊖ poles are arranged as indicated.
- Do not use new batteries together with used batteries. (With rechargeable batteries, do not use charged batteries together with discharged batteries.)
Do not use batteries of different types or brands together.
- Remove the batteries from the camera if it will not be used for a long period. (If the button cell CR2025 battery is removed from the camera, the camera settings will revert to the factory default values.)
- Some batteries may feel warm just after use. Switch the camera off and allow the batteries to cool before removing them.
- When replacing the batteries, always fit new batteries of the same type. In the case of alkaline, lithium CR123A and button cell CR2025 batteries, “new batteries” denotes recently purchased, unused batteries. In the case of rechargeable Ni-MH and Ni-Cd batteries, it denotes batteries that were recently fully recharged at the same time.
- In cold locations (+10°C (+50°F) or colder), battery performance declines and the time for which the batteries can be used decreases. Because this tendency is particularly pronounced in alkaline and lithium batteries, warm the batteries by placing them in a warm place such as your pocket before using them. If you are using a heating pad, take care not to place the batteries directly against the pad.

Power Supply Notes - continued



If any battery fluid at all leaks from the batteries, wipe the battery compartment thoroughly and then load new batteries.



If battery fluid comes into contact with your hands or clothing, wash the area thoroughly with running water. If the fluid gets into your eye, it could cause blindness. Flush the affected eye with clean water and then seek medical assistance.

● Disposing of batteries

Dispose of used batteries in accordance with your local waste disposal regulations.

● Notes on Using Small Rechargeable Batteries (Ni-MH/Ni-Cd)

- Charge AA-size Ni-MH and Ni-Cd batteries correctly using the Battery Charger (220V AC only, sold separately).
- Do not use batteries other than those specified in the Battery Charger (220V AC only, sold separately).
- Note that batteries may feel warm immediately after charging. This is normal.
- Ni-MH and Ni-Cd batteries are not charged when they are shipped. Always charge new batteries before using them.
- Due to the mechanical characteristics of the camera, a very small amount of current flows even when the camera is switched off. Take particular care with Ni-MH and Ni-Cd batteries as they will become excessively discharged and may no longer function even when charged if you leave them in the camera for a long period.
- Ni-MH and Ni-Cd batteries self-discharge when not used. Always recharge the batteries before using them. If the time for which a battery can be used decreases markedly even when they are correctly charged, this indicates that the battery has reached the end of its effective life. Purchase a new battery.
- Soiling such as fingerprints or grease on the poles of Ni-MH batteries can significantly reduce the number of shots that can be taken using the batteries. If this occurs, wipe the poles carefully with a soft dry cloth and recharge the batteries once they have fully discharged.

● Recycling Small Rechargeable Batteries



This symbol is the recycling symbol used for small rechargeable batteries (such as Ni-MH and Ni-Cd batteries). Small rechargeable batteries use scarce and valuable resources that only exist in small quantities and these metals can be recycled. Recycling resources in this way helps to reduce waste and protect the environment. Dispose of your used small rechargeable batteries by sticking insulating tape over the metal terminals on the batteries and taking them to your local recycling facility for small rechargeable batteries.

Notes on Using the AC Power Adapter (AC-5VH) (sold separately)

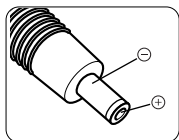

Use only the AC-5VH AC Power Adapter with your FinePix S1 Pro Digital Camera. The use of an AC adapter other than the AC-5VH may result in damage to your camera.

- Take care to ensure that the contact points on the AC power adapter do not touch other metal objects as this can cause a short-circuit.
 - Do not plug the AC power adapter into the camera when it is running on batteries. Switch the camera off and then plug in the AC power adapter.
- Do not load batteries into the camera or replace the batteries when the camera is running on the AC power adapter. Switch the camera off first.

Notes on Media

■ SmartMedia

SmartMedia are a new recording media developed specifically for use in digital cameras. Each SmartMedia card contains a semiconductor memory chip (NAND-type flash memory) which is used to record digital image data.

Because the data is recorded electrically, recorded data can be erased and re-recorded.

■ SmartMedia with ID

SmartMedia ID (SmartMedia with ID) are SmartMedia that have been assigned individual ID numbers. SmartMedia ID cards can be used in devices with features that use IDs for applications such as copyright protection. SmartMedia ID cards can be used on the FinePix S1 Pro in the same way as conventional SmartMedia cards.

■ Microdrive

Microdrive are the smallest and lightest hard disk drive and conform to the CF Type II extended standard for CompactFlash. Because Microdrive can hold large numbers of recorded images and represent a very low cost per megabyte, they allow more economical recording of high-quality images.

■ Data Retention

In the following situations, recorded data may be erased (or corrupted). Fuji Photo Film Co. Ltd. accepts no liability for any losses incurred as a result of data being erased or corrupted.

* If the media is used improperly by the customer or by a third party

* If the media is affected by static electricity or electrical interference

* If the media is removed or the device is switched off while data is being recorded onto or erased from the media (including formatting)

* If the media is bent or dropped, or subjected to strong impacts.

Important data should be backed up on to another media (MO disk, floppy disk, hard disk, etc.).

■ Notes on handling media (all types)

- When inserting the media, hold it straight as you slide it in.
- Never remove the media or switch the camera off during data recording, during data erasing (formatting) or during frame advance when images are being played back. These actions could result in damage to the media.
- Media are precision electronic devices. Do not bend, drop, or subject media to excessive shocks.
- Do not use or store media in environments likely to be affected by strong static electricity, electrical noise or magnetic fields.
- Do not use or store media in very hot, humid or corrosive environments.

■ Notes on handling SmartMedia

- Use only the SmartMedia specified for use with the FinePix S1 Pro. The use of other SmartMedia could damage the camera.
- Take care not to touch the SmartMedia's contact area (gold-colored area) or allow the area to become soiled. Use a dry lint-free cloth to wipe away any soiling that does occur.
- To avoid damage caused by static electricity, always use the special static-free case provided during transportation or storage. Keep the SmartMedia in a storage case if available.
- Inserting a SmartMedia that is charged with static electricity into your camera may result in a camera malfunction. If this occurs, switch the camera off and then on again.

Notes on Media - continued

- Do not carry SmartMedia in locations such as a trouser pocket. This could subject the SmartMedia to excessive force when you sit down, thereby damaging the SmartMedia.
- The SmartMedia may feel warm when it is removed from the camera after being used for an extended period. This is normal and does not indicate a fault.
- SmartMedia cards have a limited life. After a long period of use it will become impossible to record new image data on the card. In this event, purchase a new card.
- Stick the enclosed index label onto the index area on the SmartMedia. Do not use third-party labels on the SmartMedia as this can cause faults when the SmartMedia is inserted or removed.
- Take care that index labels do not overlap into the write-protect area.
- If there is any initial product defect in SmartMedia as a result of manufacturing by FUJIFILM, the same number of replacement cards will be provided free of charge. FUJIFILM accepts no liability for faults attributable to other causes.

■ Notes on using Microdrive and CompactFlash

- Do not write on the media label.
- Do not peel off the media label.
- Do not stick another label onto a media.
- When carrying or storing a media, keep it in the protective case provided.
- Do not use media in CF Type II slots that do not have an eject function.
- Take care when handling media that have been used for long periods as they may become hot.
- Do not place media close to strong magnets.
- Keep media dry.
- Do not apply excessive force to the media cover.

■ Notes on using media with a personal computer









- If you intend to take photos using a media that has been used on a personal computer, first format the media on your camera.
- When you format a media in the camera and then photograph and record images, a folder is automatically created on the media. Image data is then recorded in this folder.
- Do not change or delete the folder names or file names on the media from your PC as this will make it impossible to use the media in your camera.
- Always use the camera to erase image data on a media.
- To edit image data, copy the image data to the computer's hard disk and then edit the copied data.

■ SmartMedia Specifications

Type	Image memory card for digital cameras (SmartMedia)
Operating voltage	3.3 V
Operating conditions	Temperature: 0°C to +40°C (+32°F to +104°F) Humidity: 80% or less (no condensation)
Dimensions	37 × 45 × 0.76 mm (1.45 × 1.77 × 0.03 in.) (W × H × D)





Warning Displays

- If a warning is displayed or flashes in the top display panel, viewfinder display, rear display panel or color LCD monitor, check the points described in the table below before requesting repairs.

Problem		Cause	Solution	Ref. Page
Top display panel	Viewfinder display			
 (flashing)	 (flashing)	The aperture ring on the lens is not set to the narrowest aperture.	Set the aperture ring on the lens to the narrowest aperture.	P.20
 (flashing)		The lithium batteries are flat.	Replace the lithium batteries.	P.17, 18 P.22
 (lit)		The lithium battery charge is low.	Have spare lithium batteries ready.	P.22
 (flashing) (lit in M mode)	 (flashing) (lit in M mode)	The lens mounted is not a Nikkor lens with built-in CPU or no lens is mounted on the camera.	Use a Nikkor lens with built-in CPU (excluding IX Nikkor lenses). (Note that pictures can still be taken in M mode.)	P.20 P.106
 (lit)		The slot cover was opened during card operation.	Switch the camera off, close the slot cover, switch the camera back on and try again.	P.25 P.112
 (lit)		<ul style="list-style-type: none"> The AA-size batteries are low on charge or flat. No AA-size batteries are loaded. 	Switch the camera off and replace the AA-size batteries or load new AA-size batteries. Then switch the camera back on and try again.	P.18
 (flashing)		The lithium batteries are low on charge or the camera mechanism has stopped due to cold and cannot take pictures.	Switch the camera off and replace the lithium batteries. Then switch the camera back on and try again. If this does not resolve the problem, set the focusing mode to M, release the shutter and briefly switch the camera off.	P.17, 18

Warning Displays - continued

Problem		Cause	Solution	Ref. Page
Top display panel	Viewfinder display			
	● (flashing)	AF (auto focus) cannot focus the camera.	Focus the camera in manual (M) mode.	P.58
H I (lit)	H I (lit)	The subject is too bright and is beyond the camera's control range.	<ul style="list-style-type: none"> • In S mode (shutter-priority auto mode), select a faster shutter speed. • In A mode (aperture-priority auto mode), select a higher aperture number. • In exposure modes other than M, use an ND (light volume adjustment) filter. 	P.62 P.63 P.60-66
L O (lit)	L O (lit)	The subject is too dark and is beyond the camera's control range.	<ul style="list-style-type: none"> • In S mode (shutter-priority auto mode), select a slower shutter speed. • In A mode (aperture-priority auto mode), select a lower aperture number. • In exposure modes other than M, use the flash. 	P.62 P.63 P.60-66
	⚡ (flashing)	The subject is dark and the flash should be used.	Use the built-in flash.	P.76
	⚡ (flashing)	This icon flashing for about 3 seconds after the flash fires indicates that the full flash intensity was used and the image may be underexposed.	Recheck the distance to the subject, the aperture setting and the flash control range and then try again.	P.74
Err and ⚡ (flashing)	Err and ⚡ (flashing)	In modes other than A and M, the mode selector on a Nikon flash unit is not set to III .	Set the mode selector to III or set the exposure mode to A or M.	P.79

Problem		Cause	Solution	Ref. Page
Rear display panel	Color LCD monitor			
 (blinking)		The AA-size batteries are flat.	Replace the AA-size batteries.	P.18
 (lit)		The AA-size batteries are low on charge.	Have replacement AA-size batteries ready.	P.18
	! READ ERROR	The data played back was not recorded correctly.	The image cannot be played back.	
	! CARD NOT INITIALIZED	The recording media is not formatted (initialized).	Format the recording media.	P.86
	! CARD ERROR	The card played back contains an error.	The data on the card cannot be played back.	
	! PROTECTED CARD	There is a write-protect sticker on the SmartMedia.	Use a SmartMedia that does not have a write-protect sticker.	P.24
	! PROTECT	An attempt was made to erase a protected frame.	Remove the protection.	P.88
	DPOF FRAME ERASE OK?	DPOF print specifications are set for the image to be erased.	When the image is deleted, the DPOF settings are cancelled at the same time.	P.91-100
	RESET UNMATCHED DPOF OK?	DPOF file contains an error, or the DPOF file was specified on another device.	To create a new DPOF file and redo all the DPOF settings, press the "MENU/EXE" button.	P.91-100
	! DPOF FILE ERROR	More than 1000 frames were specified in the DPOF frame settings.	The maximum number of frames that can be specified for printing on the same media is 999.	
		The built-in flash was popped up even though the battery adapter is used.	The built-in flash cannot be used when the battery adapter is used.	
		<ul style="list-style-type: none"> The recording media is not formatted (initialized). You are trying to record onto a faulty media. 	<ul style="list-style-type: none"> Format the recording media. Data cannot be recorded onto faulty media. 	

Troubleshooting

Problem	Cause	Solution
No power.	<ul style="list-style-type: none"> • The batteries are flat. • The AC power adapter plug has come out of the power outlet. 	<ul style="list-style-type: none"> • Load new batteries. • Plug the adapter back in.
Power cuts out during operation.	<ul style="list-style-type: none"> • The batteries are flat. 	<ul style="list-style-type: none"> • Fit new batteries.
Battery runs out quickly.	<ul style="list-style-type: none"> • You are using the camera in extremely cold conditions. • The terminals are soiled. • The batteries have reached the end of their effective lives. 	<ul style="list-style-type: none"> • Put the batteries in your pocket or another warm place to heat them and then load them into the camera just before you take a picture. • Wipe the battery terminals with a clean, dry cloth. • Fit new batteries.
The date and time are reset when you replace the AA-size batteries.	<ul style="list-style-type: none"> • No button cell CR2025 batteries are fitted. • The button cell CR2025 batteries are depleted. 	<ul style="list-style-type: none"> • Fit new batteries. • Fit new replacement batteries.
No photograph is taken when the shutter button is pressed.	<ul style="list-style-type: none"> • No media is loaded. • The media is full and no further data can be recorded. • The SmartMedia is write-protected. • The media is not formatted. • The SmartMedia contact surface (the gold-colored area) is soiled. • The media is damaged. • The Auto Power Off function has switched the camera off. • The batteries are flat. • The camera will not focus. • You tried to take a picture using the built-in flash when you were also using the battery adapter. • An error occurred. 	<ul style="list-style-type: none"> • Load a media. • Load a new media or erase some frames. • Remove the write-protection. • Format the media. • Clean the SmartMedia contact surface (the gold-colored area) with a clean dry cloth. • Load a new media. • Switch the camera on. • Fit new batteries. • Set the focusing mode to manual (M), focus on the subject manually and take the picture. • Close the built-in flash and then take the picture. • Refer to the warning displays on P.121, 122 and 123 and take the appropriate action.
I can't use the flash to take pictures.	<ul style="list-style-type: none"> • The flash is set to Suppressed Flash mode. (The flash is closed.) • You pressed the shutter button while the flash was charging. • You are using the battery adapter. 	<ul style="list-style-type: none"> • The flash pops up. • Wait until charging is completed before pressing the shutter button. • Use lithium batteries.

Problem	Cause	Solution
The playback image is too dark even though I used the flash.	<ul style="list-style-type: none"> • The subject is too far away. • Something is obstructing the flash. 	<ul style="list-style-type: none"> • Move closer to the subject. • Remove the lens hood.
The playback image is blurred.	<ul style="list-style-type: none"> • The lens is dirty. • The camera is not focused. 	<ul style="list-style-type: none"> • Clean the lens. • Focus the camera correctly (⇨ P.28).
I cannot format the SmartMedia or Microdrive.	<ul style="list-style-type: none"> • The SmartMedia or Microdrive is write-protected. • The media is damaged. 	<ul style="list-style-type: none"> • Remove the write-protection. (Peel off the write-protect sticker.) • Use a new media.
I cannot erase all the frames.	<ul style="list-style-type: none"> • The frame is protected. 	<ul style="list-style-type: none"> • Remove the frame protection.
Nothing happens when I use the camera switches and dials.	<ul style="list-style-type: none"> • Camera malfunction. • The batteries are flat. 	<ul style="list-style-type: none"> • Remove the power supply (the batteries) and then reload them and try again. • Fit new batteries.
No image appears on the color LCD monitor when I press the "PLAY" button.	<ul style="list-style-type: none"> • There is no media loaded. • There is no photography data recorded on the media. 	<ul style="list-style-type: none"> • Insert a media that contains some photography data.
There is no image on the TV screen.	<ul style="list-style-type: none"> • The camera and TV are not connected correctly. 	<ul style="list-style-type: none"> • Connect the camera and TV correctly. • Set the TV input to "VIDEO".

Specifications

Item		Specifications																														
Type of camera		Interchangeable-lens SLR-type digital camera																														
Recording	Recording media	<ul style="list-style-type: none"> Slot 1: SmartMedia (3.3 V) Slot 2: Microdrive and CompactFlash (CF type II) 																														
	Recording modes	Design rule for Camera File System-compliant (Exif Ver.2.1 JPEG-compatible, TIFF-RGB or TIFF-YC), DPOF-compatible																														
	Recorded image sizes	3040 × 2016 (6.13 megapixels), 2304 × 1536 (3.54 megapixels) and 1440 × 960 (1.38 megapixels)																														
Imaging	Picture element	23.3 × 15.6 mm Super CCD with primary color filter (total no. of pixels: 3.4 megapixels in an interwoven pattern)																														
	Sensitivity	Equivalent to ISO 320, 400, 800 or 1600																														
Camera	Exposure control	Auto, P, S, A, M, Portrait, Landscape, Close-up, Sport and Night scene																														
	Lens mount	Nikon F mount																														
	Interchangeable lenses	See P. 106, 107.																														
	Actual field of view	Approx. 1.5× the rated focal length of the lens (for 35 mm camera equivalent)																														
	Viewfinder	Eye-level optical type (coverage: approx. 90% vertical and approx. 93% horizontal)																														
	Eyesight adjustment	-1.5 to +1.0 dpt																														
	Auto focus	TTL phase detection with auxiliary AF lamp																														
	Lens servo	AF (single AF servo or continuous AF servo automatically selected by the camera), M (manual)																														
	Exposure metering modes	3D 6-zone multi-pattern metering, 6-zone multi-pattern metering and Center-weighted metering																														
	Shutter	Electronically controlled descending-type focal-plane shutter																														
	Shutter speeds	1/2000 to 30 sec.																														
	Exposure compensation	±3 EV (in 1/3 EV step increments)																														
	AE lock	BV memory type using AE lock button (center-weighted metering)																														
	Self-timer	2 seconds or 10 seconds																														
	Synchro contacts	X contacts only (semiconductor-type), synchronized with External Flash at low shutter speeds of 1/125 sec. and slower.																														
	Built-in flash	Manual pop-up type. Guide No. 15 (ISO 100 • m) Illumination angle covers 28-mm lens field of view, TTL-BL flash control <table border="1" style="margin-left: 20px;"> <thead> <tr> <th></th> <th>F2.8</th> <th>F4.0</th> <th>F5.6</th> <th>F8</th> <th>F11</th> </tr> </thead> <tbody> <tr> <td>ISO 320</td> <td>2.2-10.3 m (7.2-33.8 ft.)</td> <td>1.8-8.7 m (5.9-28.5 ft.)</td> <td>1.3-6.3 m (4.3-20.7 ft.)</td> <td>0.8-4.3 m (2.6-14.1 ft.)</td> <td>0.8-3.2 m (2.6-10.5 ft.)</td> </tr> <tr> <td>ISO 400</td> <td>2.2-11.5 m (8.2-37.7 ft.)</td> <td>2.0-9.7 m (6.6-31.8 ft.)</td> <td>1.5-6.8 m (4.9-22.3 ft.)</td> <td>1.0-4.8 m (3.3-15.7 ft.)</td> <td>1.0-3.6 m (3.3-11.8 ft.)</td> </tr> <tr> <td>ISO 800</td> <td colspan="5">Not supported *1</td> </tr> <tr> <td>ISO 1600</td> <td colspan="5">Not supported *1</td> </tr> </tbody> </table>		F2.8	F4.0	F5.6	F8	F11	ISO 320	2.2-10.3 m (7.2-33.8 ft.)	1.8-8.7 m (5.9-28.5 ft.)	1.3-6.3 m (4.3-20.7 ft.)	0.8-4.3 m (2.6-14.1 ft.)	0.8-3.2 m (2.6-10.5 ft.)	ISO 400	2.2-11.5 m (8.2-37.7 ft.)	2.0-9.7 m (6.6-31.8 ft.)	1.5-6.8 m (4.9-22.3 ft.)	1.0-4.8 m (3.3-15.7 ft.)	1.0-3.6 m (3.3-11.8 ft.)	ISO 800	Not supported *1					ISO 1600	Not supported *1				
		F2.8	F4.0	F5.6	F8	F11																										
	ISO 320	2.2-10.3 m (7.2-33.8 ft.)	1.8-8.7 m (5.9-28.5 ft.)	1.3-6.3 m (4.3-20.7 ft.)	0.8-4.3 m (2.6-14.1 ft.)	0.8-3.2 m (2.6-10.5 ft.)																										
	ISO 400	2.2-11.5 m (8.2-37.7 ft.)	2.0-9.7 m (6.6-31.8 ft.)	1.5-6.8 m (4.9-22.3 ft.)	1.0-4.8 m (3.3-15.7 ft.)	1.0-3.6 m (3.3-11.8 ft.)																										
	ISO 800	Not supported *1																														
ISO 1600	Not supported *1																															
Synchro modes	Normal synchro, Red-eye reduction, Red-eye reduction slow synchro, Slow synchro																															
Accessory shoe	Hot shoe (with flash contacts, TTL automatic flash control contacts and ready light contacts) With safety lock mechanism																															
Remote release	Release socket on shutter button																															

*1 The flash does not operate correctly at ISO800 and ISO1600. Use Preview mode to check the exposure when shooting at these film speeds.

Item		Specifications	
Display	Information display	Viewfinder display Top display panel Rear display panel (backlit)	
	Color LCD monitor	2-inch 200,000-pixel low-temperature polysilicon TFT	
I/O sockets	Video out	mini pin jack (3.5-mm dia.) (NTSC/PAL)	
	Digital (USB)	Data downloading to PC and taking pictures your PC	
	DC input	Used to connect AC Power Adapter AC-5VH	
Main Functions	Auto Power Off	Off, 2 min. or 5 min. (disabled during auto playback and when the camera operates connected to a PC)	
	Battery check	<ul style="list-style-type: none"> Battery checking performed on camera and at image processor respectively. However, checking is performed on the camera when the battery adapter is used. Check levels: 3 levels (full, flat and low) If the battery capacity is insufficient in either the image processor or camera, a warning is displayed for 3 seconds and then the Auto Power Off function is triggered. 	
	White balance	AUTO, Sunny, Shade, Fluorescent 1, Fluorescent2, Fluorescent3, Incandescent and Custom	
	Playback	Single-frame, 4-frame, 9-frame, Playback zoom, Histogram and Auto-play	
	Erase modes	Format, All frames, Single frame	
	Image quality settings	Color, Tone, Sharpness	
	Other	DPOF, Multi-exposure, Frame no. memory, Custom WB setting, Standard chart	
General	Dimensions	148.5 × 125 × 79.5 mm (5.8 × 4.9 × 3.1in.) (excluding LCD screen and attachments)	
	Mass (Weight)	800 g (28.2oz.) (body only, not including batteries)	
	Power supply	Image processor	4 AA-size batteries (alkaline (provided), Ni-MH (sold separately) or Ni-Cd (sold separately)) Special AC Power Adapter AC-5VH (sold separately) CR2025 lithium button cell battery (supplied, for clock and settings backup)
		Camera	2 CR123A lithium batteries (provided) Power also available from image processor using battery adapter. However, the built-in flash cannot be used when the battery adapter is used.
	Number of shots using batteries*2	Approx. 650 (without previews, recorded on SmartMedia, built-in flash off) (with Ni-MH batteries (HR-3UF) used in image processor and CR123A lithium batteries used in camera)	
	Operating conditions	Temperature: 0°C to +40°C. (+32°F to +104°F) (Note that the range for Microdrive is +5°C to +40°C (+41°F to +104°F).) Humidity: 80% or less (no condensation)	
Accessories	See P.9.		

*2 This is a guide to the number of consecutive shots that can be taken at normal temperatures. Actual numbers may vary depending on the camera's operating conditions and the amount of charge in the batteries.

Specifications - continued

- Design and specifications are subject to change without notice.
- The color LCD monitor on your digital camera is manufactured using advanced high-precision technology. Even so, small bright points and anomalous colors (particularly around text) may appear on the monitor. These are normal display characteristics and do not indicate a fault with the monitor. This phenomenon will not appear on the recorded image.

Standard Number of Available Shots (Recorded Images)

The number of available shots varies slightly depending on the type of subject. The actual number of available shots also varies more widely from the standard number as the capacity of the media increases.

Image Size	Media	Hi(RGB)	Hi(YC)	Fine	Normal	Basic
3040 × 2016	Microdrive (340 MB)	19	29	144	305	741
	SmartMedia (64 MB)	3	5	26	55	132
	SmartMedia (32 MB)	1	2	12	27	66
	SmartMedia (16 MB)	0	1	6	13	32
2304 × 1536	Microdrive (340 MB)	33	50	249	520	1249
	SmartMedia (64 MB)	6	9	45	94	221
	SmartMedia (32 MB)	3	4	22	47	110
	SmartMedia (16 MB)	1	2	11	23	54
1440 × 960	Microdrive (340 MB)	84	126	502	972	1822
	SmartMedia (64 MB)	15	23	90	172	331
	SmartMedia (32 MB)	7	11	45	86	165
	SmartMedia (16 MB)	3	5	22	42	82

Compatible Media

- This camera is guaranteed to operate with FUJIFILM SmartMedia.
- Although FUJIFILM has tested many major types of Microdrives and CompactFlash cards, some media may not be compatible with this camera.

Compatible Media (As of July 2000)

Microdrive	IBM: 340MB
CompactFlash	Sandisk: SDCFB-16/32/40/48/64/98/128 Lexar Media: 4× type 8 MB to 80 MB 8× type 8 MB to 160 MB

Batteries Uses and Symptoms When Batteries are Depleted

	Uses	Symptoms When Depleted
AA-size Alkaline batteries	Image processing	"Err" appears on the top display panel
Lithium batteries CR123A	Power functions such as auto focus, aperture, mirror and shutter operation, and charge the flash.	The camera will not switch on.
Button cell lithium battery CR2025	Stores the time and other settings	When the AA-size batteries are removed for replacement, the time and other settings revert to the factory default settings.

Safety Notes

- The warning and attention symbols shown below are used to indicate the severity of the injury or damage that will result if the indicated information is ignored and the product is used incorrectly as a result.

**WARNING**

Indicates information which, if ignored, could cause death or serious injury.

**ATTENTION**

Indicates information which, if ignored, could result in personal injury or physical damage.

- The icons shown below indicate types of information that should be observed.



Indicates important information which the user should bear in mind.



Indicates a forbidden action.



Indicates a mandatory action that the user must perform.

**WARNING**

Unplug from
power socket

When an abnormal event occurs, switch the camera off and remove the batteries or disconnect the AC power adapter.

Continued use of the camera when an abnormal event occurs, such as the camera emitting smoke or an unusual odor, can cause a fire or electric shock.

- Contact an authorized FUJIFILM dealer.



Do not allow water or foreign objects to enter the camera.

If water or any foreign object gets into the camera, switch the camera off, remove the batteries and disconnect the AC power adapter. Continued use of the camera can cause a fire or electric shock.

- Contact an authorized FUJIFILM dealer.



Do not put the camera down on an unstable surface.

The camera could tip over and fall, resulting in an injury.



Do not
disassemble

Never attempt to disassemble or modify this camera. (Never open the camera casing.)

Do not use the camera when you have dropped the camera or the casing is damaged.

Any of these actions can cause a fire or electric shock.

- Contact an authorized FUJIFILM dealer.

Safety Notes - continued



WARNING



Do not use this camera in a bathroom or shower.

This can cause a fire or electric shock.

Do not use
in a bathroom or
shower



Never take pictures while moving.

Never use this camera while you are walking or while you are in control of a vehicle such as a car.

This can cause a collision or traffic accident.



Do not touch metal components during a thunderstorm.

This can result in an electric shock from lightning induction when lightning strikes.



Do not use the batteries other than as directed.

Load the batteries with the positive ⊕ and negative ⊖ poles positioned as indicated.



Do not attempt to disassemble, modify or heat the batteries.

Do not drop the batteries or subject them to impacts.

Do not attempt to recharge lithium or alkaline batteries.

Do not store batteries with other metal products.

Any of these actions can cause the battery to burst or leak fluid, resulting in a fire or injury.



Do not use AC power adapters or batteries other than those specified for use with this camera.

This can cause a fire.



If fluid leaks from the batteries and gets into your eyes or on your skin or clothing, blindness or injury could result. Flush the affected area immediately with clean water and seek medical help as soon as possible.



When disposing of or storing batteries, cover the battery terminals with insulating tape (cellophane tape, etc.).

• Contact with other batteries or metal objects can cause the batteries to emit sparks or burst.



Do not use the camera in atmospheres that contain flammable gas.

This can cause an explosion or fire.

Do not use



Do not look directly at the sun or any strong light source through the camera or lens.

This can cause blindness or damaged eyesight.

Do not look



Take care not to wrap the shoulder strap around your neck. Take particular care not to catch the shoulder strap around the necks of infants or small children.

This can result in the strap becoming wrapped around the neck and cause suffocation.

Do not use



WARNING



Keep button-cell batteries out of the reach of small children to prevent the batteries from being accidentally swallowed.

If swallowed, button-cell batteries can cause symptoms of poisoning. If a battery is swallowed, consult a physician immediately.



ATTENTION



Do not leave the camera in very humid or dusty locations or locations affected by oil smoke or steam.

Leaving the camera in such locations may cause a fire or electric shock.



Do not leave the camera in unusually hot locations.

Do not leave the camera in a closed car or in a location exposed to direct sunlight.

This could cause a fire.



Do not place heavy objects on the camera.

The camera could overbalance and fall, resulting in an injury.



Do not move the camera while the AC power adapter is connected.

This could damage the power cord or the cable and cause a fire or electric shock.



Do not cover the camera or AC power adapter with blankets or bedding.

This can cause heat to build up and result in deformation of the camera casing or a fire.



When cleaning the camera or when the camera will not be used for an extended period, remove the batteries and disconnect the AC power adapter.

Failure to do so could cause a fire or electric shock.



Do not operate the flash close to people's eyes.

This can cause temporarily damaged eyesight.



Regularly request internal inspections and cleaning.

The buildup of dust inside the camera could cause camera faults or a fire.

• Contact an authorized FUJIFILM dealer and request internal cleaning once every two years.



When you are not using the camera, fit the lens cap on the lens and store the camera out of direct sunlight.

Sunlight entering the lens could cause a fire.

Storage note



Do not move the camera or lens while it is mounted on a tripod.

The camera could fall over or strike someone and cause an injury.

Do not move



FUJI PHOTO FILM CO., LTD.

26-30, Nishiazabu 2-chome, Minato-ku, Tokyo 106-8620, Japan

Printed in Japan

Printed on recycled paper.

FGS-002107-SZ