

**BEDIENUNGSANLEITUNG
INSTRUCTION MANUAL
MANUEL D'INSTRUCTIONS
MANUAL DE INSTRUCCIONES
使用説明書**

Voigtländer
Germany

Voigtländer

Seit 1756

**BESSA-R2A
BESSA-R3A
BESSA-R4A**

Congratulations on your selection of Bessa camera. This is a compact and lightweight rangefinder camera with VM lens mount.

Quick and accurate focusing is possible; turn the focusing ring until the doubled images seen at the finder's center converge to a single image.

Utilizing Auto and Manual exposure metering systems the camera is equipped with, you can easily get the proper exposure. You will be aided by LED indicators displayed in the viewfinder.

Description of Parts

- (1) Shutter Speed Index
- (2) Shutter Speed ISO/ Film Speed Ring
- (3) AE Release Button
- (4) Film Speed Window
- (5) Shutter Release Button
- (6) Film Advance Lever
- (7) Film Counter
- (8) Main Switch
- (9) Neck Strap Eyelet
- (10) Lens Release Button
- (11) Accessory Shoe
- (12) Frame Selector Lever
- (13) Film Rewind Crank
- (14) Film Rewind Knob
- (15) Film Rewind Crank Tip
- (16) Backdoor Lock Lever
- (17) Rangefinder Window
- (18) Bright-line Frame Illumination Window
- (19) Viewfinder Window
- (20) VM Lens Mount

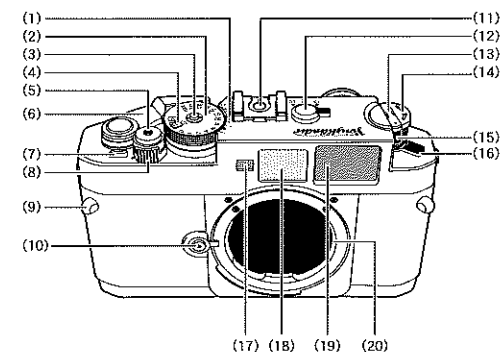

- (21) Synchro Contact
- (22) Finder Frame
- (23) Viewfinder
- (24) AE Lock Button
- (25) Tripod Socket
- (26) Battery Chamber Lid
- (27) Film Guide Rails
- (28) Rewind Fork
- (29) Film Cartridge Chamber
- (30) Film Pressure Plate
- (31) Film Cartridge Confirmation Window
- (32) Back Door
- (33) Winder Coupler
- (34) Film Rewind Button
- (35) Film Take-up Spool
- (36) Film Sprockets

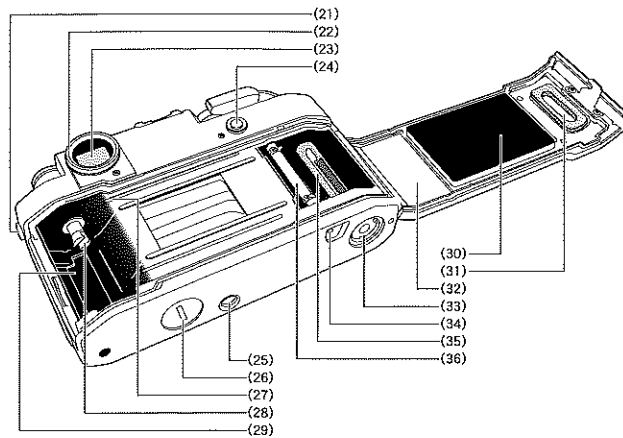

28

Attaching the neck strap

Attach the neck strap to the camera as illustrated below.

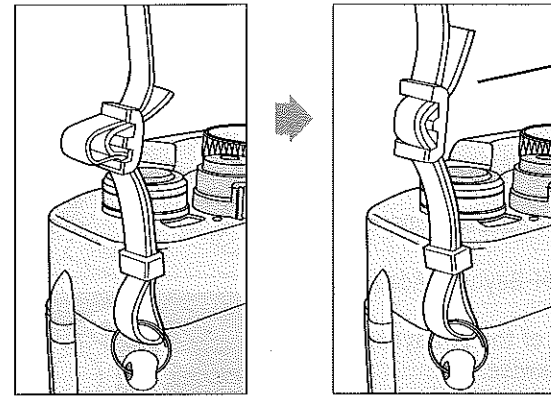

Be sure the protective end of the strap is on the inside.

29

Mounting/Removing Lens

●M (Bayonet) Mount lens

1. To mount the lens, match the red mark on the camera body with the red mark on the lens barrel, then insert the lens in the camera body and turn the lens clockwise until it clicks.
2. To remove the lens from the camera body, press the Lens Release Button(10) and turn the lens all the way counterclockwise, then lift it straight out of the mount.

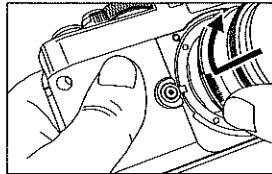

●L Mount lens

1. Mount M-Bayonet Adapter Ring (available separately) on the camera body.
*Any one of three types of M-Bayonet Adapter Ring can be used.
*Refer to the instruction manual for M-Bayonet Adapter Ring to mount it on the camera body.
2. Align the lens mount screw with that of the M-Bayonet Adapter Ring, then turn the lens clockwise.
*Pay attention not to over tighten the lens to the body.
3. To remove the lens from the camera, press the Lens Release Button and turn the lens counterclockwise.

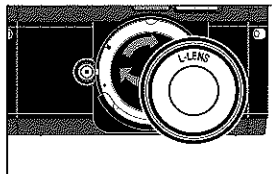
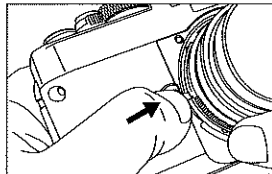

30

Inserting Batteries

1. Turn the Battery Chamber Lid(26) counter clockwise using a coin or screwdriver blade.
2. Two LR44 type alkaline or two SR44 type silver batteries may be used to power the camera.
3. Place the batteries so that both positive + sides are toward the bottom of the battery chamber.
4. Turn the Battery Chamber Lid(26) clockwise until it closes firmly.

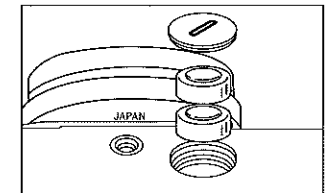
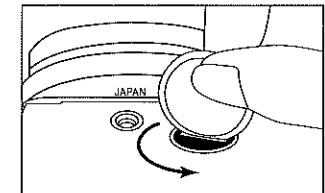

31

Battery Check

1. Turn the Main Switch(8) to the ON position.
2. Wind the Film Advance Lever(6)
3. Set the Shutter Speed Ring(2) to any position except the "B"(bulb) position.
4. Lightly press the Shutter Release Button(5) half way while looking through the View Finder(23).
 - If you can see one or two LEDs lit or blinking on the bottom of the Viewfinder, then battery condition is satisfactory.
 - If both "2000" and "1" LEDs are blinking slowly in addition to one or two of the LEDs mentioned above, then the batteries are running out of power. Prepare a new set of batteries.
 - If no LED is lit, then the batteries need to be replaced or have been loaded incorrectly.
 - The LEDs will remain on for about 8 seconds after you stop pressing the Shutter Release Button.

Note: In order to avoid battery consumption, turn the Main Switch to the OFF position while the camera is not in use.

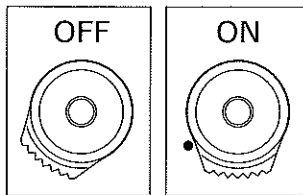

32

Loading Film

1. To open the back Door(32), unfold and lift the Film Rewind Crank(13) up, then pull the Film Rewind Knob(14) up while holding the Backdoor Lock Lever(16) in the release position. When the Back Door is opened, the Film Counter(7) will automatically reset to "S."
2. Insert the film cartridge into the Film Cartridge Chamber(29) so that the protruding end of the film cartridge faces downward. Do this in a place away from direct sunlight.
3. Rotate the Film Rewind Crank carefully while pushing down lightly on the Film Rewind Knob, until the film locks on the Film Rewind Fork(28).

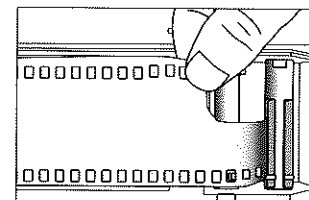
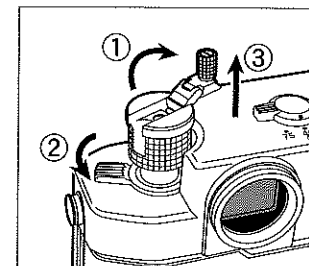

33

4. Insert the film leader into the grooves of the Film Take-up Spool(35) and place it so that the spool teeth engage the film edge perforations.
5. Check that the film perforations are properly engaged by the teeth of the Film Sprockets(36) and that the film slides smoothly along the Film Guide Rails(27) while turning the Film Advance Lever(6) lightly in order to advance the film. Caution: Do not touch the shutter curtains.
6. Gently close the Back Door and push it until it clicks and locks shut.
7. Remove slack by turning the Film Rewind Crank(13) gently in the direction of the arrow until the loaded film is properly tensioned. Stop turning the crank when it is tight, and then return the crank to its original closed position.
8. Advance the film a couple of frames, by depressing the shutter release button a few times and operating the Film Advance Lever until the Film Counter(7) indicates "1". Make sure that the Film Rewind Shaft is rotating each time the film is advanced, which will tell you that the film is advancing properly.
- When advancing the film, wind the Film Advance Lever slowly and securely until the film is fully transported to the next frame.

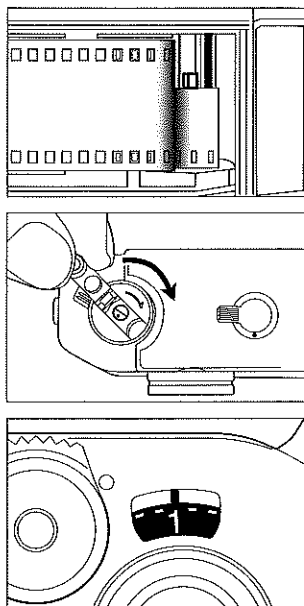

Film Speed Setting

1. Film speed is indicated on the outside of the film package or in the film instructions.
2. To set the Film speed: while lifting the Film speed Set Ring(2), turn it until the arrow indicator on the inner ring points to the corresponding Film speed (ASA/ISO) value which can be seen through the Film speed Window(4). Caution: Make sure to set film speed exactly at the detent, not in between, otherwise proper shutter speeds will not be shown in the viewfinder.

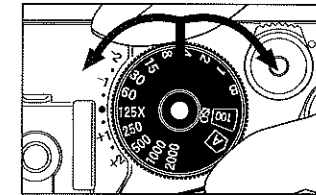

Condition	Aperture(F value)
At Night.	Faster than F2
When you want shallow depth-of-field	Faster than F2
Indoors in normal conditions	F2 - F4
Outdoors on a cloudy day	F4 - F8
Outdoors on a fine day	F8 - F11
Seaside in midsummer	F11 - up
Mountain area with snow	F11 - up

Exposure Setting

Aperture Priority Mode (auto exposure mode or "AE")

With Aperture Priority (AE) mode, the camera will automatically select the proper shutter speed based on the lens aperture value and brightness of the subject.

You may select lens aperture value with consideration of the film speed, the depth-of-field you want, the brightness of the subject, ...etc.

Recommended aperture value with ISO 100/21° film under typical situations as shown on the list. (Shutter speed corresponds from 1/2000 to 8 sec.)

1. Turn the Main Switch to the ON position
 2. Set the Shutter Speed Ring to align "A" mark at the Shutter Speed Index(1).
 3. Turn the aperture ring on the lens to the desired aperture value.
 4. Advance the film and press the Shutter Release Button half way, while looking through the Viewfinder.
- In the finder, the LED display will indicate the correct shutter speed.
 - If the LED blinks "2000" quickly, it means out of range due to over exposure. Turn the aperture ring on the lens to higher setting.
 - If the LED blinks "1" slowly, the shutter will be released at the speed of 1 sec. to 8 secs.
 - If the LED of "1" blinks fast, it means under the range of exposure due to low light. Turn the aperture ring on the lens to a lower setting.
 - The LED will remain on for about 8 seconds after you stop pressing the Shutter Release Button. If the LED goes off while composing your shot, then press the Shutter Release Button again (half way) to reactivate the meter indicator.
 - The LEDs will not come on if the film is not advanced.

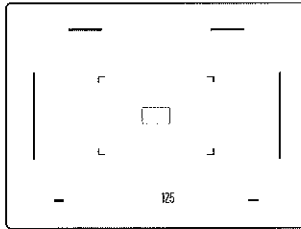
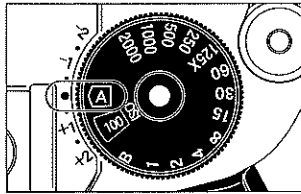

Example: Shutter will be released at 1/125 sec.

Exposure Compensation

You can also use the Exposure Compensation mode to use a different exposure value than the one that aperture priority has determined automatically. You can change the value to both brighter (+ compensation) or darker (- compensation). The amount you can compensate for is +/- 2 steps, by 1/2 step increments. Set the "A" indicator on the Shutter Speed dial to the desired value of compensation. When active, the Exposure Compensation Mode, the indicator LED of the compensated shutter speed will blink slowly.

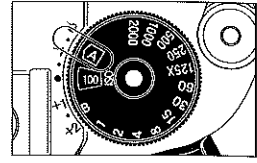

Example: Compensate by -1.5 steps.

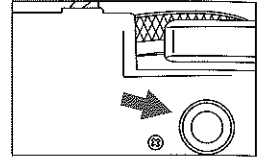

AE Lock function

Use the AE lock function with Aperture Priority mode or Exposure Compensation mode. The exposure value at the moment when AE Lock Button is pressed will be stored and also the LED indication in the finder will be locked.

1. Place the camera near enough to the subject to have the image centered in the middle of the finder.
 2. Press the Shutter Release Button in a half way and check the LED indicator in the finder. Then press the AE Lock Button (24) and reframe your composition.
- Exposure value will be locked while the AE Lock Button is pressed and held.
 - Exposure value will be released when you stop pressing the AE Lock Button.
3. Create your composition and release the shutter.
- The LEDs will remain on about 8 seconds after you stop pressing either the Shutter Release Button or the AE Lock Button.

Exposure Setting

Manual Exposure

Recommended shutter speeds with ISO 100/21° film under typical conditions as shown on the list.

- Indications on the Shutter Speed Ring
"2000" means 1/2000 sec.
"1" means 1 sec.
"B" means Bulb
- With brighter and/or fast moving subjects, it is recommended to use higher shutter speeds.

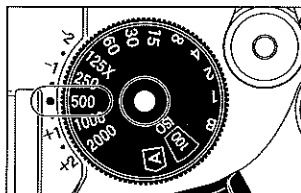

Condition	Shutter speed(sec.)
Stationary subject in subdued light	1/1 - 1/15
Indoors in normal conditions	1/30 - 1/60
Outdoors on a fine day	1/125 - 1/250
Seaside in midsummer	1/500 - 1/2000
Mountain area with snow	1/500 - 1/2000
Fast moving subjects	1/500 - 1/2000

1. Turn the Main Switch to the ON position
2. Set the Shutter Speed Ring to the desired shutter speed setting.
 - In order to set the Shutter Speed Ring to any of the manual shutter speed indicators (1/2000 - B) from Auto Exposure mode or Exposure Compensation mode, press the AE Release Button(3) and turn the Shutter Speed Ring as appropriate.
3. Adjust your focus and press the Shutter Release Button in half way while looking through the finder.
 - You will see two LED indicators in the finder. One indicates the manually set shutter speeds are on. A second blinking one indicates the proper shutter speed.
4. Turn either the aperture ring on the lens and/or the Shutter Speed Ring to align the two LEDs until they converge into one light.
 - When the blinking LED converges with the other lit indicator, and thus only one LED is lit in the finder, it means you have selected the proper exposure value.
 - If the LED of "2000" blinks fast when the Shutter Speed Ring is set to 2000, it means out of range due to over exposure.
 - If the LED of "1" blinks fast when the Shutter Speed Ring is set to 1, it means out of range due to under exposure.
 - The LED will remain on for about 8 seconds after you stop pressing the Shutter Release Button or stop turning the Shutter Speed Ring.

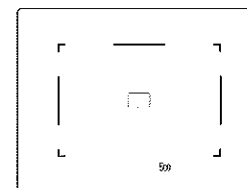
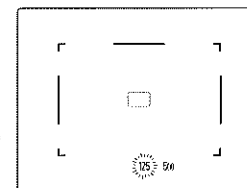

Selecting Frame

Turn the Frame Selector Lever(12) and the frame illustrated below will be shown in the finder. The frame shows the range to be included when used with the lens indicated. Select the frame pattern according to the focal length of the lens you have mounted on the camera.

Additionally, the parallax is automatically corrected according to the combination of your shooting distance and the lens selected.

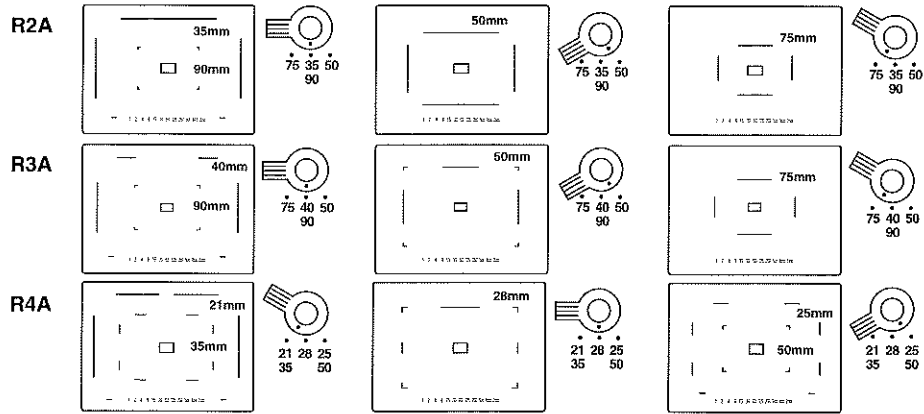

40

Focusing 1

For accurate focusing, with subjects such as a group of people, a "double image" viewfinder with a central focus zone will ensure that sharp images are easily recorded.

To achieve this, simply turn and adjust the lens until the double image converges to one.

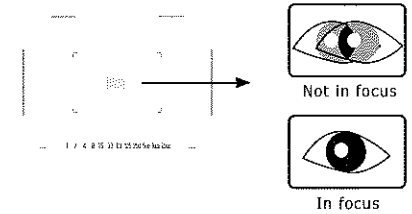

Focusing 2

For accurate focusing of architectural or technical subjects with vertical lines, use the "Split image" focusing option. To achieve this, simply turn and adjust the lens so that the lines join together.

* When focusing, make sure to put your eye in the middle of the Viewfinder.

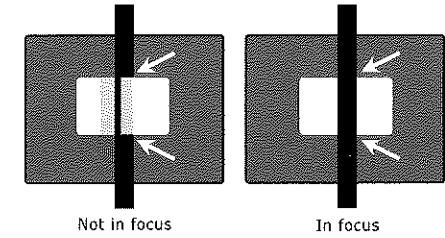

41

Holding Camera

1. Hold the camera in the palm of the left hand so as to turn the lens focusing ring easily with your left hand.
2. Hold the camera body steady and place your right index finger lightly on the shutter release button.
3. Press your left elbow lightly against your body and then look through the rangefinder eyepiece to steady the camera against your face. Then relax your right arm holding the camera.

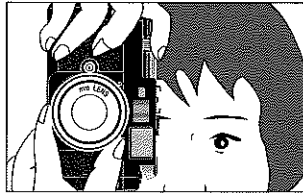
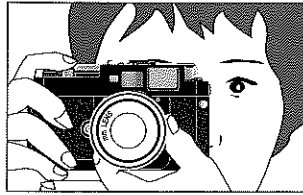

42

Rewinding the Film

1. When the roll of film ends, the advance lever will no longer advance smoothly. Check the Film Counter(7) display. If the Film Counter shows that all the frames of the loaded film have been exposed, then the film needs to be rewound.
2. Press the Film Rewind Button (34) on the bottom of the camera.
3. Unfold the Film Rewind Crank(13) and turn it in the direction of the arrow. In case if the Film Rewind Crank Tip (15) stops in between Film Rewind Knob (14) and camera body (Fig.1), after press the film Rewind Button (34) turn the Film Rewind Knob (14) till the Film Rewind Crank Tip (15) will be in the free space to unfold. (Fig.2)
4. Once the winding tension eases, the film is completely wound into the cartridge and it is ready to be removed..
5. Pull up the Film Rewind Knob(14) while keeping the Back Door Lock Lever toward the rear in order to open the Back Door and take out the film.
6. Remove the film cartridge in a place away from direct sunlight.

Note: If the film reaches the end of the roll during film advance, the film advance lever will lock. Rewind the entire roll, then complete the movement of the film advance lever after removing the cartridge which will reset it.

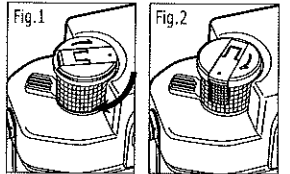
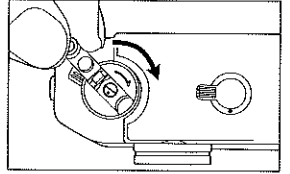
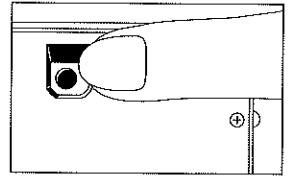

43

"B"(bulb) setting

1. With the Shutter Speed Ring(2) set at "B" position, the shutter will remain open for as long as the Shutter Release Button(5) is held down.
2. This setting is useful when a longer exposure than one second is required, such as in photography at night.
3. Be sure to use a tripod and/or cable release when using long shutter times to avoid camera movement.

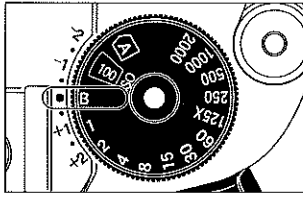

44

Flash Photography

1. Simply fit the flash unit into the Accessory Shoe(11).
2. Set the Shutter Speed Ring(2) at 1/125 sec. or slower.
3. Set the corresponding aperture value from the Guide Number of your flash unit by operating the aperture ring value to use, follow the instruction given in the manual of your flash unit.

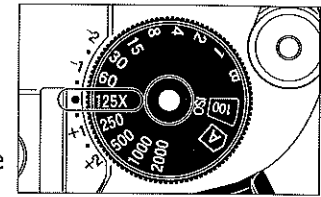

45

Optional Accessories

1. Manual operation fast Trigger Winder

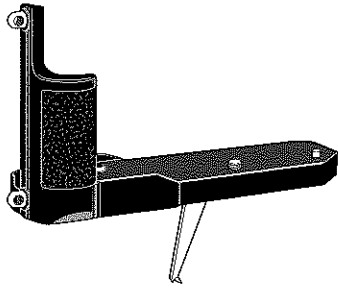

46

2. M-Bayonet adapter ring

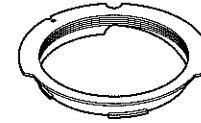

47

Specifications

Type: 35mm camera with electronically controlled focal plane shutter and TTL metering system featuring LED display.

Film Format: 35mm film, 24x36mm

Lens Mount: VM mount

Shutter: Electronic controlled metal focal plane shutter with vertical operation.

Finder magnification: x0.7 Bessa-R2A
x1.0 Bessa-R3A
x0.52 Bessa-R4A

Framelines: Bessa-R2A: 35mm, 50mm, 75mm, 90mm
Bessa-R3A: 40mm, 50mm, 75mm, 90mm
Bessa-R4A: 21mm, 25mm, 28mm, 35mm, 50mm

Focusing: Coincidence type

Exposure display: LED shutter speed indication in viewfinder.

Exposure Metering System: TTL center-weighted average metering.

Exposure Coupling Range: EV1-19(ISO 100, F1.4, 1sec. - F16, 1/2000sec)

Flash Terminal: X synchronic contact synchronized at 1/125sec or slower speed.

Film Advance: By single and/or multiple ratcheting lever action. Double exposure lock system. Trigger winder available as optional extra.

48

Film Rewind: By film rewind button and manual crank.

Film Counter: Additive type with auto reset when opening the back door.

Film Speed Range: ISO 25 - 3200 by 1/3 steps.

Power Source: Two 1.5V Alkaline batteries(LR44) or Silver batteries(SR44)

Dimensions: 135.5(W) x 81(H) x 33.5(D)mm

Weight: Bessa-R2A, R3A: 430g
Bessa-R4A: 440g

● These specifications and external appearance are subject to change without prior notice for the purpose of improvements.

49

Symbol for separate collection applicable in European countries [English]



This symbol indicates that this product is to be collected separately.

The following apply only to users in European countries.

• This product is designated for separate collection at an appropriate collection point.

Do not dispose of as household waste.

• For more information, contact the retailer or the local authorities in charge of waste management.

Symbol für getrennte Wertstoff-/Schadstoffsammlung in europäischen Ländern [Deutsch]



Dieses Symbol zeigt an, dass dieses Produkt separat entsorgt werden muss.

Folgendes gilt für Verbraucher in europäischen Ländern.

• Dieses Produkt darf nur separat an einer geeigneten Sammelstelle entsorgt werden.

Eine Entsorgung im Hausmüll ist unzulässig.

• Wenden Sie sich für nähere Informationen bitte an Ihren Händler oder die örtlich für Abfallentsorgung zuständigen Behörden.

Symbol pour la collecte sélective applicable aux pays européens [Français]



Ce symbole indique que ce produit doit être collecté séparément.

Les mesures suivantes concernent uniquement les utilisateurs européens.

• Ce produit doit être jeté séparément dans un point de collecte approprié. Ne jetez

pas ce produit dans une poubelle réservée aux ordures ménagères.

• Pour plus d'information, contactez le détaillant ou les autorités locales responsables de la gestion des ordures.

Simbolo per la raccolta differenziata applicabile nei paesi europei [Italiano]



Questo simbolo indica che il prodotto va smaltito separatamente.

La normativa che segue si applica soltanto agli utenti dei paesi europei.

• Il prodotto è designato per lo smaltimento separato negli appositi punti di raccolta.

Non gettare insieme ai rifiuti domestici.

• Per maggiori informazioni, consultare il rivenditore o gli enti locali incaricati della gestione dei rifiuti.