

Rolleiflex 3003

User's manual



Rollei
fototechnic

Rollei

fototechnic

Rollei Fototechnic GmbH
Salzdahlumer Straße 196
Postfach 3245
3300 Braunschweig

E
989007/02 - 87/FW
Printed in West Germany
Technical modifications reserved

Contents

Safety Instructions	3	7 Time exposure	33
Components and functions	6	8 Open or working aperture?	33
Introduction	7	9 Series exposures	34
A word about the operating instructions	7	10 Multiple exposures	34
The key points in brief	8	11 Use of flash units	35
Handling and use	17	Interchangeable elements	36
Checking the power supply	17	Interchangeable lenses	36
Charging the power pack	17	Interchangeable focusing screens	37
Fitting the lens	18	Interchangeable magazines	38
Loading the film magazine	18	Interchangeable power packs	38
Changing the magazine	20	Interchangeable viewfinders	38
Setting the film speed	20	The main accessories	39
Changing the film pressure plate	20	The Rolleiflex 3003 System	41
Adjusting the loop handgrip	21	Lens tables	44
Attaching the carrying strap	21	Troubleshooting guide	48
Setting the main switch	22	Technical data	50
Setting the magazine switch	22		
Holding the camera	23		
Adjusting the viewfinder eyepiece	24		
Focusing	24		
The viewfinder hood	25		
Setting the shutter speed	26		
Exposure metering in the automatic mode	26		
Exposure metering in the manual mode	28		
Note on viewfinder information	28		
Shutter release	29		
After the last frame	30		
Rewinding the film	31		
Practical tips	32		
1 Frame counter	32		
2 Power pack capacity	32		
3 Function indicator »F«	32		
4 Selective exposure metering	32		
5 Exposure correction	33		
6 Measured value storage	33		

IMPORTANT SAFETY INSTRUCTIONS

When using your photographic equipment, basic safety precautions should always be followed, including the following:

Read and understand all instructions before using.

Close supervision is necessary when any appliance is used by or near children. Do not leave appliance unattended while in use.

Care must be taken as burns can occur from touching hot parts.

Do not operate appliance with a damaged cord or if the appliance has been dropped or damaged — until it has been examined by a qualified serviceman.

Position the cord so that it will not be tripped over, be pulled, or contact hot surfaces.

If an extension cord is necessary, a cord with a current rating at least equal to that of the appliance should be used. Cords rated for less amperage than the appliance may overheat.

Always unplug appliance from electrical outlet before cleaning and servicing and when not in use. Never yank cord to pull plug from outlet. Grasp plug and pull to disconnect.

Let appliance cool completely before putting away. Loop cord loosely around appliance when storing.

To protect against the risk of electric shock, do not immerse this appliance in water or other liquids.

To avoid the risk of electric shock, do not disassemble this appliance, but take it to a qualified serviceman when some service or repair work is required. Incorrect reassembly can cause electric shock when the appliance is used subsequently.

The use of accessory attachments not recommended by the manufacturer may cause a risk of fire, electric shock or injury to persons.

Connect this appliance to a grounded outlet.

KEEP THESE INSTRUCTIONS SAVE

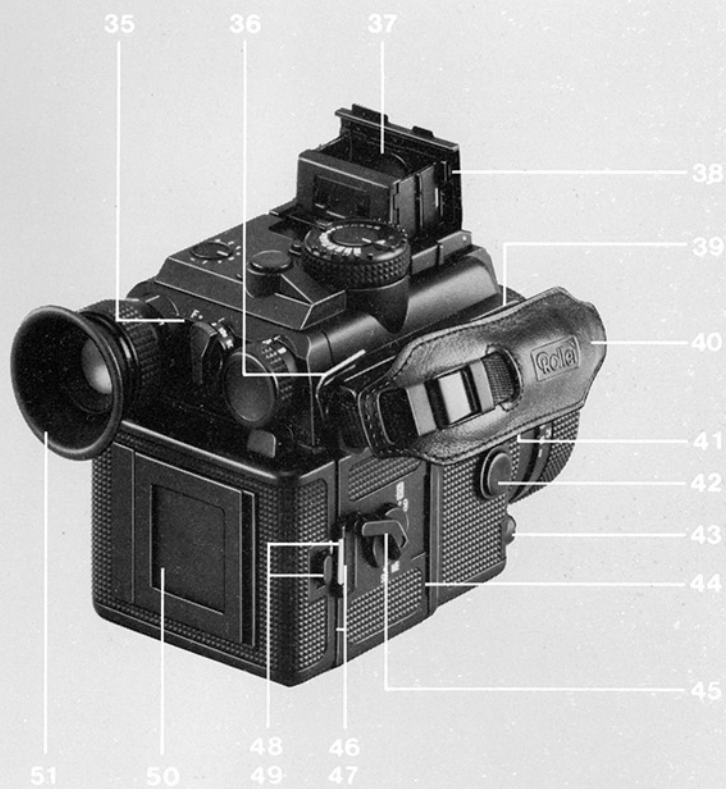
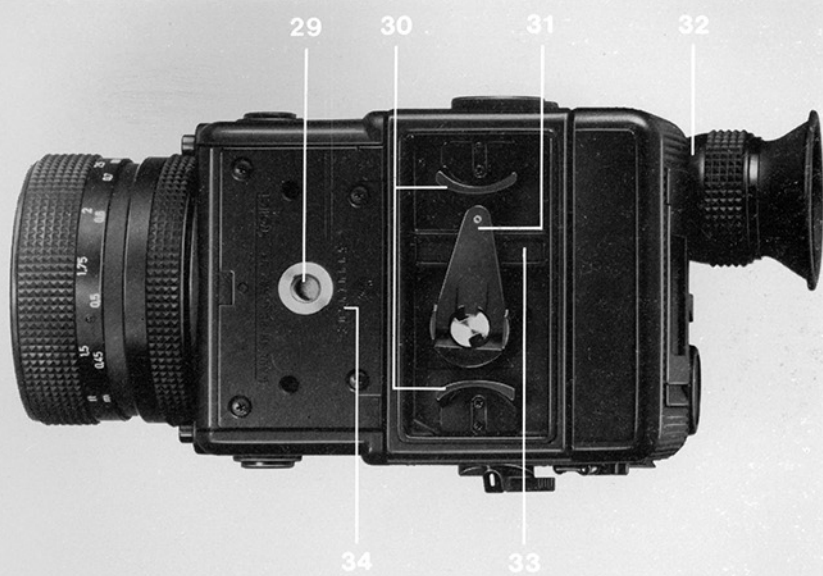

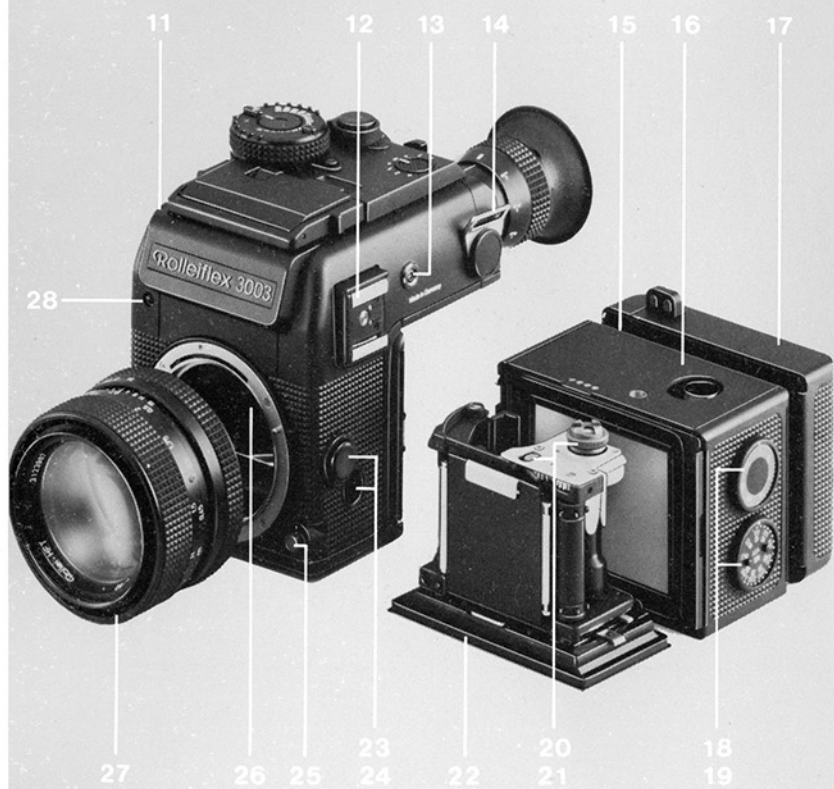
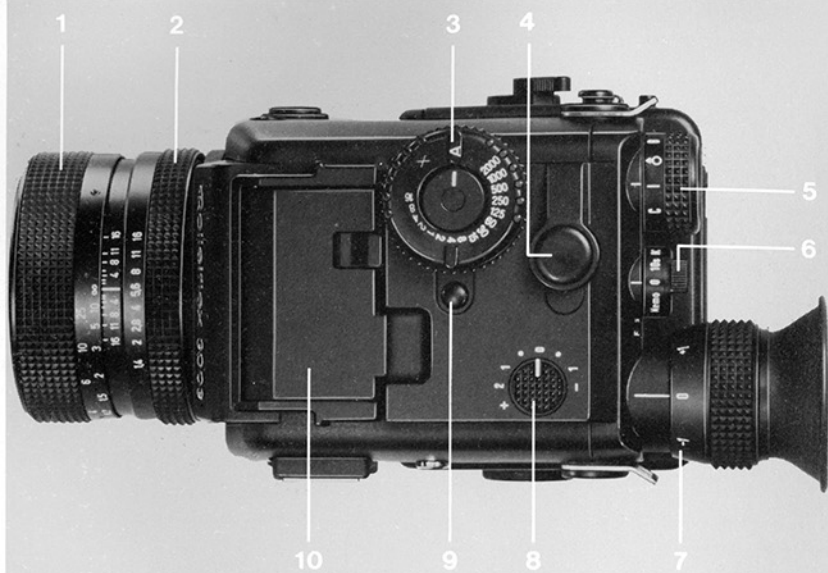

Components and functions

- 1 Focusing ring on the lens
- 2 Aperture control ring on the lens
- 3 Control dial for shutter speed and operational mode
- 4 Top shutter release
- 5 Camera main switch for series exposures
single exposures
off
time exposures
- 6 Toggle switch for memory
off
auto release
power check = B.C.
- 7 Indicator scale for finder eyepiece
- 8 Setting disc for exposure correction
- 9 Release button for control dial 3
- 10 Cover flap for viewfinder hood
- 11 Camera body
- 12 Hot shoe with control contacts and centre contact for flash units
- 13 Synchronizing contact for flash units
- 14 Left-hand eyelet for carrying strap, capable of 90° rotation
- 15 Memo holder on magazine, for tear-off tab from film box
- 16 Film magazine
- 17 Power pack
- 18 Frame counter
- 19 Film speed dial
- 20 Film transport wheel
- 21 Release button for transport wheel 20
- 22 Film insert
- 23 Left-hand shutter release
- 24 Connection socket for remote control
- 25 Release button for lens bayonet
- 26 Focusing screen
- 27 Lens
- 28 Red LED for auto release function
- 29 1/4" tripod bush
- 30 Release button for film insert
- 31 Lockable folding rewind handle
- 32 Eyepiece for telescopic viewfinder
- 33 Serial number on film magazine
- 34 Serial number on camera body
- 35 Function indicator »F«
- 36 Right-hand eyelet for carrying strap, capable of 90° rotation
- 37 Flip-up magnifier in the viewfinder
- 38 Folding viewfinder hood
- 39 Removable support for loop handgrip
- 40 Adjustable loop handgrip
- 41 Retaining screw for loop handgrip
- 42 Right-hand shutter release
- 43 Selector button for open or working aperture metering
- 44 Masking slot for magazine drawslide
- 45 Magazine switch for detaching magazine removing film insert
multiple exposures
single exposures
- 46 Release button for film magazine
- 47 Storage compartment for magazine drawslide
- 48 Magazine drawslide
- 49 Release button for power pack
- 50 Memo holder on power pack for tear-off tab from film box
- 51 Eyecup for telescopic viewfinder

Introduction

When you chose the Rolleiflex 3003, you chose one of the most professional cameras on the market today. As you begin to use the camera, you will appreciate its comprehensive range of features which are only available in this form on the Rolleiflex 3003:

- Interchangeable magazine. With this magazine, you can change film at any time without losing a single picture (from standard to high-speed film, from transparency to negative stock, from colour to black and white).
- Twin viewfinder system. Telescopic viewfinder and viewfinder hood in a single camera. This feature opens up new opportunities for taking exceptional photographs.
- Built-in high-performance motor. The camera is ready to shoot automatically. Or it can be used to make fascinating series exposures at 3 frames per second.
- Two complete lens ranges with top-quality lenses from Zeiss, Schneider and Rolleinar, from super wide-angle and telephoto to zoom and shift.
- A comprehensive range of accessories. These accessories open up for you the whole world of creative photographic composition.

These operating instructions are intended to help you to get the best out of your camera. They should therefore be carefully observed at all times.

A word about the operating instructions

These operating instructions provide the user with the technical knowledge needed to get the best out of the technology offered by this camera.

To begin with, all the important components and functions are introduced. Next follows a short guide to the camera for the reader in a hurry to get on with his photography.

Then everything the user needs to know about the Rolleiflex 3003 is described and illustrated in detail. The various operations are explained in order – from the preparation of the camera for use through to the removal of the exposed film.

The next section contains a set of practical tips. Additional information on the camera is provided in the form of hints for special photographic situations.

In the event of operating faults – which even occur with the experienced photographer when taking a shot in a hurry or after a long period without using the camera – the troubleshooting chart will help you to trace the cause and find a suitable remedy in the shortest possible time.

The component numbers in the text and the illustrations always correspond to the same part. Most of them are given on the pull-out chart. It is recommended that you read these instructions with the chart folded out.

Because the operating instructions go with the camera, they have been produced in pocket-size format so that they can be conveniently carried about. We recommend that you keep them handy whenever you use the camera – minor operating problems can usually be solved on the spot by consulting the manual. Besides, companions and colleagues will certainly want to have a look at it.

Rollei
fototechnic

The key points in brief

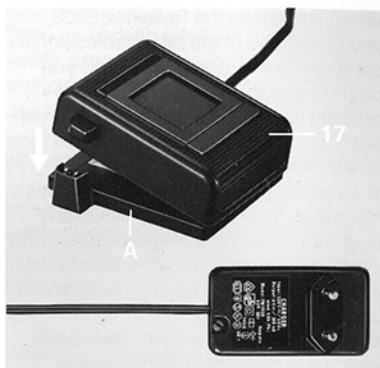
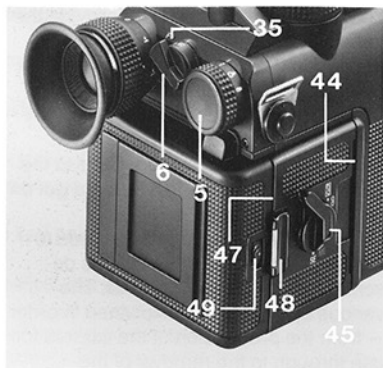

– Rapid information for those in a hurry to get on with their photography: the most important operations and techniques for familiarizing oneself with the camera and its functions.

Anyone wanting a more detailed explanation of the Rolleiflex 3003 right from the start should turn to page 17.

Power check

Remove magazine drawslide 48 from masking slot 44 and insert in storage compartment 47. Press in main switch 5 and set to »I«. Turn magazine switch 45 to the »ME« or »SE« position and set toggle switch 6 briefly to »BC«. If function indicator »F« 35 lights up, the power pack is sufficiently charged; if it remains dark, the power pack has to be recharged.¹⁾

Charging the power pack

With the standard 3003 charger: push release button 49 forward and down as shown by the arrow.

Take out power pack 17 and press it firmly on to contact plate A of the charger. Plug into the mains (220 V/50 Hz). The charging time is about 14 hours, for approximately 1000 exposures. After charging, replace the power pack, making sure that it snaps into position.

¹⁾ Due to the technology of the batteries, this test is only quite accurate *prior* to using the camera. Following one or more exposures, the test can indicate »empty batteries«, i. e. the function indicator »F« does not light up. Several minutes should then be allowed to pass before carrying out the test again.

The key points in brief

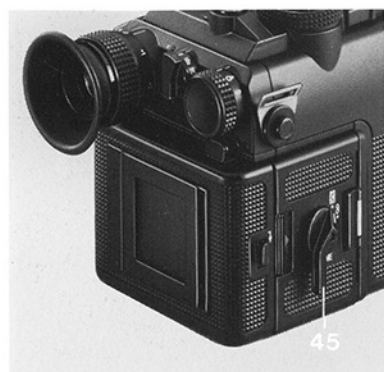

Fitting the lens

Remove the dust cap from the camera body by turning anticlockwise, after pressing red release button 25. Insert lens 27 as far as it will go, with the red spot against the red spot on the camera bayonet, then engage by turning clockwise.

To remove, press red button 25 again and turn the lens anticlockwise.

Loading the film magazine

For this operation, the magazine can remain attached to the camera and the power pack does not have to be removed from the magazine. Set magazine switch 45 to the  symbol.

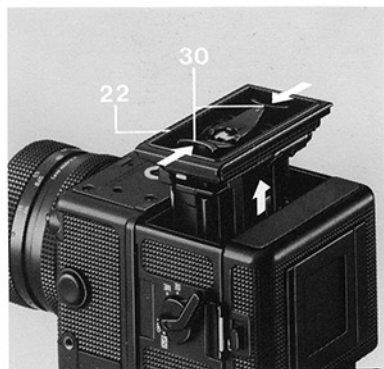

Press buttons 30 together and pull out film insert 22.

Insert the film cartridge: pull out about 8 cm of film leader and lead through, over the pressure plate and *under* the retaining strip. Lay the film over the sprocket roll and clamp behind one of the white clips. Turn transport wheel 20 as far as it will go. When transport stops, press red button 21 and again turn the transport wheel as far as it will go.

Put film insert 22 back into the magazine and lock in place.

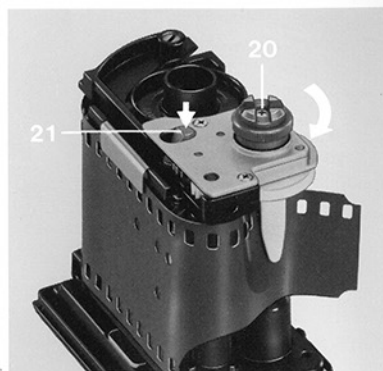
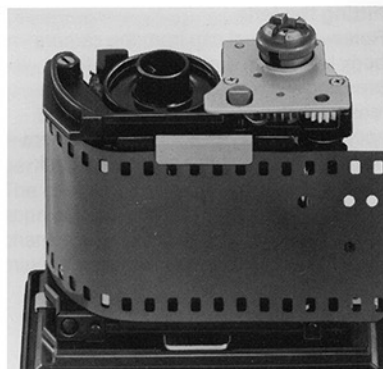
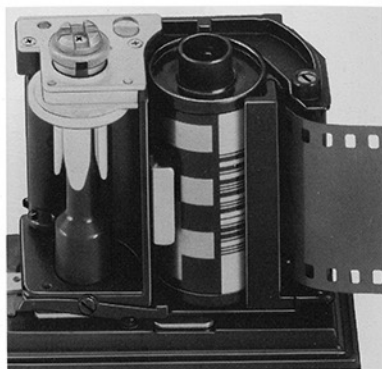

The key points in brief

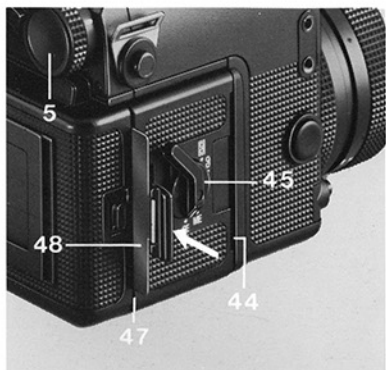

Pull out magazine drawslide 48 from masking slot 44 and slide into storage compartment 47. Set magazine switch 45 to SE and main switch 5 to »I«.

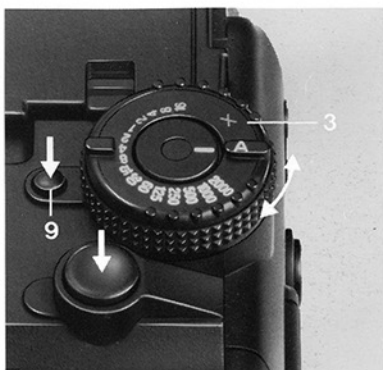

Set 1/2000s on control dial 3 after unlocking with button 9, so as to avoid slow shutter speeds occurring in poor light conditions. Press one of the shutter release buttons as many times as necessary to bring frame counter 18 to »1«. Then turn control dial 3 back to position »A«.

The key points in brief

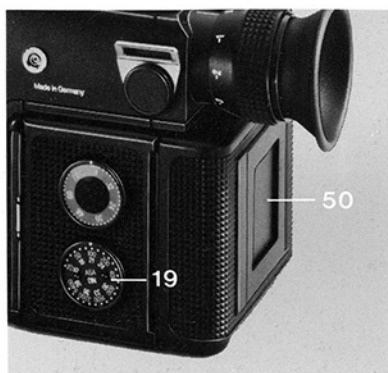

Setting the film speed

Turn film speed dial 19 to the DIN/ASA value of the film loaded. As a reminder: slide the tear-off tab from the film box into memo holder 15 on the magazine or memo holder 50 on the power pack.



Setting the operational mode

Press in main switch 5 and turn to »I«, set toggle switch 6 to »0« and magazine switch 45 to »SE« (single exposure).

The key points in brief

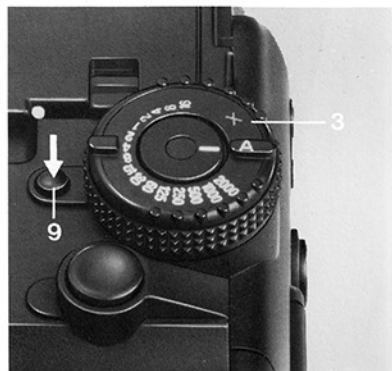

Switching on the automatic shutter speed control

Press release button 9. Turn control dial 3 and lock on »A«.

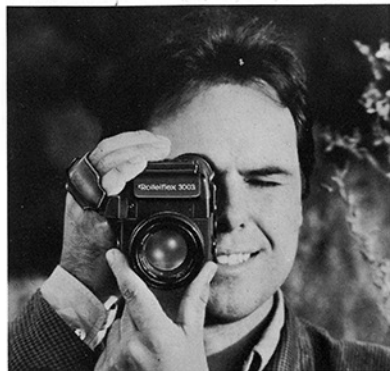

Holding the camera

Put your right hand *through* the loop so that you can reach the top shutter release and the shutter speed dial; focusing and aperture adjustment are carried out with the left hand.

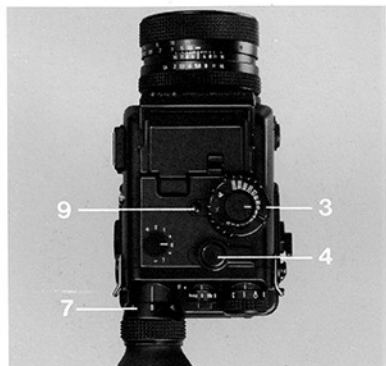

Adjusting the viewfinder eyepiece

For this operation, the viewfinder hood must be closed. Press button 9, turn dial 3 to 1/15s. Set aperture 5.6 on the lens. Press the top shutter release to the first position and hold. While looking through the eyepiece, turn it until the red indicators showing »15« and »5.6« can be seen clearly and distinctly.

The value read off scale 7 is merely a reference for the eyepiece adjustment and not a dioptré value.

Focusing

Focus by turning ring 1 on the lens to obtain maximum sharpness.

Illustration:

Microprism area A free of glitter, split-image rangefinder B without stepped outlines.

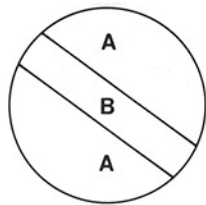

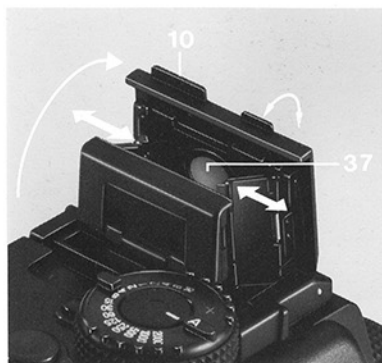

Opening the viewfinder hood

Flip up cover flap 10. Lift magnifier 37 up by its grip.

To close the viewfinder hood: flip in the magnifier, fold in the side-walls and allow the cover flap to spring down.

Note: hood open = telescopic finder covered; hood closed = telescopic finder open.

In the viewfinder hood, both the image and the speed and aperture values are reversed from left to right (for technical reasons).

Exposure metering

Select the required aperture value using control ring 2. When the shutter release is pressed in to the first position, the speed/aperture combination is displayed in the viewfinder. When using the viewfinder hood, keep your eye close to the magnifier (to avoid metering errors due to stray light).

Note: if *all* the shutter speeds light up, press button 43 to switch over to working-aperture metering when using non-standard lenses.

Viewfinder information

To the left * of the finder image: automatic speed setting. If two speeds light up, the intermediate speed is set; if *all* the speeds light up, there is a risk of incorrect exposure.

To the right * of the finder image: selected aperture value together with green flash monitoring light for use with automatic flash and red LED at the top right to show when exposure correction is switched on.

In the centre of the finder image: rectangular light metering area; the most important part of the picture should be in this area.

Centre of the metering area: micro-prism grid and split-image rangefinder (focusing aids).

* using the telescopic viewfinder in the horizontal format

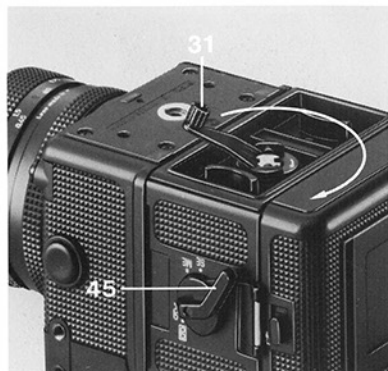

Shutter release

Depending on the selected picture format and the photographic situation, you can use the top, left-hand or right-hand shutter release. Press in fully, past the first stop. The »F« light glows briefly (from frame 1 on) to indicate film transport.

After shutter release

the film is moved on and the shutter is cocked automatically: the camera is immediately ready for shooting again. Frame counter 18 shows the number of frames exposed.

After the last exposure

film transport stops automatically and the »F« light glows continuously.

Winding back the film

Set magazine switch 45 to g . Flip out handle 31 and turn in the direction of the arrow until the catch engages. Continue turning the handle in the same direction until the film is completely (!) rewound into the cartridge.

Fold the handle back and clip in.

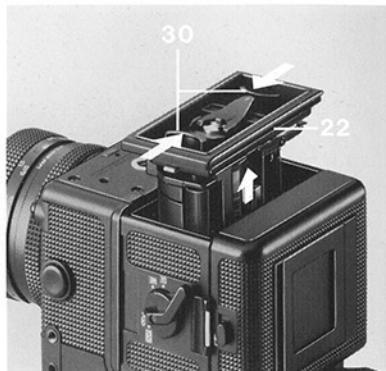

Press release buttons 30 together, pull out film insert 22 and remove the film. Finally replace the film insert and press in. Set main switch 5 to »0«.

Handling and use

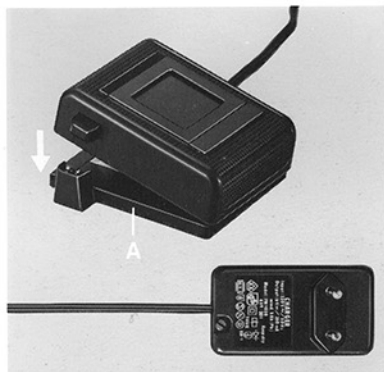
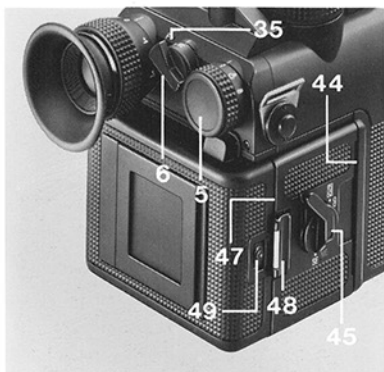

The individual operations are described in sequence, from checking the power supply to removing the exposed film. Special cases which do not occur so frequently in routine camera use are dealt with in the »Practical tips«.

Checking the power supply

Remove magazine drawslide 48 from masking slot 44 and insert in storage compartment 47. Press in main switch 5 and set to »I«. Turn magazine switch 45 to the »ME« or »SE« position and set toggle switch 6 briefly to »BC«. If function indicator »F« 35 lights up, the power pack is sufficiently charged; if it remains dark, the power pack has to be recharged.¹⁾

Charging the power pack

with the standard 3003 charger: push release button 49 forward and down as shown by the arrow, remove the power pack and press firmly onto the contact plate of the charger supplied (with contacts touching). Plug into the mains (220V/50Hz).

After about 14 hours, the power pack is fully charged. A shorter charging time can be used (as and when required), but in that case no information on capacity can be given.

Overcharging by about 2–3 hours does no damage to the batteries; longer and/or frequent overcharging reduces their life.

After charging, the unit should be unplugged and the power pack removed from the charger.

A constant source of power is especially important for the Rolleiflex 3003, since the camera cannot be operated manually. Thus, it is recommended that you always have a second power pack at the ready as a replacement.

Since all batteries gradually lose their charge even when not in use, the power pack should be recharged approximately every three months.

Tip 2 on page 32 contains information on the capacity of the power pack at low temperatures.

¹⁾ Due to the technology of the batteries, this test is only quite accurate *prior* to using the camera. Following one or more exposures, the test can indicate »empty batteries«, i. e. the function indicator »F« does not light up. Several minutes should then be allowed to pass before carrying out the test again.

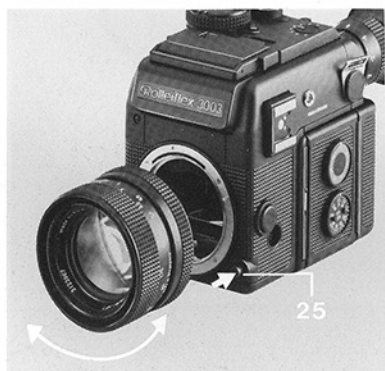

Fitting the lens

Briefly press release button 25 and remove the dust cap from the camera body by turning anticlockwise. Take both dust caps from the lens. Place the red spot on the lens bayonet against the red spot on the camera bayonet, insert the lens fully and engage by turning clockwise.

To remove the lens, press red button 25 again and withdraw the lens by turning anticlockwise.

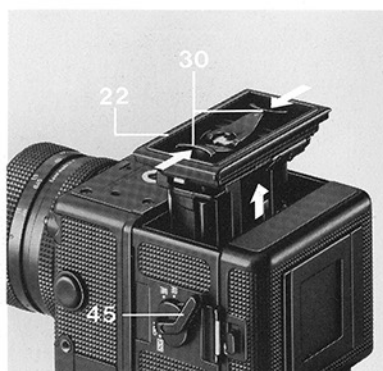

Loading the film magazine

All makes of film currently available on the world market can be used in any lengths up to 72 frames. Bulk stock pre-wound in cartridges can also be used on this camera. A special interchangeable pressure plate is available as an accessory for use with the substantially thinner 72-frame film (to meet exacting focusing requirements) – it is *only* to be used with this film.

When a film is being loaded, the magazine can remain attached to the camera and the drawslide can be left in the masking slot.

Taking out the film insert: set magazine switch 45 to g , press the two release buttons 30 together and thus withdraw film insert 22.

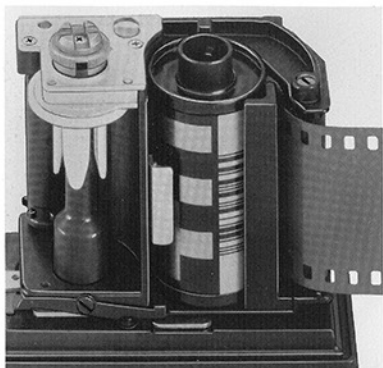

Loading the film: fit the film cartridge into the insert (picture above) and pull out about 8 cm of film leader. The picture above right shows how the film is to be threaded – over the black pressure plate but under the shiny retaining strip. Pass the film over the sprocket roll and clamp behind one of the white clips (picture right). Turn the grey transport wheel 20 clockwise as far as it will go. If the wheel is impeded, press release button 21 and turn transport wheel 20 again as far as it will go.

Fit the loaded film insert into the magazine and press in firmly to engage. Take magazine drawslide 48 out of its masking slot and put it into storage compartment 47. The forward-pointing grip of the drawslide locks the release button of the magazine.

Set magazine switch 45 to »SE« and main switch 5 to »I«. Press release button 9 and set dial 3 to 1/2000s to avoid long exposure times occurring in poor light conditions. Press one of the shutter release buttons repeatedly until frame counter 18 shows »1« (picture on page 20, upper right). Turn dial 3 back to »A«.

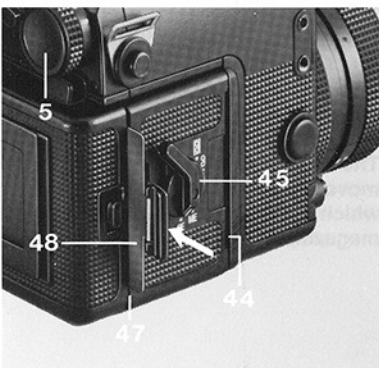
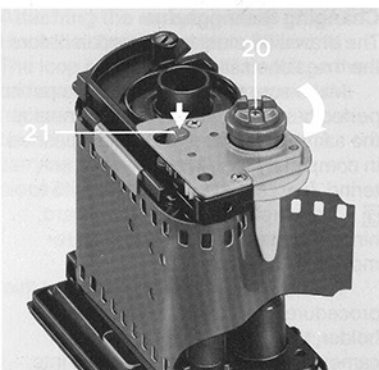
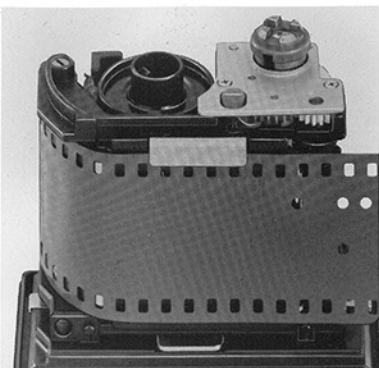

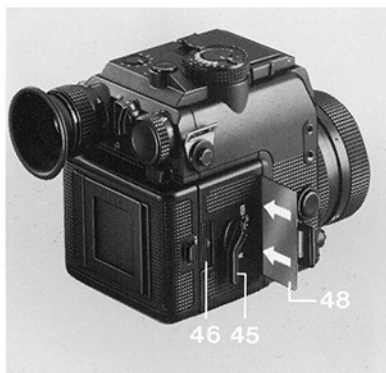

Changing the magazine

The drawslide must be pushed in before the magazine can be detached.

Make sure that the drawslide is put in perfectly *straight* with its front corners at the same level, and that it is also pushed in completely to prevent any light entering. Next set magazine switch 45 to , press release button 46 forward, hinge the magazine out and then remove it.

To attach the magazine, carry out this procedure in reverse: hook into the holder, then press firmly against the camera. Always put the drawslide into the storage compartment.

Each of the interchangeable magazines has its own frame counter and DIN/ASA adjustment. Removal is prevented as soon as the drawslide is pulled out and the magazine switch is no longer in the  position.

The magazine will generally be removed together with the power pack, which will then be fitted to the new magazine.

Setting the film speed

Switch dial 19 to the DIN/ASA value of the loaded film. For continuous exposure correction, it can be set to a different value. In this case, the entire film will be slightly over- or under-exposed.

To remind the user which film is loaded, standard memo holders 50 and 15 are fitted on the power pack and the magazine back — they will accept the tear-off strip from the film box. This is particularly useful when using several different magazines with different film stock.

Changing the film pressure plate

The standard film pressure plate may easily be replaced by the special pressure plate for 72-frame film by pressing out the two holding pins (recognizable by the arrow symbols in the film cartridge space). This operation is best carried out using the blunt end of a pencil or something similar.

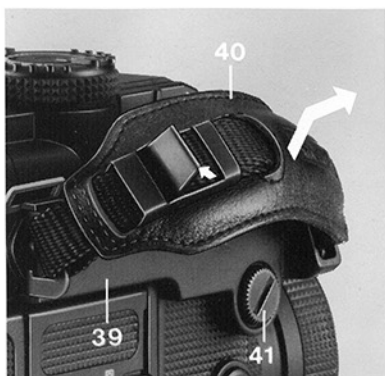

Adjusting the loop handgrip

Loosen the strap as shown in the picture and adjust loop handgrip 40 so that the camera can be held securely with the right hand alone.

To remove the handgrip, e.g. for long periods of tripod photography or when using the viewfinder hood exclusively:

Loosen retaining screw 41 with a coin, lift and remove support 39.

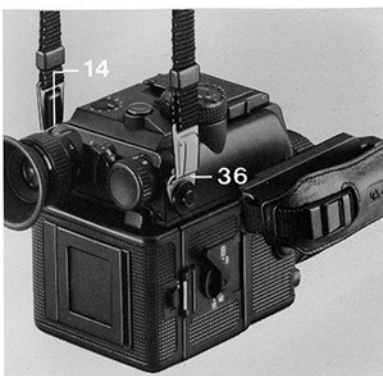

Attaching the carrying strap

Hook the strap into eyelets 36 and 14. The loop handgrip can still be left on the camera. To detach the strap, press the hooks together. The carrying strap can be individually adjusted for length. A carrying strap with a wider shoulder-piece is available as an accessory.

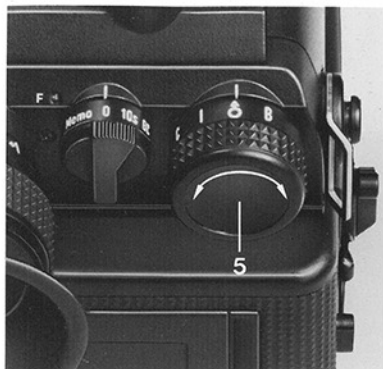

Setting the main switch

By pressing in and turning, main switch 5 can be set to

- C = Continuous exposure; film exposure and transport will continue as long as one of the shutter release buttons is depressed.
- I = Individual exposure: when one of the shutter release buttons is depressed fully, one exposure is made, then the film is moved on one frame.
- O = »Off« setting, which switches off all the functions that depend on the electrical power supply.
- B = Time exposure; duration as required, so long as the shutter release button is held fully depressed (see also practical tip 7).

The switch turns to lock in one of the four positions: intermediate settings are not possible.

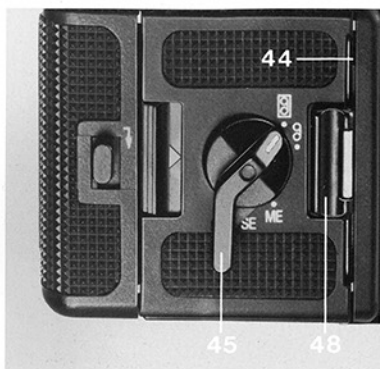

Setting the magazine switch

Switch 45 has four positions with the following functions:

- = for removing the magazine (with or without power pack), operable when drawslide 48 is in masking slot 44.
- = for removal of the film insert (empty or with rewound film), operable independently of the magazine drawslide.
- ME = for multiple exposure (without film transport), operable with the drawslide pulled out. In position ME, the masking slot for the drawslide and the film insert are locked.
- SE = for single exposures (with film transport), operable with the drawslide pulled out. In position SE, the masking slot for the drawslide and the film insert are locked.

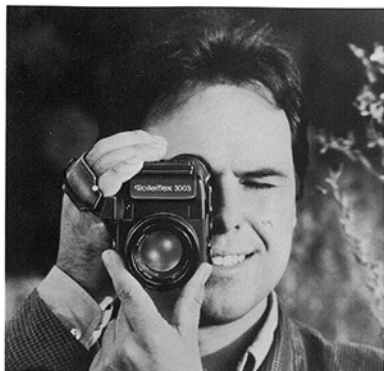

Holding the camera

While there are as many ways of holding the camera as there are photographers, the method shown in the picture is recommended when viewing through the telescopic viewfinder as it has proved effective in practice.

The right hand holds the camera from below through the loop handgrip and thus can operate the control dial and the top shutter release. The left hand is free for focusing and aperture adjustment, and can also switch between working- and openaperture metering.

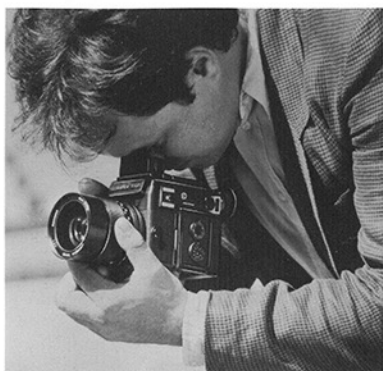

When using the viewfinder hood, the following method of holding the camera is recommended: one hand under the camera, the other free to operate the controls.

Photojournalists and sports photographers like to use the universal handgrip, available as an accessory (see »The main accessories«, page 39).

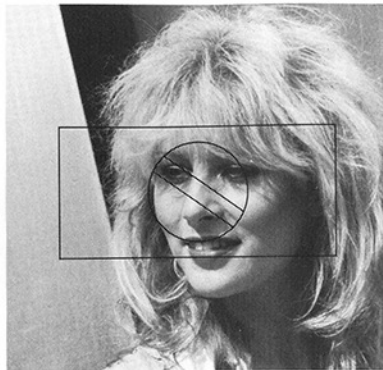
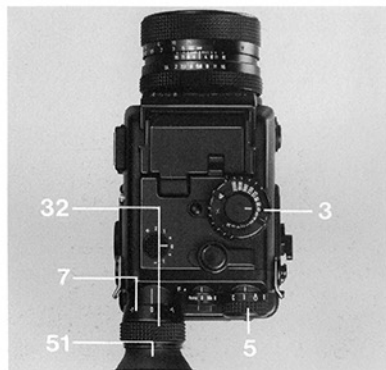

Adjusting the viewfinder eyepiece

Set 1/15s on shutter speed dial 3 and aperture 5.6 on the lens. Set main switch 5 to »I«. With your eye close up against eyecup 51, press one of the shutter release buttons to the first stop and hold. Turn eyepiece 32 until both the red viewfinder displays are quite clear. The value that can now be read off scale 7 is the user's personal setting but not a dioptric value.

The eyepiece adjustment can compensate for defective eyesight up to about ± 4 dioptres. Astigmatism cannot be compensated for in this way – in this case, the image is viewed through spectacles with the eyecup reversed.

Focusing

Focusing is carried out by turning focusing ring 1 on the lens to obtain the sharpest image in the viewfinder:

Both microprism areas are then glitter-free. Lines crossing the oblique split-image area B are not distorted. Also, the focusing screen gives a sharp image.

Lines and edges are best focused with the split-image rangefinder, while undelineated regions are best focused with the microprisms. The focusing screen also enables you to judge the depth of field.

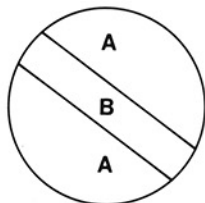

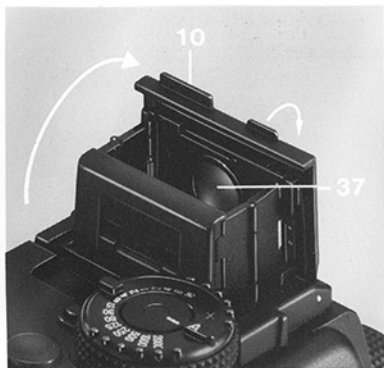

The viewfinder hood

To open, lift flap 10 to lock in the open position; the hood unfolds and gives a clear view. At the same time, the telescopic viewfinder is blanked off.

Magnifier 37 can be flipped up by its grip. It facilitates precise focusing and blocks out stray light that would result in incorrect light metering.

Both the image and the indicators in the viewfinder hood are reversed from left to right (for technical reasons).

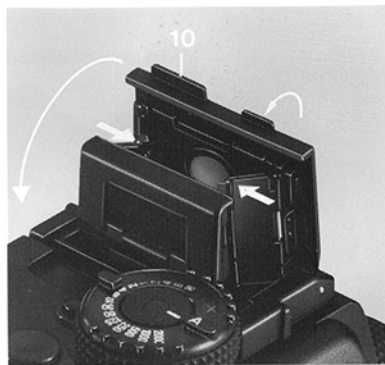

Closing the viewfinder hood: first fold the magnifier down by its grip, then fold in the two sidewalls and allow flap 10 to spring down.

Removing the viewfinder hood: for this operation, the hood must first be closed. Next push the viewfinder forward as far as it will go and then lift it out from the back.



To replace the viewfinder hood, insert it tilted forwards, pushing against the spring pressure in the direction of the lens, and press down to engage.

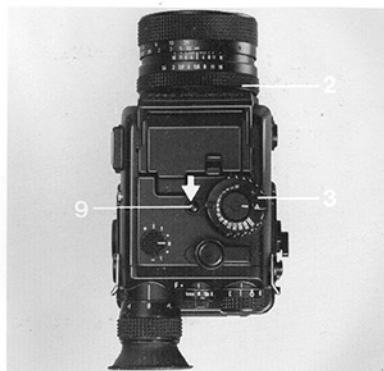

Setting the shutter speed

Press release button 9 and turn dial 3 as required to

- A = Automatic, marked in white; the shutter speed is controlled automatically between 1/2000s and 16s according to the aperture selected.
 - X = X-synchronization at 1/100s, marked in red, for use with connected flash units.
 - 2000 - 2 = choice of shutter speeds from 1/2000s to 1/2s in half steps, marked in white; the appropriate aperture is followed up manually.
 - 1 - 16 = choice of shutter speeds from 1s to 16s in half steps, marked in green, with manual aperture follow-up.
- In positions A and X the shutter speed dial is locked; when set to speeds 1/2000s - 16s, it can be turned freely.

Exposure metering in the automatic mode

Set the dial to »A«. Engage the required aperture with aperture control ring 2. Do not use intermediate values.

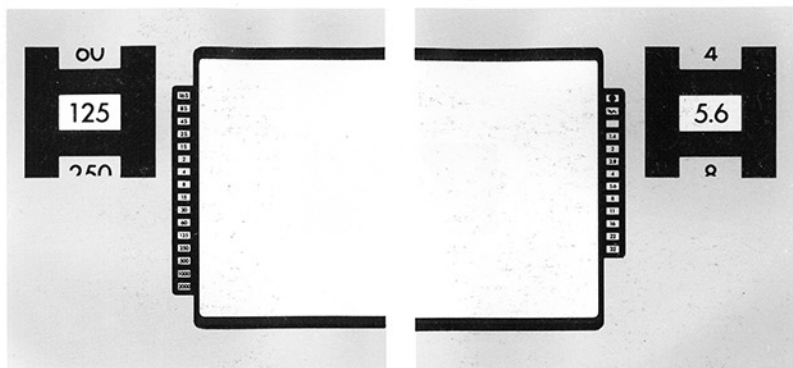

Depress the shutter release to the first stop and hold:

The shutter speed that has been metered and automatically set lights up on the *left-hand* side* of the viewfinder.

If two adjacent speeds light up, the automatic system takes the intermediate value. By choosing a different aperture, a longer or shorter exposure time can be set.

If *all* the speeds light up, there is a danger of over- or under-exposure — correction is required by increasing or decreasing the aperture.

If all the speed indicators continue to glow, you can use a lens with a wider aperture or a lens which can be stopped down further. Other alternatives are to use a faster or slower film or, finally (if the subject of the photograph allows) provide extra light by flash, reflectors or lamps.

On the *right-hand* side* of the viewfinder, the selected aperture lights up: no intermediate values are indicated here.

With older lenses or adapters without the contact step for picking up the maximum lens aperture, the whole range lights up instead of the selected aperture. However, the exposure metering system continues to operate.

With even older lenses and adapters only intended for working-aperture metering, all the speed *and* all the aperture values light up: you then switch to working-aperture metering using button 43.

* with the telescopic viewfinder in the horizontal format

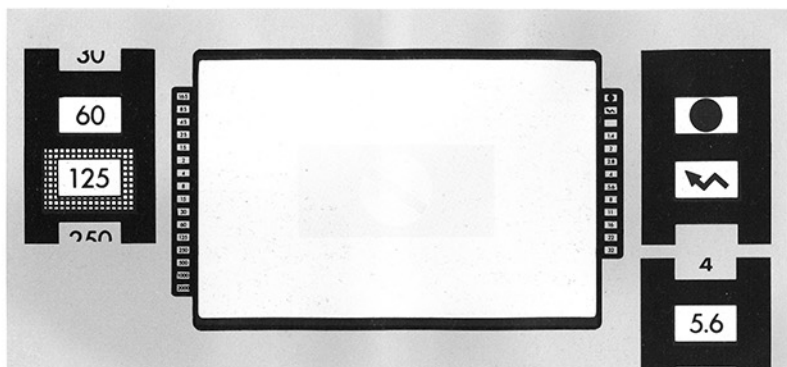

Exposure metering in the manual mode

Switch to open-aperture metering. Select the required shutter speed using dial 3 and set an intermediate aperture value. Depress the shutter release to the first stop. The selected aperture lights up on the right-hand side of the viewfinder. On the left-hand side, the *selected* shutter speed glows steadily, while the *metered* speed flashes on and off.

Now adjust the aperture so that the flashing speed value approaches the constantly glowing value and then goes out. At this point, exposure balance is achieved. If exposure balance cannot be achieved, select a faster or slower speed. In special cases, exposure balance can be obtained manually with the toggle switch 6 in the B.C. position, since the camera is also switched on in the B.C. position. This can be done without touching the shutter release.

Please make sure that the B.C. position is switched off when the camera is not in use. It uses up power.

When making an exposure correction for single exposures, the flashing and steadily glowing speed values can be deliberately different.

Note on viewfinder information

Here is a brief summary of all the important information shown in the viewfinder.

To the left of the finder image: both the metered and the selected shutter speeds –

To the right of the finder image: the selected aperture –

In the centre of the finder image: the rectangular measurement field, which as far as possible should include the most important part of the picture –

In the centre of the measurement field, focusing aids in the form of two microprism zones, divided by the oblique split-image indicator –

The whole focusing screen; with it you can focus and also determine the depth of field –

To the top right of the finder image there is a red LED that lights up when exposure correction is switched on (see point 5 in the Practical tips) as well as a green flash symbol to indicate that the flash is ready and to serve as a monitoring indicator for automatic flash units (see point 11 in the Practical tips).

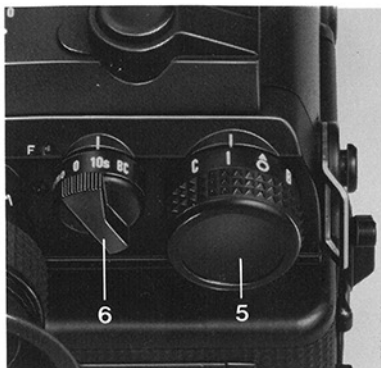

Shutter release

Directly on the camera: depending on the way the camera is held and the photographic situation, you can use the top, right-hand or left-hand shutter release — press the release button fully in past the first (audible) stop.

Using the auto release: set toggle switch 6 to »10s«. Depress one of the shutter release buttons completely. During the time delay of approximately 10s (starting when you let go of the shutter release), red indicator 28 glows.

In the automatic mode, light metering continues during this time delay and determines the shutter speed just before the actual instant of shutter release.

The auto release is used with advantage when shooting with long focal lengths from a tripod, as well as for macro work and reprophotography, to prevent movement caused by pressing the shutter release.

During the time delay, the auto release can still be switched off — first set the main switch to »O«, then set the toggle switch to »0«.



Using the cable remote release: this replaces the former mechanical cable release (not applicable) and provides a gentle, vibration-free shutter release action. This accessory is especially recommended for time exposures in the macro range and for reprophotography. It has two function indicators; the green indicator lights up during the exposure, the red during film transport. It is available with a short 50 cm cable or a 10 m length of cable. It is also available as a foot-operated release, but without function indicators. It is connected to the camera through socket 24.

Using the infrared remote release: for cableless release for single or series exposures from a distance of up to 60 m. Using a special connection in the transmitter, a second Rolleiflex can be operated either simultaneously or independently of the first camera. The power supply is derived from the camera. Monitoring lights indicate transmission and reception and when the shutter is open during time exposures.

With the infrared remote release, many photographs which were scarcely possible until now can be taken with little

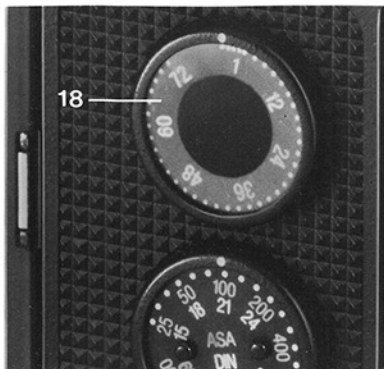

difficulty – e.g. the candid snapshot taken with a hidden camera or documentary photographs of shy wildlife from a safe distance.

Using the timer. The Rollei timer is a versatile electronic timeswitch that enables the camera to take any chosen number of photographs at preset intervals.

It sets intervals between exposures in the exceptionally wide range of 1 second – 59 hours 59 minutes, and can make between 1 and 999 exposures.

The selected programme of the number of exposures and the interval between them is constantly displayed, while the number of exposures remaining or the elapsed interval time can be read from an illuminated display. A programme already under way can be ended prematurely. Unprogrammed exposures can be made in the interval periods.

The quartz-controlled interval times are maintained with extreme accuracy.

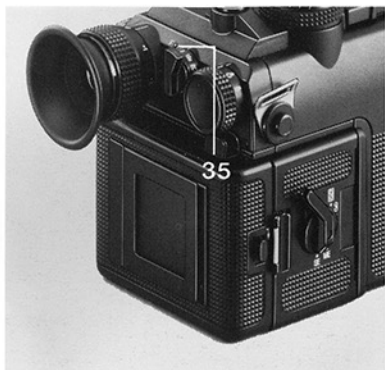

After shutter release, the built-in motor moves the film on, so that the camera is immediately ready to shoot again. The number of frames exposed is shown on frame counter 18.

After the last frame with the magazine attached, the motor disengages and function indicator »F« 35 glows steadily. If you have several magazines, replace the used magazine, otherwise the exposed film is ready to be rewound.

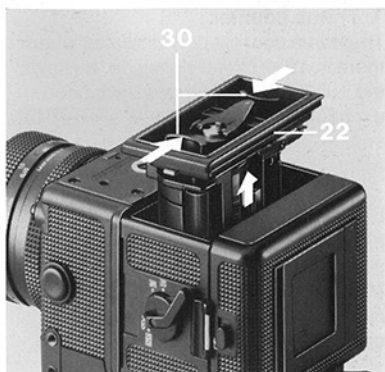
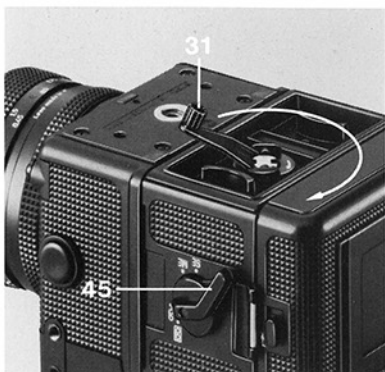

Rewinding the film

During this operation, the magazine can remain attached to the camera and the drawslide can be left in its storage compartment.

Set magazine switch 45 to g . Flip out handle 31 and engage with one of the two catches by turning steadily in the direction of the arrow. Then continue to turn in the same direction until you have wound past the end of the film (where there will be some resistance) and the film is fully (!) rewound into its cartridge. Fold the handle back and press in firmly.

Press the two release buttons 30 together, pull out film insert 22 and remove the film cartridge.

Then put the film insert back and lock, unless loading a new film immediately.

For long intervals between camera use, the viewfinder hood should be closed and the camera should be switched off.

Practical tips

1 Frame counter

The frame counter only operates when there is a film in the magazine. It shows the number of frames that have been exposed and moved on using the »SE« setting. The indicator also works with extra-long film up to 72 exposures.

In case of doubt, film transport can be checked by observing the rotating blank film-carrier spindle (on the underside of the film insert).

Multiple exposures within one frame are not indicated by the frame counter.

2 Power pack capacity

This is naturally reduced at low temperatures, as with all batteries. When fully charged, up to 1000 exposures can be made at a battery temperature between 20°C and 25°C. At -10°C, the capacity is reduced to about 200 exposures.

In severe cold (below -10°C) the power pack should be carried separately from the camera; it should be kept warm and only attached to the camera shortly before use. It is strongly recommended that you keep a fully charged replacement power pack with you at all times.

Power can also be supplied to the camera by using a cable and a connector. In this way, the power pack can be kept warm in a trouser pocket.

In extreme situations (photography in Polar regions, cold stores, refrigeration laboratories), the camera must also be kept at a suitable temperature or insulated.

3 Function indicator »F«

This facility enables the photographer to monitor the progress of important functions and warns of operating faults.

It lights up briefly for satisfactory film transport, beginning when the film is moved on to the *second* frame.

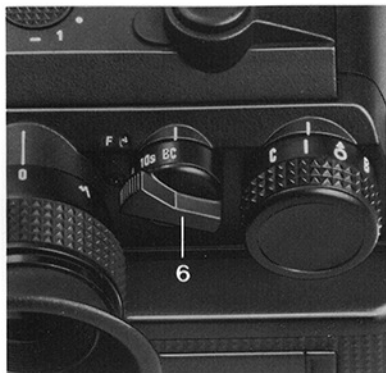

It glows continuously when the release is pressed after the end of the film has been reached; the shutter cannot then be released.

It glows continuously when the shutter release is pressed without previously switching to ME or SE. The shutter release is then locked.

It glows continuously when »Memo« is switched on without switching to ME or SE.

It lights up for the »B.C.« setting of the toggle switch when there is an adequate power supply.

It does not light up for the same toggle switch setting if the power supply is inadequate.

4 Selective exposure metering

The measurement field is identifiable in the viewfinder as a grey-tinted rectangle and should be directed at the most important part of the picture for accurate metering.

To overcome strongly contrasting light conditions, use the well-known technique of metering on the shadows for colour negative or black-and-white film, and on the bright areas for slide film.

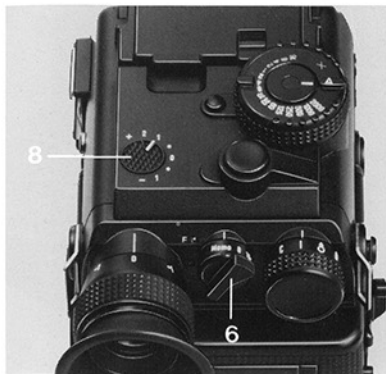

5 Exposure correction

Setting disc 8 permits exposure correction of between -1 and $+2$ exposure values. It can be used for single exposures or for longer series, e. g. in shooting against the light or when deliberately under- or over-exposing.

When this facility is in use, a red monitoring light glows in the top right-hand section of the viewfinder.

To return to normal exposure, it is important to turn disc 8 back to 0. When this is done, the red light goes out.

6 Measured value storage

Take a reading on the most important part of the subject (pressing the release to the first stop) and then set toggle switch 6 to »Memo«. The measured value is stored until the switch is put back to 0 – even when you let go of the shutter release.

In the viewfinder you can recognize the »Memo« setting by the stored unchanging shutter speed indication, even when the shutter release is not depressed, whereas the selected aperture does *not* light up.



7 Time exposure

Close the viewfinder hood to avoid metering errors caused by stray light.

For long exposure times (over 16 s): set main switch 5 to B, hold the shutter release fully down, put switch 6 to »Memo« and then let go of the shutter release. The shutter will remain open until the toggle switch is returned to 0.

8 Open or working aperture?

The system of open-aperture metering described so far provides, among other things, the brightest possible finder image and optimum light metering, since the metering system of the camera was designed for open-aperture metering.

With older Rolleiflex lenses and other makes of lenses without aperture simulation, as well as with non-automatic extension tubes, adapters and bellows, the camera can be switched to working aperture metering, using button 43. The automatic exposure system remains fully operational. If a working aperture measurement is taken using lenses designed for open-aperture metering, the measured values may differ by up to $1/2$ an exposure value.

9 Series exposures

With fast-moving subjects, first meter the exposure and choose an aperture so that a very fast shutter speed is obtained. Set main switch 5 to C and keep the shutter release fully depressed. The camera will then continue to photograph and move the film as long as the shutter release is depressed. If it is held down for the entire length of the film, the series is ended by the automatic transport stop.

A plentiful supply of film and pre-loaded magazines is recommended. For professional work, replacement power packs are also recommended. High-speed films allow short exposure times and small apertures for the best possible depth of field.

In poor light conditions, the shutter speed should be set manually or stored, using toggle switch 6, since there will not be enough time left between the shots for exposure metering.

10 Multiple exposures

With magazine switch 45 in the »ME« position, the film transport system is disengaged, and several exposures can be made in the same film frame. For this operation, the main switch is usually kept on »I« but »B« can also be used, while »C« can be used for continuous shutter release.

Set the magazine switch back to »SE« before (!) the last exposure of a multiple-exposure sequence, so that the film transport is re-engaged for the next exposed photograph.

Interesting and creative photographic effects can be achieved with multiple exposures. But this facility is also useful for documentary phased photographs of sports activities and the technical analysis of movement.

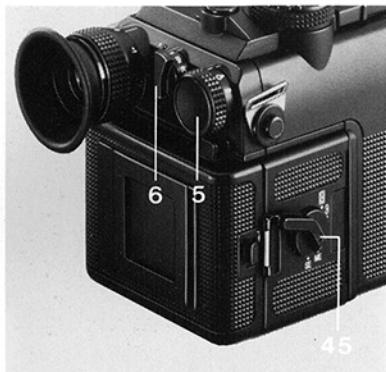

A well-developed picture concept and appropriate trials are indispensable. The following may serve as basic rules: a stationary background is a great advantage – the individual exposure times are accumulative – multiple exposures with flash capture the fastest movements.

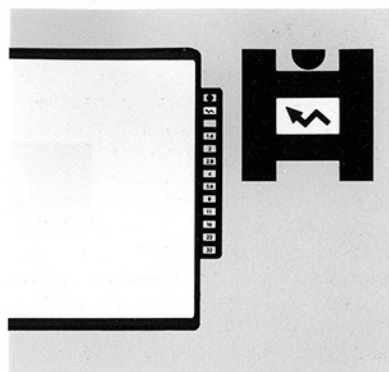

11 The use of flash units

With automatic flash:

This requires the Rolleiflex SCA 356 automatic flash adapter and an automatic flash unit offering the SCA 300 system made by Agfa, Braun, Cullmann, Metz, Osram or Regula.

The automatic flash is connected via the adapter to the hot shoe of the camera.

The control dial is set to »A«: any aperture within the working range of the flash can be used. The camera automatically sets the correct synchronous speed and meters the flash output at the film surface through the lens using a dedicated sensor. Further information will be found in the operating instructions for the flash unit concerned.

The green flash symbol lights up in the viewfinder to indicate that the flash is ready for use. At the same time, the X-synchronous speed of 1/100 s is set automatically. The green flash symbol also serves as a monitoring signal for the correct exposure. If it glows steadily or intermittently after the flash, the photograph was correctly exposed. If it goes out for a few seconds after the flash is fired, the photograph was underexposed — retake the picture with a larger aperture.

Test firings of the flash without any film in the camera to determine the flash output in advance lead to metering errors. Reason: the film surface has different reflection properties from the film pressure plate. It is best to carry out the test firings with a film loaded and the magazine switch in the »ME« position (then only one frame is lost).

Interchangeable elements

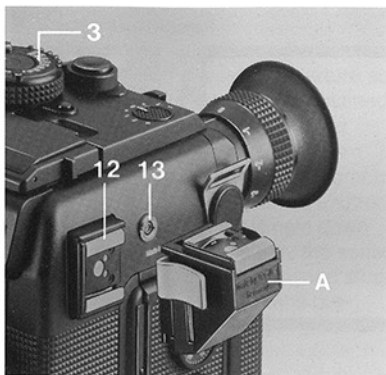

With standard flash units:

Set control dial 3 to »X« (1/100 s synchronous speed) or to any desired shutter speed between 1/100 s and 16 s (also synchronized). Flash units with a suitable foot can be fitted to hot shoe 12; flash units with a cable can be connected via socket 13. A flash bracket (A) can be supplied to allow compact flash units to be mounted upright on the hot shoe. This bracket uses the centre contact.

With the Rollei FM 1 TTL Flashmeter:

The FM 1 is a unique, sophisticated precision measuring instrument which permits accurate internal flash metering with studio flash equipment or standard flash units. For this, the unit is connected to the camera via the hot shoe. The built-in sensor in the camera body measures the light reflected from the film surface during the exposure and transmits this data to the electronics of the flash exposure meter. A highly sensitive display indicates correct exposure in EV numbers. If incorrect exposure is indicated, the aperture or the flash output can be adjusted.

Interchangeable lenses

The professional Rolleiflex 3003 system uses top-class lenses. The photographer has a choice of two different lens ranges:

The superlative Carl Zeiss lenses are logically the ideal companion to any professional camera system. The lenses manufactured by Schneider Kreuznach are also in this category. Germany's world-wide reputation in precision optics is largely based on the designs produced by these two companies. The Carl Zeiss range consists mainly of lenses with extremely large apertures, but also includes some special lenses. These lenses are distinguished by supreme image reproduction, high light intensity and contrast as well as exceptional colour brilliance and colour reproduction. This is achieved by the introduction of new optical components, the selection of the highest-quality glass and the HFT multicoating. Some of these lenses are manufactured under licence by Rollei Fototechnic GmbH.

The Rolleinar lens range has been created as an alternative to the above two ranges. A practical selection of sensibly spaced focal lengths offers the demanding photographer the whole spectrum of creative photographic composition. The rigorous quality control procedures employed by Rollei Fototechnic GmbH guarantee excellent value for money. All lenses are provided with an effective multicoating to reduce flare. Rollei produce the Rolleinar range in cooperation with leading lens manufacturers with the necessary experience and know-how in the design of top-quality lenses.

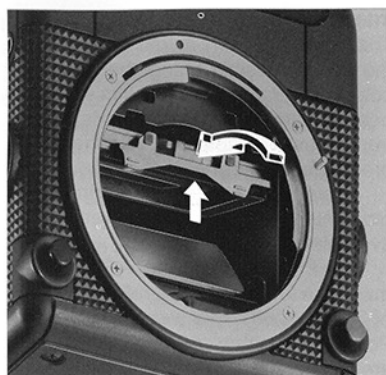
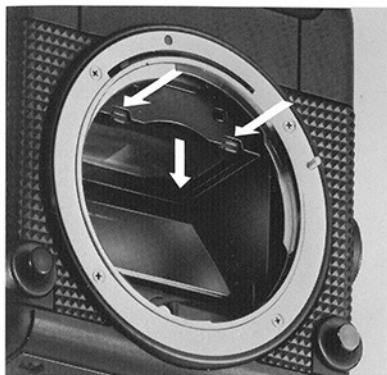

Finally, the camera also takes other types of lenses with an M 42 or M 39 thread or other thread. All such lenses can be used with the automatic exposure system.

The tables on pages 44 and 46 contain all the necessary data on the Carl Zeiss and Rolleinar lenses.

Interchangeable focusing screens

To replace: remove the lens, press both retaining tabs, pull the frame lightly down and remove. When doing this, avoid touching the mirror or the ground-glass screen.

Insert the replacement focusing screen (always supplied in its frame), with the matt side upwards and engage by pressing gently.

Always hold focusing screens by the frame. Do not clean with chemicals. Also do not rub, so as not to damage the delicate surface. Remove dust with a soft brush.

The following interchangeable screens are available:

Clear focusing screen with oblique split-image rangefinder and microprism grid, matt-surfaced; universal type for basic equipment, high focusing accuracy on vertical and horizontal lines.

Clear focusing screen with horizontal split-image rangefinder and microprism grid, matt-surfaced; for maximum focusing accuracy on vertical lines.

Clear focusing screen with microprism grid, matt-surfaced; for precise focusing in poor light conditions.

Clear focusing screen with cross-hairs, matt-surfaced; for ideal subject composition and for aligning the camera in architectural photography and repro-photography.

Clear focusing screen with clear spot and scale, matt-surfaced – the scale makes it possible to determine magnification in macrophotography and microphotography.

Clear focusing screen with reference grid for architectural photography, repro-photography and macrophotography.

Clear focusing screen for endoscopy – special screen with clear zone and cross-hairs.

The main accessories

Sensible accessories broaden the range of the Rolleiflex 3003 and greatly facilitate its operation so that certain special assignments are now possible for the first time with this type of camera. Naturally, the whole range of accessories available for the Rolleiflex SL 2000 F can be used with the Rolleiflex 3003.

The table on pages 42 and 43 shows the whole camera system together with the available accessories.

The universal handgrip system

The universal handgrip offers a very convenient and, above all, exceptionally safe way of holding the Rolleiflex 3003. This accessory allows you to use the camera in a wide variety of positions. For example, the universal handgrip can be fitted as a pistol grip under the camera. The shutter release is built in. For slow shutter speeds, the camera can be held as steady as a movie camera.

Using a few extra accessories, the grip can be fitted to the right or to the left of the camera. Here too, the built-in shutter release in the handgrip can be operated. Using additional accessories, the handgrip can be converted into a universal flash holder.

The bellows

The bellows unit is recommended for photography in the close-up and macro ranges. For automatic exposure control, it is necessary to switch the camera to working-aperture metering.

The microscope adapter

The microscope adapter connects the Rolleiflex 3003 to commercially available microscopes. Automatic exposure control is maintained by pressing the working-aperture button.

Extension tubes

Four extension tubes (50, 30, 15 and 7.8 mm) can be used singly or in any desired combination to permit close-up photography with various magnifications depending on the focal length of the lens. All the extension tubes transmit the aperture control function. For automatic exposure control, the camera must be switched to the working aperture.

The magnifier adapter

With the magnifier adapter, all commonly available magnifying lenses (Luminars, Photars) can be used on the Rolleiflex 3003. The M 42x1 adapter is also required.

The 35/66 adapter

This adapter permits the unrestricted use of SL 66 lenses on the Rolleiflex 3003. It can be fitted with all SL 66 focal lengths from 30 to 1000 mm.

Using this adapter, lenses designed for the professional 6x6 format can also be used very effectively in the 24x36 format. Since only the central area of the 6x6 lens is actually used in the miniature format, the overall quality and brilliance of the resulting picture are superb. The automatic exposure control of the camera will operate in the working-aperture mode.

Rollei SCA 365 flash adapter

The Rollei SCA 356 allows all reputable makes of flash unit offering the SCA 300 system to be connected into the electronics of the camera. The connection is made by plugging the flash unit with the SCA adapter into the hot shoe of the camera. This provides the transmission of the necessary data for automatic flash operation and so guarantees the best possible flash photographs.

Interchangeable magazines

The interchangeable magazines allow the fastest possible change between colour and black-and-white film stock or between films of different speeds, or from a newly completed film to the next pre-loaded magazine.

Besides the standard magazine, other interchangeable magazines are available.

The Polaroid magazine. A Polaroid magazine for use with the following types of film: 665, 667, 668 and 669. The Polaroid magazine and its power supply are attached to the camera just as easily as the standard magazine. The attachment of the Polaroid magazine does not interfere with viewing through the telescopic finder. Optical compensation for the somewhat longer film distance in the Polaroid magazine is achieved by means of a plane-parallel glass plate. The full focusing range of the lenses is maintained. Two 24 x 36 mm photographs can be taken in one Polaroid frame. A fixed metal drawslide masks the film so that the magazine can be changed without losing a picture.

The Type 250 long-film magazine. The long-film magazine allows up to 250 photographs to be taken without changing the film. It accepts type 250 film cassettes containing up to 10 m of bulk film stock. All the camera functions still operate without restriction when the long-film magazine is used. The magazine is equipped with an additional shutter release for more convenient handling. Long-film magazines are especially useful in conjunction with the motor drive in sports and documentary photography and generally for any application involving high film consumption.



Interchangeable power packs

Interchangeable power packs ensure a continuous power supply, since the power pack not in use can be recharged on the quick-action charger (available as an accessory).

Interchangeable viewfinders

As already described, the viewfinder hood can be replaced by other finders, e.g. by a prism sports finder, which is available as an accessory. This gives an upright right-reading image. The large eyepiece provides the photographer with an ideal image monitor – a considerable advantage in sports, reportage or underwater photography. In addition, the good view into the finder enables spectacle-wearers to keep a distance between eye and eyepiece.

The Rolleiflex 3003 System

- 730 030 Rolleiflex 3003 with standard lens Planar f 1.8/50 mm
- 969 065 Distagon f 3.5/15 mm
- 969 770 F-Distagon f 2.8/16 mm
- 969 250 Distagon f 4/18 mm
- 969 260 Distagon f 2.8/25 mm
- 969 470 Distagon f 2/28 mm
- 969 510 PC-Curtagon f 4/35 mm
- 969 320 Distagon f 2.8/35 mm
- 969 090 Distagon f 1.4/35 mm
- 969 230 Planar f 1.4/50 mm
- 969 480 Makro-Planar f 2.8/60 mm HFT with 30 mm extension tube
- 969 120 Planar f 1.4/85 mm
- 969 270 Sonnar f 2.8/135 mm
- 969 360 Tele-Tessar f 4/135 mm
- 969 370 Tele-Tessar f 4/200 mm
- 969 692 Doubling teleconverter
- 205 594 35/66 adapter
- 969 665 HFT-Rolleinar f 3.2–4.5/28–105 mm Macro
- 969 681 Zoom-Rolleinar MC f 3.5–4.3/35–105 mm, Macro
- 969 695 HFT-Rolleinar f 4/80–200 mm, Zoom
- 969 699 HFT-Rolleinar f 2.8/80–200 mm, Zoom
- 969 683 HFT-Rolleinar f 4–5.6/50–250 mm Macro
- 969 600 F-Rolleinar MC f 3.5/14 mm
- 969 610 Rolleinar MC f 4/21 mm
- 969 615 HFT-Rolleinar f 2.8/28 mm
- 969 620 Rolleinar MC f 2.8/35 mm
- 969 635 Rolleinar f 3.5/50 mm, Macro with 25 mm extension tube
- 969 640 Rolleinar MC f 2.8/85 mm
- 969 430 Rolleinar MC f 2.8/105 mm
- 969 645 HFT-Rolleinar Macro f 2.8/105 mm
- 969 650 Rolleinar MC f 2.8/135 mm
- 969 660 Rolleinar MC f 3.5/200 mm
- 969 700 Rolleinar MC f 5.6/400 mm
- 969 710 Reflex Rolleinar f 8/500 mm
- 969 720 Mirotar f 5.6/1000 mm
- 969 730 Mirotar f 4.5/500 mm
- 979 455 Tele-Tessar f 8/1000 mm
- 969 575 Luminar f 2.5/16 mm

969 576	Luminar f 3.5/25 mm	1)	Underwater housing (available from Ocean Optics, D-6100 Darmstadt)
969 577	Luminar f 4/40 mm		
969 578	Luminar f 4.5/63 mm		
971 000	Spare carrying strap	207 036	Flash bracket
971 010	Wide carrying strap	207 021	NC battery set
970 995	Leather bag for lenses with focal lengths up to 135 mm		Interchangeable focusing screens:
970 990	Leather bag for lenses up to 50 mm focal length, except Distagon f 1.4/35 mm and f 3.5/15 mm	205 690	Oblique split-image and microprism grid
972 300	– Lens cases for	205 691	Horizontal split-image and microprism grid
972 340	Carl Zeiss lenses	205 692	Microprism grid
205 635	Rear lens cover	205 693	Cross-hairs
205 480	Front lens cover E 49	205 694	Clear spot
205 640	Body cover	205 695	Endoscopy
205 500	Automatic extension tube set	205 696	Reference grid
979 630	Bellows unit	207 055	30° prism sports viewfinder
205 530	Slide copying attachment	207 042	Spare magazine drawslide
205 520	Macro tripod	207 017	36/72 interchangeable magazine
205 545	Reverse-mounting adapter E 49	207 013	250 long-film magazine
205 590	Reverse-mounting adapter E 55	207 015	Polaroid magazine
205 550	M 39x1 adapter	207 025	Interchangeable power pack
205 591	M 42x1 adapter	207 070	External battery connector
205 570	Adapter for magnifying lenses	207 060	External power supply connector
205 580	Microscope adapter	207 038	Pistol grip
205 310	Lens hood for Distagon f 2.8/25 mm	207 031	Flash extension piece I
205 320	Folding lens hood for Distagon f 2.8/35 mm and Planars f 1.4 and f 1.8/50 mm	207 033	Attachment for quick tripod coupling
205 330	Lens hood for Tele-Tessar f 4/135 mm	207 039	Extension piece for side mounting
205 335	Lens hood for HFT-Rolleinar 50–250 mm Macro	207 032	Flash extension piece II
205 700	Close-focus lens I	207 037	Extension piece for Metz 45 CT or 60 CT automatic flash
205 710	Close-focus lens II	207 066	FM 1 TTL Flashmeter
207 085	Standard charger for Rolleiflex 3003	207 065	Rollei SCA 356 automatic flash adapter
208 955	Car battery connection lead	2)	Flash guns or compact flash units (SCA 300 system) made by Agfa, Braun, Cullmann, Metz, Osram and Regula.
207 080	Quick-action charger	3)	Metz automatic flash guns.
207 061	FRC 1 foot-operated remote release		
207 048	Extension cable 10 m for Timer		
207 045	IR remote release kit		
207 041	Timer		
207 040	Remote release handpiece, 0.5 m		
207 043	Remote release handpiece, 10 m		
207 044	ME 2000 hand release		
969 800	NVS 100 night vision unit		



971000



971010

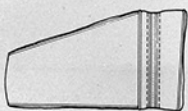

970995

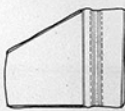

970990

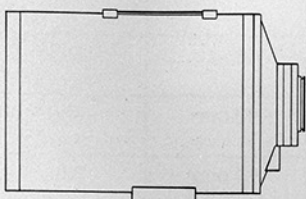

969720

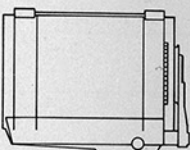

969730

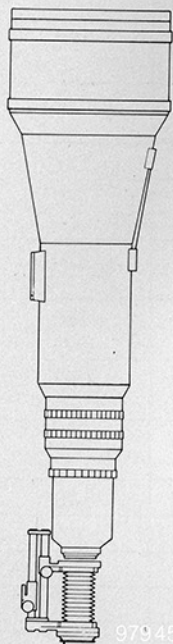

979455



972300



972340



972300



972340

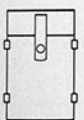

972300



972340



205640



205480



205500



205500

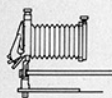

205530

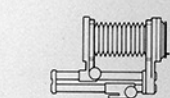

979630



205520



205550



205591



205570



969615



969578

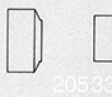

205335



205330



205320



205310



969577



969576



969575



205700



969660



205710



969700



969710



969650

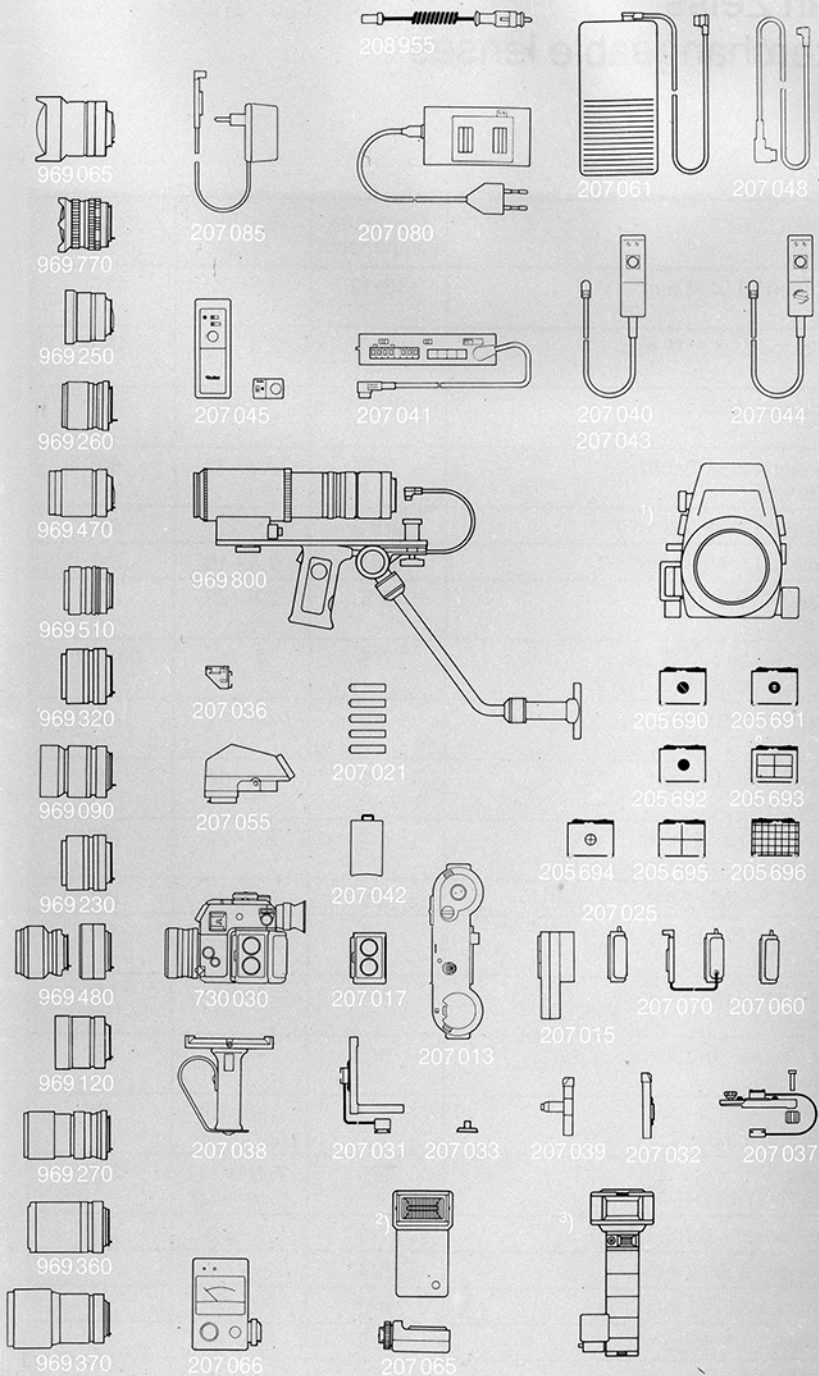

Carl Zeiss interchangeable lenses

Lens	Elements/ components	Aperture range	Angle of view
Distagon f 3.5/15 mm HFT	13/12	3.5–22	110°
F-Distagon f 2.8/16 mm HFT	8/7	2.8–16	180°
Distagon f 4/18 mm HFT	10/9*)	4–22	100°
Distagon f 2.8/25 mm Rollei HFT	8/7	2.8–22	80°
Distagon f 2/28 mm HFT	9/8*)	2–22	74°
Distagon f 1.4/35 mm HFT	9/8*)	1.4–16	61°
Distagon f 2.8/35 mm Rollei HFT	5/5	2.8–22	61°
PC Curtagon f 4/35 mm HFT, Schneider Kreuznach	7/6	4–22	64°/78°
Planar f 1.4/50 mm Rollei HFT	7/6	1.4–16	46°
Planar f 1.8/50 mm Rollei HFT	7/6	1.8–16	45°
Makro-Planar f 2.8/60 mm HFT (with 30 mm extension tube)	6/4	2.8–22	39°
Planar f 1.4/85 mm HFT	6/5	1.4–16	29°
Sonnar f 2.8/135 mm Rollei HFT	4/4	2.8–32	18°
Tele-Tessar f 4/135 mm Rollei HFT	4/4	4–32	18°
Tele-Tessar f 4/200 mm Rollei HFT	6/5	4–32	13°
Mirotar f 4.5/500 mm HFT	5/5	4.5/8/11 Grey filter	5°
Mirotar f 5.6/1000 mm HFT	5/5	5.6/8/11 Grey filter	2.5°
Tele-Tessar f 8/1000 mm	4/4	8–64	2.5°
Luminar f 2.5/16 mm	5/4	2.5–10	–
Luminar f 3.5/25 mm	4/3	3.5–14	–
Luminar f 4.5/40 mm	3/3	4.5–25	–
Luminar f 4.5/63 mm	3/3	4.5–36	–

*) floating elements **) with bellows unit

focuses down to	Filter size	max. \varnothing	max. length	Weight in g.
0.16 m	Revolver with 4 Filters	83 mm	94 mm	620
0.30 m	Revolver with 4 Filters	70 mm	68 mm	343
0.30 m	70 mm slip-on filter	70 mm	52 mm	350
0.25 m	E 49	62 mm	64 mm	310
0.24 m	E 55	63 mm	83 mm	530
0.30 m	E 67	70 mm	85 mm	471
0.40 m	E 49	62 mm	53 mm	210
0.30 m	E 49	63 mm	56 mm	290
0.45 m	E 49	62 mm	50 mm	230
0.45 m	E 49	62 mm	47 mm	185
0.27 m (1:1 with ET)	E 55	68 mm	70 mm	570
1.00 m	E 67	70 mm	72 mm	537
1.60 m	E 55	63 mm	98 mm	450
1.60 m	E 49	62 mm	96 mm	370
2.50 m	E 67	76 mm	134 mm	750
3.50 m	Filter-slide	193 mm	235 mm	4,500
12.00 m	Filter-slide	250 mm	420 mm	16,500
14.5 m	Size VI	218 mm	825 mm	8,800
β 8-14:1**)	-	28 mm	42 mm	100
β 4-8:1**)	-	28 mm	36 mm	91
β 2-4:1**)	-	28 mm	29 mm	67
β 1-3:1**)	-	28 mm	30 mm	74

ET = extension tube

Rolleinar interchangeable lenses

Lens	Elements/ components	Aperture range	Angle of view
F-Rolleinar-MC f 3.5/14 mm	10/7	3.5–16	180°
Rolleinar-MC f 4/21 mm	9/8	4–16	90°
HFT-Rolleinar f 2.8/28 mm	8/7	2.8–22	75°
Rolleinar-MC f 2.8/35 mm	7/5	2.8–16	63°
Rolleinar f 3.5/50 mm, Macro (with 25 mm extension tube)	5/4	3.5–22	47°
Rolleinar-MC f 2.8/85 mm inc. lens hood	4/4	2.8–16	28°
HFT-Rolleinar Macro f 2.8/105 mm inc. lens hood	6/6	2.8–32	23°
Rolleinar-MC f 2.8/105 mm inc. lens hood	4/4	2.8–16	23°
Rolleinar-MC f 2.8/135 mm inc. lens hood	4/4	2.8–22	18°
Rolleinar-MC f 3.5/200 mm inc. lens hood	4/4	3.5–22	13°
Rolleinar-MC f 5.6/400 mm inc. lens hood	8/5	5.6–22	6°
Reflex-Rolleinar-MC f 8/500 mm inc. lens hood	7/2	8	5°
HFT-Rolleinar f 3.2–4.5/28–105 mm, Macro	15/12	3.2–22	75°–23°
Zoom-Rolleinar-MC f 3.5–4.3/35–105 mm, Macro	16/13	3.5–22	63°–23°
HFT-Rolleinar f 4–5.6/50–250 mm, Macro	14/11	4–22	47°–10°
HFT-Rolleinar f 2.8/80–200 mm, Zoom	17/11	2.8–32	30°–12°
HFT-Rolleinar f 4/80–200 mm, Zoom	13/9	4–32	30°–12°
Doubling teleconverter	7/5	–	–

focuses down to	Filter size	max. \varnothing	max. length	Weight in g.
0.3 m	built-in	64 mm	56 mm	320
0.45 m	E 58	63 mm	56 mm	245
0.30 m	E 52	63 mm	40 mm	200
0.4 m	E 52	63 mm	60 mm	235
0.22 m to β 1:1 with ET	E 49	64.5 mm	52 mm	205
0.85 m	E 52	63 mm	64 mm	270
0.35 m to β 1:1	E 55	72 mm	103 mm	650
1.2 m	E 52	63 mm	69 mm	305
1.5 m	E 52	66 mm	97 mm	505
2.3 m	E 58	71 mm	147 mm	590
4 m	E 72	78 mm	216 mm	950
1.5 m	E 33.5	78 mm	95 mm	500
0.25 m to β 1:4	E 67	70 mm	112.5 mm	686
1.6 m to β 1:4	E 55	64 mm	96 mm	445
1.8 m to β 1:1,4	E 55	68 mm	179 mm	720
1.8 m	E 77	81 mm	174.5 mm	1080
1.0 m	E 58	68 mm	141 mm	655
—	—	62 mm	48 mm	221

ET = extension tube

Troubleshooting guide

Problem	Cause
The shutter is not released, indicator F glows steadily	SE or ME not switched on
	Memo switched on without setting to ME or SE
	End of film reached
	Power supply interrupted during (time) exposure
No shutter release, indicator F does not light up	Auto release still in action
	Power pack totally discharged
Shutter speeds light up, aperture indicators do not.	Memo in operation
All shutter speeds light up.	Warning signal indicating danger of faulty exposure
All aperture values light up	Lens or adapter without coded contact step
All speeds and all apertures light up	Old working-aperture lens or adapter
On B.C. setting, indicator F does not light up	Power pack discharged
Impossible to switch to  position.	Drawslide pulled out
Impossible to switch to SE or ME position	Drawslide not pulled out
Film insert jammed	Film not completely rewound
Photograph incorrectly exposed in spite of automatic exposure control	Film speed incorrectly set
	Exposure correction not switched off
Image lacks sharpness	Focusing error, eyepiece badly adjusted or incorrectly set
Flash photograph incorrectly exposed	Control dial not set to X, or exposure time too short (does not apply to automatic flash units)
Power pack capacity inadequate	Charged for too short a time or too unevenly

Remedy

Set magazine switch to SE or ME

Change film or magazine

Change or recharge power pack: then switch briefly to ME and again to SE. If necessary, rewind last frame.

Set main switch to 0, then toggle switch to 0

Change or recharge power pack

Switch off memo

Choose another aperture; if necessary use flash or a different film

Light metering and automatic control continue to function

Switch to working-aperture metering

Recharge power pack

Push drawslide into masking slot

Pull out drawslide and insert in storage compartment

Rewind film completely (!) into cartridge

Observe the film manufacturer's directions; use the memo holder

Set correction switch to 0, observe the warning signal in the viewfinder

Focus precisely, switch to open aperture, set eyepiece correctly

Turn to X, select shutter speed of 1/100s or slower

Charge power pack for 14 hours, and every 3 months when not in use

Care of the camera

The Rolleiflex 3003 requires the same care as any other valuable piece of equipment from which you expect long-term reliability. Please use the following proven methods of cleaning.

Remove dust with a soft camel-hair brush or air blower. If it is necessary to clean the outer surfaces of the lenses, breathe on them and then polish with lens-cleaning paper. For protection against static, breathe on them and allow the moisture to evaporate.

Take special care when cleaning the focusing screen: the roughened lower surface should only be treated with a soft brush or air blower. Protect this side carefully against dirt and fingermarks. Protect the camera from the long-term damaging effects of steam and damp.

The high humidity in tropical and sub-tropical regions can cause the corrosion of metal parts and fungal attacks on glass surfaces. Whenever possible, dry the camera frequently in the fresh air and sun. Keep the magazine and the film-guide surfaces clean (particles of gelatine rubbed off the film are breeding ground for fungus). When not in use for long periods, the camera should be stored in an airtight container with silica gel cartridges. Take particular care to protect the camera from any kind of dirt.

Technical data

Camera type

35 mm single-lens reflex camera with interchangeable film magazine, two built-in viewfinder systems and a built-in motor drive. Highly integrated analog/digital circuitry, central process control and monitoring of all metering and driving functions.

Picture format

24 x 36 mm

Film types

Type 135 35 mm cartridges for 12, 20, 24, 36 or 72 photographs, also sheet film and bulk film stock.

Film speed

Set on the magazine: 15–39 DIN (25–6400 ASA).

Exposure metering

Rollei TTL selective metering, using open or working aperture. Indication of measuring field in the viewfinder image. Exposure correction from -1 to +2 EV steps.

Sensor: two Silicon photodiodes.

Metering range

Exposure values 1–18 with 21 DIN/100 ASA film with aperture f1.4.

Shutter

Vertical-travel, metal-foil focal-plane shutter. Electronically controlled. Automatic selection of shutter speed with aperture priority, or manual exposure balance (follow-up system).

Shutter speeds: 1/2000 to 16s, set automatically or manually. Time exposure B. Flash synchronization speeds 1/100s to 16s.

X = 1/100 s.

Lenses

Rollei QBM bayonet locking with aperture simulator, Zeiss lenses with focal lengths from 15 to 1000 mm, Rollei lenses with focal lengths from 14 to 500 mm and also zoom lenses.

Shutter release

Three microswitches. One on each side of the camera as well as one at the top of the camera for use in reportage photography with the loop handgrip. Auto release, electronically controlled.

Film transport

Built-in high-performance motor, single exposures or continuous exposure at approx. 3 frames per second.

Multiple exposure

Using the switch on the magazine.

Reflex mirror

Hard-coated damped swinging mirror.

Viewfinder system

Two built-in viewfinders.

● Telescopic finder with rotating eyepiece for dioptre adjustment. Rubber eyecup.

● Hood with interchangeable viewfinder attachments. Standard version: folding viewfinder hood with flip-up magnifier. Seven interchangeable focusing screens; can be changed without tools.

Viewfinder information

Set aperture indicated by means of self-luminous numbers (LEDs). Shutter speeds indicated by means of self-luminous numbers (LEDs). Indication that shutter speed range is exceeded. Indication of measuring field for exposure metering. »Flash ready« and under-exposure indicated when automatic flash is in use. Memory function. Indication that exposure correction is in use.

Flash synchronization

1/100s. Accessory shoe with synchronizing centre contact and contacts for automatic flash units with Rollei SCA 356 adapter.

Automatic flash

TTL flash metering in the film plane using additional photodiodes with »flash ready« and exposure monitors in the viewfinder. Automatic setting of synchronizing speed in the »A« mode.

Power supply

Quick-change power pack with soldered-in NiCd batteries. Interchangeable with external power supply. Charger for normal charging, time 14 hours.

Interchangeable magazines

With drawslide, for quick change of partly exposed films. For 12-, 20-, 24-, 36- or 72-exposure 35 mm films and also sheet film. Exposed film can also be removed with the magazine attached. The magazine interlocks to prevent operating errors. Facility for single and multiple exposures. Film speed can be set between 15 and 39 DIN (25–6400 ASA). Frame counter only operates when the magazine is loaded. Memo holder for tear-off tab from the film box.

Polaroid magazine for Polaroid film pack (Two pictures 24 x 36). Long film magazine for 250 exposures.

Connections

Multi-pin socket for electrical remote release cable, timer, infrared remote control. 1/4" tripod bush.

Dimensions

89 x 111 x 159 mm with f 1.4/50 mm lens.

Weight

Approximately 1350g with f 1.4/50 mm lens.