

Bell & Howell GUARANTEE

This new Bell & Howell/Canon product is guaranteed to be free from imperfections in both material and workmanship for one year from date of original purchase. Should any part of this equipment be defective, it will be replaced or repaired free of charge, (except for transportation), provided the equipment has been operated according to the instructions accompanying it.

No liability is assumed for film which is damaged or is unsatisfactory for any reason and no liability is assumed for interruptions in operation of equipment. This guarantee is void:

- a) If equipment has not been registered with Bell & Howell (please use card supplied);
- b) If equipment has been damaged by accident or mishandling;
- c) If equipment has been serviced by other than Bell & Howell approved service station;

The foregoing is in lieu of all other warranties expressed or implied and Bell & Howell Company neither assumes nor authorizes any person to assume for it any other obligation or liability in connection with this product.

**Location of nearest approved service station will be furnished on request.*

Bell & Howell COMPANY, 7100 McCORMICK Rd., CHICAGO 45, ILLINOIS

PRINTED IN JAPAN

HOW TO USE YOUR



Bell & Howell
/ **Canon**

FX

35 mm

STILL CAMERA

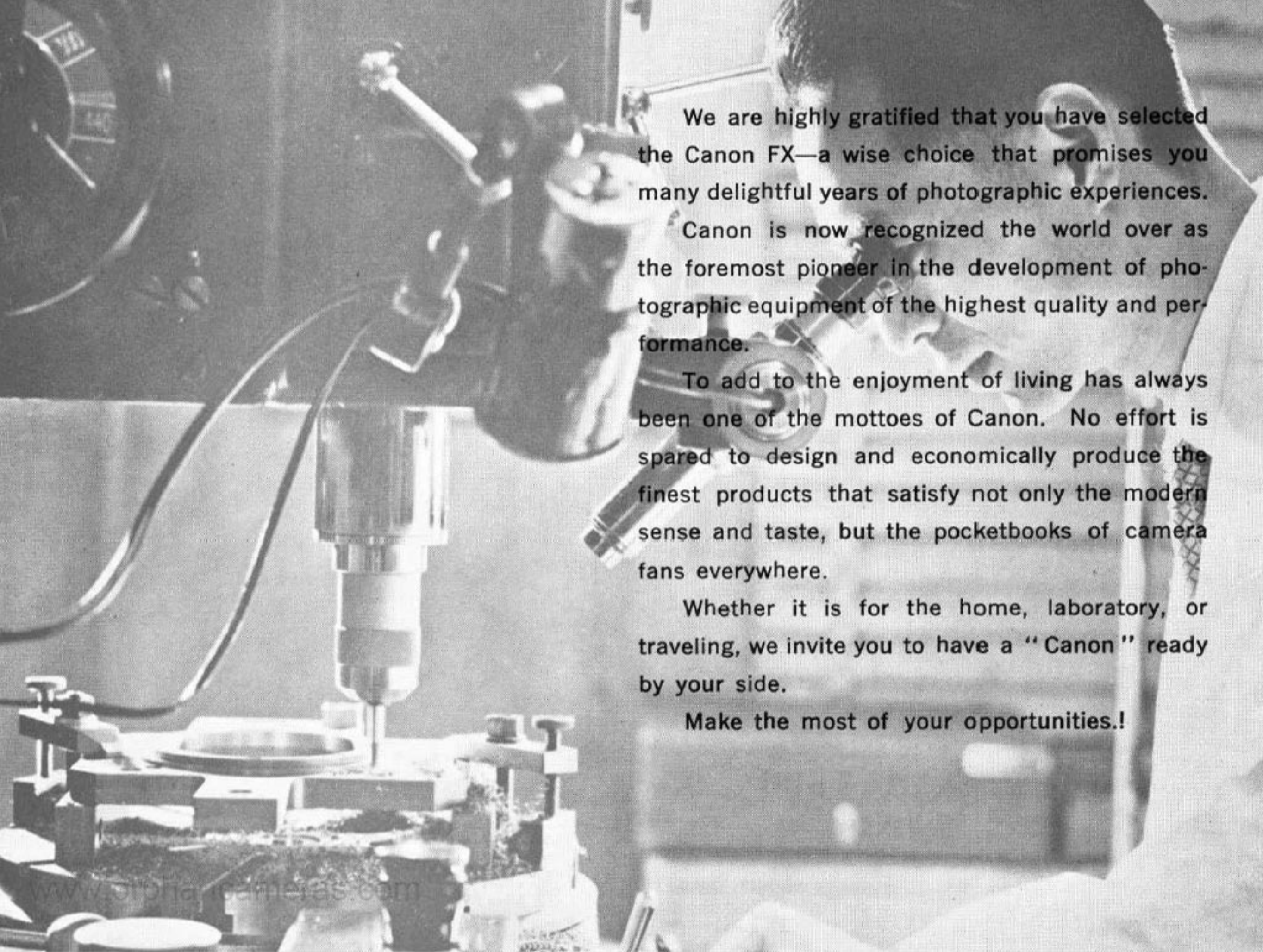

We are highly gratified that you have selected the Canon FX—a wise choice that promises you many delightful years of photographic experiences.

Canon is now recognized the world over as the foremost pioneer in the development of photographic equipment of the highest quality and performance.

To add to the enjoyment of living has always been one of the mottoes of Canon. No effort is spared to design and economically produce the finest products that satisfy not only the modern sense and taste, but the pocketbooks of camera fans everywhere.

Whether it is for the home, laboratory, or traveling, we invite you to have a "Canon" ready by your side.

Make the most of your opportunities.!

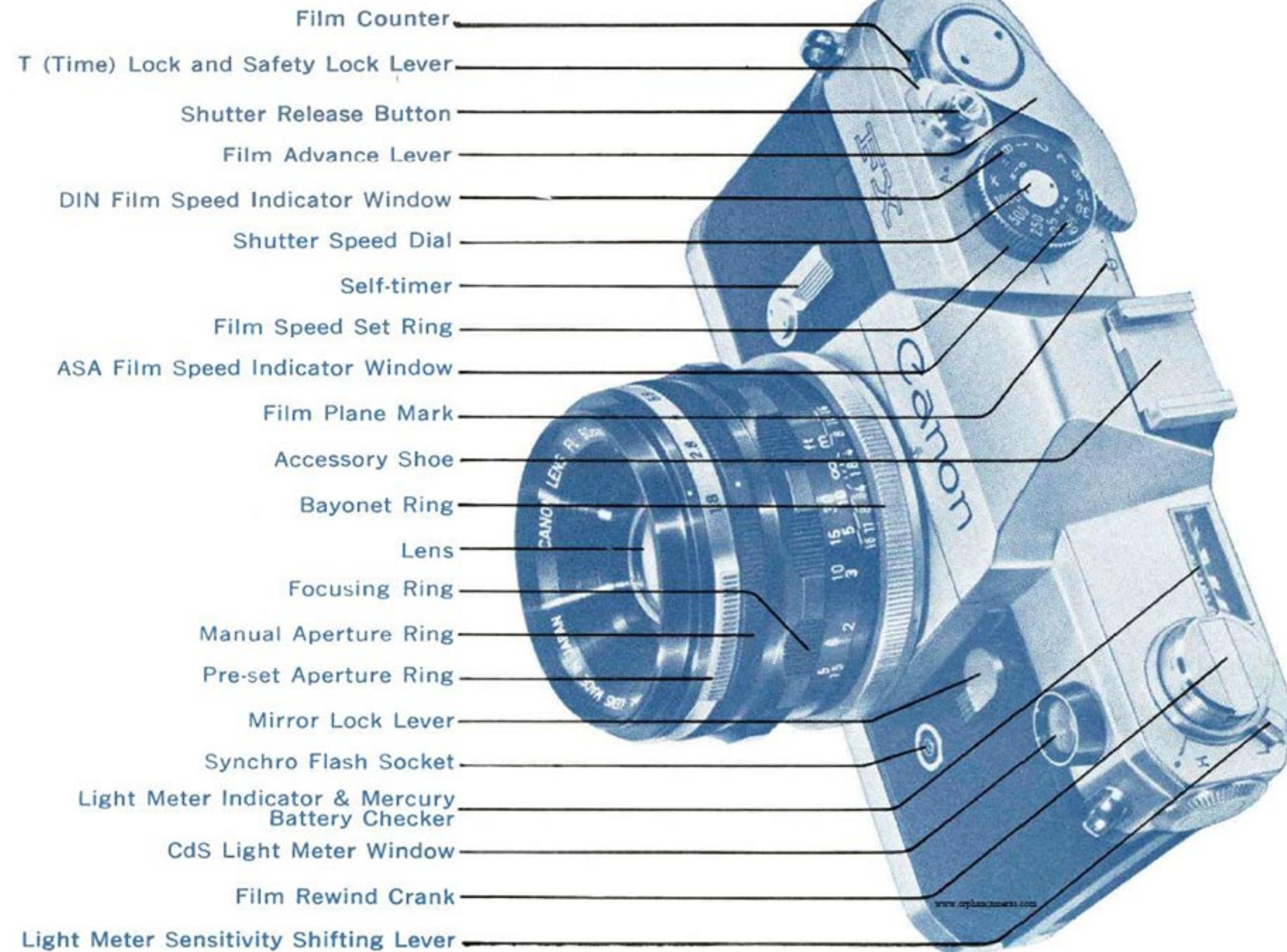

Canon FX Specifications

Type:	35 mm film single-lens reflex camera.	Battery Checker:	Built-in checker for mercury battery.
Viewfinder:	Eye-level viewfinder using Pentagonal Dach Prism. Waist-Level Viewer 2 can be attached.	Flash Synchronization:	Synchronizing possible for FP and X contacts and FP class, M class, F class and speedlight. Automatic time lag adjusting type, JIS B Model terminals.
Focusing Glass:	Highly efficient in resolving power, using Fresnel Lens, and built-in split-image rangefinder.	Built-in Self-timer:	Time adjusting type operated by shutter button.
Mirror:	Shock-proof quick return type. Mirror can be fixed "upward."	Winding Lever:	Single operation 160° winding lever, possible to wind with several short strokes.
Standard Lens:	FL 50 mm F 1.8, FL 58 mm F 1.2	Film Rewinding:	Rewinding done by button and crank.
Aperture:	Fully automatic pre-set aperture built-in. Pre-set release possible.	Film Loading:	Back cover opening and closing, using only cartridge.
Shutter:	1/1000~1 second dial and B(T) X single pivot dial focal plane shutter.	Interchangeable Lenses:	Automatic pre-set aperture of various types. FL lens system.
Built-in Meter:	Match needle type CdS meter coupled to shutter dial. With ASA 100 film, the high and low two-stage conversion system ranges between LV 1-10 and LV 9-18. Use ASA 10-800, and utilize one mercury battery MD Model 1.3V.	Film Counter:	Self-resetting type.
		Size, Weight:	141×90×43 mm/670 grams (body only).
		Other various safety devices, complete accessories, etc.	

Index

Mercury Battery Loading and Checking	5
When First Handling the Camera	6
Winding	7
Advance Lever, Shutter Safety Lock, Film Counter	
Shutter and Aperture	9
Shutter Dial, Pre-set Aperture, Pre-set Aperture Release	
How to use Built-in Light Meter	13
Preparations, Exposure Setting, Meter Sensitivity	
Holding the Camera	18
Focusing	20
Split-image, Eyesight Correction Lenses, Viewfinder	
Preliminary Steps in Photography	23
Film Loading.....	25
Film Rewinding	31
Self-timer	32
Flash Synchronization	33
Uses of Lenses	34
Changing Lens, Distance Scale, Infrared Index, Depth-of-Field	
Fixing Mirror in "up" Position	39
Double Exposure.....	40
Filters	41
Proper Care of Your Camera.....	43

Mercury Battery Loading

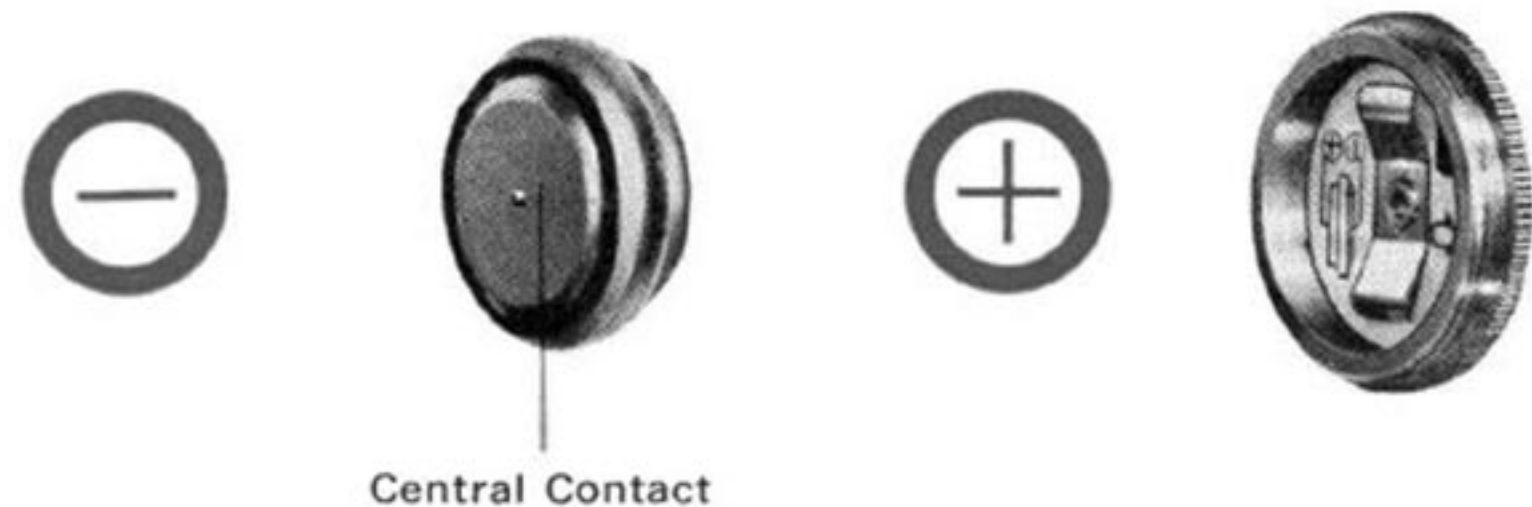
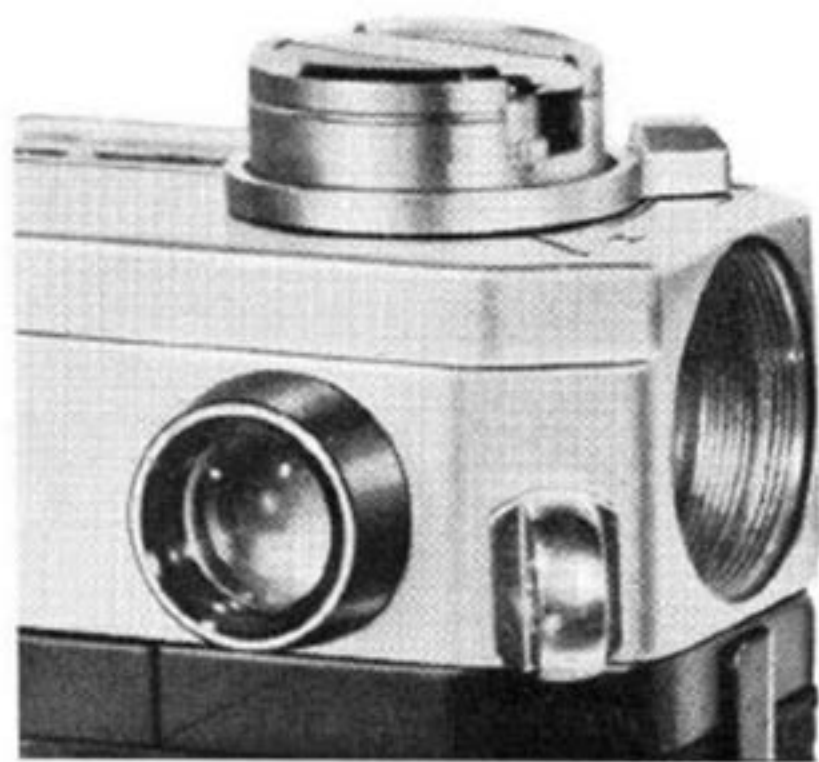

Load the mercury battery (contained in a separate envelope) into the battery compartment. Since the mercury battery powers the built-in CdS meter, the meter will not function unless the battery is in position.

1. Press the finger against battery cover and turn to the left to remove.
2. Face the central contact of the mercury battery inwards and insert, then screw the cover back in.

When inserting, do not confuse the ⊕ ⊖. Not only will the meter fail to function in case of re-
-tion, but the cover cannot be screwed

* For mercury battery, the National MD model or the Toshiba TH-MC is used—equivalent to the United States Mallory RM 625, Eveready E 625, General No. 625. Life of the battery in continuous use is about one year.

* Do not soil with perspiration or fingerprints. Before insertion, clean mercury battery thoroughly with a dry cloth. Perspiration or finger marks may cause corrosion and may prove particularly harmful to center of contact. If unclean battery is inserted, camera contact point may be damaged. Proper use and maintenance of all your equipment will insure its usefulness.

* When not in use for a long period, remove the mercury battery and keep in a dry place.

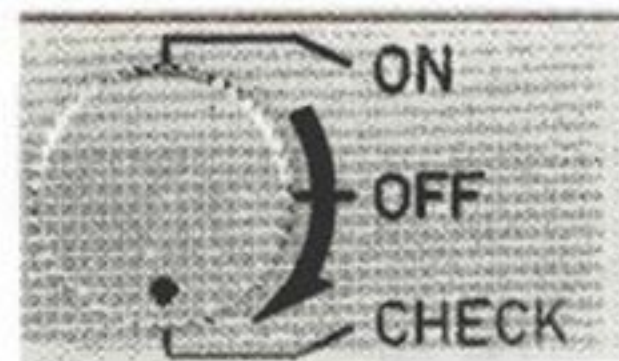

Battery Check

Always check the new battery. It is always necessary to make a check of the voltage when making battery changes.

1. Turn the revolving switch to match the CHECK indicator.
2. Check the efficiency of the battery by reading the meter needle. Voltage is sufficient if the needle swings to the right side within the blue colored section. If the needle stops in the white section to the left side, the battery must be replaced.

Before Using

FIRST, BECOME FAMILIAR with the workings of each section. Before loading the film, try out the winding lever and the use of the meter. Become thoroughly acquainted with the camera. By doing so, you will be able to operate the camera without confusion.

READ THE INSTRUCTIONS

The camera being a machine, there is a proper way to handle it. Avoid unnecessary failures by reading the instructions first. As the very first step in handling the camera, explanations will begin with the film winding.

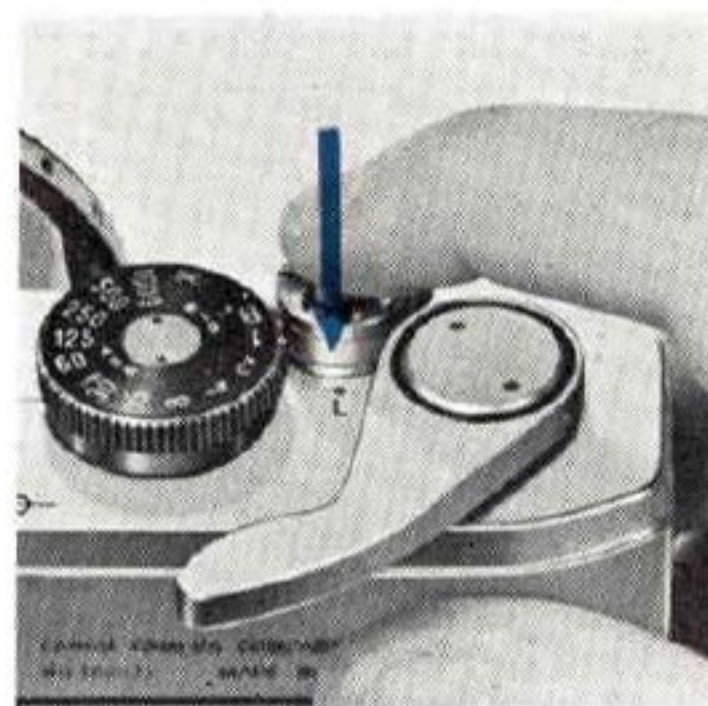
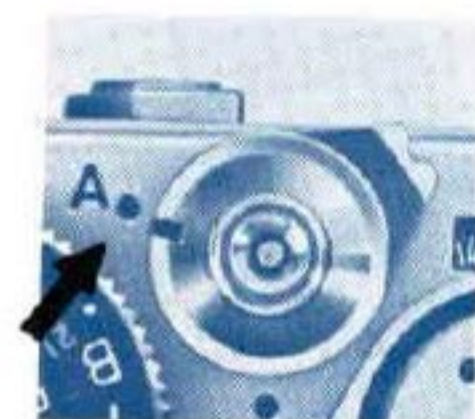

The turning of film advance lever operates the inner mechanism, such as the shutter and film winding, mirror and aperture charging, etc., to be carried out in one motion.

Single-stroke film advance lever advances the film, cocks the shutter, counts exposures all in one operation.

When the shutter button is pressed, the mirror swings up, simultaneously the lens closes down to the pre-selected position, and the shutter operates.

Immediately after the shutter operation, the advance lever is again in ready position.

- * Winding is not possible unless the indicator of the shutter button safety lock is in "A" position.
- * The winding may be done by moving the lever with several short strokes.
- * Unless the winding is complete, even though the shutter button is pressed, the shutter will not actuate. In such a case, check the winding once more.
- * After loading the film, since there is the possibility of the very first winding not catching, make another wind.

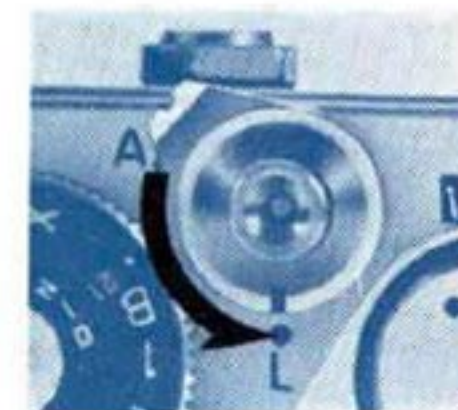
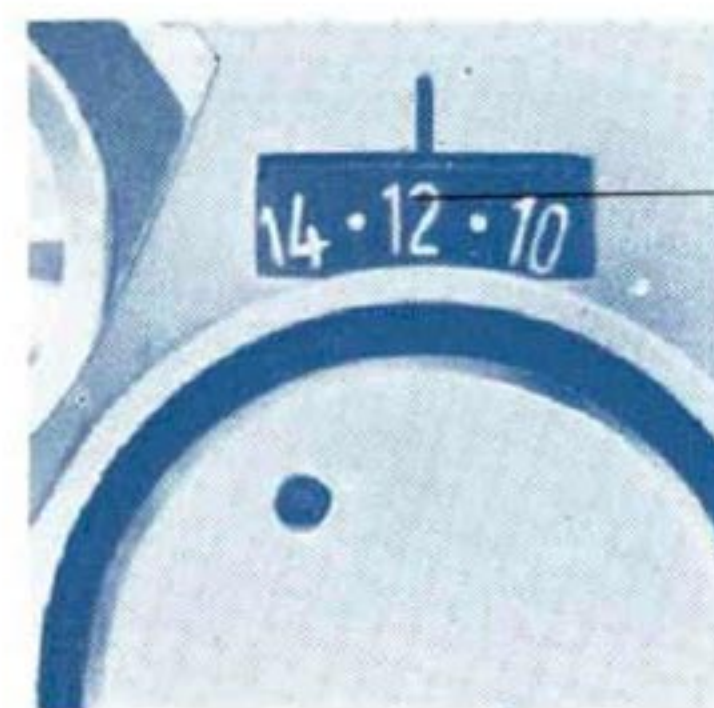

Indication of the Number of Pictures Taken

Each winding of film will advance the number of the film counter, indicating the number of pictures taken. When the back cover is opened, the indicator automatically returns to the starting position "S."

Safety Device for Shutter

When the safety lock around the shutter button is turned to the "L" position, the shutter is locked and will not move. This device may be used when camera is carried around in a wound condition.

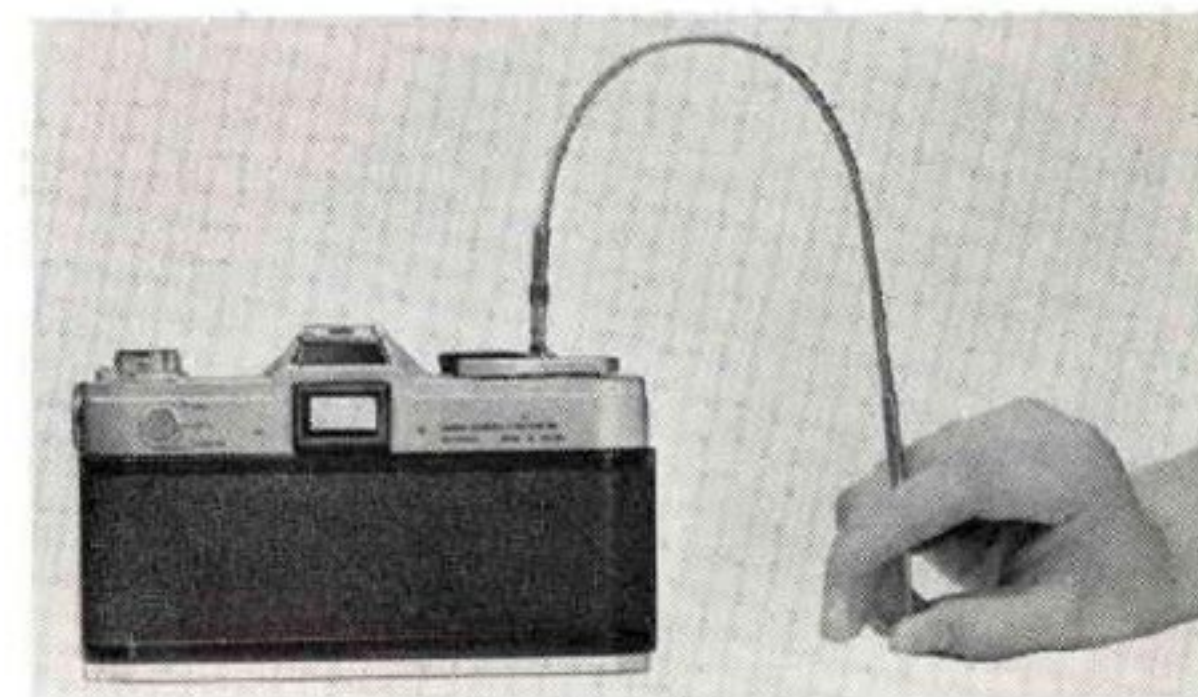

Attaching the Cable Release

A cable release can be attached to the shutter button. Although the safety lock lever is at "L" position, the shutter will operate by pressing the release. Please be careful.

Shutter and Aperture Adjustment

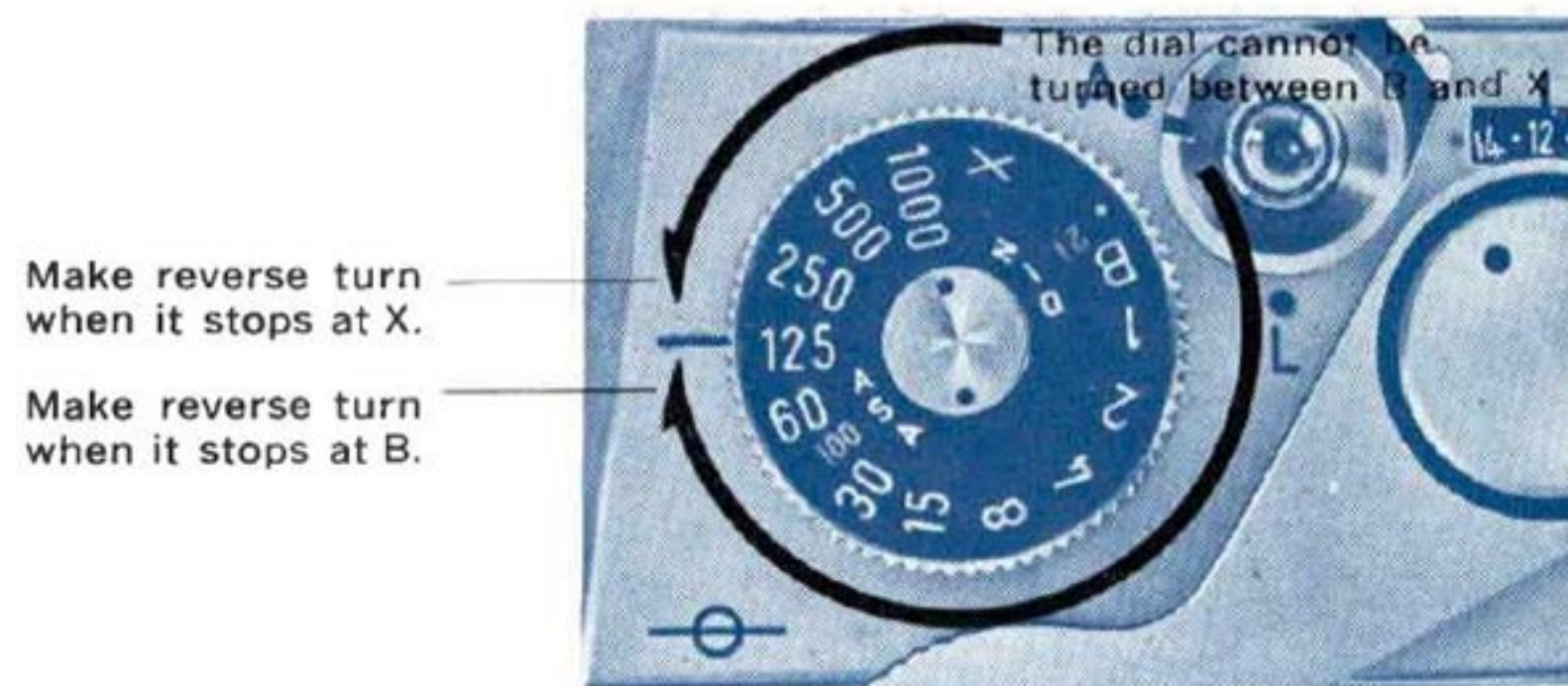

Exposure is the opening of the shutter to throw light on the film. The shutter and aperture adjust the exposure, with the shutter adjusting the exposure time and the aperture adjusting the amount of light. Since the Canon FX uses the coupled meter, it is simple to obtain the proper exposure. (Page 13)

Shutter Dial

By revolving the dial, it is possible to adjust the speed by turning it to the necessary index number. The index on the dial shows the denominators 1/1000 sec., 1/15 sec., etc.

- * The index between X and B does not revolve.
- * B means bulb exposure. The shutter remaining open during the pressing of the shutter button, it is employed when making exposures of more than one second.
- * When it is necessary to make exposure over an extended time T (time), set it at B. Keep the shutter button pressed, and turn the T lock lever to indicator L. In this case, although the finger is removed, the exposure continues. When the lever is returned to A, the shutter closes.

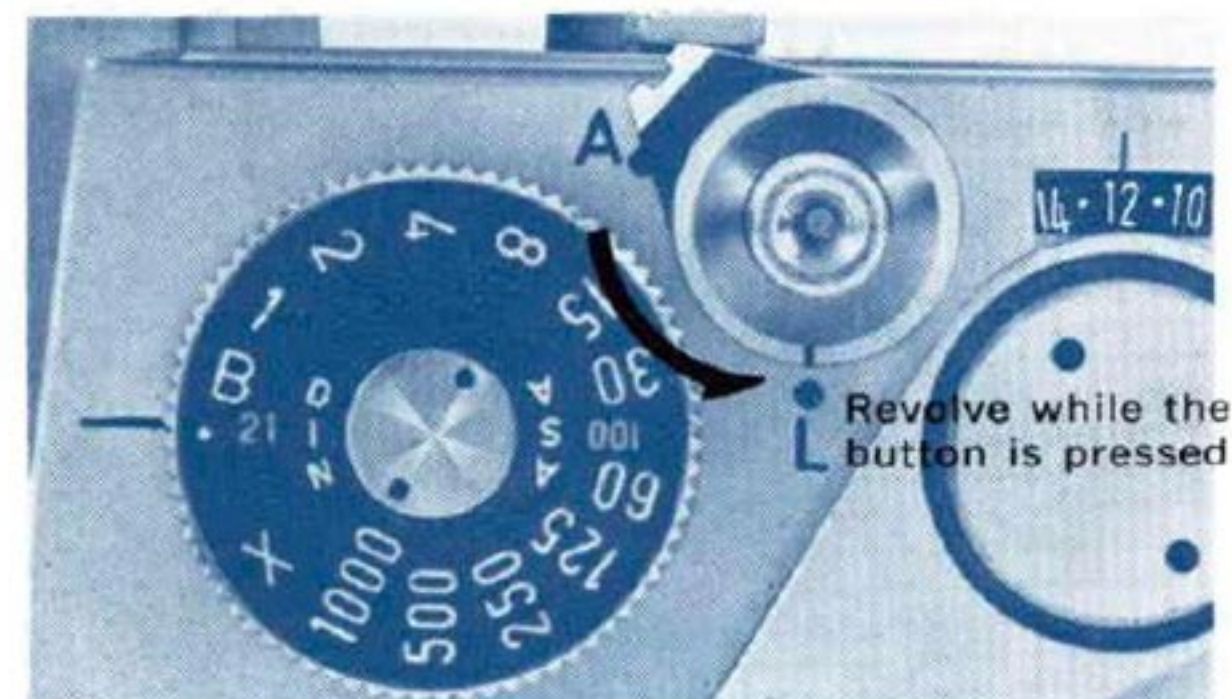

- * T exposure is possible also by using the lock-attached cable release.
- * The X index is used for synchronizing a speedlight. Although the shutter speed is 1/60 sec., actually it is equivalent to a very short exposure during the flash time of the Speedlight.
- * Set the index at the position where the click stop catches. Especially in case of B index, adjust it to the white dot just below the B index.

Lens Aperture

Turn the pre-set aperture ring to adjust the desired F stop to the index. By doing so, the adjust-



ment of the quantity of light and depth-of-field (page 37) are made.

Pre-set Aperture

This is the mechanism for adjusting the size of the aperture which is automatically closed down. If this ring is turned and set the desired F stop to the index, the lens is closed down to the pre-selected aperture stop for the instant that the shutter is released.

Ordinarily, the diaphragm is full opening. In other words, the pre-set aperture ring is an adjusting ring which automatically pre-fixes the size of the lens aperture.

**Pre-Set Aperture Release
(Manual Aperture)**

Used in ordinary photography to check the depth-of-field or when fixing aperture with bellows attached. When turning the manual aperture ring, it is possible to fix the aperture up to the pre-set lens aperture, thus enabling the checking of the focus resulting from this condition.

Before taking a picture, always open the manual aperture.

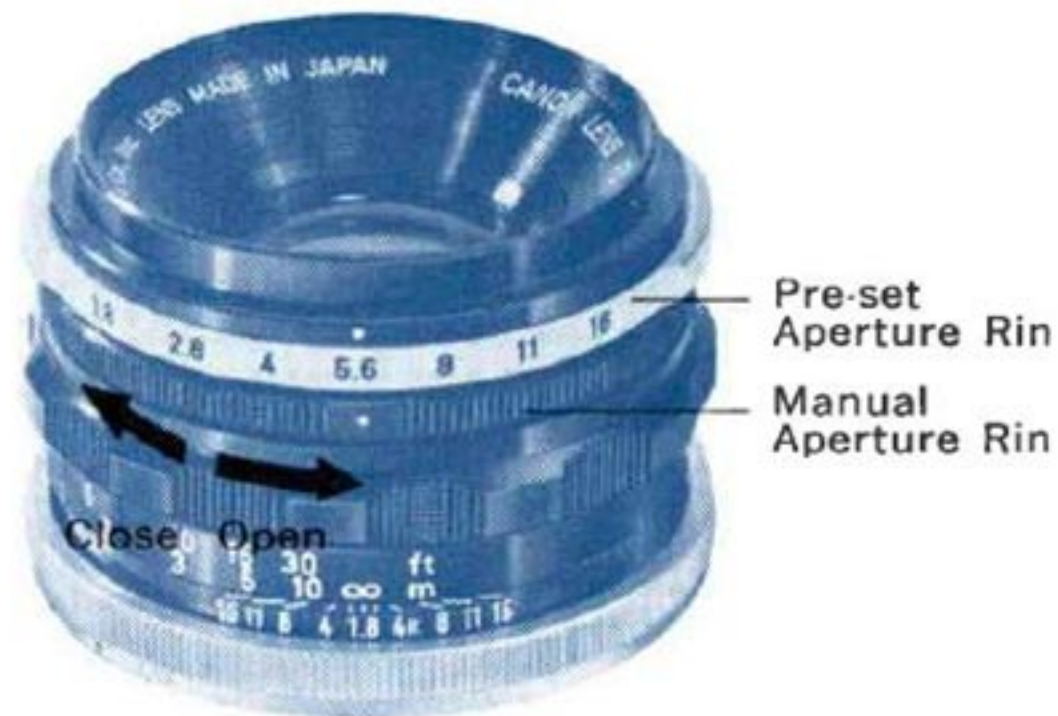

**Do Not Turn the Manual Aperture Ring
While the Pre-set Aperture Ring is full opening**

* In the case of the aperture, as the numerical value gets larger the amount of light reaching the film becomes correspondingly less. For each aperture, the light is reduced one-half. Accordingly, when the aperture is increased by one index point, the exposure is doubled, and when it is increased by two index points the exposure is quadrupled. Half-way points on the aperture index may also be used. Depending on the lens, there are instances when there is no relation to the lightness being halved between the

maximum diameter of the aperture and the next aperture reading. Canon FX, by using the built-in meter, can easily determine the lens aperture which sets the shutter speed.

* The ratio between aperture and the amount of exposure, using F2 as the basis, is as follows:

Lens Aperture	1.2	1.4	1.8	2	2.8	(3.5)	4	5.6	8	11	16	22
Exposure Ratio	1/3	1/2	1/1.25	1	2	(3)	4	8	16	32	64	128

Relation Between the Mirror, Diaphragm and Shutter

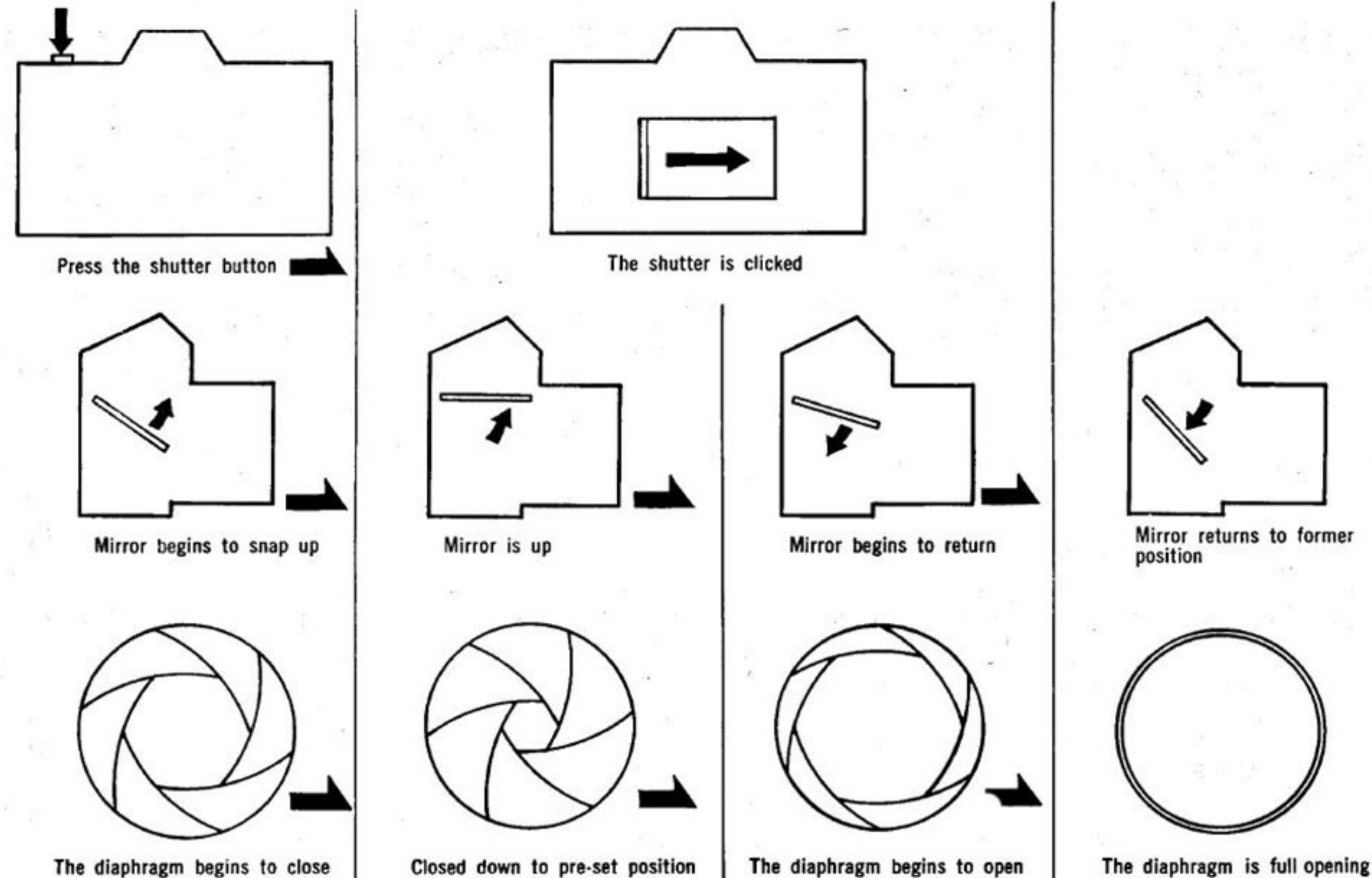

Press the shutter button. (1) The lens is closed. (2) The mirror snaps up. (3) The shutter is clicked. (4) The aperture opens, the mirror returns. Simultaneously.

How to Use Built-in Light Meter

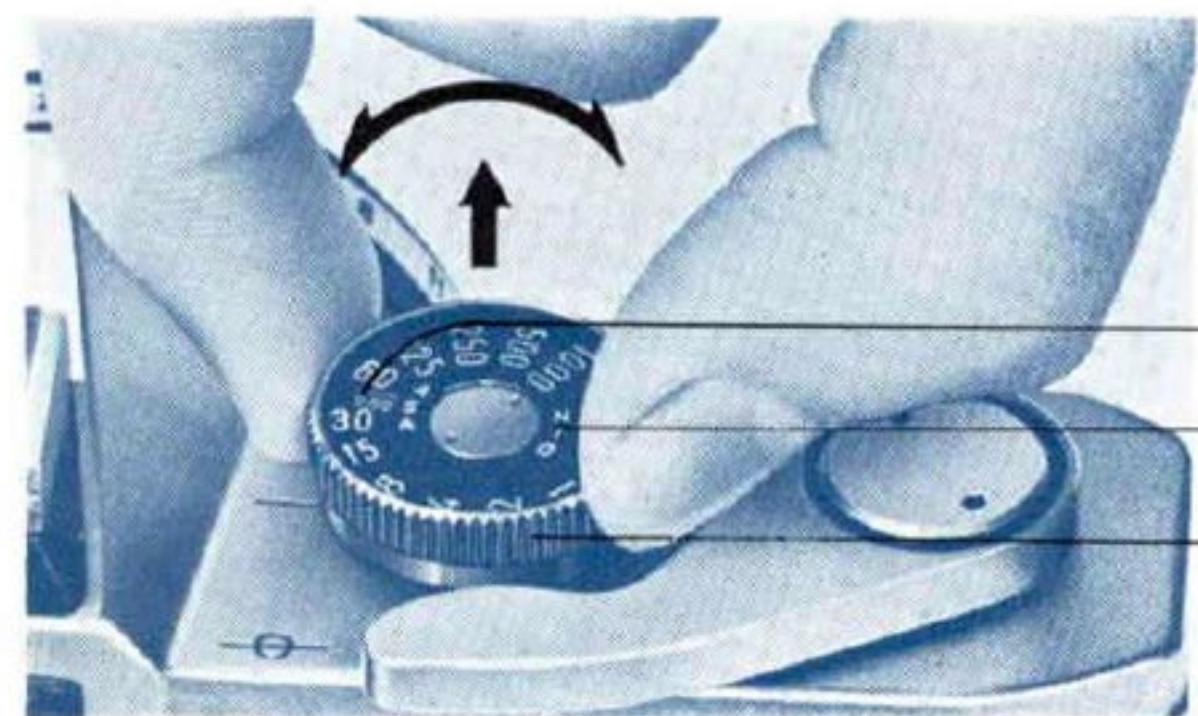

ASA Film Speed Window
DIN Film Speed Window
Lift up the outer sensitivity set-ring and turn

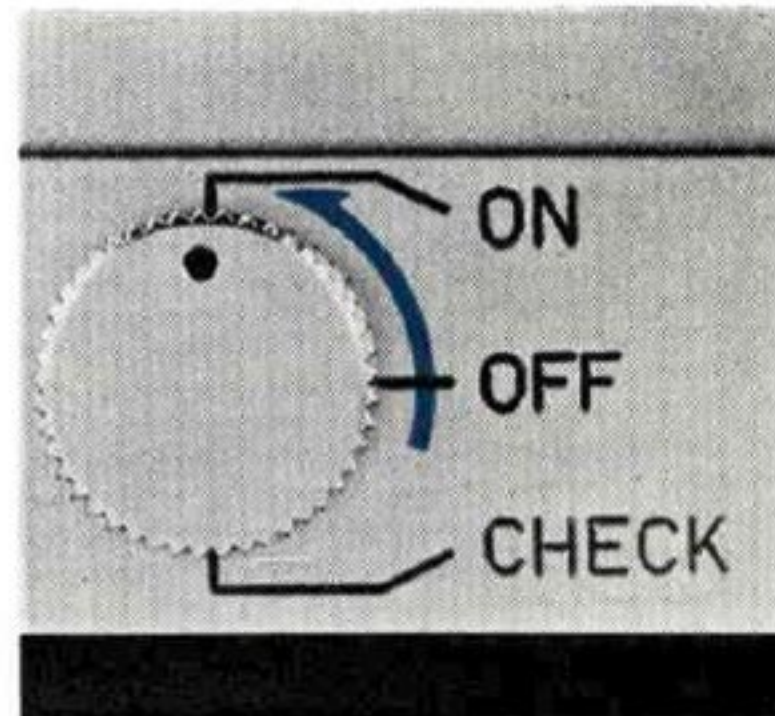

The Canon FX Meter, which is the match-needle type, is coupled to the shutter dial. The exact exposure may be easily determined according to the brightness of the subject to be photographed. Although there are two ways of determining the exposure—either by first selecting the shutter speed or by first selecting the lens aperture—in any case, it is most important that the essentials are mastered.

Preparations

1. Show the film speed of the film used in the small window. To do this, hold up and turn the sensitivity set-ring around the shutter dial. If the film is ASA 100, for example, make cor-

rect setting by showing 100 in the ASA window.

* When ASA 10 appears in the small window, this is as far as it will turn to the left. The right turn extremity reads 800.

* The following film speeds may be used:

	(12)	(20)	(32)	(40)	(64)	(80)	(125)	(160)	(250)	(320)
ASA	10	16	25	50	100	200	400			
DIN	11	13	15	18	21	24	27			
	(12)	(14)	(16)	(17)	(19)	(20)	(22)	(23)	(25)	(26)
	(500)	(640)								
						800				
						30				
	(28)	(29)								

Figures in brackets represent intermediate film speeds.

* Explanations of the film speed are shown either on the film box cover or in the explanatory sheet.

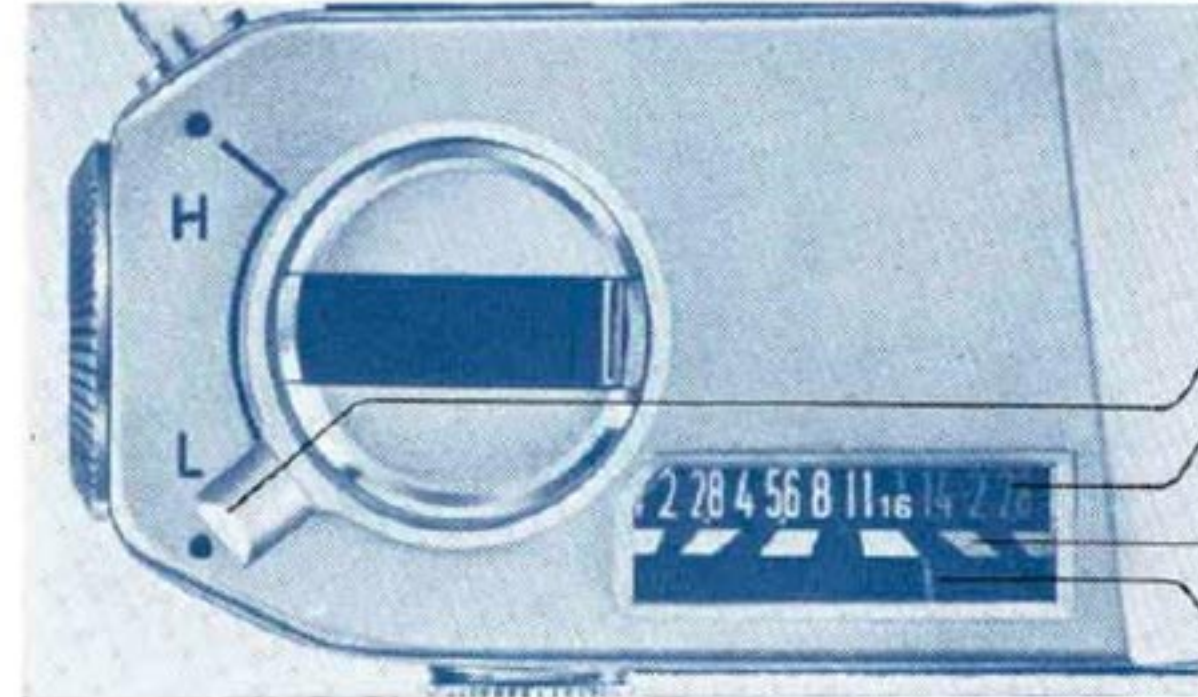

Orange dot for high sensitivity range (Indoors)
Black dot for low sensitivity range (Outdoors)
Light Meter Sensitivity Shifting Lever
Light Meter Aperture Scale
Guide Line
Needle

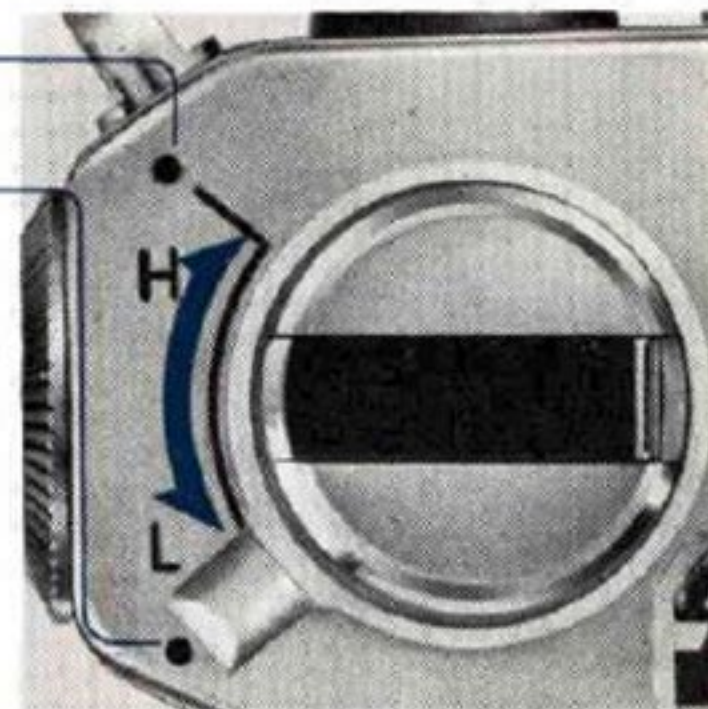

2. Turn the switch to ON.

3. Determine the meter sensitivity.

In ordinary brightness outdoors, turn the sensitivity shifting lever to match the black dot "L" for low sensitivity use. Make adjustments to the orange dot for indoors or outdoors just before sunset.

* The sensitivity of the meter is based on a two-stage high and low system. For high sensitivity (dark subject) using ASA 100 film, the setting should be LV 1—10 (F 1.4 1 sec.—F 16 1/4 sec.); for low sensitivity (bright subject) the setting should be LV 9—18 (F 1.4 1/250 sec.—F 16 1/1000 sec.)

4. For low sensitivity, use the white figure of the aperture reading; when using high sensitivity, follow the orange figures.

Exposure Setting-1

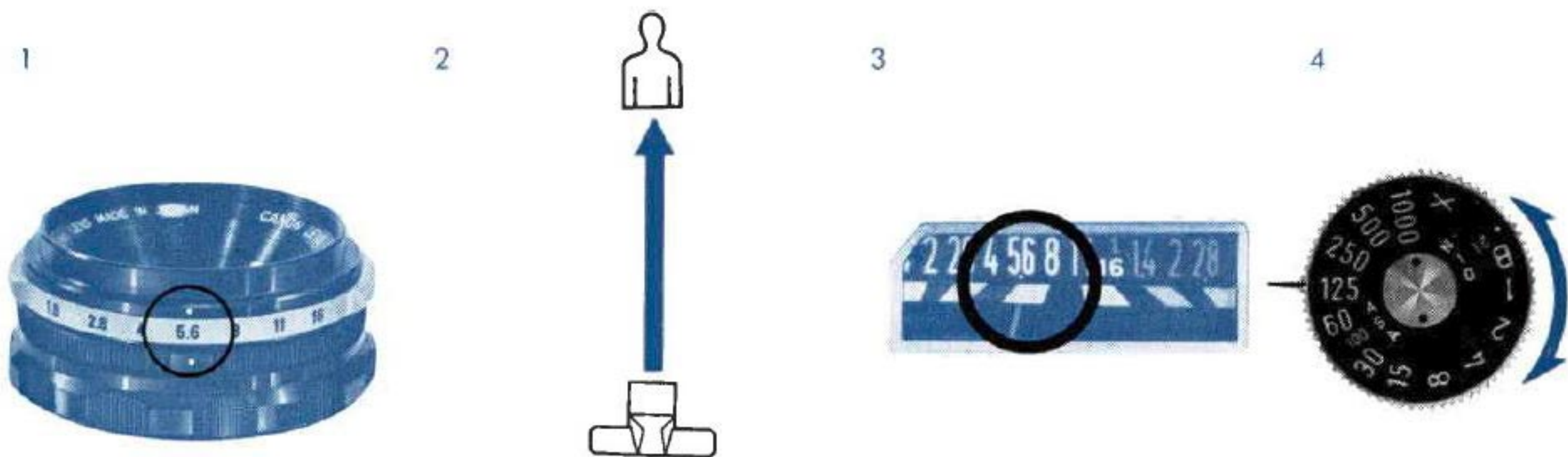

1. Set the lens aperture.
2. Facing the camera towards the subject, the position of the meter needle is determined.
3. Turn the shutter dial and adjust the same figure as the lens aperture to the guide line where the needle stops.
4. Set the shutter dial to the click stop position. The exact exposure has now been set.

- * When measuring the brightness, be careful not to cover the light meter window with your hand. Since the light meter acceptance angle is 40° , it is possible to measure the principal subject without being hindered by excessive light. (Light other than that reflected from the subject).
- * No attention is needed to the B or X index of the shutter dial.
- * Reading of the aperture stop is made according to the guide line.
- * During the use of the meter, there are instances of the movement of the needle becoming slack, owing to changes in the degree of light, but this is due to the peculiar characteristics of the CdS.

Exposure Setting-2

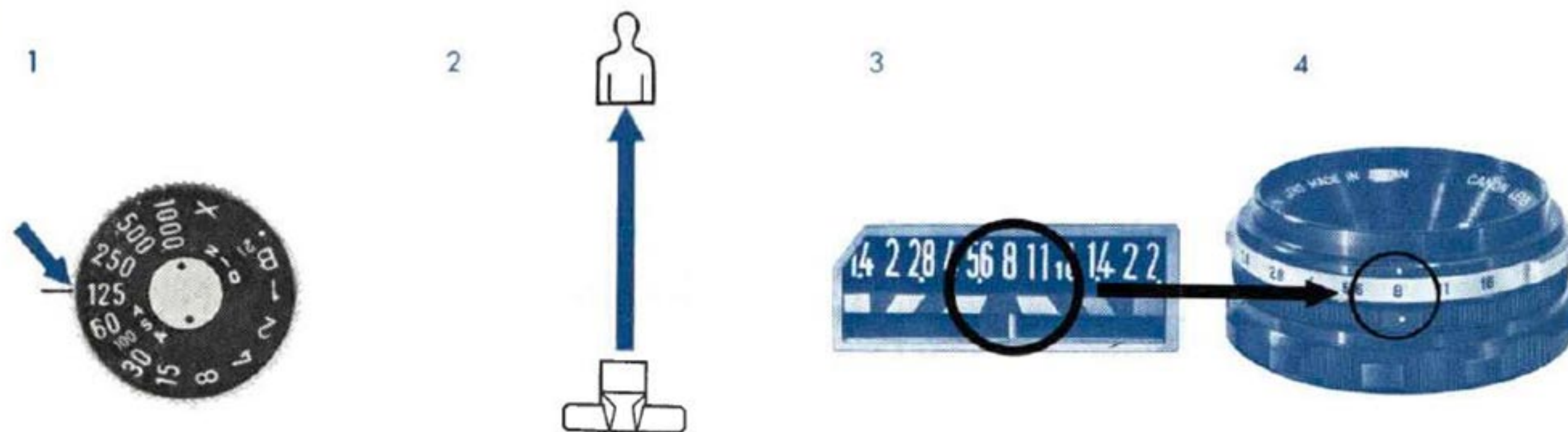

1. Set the desired shutter speed.
2. Turn the camera towards the subject to be photographed.

3. Read the aperture stop to which the needle is pointing, and set the lens aperture.

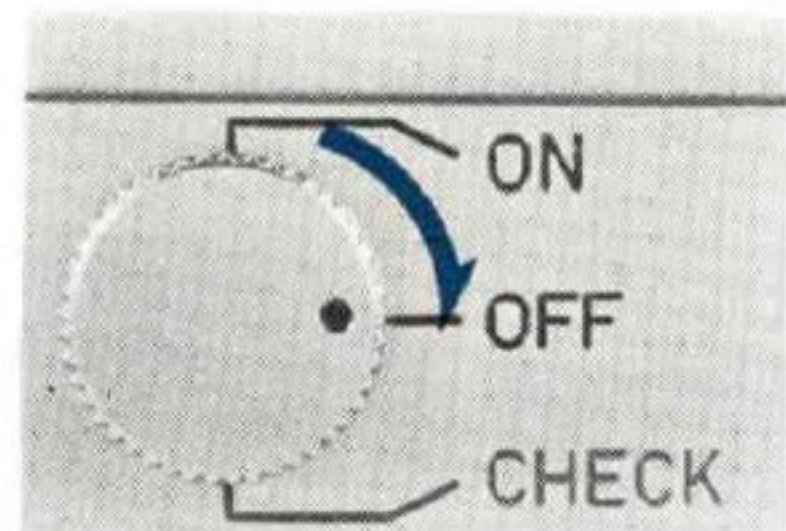

- * Intermediate positions on the shutter dial scale are unusable, but since any aperture may be utilized, the shutter speed should first be determined when strictly considering the exposure. It is most practical to adjust the aperture according to this.
- * When the camera is not to be used for a long time, always turn the switch to "OFF". Also, make a battery check before using again.

When taking portraits against such bright backgrounds as the sky, cloud or sea, there is the possibility of the subject being under-exposed.

This is due to the fact that the meter has been over-sensitized to the brightness of the background, thus failing to produce the correct reading for the subject. In such a case, make the measurement near the subject. Be especially careful when the picture is being taken against the light.

When taking pictures against the light, it is important to place the emphasis on the background, or the subject. Determine the exposure while paying due consideration beforehand to the results desired.

Be careful also of the tendency to tilt the camera upwards when reading the meter needle.

Holding the Camera



Holding the camera firmly is very important if you want to take a clearly focused picture. Hold the camera in either a vertical or horizontal position, as shown in the photographs. Look through the finder, and adjust the focus while determining the composition. Then, gently press the shutter button. At this time, it is important to consider the following points.





1. Hold the camera with both hands as firmly as possible.
 2. Stabilize the camera by pressing it against the cheek or forehead.
 3. When the camera is in a horizontal position, both elbows should be firmly against the body, and at least one elbow should be resting against the body when in a vertical position.
- * Rough pressing of the shutter button, causing camera movement, is one cause of picture distortion.
- * It is advisable to use the tripod and cable release. Particularly recommended when using a slow shutter speed below 1/30 sec.



Focusing



Remove the lens cap. While looking through the viewfinder, rotate focusing ring.

Viewfinder range

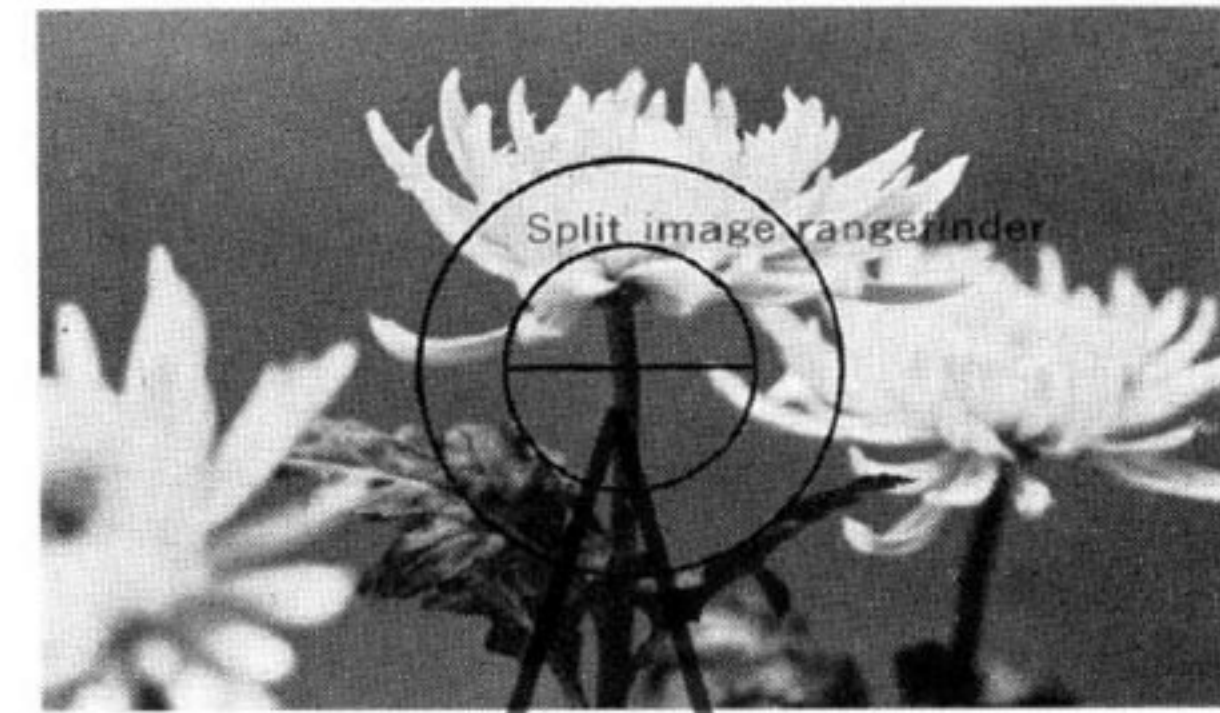

It is out of focus when the image within the circle in the center of the viewfinder does not coincide. It is in focus when the top and bottom images coincide.

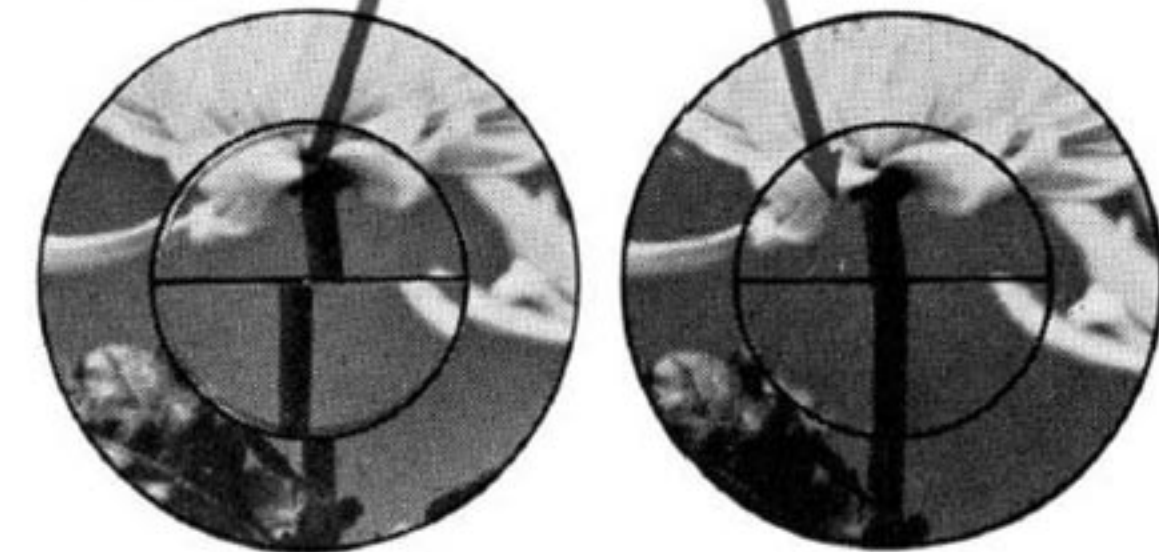

Out of focus

In focus

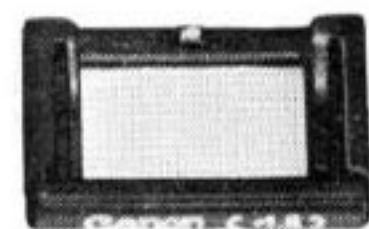

+1.5



0

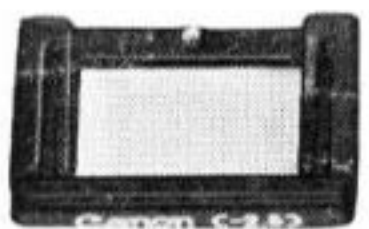

-2.5

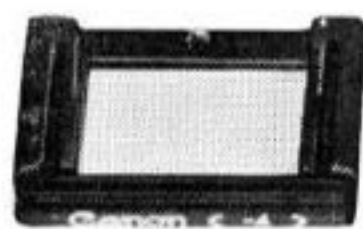

-4(diopter)

- * The viewfinder is equipped with eyesight adjustment lenses. When attached, they let you take pictures without glasses for those who are far-sighted or near-sighted.
- * The central circular section is not a focus glass. Use it only as a rangefinder.
- * When focusing on the surface of the focus glass, do this outside the central circular section.



Composition and Viewfinder

The picture to be recorded on the film can be seen on the surface of the focus glass. There is no parallax error. It is possible to determine the composition exactly according to the viewfinder.

- * The Waist-Level Viewer Model 2 can be attached to the eyepiece. In this case, the image is reversed left and right. It can be used for copying, enlarging and microphotography.

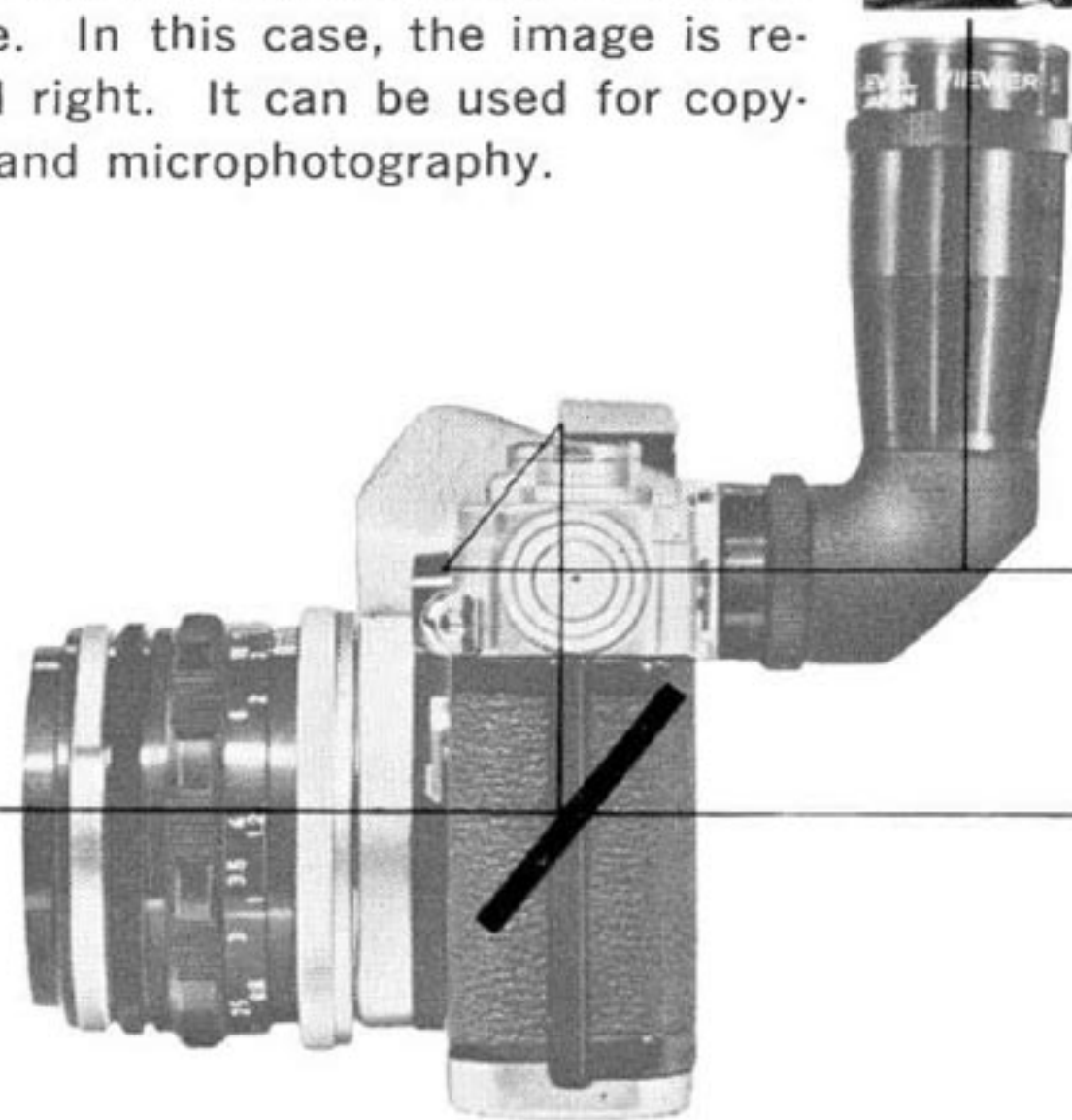

Preliminary Steps in Photography

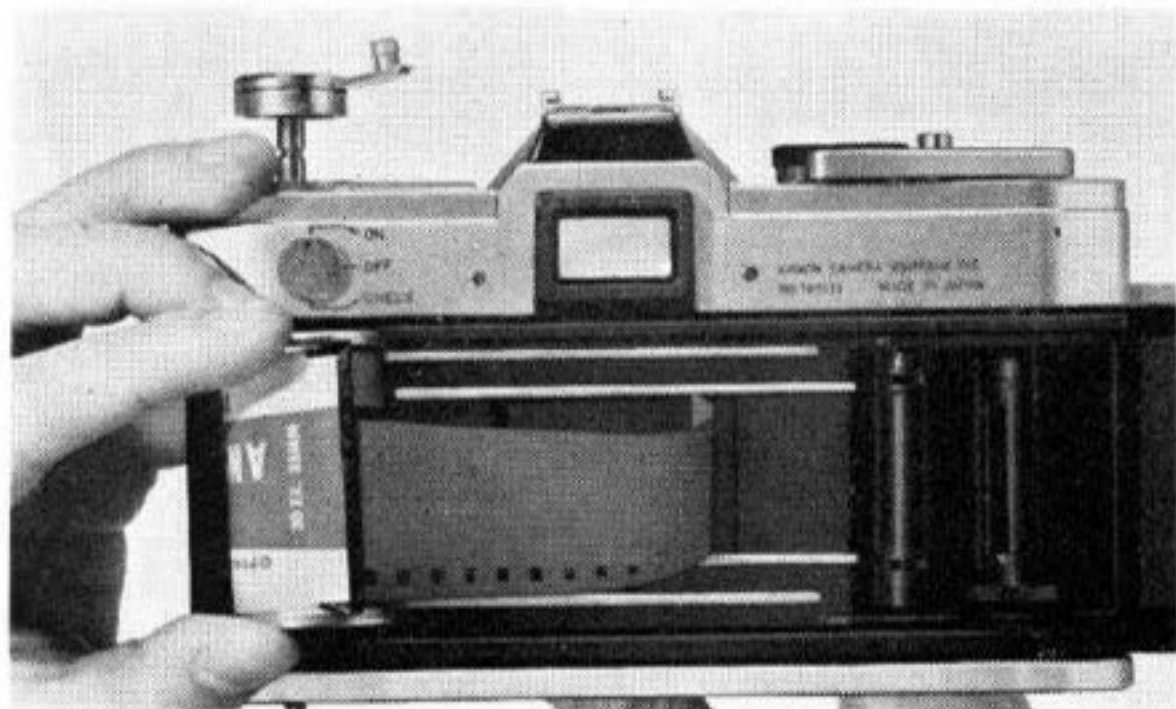

1. Load the film.

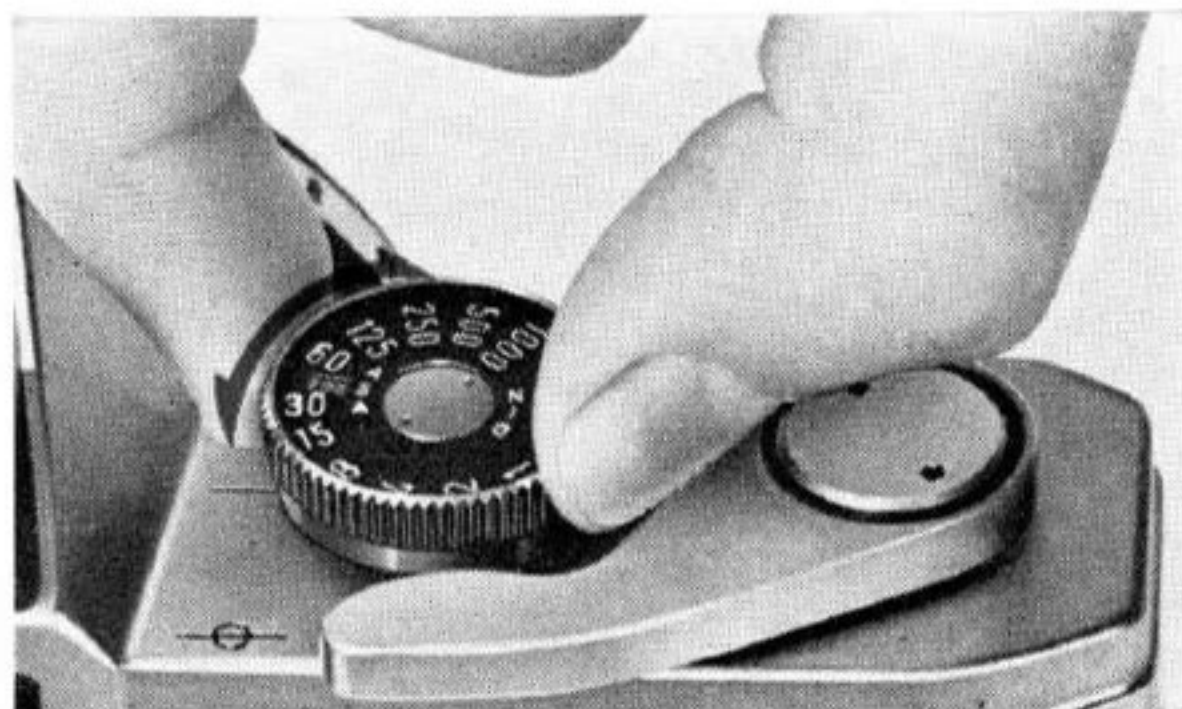

2. Set the film speed.

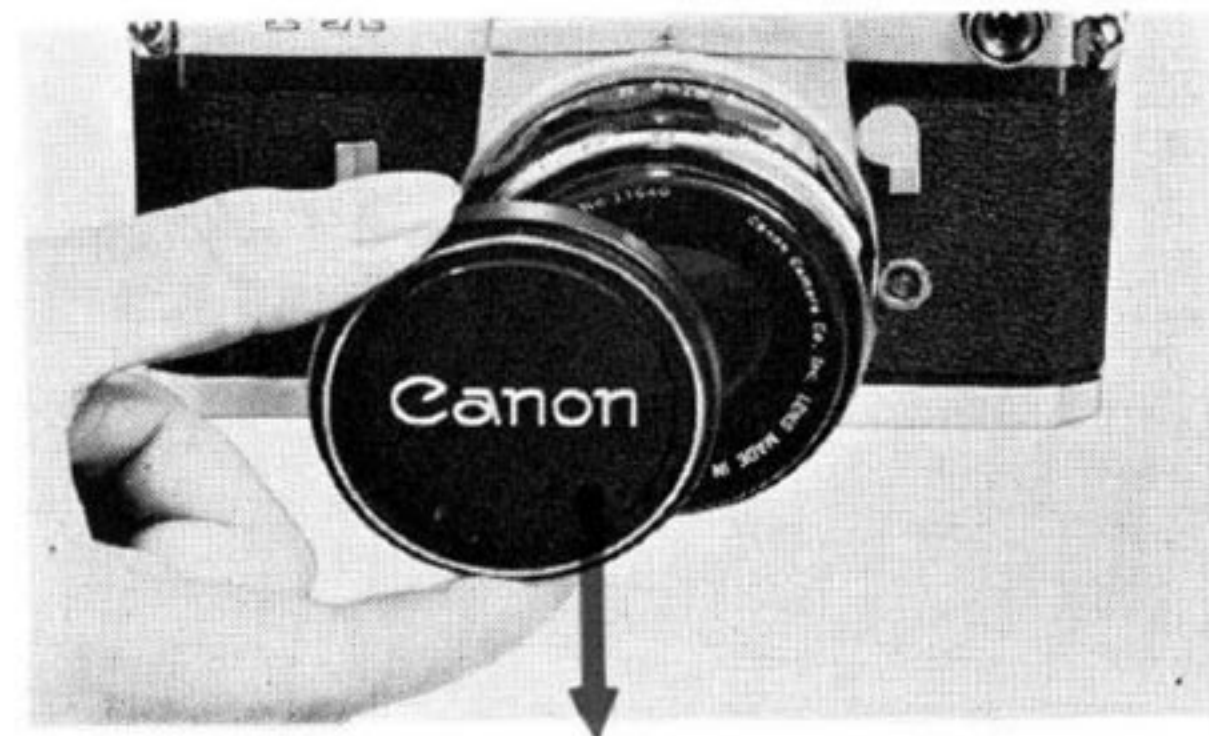

3. If you own a lens cap, remove it first.

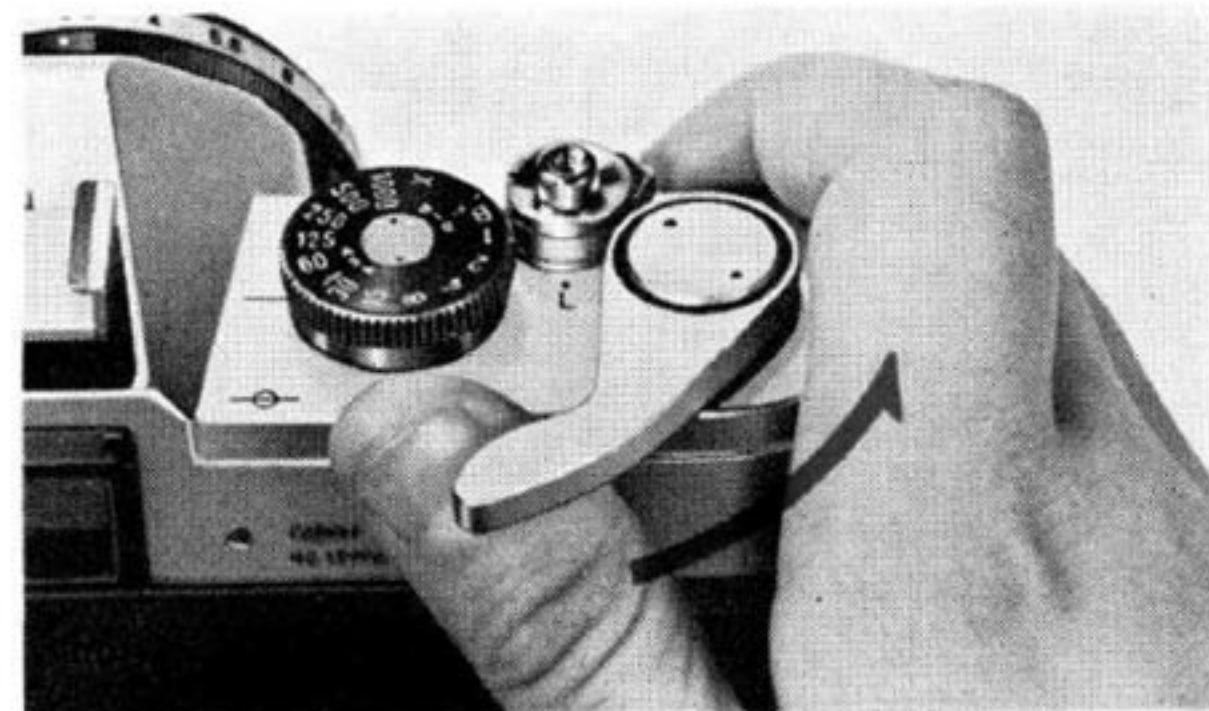

4. Wind the film advance lever.



5. Determine the exposure with built-in meter.

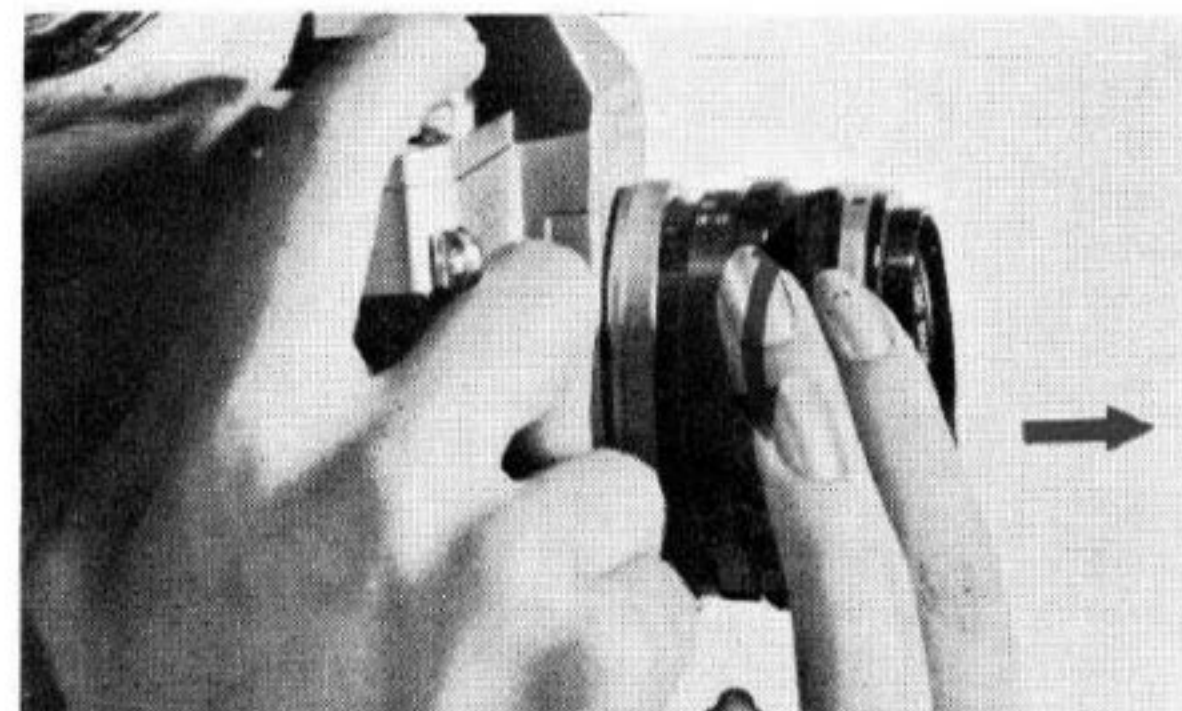

6. Look through the viewfinder.

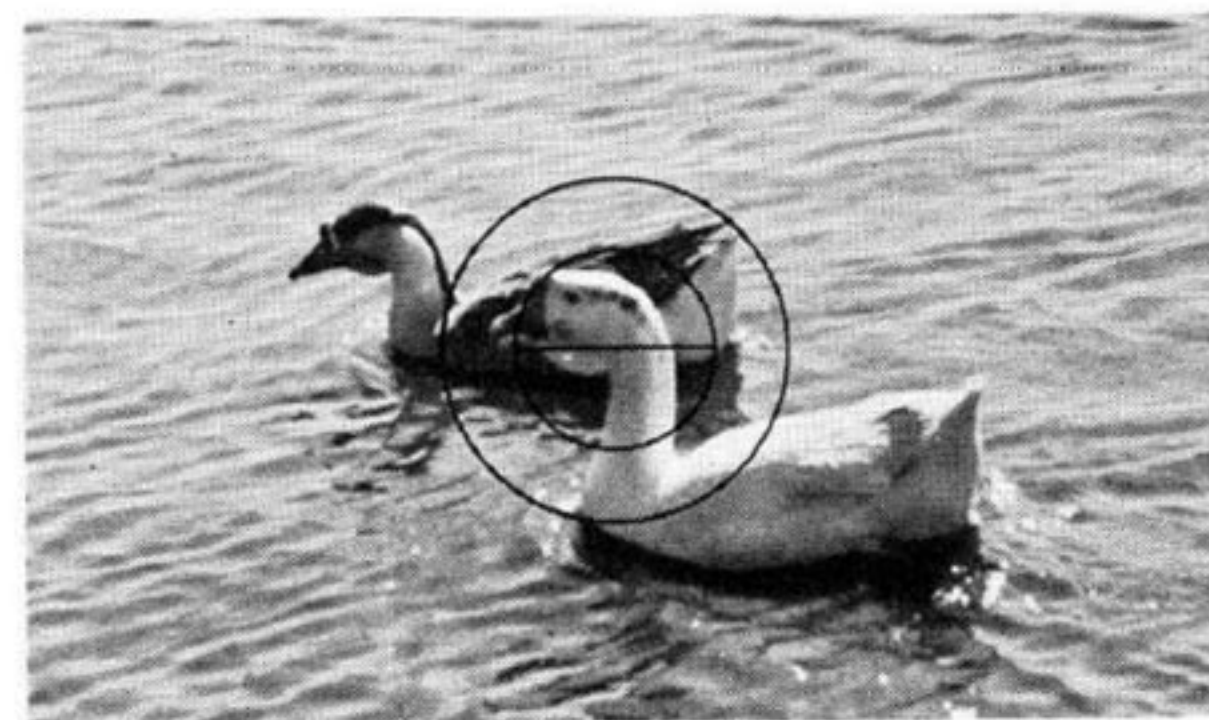

7. Focus and compose the picture.

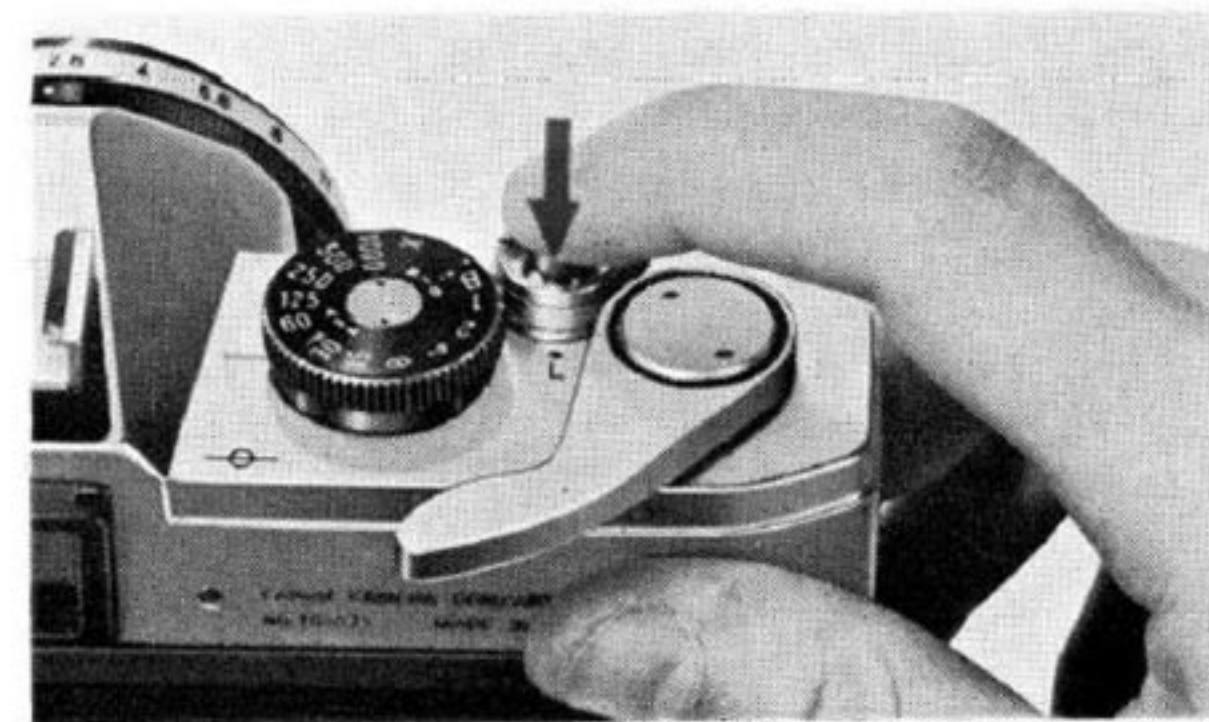

8. Press the shutter release button.

Film Loading

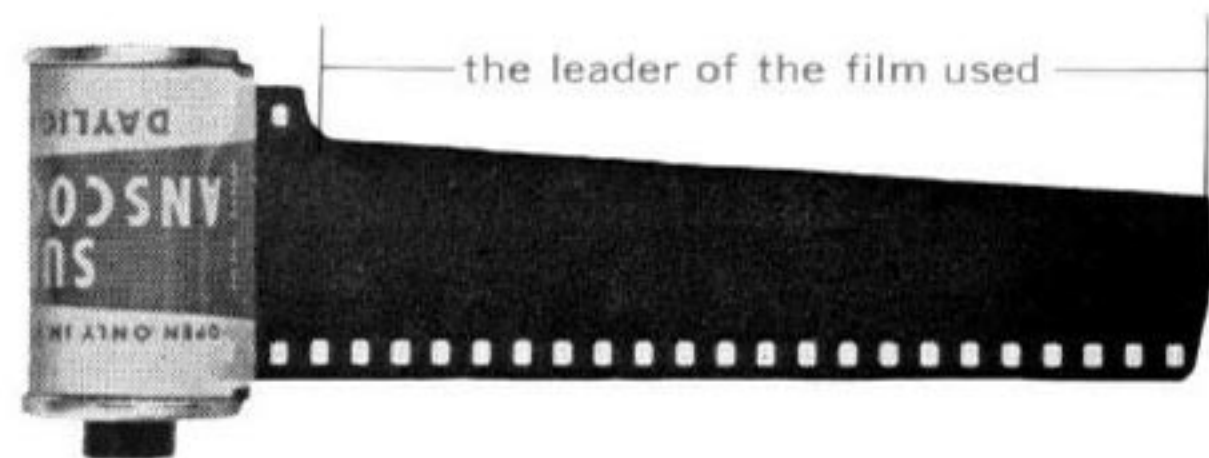

Direction in which film is placed
(emulsified surface facing the back of the lens)

Film used: Ordinary 35 mm film in cartridge for daylight loading.

Handling: When loading, avoid direct sunlight. When unavoidable, face back to the sun and load quickly.

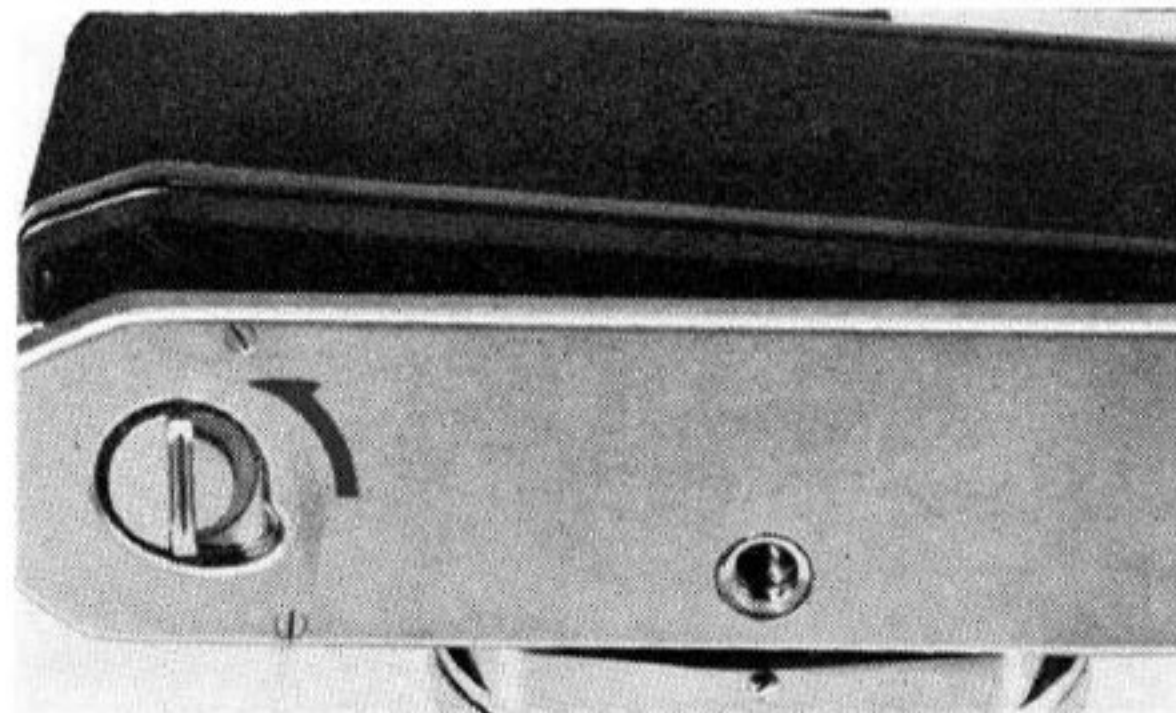

1. **Open the back cover.**
Raise the opening and closing knob, make a half turn to the left, and the cover will rise.
2. **Insert cartridge.**
Raise the rewinding knob sufficiently. When the cartridge has been inserted, push the knob back to its former position again. Push the fork into the axis of the cartridge. In case the knob does not fully return, it can be easily put into proper position by turning it slightly to the left or right.

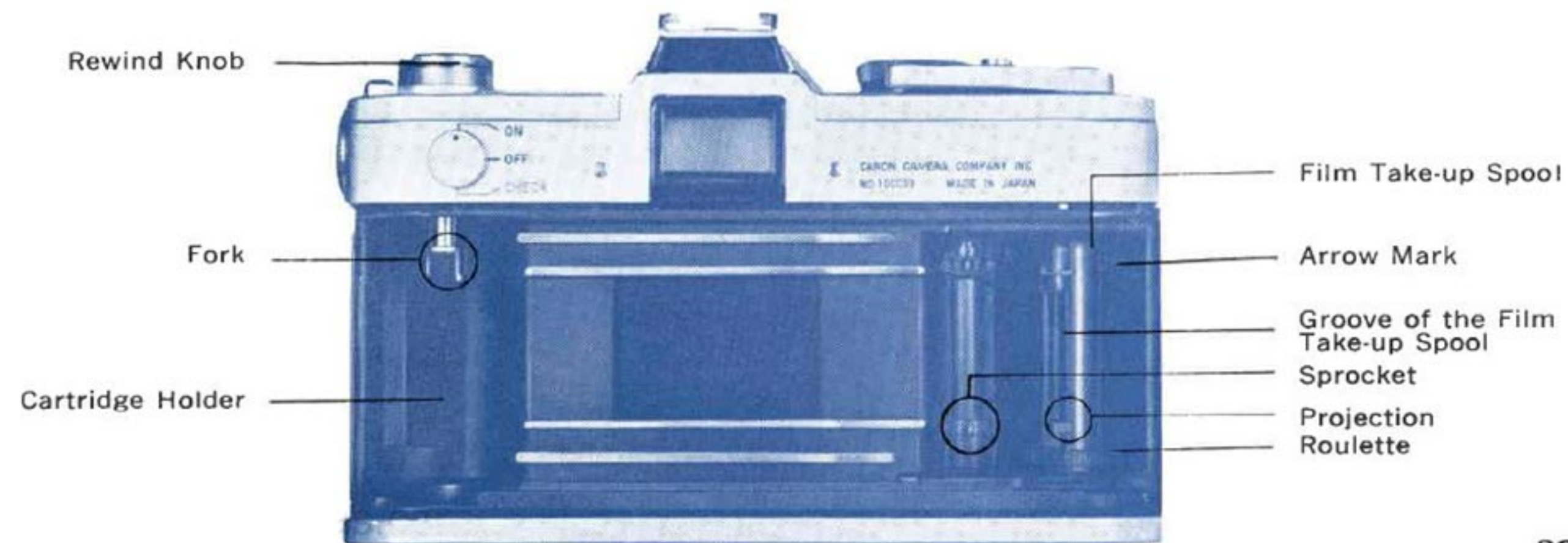
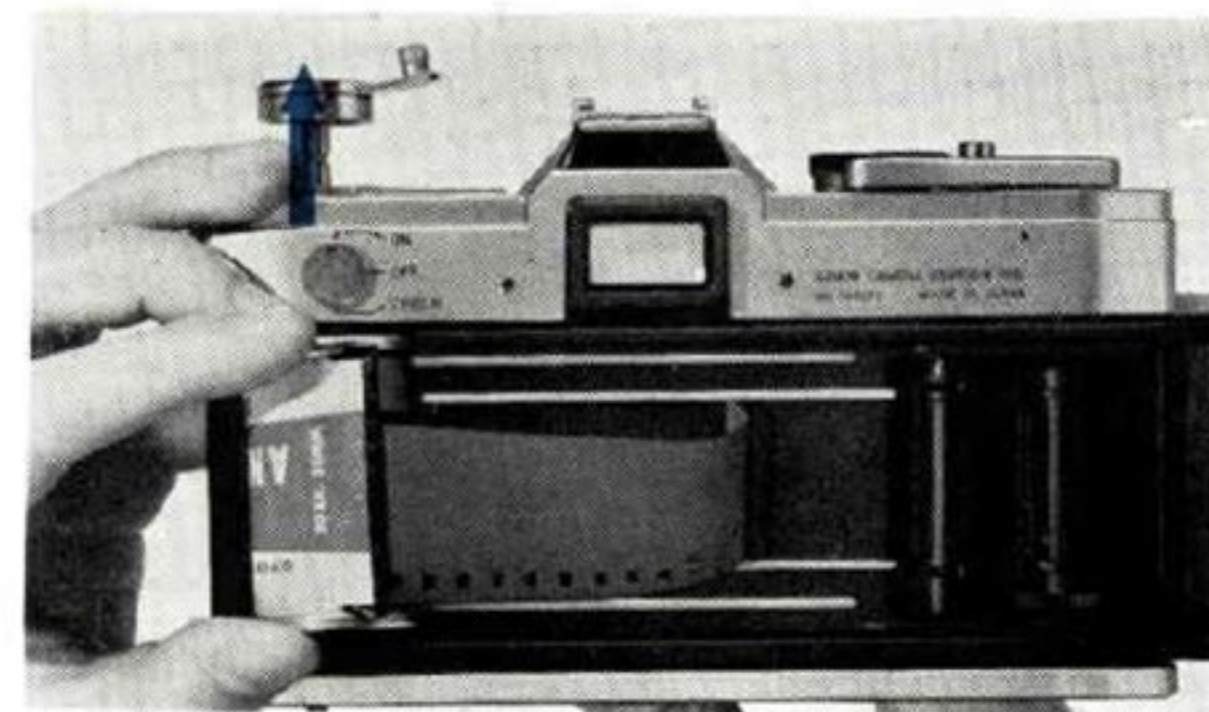

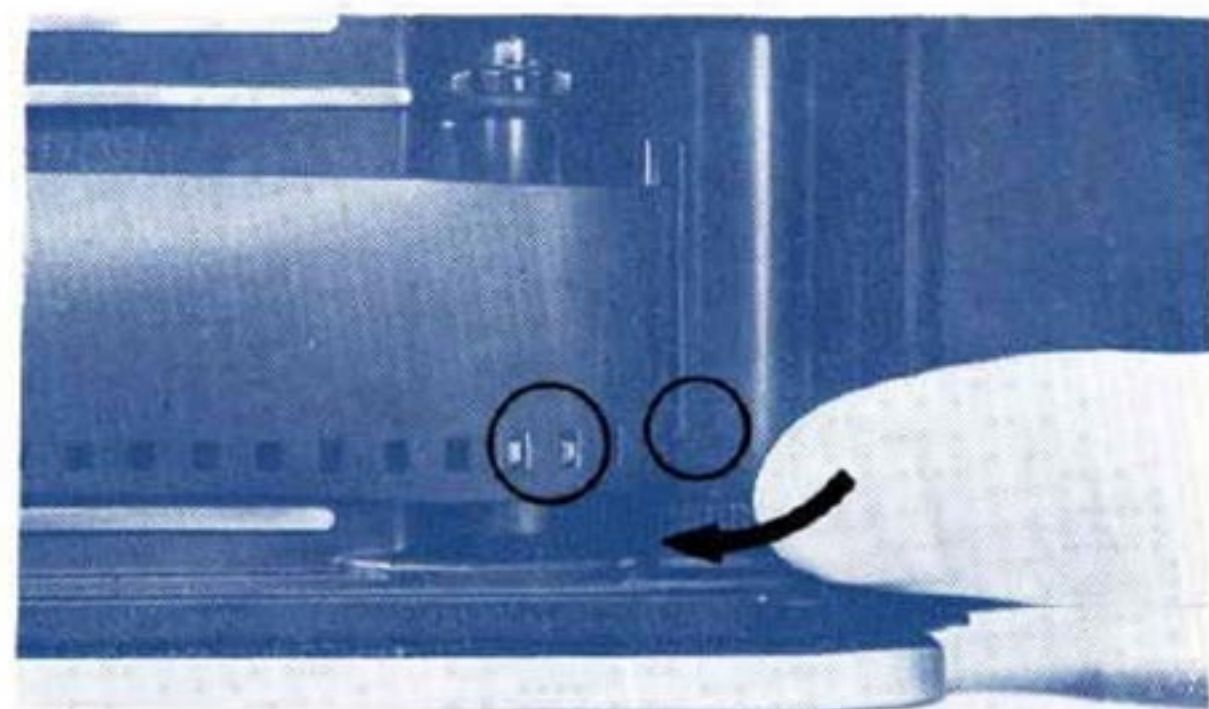
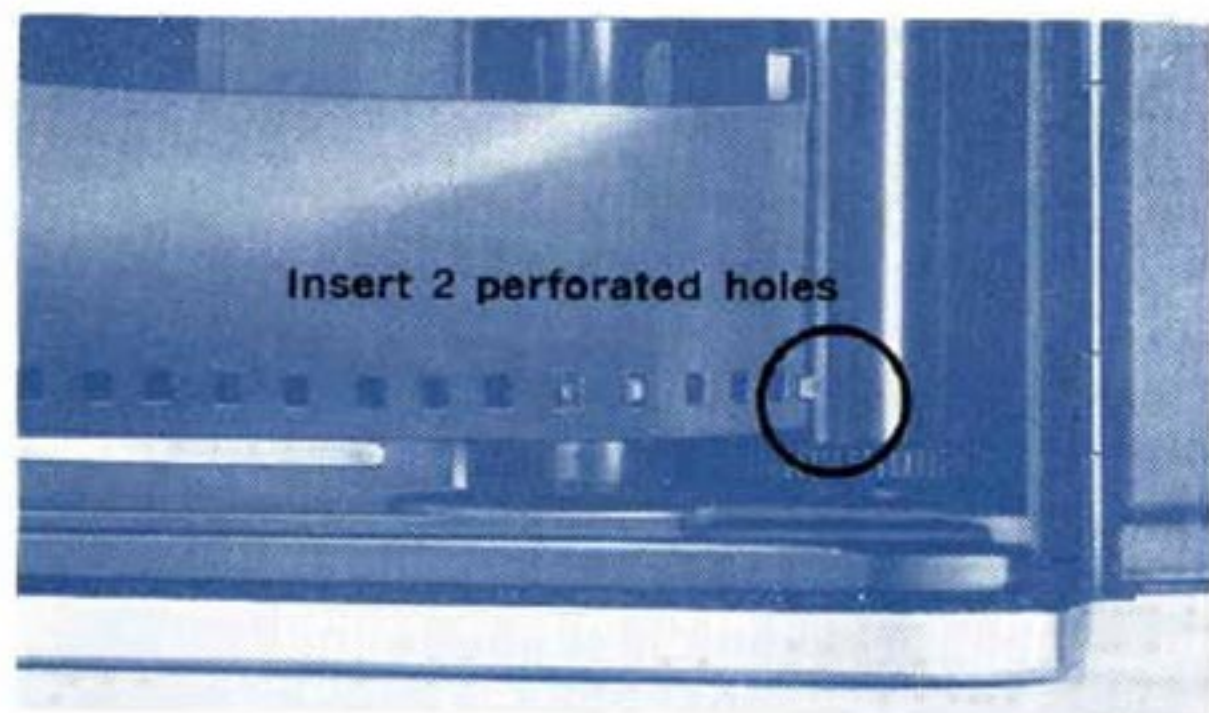

3. Insert the film.

When the groove is hidden on the opposite side, turn the roulette in the direction of the arrow, and bring it to the front. Pull out the tip of the film just a little, and insert it securely into the groove, while seeing that it does not become bent. The proper amount to be inserted is about two perforations.

4. Next, while turning the roulette in the direction of the arrow, engage the holes of the film with the projection of the film take-up spool and make certain that the film does not slip from the sprocket.

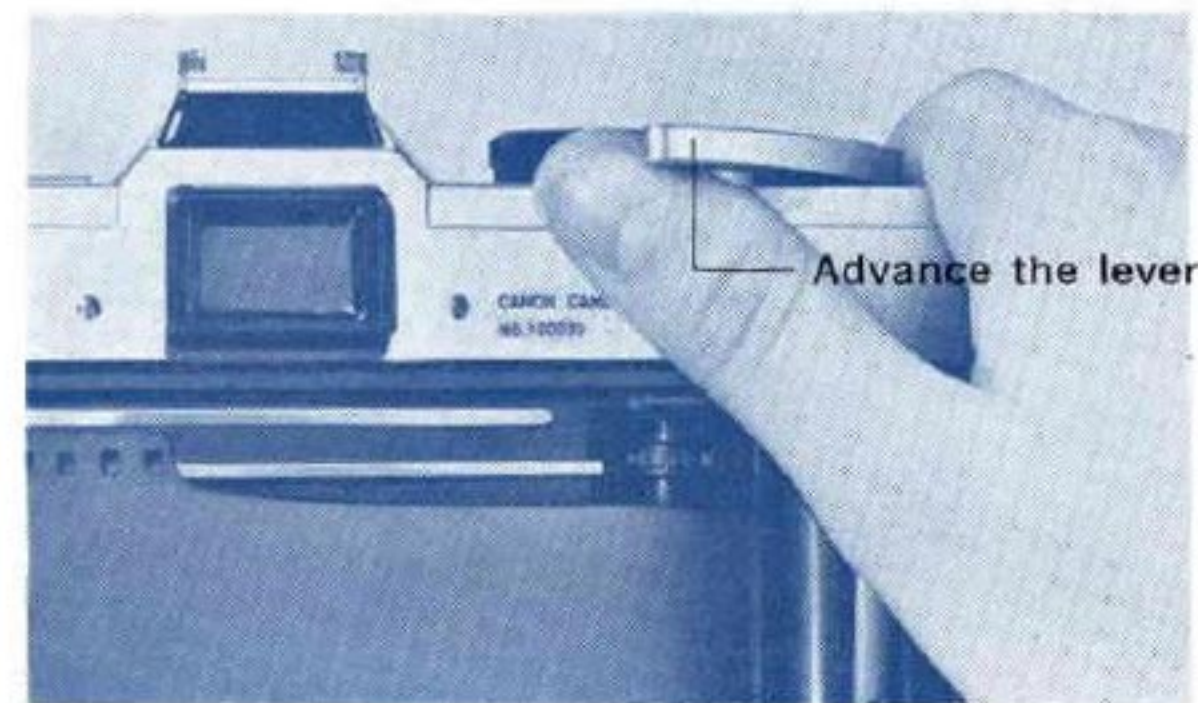

5. Turn the advance lever, and wrap the film around the spool about once.

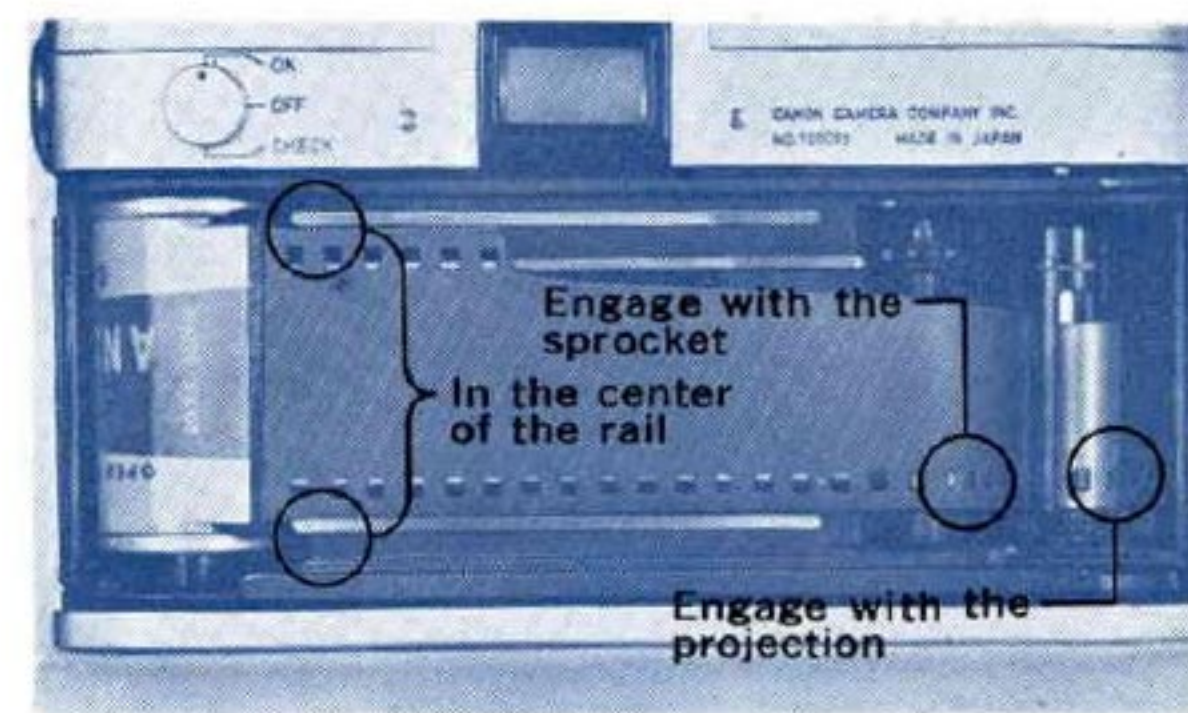

6. If the film sags, pull up the rewinding crank and remove the sagging by gently turning to the right.

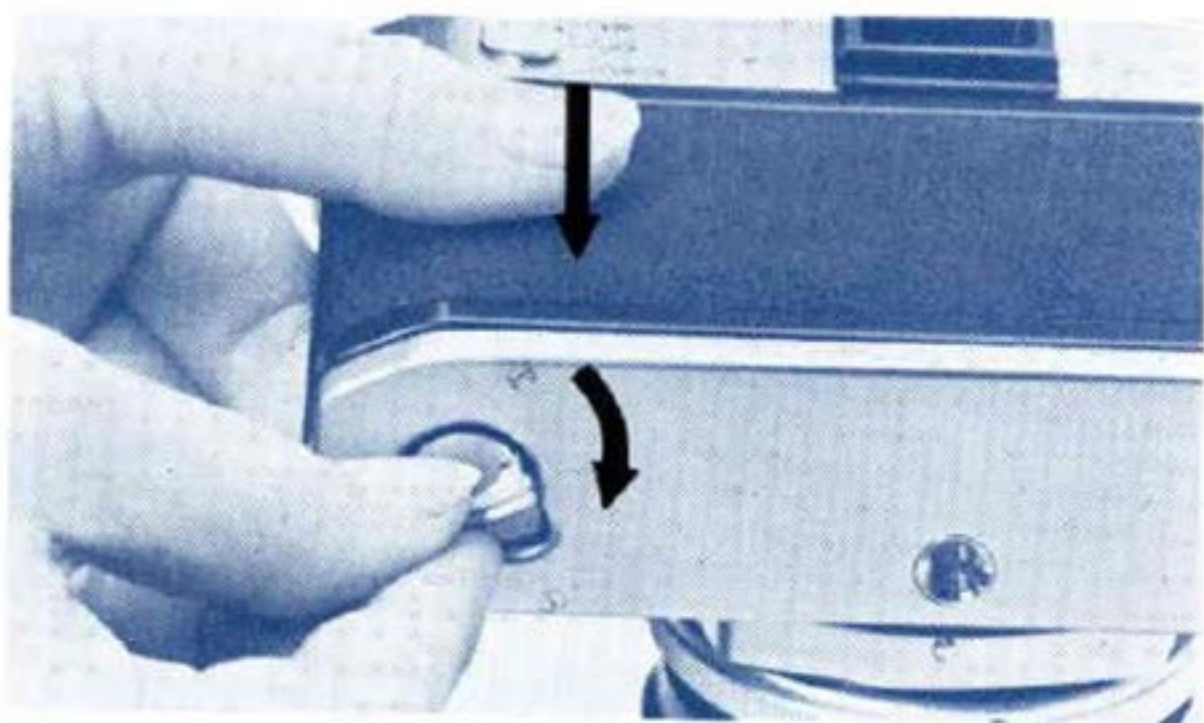

7. Close the back cover.

Press down to prevent the cover from rising, then turn the opening and closing knob. Fold down the rewinding crank.

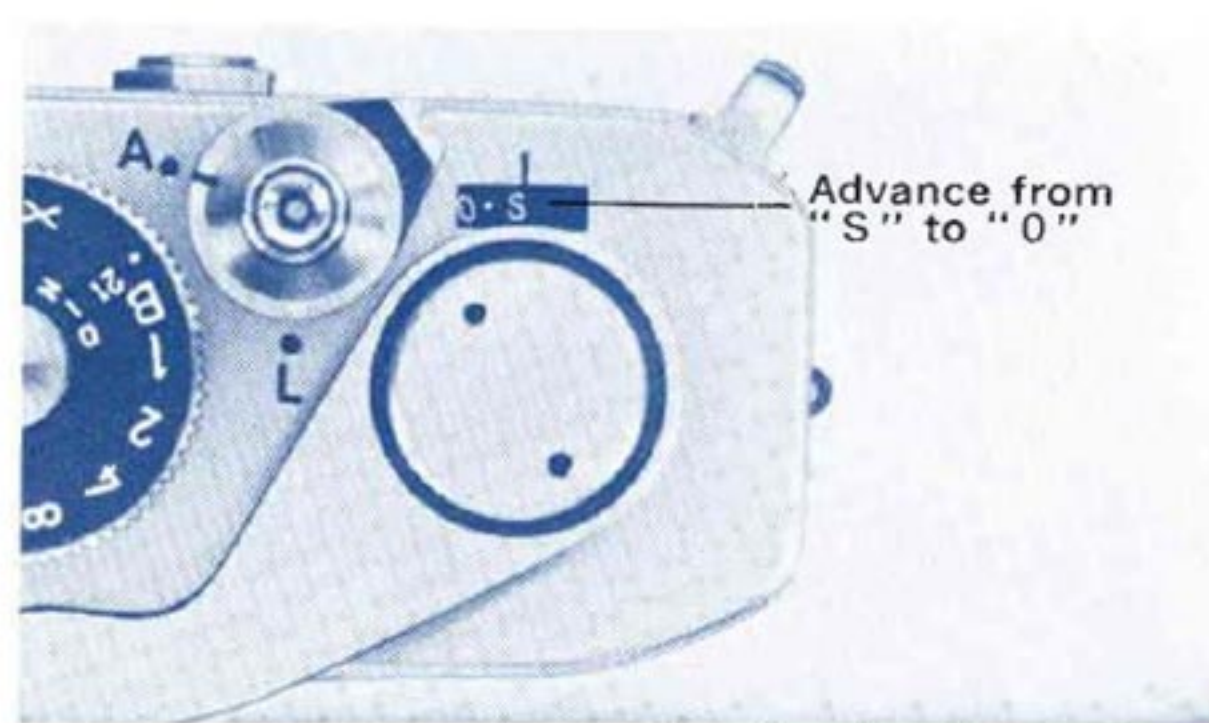

8. Make two (unexposed) shots.

Leave the lens cap on and advance the film twice, each time releasing the shutter. The film counter will advance from the S mark to 0. With one more advance, the camera will be ready for the first shot.

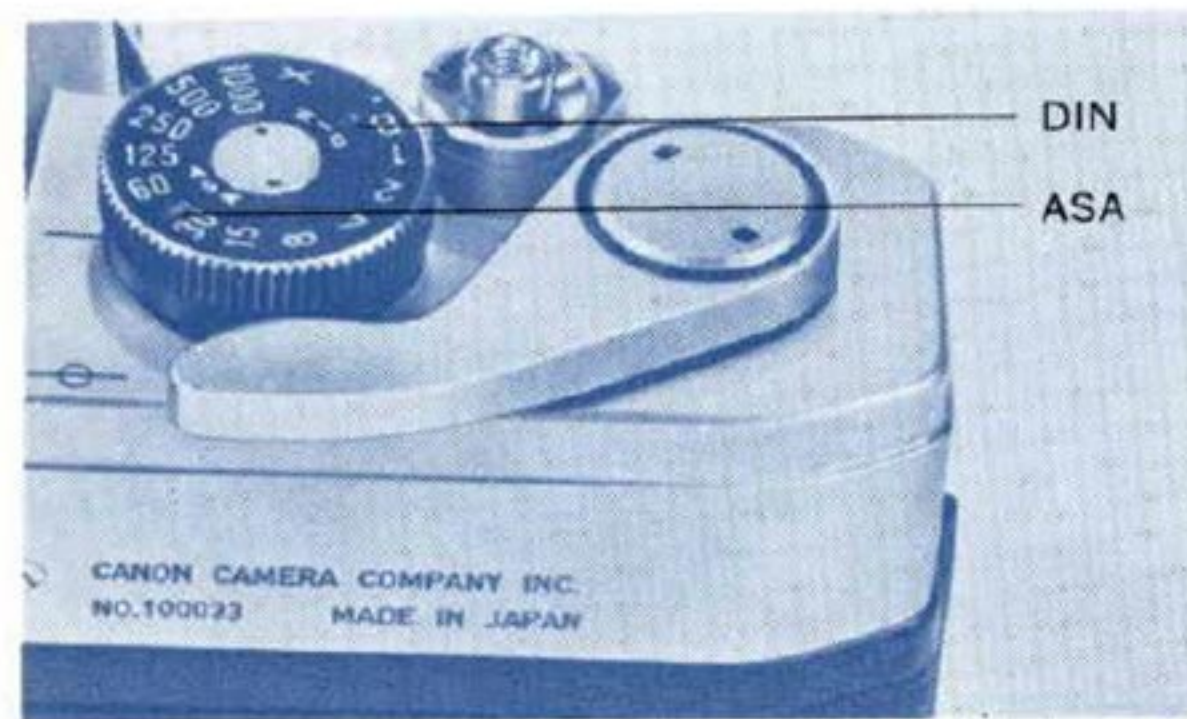

Showing the Film Speed

When loading the film, do not forget to show the film speed in the window of the shutter dial. Turn to page 13 for setting the film speed.

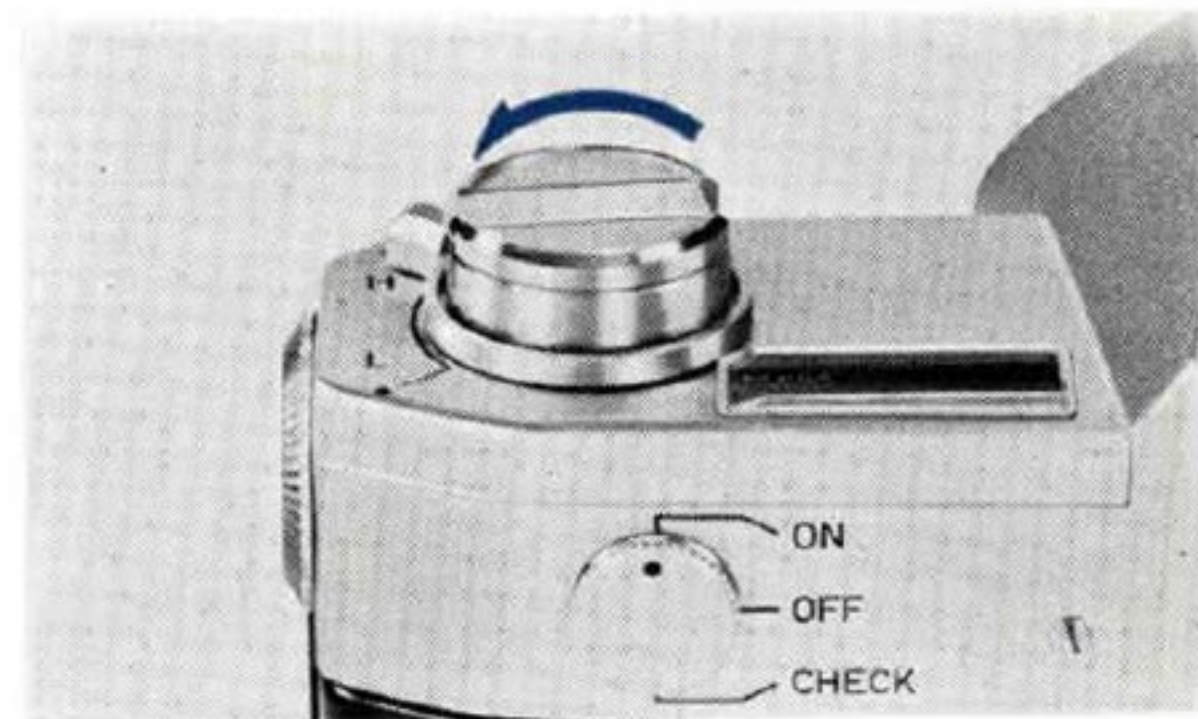

Checking the Correct Way of Loading Film

When advancing film, if the rewind crank turns counter-clockwise, it is proof that the film has been correctly inserted. If there is no turning, it means that either the film has slipped from the spool or the perforations are not correctly engaged with the sprocket.

To prevent failures, always observe the film carefully when loading. When the film is not being sent forward properly, rewind once and reload (see page 31). Be careful not to rewind the film completely back into the cartridge.

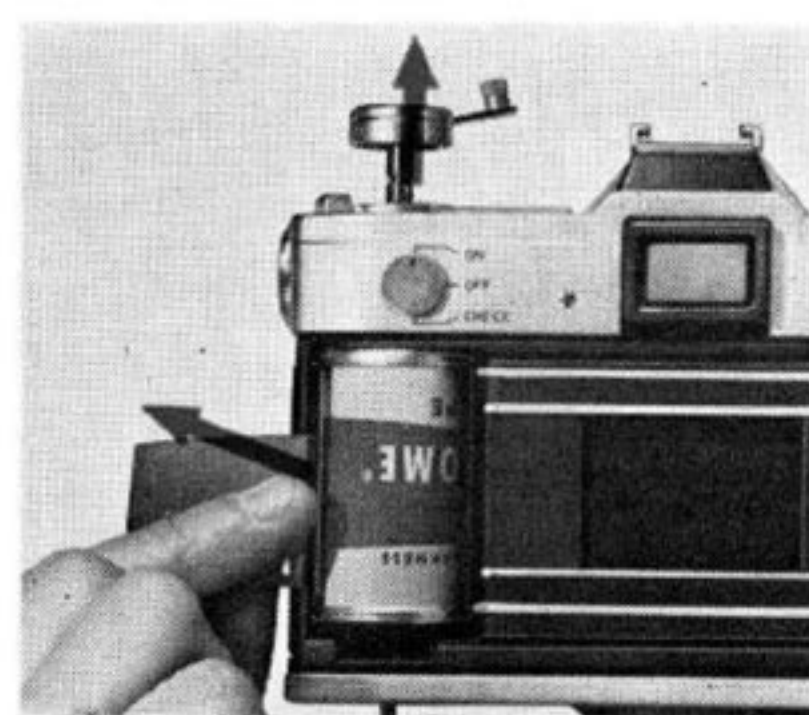
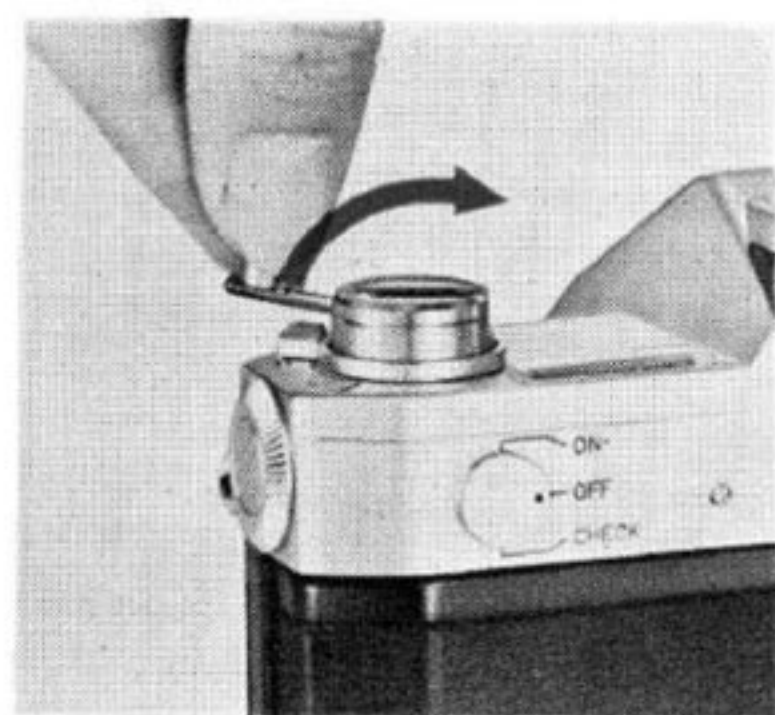
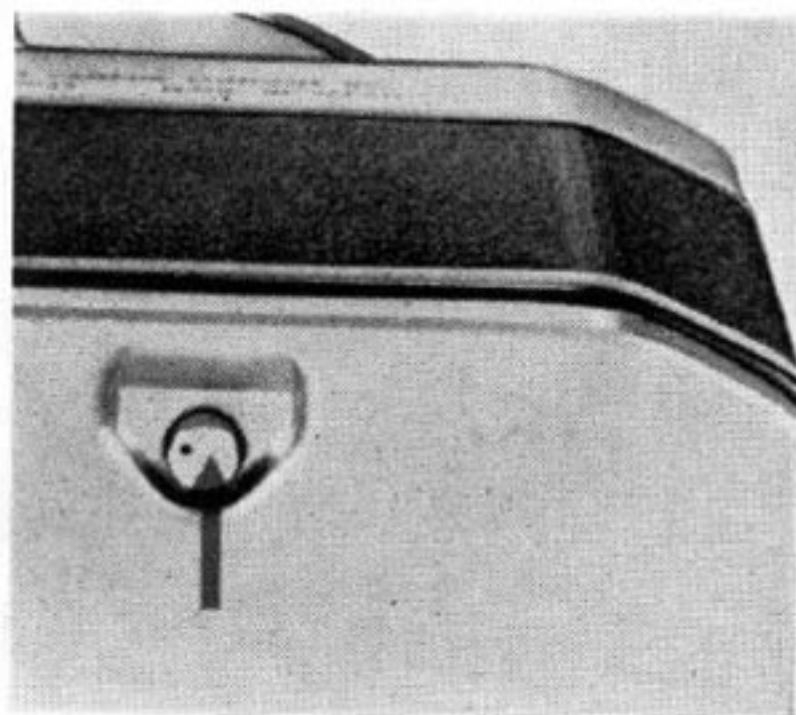

Since no further winding is possible when the end of the film is reached, rewind the film immediately into the original cartridge, as explained below. As the exposed film is naked within the camera, the entire roll will be ruined if the cover is opened before rewinding.

1. **Press in the Rewind Button.**
2. **Rewind with crank.** Raise the rewinding crank, turn it in the direction of the arrow, and return the film into the cartridge. When the rewinding button stops revolving during operation (rewinding resistance becomes light), immediately stop rewinding.

3. **Open back cover.**
4. **Remove the cartridge.**
Remove after raising the rewinding knob completely.
 - * Once the rewinding button has been pressed, the finger may be removed. When the lever is wound, this button will return automatically.
 - * If winding continues even after the film is at an end, the film will tear and rewinding will become impossible. Please be very careful. If this happens, open the back cover in a completely dark room.



- Wind the shutter.
Turn the self-timer lever in the direction of the arrow and press the shutter button. The shutter will be actuated approximately 10 seconds later.
- * Wind the self-timer over 2/3.
 - * Time adjustment is possible, according to position of winding.
 - * The shutter may be wound later.
 - * Do not forget to wind the shutter. If this is neglected and only the self-timer is wound and the shutter button pressed, only the self-timer will act and the shutter will not click.



By connecting the flash unit and cord of speedlight to the flash terminal, it is possible to synchronize the following shutter speeds.

Flash Bulb	Scope of Synchronization													
	1000	500	250	125	60	30	15	8	4	2	1	B	X	
FP class	○	○	○	○	○	●	○	○	○	○	○	○	○	●
M class	●	●	○	○	○	●	○	○	○	○	○	○	○	●
F class	●	●	●	●	●	○	○	○	○	○	○	○	○	●
Speed-light	●	●	●	●	●	○	○	○	○	○	○	○	○	○

- * ● markings cannot be used.
- * Even in the case of flash photography, the lens hood is necessary.
- * The shutter speed for X is 1/60 sec.
- * Use shutter speeds of under 1/60 sec., for very small types of M class bulb, such as AG-1, US-1 and PF-1, MX-O.

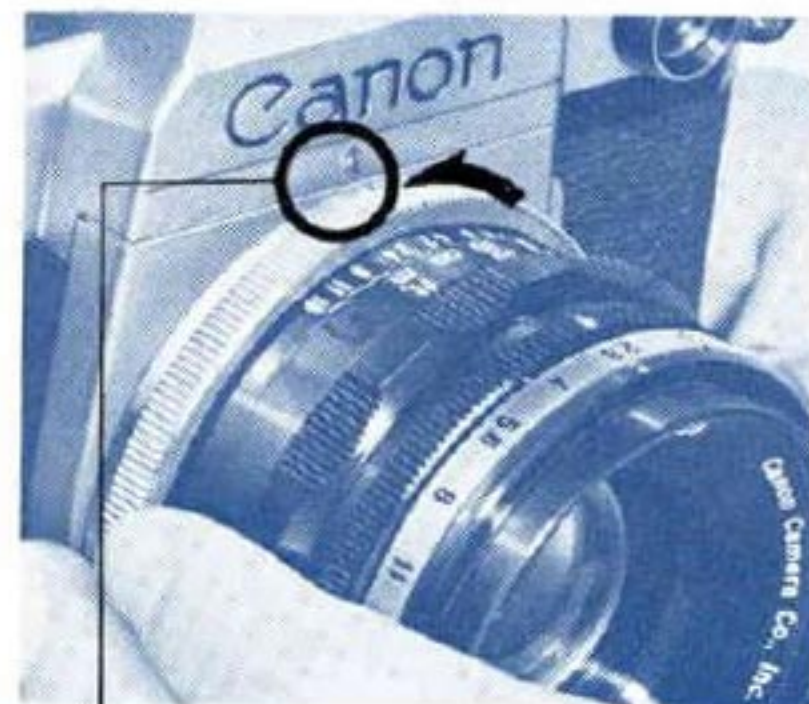

Coincide the red dots and remove

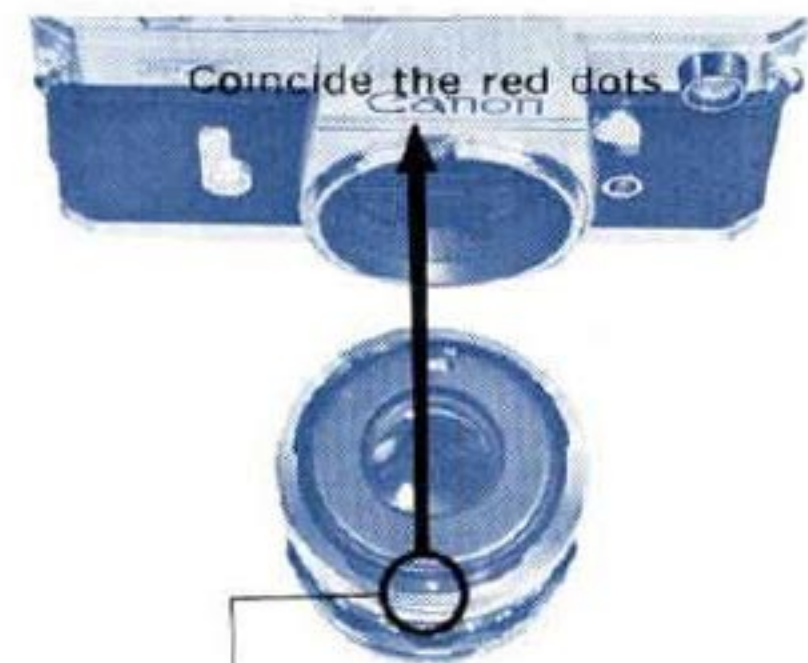

Coincide the red dot and guide pin



Aperture Lever

Changing Lens

In removing the lens from the camera, after turning the bayonet ring of the lens to the left, pull the lens forward.

In mounting the lens, match the red dot of the lens to the red dot on the camera mount. Turn the bayonet ring to the right and fasten.

* When mounting, turn the bayonet ring of the lens sufficiently to the left and coincide the red dot and guide pin of the lens.

* Do not change your lens in the strong light. When changing your lens, have the replacement lens at hand. Then quickly change the lens in the shade...or use your shadow as a shield from the direct light.

* There is a pre-set aperture operating lever at the back end of the lens. This lever, which opens and closes the aperture, is very important. When the lens is removed, be sure always put on the dust cap.

* After the lens has been detached, **do not touch the mirror or the coupling section of the aperture.** When not in use for a long time, protect the lens with flange cap.

* As every trace of water bubble cannot be entirely removed from glass used for high quality lenses, it should be understood that this is unavoidable because of the manufacturing process. Lens bubbles will not affect the sharpness of the picture.

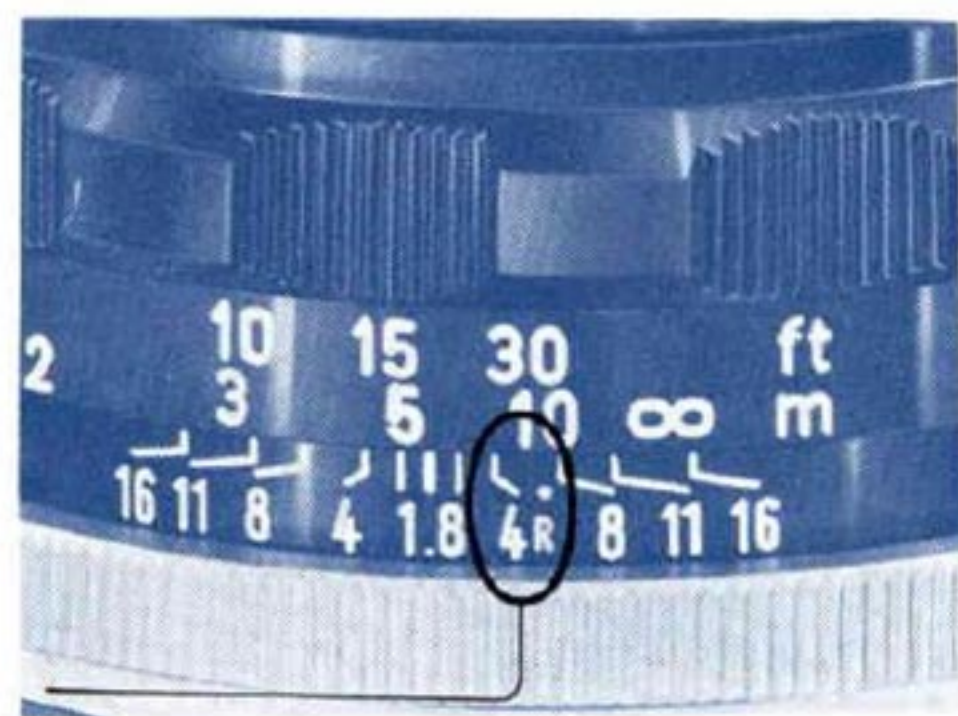
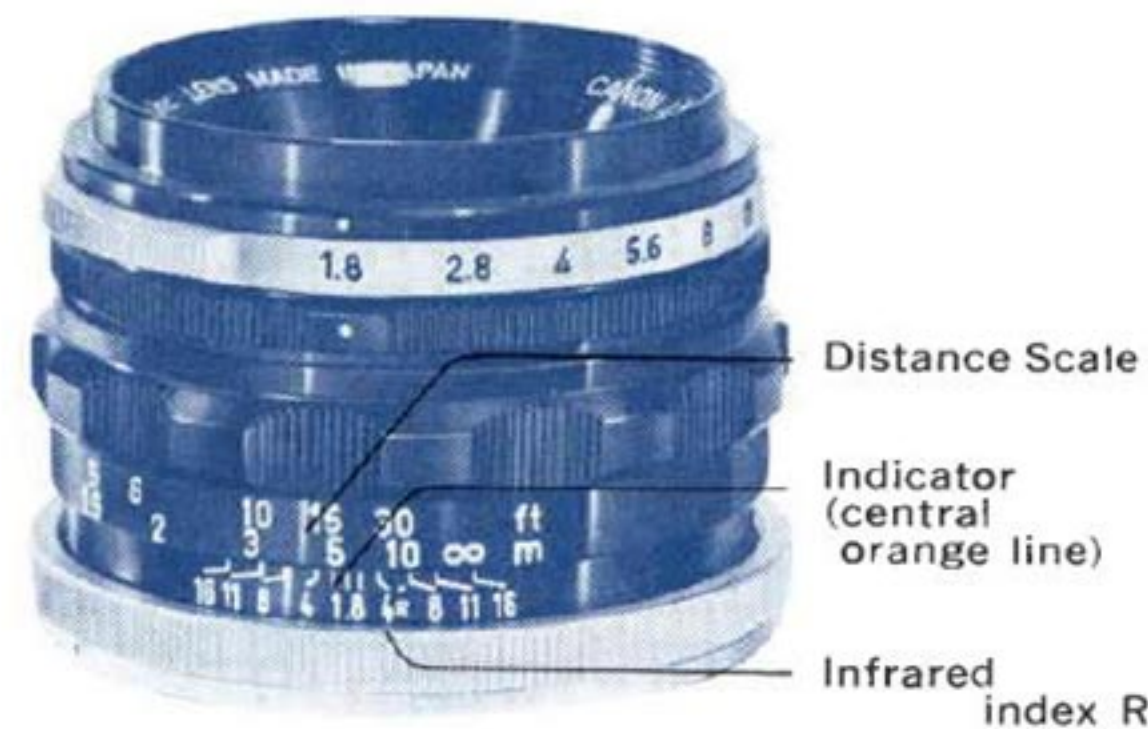

Distance Scale

The distance scale shows the distance between the focused subject and the film surface. Although for ordinary pictures it is not necessarily essential, it is needed for checking the depth-of-field, for infrared photography and flash photography. The correct position of the scale, where the distance is a one-digit figure, is in the middle of the figure; if it is a two-digit figure, it is between the two figures; and if it is a three-digit figure, it is in the middle of the central figure.

Infrared Index R (Infrared Mark)

For infrared photography, correction is necessary because the focal position varies a little from ordinary photography. Make ordinary focusing first, then adjust that distance scale to the Infrared Mark "R". For instance, if the distance scale reads 10 m after focusing, merely shift the 10 scale to "R" position.

* Infrared Index

The position of R is scaled according to the use of the standard of a film with the highest sensitivity of a wave length of about 8000\AA and infrared filter (for example, KODAK IR 135 film and WRATTEN 87 filter or JIS IR 77-87 filter). When you take pictures using the plus X or ordinary Pan film with the WRATTEN 25 or red filter of SR 59-60 attached, the proper amount of correctional movement is about $1/3$.

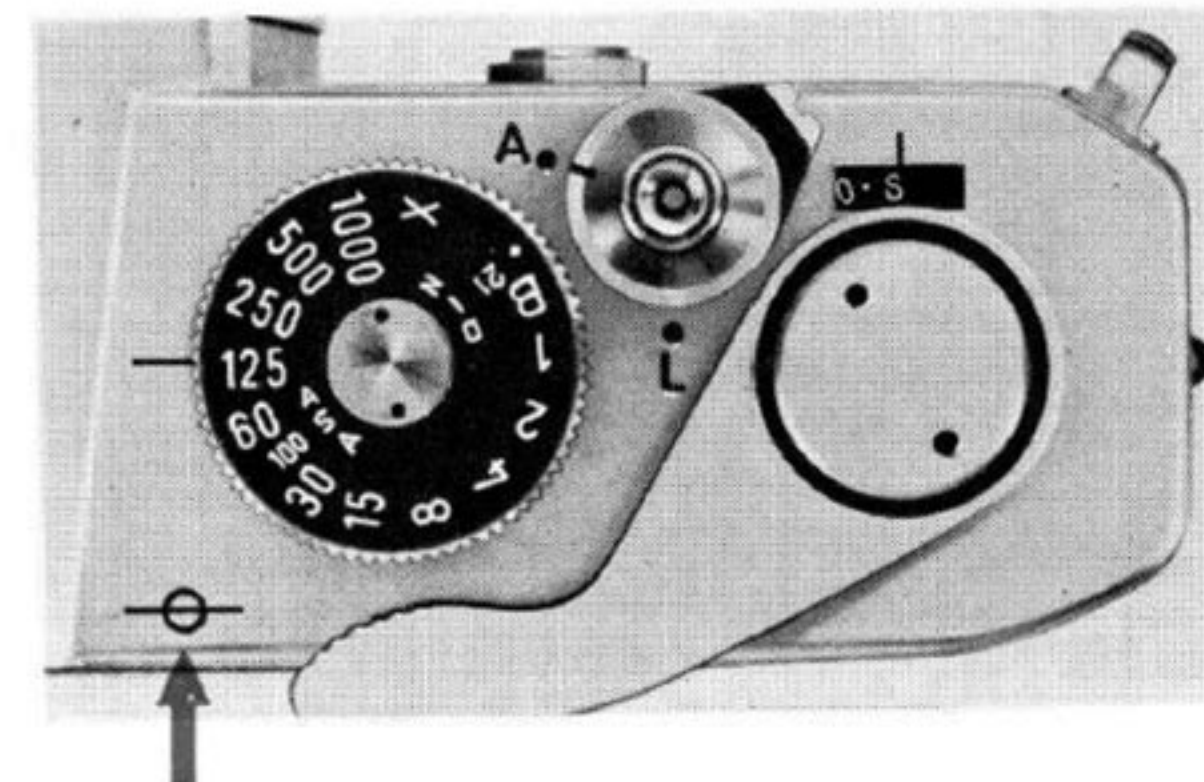

Film Plane Mark

The lens distance index is scaled by measuring the distance from the film position. Thus, in case the focusing is done by actual measurement, measure from the film plane mark and transfer this distance to the lens distance index.

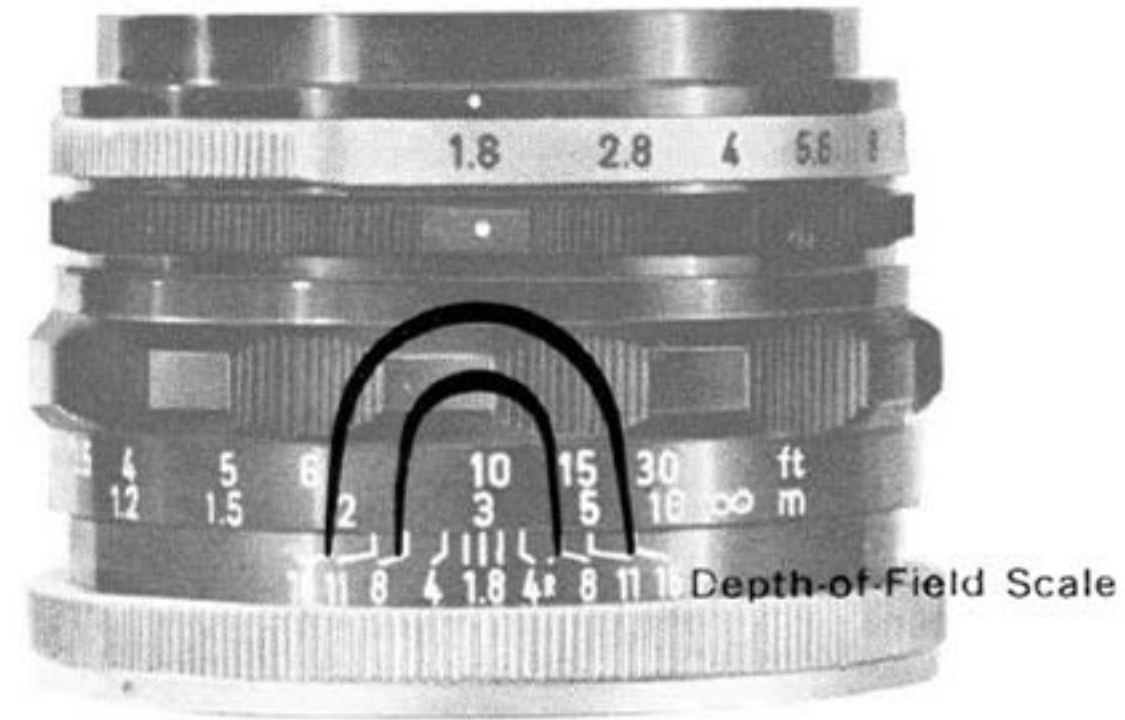

Depth-of-Field Scale

When one given subject is focused, there is a range in front and behind which is sharply produced, known as "depth-of-field."

As this scope changes according to the size of the lens aperture, the aperture readings are scaled related to the distance scale.

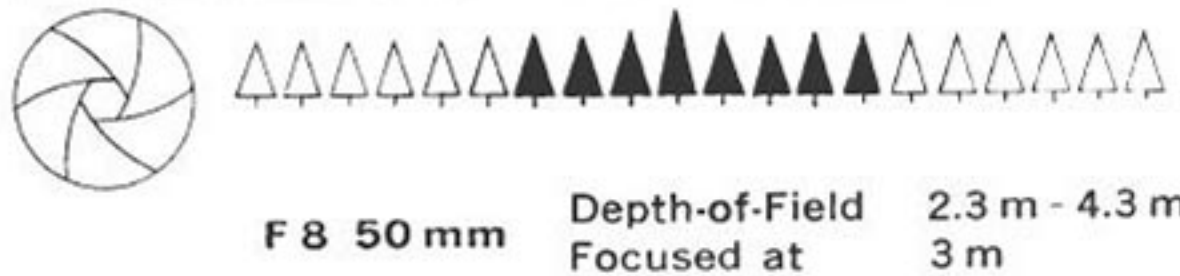
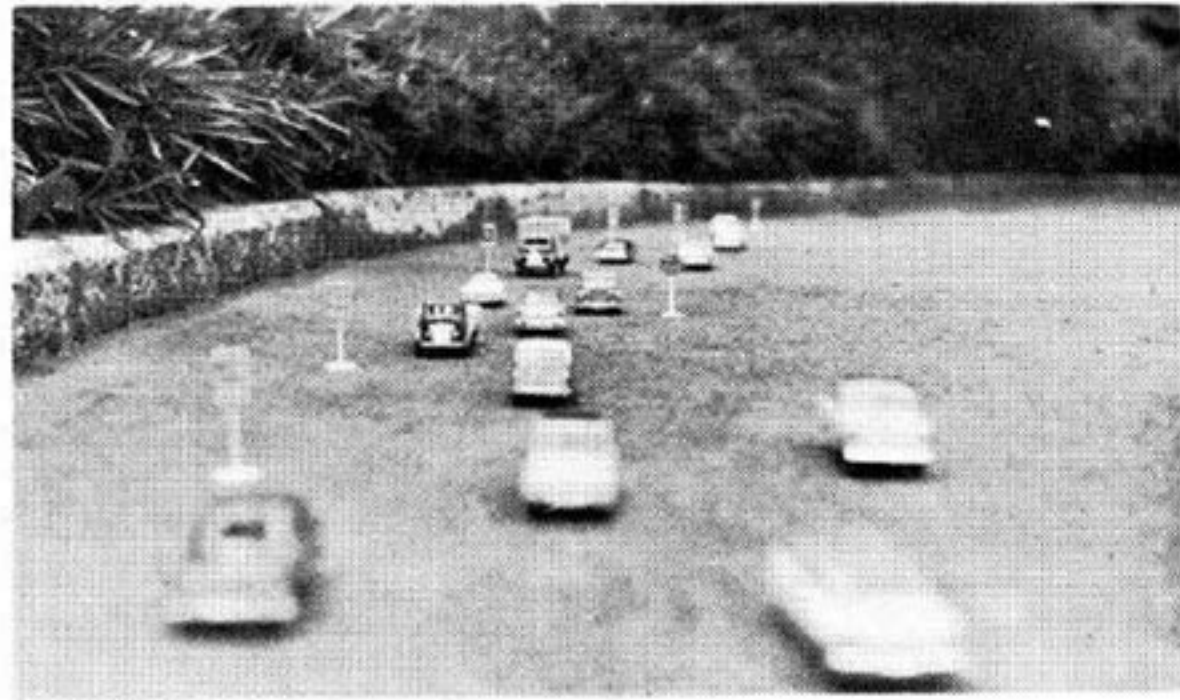

To use the depth-of-field scale, for instance, if the lens is 50 mm and the subject has been focused at a distance of 3 m, with an F 8 aperture, make the reading of about 2.3 m and about 4.3 m from the distance scale of 8 on both sides of the distance index.

Similarly, if the aperture is F 16, the picture will be sharp from about 1.9 m to 7.6 m.

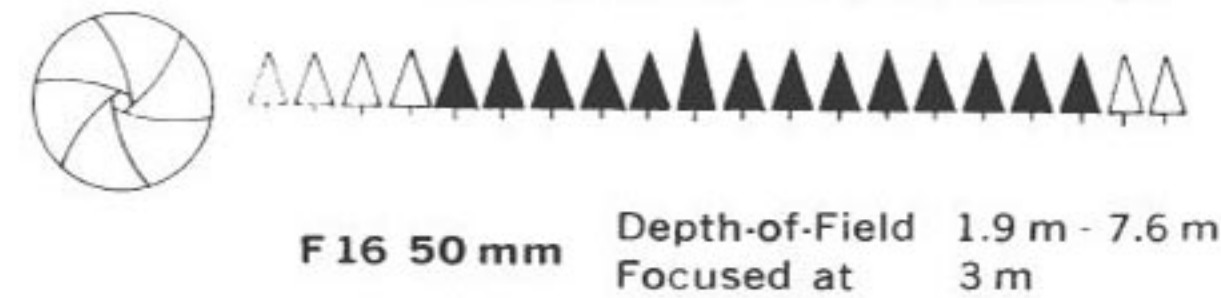
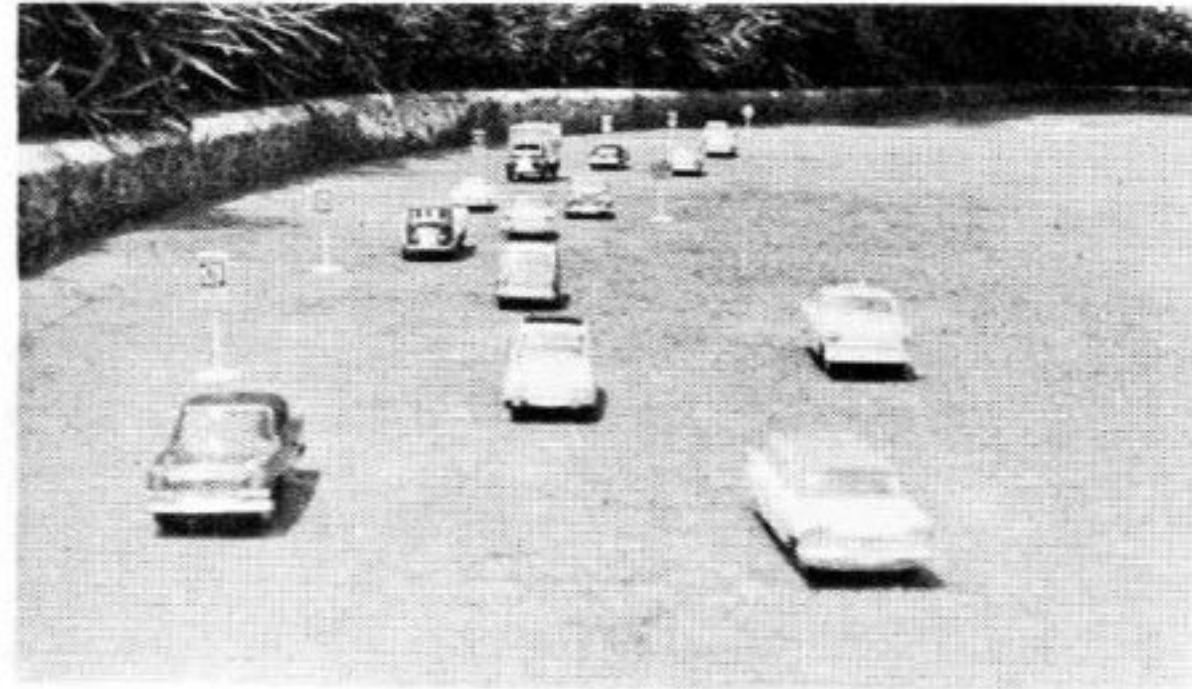

This range will vary with the "F" stop selected. For example:

- The depth-of-field will be deeper...
 - the smaller the lens aperture
 - the shorter the lens focal length
 - the farther the distance of the subject.
- The depth-of-field will be shallower...
 - the larger the lens aperture
 - the longer the lens focal length
 - the nearer the distance of the subject

The versatile Canon Lens FL has a feature which lets you see the actual sharpness through the viewfinder eyepiece by rotating the manual aperture ring.

Lens Mount (R Lens and FL Lens)

As the lens mount for the Canon FX is the same as for the Canonflex, it is possible to attach all Canonflex interchangeable lenses. However, as the mechanisms of the automatic aperture are entirely different, the picture must be taken by using the manual aperture. The same thing applies when the FX lens is used on the Canonflex.

Fixing Mirror Upwards

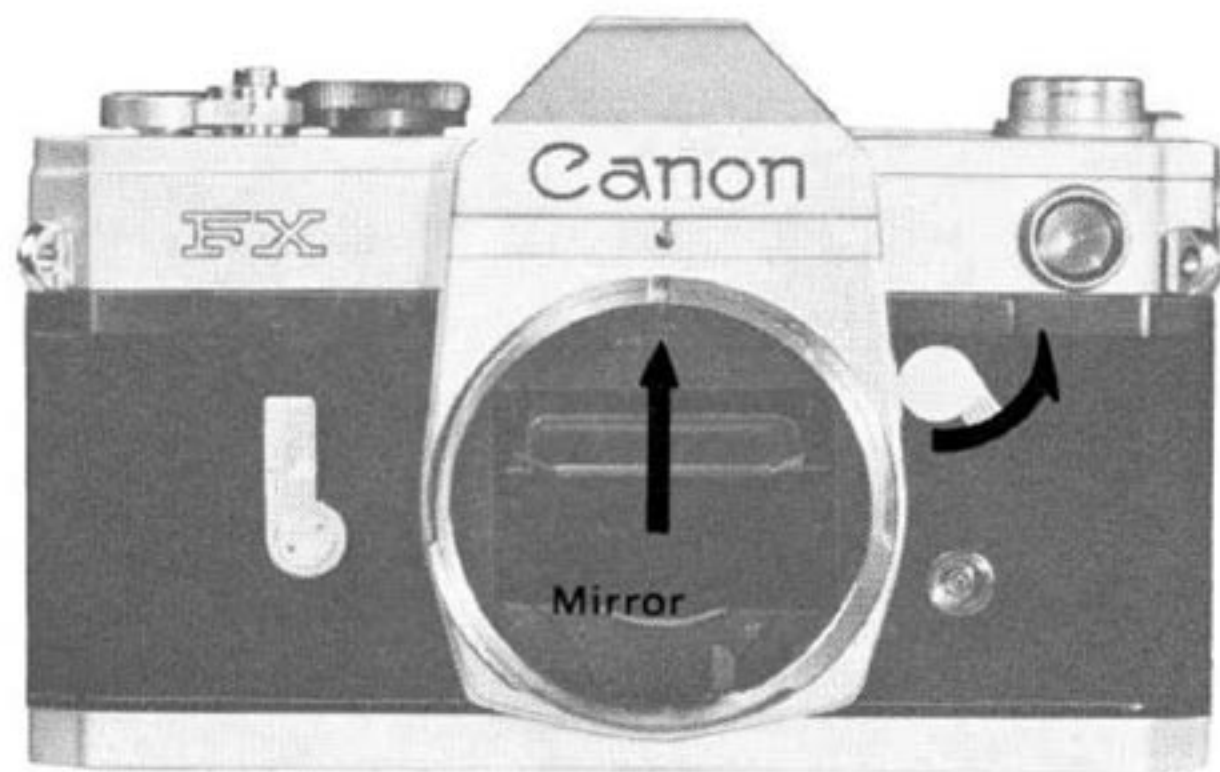

In case the 19 mm super wide-angle lens equipped with this camera is used, the mirror will be set in "up" position.

- * For mounting the lens, turn the mirror lock lever in the direction of the arrow. The mirror is thus fixed to a position under the surface of the focal glass. The lens is then attached and used with the mirror in a fixed up position.
- * Attach the lens quickly in the shade. The film will sometimes become foggy if the lens is left unattached.
- * The mirror lock may be operated without regard to the shutter winding and shutter speed. Film wastage is prevented.
- * **Do not use the mirror lock for ordinary picture taking with the automatic aperture.**



Super wide-angle 19 mm lens

When its use becomes necessary, release the pre-set aperture and take the pictures under "manual" conditions.

- * When the mirror lock is operated, it loses its functions as a single lens, thus necessitating the use of a separate viewfinder for use exclusively with the 19 mm lens.
- * When the mirror is locked up, always keep the lens covered when not in use. If it is accidentally turned in the direction of the sun without the cap, there is the danger of the diaphragm of the shutter being burned.
- * After the mirror lock device has been used, never fail to completely return the mirror lock lever to its original position. Failure to do this will result in inexact focusing.

Double Exposure

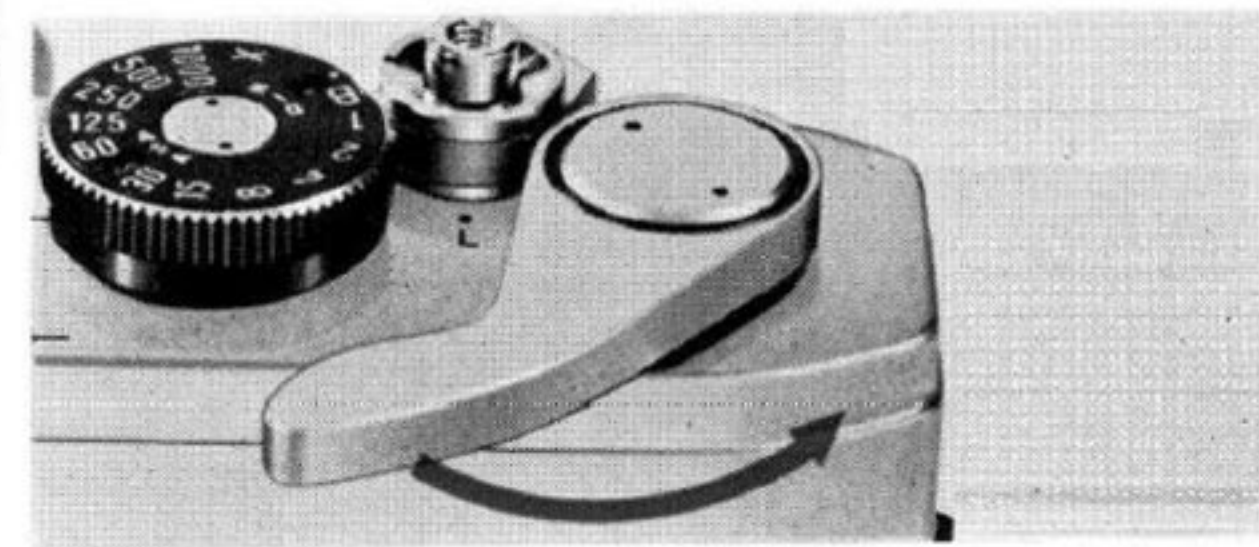
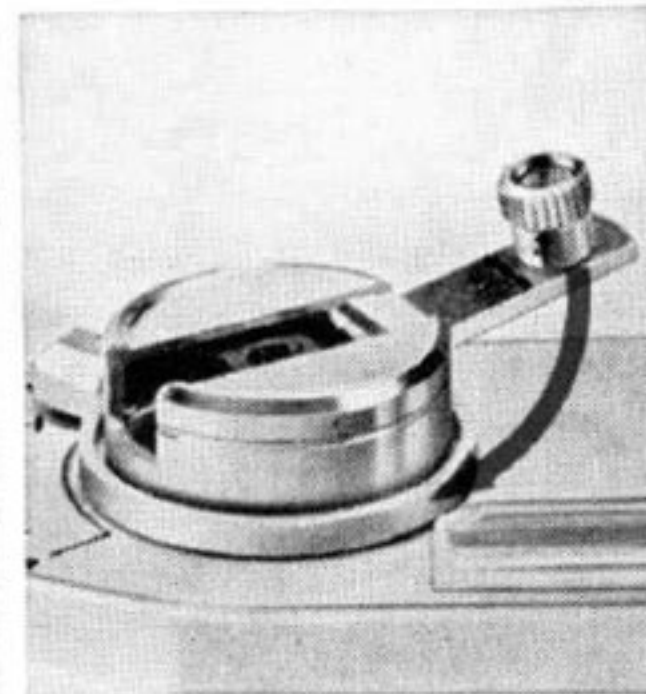
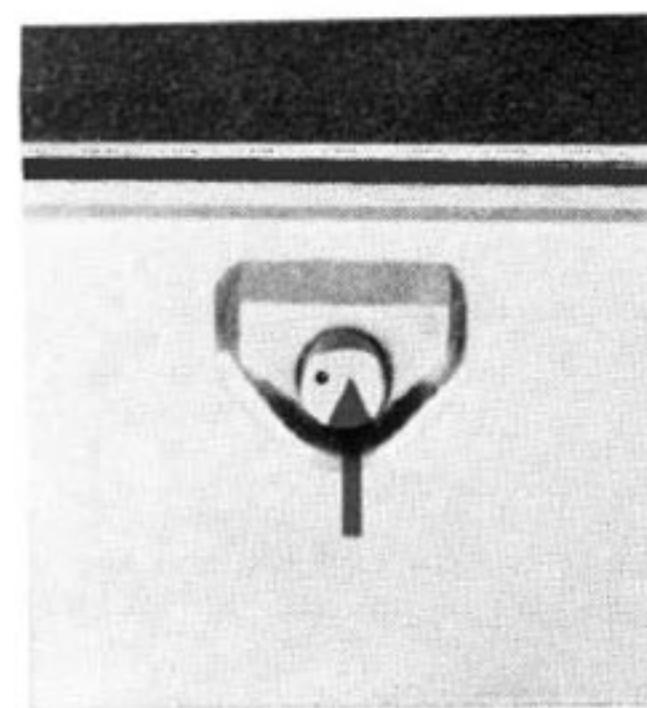

Under ordinary usage, there is no danger of double exposure by the Canon FX. However, if necessary, double exposure can be made by the following steps:

1. When the first exposure has been made, press the rewinding button.
2. Watch the marking on the rewinding button and rewind the film with the rewinding crank.
3. When the marking has made one revolution, stop rewinding.
4. Next, wind the lever while lightly holding the rewinding crank. When resistance is felt on the rewinding crank temporarily stop the operation.

5. Wind once more.
By repeating this process, it is possible to make any number of exposures on the same film surface. But the film counter will continue to advance with each exposure.
- * When making the rewinds, just make one turn of the rewinding button.

Filters

There are various types of 48 mm (for 50 mm F 1.8) and 58 mm (for 58 mm F 1.2) screw-in type filters used for special effects with black and white and color films.

FILTER FACTOR	TYPE	FILTER CHARACTERISTICS
1	UV (SL 39 · 3 C) for black & white and color	<ul style="list-style-type: none"> Absorbs only ultra-violet rays. Especially effective at seaside, high mountains where there is much ultra-violet rays. Recommended for use in color photography.
1.5	Y 1 (SY 44 · 2 C)	<ul style="list-style-type: none"> Increases contrast of black & white film. Enhances clouds, lightening the blue sky. Brightens red and yellow.
2	Y 3 (SY 50 · 2 C)	
3	O 1 (SO 56 · 2 C)	
6	R 1 (SR 60 · 2 C)	<ul style="list-style-type: none"> Darkens blue, increases yellow and red values perceptibly. Good for contrasts in distant landscapes.
3	G 1 (MG 55 C)	<ul style="list-style-type: none"> Makes strong contrasts. Renders day almost into night. May also be used with infrared film.
1	Skylight	<ul style="list-style-type: none"> Prevents red from turning radically into white. Lightens sky and face appropriately, and reflects the lightness of fresh greenery.
4	ND 4	
8	ND 8	
2	Color Conversion A	<ul style="list-style-type: none"> Acts to harmonize the blue sky and shade.
3	Color Conversion B	
		<ul style="list-style-type: none"> ND 4 reduces light volume by 1/4, ND 8 by 1/8. No effects on the reproduction of colors of color film.
		<ul style="list-style-type: none"> Color film filter for conversion of color temperature when photographing tungsten type film under sunlight.
		<ul style="list-style-type: none"> Color temperature conversion filter for use with daylight type film under tungsten light.

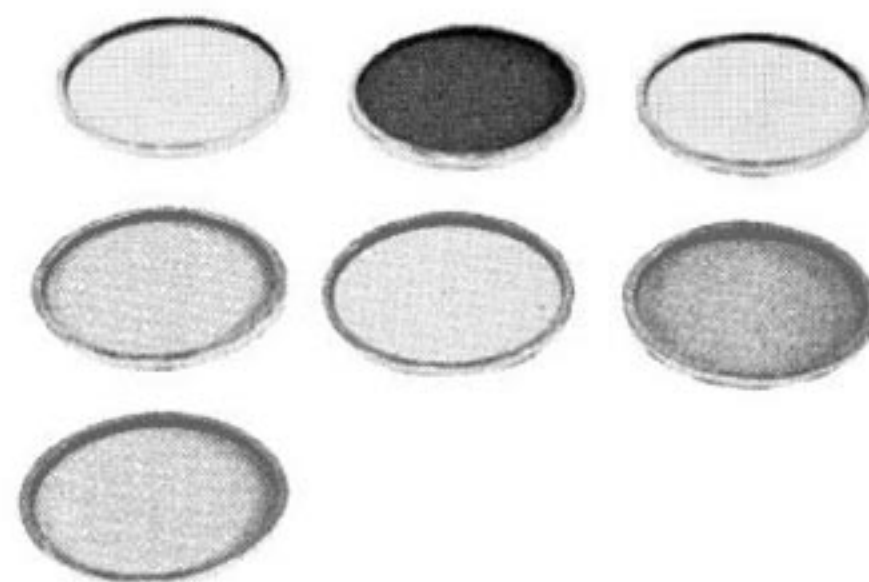

Filter Factor Correction

When using the filter, exposure must be adjusted by adding the filter factor.

Adjustment Method 1...

Changing the film speed

Divide the film speed by the filter factor. This numerical value is the sensitivity when using the filter. Accordingly, correct the film speed.

- Example: If the film speed is ASA 100 and the filter factor is 2, then it is $100 \div 2 = 50$. The film speed must be adjusted to ASA 50.

Adjustment Method 2...

Changing the exposure

After adjusting the exposure in the ordinary manner, adjust the lens aperture or shutter speed according to the filter factor.

- For example, the exposure is in a multiple relation, so that if the filter factor is 2, open the lens one stop. If the filter factor is 4, open the lens two stops.



Storage of Camera

Moisture and dust are harmful to your camera. It should be taken out into the fresh air from time to time.

If your camera is to be stored for a long time, it should be removed from its case. Silica gel or another drying agent should be placed alongside it.

Cleaning of the Camera

When you use your camera on a rainy day, or at the beach, moisture and salt air adhere to it,

which can result in stains, rust, and corrosion. Use a soft brush to rid the body of dust and a dry soft cloth for wiping. Do not touch the lens. Use a blower with a rubber ball to blow away dust on the lens or brush lightly with a brush. If you should inadvertently get a fingerprint on your lens and a blower or brush does not remove it, follow this procedure: use a little pure alcohol, or ether, if available on special lens tissue. Then wrap the tissue around a wooden matchstick and wipe the lens in a circular motion...lightly and systematically.

Never wipe the lens roughly. **Be very careful not to touch the mirror.**

In case the camera is accidentally dropped into sea water, promptly wash in pure water, wipe thoroughly and have cleaned IMMEDIATELY by a repair shop. Undue delay will cause irreparable damage and corrosion.

In extremely cold areas, expose the camera to the outer air only when in use. Put it back immediately after use. When using, expose the

camera gradually to the outer air to prevent the lens from clouding.

Interchangeable Lenses



A wide range of interchangeable lenses from 19 mm F 3.5 to 1000 mm F 11 are available to further enhance your Canon FX.

Interchangeable Lenses

FL 19 mm	F 3.5 (Manual)	R 300 mm	F 4
FL 35 mm	F 2.5	R 400 mm	F 4.5
FL 50 mm	F 1.8	R 600 mm	F 5.6
FL 58 mm	F 1.2	R 800 mm	F 8
FL 85 mm	F 1.8	R 1000 mm	F 11
FL 100 mm	F 3.5		
FL 135 mm	F 2.5		
FL 200 mm	F 3.5		

Interchangeable Lenses



Canon Zoom Lens FL 55mm-135mm F3.5

Canon Zoom Lens FL 55 mm-135 mm F 3.5

The new Canon Zoom Lens FL 55 mm-135 mm F 3.5 with zooming ratio of 2.5X is a high performance zoom lens with fully automatic pre-set type diaphragm designed specially for the owners of Canon FX.

Canon Zoom Lens FL 85 mm-300 mm F 5

The new exciting zoom lens to Canon single lens reflex cameras.

Accessories

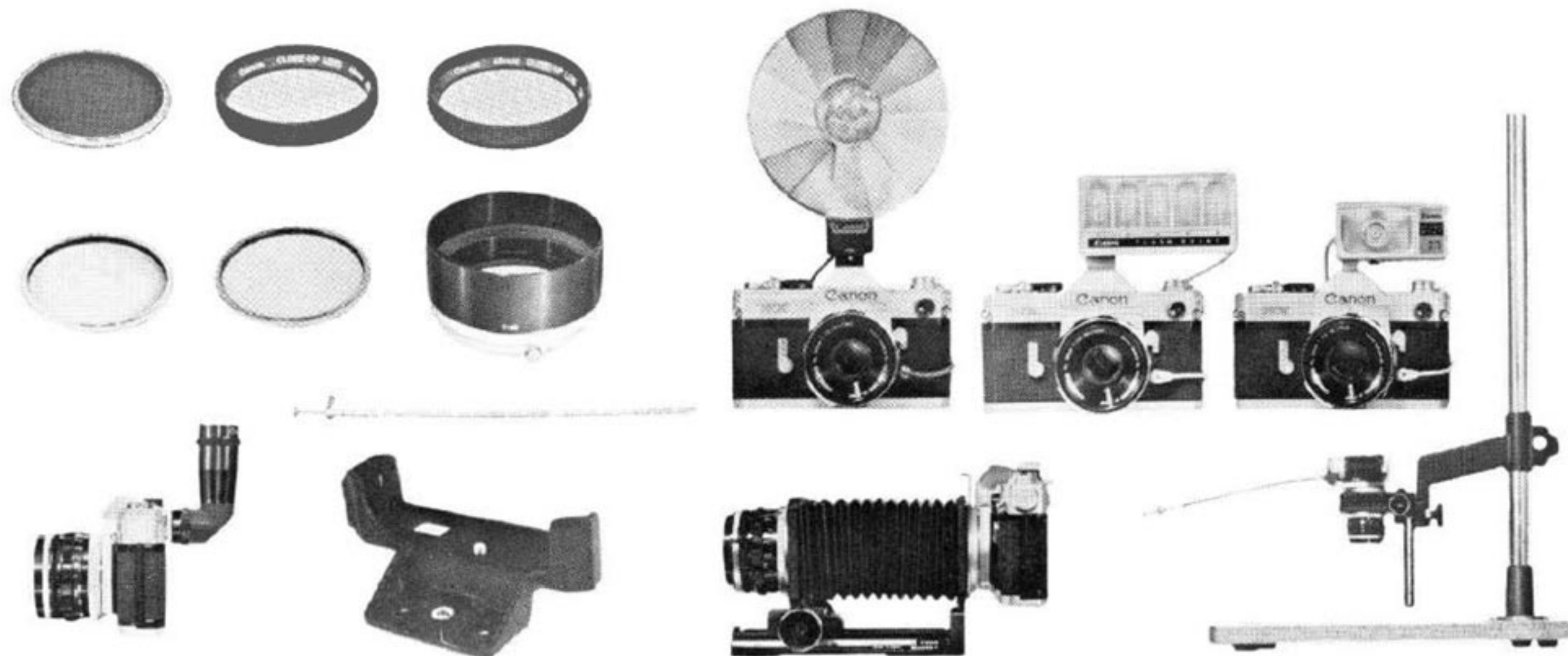

- Bellows R
- Filters
 - { 48 mm screw-in type filters { for black & white
for color
 - { 58 mm screw-in type filters { for black & white
for color
- Waist-Level Viewer 2
- Lens Hood
- Flash Unit J-2, J-3, V-3
- Flash Quint
- Copy Stand 3F
- Close-up Lens 48 mm
58 mm
- Camera Holder R4
- Canon Release
- Speedlite 100

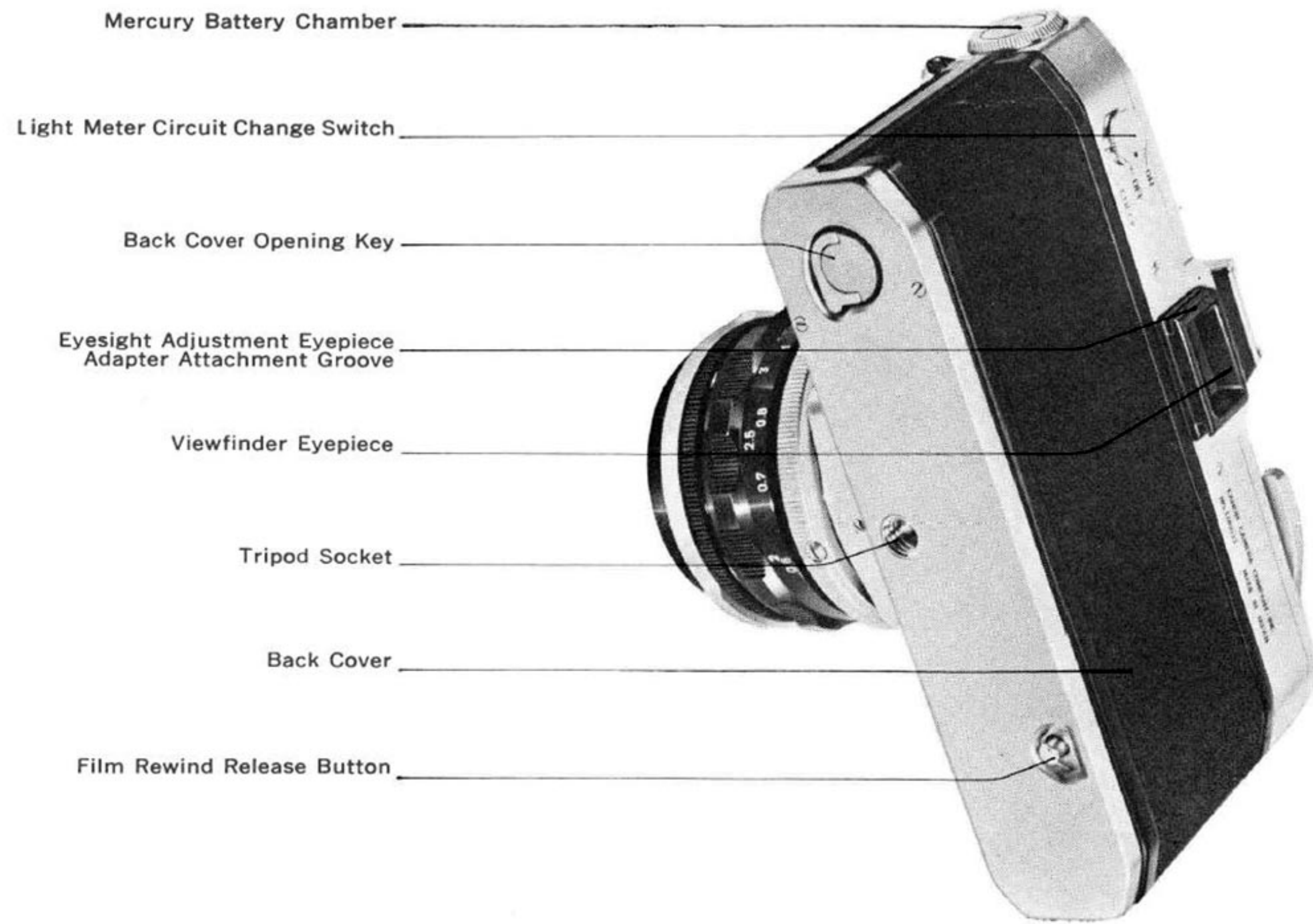

Mercury Battery Chamber

Light Meter Circuit Change Switch

Back Cover Opening Key

Eyesight Adjustment Eyepiece
Adapter Attachment Groove

Viewfinder Eyepiece

Tripod Socket

Back Cover

Film Rewind Release Button