

Canon

CANON INC. 9-9, Ginza 5-chome, Chuo-ku, Tokyo 104, Japan

U.S.A.
NEW YORK — **CANON U.S.A., INC.**
10 Nevada Drive, Lake Success, Long Island, N.Y. 11040, U.S.A.

MANHATTAN — **CANON U.S.A., INC.**
600 Third Avenue, New York, N.Y. 10016, U.S.A.

CHICAGO — **CANON U.S.A., INC.**
457 Fullerton Avenue, Elmhurst, Illinois 60126, U.S.A.

LOS ANGELES — **CANON OPTICS & BUSINESS MACHINES CO., INC.**
3113 Wilshire Blvd., Los Angeles, California 90010, U.S.A.

CANADA
TORONTO — **CANON OPTICS & BUSINESS MACHINES CANADA LTD.**
3245 American Drive, Mississauga, Ontario, Canada

EUROPE, AFRICA
& MIDDLE EAST
AMSTERDAM — **CANON AMSTERDAM N.V.**
Gebouw 70, Schiphol, Oost, Holland

CENTRAL &
SOUTH AMERICA
PANAMA — **CANON LATIN AMERICA, INC.**
Apartado 7022, Panamá 5, Panamá

INSTRUCTIONS

Canon TLb



We are highly gratified that you have selected the Canon TLb—a wise choice that promises you many delightful years of photographic experiences. Canon is recognized the world over as the foremost pioneer in the development of photographic equipment of the highest quality and performance. Whether your new TLb is for the home or for traveling, make the most of your opportunities!

Before Using . . .

Please read this instruction booklet carefully, and master the manipulations of the various parts of the TLb completely. Once thoroughly versed in the correct handling of this camera, you can use the Canon TLb to the fullest extent of its capabilities.

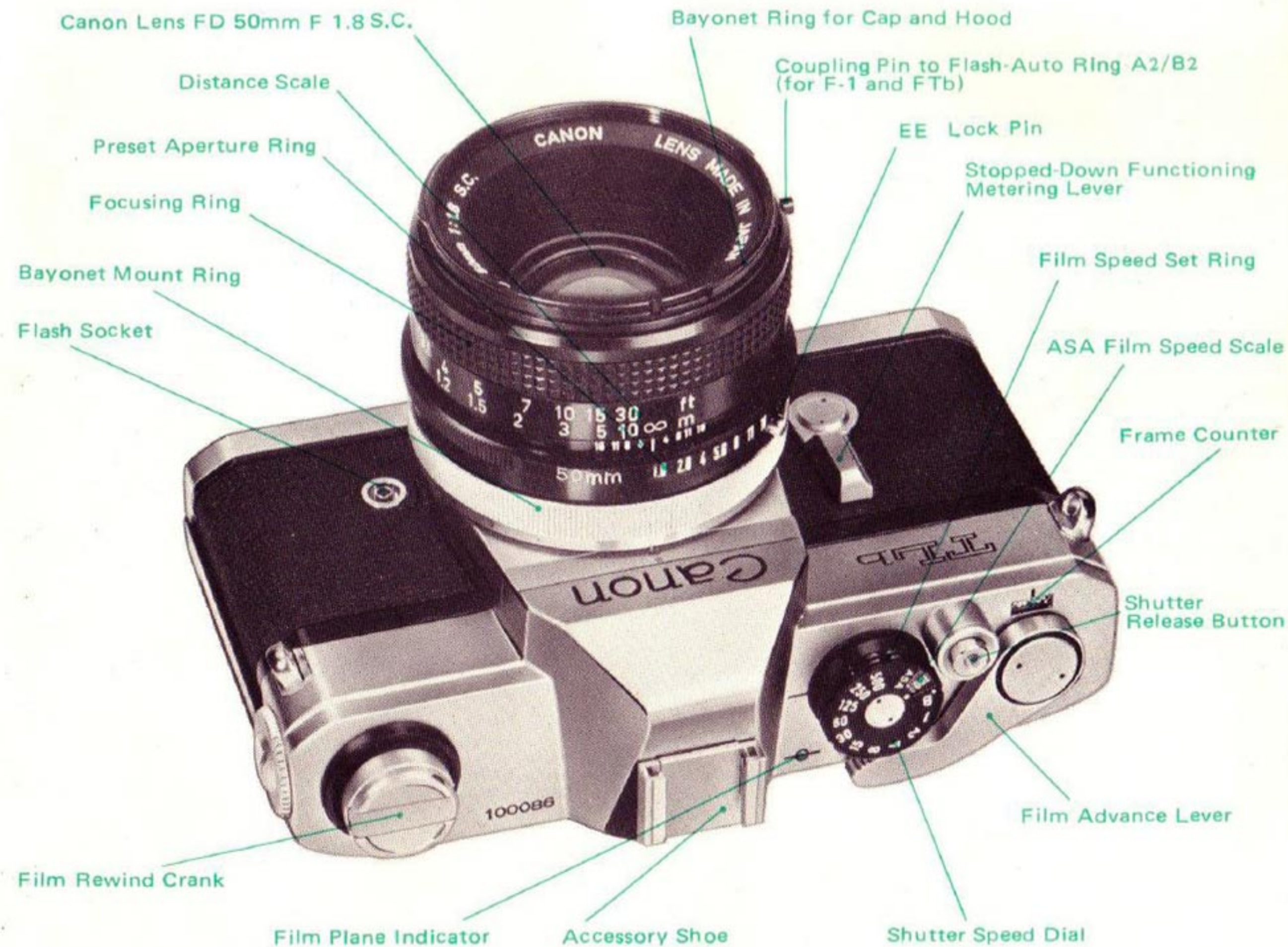



Contents

Technical Data	8
Loading Mercury Battery	10
Film Winding	11
Shutter and Aperture Adjustment	13
Using Built-in Exposure Meter	17
Exposure Settings	19
Coupling Range of Built-in Exposure Meter	22
Viewing and Focusing	23
Holding the Camera	25
Film Loading	27
Film Rewinding	30
Synchronizing Flash Unit	31
Changing Lenses	32
Double Exposures	37
Filters	38
Interchangeable Lenses and Accessories	39
Proper Care of the Camera	43

Follow these simple steps for normal photography:

1 Load the film. (See page 27.)

2 Set the ASA film speed. (See page 18.)

3 Wind the film advance lever. (See page 27-28.)

4 Remove the lens cap.

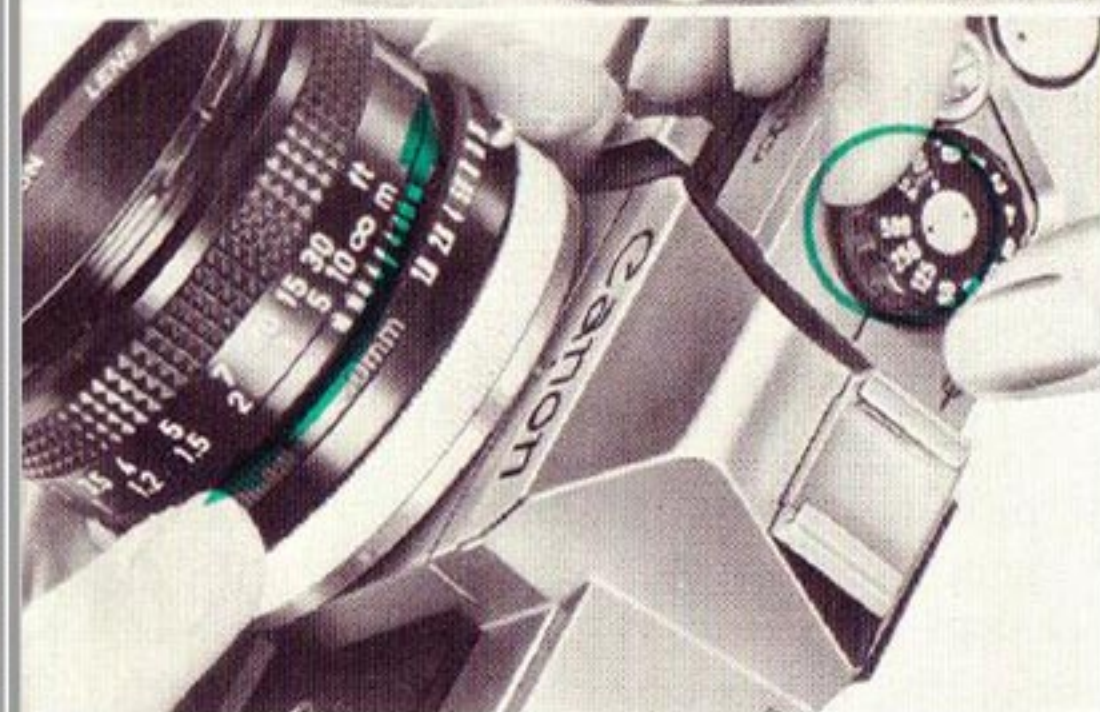
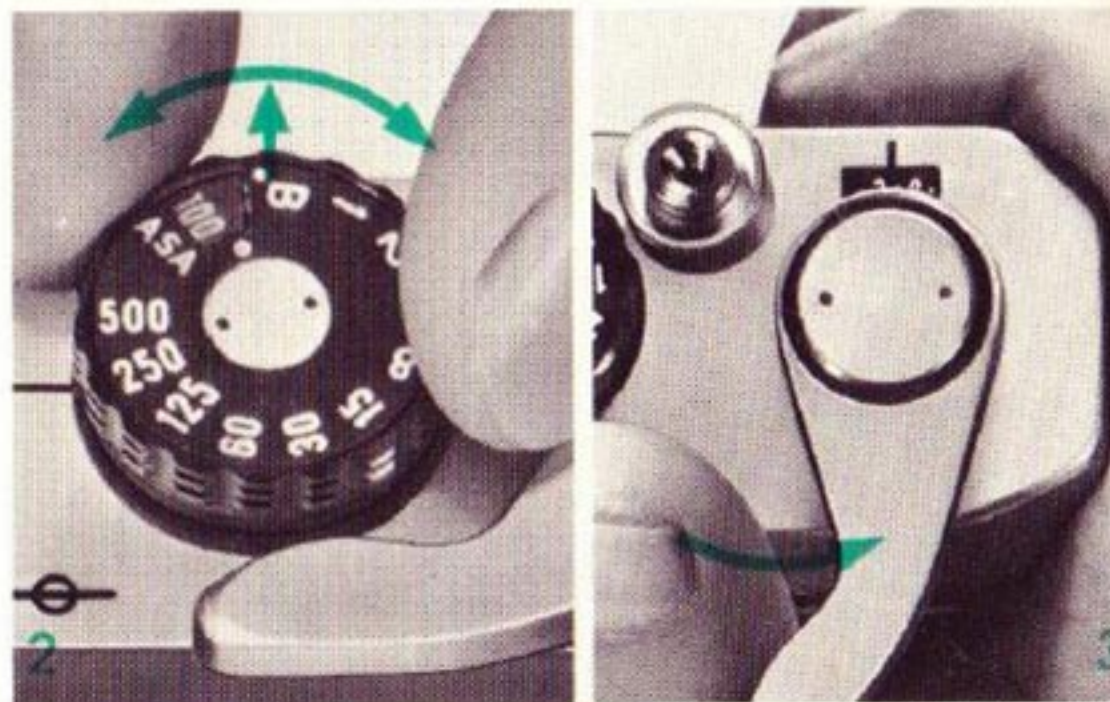
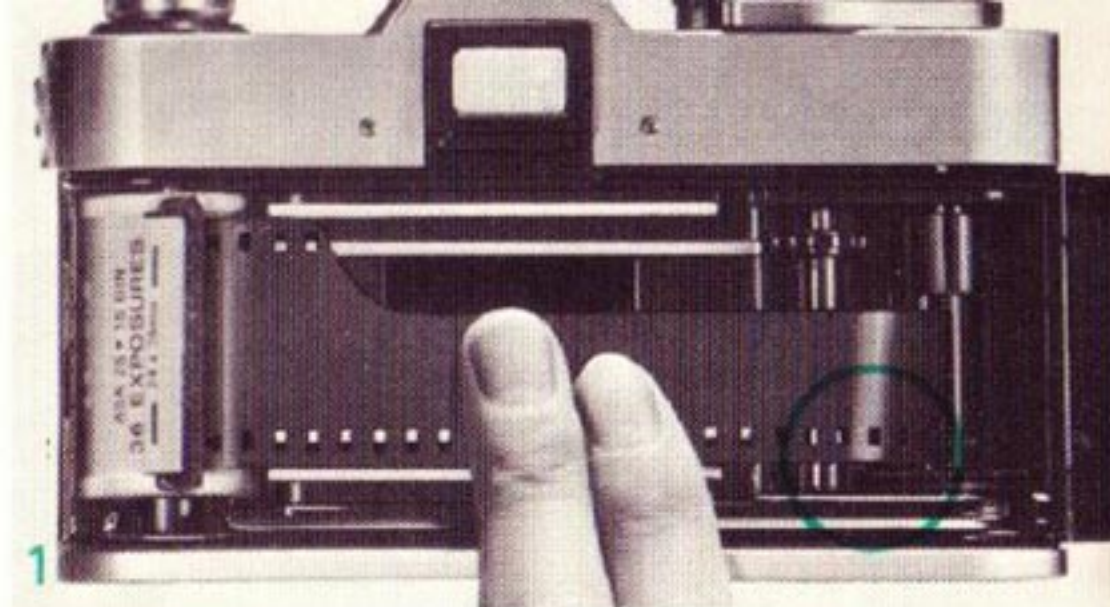

5 Look through the viewfinder and focus. (See page 23.)

6 Determine the exposure by adjusting the shutter speed dial and the preset aperture ring. (See page 13.)



7 Compose the picture.

8 Press the shutter release button gently.

Technical Data

- Type: 35mm single-lens reflex camera with focal plane shutter. Picture size; 24x36mm.
- Standard Lens: Canon FD 50mm F1.8 S.C.
- Interchangeable Lenses: Canon FD series lenses for full aperture metering and FL series lenses for stopped-down metering.
- Viewfinder: Eye-level type using pentagonal prism.
- Viewfinder Attachments: Angle Finder A2, B, Magnifier S, Rectangular Type Dioptric Adjustment Lenses (Standard—1.2 diopter. Interchangeable with + 1.5, 0, -2.5, and -4.)
- Focusing Screen: Microprism screen rangefinder using Fresnel lens.
- Field-of-View: 94% of actual picture area. 0.85x with standard 50mm lens at infinity.
- Viewfinder Information: Meter needle and aperture needle, red signal indicating outside lower side of meter coupling range, meter index for stopped-down metering and coupling range limit marks.
- Mirror: Shockless quick return system.
- Lens Mount: Bayonet type FD mount. FL and R series of lenses mountable.
- Coupling Function of Lenses: FD lenses; full aperture metering, coupled with automatic diaphragm. FL lenses; stopped-down metering, coupled with automatic diaphragm. R lenses; stopped-down metering, manually operated diaphragm.
- Shutter: Focal plane shutter with speeds from 1/500 to 1 sec. and B. Multiple series. Equiinterval index. X contact at "60".
- Shutter Speed Dial: Single shaft non-revolving type with shutter speed scales and ASA film speed scales.
- Film Speed Scale: ASA 25-2000.
- Exposure Meter: Built in. Coupled to shutter speeds, film speeds and f/stop. Matching needle type full-aperture metering mechanism through the lens. Center-directed average

light metering system using CdS photocell behind the pentaprism. Full aperture opening f/stop automatic compensation mechanism for the FD lenses. Stopped-down metering possible. Meter index type metering, using stopped-down functioning lever. Powered by one 1.3v M20 (#625) mercury battery.

- Exposure Meter Coupling Range: When using FD 50mm F1.8 S.C. with ASA 100 film, EV3.7(f/1.8 at 1/4 sec.)-EV 17 (f/16 at 1/500 sec.).
- Flash Synchronization: FP and X contact. Automatic time lag adjusting type. Flash socket on front side of the body.
- Synchronizing Range: FP class; 1/500-1/125 sec., 1/30 sec. or under. Speedlite; 1/60 sec. or under. M, MF class; 1/30 sec. or under.
- Film Loading: By opening back cover. Accepts any standard 35mm film roll in cartridge. Easy and rapid loading with the multi-slitted film spool.
- Film Advance Lever: Single operation 174°. Short-stroke winding possible.
- Film Rewinding: Performed by rewind button and crank.
- Double Exposures: Possible by operating film rewind button and crank.
- Frame Counter: Self-resetting type activated by opening back cover.
- Size: 144 x 93 x 43mm (5-5/8" x 3-5/8" x 1-3/4").
- Weight: 680g. (1.32 lbs.)—body only.

Subject to alterations.

"Spectra Coating" and "Super Spectra Coating" shall be abbreviated as "S.C." and "S.S.C." respectively.

Loading Mercury Battery

The built-in exposure meter of the Canon TLb functions only when the mercury battery is properly loaded.

- 1 Insert a coin into the groove of the battery compartment cover and turn it to the left to remove.
- 2 Face the central contact (⊖) of the mercury battery inwards and insert.
- 3 Replace the cover by turning it to the right. Be sure to insert the battery in the correct direction by referring to the diagram on the compartment cover. Otherwise, the cover cannot be properly screwed in.
- 4 Before inserting, wipe off the fingerprints or stains from the battery poles with a dry cloth. Otherwise, the meter may not function due to imperfect contact, and dirty poles may cause corrosion and damage the contact points of the camera.
- 5 A 1.3v M20 (#625) mercury battery should be used—equivalent to Mallory PX-625, Eveready EPX-625. Life of the battery in normal use is approximately one year.
- 6 When the camera is not to be used for a long period, remove the mercury battery and keep the camera in a dry place.
- 7 After passing one year, replace the battery even not in use.

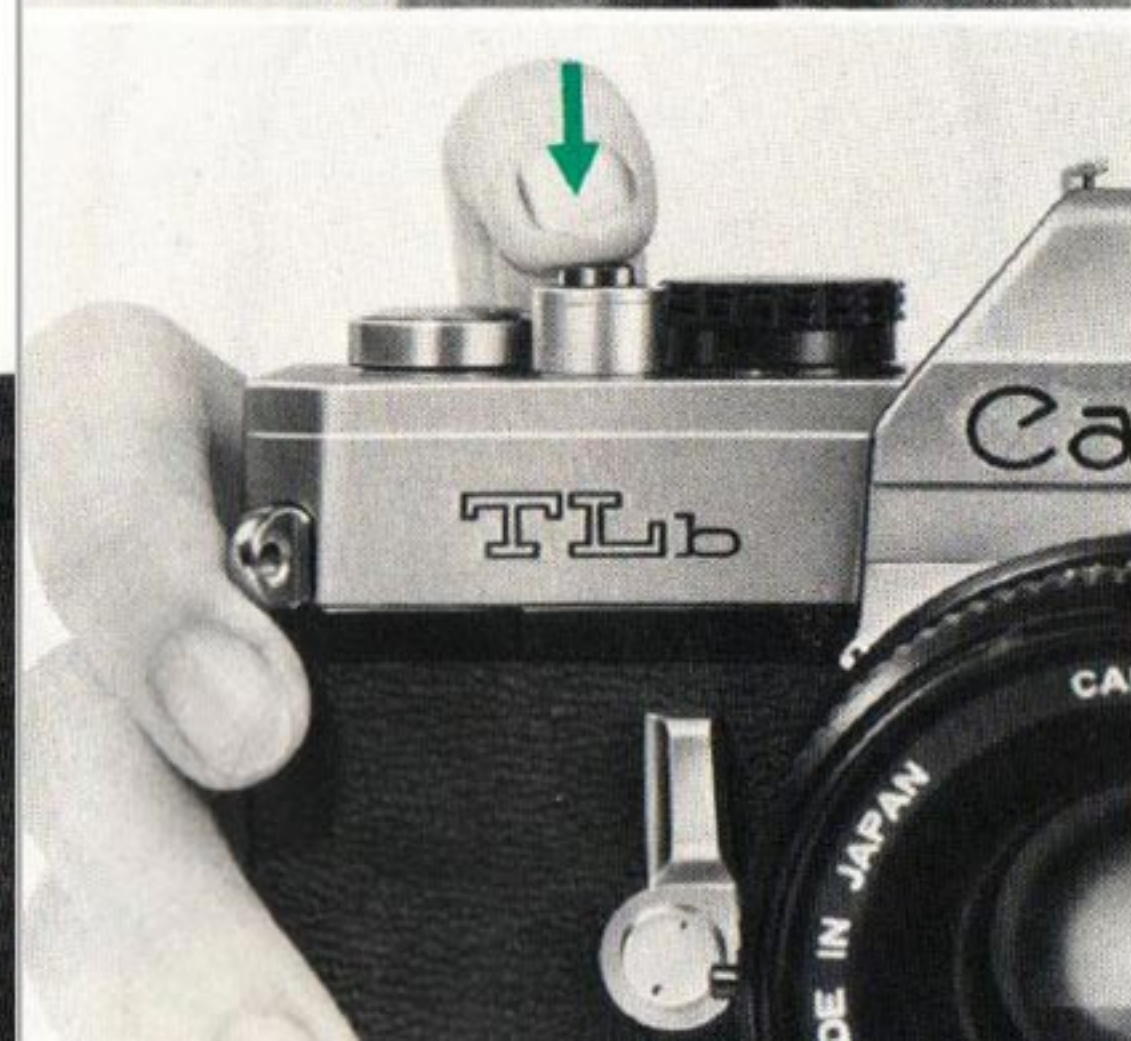
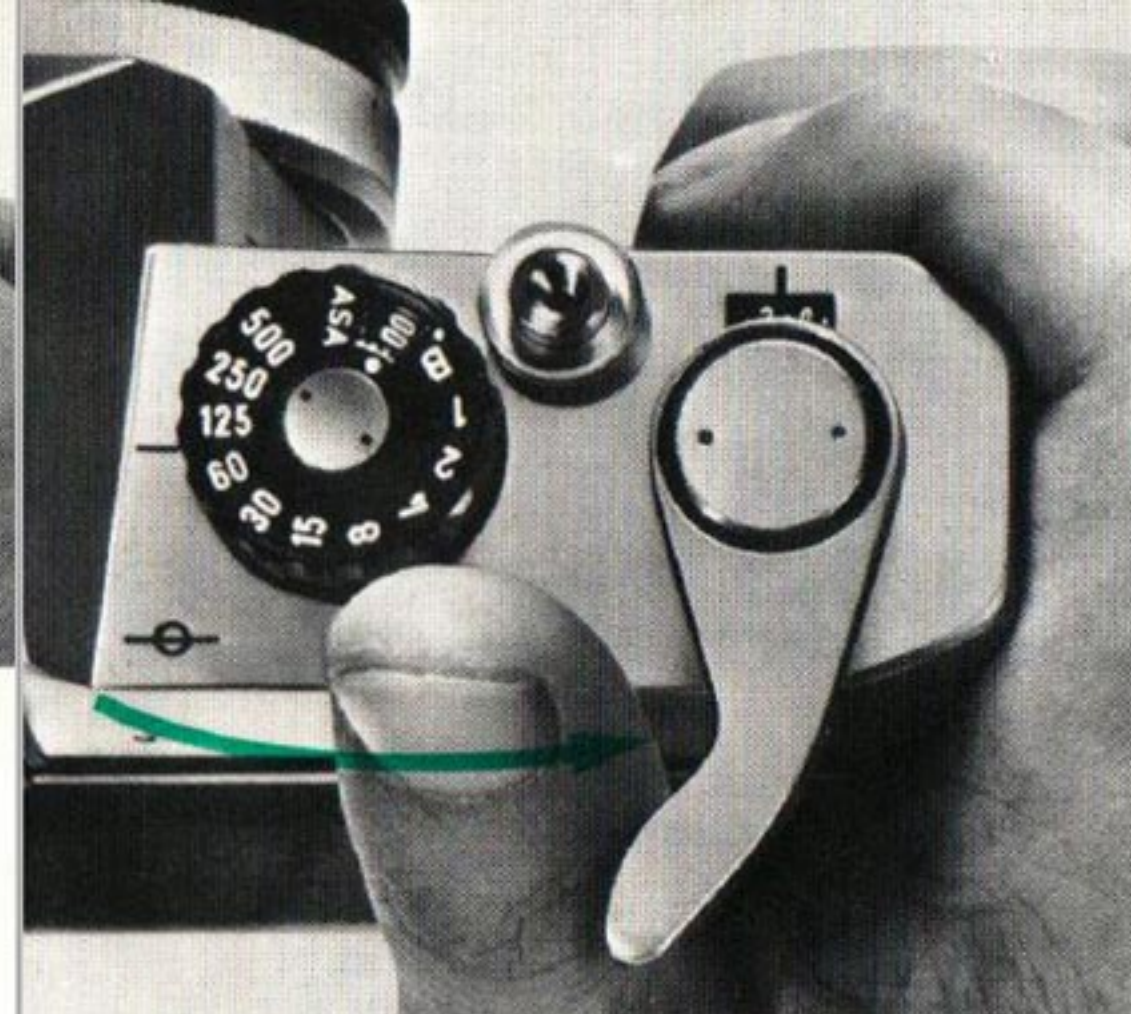

Film Winding

The film advance lever winds the film, cocks the shutter, and prepares the aperture and mirror for the next shutter release all in one motion.

- 1 Turn the film advance lever until it stops. The film will be advanced one frame and the shutter cocked. The frame counter is simultaneously advanced to the next number.
- 2 When the shutter release button is pressed, the mirror flips up, the diaphragm simultaneously closes down to the preset f/stop and the shutter operates. After the shutter is operated, the advance lever can be wound for the next frame.
 - Winding may be done by moving the lever with several short strokes.
 - After loading the film, make another wind, because the first winding may not be complete.
 - The shutter will not function when pressing the shutter release button unless winding is completed. In such a case, check the winding once more.

Frame Counter

Each winding will advance the number of the frame counter, indicating the number of pictures taken. When the back cover is opened, the counter automatically returns to starting position "S".

Attaching the Cable Release

Optional Canon Release can be attached to the TLb by screwing it into the threaded hole in the center of the shutter release button. The use of a cable release is recommended when the camera is attached to a tripod both for long time-exposure photography and tele-photography. Moreover, it is very convenient for copy work together with a tripod or copy stand.

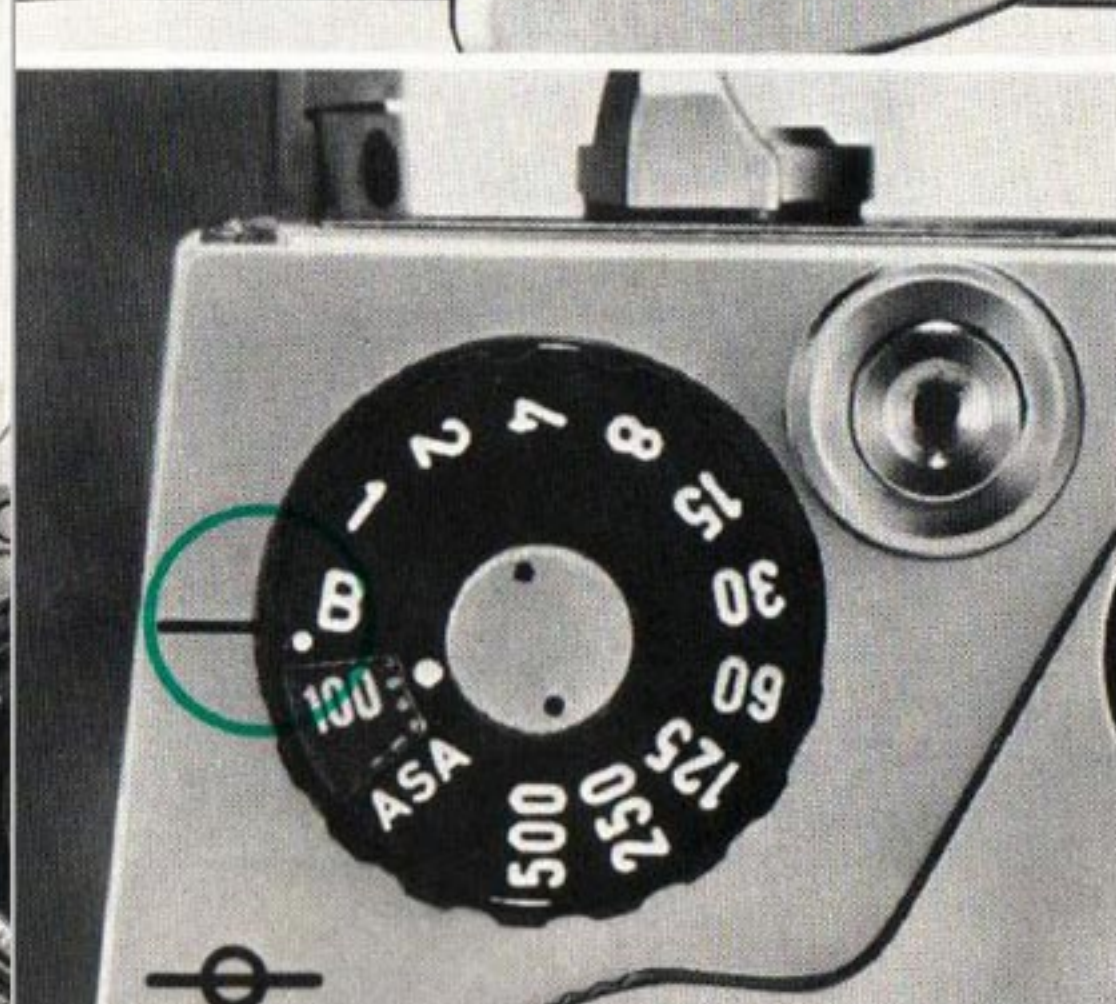
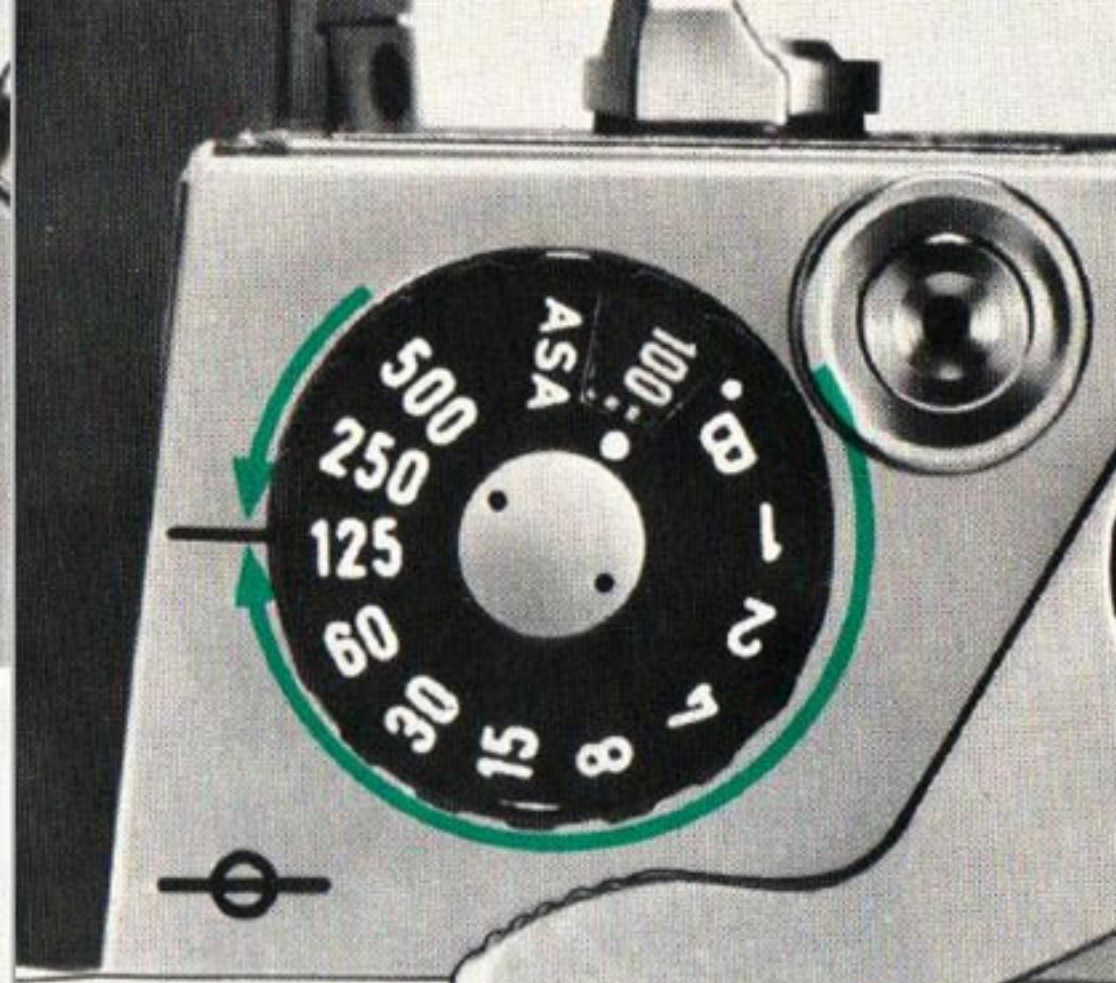
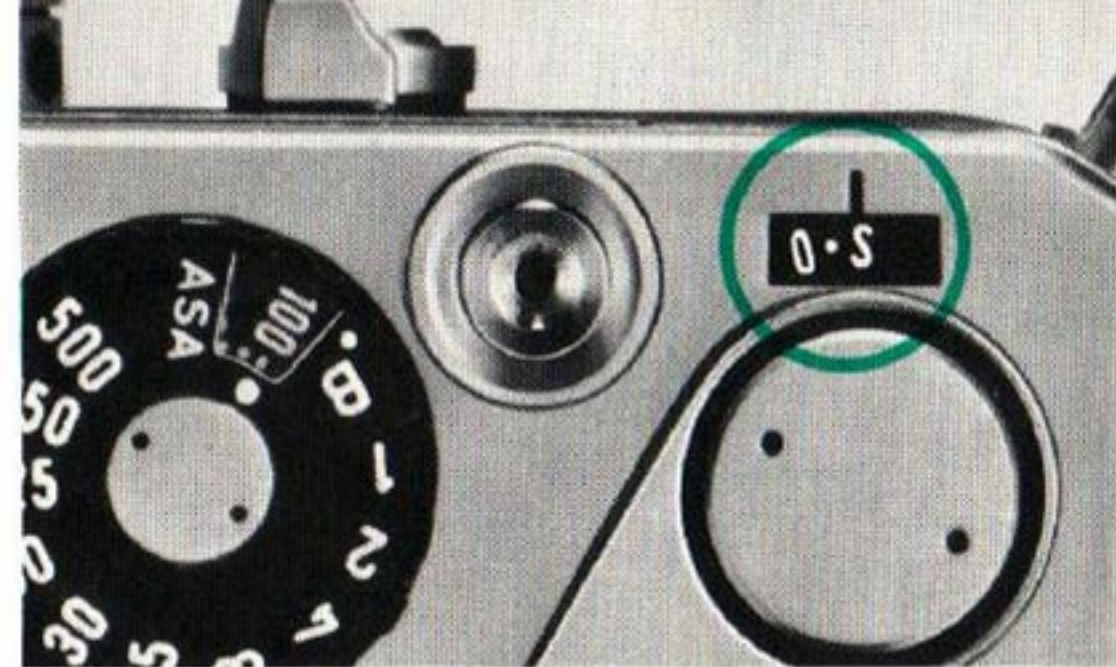

Shutter and Aperture Adjustment

Exposures are adjusted by the shutter and aperture. The shutter controls the exposure time and the aperture controls the amount of incoming light. The Canon TLb uses a matching needle metering system, a very simple method of obtaining proper exposures.

Shutter Speed Dial

Adjust the shutter speed by turning the shutter speed dial to the desired index number. The index on the dial shows the denominators of 1/500 sec., 1/250 sec., etc.

- The shutter speed dial does not revolve between indexes "500" and "B".
- Be sure to set the index at a position where the clickstop catches. In case of "B" index, adjust it to the white dot just below the "B" index.
- "B" indicates bulb exposure, and is used when making exposures of more than one second. When the shutter speed dial is set at "B", the shutter remains open as long as the shutter release button is pressed.
- When time exposure is necessary to make an exposure over an extended time, use the lockable cable release.
- The "60" index is also used for synchronizing an electronic flash unit such as Canon Speedlite. Then it is

equivalent to a very short exposure time during the flash of the flash unit.

Aperture

The aperture is set by turning the preset aperture ring to the desired f/stop.

■ As the f/stop number gets larger, the amount of light reaching the film plane becomes correspondingly less. For each f/stop up, the light is reduced one-half. Accordingly, when the aperture is increased by one f/stop, the exposure is doubled, and when it is increased by two f/stops the exposure is quadrupled.

■ Certain lenses, however, have no relation to the brightness halved between the full aperture opening and the stopped-down f/stop by one scale on the preset aperture ring.

■ The ratio between the aperture and the amount of exposure, using f/2 as the basis, is as follows:

f/stop:

1.2 1.4 1.8 2 2.8 3.5 4 5.6 8 11 16 22

Exposure Ratio:

3 2 1.25 1 1/2 1/3 1/4 1/8 1/16 1/32 1/64 1/128

■ The preset aperture ring can also be set between two f/stops.



FD 50mm F 1.8 S.C.



Manual Lock Lever

Automatic/Manual Aperture Lever

Automatic Control of Aperture

In the case of the FD or FL lens, the field-of-view can always be seen through the viewfinder at full aperture opening even after the f/stop has been set with the preset aperture ring. Set the desired f/stop on the preset aperture ring to the index. The diaphragm will close down to the preset f/stop only for the instant that the shutter is released. Except for that instant, the diaphragm remains fully open.

Manual Control of Aperture

1 By pressing the stopped-down functioning lever and turning the preset aperture ring, the diaphragm can be closed down to any f/stop and the depth-of-field at the time of shutter release can be checked. When the lever is reset to its original position, the diaphragm again returns to maximum opening.

■ The aperture is manually stopped down also when performing close-up photography and macrophotography.

2 When an accessory such as Extension Tube M is used between the lens and the camera body, turn the automatic aperture lever of the lens counterclockwise all the way and set the manual lock lever at "L" position before mounting the lens. This manual lock lever locks the automatic aperture lever and the diaphragm can be opened or closed by turning the preset aperture ring. For releasing the lever, return the manual lock lever to the original position (white dot).

With the use of this lock, photography using manually operated aperture can also be performed on Canon single-lens reflex cameras like FX besides the TLb, FTb, FT QL and F-1. But do not use it together with Canonflex R, RP, RM and R2000.

- The preset aperture ring cannot be set at the green mark (circle) when the FD lens is attached to the TLb.
- Refer to page 35 concerning depth-of-field.

When an FD lens except the FD 50mm F1.8S.C. is used and manual control of aperture is required, turn the automatic/manual aperture lever of the lens counterclockwise until it is automatically locked. The aperture can be opened or closed by turning the preset aperture ring. For releasing the lever, turn it clockwise.

When using the lens attached reversely to the macrophoto coupler for duplicating photography, macrophotography, etc., set the automatic aperture lever of the lens in the position for manual operation, attach the macrohood of the macrophoto coupler to the mounting section of the lens, and turn the bayonet ring until it locks.

Relationship Between the Shutter, Diaphragm, and Mirror

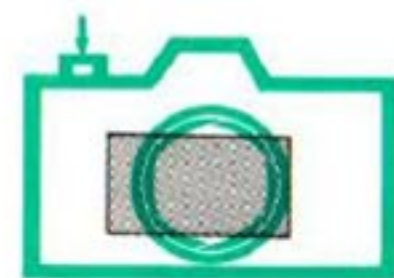

Press the shutter release button.



Mirror begins to snap up.



The shutter clicks. The diaphragm closes down to preset f/stop.



Mirror is up.



The diaphragm returns to maximum opening.



Mirror returns to former position.

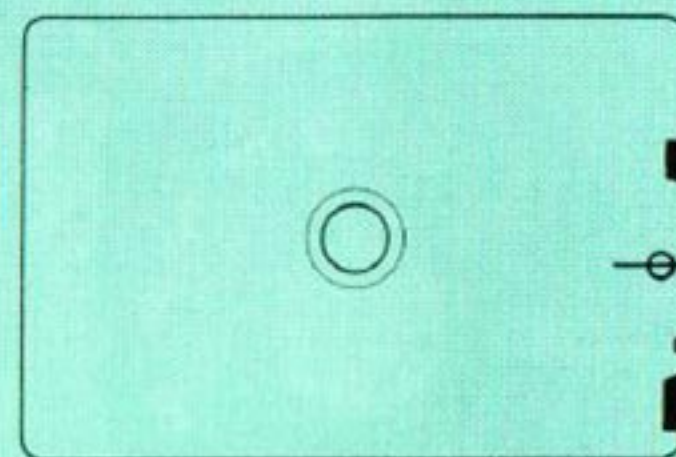
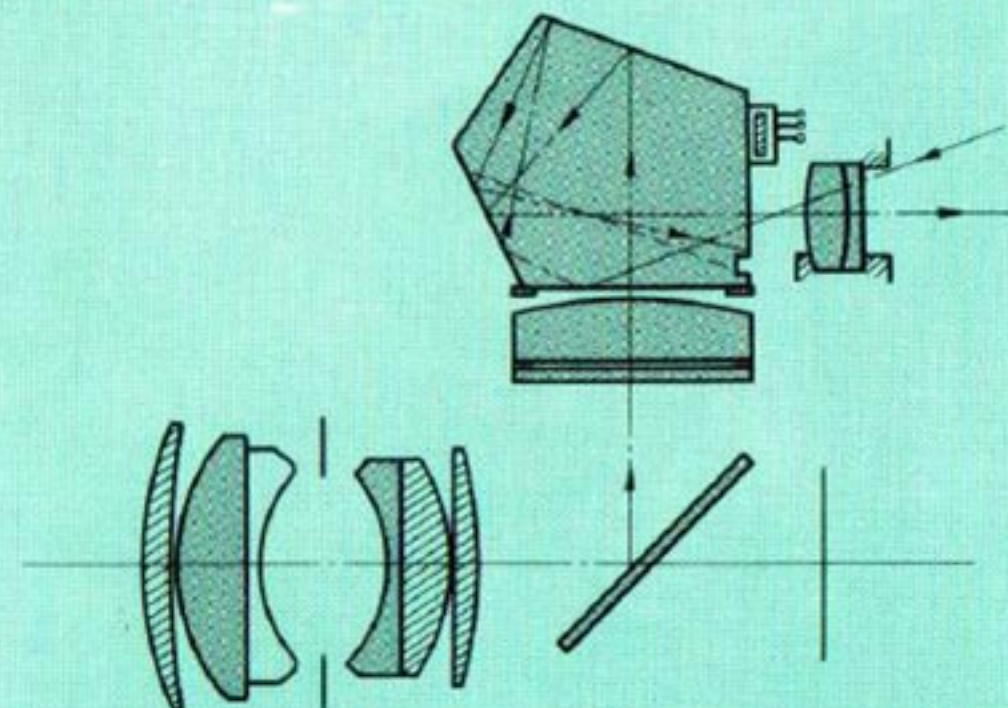

Using Built-in Exposure Meter

Canon TLb provides the most accurate light measurement possible with its unique TTL (Through-The-Lens) system. The built-in exposure meter, which is of matching needle type, is coupled to the ASA film speed scale, shutter speed dial and preset aperture ring.

The CdS photocell of the exposure meter is located on the upper position of the eye piece and in the rear of the pentagonal prism. The center-directed light metering system enables accurate measurement of the main subject even in counterlight.

■ The correction of the full aperture opening of the lens is performed automatically. Therefore, the operation does not change regardless of the speed of the lens used. An FL lens can be used only with stopped-down metering.

■ Due to the characteristics of the CdS photocell, the movement of the meter needle may occasionally become slack, owing to changes in the degree of light.

■ Metering at "B" on the shutter speed dial is not possible with the built-in exposure meter, because "B" is used for long exposures over one second.

■ Always use a lens hood when shooting against the light.

Film Speed Setting

Set the ASA film speed scale to the speed of the film being used. Film speeds are normally shown on the film box cover and/or explanatory sheet.

Lift and turn the film speed set ring around the shutter speed dial. If the film is ASA 100, for example, make the correct setting by showing "100" in the small window.

■ The following film speeds may be used:

	(32)(40)	(64)(80)	(125)(160)	(250)(320)
ASA 25	: : 50	: : 100	: : 200	: :
DIN 15	: : 18	: : 21	: : 24	: :
	(16)(17)	(19)(20)	(22) (23)	(25) (26)
	(500)(640)	(1000)(1250)	(2000)	
400	: : 800	: : 1600	:	
27	: : 30	: : 33	:	
	(28) (29)	(31) (32)	(34)	

Figures in parentheses represent intermediate film speeds.

■ When "25" appears in the small window, this is as far as the film speed setting ring will turn to the left. The white dot at the right-turn extremity reads ASA 2000.

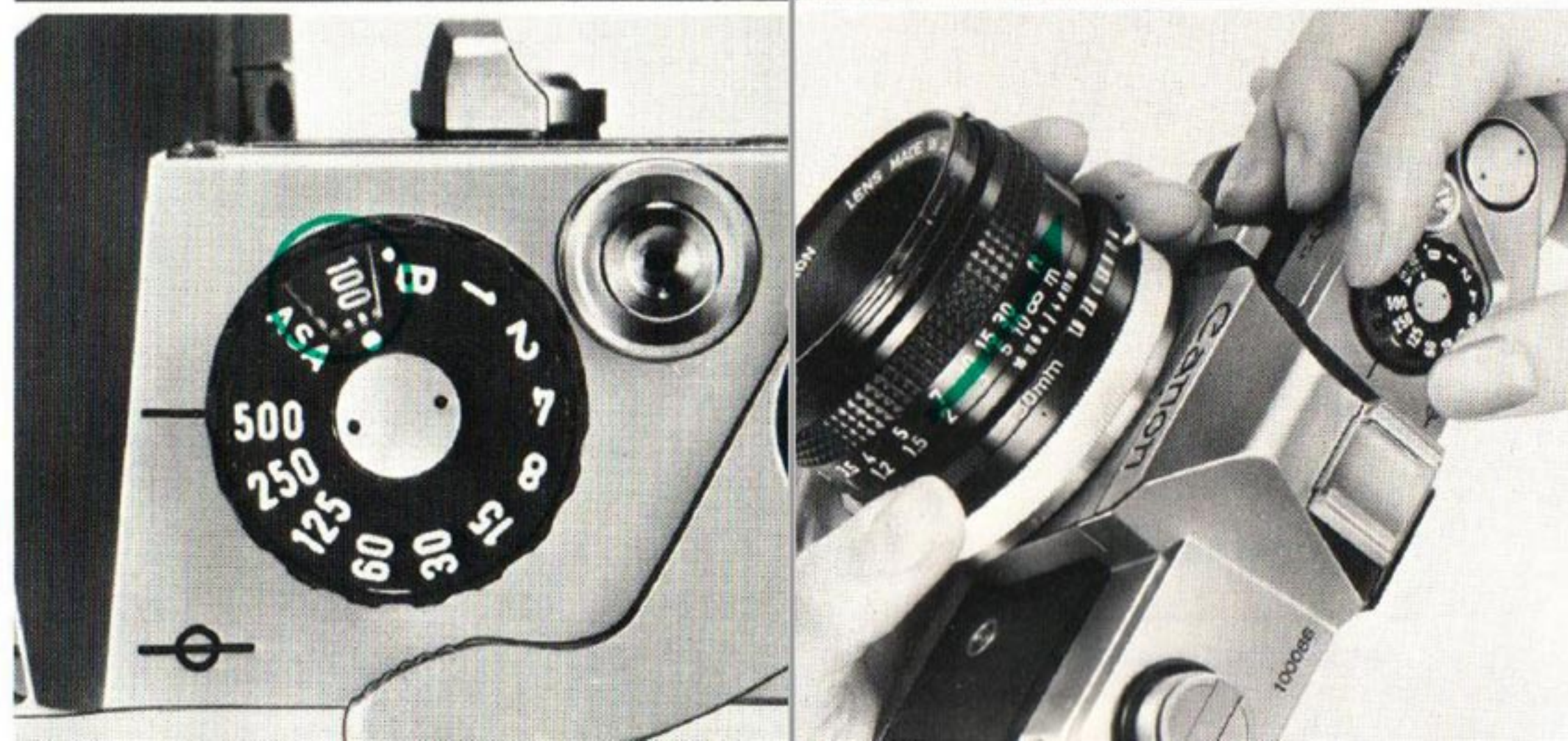
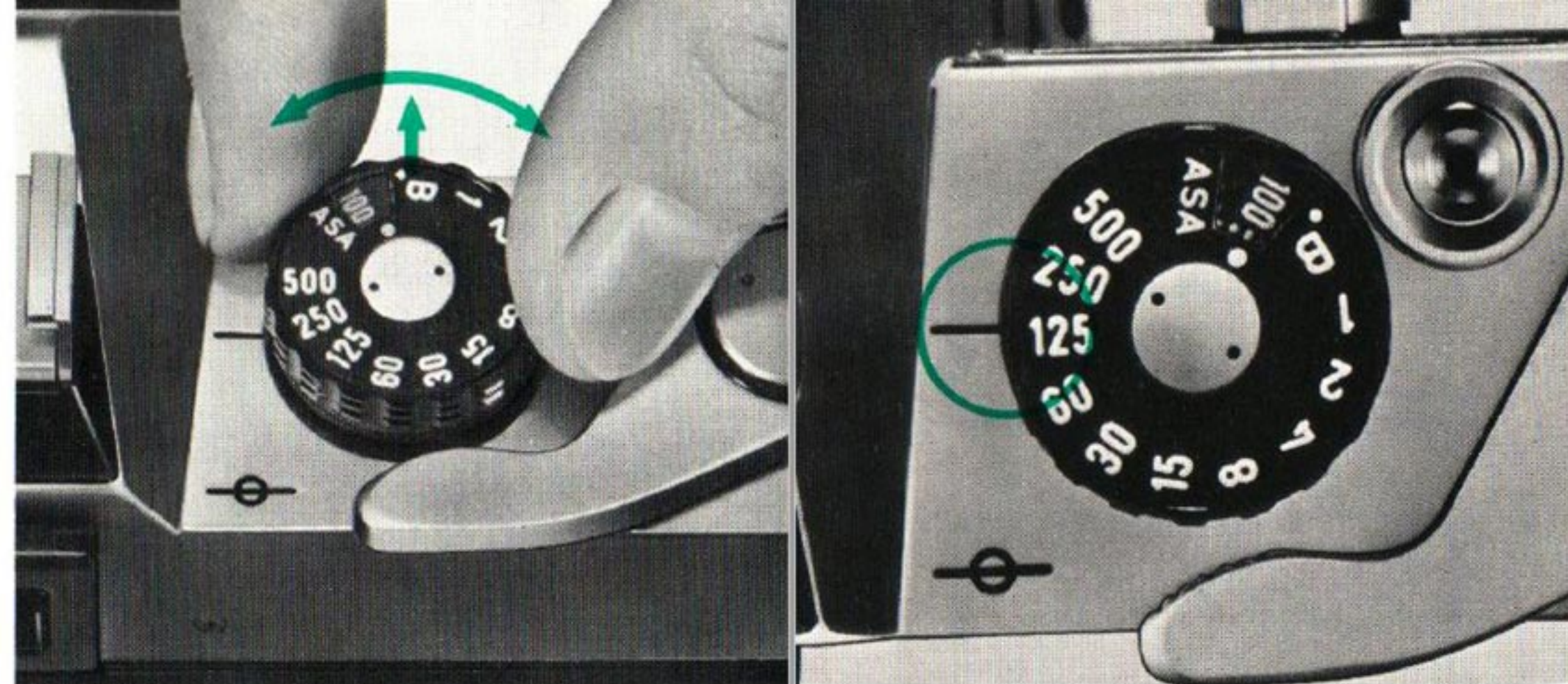

Exposure Settings

Full Aperture Metering

Full aperture metering can be performed with an FD lens which has an aperture signal lever and pin.

- 1 Set the shutter speed dial at the desired speed.
- 2 Face the camera towards the subject, look into the viewfinder, and check the position of the meter needle and aperture needle.

■ The meter needle is coupled to the film and shutter speeds, and moves vertically according to the brightness of the subject. The aperture needle, with a round circle, is coupled to the preset aperture ring of the FD lens.

- 3 Turn the preset aperture ring and align the aperture needle with the meter needle.

■ The green mark (circle) on the preset aperture ring is for Servo EE Finder with Canon F-1 use only.

■ In the case of f/stop priority, turn the shutter speed dial and align the meter needle with the aperture needle. Be sure to set the shutter speed dial at the click-stopped positions.

- 4 If the aperture needle does not align with the meter needle by turning the preset aperture ring, it means that the shutter speed is not properly set. In this case, align the two needles by turning the shutter speed dial.

- The moving range of the aperture needle inside the viewfinder changes according to the lens speed. And the aperture needle will not always move vertically the full length between the coupling limit marks. Then the shutter speed should be changed when the aperture needle cannot be aligned with the meter needle.

5 When the shutter is set on the high speed side, the meter needle moves downward. When it is set at a slower speed, the needle moves upward. When the shutter is set at a slow speed outside the meter coupling range, the meter needle swings all the way up and the red signal appears at the bottom of the viewfinder, and metering is not possible even if the f/stop is changed. When the red signal appears and metering cannot be performed, use a flash unit or high-speed film. Refer to "Coupling Range of Built-in Exposure Meter" on page 22.

- Select a faster shutter speed when the meter needle swings all the way up, and a slower speed when it swings all the way down.

- Since the shutter speed dial cannot be set at the intermediate positions, the shutter speed priority method is recommended when exposure accuracy is a crucial factor.

- In photography under counter-light condition, reduce film speed by one scale, or open the f/stop by one scale, after light metering.

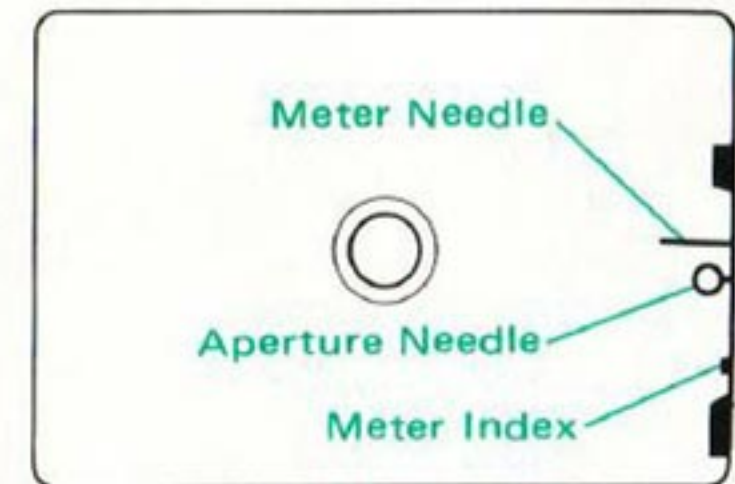

Meter Needle Moving Downward

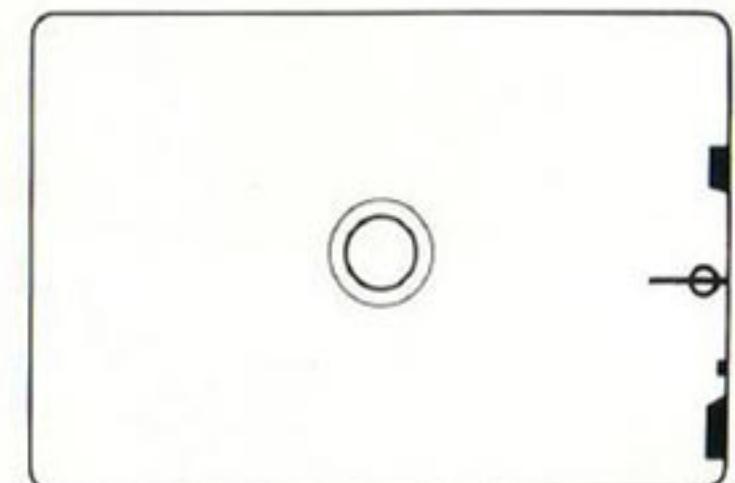

Correct Exposure

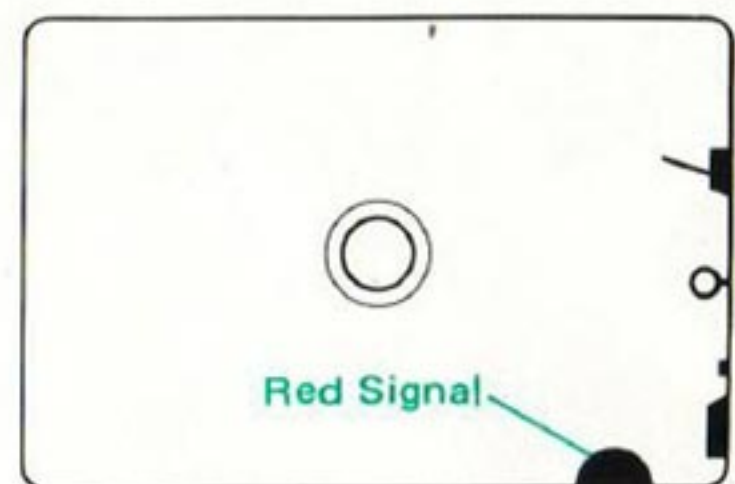

Outside the Coupling Range

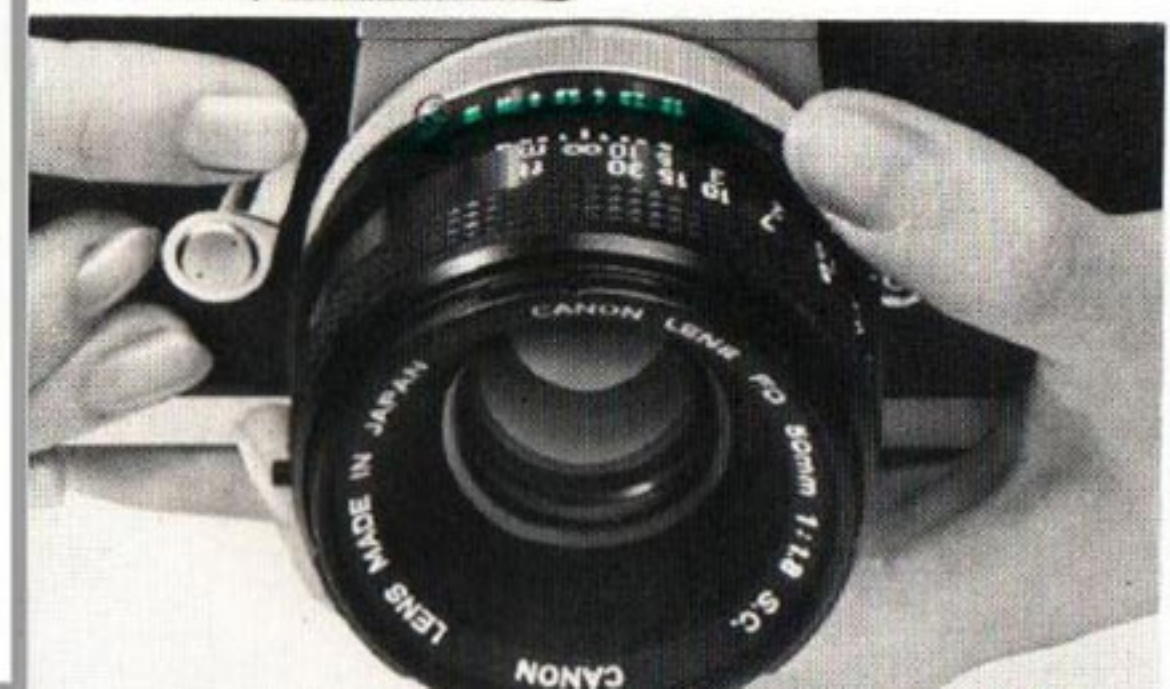
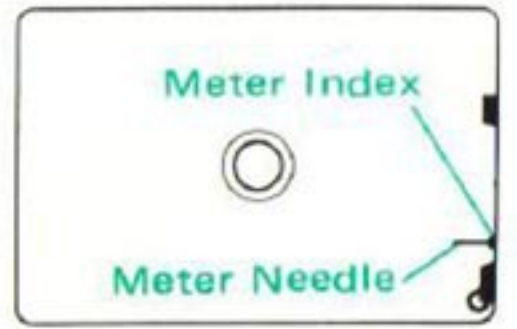
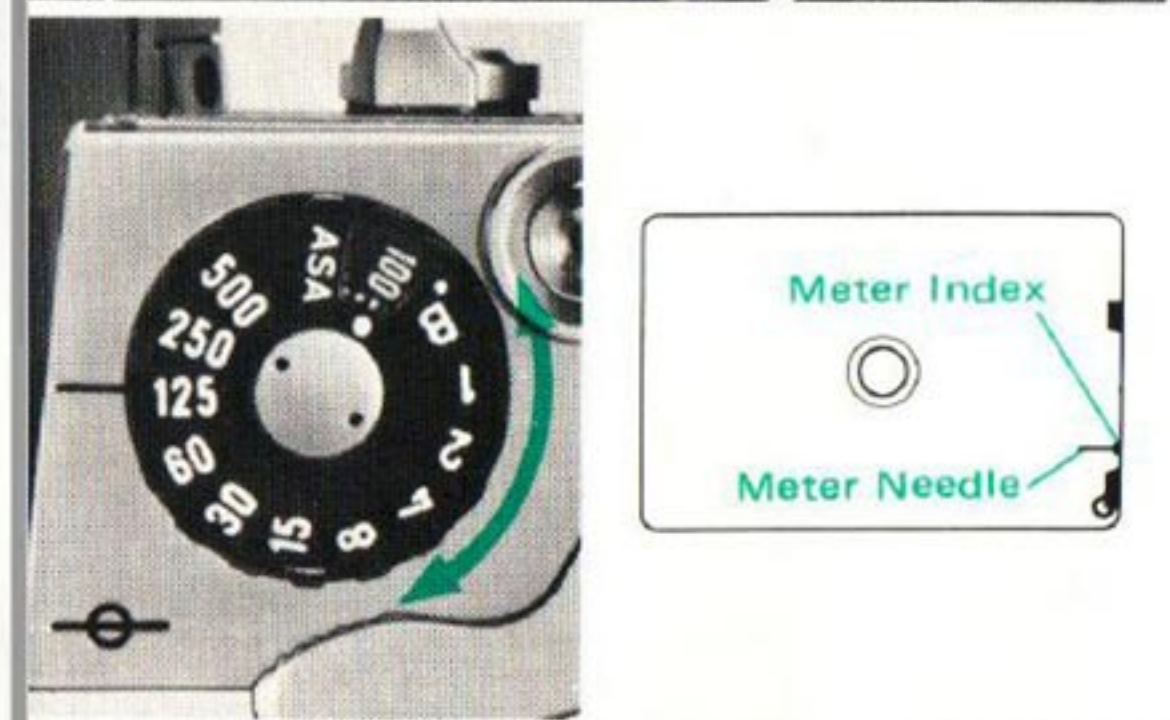
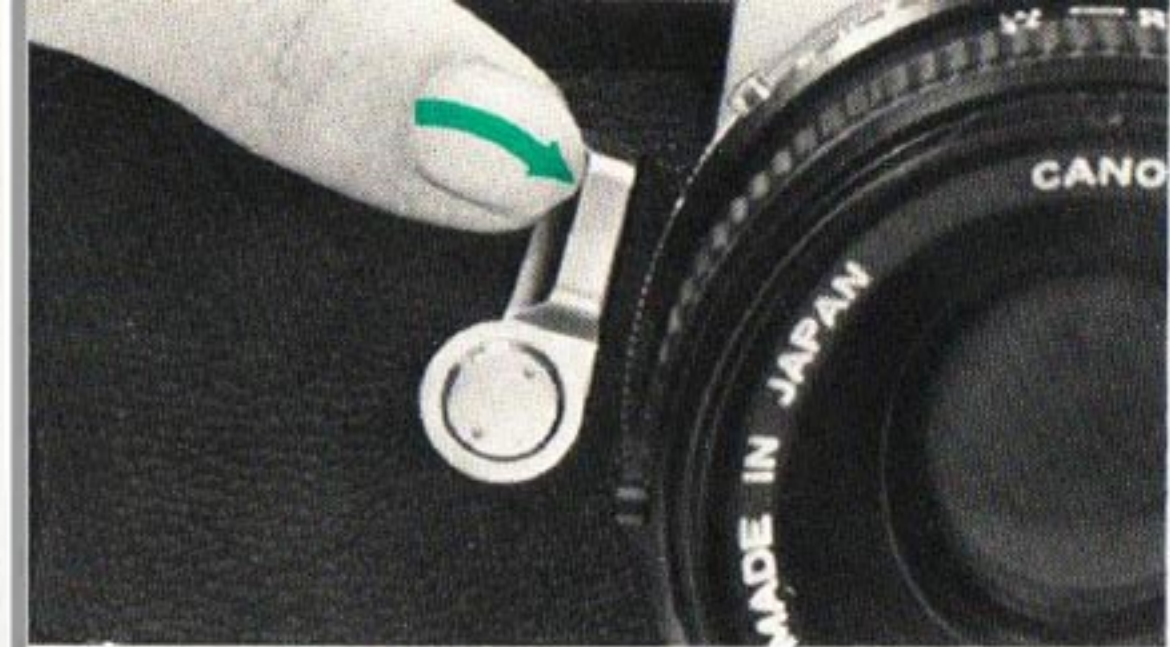

Stopped-Down Metering

When using a lens having no full aperture metering signal such as FL lenses, metering should be performed by stopping down the lens. Stopped-down metering is performed by pressing the stopped-down functioning lever.

1 Set the shutter speed dial at the desired speed.

2 Face the camera towards the subject, look into the viewfinder, and press the stopped-down functioning lever. The aperture needle will point to the lower coupling limit mark and only the meter needle remains.

3 Turn the preset aperture ring and make the meter needle stop at the meter index in the viewfinder.

- In the case of f/stop priority, adjustments can be made with the shutter speed dial.

4 If the meter needle is pointing above the meter index and cannot be matched by closing the preset aperture ring and metering cannot be performed, turn the shutter speed dial to the faster side. If the meter needle is pointing below the meter index and cannot be matched by opening the preset aperture ring, turn the shutter speed dial to the slower side. When the red signal appears, use a flash unit or high-speed film.

Coupling Range of Built-in Exposure Meter

The built-in exposure meter couples to the following range of f/stops and shutter speeds with respective film speeds. When photographing with the film speed ASA 100, for example, the exposure meter couples within the full range from full aperture opening to f/22, between 1/4 sec. and 1/500 sec.

Film Speed		Shutter Speed									
ASA	25	1	1/2	1/4	1/8	1/15	1/30	1/60	1/125	1/250	1/500
ASA	50	1/2	1/4	1/8	1/15	1/30	1/60	1/125	1/250	1/500	...
ASA	100	1/4	1/8	1/15	1/30	1/60	1/125	1/250	1/500
ASA	200	1/8	1/15	1/30	1/60	1/125	1/250	1/500
ASA	400	1/15	1/30	1/60	1/125	1/250	1/500
ASA	800	1/30	1/60	1/125	1/250	1/500
ASA	1600	1/60	1/125	1/250	1/500
Minimum f/stop		f/22	f/22	f/22	f/22	f/22	f/22	f/22	f/22	f/22	f/16

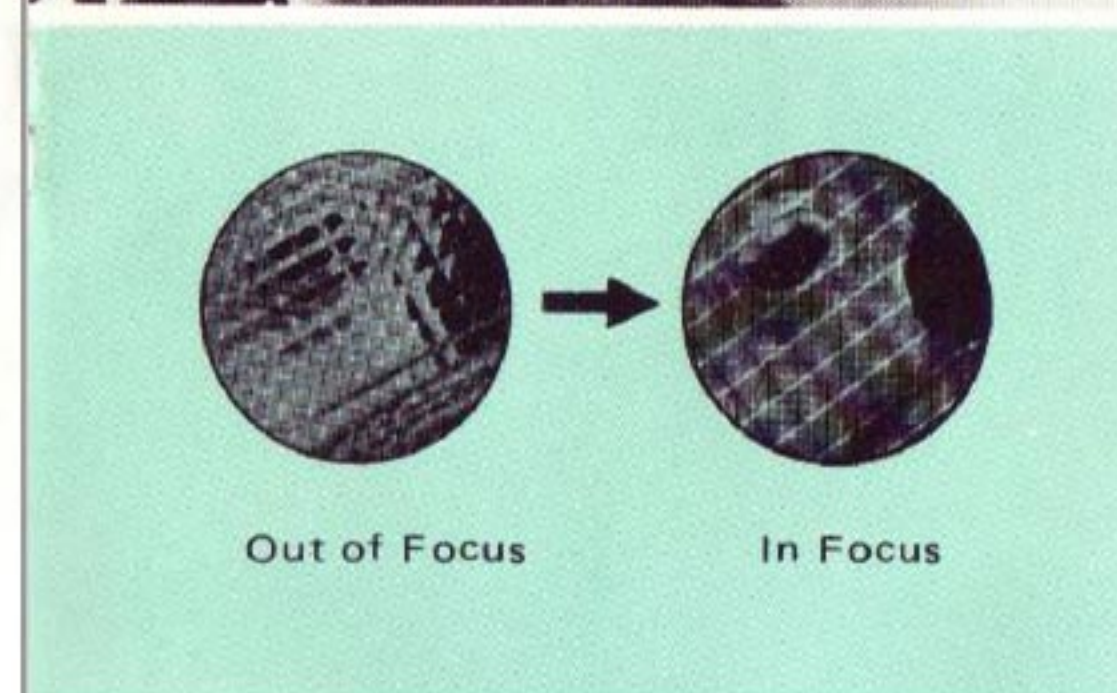

Viewing and Focusing

Composition

The exact picture image to be photographed can be seen on the focusing screen of the viewfinder without any parallax. This enables you to determine the exact composition of your scene before pressing the shutter release button.

Focusing

The center circular section of the viewfinder is a micro-prism screen rangefinder made up of microscopic prisms for fast and precise focusing.

While looking through the viewfinder, revolve the focusing ring. It is in focus when the image in the rangefinder becomes sharp and clear.

Dioptric Adjustment Lenses (Rectangular Type)

Dioptric adjustment lenses are available as optional attachments. When a dioptric adjustment lens is attached to the viewfinder eyepiece, those who are far- or near-sighted can take pictures without glasses. Four different diopters of +1.5, 0, -2.5 and -4 are available.

Angle Finders A2 and B

Canon Angle Finders A2 and B can be attached to the eyepiece for copying, close-up photography, macro-photography and photomicrography. You will see the right and left sides of the image in reverse with the Angle Finder A2, and upright with the Angle Finder B.

Magnifier S

The Canon Magnifier S can be attached to the viewfinder eyepiece of the TLb, with the separately available adapter which magnifies the rangefinder section for accurate focusing. Because it can be sprung up and clamped, the entire field-of-view can easily be viewed after focusing, which is very useful for copying in great quantities.

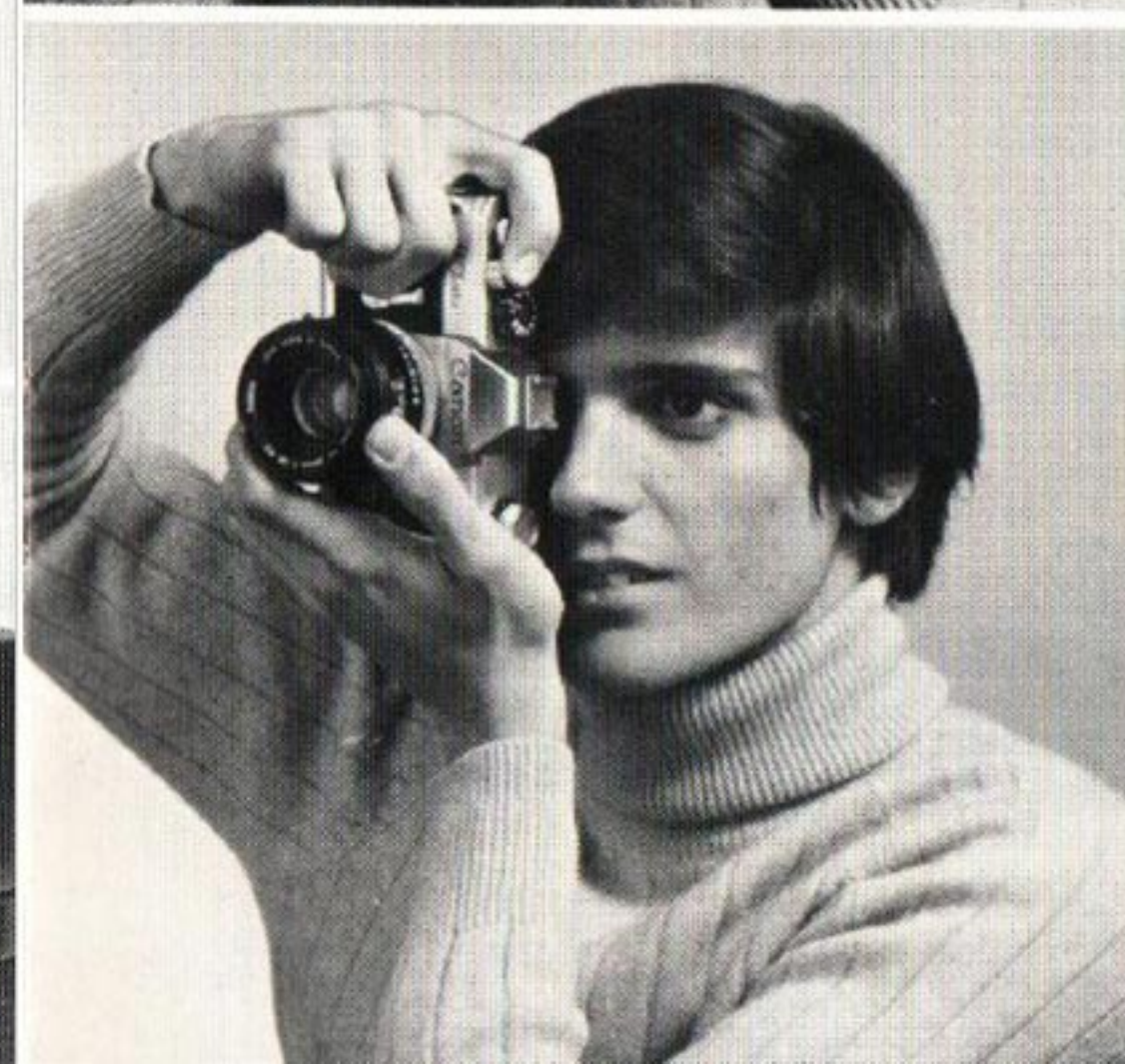
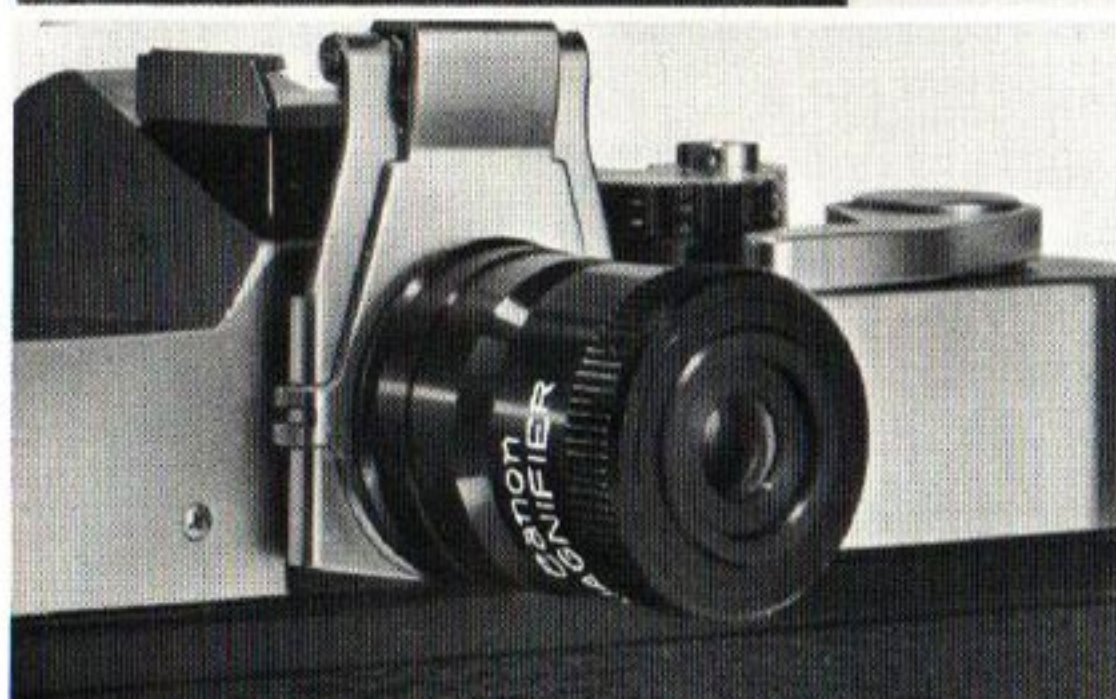
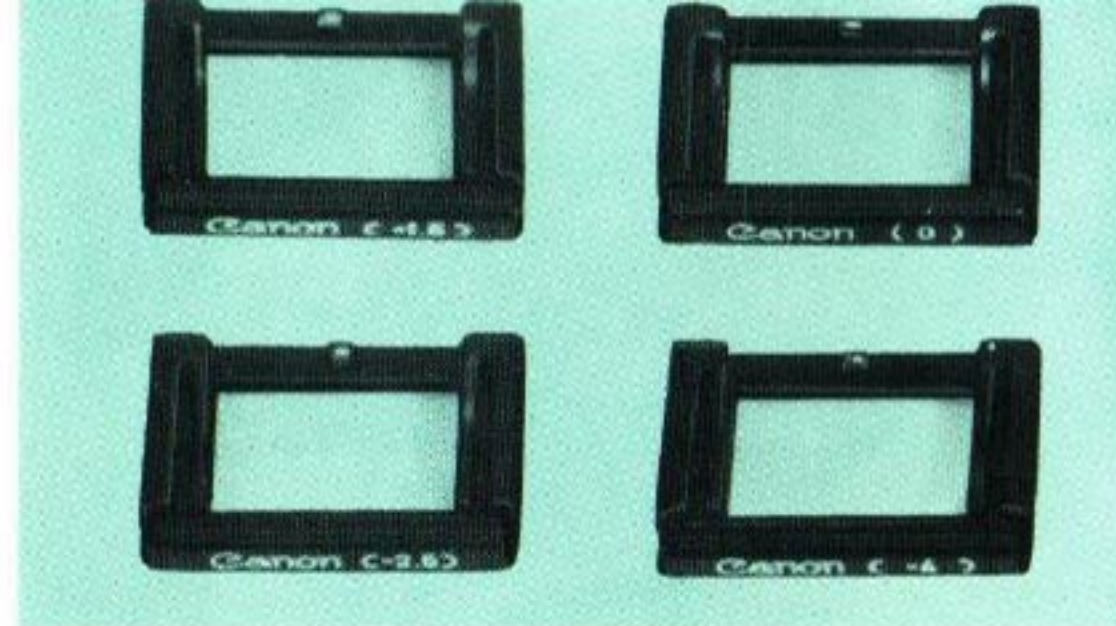

Holding the Camera

Hold the camera firmly in order to take a clear picture. Hold the camera either in a vertical or horizontal position, look through the viewfinder, and focus. Then press the shutter release button gently. The following steps are important.

- 1 Hold the camera snugly in both hands. The camera should be pressed firmly to your cheek or forehead.
- 2 When the camera is in a horizontal position, both elbows should be firmly pressed against the body, and when in a vertical position, one elbow at least should be resting against the body.
- 3 Hold your breath and press the shutter release button with a smooth, steady stroke. Otherwise you will have a blurred picture.
 - When using a telephoto lens and/or slow shutter speeds below 1/30 sec., the use of a tripod and cable release is recommended.
 - When taking pictures against the light, always use a lens hood.
 - Camera Holder F, for attaching a tripod, and the Canon Release are separately available.

Film Rewinding Crank

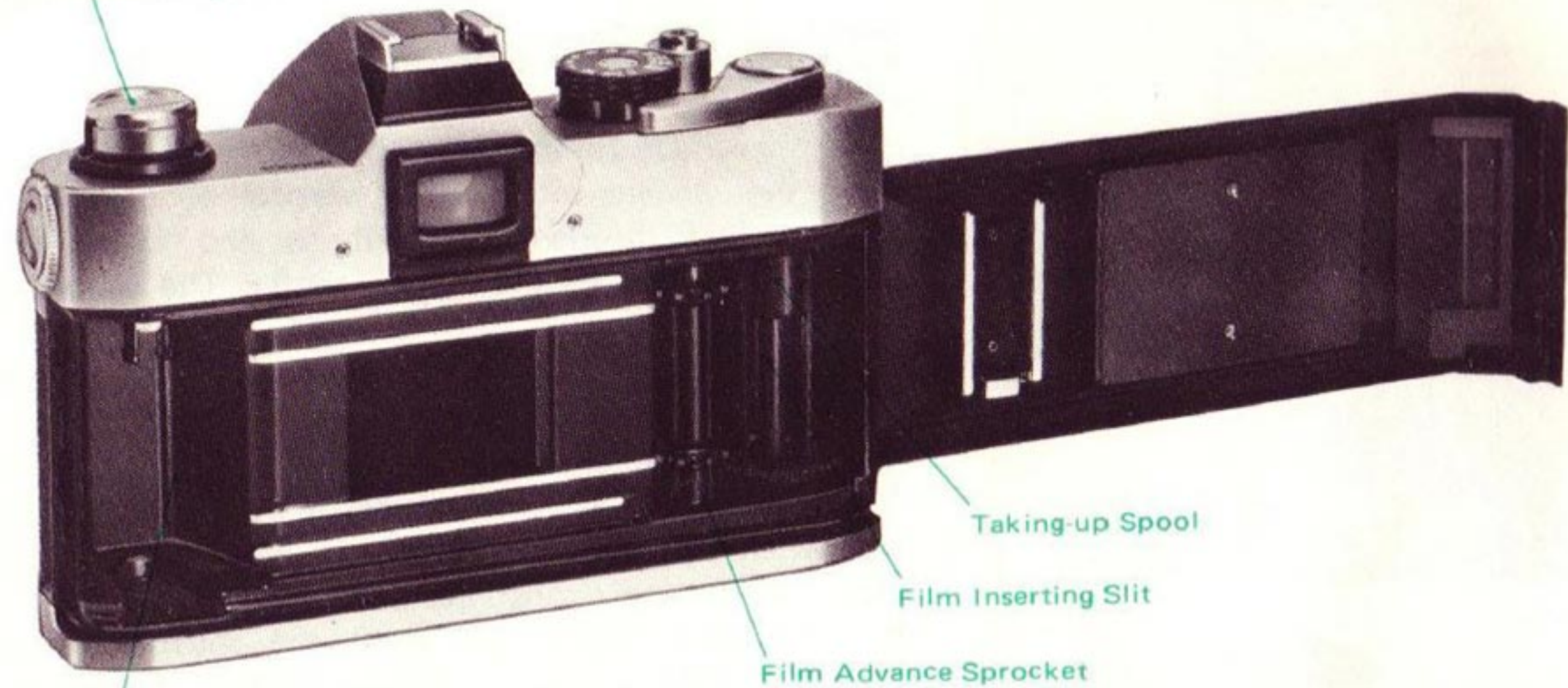

Cartridge Compartment



Direction in which film is placed
(emulsified surface facing the back of the lens)

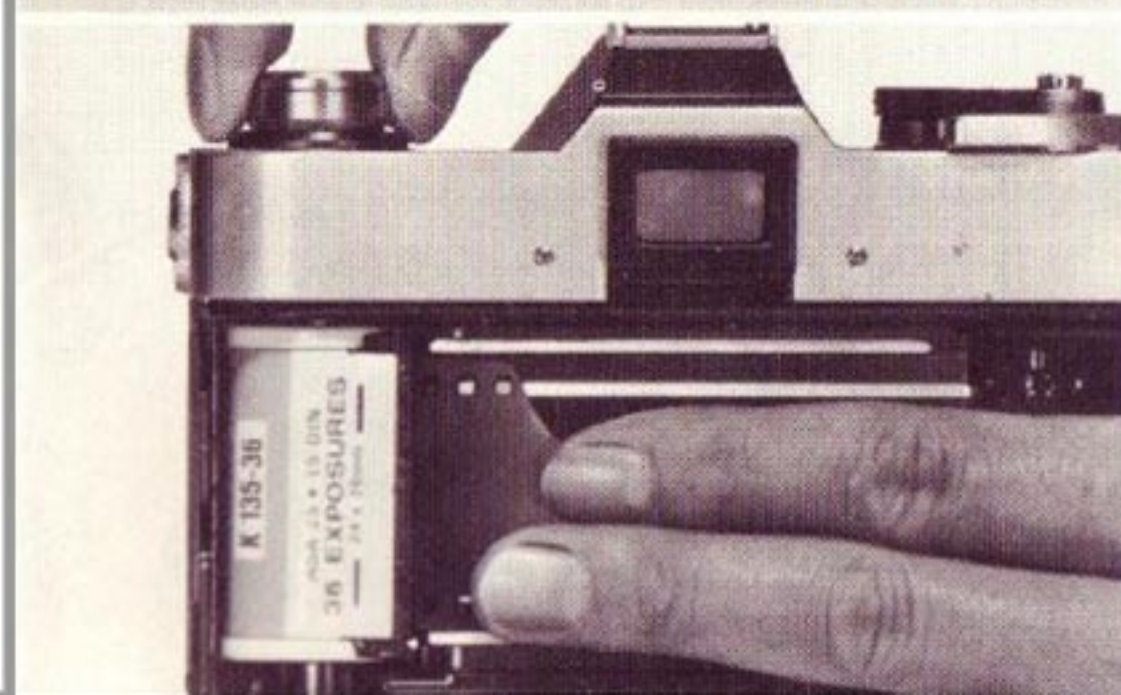
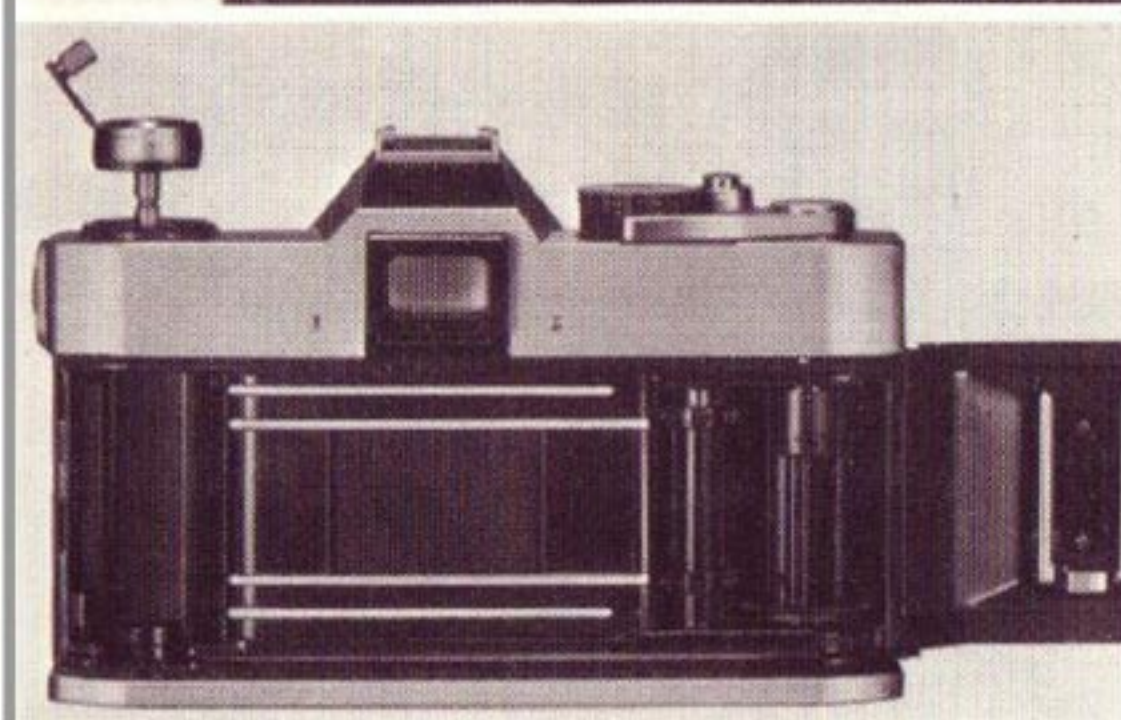
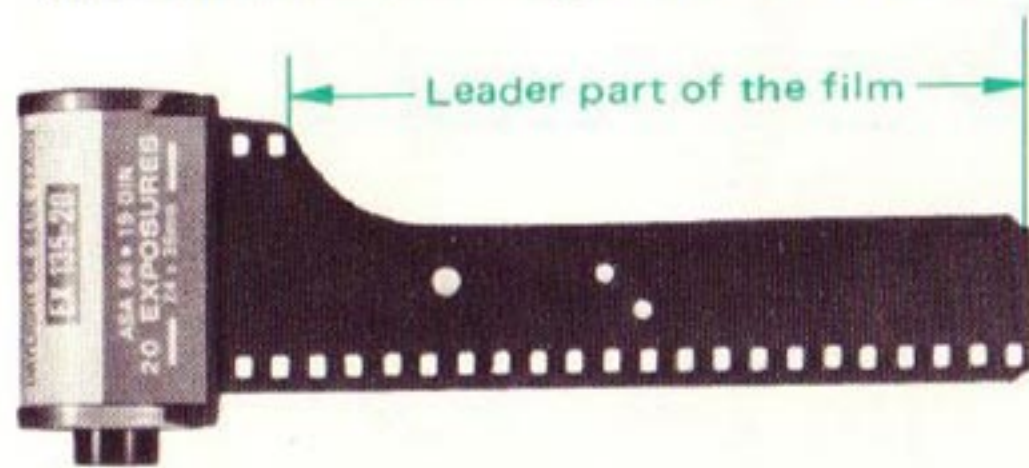

Film Loading

Canon TLb accepts any standard 35mm film roll in cartridge for daylight loading. Always avoid loading film in direct sunlight.

- 1 Raise the film rewind crank and pull it all the way up. The cover will rise slightly.
- 2 Open the cover fully. Face the film cartridge as illustrated, and insert it into the cartridge compartment. Push the film rewind crank back into its former position. The crank fork will slip into the axis of the film cartridge. In case the crank does not fully return, turn it slightly to the left or right.

3 Pull out the film from the cartridge and insert the film tip into the slit of the film taking-up spool for a length of approximately two perforations.

4 Turn the film advance lever and wind the film around the film taking-up spool.

■ At this time, engage the teeth of the film taking-up spool and that of the film advance sprocket with the film perforations.

5 Press down on the back cover and close it.

If the film is sagging, the cartridge will rise and the back cover will not close.

6 Leave the lens cap on and take two blank shots, each time turning the film advance lever.

The frame counter will advance from the "S" mark to "0". With one more shot and advance, the camera will be ready for the first shot.

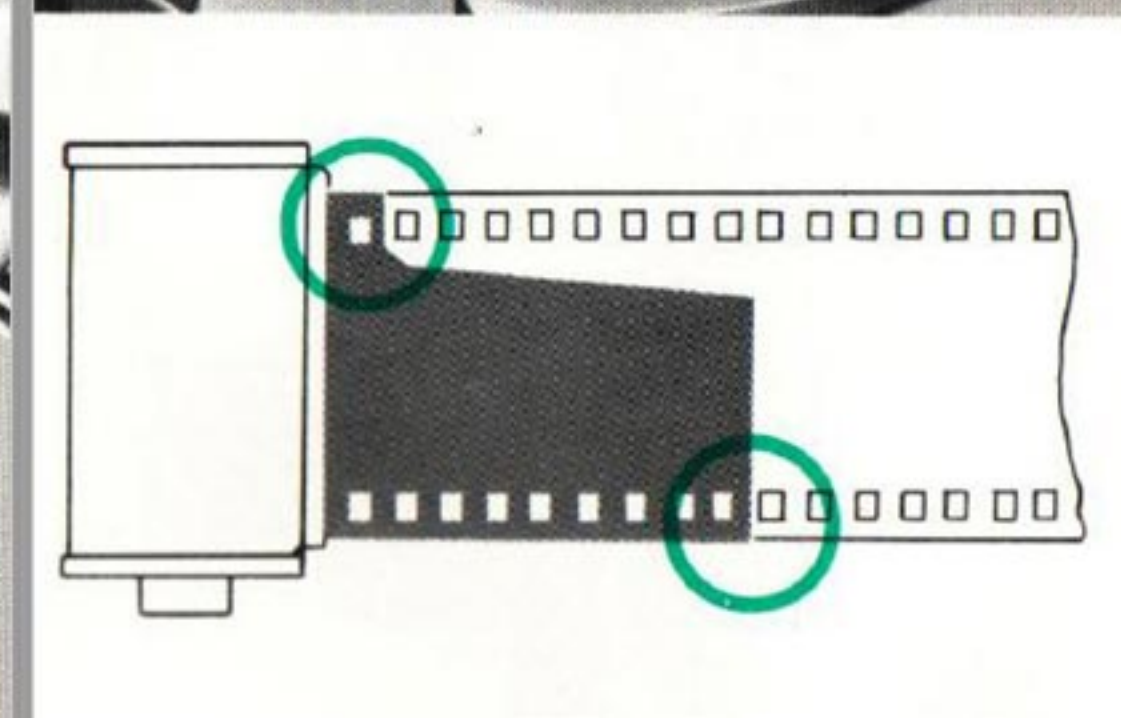
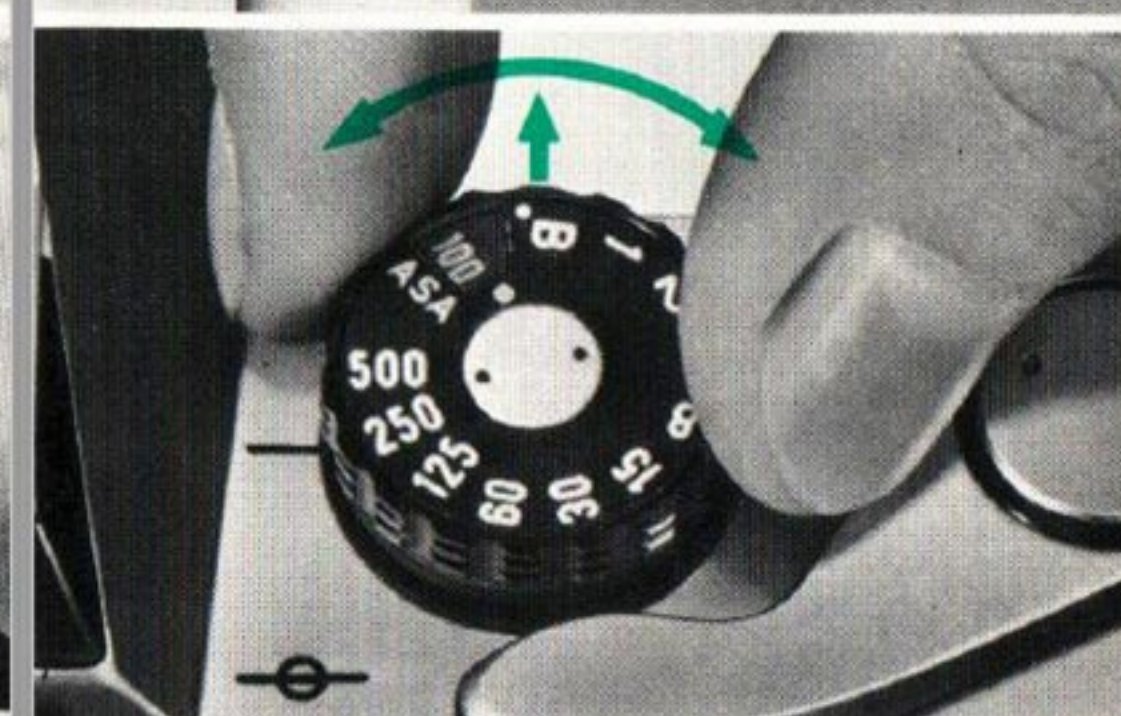
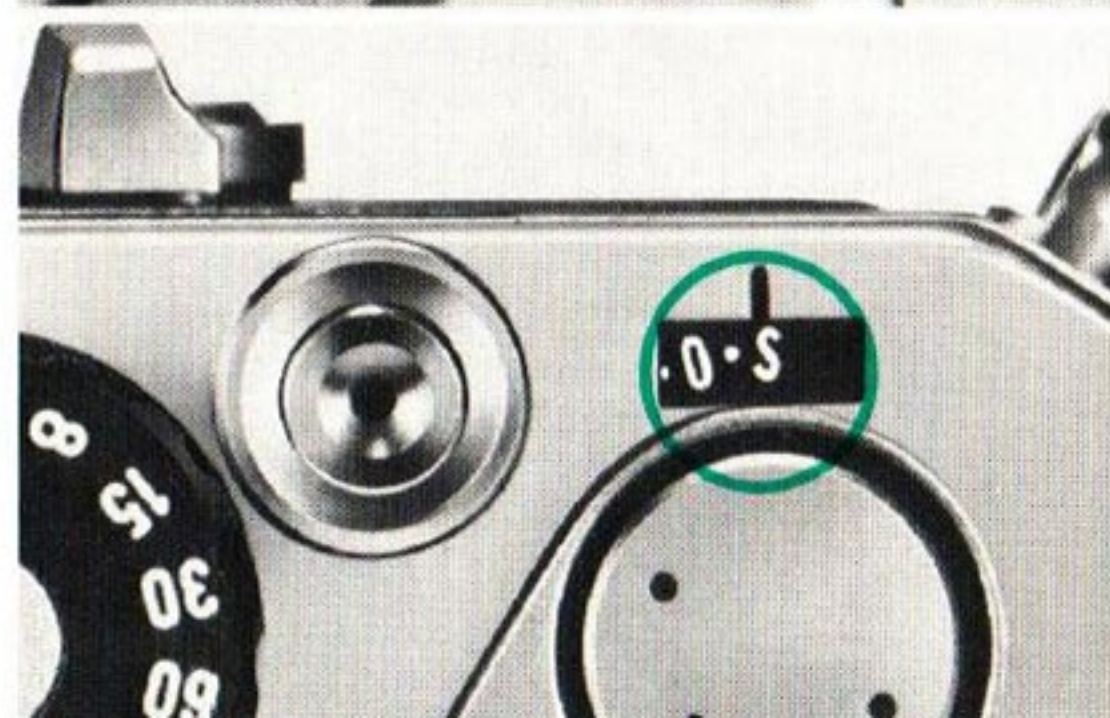
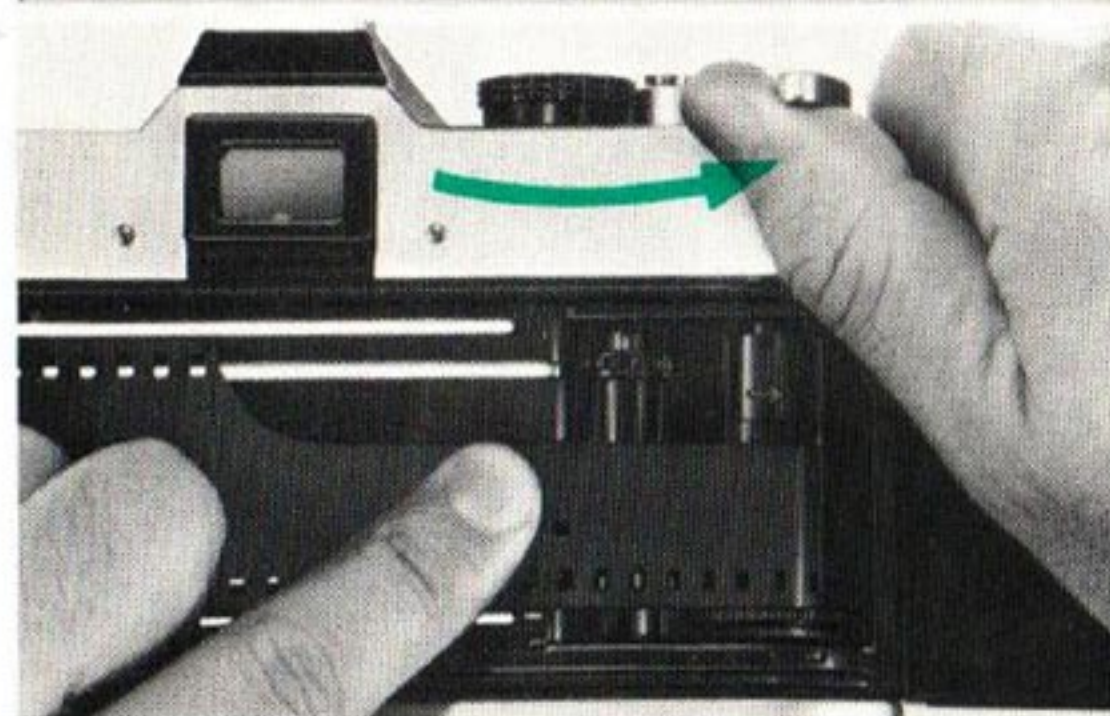
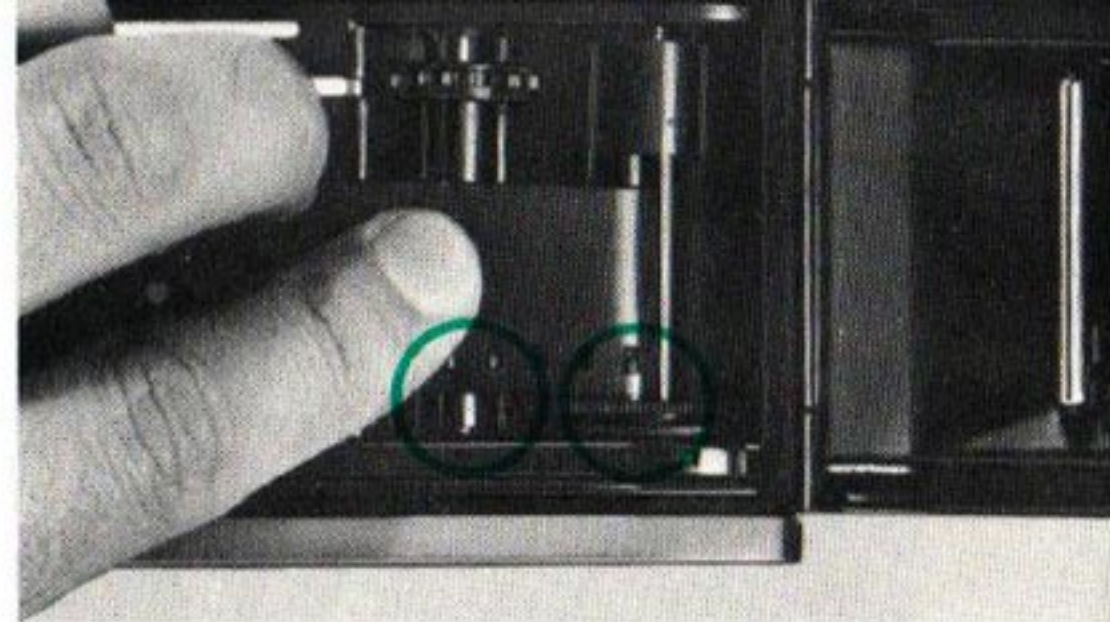

Checking Correct Film Loading

The film is properly loaded and advanced if the film rewind crank rotates counterclockwise when you wind the film advance lever. If the film rewind crank does not rotate, take out the film, as explained on the following page, and reload.

Setting the Film Speed

When loading the film, be sure to set the film speed scale at the proper position. Refer to page 18.

Repacking a Long-Wound Film

When repacking a long-wound film for darkroom loading into an ordinary cartridge, be sure to trim the tip of the leader between perforations.

Film Rewinding

Be sure not to open the back cover before rewinding. Otherwise, the entire roll will be exposed and ruined as the exposed film is naked within the camera.

- 1 Press in the film rewind button.
- 2 Raise the film rewind crank, turn it in the direction of the arrow, and rewind the film into the cartridge. When the film rewind button stops revolving and rewinding resistance becomes light, stop rewinding immediately in order to keep the leader part of the film outside the cartridge.
- 3 Open the back cover.
- 4 Pull up the rewind knob fully and remove the cartridge.

- Once the film rewind button has been pressed, the finger may be removed. The button will pop out automatically when the film advance lever is wound.

- If you force the film advance lever after the film reaches its end, the film will become detached from the cartridge spool or tear, and rewinding will become impossible. In this case, open the back cover in a darkroom, remove the film, and put it in a box into which no light enters.

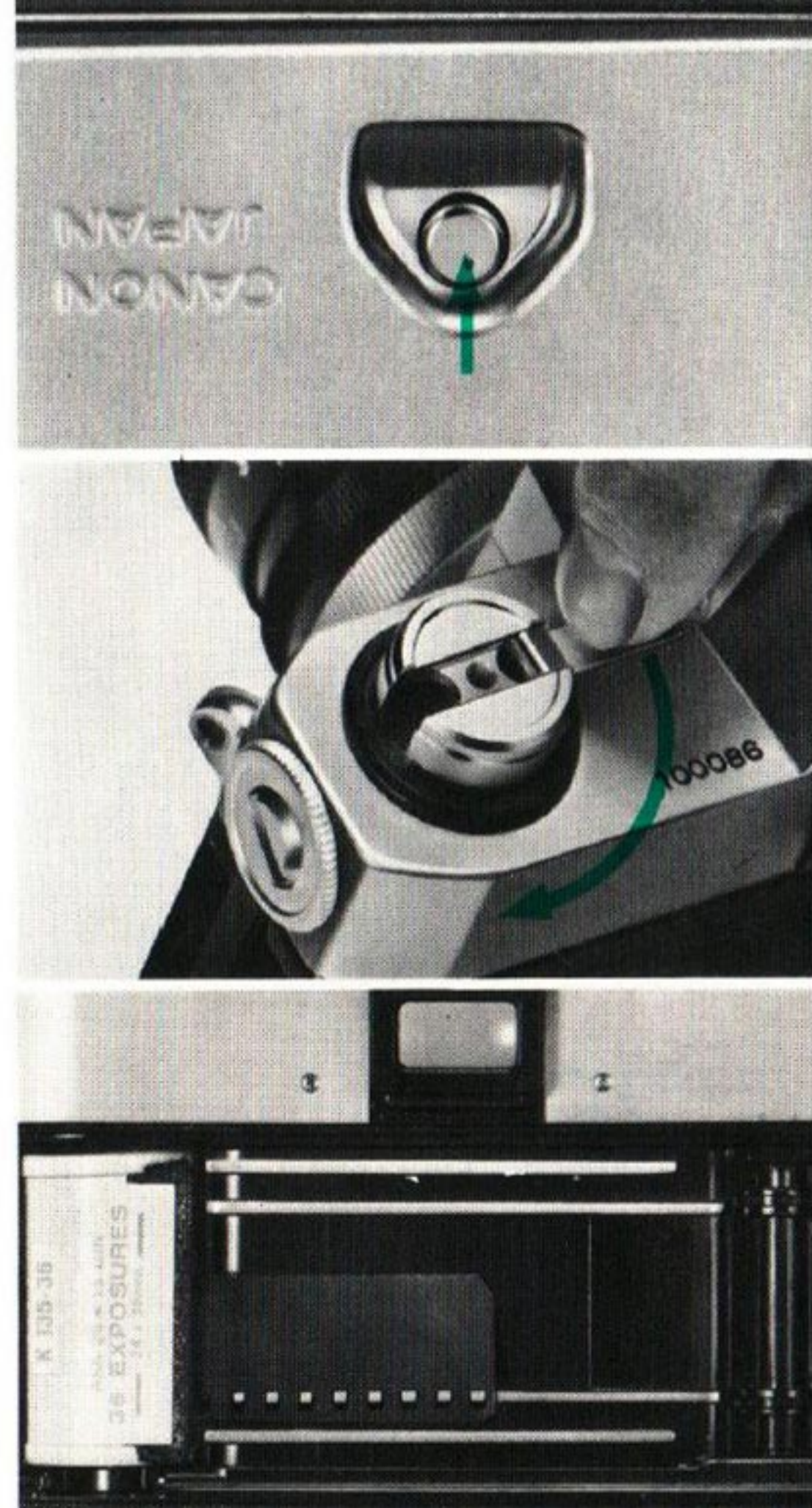

Synchronizing Flash Unit

When using an electronic flash unit or flash bulb unit, attach it to the accessory shoe of the camera, and connect the cord of the unit to the flash socket of the camera.

The exposure is decided by dividing the guide number of the unit with the focusing distance and obtaining the proper f/stop.

- The X contact of Canon TLb is 1/60 sec.

Type		Synchronized Shutter Speed
Flash	FP class(#6, Press 26)	1/125 or faster 1/30 or slower
	M class (M3, #5, Press 25)	1/30 or slower
	MF class (AG-1, AG-3, M2, Flashcube)	1/30 or slower
Electronic Flash Unit	Speedlite	1/60 or slower

Changing Lenses

1 Remove the lens from the camera body by turning the bayonet ring of the lens to the left until the red dot on the lens coincides with the red dot on the camera mount.

2 To confirm the operation or for reverse-lens shooting, first remove the lens from the camera body. Then, press the lock pin which is located just above the positioning pin of the bayonet ring with a pointed object and turn the bayonet ring.

3 Mount the lens by matching the red dot of the lens to the red dot on the camera mount. Turn the bayonet ring to the right and fasten.

■ Attach the lens quickly in the shade. The film will sometimes become foggy if the lens is left unattached.

■ To remove the dust cap of the lens, turn the bayonet ring fully to the left. In this case, mount the lens onto the camera body as is.

■ Whenever a lens is removed, be sure to put on the dust cap to protect the various signal levers and pins.

■ To prevent a dirty or damaged mirror, do not leave the camera body without a lens for a long time.

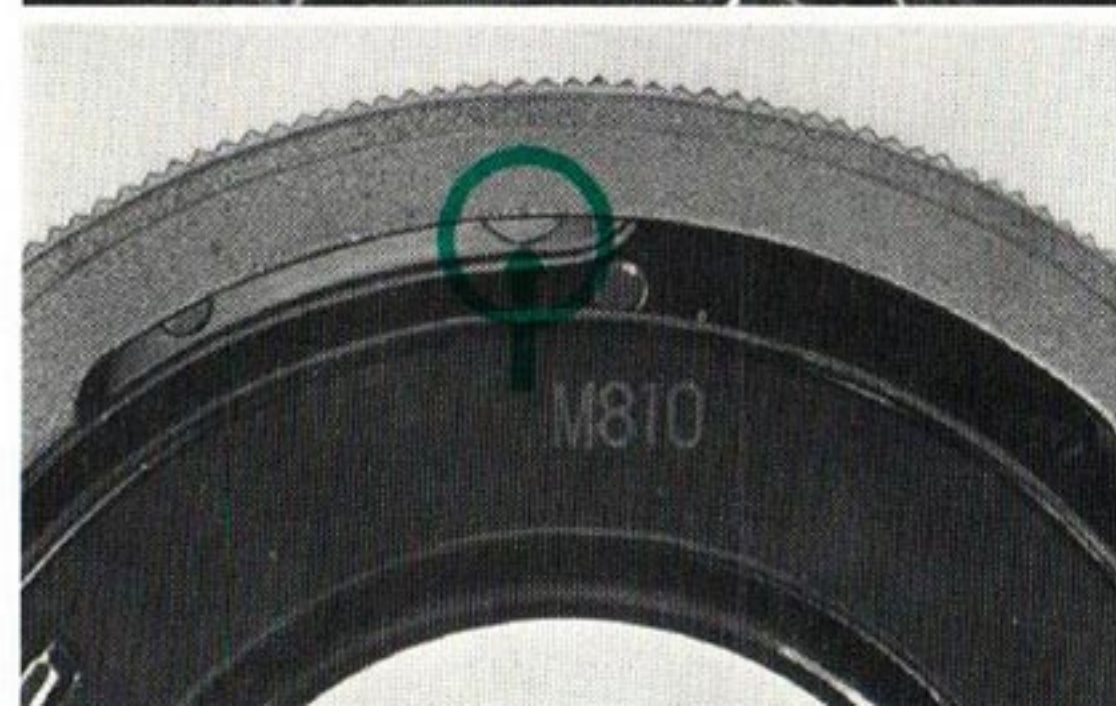
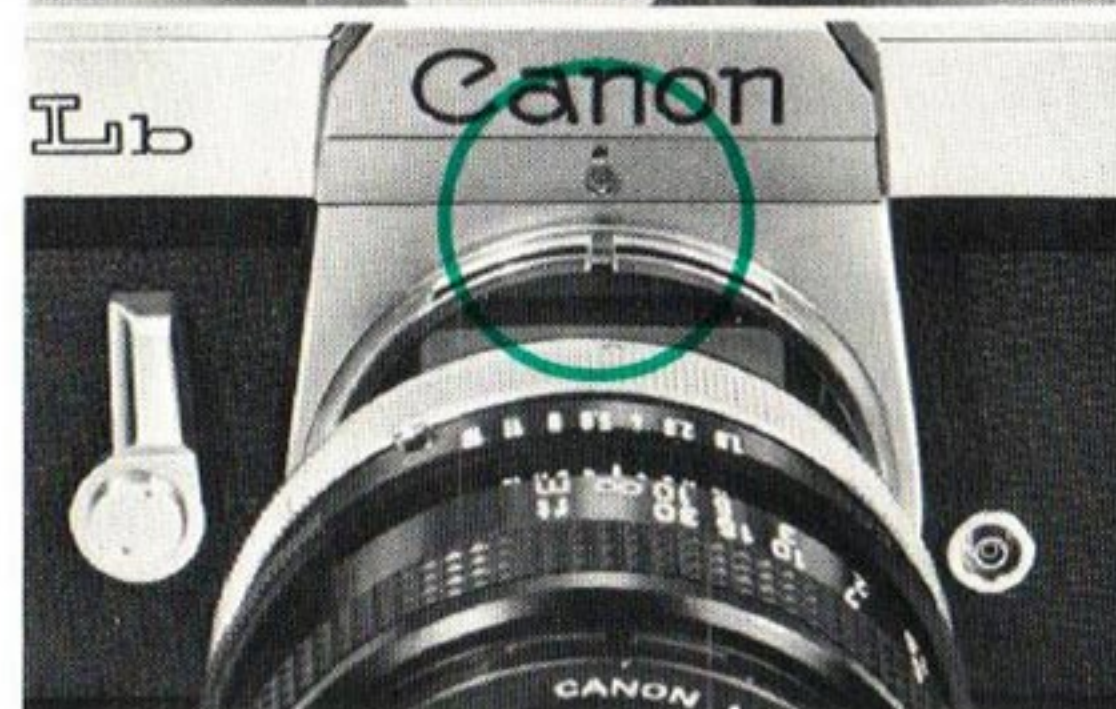
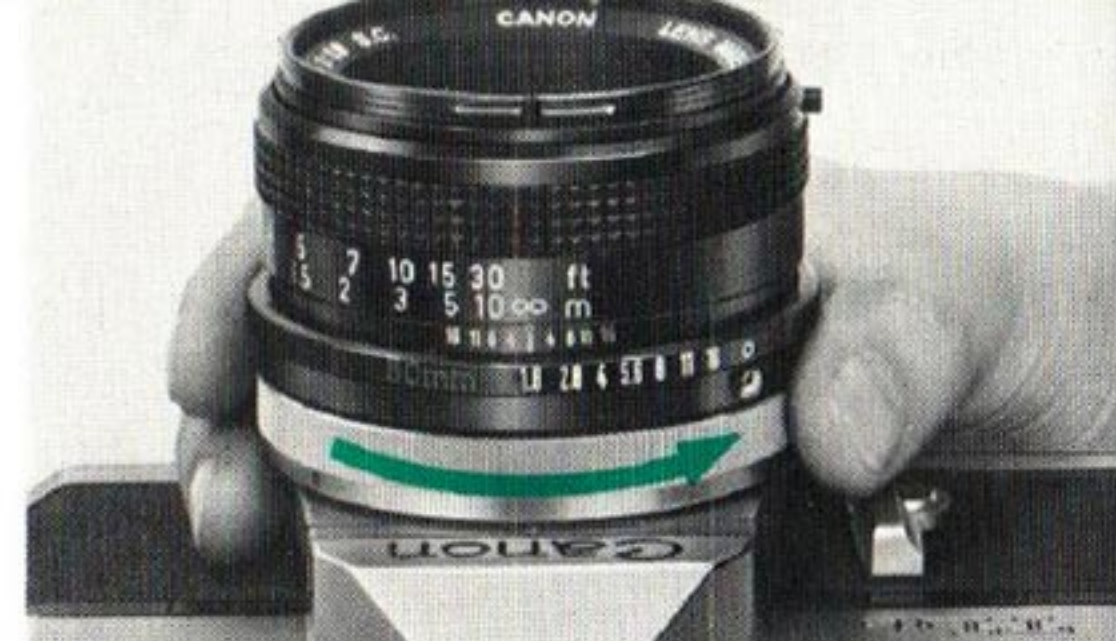

Lens Signal

Aperture Signal Lever: Transmits the preset f/stop of the automatic aperture to the camera body.

Full Aperture Signal Pin: Transmits the full aperture f/stop when a lens with a different full aperture number is mounted. It also performs error compensation of the full aperture metering.

Automatic Aperture Lever: Stops down the aperture to the preset position. (See page 15.)

EE Lock Pin: This is a protective pin to prevent the aperture of the lens from moving to the green mark unintentionally. In order to set at the green mark, turn the aperture ring while pushing down the EE lock pin. When withdrawing from the green mark, turn the aperture ring again pushing down the EE lock pin.

EE Switch Pin: When the preset aperture ring is set at the green mark for EE use, the lens can be attached only to the Canon F-1. If the lens is attached to the TLb, it cannot be set at the green mark.

Pin: Reserved.

Distance Signal Pin: It is used for the F-1 and FTb, which have a flash direct contact for automatic flash photography with the exclusive electronic flash unit, Speedlite 133D, and a Flash Auto Ring. However, since the TLb does not have a flash direct contact, this distance signal pin can not be used.

Distance Scale

Indicates the distance between the focused subject and the film plane. It is necessary for checking the depth-of-field, for flash and infrared photographs.

■ The correct position of the scale is in the center of each value. For example, the correct position of a two-digit value is the center of the two figures.

Infrared Index

For infrared photography, correction of the distance scale is necessary because the focal point slightly deviates from ordinary photography. Focus first in the ordinary manner, then adjust the distance scale to the infrared mark "•" ("R" in the case of FL lenses) in red. For instance, if the distance scale reads 10m after focusing, shift the 10 scale to "•". The position of "•" on the TLb is based on using film with the highest wave-length sensitivity figure of $800\text{m}\mu$, such as Kodak 1R 135 film and Wratten 87 filter.

Film Plane Indicator

When focusing is done by actual measurement, measure the distance from the film plane indicator and interpret the measured distance on the distance scale.

When performing close-ups, macrophotography or copy work, decide the distance of the camera from the subject with this indicator.

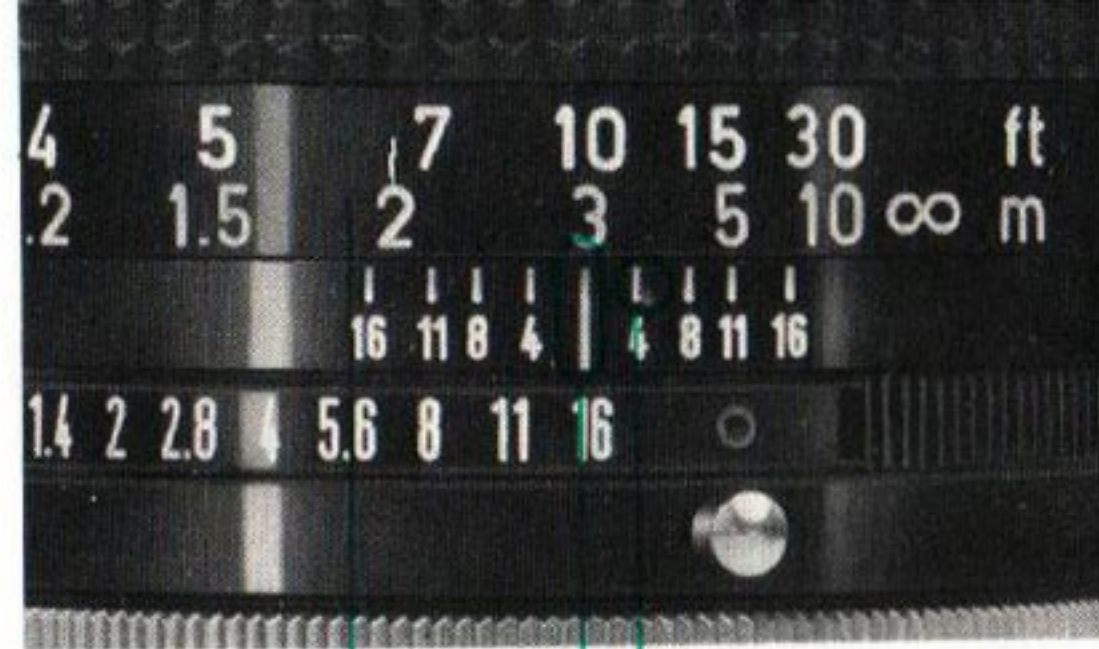

Distance Scale

Infrared Index (red dot)

Index (orange line)

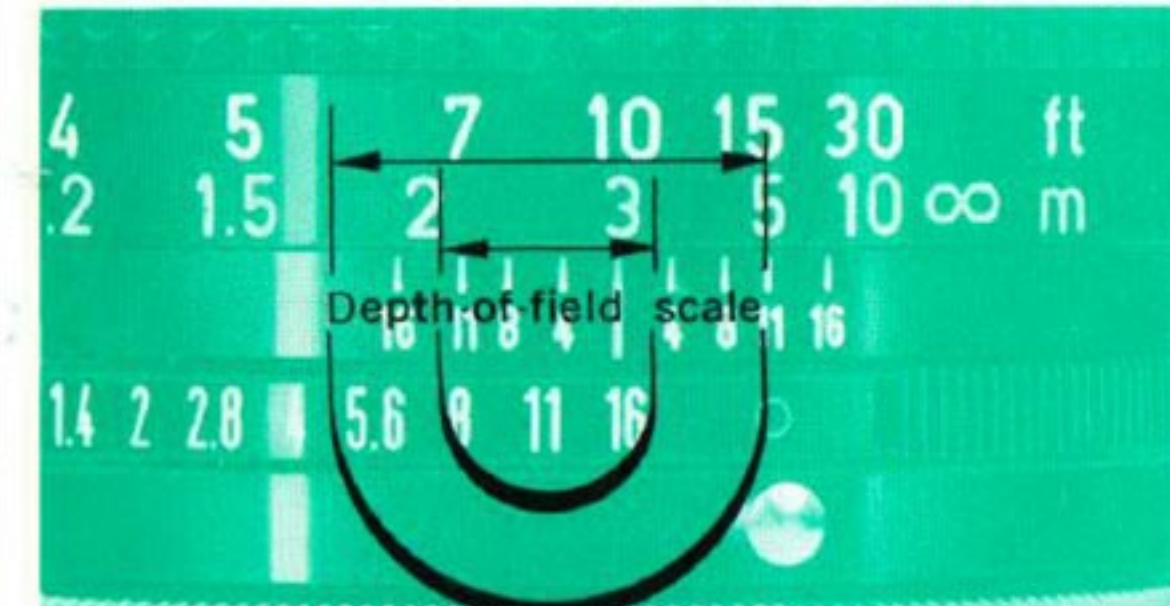
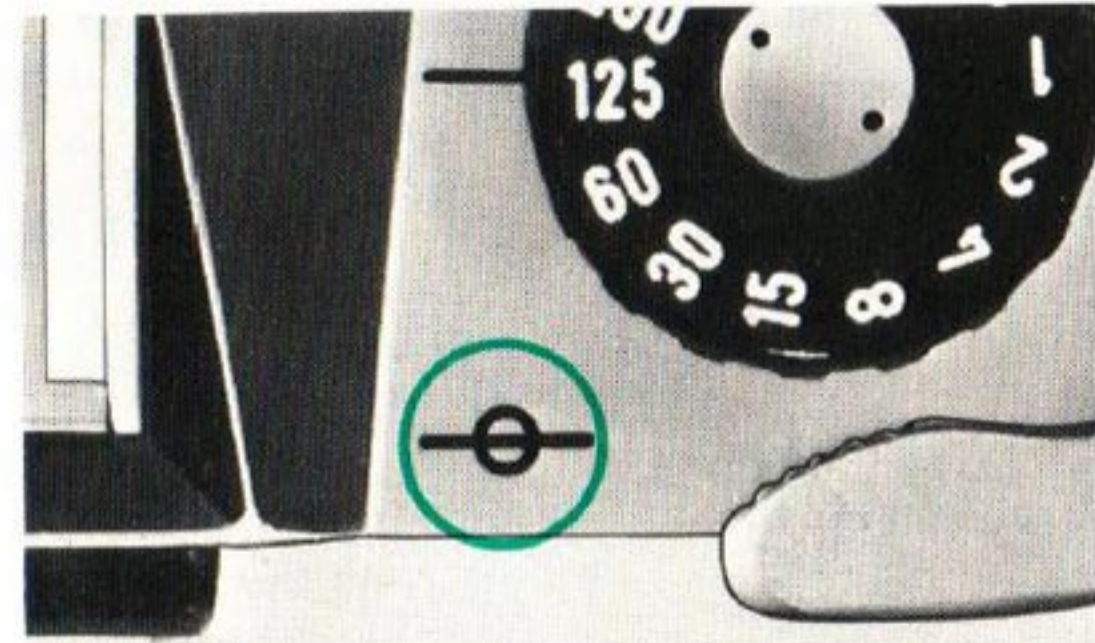

Depth-of-Field Scale

The depth-of-field scale indicates the range of subjects which will be in sharp focus on the film. In this case, the depth-of-field behind the subject is deeper than in front of subject. This range will vary with the following factors: The depth-of-field will be deeper, the larger the f/stop number, the further the distance of the subject, and/or the shorter the focal length of the lens. The depth-of-field will be shallower, the smaller the f/stop number, the nearer the distance of the subject, and/or the longer the focal length of the lens.

For example, if the lens is 50mm and the subject has been focused at a distance of 3m (10'), with an f/8 aperture opening read off from both indexes on either side of the indicator (orange line), the approximate depth-of-field is from 2.3m (8') to 4.3m (14').

If the aperture is closed down to f/16, the picture will become sharp when the subject is between 1.9m (6') to 7.6m (25') from the camera. This range will vary with the selected f/stop.

■ In the case of Canon FD lenses, you can see the actual sharpness through the viewfinder by pressing the stopped-down functioning lever.

■ Although air bubbles may sometimes be seen in a lens, they do not affect the resolution power or the sharpness of the picture.

Lens Hood

When attaching the lens hood on the lens, align it to the bayonet ring on the lens and turn it clockwise.

With some exceptions of standard and wide-angle lenses, a lens hood can be stored in the camera case. When doing this, attach the lens hood onto the lens in inversed order and align it to the bayonet ring and turn counterclockwise.

FD Lens Mount (FL and R Series Lenses)

All Canon FD and FL lenses, which have FD and FL mounts, can be used with the Canon TLb, except the FLP 38mm F 2.8.

■ It is also possible to attach and use all Canon R lenses for Canonflex use. However, as the preset aperture mechanism differs, pictures must be taken by controlling the aperture manually.

Note: FD lenses can be mounted on the already marketed Canon's SLR cameras; however, the FD 50mm F1.8 can not be used on the Canonflex, which mainly uses R series lenses.

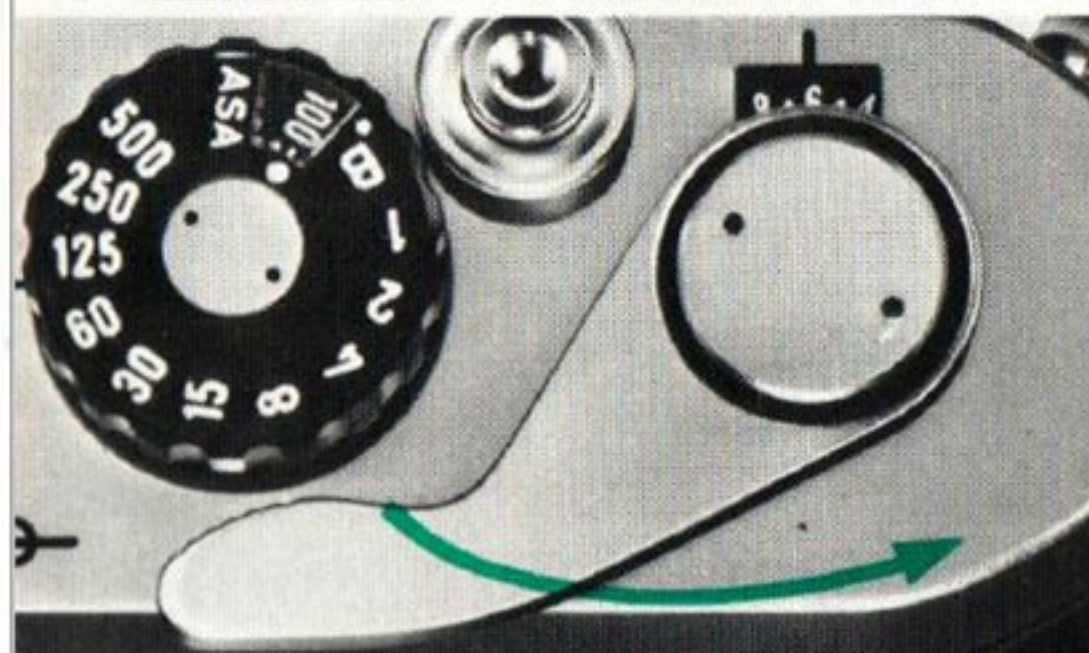

Double Exposures

Although the Canon TLb is designed to prevent double exposures being made by mistake, double exposures can be made by the following steps:

- 1 When the first exposure has been made, depress the film rewind button.
- 2 Rewind the film with the film rewind crank while watching the red mark on the film rewind button carefully.
- 3 Stop rewinding when the mark has made a $7/8$ turn, i.e., 315° .
- 4 Next, wind the film advance lever while lightly holding the rewinding crank. When resistance is felt on the film rewind crank, stop winding.
- 5 Wind the film advance lever once more. The camera is ready for double exposures.
 - By repeating the above process, any number of exposures on the same frame can be made. However the frame counter will continue to advance with each exposure.

Filters

Type	Effectiveness of Filters
○● UV	Absorbs only ultra-violet rays. Especially effective at seaside, and on high mountains. Recommended for use in color photography.
○ Y1 Y3	Increases contrast of black and white film. Enhances clouds, darkens the blue sky. Brightens red and yellow.
○ O1	Darkens blue, increases yellow and red perceptibly. Good for contrasts especially in distant landscapes.
○ R1	Makes strong contrasts. May also be used with infrared film.
○ G1	Prevents red from turning radically into white. Lightens sky and face appropriately, and reflects the lightness of fresh greenery.
○● ND4 ND8	ND4 reduces light values by 1/4, ND8 by 1/8. No effect on the reproduction of colors.
● SKYLIGHT	Acts to harmonize the blue sky and shade.
● CCA4	For use with daylight type film under cloudy conditions.
● CCA8	For use with universal type (color negative) film under cloudy conditions or with tungsten type film in the morning sun or sunset.
● CCA(12)	For use with tungsten type film under sunlight.
● CCB4	For use with daylight type film in the morning sun or sunset.
● CCB8	For use with daylight type film and clear flash bulb.
● CCB(12)	For use with daylight type film under tungsten light.

○ For black and white film. ● For color film.

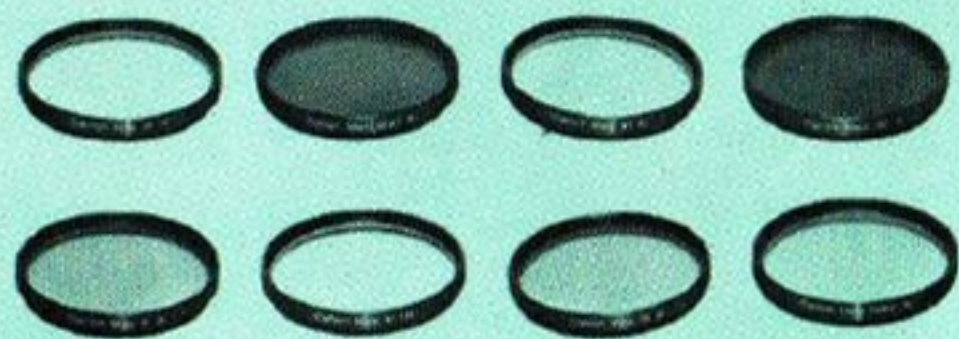

Various types of filters, according to lens thread diameters, are available for special effects in both color and monochrome photographs. The through-the-lens exposure measurement system of Canon TLb does not require exposure factor compensation.



Interchangeable Lenses and Accessories

A wide range of interchangeable lenses from 7.5mm to 1200mm and various accessories are available to further enhance your Canon TLb.

FD Series of Interchangeable Lenses

1. Fisheye 7.5mm F5.6 S.S.C.
2. Fisheye FD 15mm F2.8 S.S.C.
3. FD 17mm F4 S.S.C.
4. FD 20mm F2.8 S.S.C.
5. FD 24mm F2.8 S.S.C.
6. FD 28mm F3.5 S.C.
7. FD 35mm F3.5 S.C.
8. TS 35mm F2.8 S.S.C.
9. FD 35mm F2 S.S.C.
10. FL 50mm F3.5
11. FD 50mm F1.8 S.C.
12. FD 50mm F1.4 S.S.C.
13. FD 55mm F1.2 S.S.C.
14. FD 55mm F1.2 AL S.S.C.
15. FD 100mm F2.8 S.S.C.
16. FD 135mm F3.5 S.C.
17. FD 135mm F2.5 S.C.
18. FD 200mm F4 S.S.C.
19. FD 300mm F5.6 S.C.
20. FD 100-200mm F5.6 S.C.
21. FL-F 300mm F5.6
22. FL-F 500mm F5.6
23. FL 400mm F5.6
24. FL 600mm F5.6
25. FL 800mm F8
26. FL 1200mm F11 S.S.C.

Note: Some lenses are not available but will be marketed soon.

All Canon FL and R Lenses can be used with the TLb, except the FLP 38mm F 2.8.

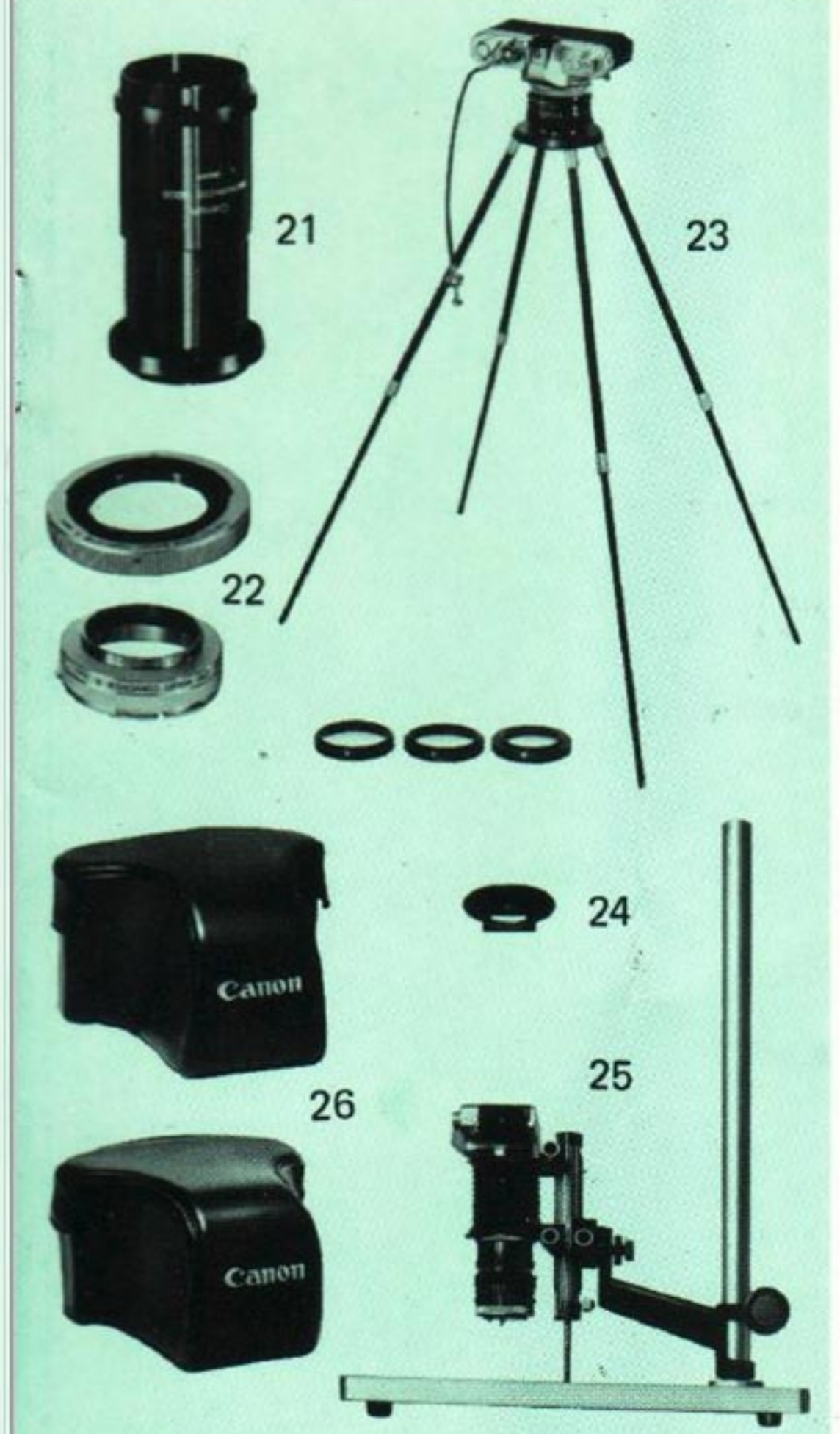

Accessories

1. Bellows FL
2. Bellows M
3. Slide Duplicator
4. Angle Finder A2, B
5. Magnifier S and Magnifier Adapter S
6. Dioptric Adjustment Lenses (Rectangular Type)
7. Flash V-3
8. Camera Holder F
9. 55mm Close-up Lens 240, 450
10. 58mm Close-up Lens 240, 450, 1800
11. Release 30, 50
12. Lens Hood BW-55-A, BW-55-B, BS-55, BT-55, BS-58
13. Lens Cap C55, C58
14. Neck Strap 4
15. Filter 55mm/58mm
16. Macrophoto Coupler FL 55, 58
17. Extension Tubes M 5, 10, 20
18. Photomicro Unit F
19. Gadget Bag G-1
20. Gadget Bag 4
21. Microphoto Hood
22. Lens Mount Converter A, B
23. Handy Stand F
24. SLR Eyecup S
25. Copy Stand 4
26. TLb Case 1.8, 1.2

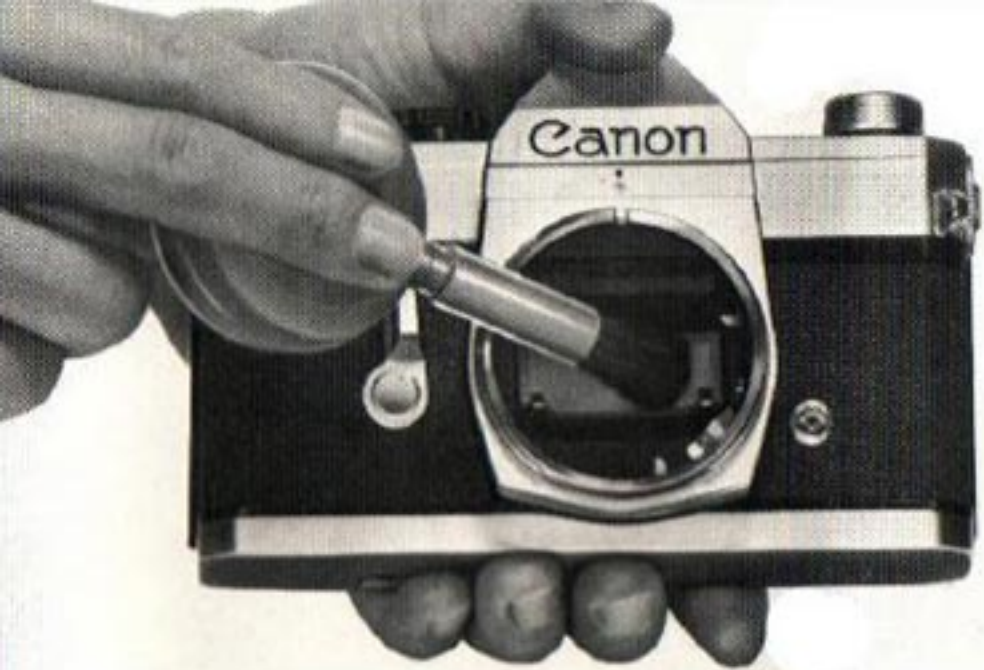

Proper Care of the Camera

Moisture and dust are harmful to your camera. If your camera is to be stored for a long time, it should be removed from its case and also remove the mercury battery, and silica gel or another drying agent should be placed alongside it.

When you use your camera on a rainy day, or at the beach, moisture and salt air adhere to it, which can result in stains, rust, and corrosion. Use a soft brush to get rid of dust and a soft dry cloth for wiping.

- In extremely cold areas, expose the camera to the outer air only when in use. When using, expose the camera gradually to the outer air to prevent the lens from clouding.

- Do not keep the camera in a hot place such as a car globe compartment or the rear window shelf. It will cause a trouble with the camera.

- Do not expose the camera leaving it without the lens cap directly to the sun. It will cause a fog on the film.

Cleaning the Lens

Use a blower or a brush to remove dust on the lens. If you should get a fingerprint on the lens, soak a little pure alcohol or ether on lens cleaning tissue, then wrap the tissue around a matchstick and wipe the lens lightly in a circular motion.

Camera Body Number _____

Lens Number _____

Date of Purchase _____

Dealer's Name _____

