

Canon T90



E
English Edition
INSTRUCTIONS

INTRODUCTION

Thank you for purchasing the Canon T90. This camera is designed as a comprehensive package of the most advanced and innovative technologies available in the world today, balancing your photographic desires with automatic features — a state-of-the-art camera.

Your photographic range is heightened by 1) the built-in motor drive capable of winding film at a maximum of 4.5 frames per second with merely four size-AA batteries, 2) the high-speed PMS shutter permitting 1/4000 sec shutter speed and 1/250 sec flash synchronization, 3) the three switchable metering distribution patterns, and 4) a wide range of AE shooting modes responding to your photographic

needs. Meanwhile, complete automation in areas such as film transportation and film speed setting makes "multiple functions and simple operation" finally and fully compatible.

Your shooting options are further expanded by optional accessories like the Speedlite 300TL, the Macro Ring Lite ML-2, the Data Memory Back 90 and the Command Back 90.

For a full understanding of the T90, please read this instruction booklet carefully before using the camera.

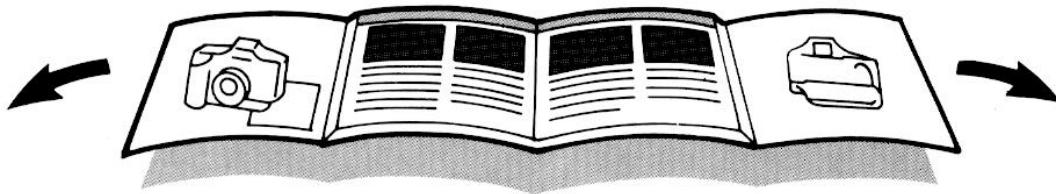

While reading these instructions unfold the front and back flaps of this booklet for easy reference to the camera's parts.

Nomenclature

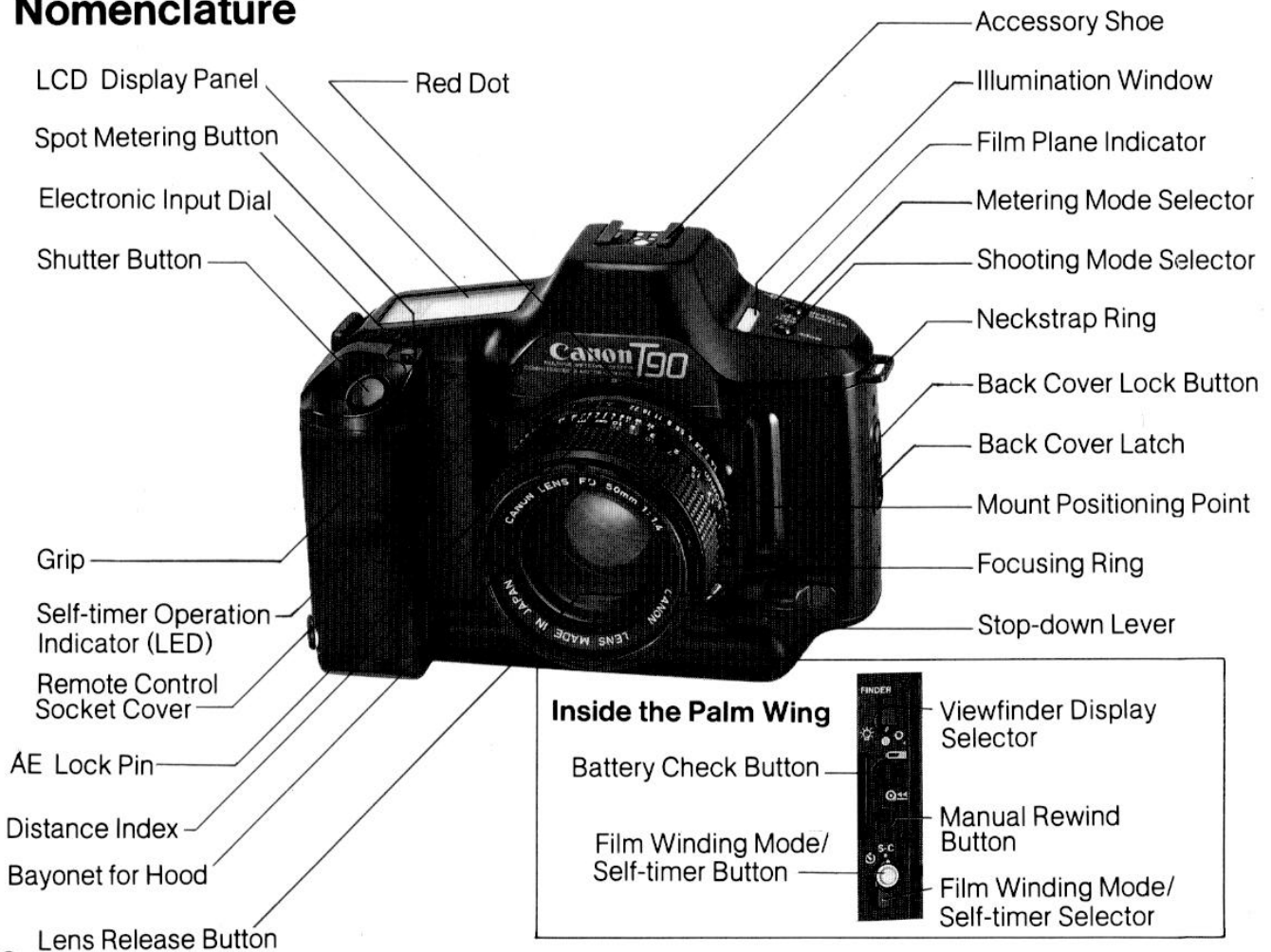

Contents

Preliminary Preparations	6	2 Aperture-priority AE	23
1. Attaching the Lens	7	3 Standard program AE	24
2. Setting the Lens for AE Photography	9	4 Variable-shift program AE	25
3. Loading the Batteries	10	<Setting Each Mode >	27
4. Turning on the Camera	11	3. Setting the Metering Mode	33
5. Checking the Batteries	12	<Metering Modes of the T90 >	33
6. Loading the Film	15	1 Center-weighted average	
<Automatic Setting of the Film		metering	33
Speed >	18	2 Partial metering	34
Shooting with the Lens Set on "A"		3 Spot metering	34
Mark (Basic Operation)	19	<Setting Each Mode >	35
1. Setting the Film Winding Mode	20	4. How to Use the Metering Modes	36
1 Single frame shooting	20	5. Focusing	38
2 Continuous shooting	20	6. Shooting	40
<Automatic Film Winding Speed		<Exposure Preview Button >	42
Changeover Function >	21	<Remaining Frame Counter >	42
2. Setting the Shooting Mode	22	<Viewfinder Display Selector >	44
<Shooting Modes of the T90 >	22	7. Automatic Film Rewind	45
1 Shutter-priority AE	22	<Manual Film Rewind >	47

4

Shooting with the Lens Set on "A"	
Mark (Intermediate Operation)	48
1. Spot Metering	49
1. One-point spot metering	49
<Exposure Level Difference	
Comparison >	50
2. Multi-spot metering	51
3. H/S Control	53
<Highlight control >	54
<Shadow control >	55
Shooting with the Lens off "A" Mark	57
1. Manual Override	58
2. Stopped-down AE	59
<Checking Depth-of-Field >	60
<Error Display >	61
3. Stopped-down (Fixed Index) Metering ..	62
<Manual Diaphragm Control >	63
<Film Plane Indicator >	64
4. Bulb	64
Other Shooting/	
Exposure Compensation	66
1. Self-timer Photography	66

2. Exposure Compensation	68
<Exposure Compensation Index > ...	68
3. Multiple Exposures	70
<Clearing the Preset Exposures >	71
<Changing the Preset Exposures > ...	72
<Exposure Compensation in Multiple	
Exposures >	72
4. Shooting with Infrared Film	73
5. Flash Photography	74
<Canon Speedlite 300TL >	74
<Other Canon Speedlites >	77
<Other Makers' Flashes >	77
Accessories	78
Caring for Your Camera	86
Other Notes	87
Exposure Warning Displays	90
Display Panel	94
Viewfinder Information	95
Specifications	96
Index	99
Carrying the Camera	103

Preliminary Preparations

6

1. Attaching the Lens



- 1) Turn the rear lens cap in the direction of the arrow until it stops, and pull it off the lens.
 - To attach the rear lens cap, align its arrow with the red dot on the lens. Then lightly push it in and turn it clockwise until it stops.



- 2) Turn the body cap counter-clockwise and pull it off.
 - To attach the body cap, first align its red positioning point with the red dot above the camera mount, then turn the cap clockwise.



- 3) To mount the lens, first align the lens' mount positioning point with the camera's red dot.

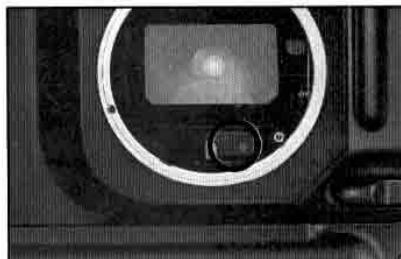

Do not mount the lens if the red dot inside the camera mount is showing; correct exposure is impossible if you do. In this case, push in the stop-down lever so that it locks in the normal position and this warning mark can no longer be seen.



- 4) Then turn the lens clockwise until it stops and the lens release button pops out with a click.
- To remove the lens, turn it counterclockwise while pressing the lens release button.



- 5) Remove the front lens cap.



Be sure to place the lens with its front end down to avoid damaging the protruding pins.

Lenses which cannot be mounted on the T90:

- FL 19 mm f/3.5
- FL 58 mm f/1.2

Lenses which cannot be used with the T90's meter for mechanical reasons:

- FL 19 mm f/3.5 Retro-focus
- FL 35 mm f/2.5

FL 50 mm f/1.8-I
 FL 58 mm f/1.2-II
 (Use of an independent exposure meter is recommended.)

2. Setting the Lens for AE Photography

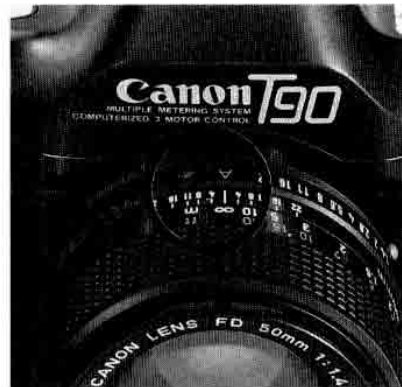
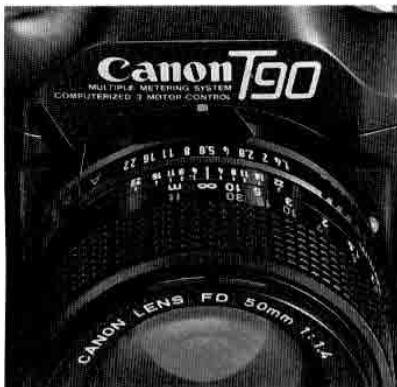

While pressing in the AE lock pin, turn the aperture ring in the direction of the arrow until the "A" mark click-stops at the distance index.

3. Loading the Batteries



1) As shown in photo, pull the battery magazine latch out first and then turn it in the direction of the arrow (OPEN). Pull the battery magazine out of the camera.

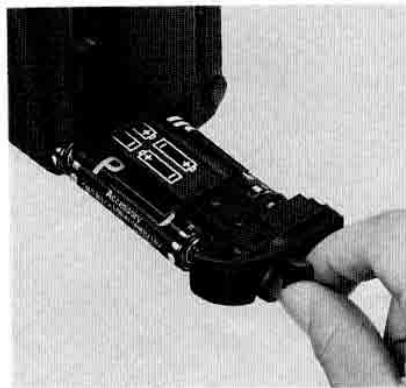

2) Load four new size-AA alkaline-manganese batteries (LR6) so that their terminals face in the directions indicated on the battery magazine. The camera will not function if the batteries are loaded incorrectly.



3) Insert the loaded battery magazine back in the camera. While pressing the latch firmly, turn it in the reverse direction to lock it.

When you replace the batteries with the camera mounted on a tripod, loosen the tripod screw slightly before replacing the batteries.

10

4. Turning on the Camera

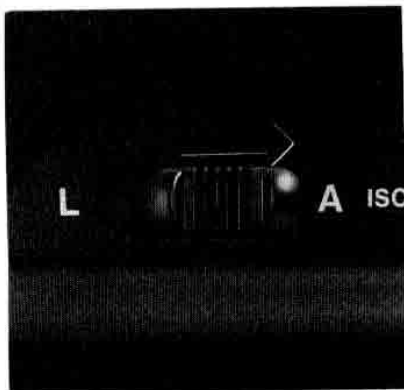

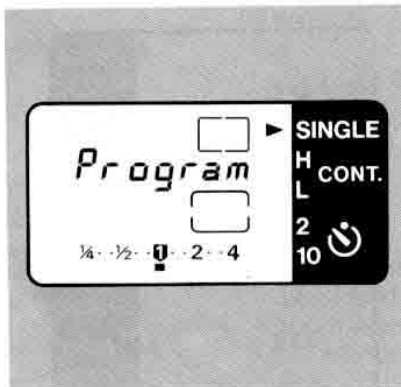

Slide the main switch to "A". The display will come on at this time. If the display does not appear, confirm that the batteries are loaded correctly.

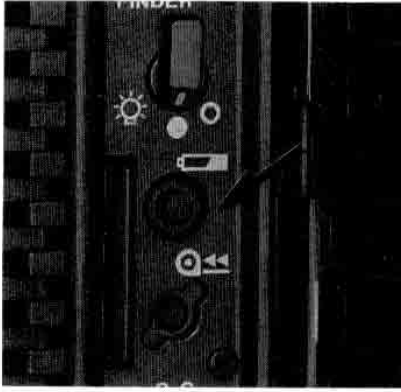

(example)

5. Checking the Batteries



Open the palm wing on the side of the camera and press the battery check button (). Battery voltage is then shown on the display panel.

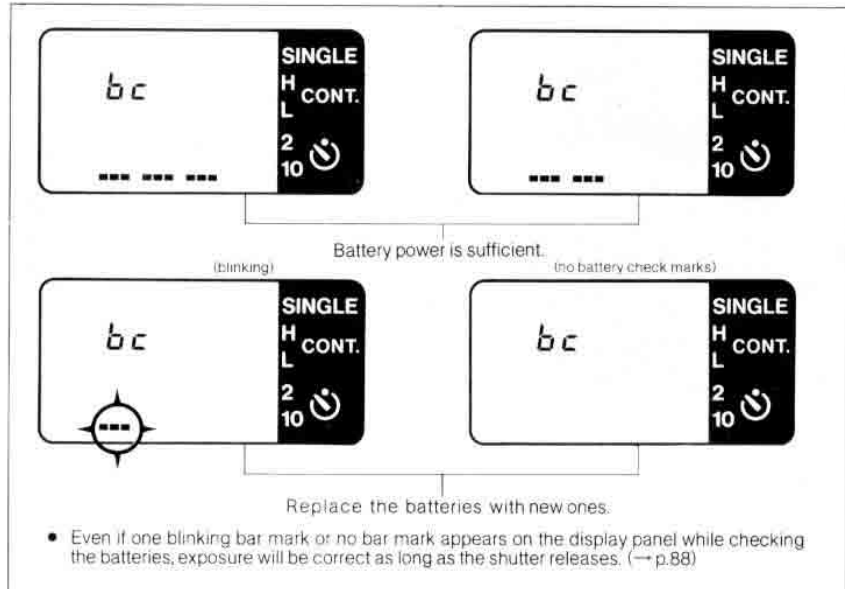

12

< Batteries >

This camera will not operate without batteries. Try to make a habit of checking the batteries at the following times.

- After loading new batteries.
- After storing the camera for a long time.
- If the shutter does not release.
- When you are using the camera in low temperatures.
- Before shooting important events.

Use a new set of batteries as specified below or equivalent batteries of another brand.

1. Four AA size 1.5 V alkaline batteries LR6 (AM-3)
2. Four AA size 1.5 V carbon-zinc batteries R6 (SUM-3)
3. Four AA size 1.2 V Ni-Cd batteries

Notes

- Always use four new batteries of the same brand and replace them at the same time.
- Wipe the battery terminals and the camera contacts with a clean, dry cloth before loading, to ensure proper contact.
- Remove the batteries if you do not expect to use the camera for about three weeks or longer.
- When shooting in temperatures below 0°C (32°F), keep your camera and spare batteries close to your body or in a pocket to keep them warm until you are ready to take a picture. You can also use a set of Ni-Cd batteries which function well in low temperatures. — approx. 15 rolls in the HIGH mode and 45 rolls in the LOW mode at -20°C (-4°F) with 24-exp. film. (→ p.34)

13

- When using Ni-Cd batteries, please note that different brands have different types of terminals. Be sure to use a type which is suitable for the camera.
- Refer to the manufacturer's instructions for recharging Ni-Cd batteries.
- Three bars (—) may not appear on the display panel during the battery check, even if using fully charged Ni-Cd batteries, because of their low nominal voltage.
- The battery naturally discharges even when not in use, so try to check the batteries regularly.

14

6. Loading the Film



1) To open the back cover, push the back cover latch down, while pressing the back cover lock button.

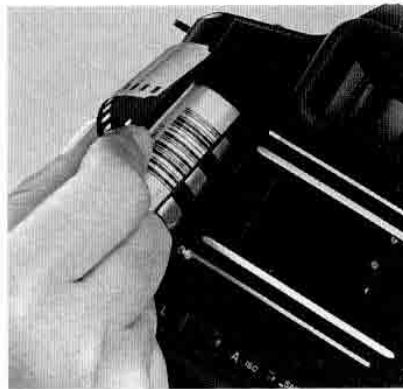

2) Insert the upper flat end of the film cartridge into the film chamber first, then lower the other end. The film-load check mark () will then appear on the display to indicate that film is loaded.

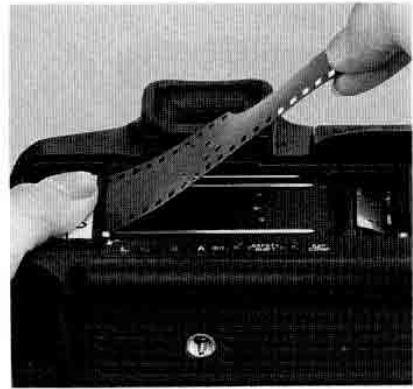

3) Pull the film leader across the back of the camera until its tip is aligned with the orange index.

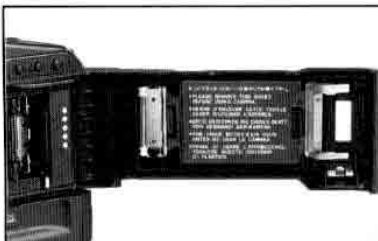

CAUTION

- Before loading the first film cartridge, remove the plastic insert and throw it away.
- NEVER touch the shutter curtain. It is sensitive to pressure due to its high precision design.
- Be careful that the film leader does not touch the shutter curtain, either.

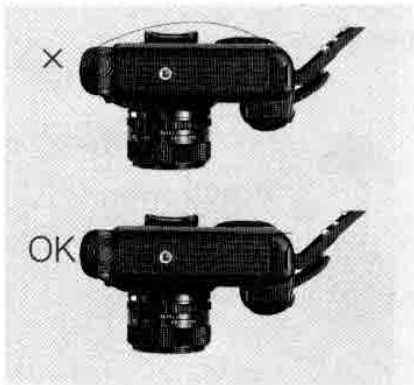

4) Make sure that the film has no slack and that its perforations are properly engaged with the sprocket teeth.



5) Close the back cover. The camera will advance the film automatically and stop when "1" appears in the frame counter brackets on the display panel.

If the film leader extends past the orange index, take out the film cartridge and manually wind the excess film back into the cartridge.

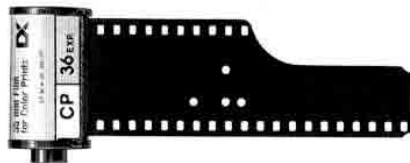

When the humidity is high, film becomes soft and is easily torn. Keep the film stored in its canister until just before you load it to keep it from tearing.

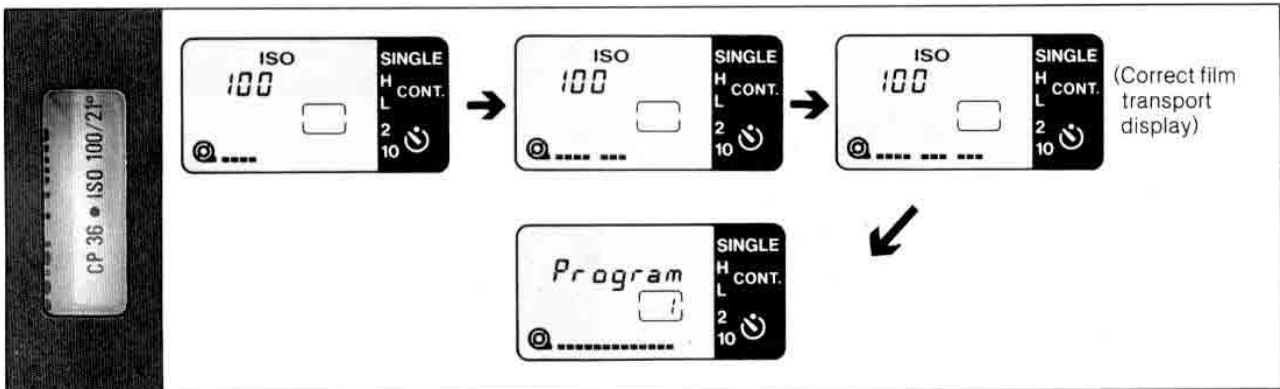

- You can confirm film loading through the film load check window.

- While the camera is advancing the film, the film transport bars (also serve as the battery check marks) will appear at the bottom of the display panel moving in sequence from left to right. If the film has not been correctly advanced, however, the bars blink after the camera has stopped. In that case, reload the film.

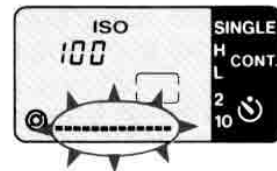



The T90 is designed to automatically set film speed by sensing the DX code marked on the film cassette.

1 When using a film with DX code, you do not have to set the film speed. (ISO 25–5000)

- The film speed automatically set according to the

DX code will appear on the display panel while the camera is advancing the film toward the first usable frame. (Refer to the left page.)

2 When using a film without DX code, set the film speed manually.

- 1) While pressing the film

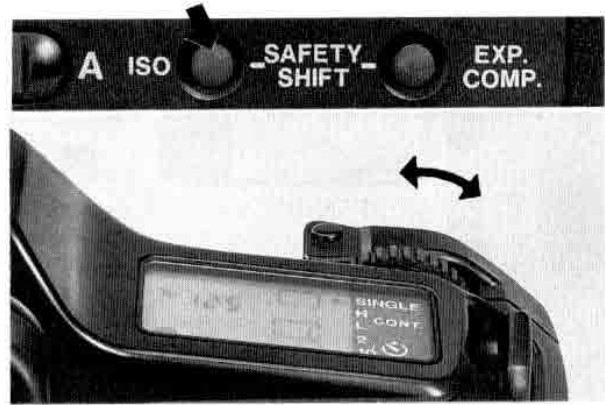

speed button, turn the electronic input dial until the film speed (indicated by ISO) of your film appears on the display panel. (ISO 6–6400)

- 2) Remove your finger from the film speed button.

- The preset film speed will appear and blink on the display panel to warn you if the film speed is not set. Always be sure to set the film speed correctly. (Once the film speed is set, the warning stops.)

Film passing through X-ray examinations at airports, even when loaded in a camera, may be exposed and ruined. To avoid accidental exposure, tell the inspector you want your camera and film hand checked.

Shooting with the Lens Set on "A" Mark (Basic Operation)

1. Setting the Film Winding Mode

Shooting Capacity (with 24-exp. film)

Temperature \ Battery	Film winding mode	Alkaline (LR6/AM-3)	Carbon-zinc (R6/SUM-3)
Normal (20°C/68°F)	HIGH	75	10
	LOW	150	30
Low (-10°C/14°F)	HIGH	—	—
	LOW	7	3
Low (-20°C/-4°F)	HIGH	—	—
	LOW	1	—

(based on Canon's standard test method)

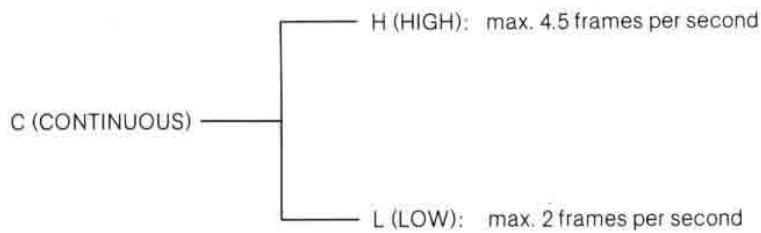

S (SINGLE): single frame

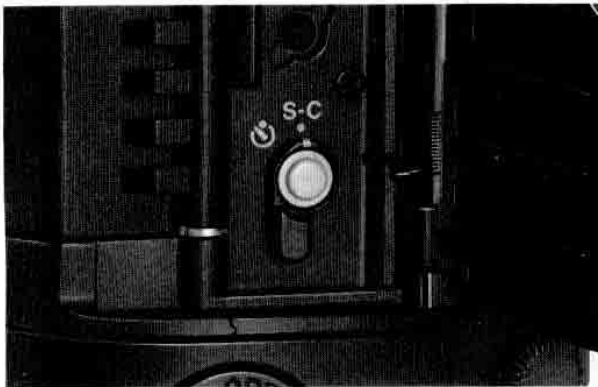
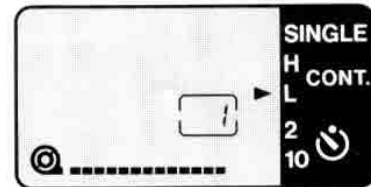
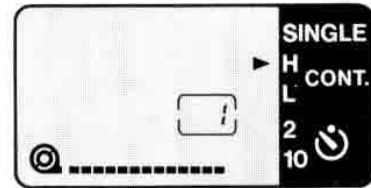
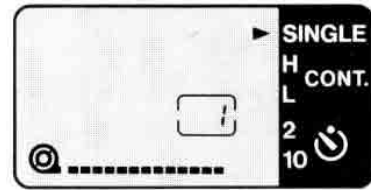

- 1) Open the palm wing and set the film winding mode/self-timer selector to "S-C".
 S-C : film winding mode setting
 : self-timer setting (→ p.66)
- 2) Press and release the film winding mode button (also serves as the self-timer button) to set the desired film winding mode on the display panel.

Automatic Film Winding Speed Changeover Function

The Canon T90 has an automatic film winding speed changeover function which will change the film winding speed from HIGH to LOW mode when battery power drops below a prescribed voltage. This saves battery energy and extends battery life, so more pictures can be taken with the same batteries.

When the winding speed is automatically switched to the LOW from HIGH, the "▶" mark pointing at the HIGH on the display panel starts blinking to warn you.

In this case:

- 1 If you wish to drive the camera in the HIGH mode, replace the batteries with new ones.
- 2 If you want to make the blinking "▶" stop, though you continue to shoot in the LOW mode, press the film winding mode button to set the "▶" mark to LOW mode on the display panel.

2. Setting the Shooting Mode

< Shooting Modes of the T90 >

The Canon T90 has various shooting modes to meet your needs and what you want your picture to portray. The following is an explanation of the shooting modes in which the FD lens must be set to the "A" mark. (AE photography is possible only with FD lenses.)

1. Shutter-priority AE (with safety shift function)

You set the shutter speed and the camera automatically chooses the correct aperture for the lighting conditions. This mode is useful for taking pictures of moving subjects and for normal snap shots. By controlling the shutter speed, you can also control the subject's movement. Faster shutter speeds freeze subject motion while slower shutter speeds can provide artistic blur effects.

< Shutter-priority safety shift function (ON/OFF possible) >

If the selected shutter speed is too slow or too fast for the light conditions, the T90 automatically switches the shutter speed to a higher or a lower one to avoid under- or overexposure.

Shutter-priority AE with safety shift function
(when the shutter speed is set to 1/125 sec, the FD 50 mm f/1.4 lens and ISO 100 film is used)

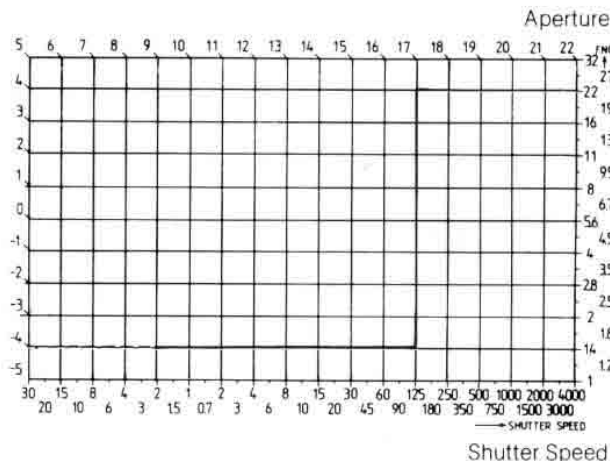

22

2. Aperture-priority AE (with safety shift function)

You set the aperture and the camera automatically chooses the correct shutter speed for the lighting conditions. This mode is useful for portraits, landscapes and still life photography in which depth of field, i.e. the range of in-focus images is an important factor.

< Aperture-priority safety shift function (ON/OFF possible) >

If the selected aperture is too large or too small for the lighting conditions, the T90 automatically switches the aperture to a smaller or larger one to avoid incorrect exposure.

Aperture-priority AE with safety shift function
(when the aperture is set to f/5.6, the FD 50 mm f/1.4 lens and ISO 100 film is used)

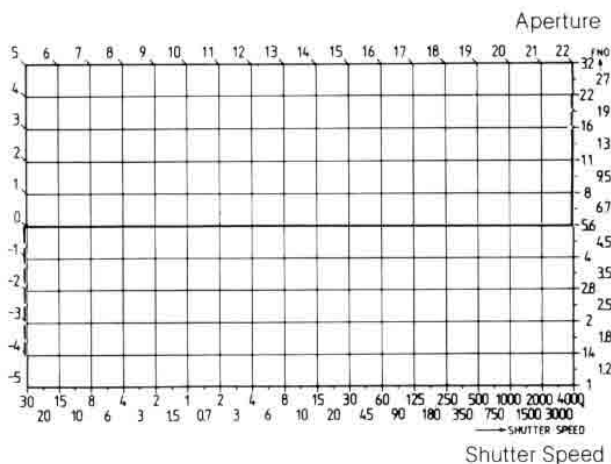

23

3. Standard program AE (Program)

Both the shutter speed and the aperture are automatically set according to the brightness of the subject and a programmed shutter speed/aperture combination. The standard program AE is the most popular programmed AE because it emphasizes neither the shutter

speed nor the aperture size. The program AE mode is convenient for those who are taking pictures with an SLR for the first time, those who do not like to worry about complicated operation, those who would simply like to concentrate on picture composition, or daily snap shots.

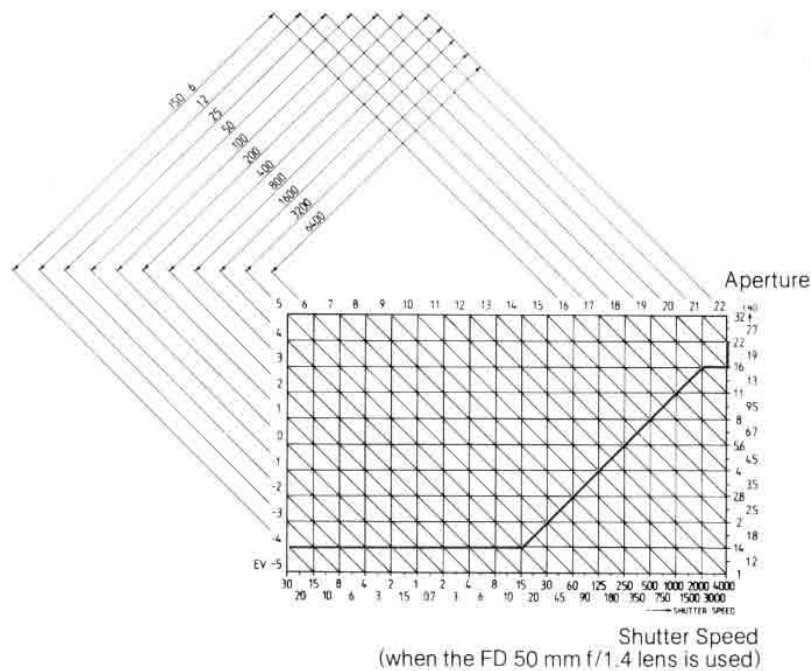

24

4. Variable-shift program AE

This is also the program AE mode as mentioned above, but there are 7 types of programmed characteristics in this mode. Choose any one of them according to your shooting objectives and the focal length of your lens.

1 Standard program AE (P)

This has all the same programmed characteristics as No. 3, but is displayed in "P" on the display panel while "PROGRAM" is displayed in No. 3. This mode is basically oriented toward the tele programs and the wide programs when using the electronic input dial.

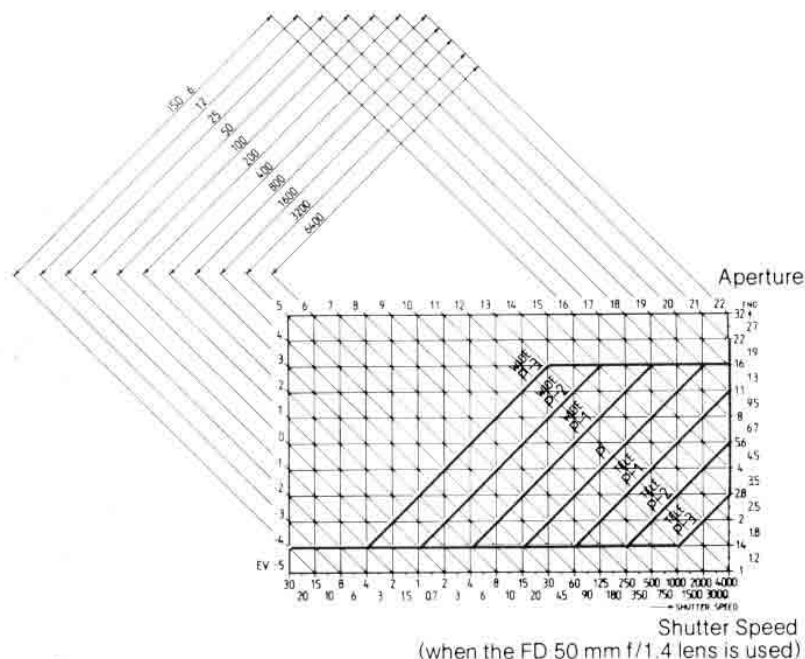

25

2 Tele Program AE (TELE 1 – TELE 3)

Tele program's shutter speed/aperture combination is programmed so that the camera chooses the fastest possible shutter speed. It is effective for emphasizing the main subject by making the depth-of-field shallower. It is also well suited to stopping action in, for example, sports photography. When using a telephoto lens, a small amount of blur due to camera shake, becomes accentuated because of its long focal length. This program's fast shutter speeds reduce the risk of blur.

3 Wide Program AE (WIDE 1 – WIDE 3)

The wide program chooses the smallest possible aperture, thus allowing a deep depth-of-field. It is suitable for bringing not only the main subject but also the background and foreground into sharp focus and so is appropriate for landscapes or large group shots.

WIDE P-3



STANDARD



TELE P-3



There are four other shooting modes, though the FD lens must be removed from the "A" mark.

Manual Override (→ p.58)

Stopped-down AE (→ p.59)

Stopped-down (Fixed Index) Metering (→ p.62)

Bulb (→ p.64)

26

<Setting Each Mode>

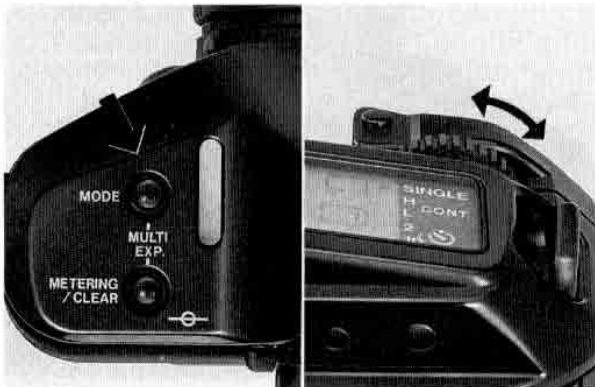

To select a mode, while pressing the shooting mode selector, turn the electronic input dial until the desired shooting mode appears on the display panel. (The display moves in the following cycle.)

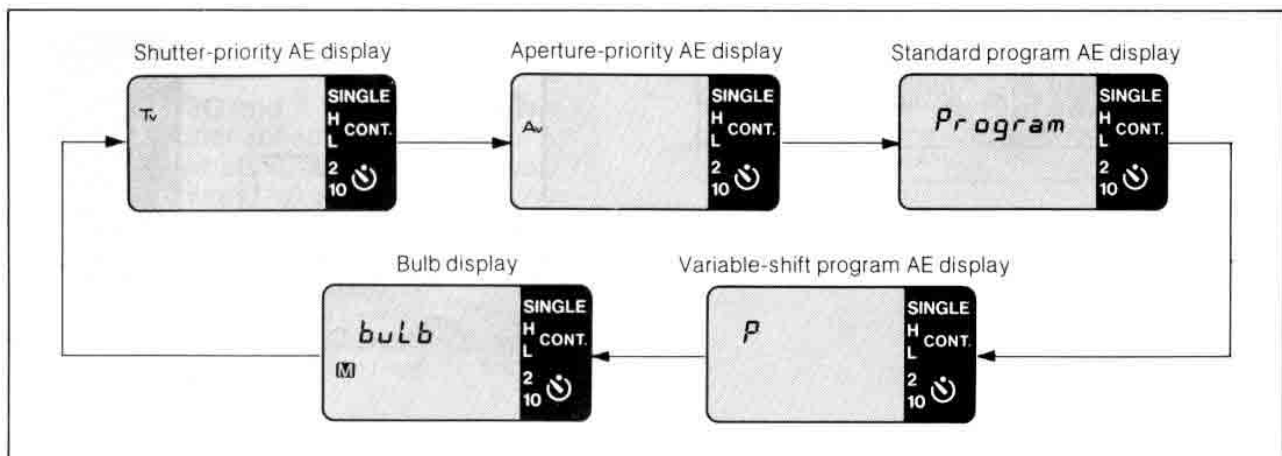

1. Setting the shutter-priority AE

- 1) While pressing the shooting mode selector, turn the electronic input dial until the "Tv" indicating the shutter-priority AE appears on the display panel.
- 2) Remove your finger from the shooting mode selector. At this point, the initial shutter speed setting is always 125. (1/125 sec)
- 3) Turn the electronic input dial until the desired shutter speed is displayed on the display panel.

Shutter speed display

4000	3000	2000	1500	1000	750	500	350	250					
180	125	90	60	45	30	20	15	10	8	6	4	3	2
0"7	1"	1"5	2"	3"	4"	6"	8"	10"	15"	20"	30"		

Note

The shutter speed is automatically set to 1/125 sec when switching to the shutter-priority AE mode from other modes.

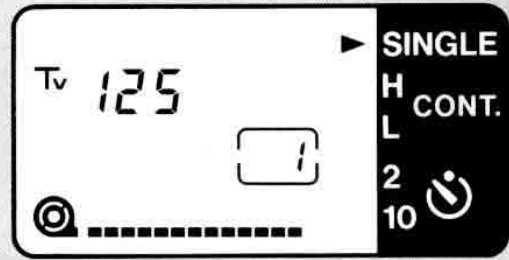
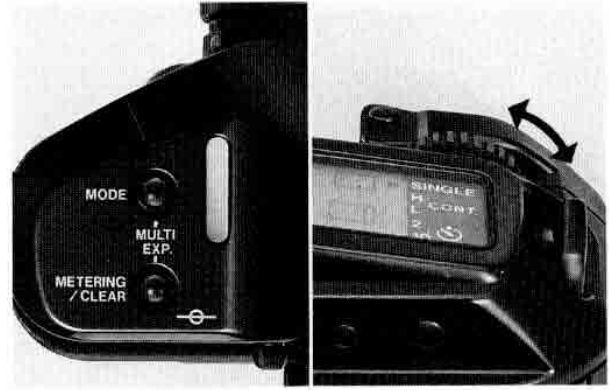

2. Setting the aperture-priority AE

- 1) While pressing the shooting mode selector, turn the electronic input dial until the "Av" indicating the aperture-priority AE appears on the display panel.
- 2) Remove your finger from the shooting mode selector. At this point, the initial aperture setting is always 5.6. (f/5.6)
- 3) Turn the electronic input dial until the desired aperture value is displayed on the display panel.

Aperture value display

1.2	1.4	1.8	2.0	2.5	2.8	3.5	4	4.5	5.6	6.7	8	9.5
11	13	16	19	22	27	32						

Notes

- The aperture is automatically set to f/5.6 when switching to the aperture-priority AE mode from other modes.
- Be sure that the aperture value set on the display panel is between the maximum and minimum aperture of your lens. Otherwise exposure will be incorrect. (e.g. when using the FD 50 mm f/1.4 lens, set the aperture between f/1.4 and f/22.)

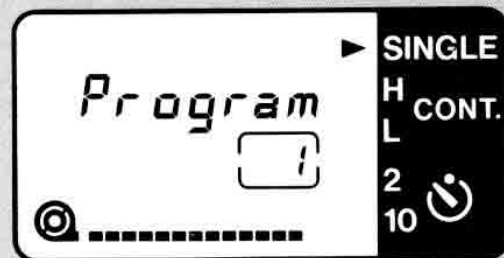
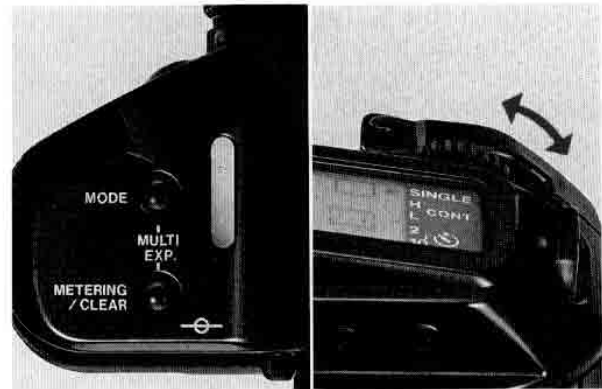

< Setting the Safety Shift Function >

- 1) Set the T90 to the shutter-priority AE (Tv) or the aperture-priority AE (Av).
- 2) Press both the film speed button and the exposure compensation button for approx. 1 sec.
- 3) The "SS" mark indicating the safety shift will then appear on the display panel and the safety shift function will be activated.
- 4) To clear the safety shift function, press both the film speed button and the exposure compensation button again until the "SS" disappears.

Note

Setting the safety shift function is possible in any mode, but is effective only in the shutter-priority AE and the aperture-priority AE modes.

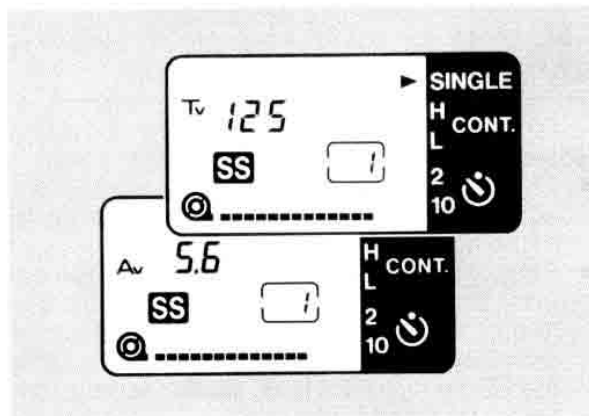
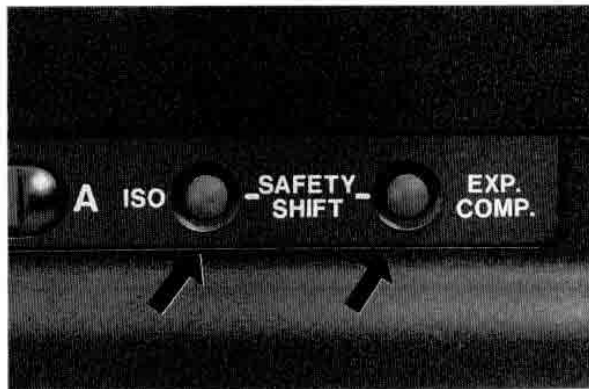

3. Setting the standard program AE

- 1) While pressing the shooting mode selector, turn the electronic input dial until "Program" appears on the display panel.
- 2) Remove your finger from the shooting mode selector.

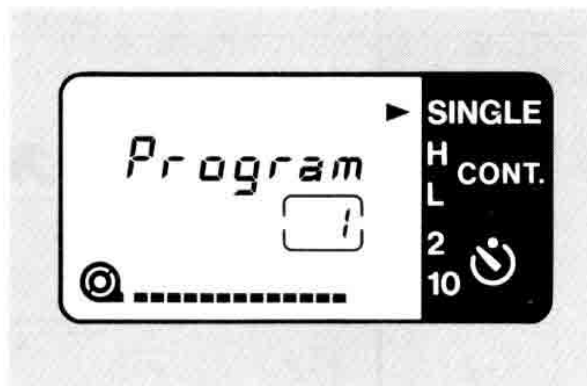
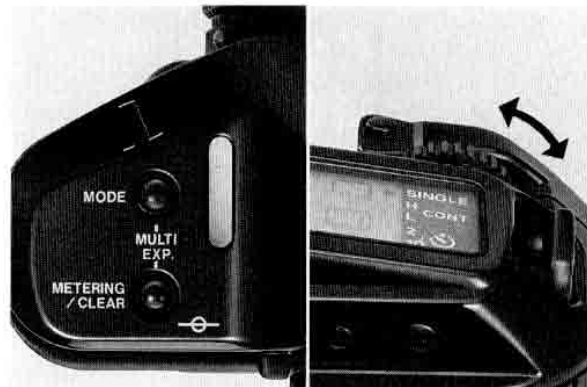

4. Setting the variable-shift program AE

- 1) While pressing the shooting mode selector, turn the electronic input dial until "P" indicating the variable-shift program AE appears on the display panel.
- 2) Remove your finger from the shooting mode selector.
- 3) Turn the electronic input dial until the desired program AE (any one of seven modes) is displayed on the display panel.

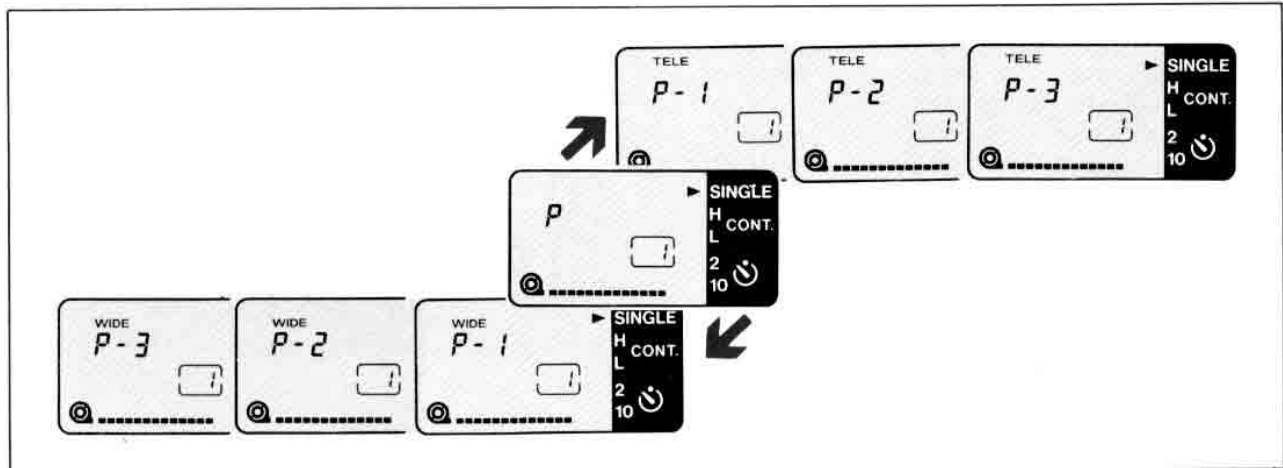
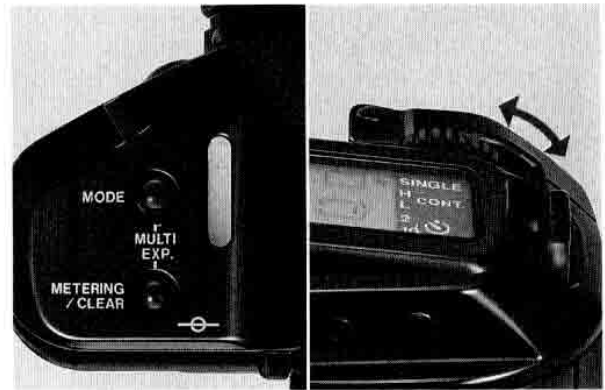

32

3. Setting the Metering Mode

< Metering Modes of the T90 >

With the T90, the metering mode, i.e, the metering sensitivity pattern, can be changed regardless of which lens you use or the subject you are shooting.

Do not use a linear polarization filter.

1 Center-weighted average metering

This is a convenient metering system for general photography under normal shooting conditions. The meter measures the entire viewing area, emphasizing the central portion where the subject is most likely to be and diminishing toward the edges.

(Metering sensitivity distribution pattern)

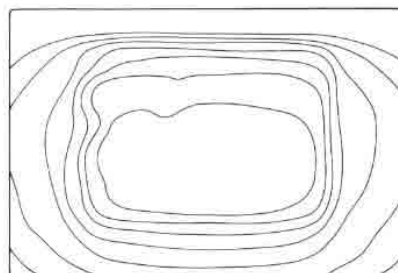
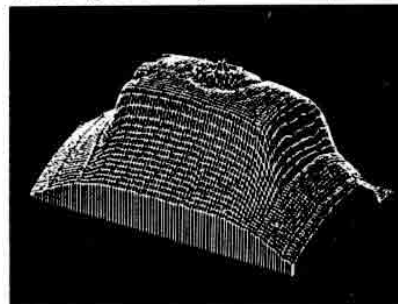

(When using FD 50 mm f/1.4 lens)

2 Partial metering

This system, with its 13% coverage of the field of view, allows you to meter only the central portion of the image in the viewfinder. It is particularly effective for metering backlit subjects, such as a person in front of a bright window.

(Metering sensitivity distribution pattern)

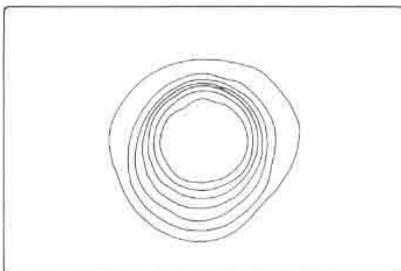
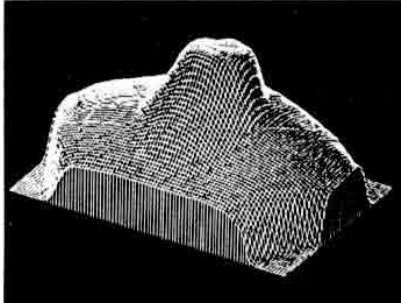

(When using FD 50 mm f/1.4 lens)

3 Spot metering

Spot metering is ideal for subjects which require precise measurement. Since the metering area is 2.7% of the field of view, you can select a small, exact area from the overall scene. It is especially advantageous for stage photography, photomacrography and photomicrography.

(Metering sensitivity distribution pattern)

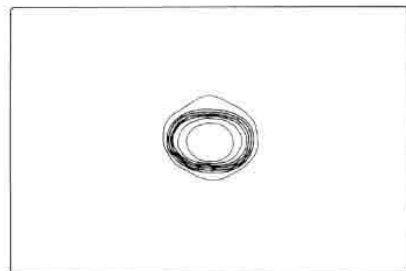
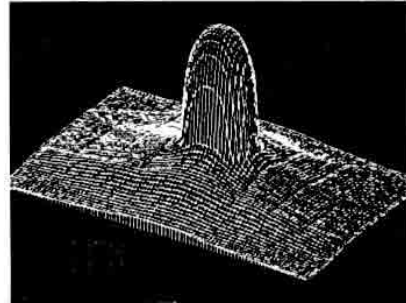

(When using FD 50 mm f/1.4 lens)

34

< Setting Each Mode >

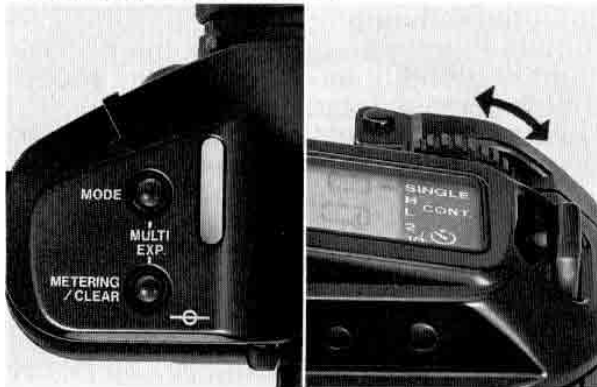

While pressing the metering mode selector, turn the electronic input dial until the desired metering mode appears on the display panel. (The display moves cyclically.)

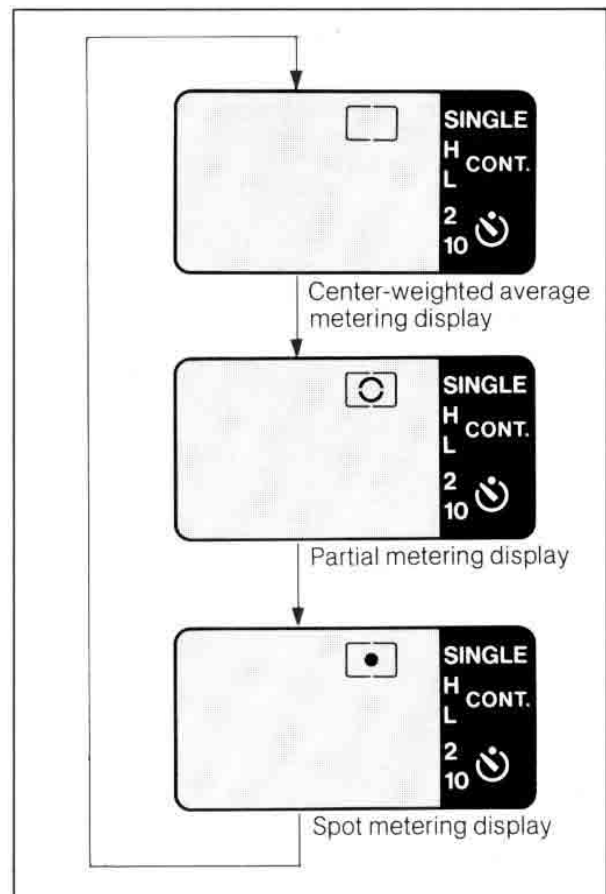

35

4. How to Use the Metering Modes

1 Center-weighted average metering

This is the normal setting position used for general photography, and is recommended especially for AE photography.

2 Partial metering

With this metering system, the AE lock mechanism is on as long as the shutter button is being pressed halfway down.

- 1) Put the main subject in the center of the viewfinder so that the partial metering mark covers it.
- 2) Press the shutter button halfway and compose the picture. A red "*" mark (AE lock LED) will then appear in the viewfinder.

- If desired, while continuing to hold down the shutter button, recompose the picture so that the subject is not in the center. The same exposure value is kept locked in the camera's memory by the AE lock function even when the picture is recomposed.

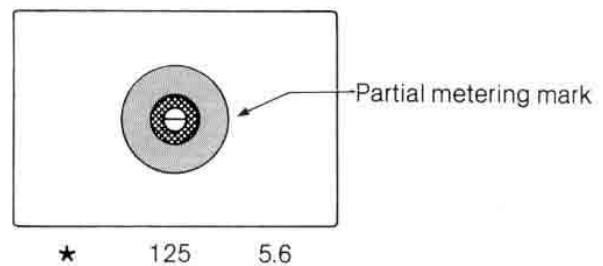

36



< Sequential AE lock photography >

When shooting continuously using the AE lock mechanism in the same lighting conditions (e.g. backlit subjects), it is not necessary to meter the subject for each shot as long as you keep the shutter button pressed halfway down between exposures.

Please see p.48 on how to use the spot metering mode.

37

5. Focusing



1) While looking into the viewfinder, turn the focusing ring until the main subject is sharp.

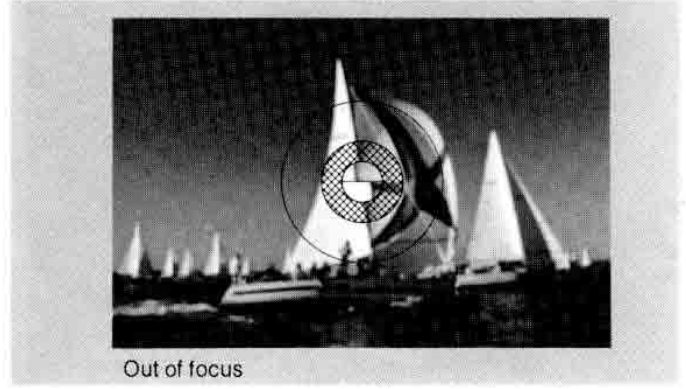

Out of focus

2) The subject is in focus when the upper and lower halves of the central split rangefinder merge to become one unbroken image.

38



In focus

New split rangefinder

This divides the subject in half horizontally. The subject is in focus when the two halves merge to become one unbroken image.

Microprism rangefinder

This breaks the subject into tiny fragments, causing a shimmering effect when out of focus. The subject is in focus when the image in the microprism ring is clear and not shimmering.

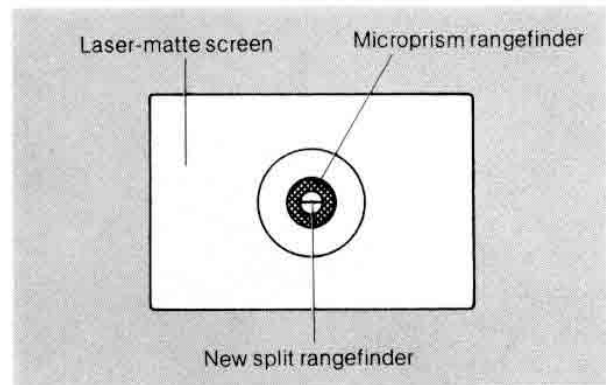

Laser-matte screen

This screen can be used on all surfaces. The subject is in focus when the image is not fuzzy.

The T90's focusing screen can be changed according to the subject you are shooting and the lens in use. (→ p.84)

6. Shooting

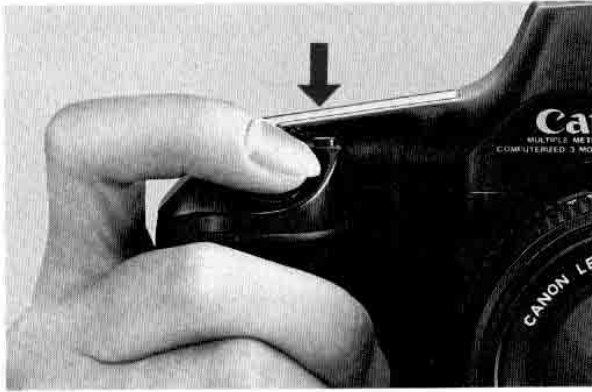

- 1) Gently press the shutter button halfway down to check the exposure. Exposure will be correct unless the aperture value and/or the shutter speed blink in the viewfinder.
- 2) Compose the picture and gently press the shutter button all the way to take the picture. The film will be automatically advanced to the next frame.
 - If the correct exposure is not possible, the aperture value and/or the shutter speed will blink in the viewfinder to warn you of incorrect exposure
 - Please see p.111 on the exposure warning displays and how to correct each case.

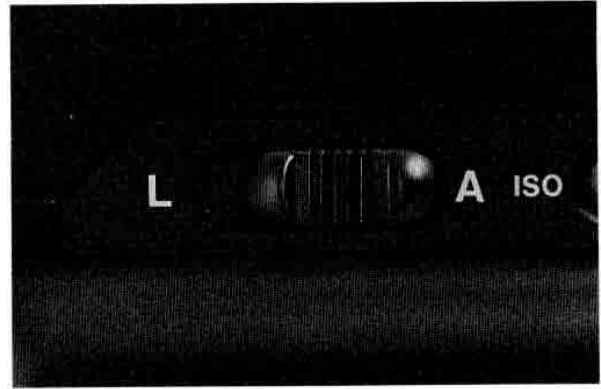

- 3) Slide the main switch to "L" to turn off the camera when shooting is finished.
 - Press the shutter button GENTLY for the least camera shake.
 - When shooting continuously, the viewfinder information will not be displayed. Your picture, however, will be correctly exposed since exposure will not be affected.
 - The film will be automatically advanced to the next frame after exposure and the frame counter on the display panel also indicates the next frame to be exposed.

40

<Viewfinder Information Examples >

Correct exposure (solid)

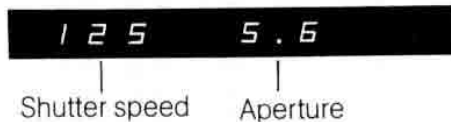

Incorrect exposure (blinking)

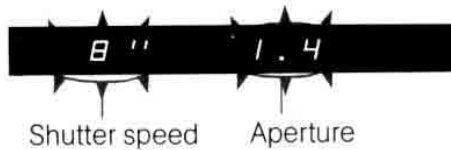
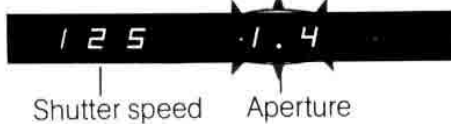

<Exposure Preview Button >

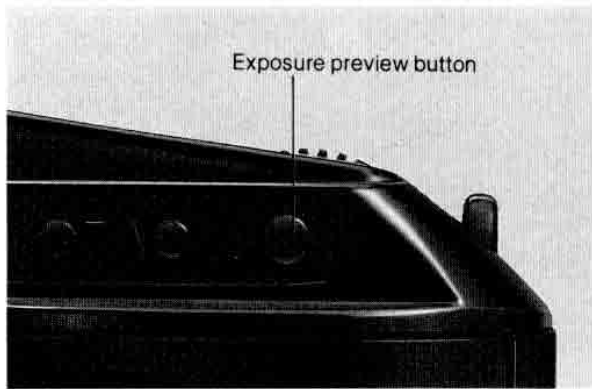

When you only want to check the exposure, press the exposure preview button instead of the shutter button. When the exposure preview button is pressed, the viewfinder information is turned on just as when the shutter button is pressed halfway.

- The exposure preview button is positioned so that you can press it while turning the electronic input dial.

<Remaining Frame Counter >

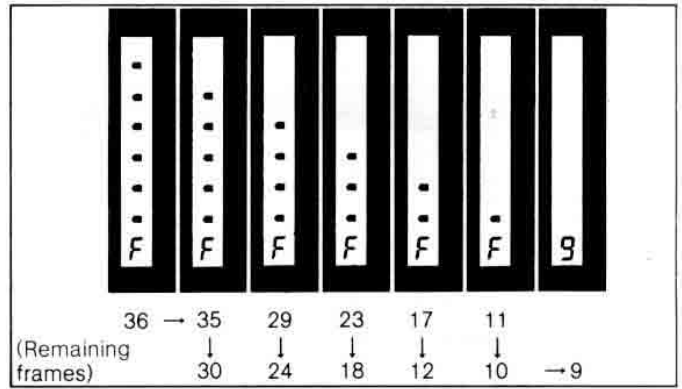

You can check how many frames remain any time, even during shooting, as displayed on the right of the viewfinder.

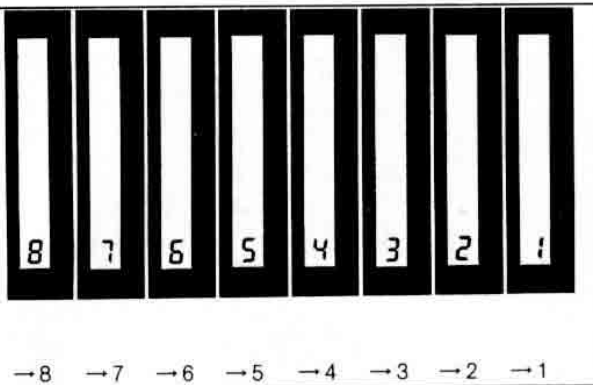

1 When using a film with DX code

The remaining frames are displayed on the right of the viewfinder by the "■" mark, "F" (Film) and the figure.

- The figure display appears only when the remaining frames has become less than 9.

When the T90 is used in the spot metering mode, the stopped-down (fixed index) metering mode or the FE lock mode together with the Speedlite 300TL, "■" mark is not displayed. (Only "F" and the figures from 1 to 9 are displayed.)

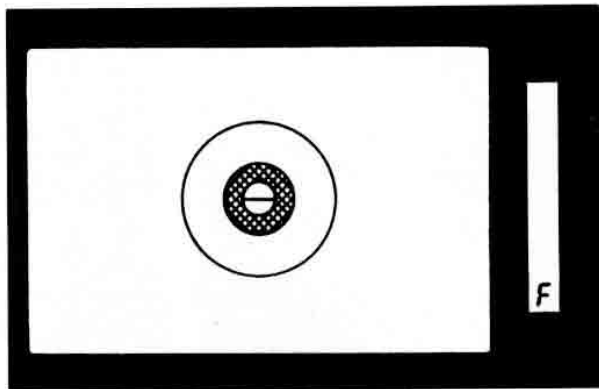

2 When using a film without DX code

The display is only "F".

<Viewfinder Display Selector >



All the viewfinder information (both the right and the bottom of the viewfinder) can be turned off to save battery consumption. The whole display panel and the viewfinder information on the right can be illuminated to make shooting in the dark easier. Use the viewfinder display selector inside the palm wing.

- : The entire viewfinder information can be turned ON.
- : The entire viewfinder information can be turned OFF.
- ☀ : The display panel and the viewfinder information on the right are illuminated when the shutter button is pressed half-way.

44

7. Automatic Film Rewind

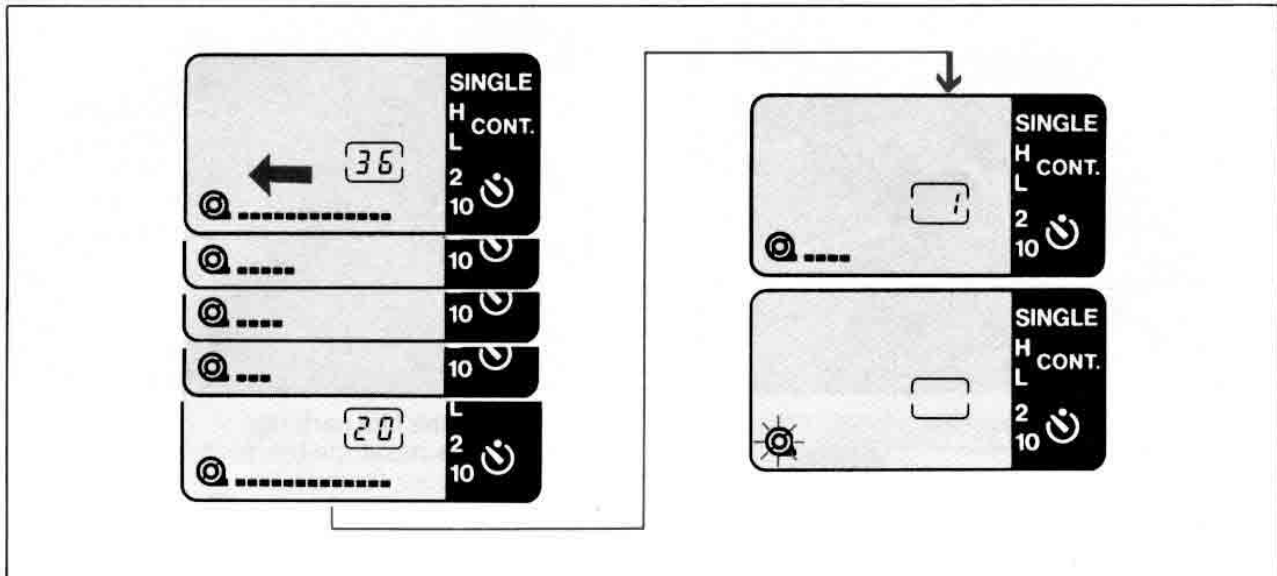

At the end of the roll, the camera rewinds the film automatically.

1) While the camera is rewinding the film, the film transport bars will move in sequence from right to left to indicate that the film is being rewound. At this time, the frame counter will count down.

2) Film rewind stops automatically when the roll is completely rewound, and the film load check indicator blinks.

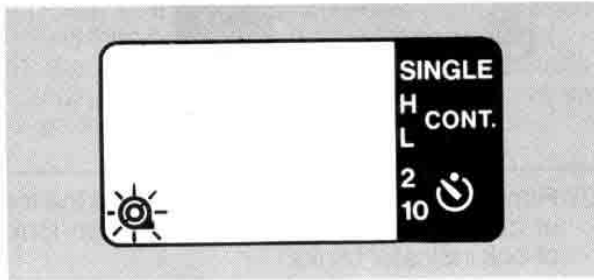
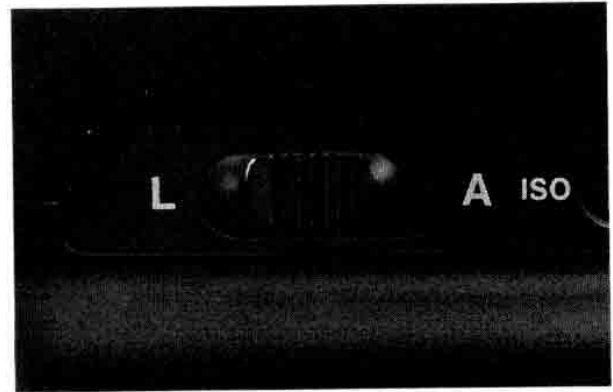

- 4) Remove the film cartridge.
- 5) Slide the main switch to "L" to turn off the camera.

- 3) Open the back cover when the film-load check mark (☀) starts blinking.

46

< Manual Film Rewind >

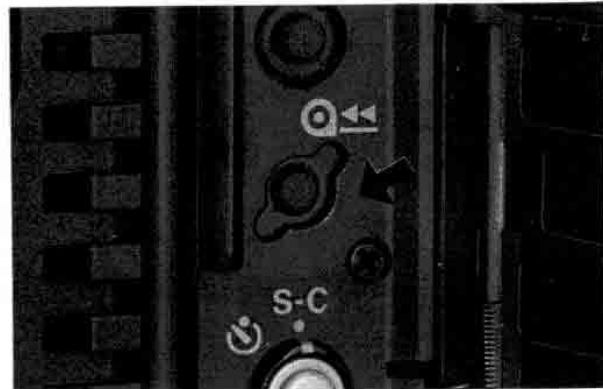

- If you want to rewind the film before the end of the roll, manual film rewind is possible.
- 1) Open the palm wing.

- 2) As soon as the manual rewind button (☀) is pressed, the camera starts rewinding the film.

47

1. Spot Metering

The spot metering can be used in the following three ways:

- 1 One-point spot metering
 - 2 Multi-spot metering
 - 3 H/S control
- When the shutter button is pressed halfway, the AE lock function works as in the partial metering mode (→p.36), and the sequential AE lock photography is also possible. (→p.37)

Shooting with the Lens Set on "A" Mark (Intermediate Operation)

48

1. One-point spot metering

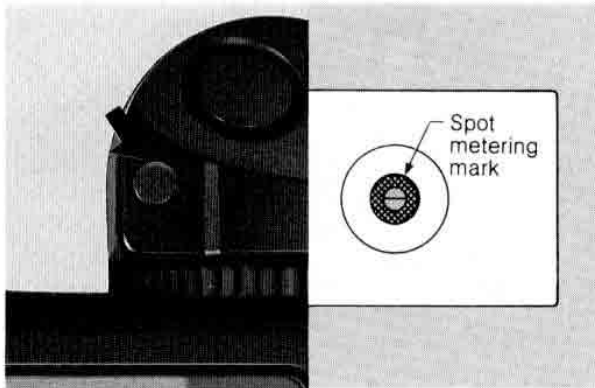

- Only one point is measured in the viewfinder.
- 1) Put the main subject in the center of the viewfinder so that the spot metering mark covers it.
 - 2) Press the spot metering button. As shown in the photo on the right page, when you want to take a picture of a glass backlit by a bright window, press the spot metering button so that it covers the glass. (When the subject transmits light exposure compensation is necessary.)
- When the spot metering button is pressed, both the shutter speed and the aperture are displayed at the bottom of the viewfinder. The fixed dot (●) will then appear at the position of the triangle index on the right of the viewfinder.

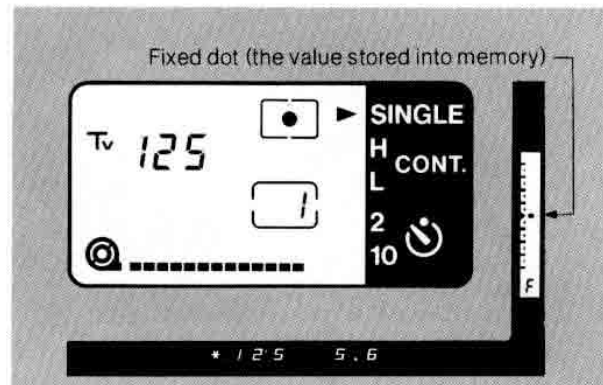

- When the spot metering button is pressed, the exposure value is kept locked in the camera's memory for 30 secs after you have removed your finger.
- The exposure value stored into memory in the spot metering mode is cleared under the following conditions:
 1. When more than 30 secs. have elapsed without releasing the shutter after the spot metering button has been pressed and the finger has been removed.
 2. When the metering mode selector is pressed.
 3. When the finger is removed from the shutter button after exposure.

49

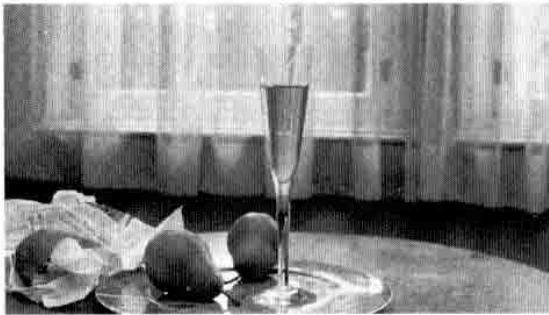

One-point spot metering is also possible by pressing the shutter button halfway. In this case, however, the exposure value is not stored into memory. When you remove your finger from the shutter button, the exposure value is cleared.

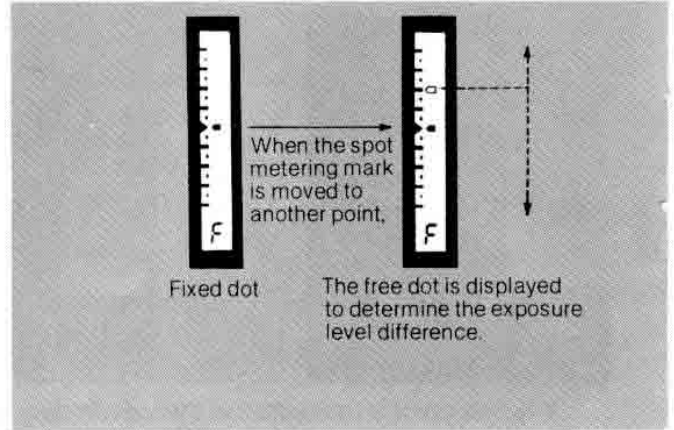

< Exposure Level Difference Comparison >

When you move the spot metering mark to another point of the subject after the spot metering button has been pressed, the new metering value (■) will appear to the right of the viewfinder as a free dot. You can check the exposure level difference between the main subject (stored into memory by the fixed dot) and another point of the viewfinder, that exists in the scene before pressing the shutter button.

- The free dot moves in the range of ± 4 steps. If the exposure level difference is ± 4.5 steps or more, the "▲" (+) or "▼" (-) indicator will be displayed instead of the "■" dot.

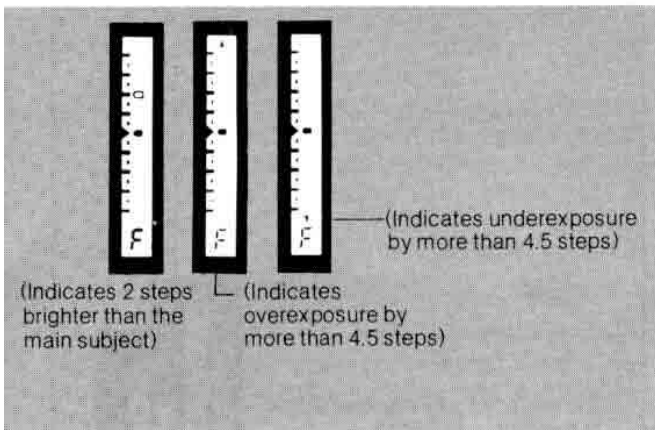

- In most cases, exposure compensation is necessary for the one-point spot metering. Please read the column of "H/S control" (→ p.69), too.
- In order to obtain correct exposure in the one-point spot metering, factors such as subject contrast pattern, reflectivity and latitude of the film in use must be carefully considered.

2. Multi-spot metering



Several points can be measured in the scene in the viewfinder, taking your measuring reference point into account.

- 1) As shown in the photo above, when you want to obtain correct exposure on her face and also want to obtain correct exposure on the background, press the spot metering button twice on her face and once on the background.

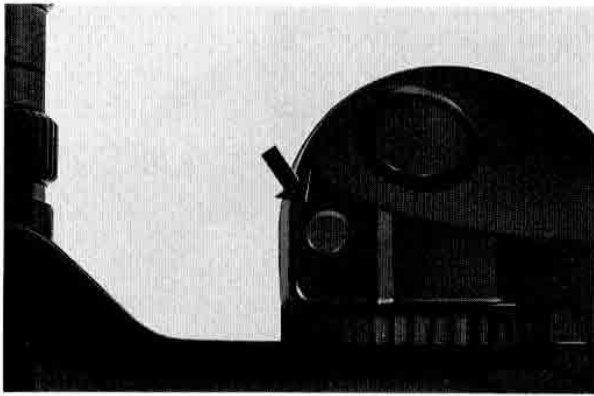

- 2) The final exposure is made by averaging each exposure value of the three points. The emphasis of the exposure is put on her face since it is metered twice and the correct exposure can be obtained, while even the exposure on the background can be maintained since it is metered once.
- The digital values of both the shutter speed and the aperture appearing at the bottom of the viewfinder are sequential weighted averages calculated each time a point is metered.
 - The triangle index in the center of the right-hand LCD is also used as the center point around which the other readings also marked by the "■" dot are divided.
 - When three points are measured, three fixed dots are displayed finally.

52

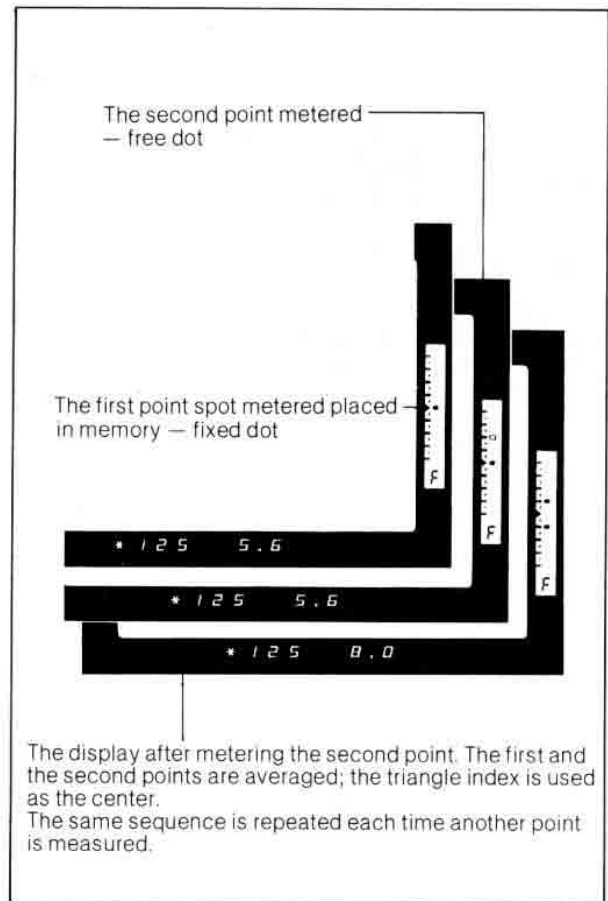

- The exposure value stored into memory in the multi-spot metering mode is cleared under the following conditions:
 1. When more than 30 secs have elapsed without releasing the shutter after the spot metering button has been pressed last.
 2. When the metering mode selector is pressed.
 3. When the finger is removed from the shutter button after exposure.

Multi-spot metering is only possible by pressing the spot metering button unlike the one-point spot metering. (→p.49)

Up to eight points can be metered using the multi-spot metering. Subsequent attempts will be disregarded.

3. H/S control

If your subject is either white or black, the whiteness and the blackness cannot be reproduced faithfully because of their unusual reflectivity of light and the result in either case will be "gray". The T90's H/S control is advantageous for the exposure compensation in those cases.

- "H" stands for "highlight" and is used when the subject is white, while "S" stands for "shadow" and is used when it is black.
- The H/S control can be used with both the one-point spot metering and the multi-spot metering. The following page explains how to use the H/S control in the one-point spot metering explained in consideration of its application.

<Highlight Control >

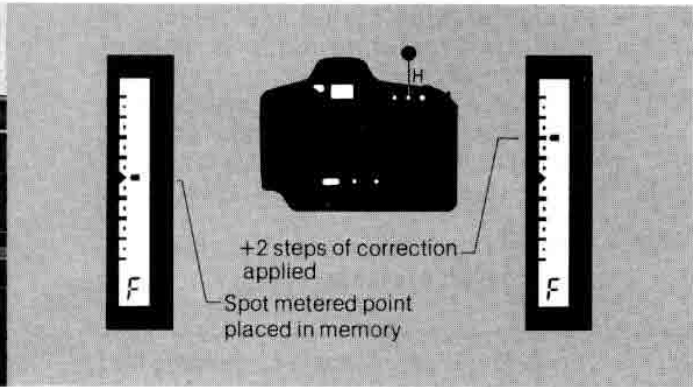
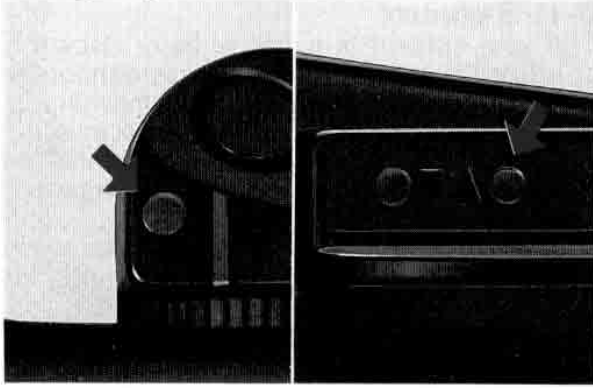

- 1) Press the spot metering button to indicate the fixed dot at the position of the triangle index.
- 2) When the highlight control button at the upper back of the camera is pressed and released, the dot starts moving upward to make compensation. Set the desired amount of compensation according to how bright the subject is.

54

<Shadow Control >

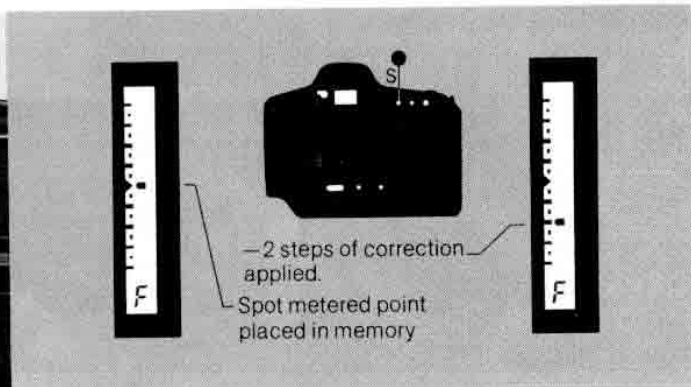
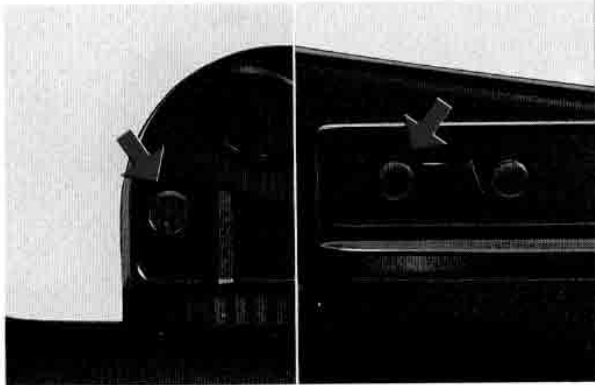

- 1) Press the spot metering button to indicate the fixed dot at the position of the triangle index.
- 2) When the shadow control button next to the highlight control button is pressed and released, the dot starts moving downward to make compensation. Set the desired amount of compensation according to how dark the subject is.

- The range of exposure compensation in the H/S control is up to ± 4 steps. If the amount of compensation is ± 4.5 or more, the "▲" (in the highlight control) or the "▼" (in the shadow control) indicator will be displayed in spite of the "■" dot.
- Each pressing of the H/S control button moves the dot by a 1/2 step. When the button is kept pressed, the dot moves in series by a 1/2 step at approx. 0.3 sec fixed interval.
- The exposure compensation value in the H/S control can be cleared by the same method as the one-point spot metering. (→ p.64)

55

Highlight Control Examples



0



+2



+2.5

Shadow Control Examples



0



-1



-2

56

- Figures indicate the amount of exposure compensation.

***Shooting with
the Lens off
“A” Mark***

57

1. Manual Override

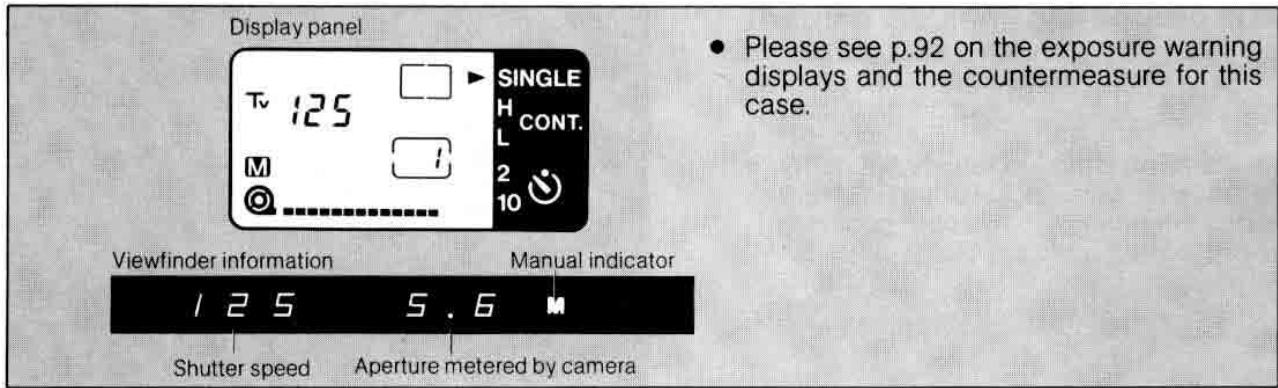

- Please see p.92 on the exposure warning displays and the countermeasure for this case.

This is a creative mode in which you can control exposure by setting both the shutter speed and the aperture as you like.

- 1) Set the display panel to "Tv".
- 2) Set the desired shutter speed by turning the electronic input dial.
- 3) Remove the lens from the "A" mark. An "M" will then be displayed on the display panel.
- 4) Set the desired aperture value to the lens manually, referring to the aperture displayed in the viewfinder. You must rely on your own experience for setting the exposure.

58

2. Stopped-down AE

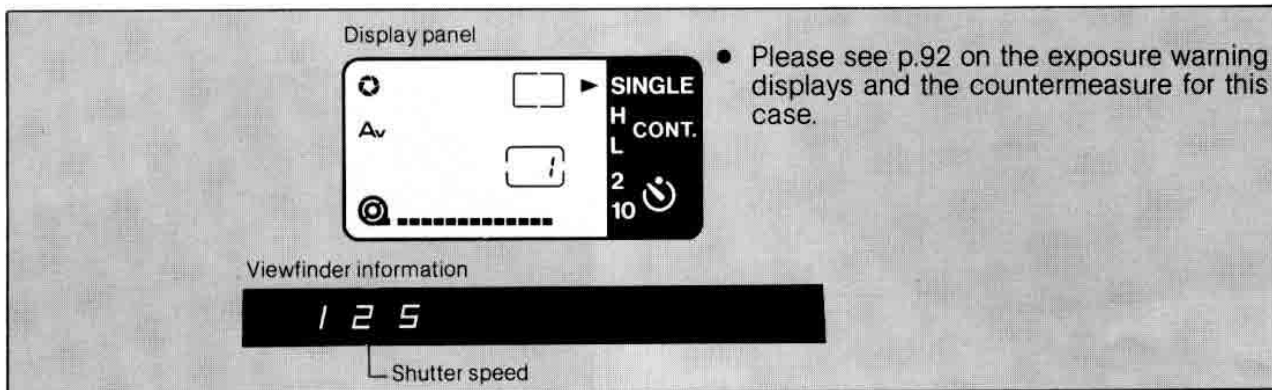

- Please see p.92 on the exposure warning displays and the countermeasure for this case.

It is necessary to use the stopped-down AE mode when using close-up accessories which have no FD signal pins, such as extension tubes or bellows in combination with an FD lens. You can take a picture while confirming the depth-of-field by pushing in the stop-down lever. This mode is also useful when using the Canon Reflex Lens or FL lenses and when using simple FD lenses.

- 1) Set the display panel to any one of "Av", "P", or "Program".
- 2) When using an FD lens, remove the aperture ring from the "A" mark.
- 3) Set the desired aperture value to the lens manually.

59

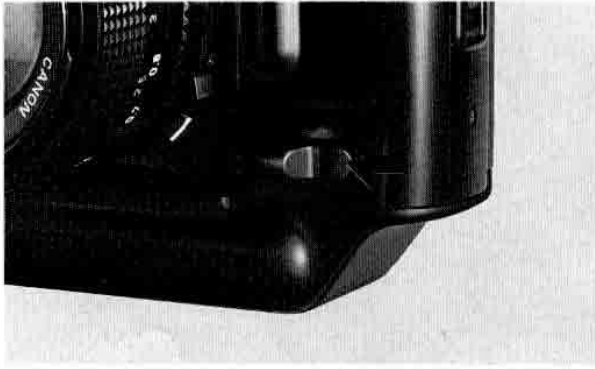

- 4) Push in the stop-down lever. A "⊙" mark will then be displayed on the display panel.
- 5) The camera sets the shutter speed automatically according to the aperture you have set on the lens.

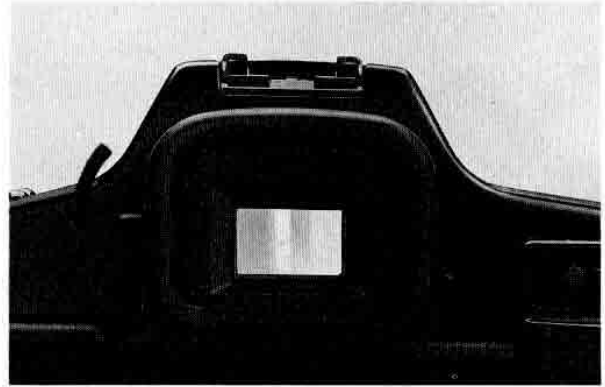

If your eye will not be at the viewfinder the moment you press the shutter button, close the eyepiece shutter by pushing the eyepiece shutter lever, to avoid stray light from entering.

When using the stopped-down metering with an FD lens attached directly to the camera body, use an aperture of f/2.8 or smaller.

<Checking Depth-of-Field>

When you check the depth-of-field with the FD lens, stop down the aperture by pushing in the stop-down lever as mentioned above. When you look through the viewfinder with the lever pushed in, you can see the range of sharpness, i.e. the depth-of-field.

<Error Display>

When you use the stopped-down AE mode with the FD lens, do not push in the stop-down lever with the lens set on the "A" mark. If you do, "E" marks indicating an error will appear to warn you of incorrect operation (EEEE EE in the viewfinder and EEE on the display panel), and the shutter is locked.

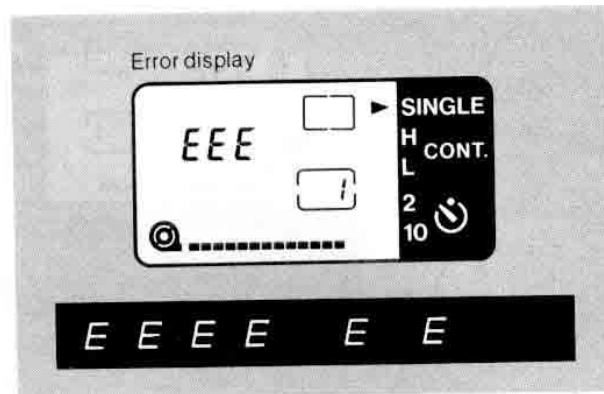

In this case, either push in the stop-down lever again to clear the stopped-down AE or remove the lens from the "A" mark. The error display will then disappear.

3. Stopped-down (Fixed Index) Metering

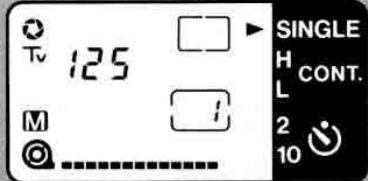

- Please see p.92 on the exposure warning displays and the countermeasure for this case.

Correct exposure	125	o	o	M
Underexposure	125	0	P	M
Overexposure	125	C	L	M

The shooting objectives of this mode are the same as for stopped-down AE mode, but this mode needs manual operation.

- 1) Set the display panel to "Tv".
- 2) Set the desired shutter speed by turning the electronic input dial.
- 3) When using an FD lens, remove the aperture ring from the "A" mark.
- 4) Push in the stop-down lever. An "⊗" mark will then be displayed on the display panel.

- 5) Check the exposure in the viewfinder.
 - In the viewfinder, any one of "OP", "oo", or "CL" is displayed as well as the shutter speed you have set. The meaning of each display is as follows:
 - OP : underexposure (Open the aperture.)
 - oo : correct exposure
 - CL : overexposure (Close the aperture.)

62

- 6) Turn the aperture ring of the lens until the "oo" is displayed.
- 7) Press the shutter button.
 - To the right of the viewfinder, "■" dot is displayed and it moves upward or downward as the aperture is changed. When the "oo" mark is displayed at the bottom of the viewfinder, the "■" is aligned with the triangle index.

- If the "OP" is still displayed when the aperture ring is turned to the maximum aperture of your lens, set a slower shutter speed on the display panel.
- If the "CL" is still displayed when the aperture ring is turned to the minimum aperture of your lens, set a faster shutter speed.

- Notes for this mode and the situations in which the error is displayed are all the same as for stopped-down AE mode. (→ p.59)
- underexposure display: indicates that the aperture must be opened.
- overexposure display: indicates that the aperture must be closed.

< Manual Diaphragm Control >



Stopped-down metering is necessary whenever you insert accessories, such as Extension Tubes M, between the camera and the FD lens for close-up photography.

- 1) Insert the slot of the accessory manual diaphragm adapter (optionally available) over the tip of the automatic aperture lever at the rear of the lens.
- 2) Push the lever counterclockwise and lower the adapter into the groove.
- 3) Mount the lens as it is onto the accessory.

Do not mount the lens with the manual diaphragm adapter directly onto the camera or the Auto Bellows etc.

4. Bulb (Long Exposure)

<Film Plane Indicator>

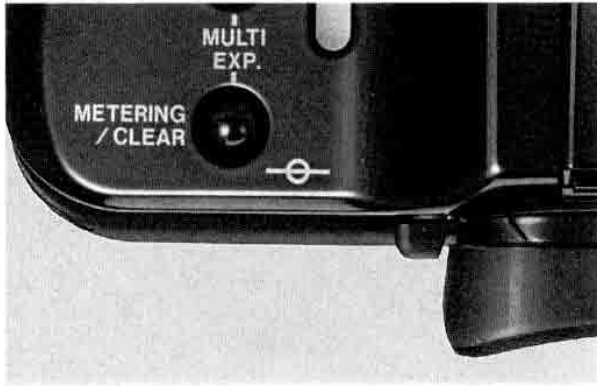

This mark, engraved on the top of the camera body, indicates the exact position of the film plane. It is useful for measuring the exact shooting distance from film to subject in close-up photography. Distances on the lens' distance scale are calibrated from this mark.

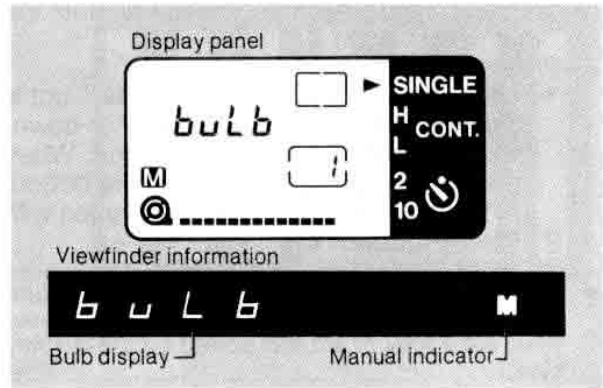

It is possible to make an exposure longer than 30 secs when doing such types of photography as astro or night photography.

- 1) While pressing the shooting mode selector, turn the electronic input dial until "buLb" appear on the display panel.
- 2) Manually set an aperture.
- 3) The shutter will remain open as long as you press the shutter button.

The Canon T90 is designed so that bulb exposure requires relatively little power, thus saving energy.

When using an FD lens, be sure to remove the aperture ring of the lens from the "A" mark.

64

- Bulb operation time is displayed on the display panel by a series of 3 bars and the numbers 1—30. Each bar mark (—) indicates 30 seconds. Exposure time up to 120 seconds is possible (3 bars plus 30).
- It is possible to control the exposure time within a range of 23 hours 59 minutes 59 seconds by using the Command Back 90 (optionally available).
- Use of a tripod and cable release is recommended when making long exposures.
- Please see p.92 on the exposure warning displays and the countermeasure for this case.

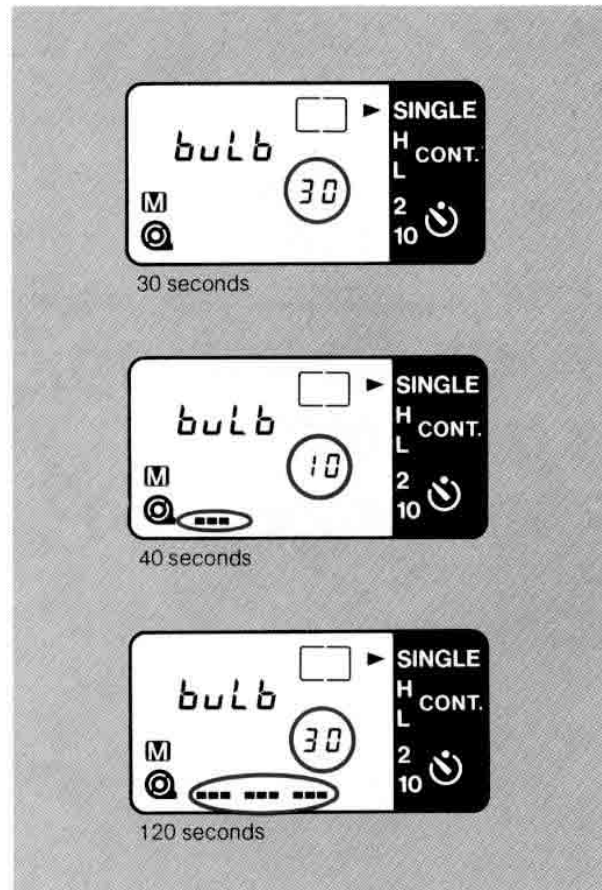

65

1. Self-timer Photography

Other Shooting/ Exposure Compensation

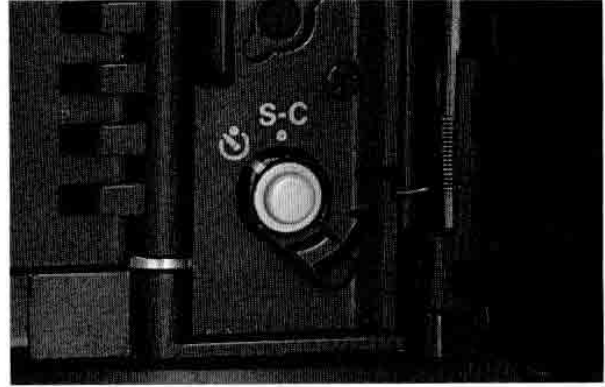

The self-timer allows you a time-lag of either 2 or 10 secs. Use the 10 sec self-timer when you want to be in the picture too, and use the 2 sec timer as an alternative to a cable release for the softest possible shutter release in close-up photography.

- 1) Open the palm wing and set the film winding mode/self-timer selector to "  ".

66

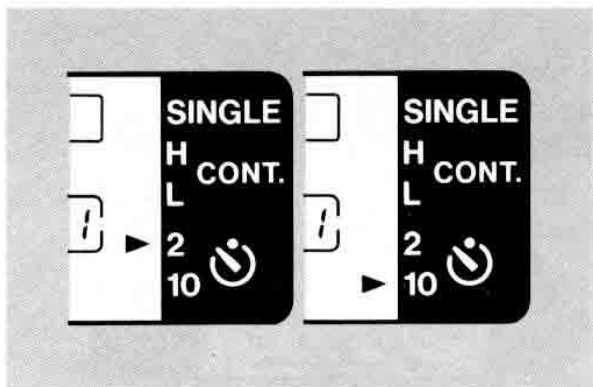



- 2) Press and release the self-timer button (also serves as the film winding mode button) to set either 2 or 10 secs. on the display panel.

- 3) Focus the subject and compose the picture.
- 4) Make sure the exposure is correct by checking the viewfinder information, then press the shutter button. The self-timer operation indicator will start blinking and the frame counter will display the countdown of seconds until shutter release.
- 5) The shutter will be released automatically 10 secs after the shutter button is pressed. 2 secs before shutter release, the self-timer operation indicator will begin blinking at a faster rate.
 - When the 2 sec timer is set, the self-timer operation indicator begins blinking at a faster rate.

If your eye will not be at the viewfinder the moment you press the shutter button, close the eyepiece shutter by pushing the eyepiece shutter lever to avoid stray light from entering. (→ p.60)

Do not stand in front of the lens when you press the shutter button or exposure may be incorrect.

If you have started the self-timer but wish to cancel it before shutter release, press the battery check button () inside the palm wing or move the film winding mode/self-timer selector off the "  " position.

67

2. Exposure Compensation

It is necessary to correct exposure in the cases, for example, when you want high-key (intentionally overexposed) or low-key (intentionally underexposed) shots, and when you take a backlit subject with center-weighted average metering. With the T90, exposure compensation is possible in the following two ways:

- 1 the exposure compensation index
- 2 H/S control in the spot metering (→p. 53)

<Exposure Compensation Index>



- 1) Press the exposure compensation button. The exposure compensation index will then appear on the display panel instead of the film transport bars.



- 2) While pressing the exposure compensation button, turn the electronic input dial to move the "■" dot under "0" to the desired point on the exposure compensation index.
 - "0" indicates that no exposure compensation is made.
 - It is possible to make the exposure compensation in increments as small as 1/3 f/stop.

68

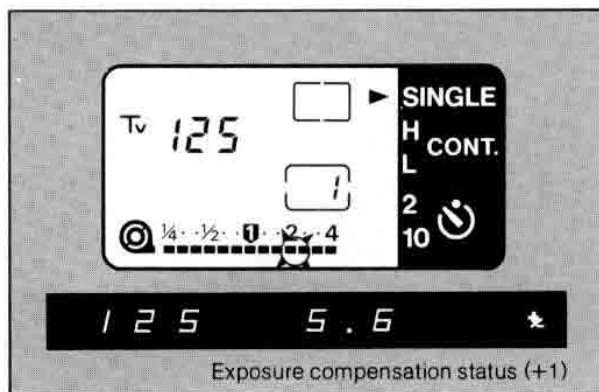

- 3) Remove your finger from the exposure compensation button. The film transport bars will appear on the display panel again, and "■" dot will blink at the position where you have moved it for exposure compensation. At the bottom of the viewfinder, "+/-" mark will be displayed to warn you that the camera is in the exposure compensation status.
- 4) To cancel the exposure compensation, move the "■" dot back to "0" position, in the same as above.

The whole numbers are for increasing exposure while the fractions are for reducing exposure. The numbers of "2" and "1/2" are equivalent to one f/stop (or one step of the shutter speed), while "4" and "1/4" are equivalent to two f/stops (or two steps of the shutter speed). The intermediate settings indicate increments of 1/3 f/stop.

When it is difficult to determine exactly how much correction to make, bracket the exposure by changing the position of the "■" dot.

3. Multiple Exposures

The T90's provision for multiple exposures allows you to easily make two or more exposures on the same frame for creative effects. Preset multiple exposures up to 9 times with the single operation of the electronic input dial and continuous multiple exposure photography are possible.

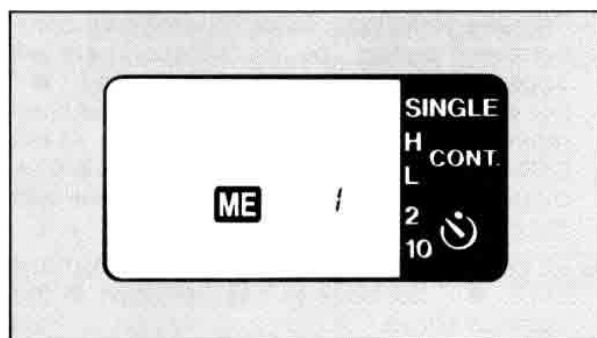
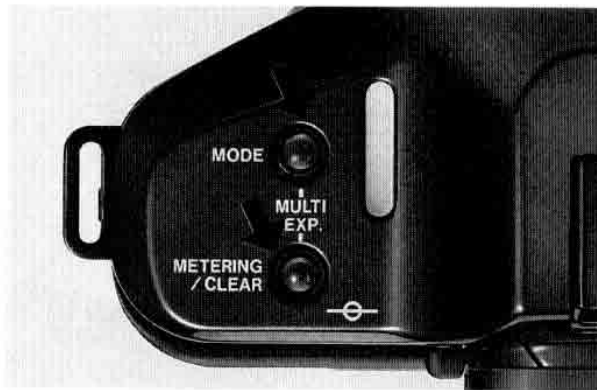

- 1) Press both the shooting mode selector and the metering mode selector at the same time. The " ME " mark indicating multiple exposure mode will then appear on the display panel and the frame counter will become "1".

70

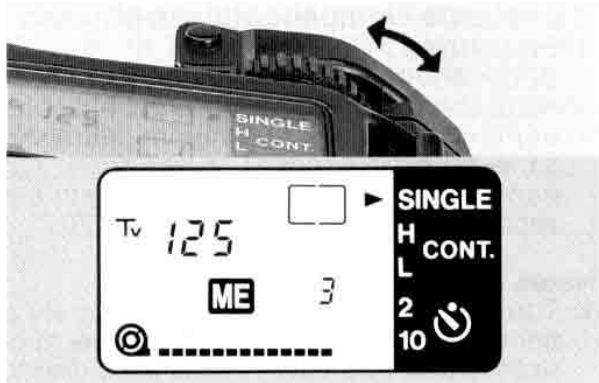

- 2) While pressing both selectors, turn the electronic input dial to the desired number of exposures (for example, set "3" on the frame counter if you want to make three exposures on the same frame.)
- 3) Remove your fingers from both selectors.
 - While shooting, the " ME " mark will flash on and off to warn you that the camera is in the multiple exposure status.
 - Each time the shutter is released, the preset number of exposures on the frame counter will decrement by 1.
 - When the preset number of exposures have been completed, the film is automatically wound to the next frame and the multiple exposure status is automatically cleared.

< Clearing the Preset Exposures >

1 Before shooting

- 1) Press both the shooting mode selector and the metering mode selector at the same time again.
- 2) While pressing both selectors, turn the electronic input dial to return the frame counter to "1".
- 3) Remove your fingers from both selectors. The " ME " mark will disappear and multiple exposure mode is cleared.

2 While shooting

The operating procedures are basically the same as above, but turn the electronic input dial until the frame counter is blank or there is no frame counter display in step 2).

71

< Changing the Preset Exposures >

1 Before shooting

- 1) Press both the shooting mode selector and the metering mode selector at the same time again.
- 2) While pressing both selectors, turn the electronic input dial to change the preset number of exposures.
- 3) Remove your fingers from both selectors.

2 While shooting

The operating procedures are all the same as above.

< Exposure Compensation in Multiple Exposures >

When you make multiple exposures, it is necessary to correct the amount of exposure depending on the situation because the same frame is exposed several times. You can easily correct the exposure with the exposure compensation index. (→ p. 68)

Notes

- 1 The method described above is merely a general guideline. The actual amount of exposure compensation varies according to the situation so your technique will benefit greatly from practice.
- 2 It is not advisable to make multiple exposures on the first or last several frames due to possible film curl which may adversely affect image registration.
- 3 Generally, the first exposure of a series should be of a relatively dark subject so that the image in the next exposure will show up clearly.

Number of multiple exposures	Exposure compensation index
Double	1/2
Triple	Between 1/2 and 1/4
Quadruple	1/4

72

4. Shooting with Infrared Film

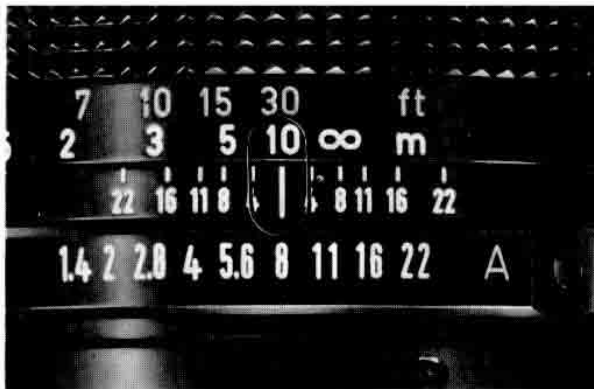

When you load the T90 with black and white infrared film, it is necessary to make a slight adjustment in focus. A red infrared index is engraved on most Canon lenses for this purpose.

- 1) Focus as usual looking through the viewfinder.
- 2) If, for example, the lens is focused at 10 m on the distance scale, turn the focusing ring to align the 10 m mark with the red dot.
- 3) Release the shutter after making this correction.



Notes

1. When using infrared film, it is necessary to use a deep red filter, as specified by the film manufacturer.
2. The position of the infrared index mark has been computed for the use of infrared film with peak sensitivity at 800 nm.
3. When using color infrared film, read the instructions of the film manufacturer.

73

5. Flash Photography

Canon developed the PMS (Permanent Magnet Shutter), which makes flash photography with an X-sync speed of 1/250 sec possible.

<Canon Speedlite 300TL >

The Canon Speedlite 300TL is an impressive flash unit for exclusive use with the T90. It has solved the problems of both conventional TTL and external flash systems. The main features are as follows:



74

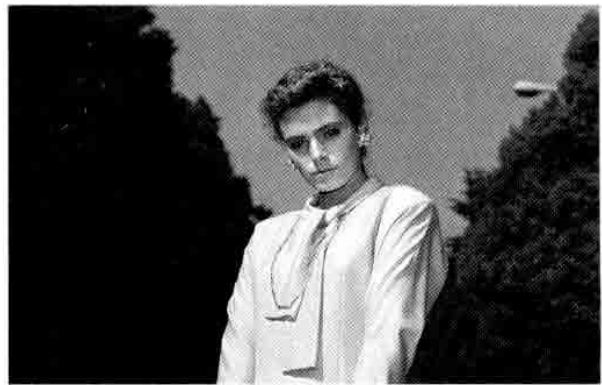

1. A-TTL Mode

This mode automatically responds to a wide range of illuminations from dark surroundings to bright, so automatic fill-in flash is possible. Using the TTL control system, this mode measures the light reflected from the film surface directly by the sensor inside the camera. In cases such as fill-in flash photography, this A (Advanced)-TTL mode balances the exposure level between the main subject and the background to prevent unnatural effects.



2. FE Lock TTL Mode

With the world's first spot metering for flash photography using the principle of AE lock, this mode gives correct exposure even when the main subject is not in the center of the viewfinder. TTL flash photography is possible without being affected by the reflectivity of the film in use since the TTL control system of this mode does not use the reflection from the film surface. Automatic fill-in flash is possible.

- "FE lock" stands for flash exposure lock.



3. FE Lock + H/S Control

It is also possible to use the FE lock mode of the Speedlite 300TL with the H/S control of the T90 to independently control the exposure level for the main subject with the flash and the exposure level for the background with the ambient light.

4. Second Curtain Synchronization

With the focal plane shutter, flash synchronization is made when the first shutter curtain is fully open. With the combination of the Speedlite 300TL, however, it is also possible to make the flash synchronization just before the second shutter curtain starts running.

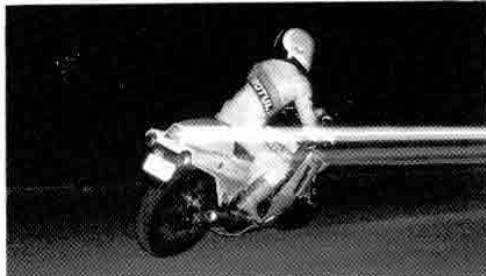

- First curtain synchronization (The flow of light is unnatural for the subjects' movement.)



- Second curtain synchronization (Natural)

At the "P" position even beginners can enjoy advanced techniques such as fill-in flash without fear of failure. Manual flash photography is done in the Manual Hi mode with a guide number of 30 (ISO 100·m) and in the Manual Lo mode at 7.5 (ISO 100·m). Aside from exposure control, the Speedlite 300TL performs bounce flash and has a built-in zoom mechanism in the head that utilizes energy more efficiently. The SE (Save-energy) function prevents unnecessary battery consumption if you forget to turn off the flash.

When using multiple flash accessories such as the TTL Hot Shoe Adapter, the TTL Distributor and the Off-camera Shoe Adapter with the Speedlite 300TL, automatic TTL multiple flash photography is possible with up to four flash units. (→ p.81)

Viewfinder Information

When the shutter button is pressed halfway, after the flash has been charged, you can confirm the exposure in the viewfinder.

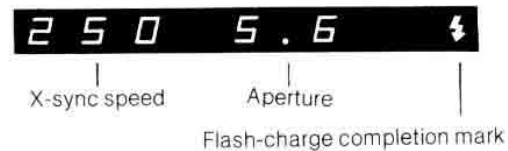

For further details, please consult the 300TL's instructions.

76

<Other Canon Speedlites>

1. T-series Speedlites

- PROGRAM mode→ The shutter speed is automatically set to 1/90 sec upon flash-charge completion. An aperture is selected automatically by the flash.
- F.NO.SET mode→ The shutter speed is automatically set to 1/90 sec upon flash-charge completion. An aperture is set on the flash manually.

2. 577G, 533G and A-series Speedlites

- The shutter speed is automatically set to 1/90 sec upon flash-charge completion. An aperture is set on the flash manually.

When using the Speedlite with the manual mode, for example, the 299T in manual flash mode, the X-sync speed will be 1/250 sec.

(When the lens is removed from the "A" mark and the T90 is set to the shutter-priority AE mode, the X-sync speed can be set between 30 and 1/250 sec.)

It is recommended that a Canon Speedlite be used with this camera. Using a flash (usually with more than two contacts) or flash accessory of another maker may cause the camera to work improperly or even possibly damage the camera itself.

<Other Manufacturers' Flashes>

1. Standard type flash → The X-sync speed can be set to 1/250 sec or slower.
2. Large studio type flash → The X-sync speed must be set to 1/125 sec or slower.

When the large studio type flash or the general cable connection type flash is used with the T90, the Canon Hot Shoe Adapter is required to connect the flash with the camera.

Accessories

Data Memory Back 90



The Data Memory Back 90 is an interchangeable camera back designed for exclusive use with the T90, and can memorize up to 16 types of exposure control data automatically. The Data Memory Back 90 has two modes; the standard mode for storing all 16 types of data and the reduced mode for storing the 6 types of data.

Primary data stored can be checked on the Data Memory Back's LCD monitor panel. In addition, like the Command Back 90, the Data Memory Back 90 can also imprint several data automatically.

DATA FUNCTION

1. Printing of the auto date up through the year 2099. (automatic compensation for leap years and long and short months)
2. Printing of the Day/Hour/Minute in a 24 hour format.
3. Printing of a frame counter number. (4-digit number)

Note

With the Interface Unit D.M.B. all data can be checked on the screen of an MSX personal computer. (Data Memory Back 90, Interface Unit D.M.B. and the MSX computer are not available in North America and some other areas.)

78

MEMORY FUNCTION

- Standard Mode (Data can be stored up to 156 frames.)
 1. Shutter speed
 2. Aperture value
 3. Shooting mode
 4. Metering mode
 5. Use flash or not
 6. Aperture stopped down or not
 7. Spot metering data*
 8. FE lock data*
 9. Use exposure compensation or not
 10. Amount of exposure compensation*
 11. Number of exposures made
 12. Film speed
 13. Use manual exposure or not
 14. Auto calendar (Year/Month/Day and Day/Hour/Minute)
 15. Auto frame counter (4-digit serial number)
 16. Lens in use
- Reduced Mode (Data can be stored up to 338 frames.) Six types of data (1, 2, 6, 11, 13 and 15 shown above) can be stored.

Note

* These items can only be displayed on the screen of an MSX computer connected to the Data Memory Back 90 through the Interface Unit D.M.B.

Command Back 90



The Command Back 90 is an interchangeable camera back designed for exclusive use with the T90. As the name "Command" suggests, it not only records data but also controls the T90 for various types of timed photography.

The following operations are possible using the quartz controlled Command Back 90:

DATA FUNCTION

1. Printing of the auto date up through the year 2029. (automatic compensation for leap years and long and short months)
2. Printing of the Day/Hour/Minute in a 24 hour format.
3. Printing of an arbitrary 6-digit number plus the letters A through F.
4. Printing of a frame counter number up to 4 digits.

79

TIMER FUNCTION

1. Self-timer (the shutter is released after a fixed period of time).
 2. Interval timer (the shutter is released at fixed intervals).
 3. Long release timer (the shutter is released and held open for a fixed period of time when the T90 is set to "buLb").
 4. Frame counter setting (the camera stops automatically after the set number of exposures has been made).
- The timer settings can be set to any value from one second to 23 hours, 59 minutes, 59 seconds.
 - It is possible to use both the data and timer functions at the same time.
 - It is possible to program the camera completely by combining modes 1—4 in the timer function.

Macro Ring Lite ML-2



The Macro Ring Lite ML-2 is an automatic flash unit for close-up shooting. It uses the TTL control system eliminating the need for exposure compensations. Separate flash tubes are arranged on the right and left sides, which can be fired together or independently for extra lighting versatility. The guide number is 11 (ISO 100·m).

80

Wireless Controller LC-2



This accessory is a remote control photography device which uses infrared rays to control the camera from a distance and is particularly useful in such areas as wildlife photography and news coverage. The Wireless Controller LC-2 consists of a transmitter and a receiver and has three modes; the standard mode, the delay mode and the auto sensing mode (activates when an object blocks the light path between the transmitter and the receiver).

Multiple Flash Accessories

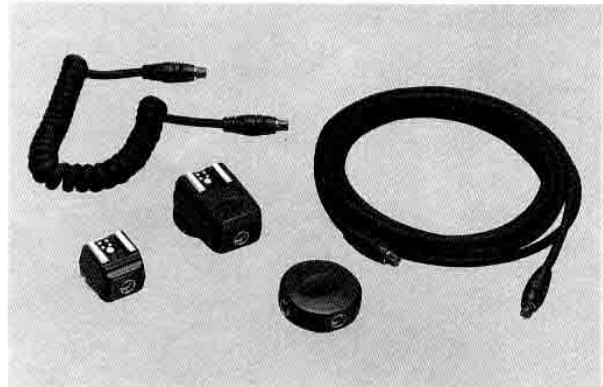

The accessories consist of the TTL Hot Shoe Adapter, the TTL Distributor, the Off-camera Shoe Adapter and the Connecting Cords 60 and 300. With the Speedlite 300TL and/or the Macro Ring Lite ML-2, automatic multiple flash photography by the TTL control system is possible using up to four flash units. The combination of the automatic TTL multiple flash is as follows:

1. With only the Speedlite 300TL (up to four)
2. With only the Macro Ring Lite ML-2 (up to four)
3. In combination with the both (up to four)

Dioptric Adjustment Lens with Eyecup

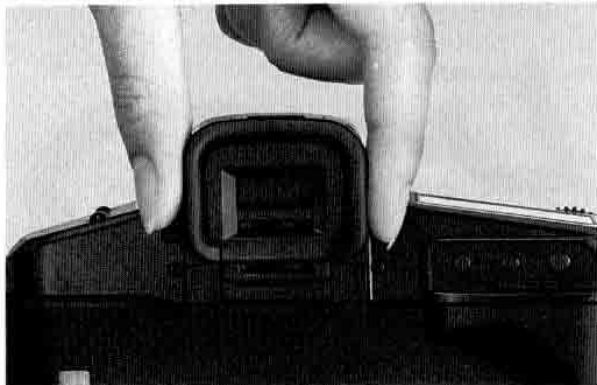

Ten eyesight correction lenses are available in powers of +3, +2, +1.5, +1, +0.5, 0, -0.5, -2, -3 and -4 diopters. They may make viewing and focusing easier if you are near or farsighted. Choose the one which is closest to your eyeglass prescription, and make a practical test if possible.

Positioning Guide 90



This accessory is a special stabilizer which is necessary when the T90 is used with the Camera Holder F4, the Focusing Rail, or the camera support bracket of the Speedlites 577G and 533G. Slide the Positioning Guide 90 to attach it.

The Positioning Guide 90 comes with the attachment screw. When the Camera Holder F4 or the camera support bracket of the Speedlites 577G and 533G is used with the T90, use the attachment screw provided with the Positioning Guide 90. When the Focusing Rail is used, however, use the one provided with the Focusing Rail.

82

Close-up/Macrophotography Accessories

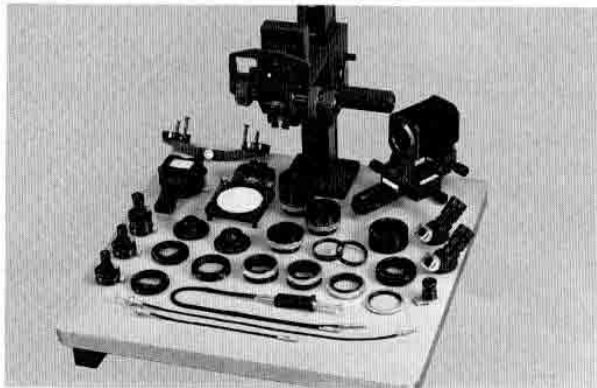

Accessories such as the Auto Bellows, Copy Stand 5 and various extension tubes are designed for everything from simple close-up photography to life-size and magnified macro photography.

- **Cable Release Adapter T3**
This is an accessory for use with the Double Cable Release when using the Auto Bellows. It is possible to use this adapter with the Release 30 or 50.

Remote Switch 60T3

The Remote Switch 60T3 is designed to be used when the camera is mounted on a tripod for close-up shooting or when using a telephoto lens with which camera-shake is a particular problem. Attach directly to the camera's remote control socket.

Lens Hood



We strongly recommend the use of a lens hood to keep out side light which may cause flare and ghost images to form on the image. Rigid Canon hoods also help to protect the lens from shock. Use only a hood which is specified for your particular lens. Most Canon hoods fit into the bayonet mount and are fixed by turning. For details, please see the lens instruction manual.

83

Interchangeable Focusing Screens

You can change the focusing screen in your T90 according to your specific focusing needs. Canon offers eight different types of focusing screens for the T90.

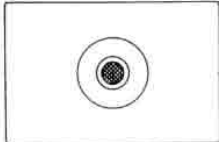
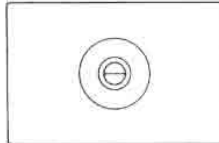
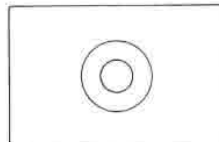
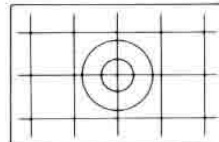
Type	Application
A. Microprism 	Matte/Fresnel field with microprism range-finder spot in the center of the screen. Especially suited for general photography when using an aperture of f/5.6 or larger.
B. New Split 	Matte/Fresnel field with split-image range-finder spot in the center of the screen. The lens is in focus when the bottom half is even with the upper half. Suited for general photography since, unlike former focusing screens, rarely does one-half of the range-finder darken, even when using small maximum aperture lenses.
C. All Matte 	Matte/Fresnel field with clear matte center spot. Especially recommended for macro and telephoto photography, this screen enables the entire field of view to be seen without distraction. The lens is in focus when the subject can be clearly seen.
D. Matte/Section 	Similar to C screen but with horizontal and vertical reference lines. Recommended for architectural photography and copy work in which accurate image placement is essential.

84

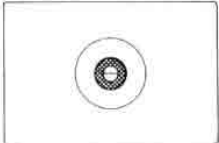
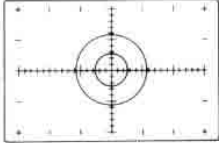
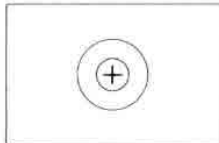
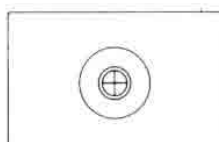
Type	Application
E. New Split/Microprism 	Standard with the T90. Three focusing methods (split image, microprism and matte/fresnel) are possible according to preference.
H. Matte/Scale 	Matte/Fresnel field with fine matte center plus horizontal and vertical scales in millimeters. Recommended for close-ups, photomicrography, copy work and architectural photography where it is useful to know the size of the subject or the magnification involved.
I. Double Cross-hair Reticule 	Matte/Fresnel field with clear center spot containing double cross-hair reticle. While focusing, move your eye left to right. If cross-hairs stay in the same position on the subject, then the subject is in focus. Recommended for photomicrography, astrophotography, or other applications requiring high magnifications.
L. Cross Split-image 	Matte/Fresnel field with cross split-image in the center of the screen which divides the subject in half both horizontally and vertically. The subject is in focus when the four quarters merge to become one unbroken image. Suitable for general photography.

NEVER change the screen with your fingers. A special tool is provided with each accessory focusing screen to facilitate screen replacement.

These focusing screens are exclusively designed for the T90. Do not use them on other cameras.

Caring for Your Camera

As with any precision instrument proper care and maintenance involve a few simple rules in addition to common sense. Observing these few rules will keep your T90 in top condition at all times.

We recommend that you clean your T90 periodically using the tools listed below.

Cleaning tools: Blower brush, Cleaning fluid, Cleaning tissue, Silicone cloth.

- (1) To clean the lens surface and the viewfinder:
Blow off dust with the blower brush and then gently wipe the lens surface with a lens cleaning tissue which has been moistened with a few drops of lens cleaner.
- (2) To clean the reflecting mirror and the focusing screen:
Use only a blower brush. If more cleaning is necessary, NEVER attempt to do it yourself but take it to an authorized Canon service facility.

- (3) To clean the film chamber:
The film chamber also requires occasional cleaning with a blower brush to remove accumulated film dust particles which might scratch the film.
- (4) To clean the film pressure plate and the film guide rails:
Lightly wipe the surface with a cleaning tissue moistened with cleaning fluid.

PRECAUTIONS

- Be careful NEVER to touch the shutter curtain.
- After using the camera on a beach, clean it thoroughly. Salt and sand are your T90's worst enemies.
- Aerosol spray dust removers are not recommended for the shutter curtain area. If used, hold the can at least 20 cm (8 inches) away from the curtain.

86

Other Notes

Storage of your T90

The best thing you can do for your T90 is to use it regularly. In the event that you must store it for quite a while, however, first remove it from its case or camera bag. Remove the batteries. Wrap the camera in a clean, soft cloth and place it in a cool, dry, dust-free place. If you store the body and lens separately, attach both the body and rear lens caps.

Avoid storing your T90 in the following places:

- "Hot Spots" such as the trunk, rear window shelf or glove compartment of a car.
- Laboratories or other such areas where chemicals may cause corrosion.
- In direct sunlight.

Before using the T90 after it has been stored for a long time or before using the camera for important events, carefully check the operation of each part.

1. Liquid Crystal Display

The T90's display panel uses liquid crystal to display exposure information. After about 5 years of normal use, the display may become hard to read.

The liquid crystal may respond relatively slowly in low temperatures and the display may become dark at high temperatures (about 60°C/140°F). Normal functioning will return when the temperature returns to normal.

2. Back-up Battery

The T90 has a built-in back-up battery which memorizes the display panel data, such as the frame counter number and the ISO film speed, when the AA-size batteries are being changed. Battery life is about 5 years. When voltage becomes insufficient, "ISO 100" will blink (at 2 Hz) on the display panel after loading batteries for normal camera operations. If the back-up battery is removed, the memory will be erased. In this case, reset the film speed.

Take your camera to the nearest Canon Service facility for the replacement of the liquid crystal or the back-up battery. (Replacement will be at owner's expense.)

87

3. Batteries

Even if one blinking bar mark or no bar mark appears on the display panel during battery check, indicating that the batteries are low, as long as the shutter releases, exposure will be correct. Automatic rewind, however, may not be possible because of the insufficient power of the batteries. Also, if the camera happens to stop during rewind, all of the film transport bars start blinking on the display panel to warn you. Automatic rewind will start again once you replace the batteries with the new ones.

4. HELP Display

"HELP" may appear in the viewfinder in the case of camera malfunction or operational error warning. When "HELP" is displayed, perform the following operations:

- 1) Check the batteries by pressing the battery check button inside the palm wing.
- 2) If the battery voltage is sufficient, remove the battery magazine once and reset it.
- 3) Release the shutter once.

If "HELP" does not appear again, the camera has returned to normal condition and you can keep shooting. If "HELP" will not disappear after repeating the operation described above several times, there has been a camera malfunction and the camera needs repair. Take the camera to the nearest Canon Service facility.

- On the display panel, the error display (EEE) will appear while the "HELP" is displayed in the viewfinder.
- The "HELP" and "EEE" displays will appear even when the viewfinder display selector is turned off.

5. When Using the Canon Extenders

Exposure compensation may be necessary when using the Canon Extenders with the T90. Correct the exposure by using the exposure compensation index as follows:

Extender	Lens	The max. aperture of the lens	T90's metering mode		
			Center-weighted average	Partial	Spot
2X-A	Single	All lenses	0	-2/3 step	-2/3 step
	Zoom	All lenses	0	-2/3 step	-1/3 step
2X-B	Single	f/1.2—f/2.0	+2/3 step	+2/3 step	+1/3 step
		f/2.5—f/2.8	+2/3 step	0	0
		f/3.5 or slower	0	0	0
	Zoom	All lenses	+1/3 step	-1/3 step	0
1.4X	Single	All lenses	0	-2/3 step	-2/3 step
	Zoom	All lenses	0	0	0

- "+" means increasing the exposure.
- "-" means decreasing the exposure. (→ p.68)

Exposure Warning Displays

(When using the FD 50 mm f/1.4 lens,  indicates blinking display at 4 Hz)

When the shutter speed and/or the aperture value blink at 4 Hz in the viewfinder, exposure will be incorrect. Please see p.93 on the response action for each case marked by the "  " mark.

1. Shutter-priority AE (Safety shift ON)

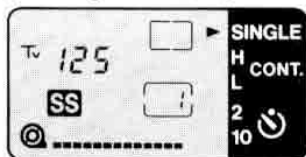

① Correct exposure



② Out-of-metering range warning — Low -1



③ Out-of-metering range warning — High -2



or



2. Shutter-priority AE (Safety shift OFF)



① Correct exposure



② Underexposure warning -3



③ Overexposure warning -4



or



3. Aperture-priority AE (Safety shift ON)

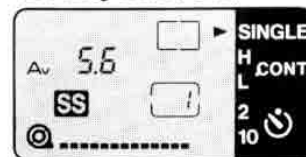

① Correct exposure



② Out-of-metering range warning — Low -1



③ Out-of-metering range warning — High -2



or



90

4. Aperture-priority AE (Safety shift OFF)

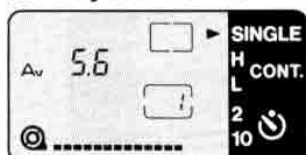

① Correct exposure



② Underexposure warning -5



③ Overexposure warning -6



5. Standard program AE



① Correct exposure



② Out-of-metering range warning — Low -1



③ Out-of-metering range warning — High -2



or



6. Variable-shift program AE

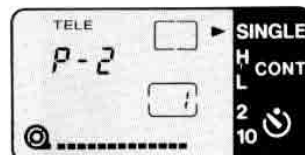

① Correct exposure



② Out-of-metering range warning — Low -1



③ Out-of-metering range warning — High -2



or



7. Manual

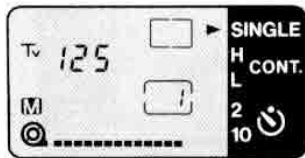

① Correct exposure



② Underexposure warning \oplus -3



③ Overexposure warning \oplus -4



or



8. Stopped-down AE

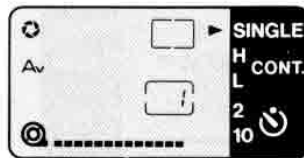

① Correct exposure



② Out-of-metering range warning — Low \oplus -7



③ Out-of-metering range warning — High \oplus -8



9. Stopped-down (fixed index) metering



① Correct exposure



② Underexposure warning \oplus -9



③ Overexposure warning \oplus -10



10. Bulb

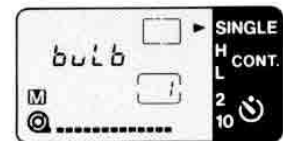

① Correct display



② Lens "A" mark warning \oplus -11



Countermeasure for Each Case

- \oplus -1 1) Switch to flash photography, or add other lighting.
2) Use a film with higher ISO film speed.
- \oplus -2 1) Use an ND (neutral density) filter.
2) Use a film with lower ISO film speed.
- \oplus -3 1) Decrease the shutter speed setting until the aperture value stops blinking.
- \oplus -4 1) Increase the shutter speed setting until the aperture value stops blinking.
- \oplus -5 1) Increase the aperture setting until the shutter speed stops blinking.
- \oplus -6 1) Decrease the aperture setting until the shutter speed stops blinking.
- \oplus -7 1) Open the aperture manually.
- \oplus -8 1) Close the aperture manually.
- \oplus -9 1) Increase the aperture setting until "00" is displayed.
2) Decrease the shutter speed setting.

- \oplus -10 1) Decrease the aperture setting until "00" is displayed.
2) Increase the shutter speed setting.
- \oplus -11 1) Remove the aperture ring of the lens from "A" mark.

Notes

- 1 In the case of out-of-metering range warning (low) and underexposure warning, the maximum aperture of the lens in use blinks in the viewfinder. When the FD 200 mm f/2.8 is used, "2.8" will blink in the viewfinder.
- 2 When using a lens with a minimum aperture of f/16 such as the FD 50 mm f/1.2L, the aperture displays of "16" and "19" also indicate overexposure warning. In this case, please note that the aperture does not blink in the viewfinder.
- 3 When using a lens with a minimum aperture of f/32 such as the FD 135 mm f/2, exposure will be correct even if the aperture display of "27" is blinking in the viewfinder. When "32" starts blinking, however, your picture will be overexposed.

Display Panel

The T90 uses a large liquid crystal display panel to indicate shooting information. The diagram below shows all the information at the same

time; however, the display never actually looks like this. Normally the panel displays only the information required at the time.

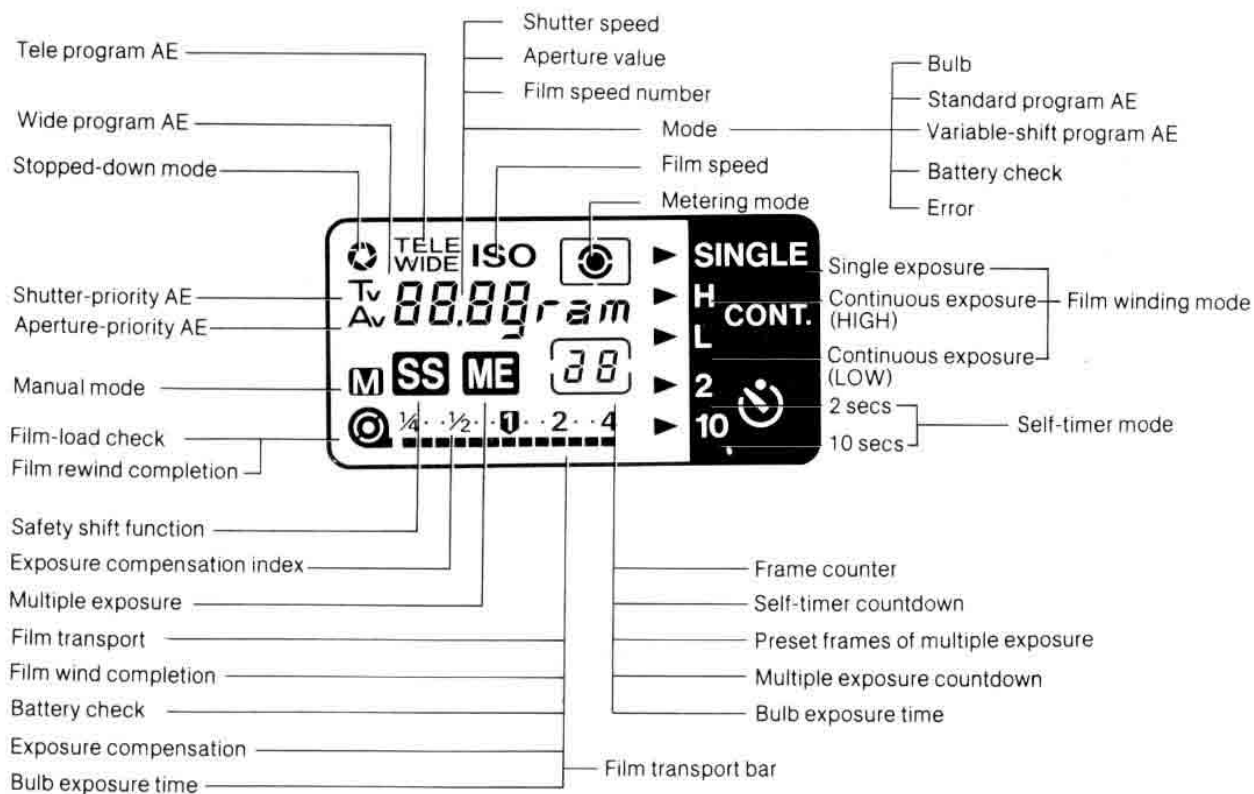

Viewfinder Information

This viewfinder is bright and easy to read. Only the necessary information is displayed outside

the field of view. The diagram below shows all the information at the same time for convenience.

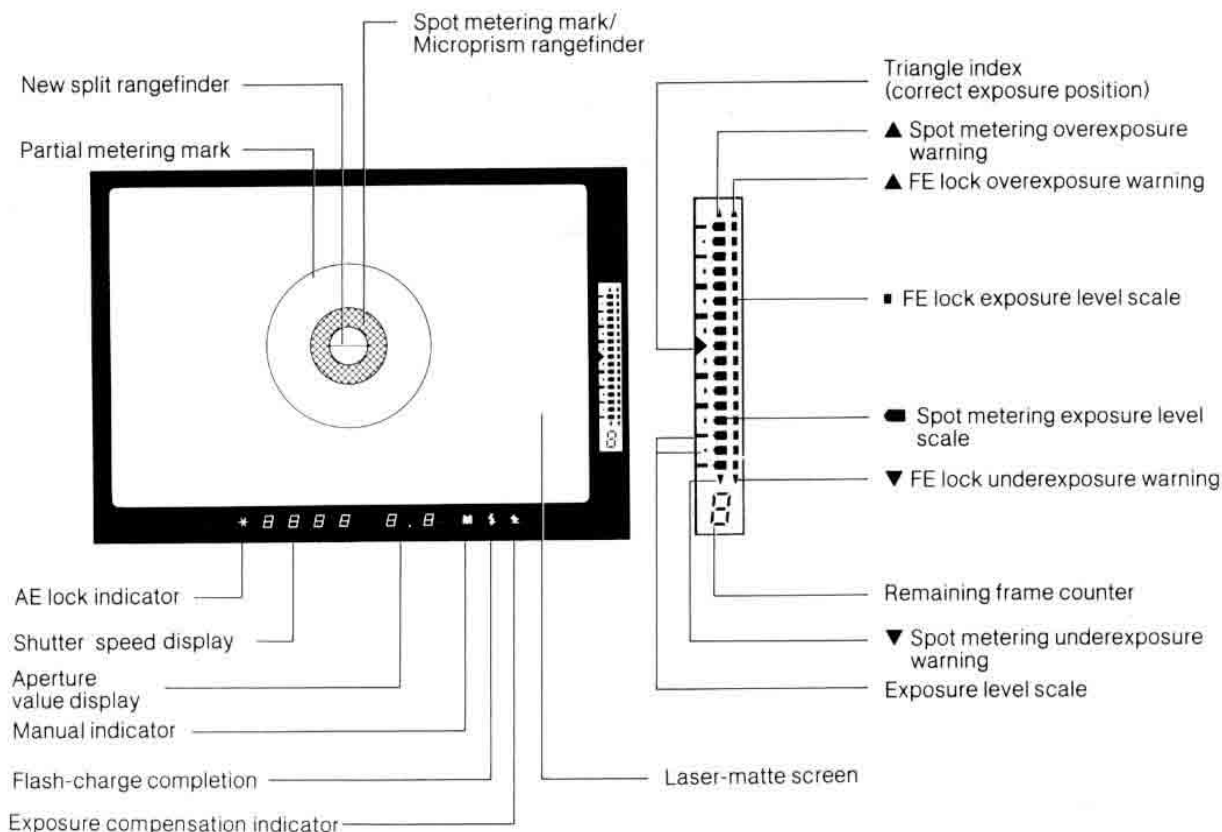

Specifications

Type: 35 mm single lens reflex (SLR) camera with electronically controlled automatic exposure (AE), focal-plane shutter, and built-in motor drive.

Format: 24 × 36 mm

Usable Lenses: Canon FD lenses (full aperture metering and stopped-down metering) and non-FD lenses. (stopped-down metering)

Standard Lens: FD 50 mm f/1.4

Lens Mount: Canon Mount

Viewfinder: Fixed eye-level pentaprism. Gives 94% vertical and horizontal coverage of actual picture area, and 0.77X magnification at infinity with a standard 50 mm lens.

Dioptric Adjustment: Built-in eyepiece is adjusted to standard -1 diopter. (eyepoint: 19.3 mm)

Focusing Screen: Standard split-image/micropism rangefinder. Seven other types of interchangeable screens are available optionally.

Mirror: Quick return type half-mirror with shock and noise absorber.

Viewfinder Information: Displayed to the right and at the bottom of viewing area. Bottom area:

- (1) 7-segment LED digit display
 - 1 Shutter speed (red) — flashes at 4 Hz to give out-of-metering range warning.
 - 2 Aperture (red) — flashes at 4 Hz to

give out-of-metering range warning.

- 3 All hyphens (red) — data imprint confirmation; displayed only when special accessories are attached.
 - (2) 7-segment LED character display
 - 1 EEEE EE (red) — error warning; displayed when the lens is set to "A" during stopped-down operation.
 - 2 HELP (red) — camera malfunction or operational error warning.
 - (3) 3-segment LED display
 - 1 ✕ (red) — AE lock indicator in partial area metering and spot area metering.
 - (4) LED mask lighting display
 - 1 M (red) — manual indicator.
 - 2 ⚡ (green) — flash charge-completion indicator.
 - 3 +/- (red) — exposure compensation indicator.
- Right area:
- (1) Dot and 7-segment digit transparent LCD display
 - 1 ■ (white on blue background) — multi-spot metering indicator, H/S control indicator, and remaining frame display.
 - 2 □ (white on blue background) — FE lock indicator when the Speedlite 300TL is used with the camera in the FE lock mode.

96

Light Metering System: Through-the-lens (TTL) full aperture metering for FD lenses, using silicon photocell (SPC). Three selectable metering patterns; center-weighted average metering, partial area metering, and spot area metering. When using lenses or accessories without FD signal pins, only stopped-down metering may be used.

Exposure Modes:

- 1 Shutter-priority AE with selectable safety shift function (ON/OFF possible)
- 2 Aperture-priority AE with selectable safety shift function (ON/OFF possible)
- 3 Standard program AE
- 4 Variable-shift program AE (selectable out of 7 programs)
- 5 Manual
- 6 Stopped-down AE
- 7 Stopped-down (fixed index) metering
- 8 Flash AE (possible with specified Canon Speedlites)

Meter Coupling Range: EV 0—20 (with ISO 100 film and a 50 mm f/1.4 lens)

Film Speed: ISO 6—6400. (ISO25—5000 is automatically set by 1/3 step according to DX code standard) Also can be set manually.

Exposure Compensation:

- 1 Exposure compensation index — ±2 steps by 1/3 increment

- 2 H/S control — ±4 steps by 1/2 increment. (can only be used during the spot area metering, and in the FE lock mode with the Speedlite 300TL)

Shutter: Vertical-travel metal type focal-plane shutter. All speeds electronically controlled. Front and back curtains controlled by separate quick-return permanent magnets.

Shutter Speeds: 1/4000—30 secs and bulb. (X-sync = 1/250 sec) Can also be set in 1/2 step.

Self-Timer: Electronically controlled, with a delay of either approx. 10 secs or approx. 2 secs. Indicated by blinking red LED of the operation confirmation lamp.

Film Loading: Automatic. After the film has been positioned and the back cover closed, the film is automatically advanced to the 1st usable frame and then automatically stopped. (approx. 2 secs) The frame counter display then reads "1".

Film Wind: Automatic using the built-in coreless motor exclusively used for film transport. Continuous shooting is possible. Confirmation by the film transport bar marks on the LCD display panel.

Film Winding Mode: Three selectable modes; S (single exposure), H (max. 4.5 frames per sec), and L (max. 2 frames per sec). When operating in H mode, automatically

switches to L mode when battery power drops below prescribed voltage to make shooting capacity longer.

Film Rewind: Automatic using the built-in coreless motor exclusively used for film rewind. Automatically starts when the end of the film is reached and then automatically stops (approx. 8 secs with 24-exp. film). Manual film rewind is also possible by pressing the manual rewind button.

Flash Contact: Coupled directly to the camera by means of the X-sync contact on the accessory shoe. When using the Speedlite 300TL, either the first shutter curtain synchronization or the second shutter curtain synchronization can be set.

Automatic Flash:

When the Speedlite 300TL is used and the camera is set to a program AE mode:

- 1 A-TTL flash-auto: Using A-TTL program of the camera and the near-infrared preflash of the Speedlite, the correct aperture value is automatically set according to the shooting distance and subject reflectivity. X-sync speed is also automatically set between 1/60 — 1/250 sec upon flash charge-completion. TTL control system which meters the light reflected from the film surface. Automatic fill-in flash is possible.

- 2 FE lock TTL flash-auto: The camera's FE lock program automatically sets the aperture. The main flash tube produces preflash and the reflection from the subject is measured by TTL spot metering and is entered into memory. X-sync speed is also automatically set between 1/60 — 1/250 sec upon flash charge-completion. Automatic fill-in flash is possible.

Remote Control: Possible. With three-terminal contact for remote control. Remote Switch 60T3 is required.

Multiple Exposure: By pressing both the shooting mode selector and the metering mode selector at the same time. Continuous multiple exposure is possible. Reset/clear during shooting and preset up to 9 exposures are also possible. Automatically cleared upon completion of preset exposures.

Eyepiece Shutter: Provided.

Exposure Preview Button: Provided.

Finder Display Selector: All LCD/LED displays can be turned ON or OFF. LCD display to the right of the viewfinder and the display panel can be illuminated by the built-in illumination lamp.

LCD Display Panel: Displays only the information required at the time, e.g. shooting mode, metering mode, film winding mode,

Index

shutter speed, aperture, film speed, frame counter (additive type), self-timer operation time, bulb operation time, battery check, etc.

Power Source:

- 1 Main power source — four AA size batteries. Alkaline-manganese batteries are standard but carbon-zinc and Ni-Cd batteries may also be used.
- 2 Memory back-up — built-in lithium battery (BR-1225 or CR-1220), battery life is approx. 5 years.

Battery Check: By pressing the battery check button. Three energy levels are shown by the battery check bar marks on the display panel.

Back Cover: Removable. Opened by sliding the latch with safety lock. Command Back 90 and Data Memory Back can be attached.

Dimensions: 153.1 (W) × 121 (H) × 69.4 (D) mm (6-1/4" × 4-3/4" × 2-3/4")

Weight: 800 g (28-3/16 oz.) body only.

[A]	
Action photography	22
AE lock.....	36, 37, 48
Aperture-priority AE	23, 29, 30
A-TTL mode	74
Auto first frame positioning.....	17
Auto load.....	15
Auto rewind	45
Auto wind	41

[B]	
Backlight control.....	34
Back-up battery.....	87
Batteries	13, 87, 88
Battery check	11
Bulb.....	64

[C]	
Cable release.....	83
Cable Release Adapter T3.....	83
Canon Service Facility.....	86, 87, 88, 101
Caring for your camera	86, 87
Carrying case	103

Subject to change without notice.

Center-weighted average metering	33, 35, 36
Close-up accessories	83
Command Back 90	79
Continuous exposure mode	20
Correct exposure	40, 90
[D]	
Data Memory Back 90	78
Depth of field	59, 60
Dioptric adjustment lens	82
Display panel	94
DX code	18
[E]	
Error display	61
Exposure compensation	53, 68
Exposure compensation index	68
Exposure level difference comparison	50, 51
Exposure preview button	42
Exposure warning displays	90
Extender	89
Eyepiece shutter	60

[F]	
FD signal pin	8
FE lock TTL mode	75
FE lock with H/S control	75
Film plane indicator	64
Film speed	18
Filter	33
Flash photography	74
Focusing	38
Focusing screen	84
Frame counter	41
[H]	
HELP display	88
Highlight control	54
Hood	83
How to use the metering modes	35
H/S control	53
[I]	
Infrared film	73

[L]	
Laser-matte screen	38
Liquid crystal display	87
Loading the batteries	9, 10
Loading the film	15, 16
Long time exposure	64
[M]	
Macro Ring Lite ML-2	80
Main switch	11, 41
Manual diaphragm control	63
Manual override	58
Manual rewind	47
Metering distribution pattern	33, 34
Metering mode	35
Microprism rangefinder	38
Motor drive	20
Multiple exposure	70
Multiple flash accessories	81
Multi-spot metering	51
[N]	
Neckstrap	103

100

New split rangefinder	38
[O]	
One-point spot metering	49
[P]	
Palm wing	3
Partial metering	34, 35, 49
Portraiture	23
Positioning Guide 90	82
Program AE	24, 25, 26
Program AE characteristics graph	24, 25
[R]	
Remaining frame counter	42
Remote control photography	81, 83
Remote Switch 60T3	83
Response action for each exposure warning	93
[S]	
Safety shift function	22, 23, 30
Second shutter curtain synchronization	76

Self-timer	66
Sequential AE lock photography	37
Shadow control	55
Shooting capacity	20
Shooting mode	22, 27
Shutter-priority AE	22, 28, 30
Single exposure mode	20
Snap shot	22, 24
Speedlite 300TL	74, 77
Spot metering	34, 35, 36
Spot metering button	48, 51, 54, 55
Stage photography	34
Standard program AE	24, 31
Storage	86, 87
Stop-down lever	7, 60, 62
Stopped-down AE	59
Stopped-down (fixed index) metering	62
[T]	
Tele program AE	26, 32
TTL control system	74, 75

[V]	
Variable-shift program AE	25, 32
Viewfinder display selector	44
Viewfinder illumination	95
[X]	
X-sync	74
X-ray examinations	18
[W]	
Wide program AE	26, 32
Wireless Controller LC-2	81

Nomenclature

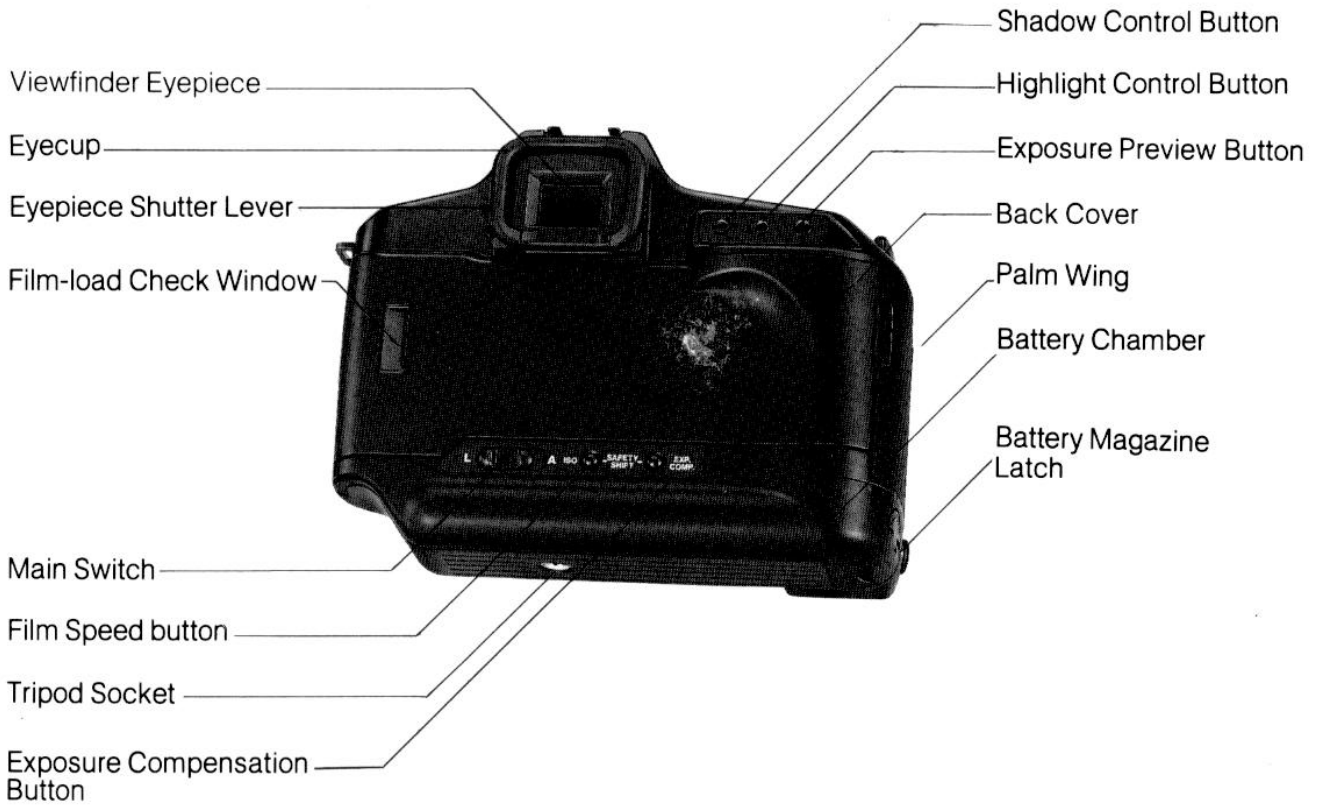

102

Carrying the Camera

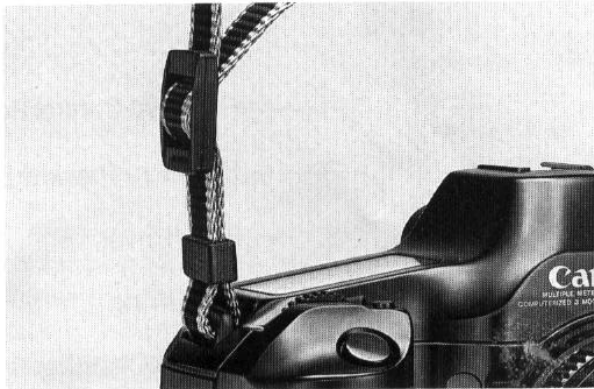

1) Thread the ends of the neckstrap through the rings on the camera as shown.



2) Put the camera in the case as shown above.

- ★ Canon offers two types of cases in addition to the standard case.
 - Canon Snap Case T90 SA-3 can store the T90 with the FD 35—70 mm f/3.5—4.5 lens.
 - Canon Snap Case T90 SB-3 can store the T90 with the FD 35—105 mm f/3.5—4.5 lens.

Canon

CANON INC. 7-1, Nishi-Shinjuku 2-Chome, Shinjuku-ku, Tokyo 163, Japan
Mailing address: P.O. Box 5050, Dai-ichi Seimei Building, Tokyo 163, Japan

U.S.A. ————— **CANON U.S.A., INC. HEADQUARTERS**
One Canon Plaza, Lake Success, N.Y. 11042, U.S.A.
CANON U.S.A., INC. MANHATTAN SERVICE CENTER
600 Third Avenue, New York, N.Y. 10016, U.S.A.
CANON U.S.A., INC. ATLANTA OFFICE
5625 Oakbrook Parkway Norcross, Georgia 30093, U.S.A.
CANON U.S.A., INC. CHICAGO OFFICE
100 Park Blvd Itasca, IL 60143-2693, U.S.A.
CANON U.S.A., INC. LOS ANGELES OFFICE
122 Pasadena Avenue East, Costa Mesa, California 92626, U.S.A.
CANON U.S.A., INC. SANTA CLARA BRANCH
4000 Burton Drive, Santa Clara, California 95054, U.S.A.
CANON U.S.A., INC. DALLAS OFFICE
3200, Regent Blvd, Irving, Texas 75083-3145, U.S.A.
CANON U.S.A., INC. HONOLULU BRANCH
Blg. 9-2, 1050 Ala Moana Blvd., Honolulu, Hawaii 96814, U.S.A.
CANON U.S.A., INC. WASHINGTON D.C. BRANCH
5701 General Washington Drive Alexandria, VA 22312, U.S.A.

CANADA ————— **CANON CANADA INC. HEADQUARTERS**
6390 Dixie Road, Mississauga, Ontario L3T 1P7, Canada
CANON CANADA INC. MONTREAL SERVICE CENTRE
10652, Côte de Liesse, Lachine, Québec H8T 1A5, Canada
CANON CANADA INC. CALGARY OFFICE
2828, 10th Street, N.E. Calgary, Alberta T2E 7K7, Canada

EUROPE, AFRICA
& MIDDLE EAST ————— **CANON EUROPA N.V.**
P.O. Box 7907, 1008 AC Amsterdam, The Netherlands
CANON FRANCE-PHOTO CINEMA S.A.
30, boulevard Vieux-Bourget, Ile de la Jatte, 92521 Neuilly-sur-Seine, France
CANON UK LTD.
Units 4 & 5, Brent Trading Centre, North Circular Road, London NW10 0JF, United Kingdom
CANON EURO-PHOTO G.m.b.H.
Linsellesstraße 142-156, D-4156 Willich 3, West Germany

CENTRAL &
SOUTH AMERICA ————— **CANON LATIN AMERICA, INC. DEPTO. DE VENTAS**
Apartado 7022, Panama 5, Republica de Panama
CANON LATIN AMERICA, INC. CENTRO DE SERVICIO Y REPARACION
Apartado 2019, Zona Libre de Colón, Republica de Panama

SOUTHEAST ASIA ————— **CANON HONG KONG TRADING CO., LTD.**
Room 1101-3 & 1121-2, Ferrissuta Centre, 67 Moody Road, Tsimshatsui East, Kowloon, Hong Kong
CANON SINGAPORE PTE. LTD.
95 South Bridge Road #13-01-15, South Bridge Centre, Singapore 0105

OCEANIA ————— **CANON AUSTRALIA PTY. LTD.**
Unit 1-37, Waterloo Road, North Ryde (Macquarie Park), N.S.W. 2113, Australia

JAPAN ————— **CANON SALES CO., INC.**
11-28, Mita, 3-Chome, Minato-ku, Tokyo 108, Japan

PUB.C-IE-121H
1086B25

©CANON INC. 1985
CY8-6016-002

PRINTED IN JAPAN