

E

INSTRUCTIONS
English Edition



Canon

750



Accessory Shoe

Selector Dial

Film Plane Indicator

Shutter Button

Frame Counter

Neckstrap Ring

Action Grip

Aperture Ring

Focusing Ring

Lock Release Button

Film Rewind Knob

Film Speed Dial

Bayonet for Hood

AE Lock Pin

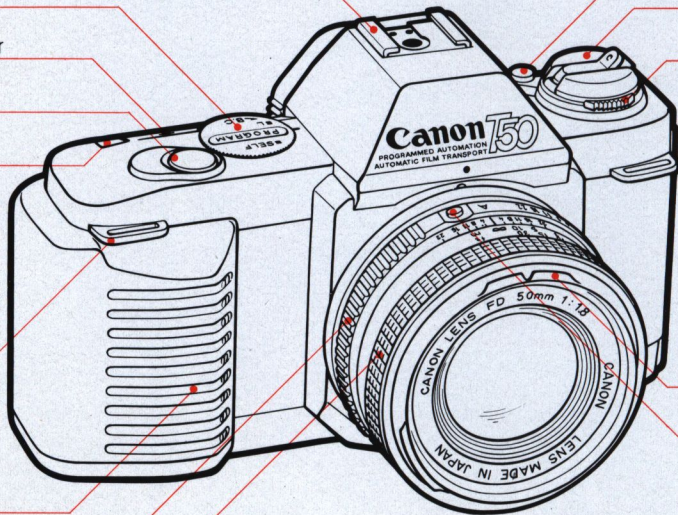

Welcome to the world of SLR photography! Your new T50 combines built-in power winding with the sophisticated electronics of Canon's programmed SLRs. It is as easy to use as a compact camera, yet affords the special flexibility that only SLRs give: lens interchangeability. The T50 takes care of every exposure worry for you from regular daylight shooting, to flash photography when accompanied by the Canon Speedlite 244T. Even film loading is automatic. You'll find the built-in power winder very helpful when taking "action" pictures or shooting by remote control with the Remote Switch 60 T3. And because it is an SLR, you can use the T50 with any of Canon's over 50 interchangeable FD lenses

for interesting and professional-looking photographs. The T50 is truly the camera for all and everyone, regardless of experience.

Before you begin, take a few minutes to read these instructions. They have been written so that you can quickly master the operations of the camera, while also providing some tips and explanations on photography.

It is a good idea to acquaint yourself with the camera by first taking some pictures without any film loaded in the camera. Load film once you feel comfortable with the camera.

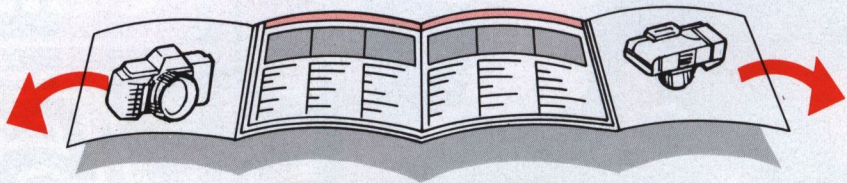

When reading these instructions, unfold the front and back flaps of this booklet for easy reference to the camera's parts.

Table of Contents

1. Attaching the Lens	6
2. Setting the Lens for Programmed AE.....	8
3. Loading the Batteries	9
4. Checking the Batteries	10
5. Selector Dial	11
6. Setting the Film Speed	12
7. Loading the Film	13
8. Learning to Hold the Camera Correctly	15
9. Shooting	16
10. Continuous Shooting	18
11. The T50's Viewfinder	19
12. Focusing Aids.....	20
13. Viewfinder Information	21
14. Self-Timer	22
15. Rewinding the Film.....	23
16. Dedicated Flash Photography with the 244T	24
17. Photography with the Remote Switch 60 T3.....	26
18. Other Accessories	27
19. Carrying the Camera	29
20. Caring for Your Camera	30
Specifications	32

1. Attaching the Lens

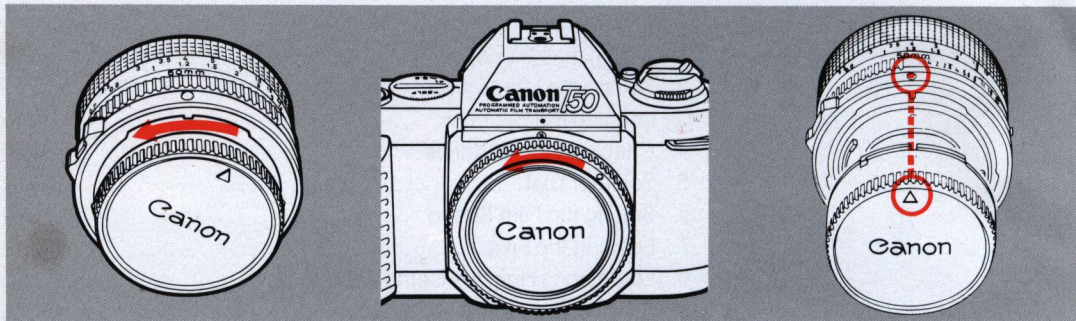

6

Turn the rear lens cap in the direction of the arrow until it stops. Then pull it off the lens.

Remove the body cap.

To reattach the rear lens cap, align it with the lens as illustrated. Then lightly push it in and turn it clockwise until it stops.

This camera is designed for use with Canon FD lenses only. Lenses and accessories shown below cannot be used with the T50.

FL series lenses
TS35 mm f/2.8

Fish-eye 7.5 mm f/5.6
Reflex 500 mm f/8
Macrophoto 20 mm f/3.5
Macrophoto 35 mm f/2.8
Close-up system accessories such as Extension Tubes or Bellows without AE signal pins

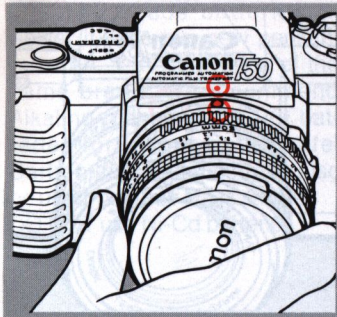

To mount the lens, first align the red positioning point on the lens with the red dot above the camera mount as illustrated.

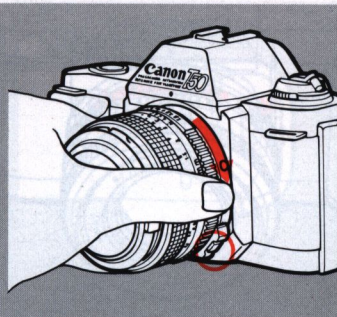

Then turn the lens in the direction of the arrow until it stops and the lens release button pops out with a click.

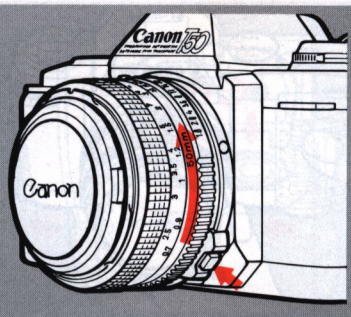

To dismount the lens, turn the lens in the direction of the arrow while pressing the lens release button.

After mounting the lens, make sure the lens release button has popped out. Otherwise, the lens will not work properly. **DO NOT** press the lens release button while mounting, or it may not pop out.

Be sure to place the lens with its front end down (as illustrated) to avoid damaging the protruding pins.

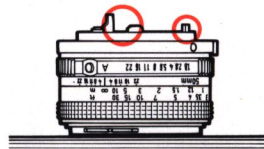

2. Setting the Lens for Programmed AE

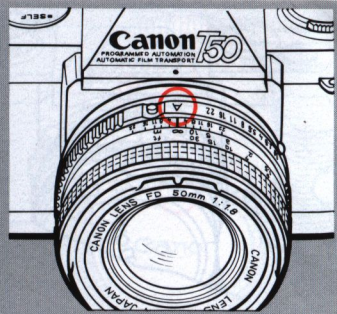
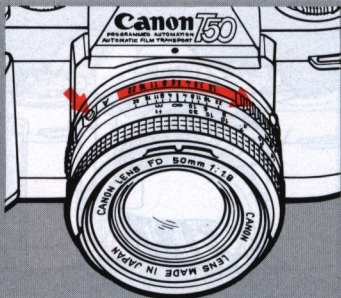
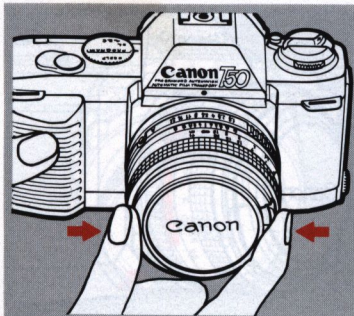

- 8 Remove the front lens cap. While pressing in the AE lock pin, turn the aperture ring in the direction of the arrow until "A" click-stops at the distance index.

"A" will be in line with the red dot on the camera. If you forget to do this, automatic exposure will be impossible. Since programmed AE requires this setting, be sure to always check that the lens is set at "A."

Note:

If you disengage the aperture ring from the "A" mark, the camera's shutter speed will remain set at 1/60 sec. At the same time, a red "M" will appear in the viewfinder when you depress the shutter button halfway.

3. Loading the Batteries

The T50 needs batteries to power it. Use two new penlight (size AA, 1.5V) batteries of the same brand. We recommend Alkaline-manganese (LR6) batteries for longer battery life. Carbon-zinc batteries may also be used, but their life is shorter. **DO NOT** use Ni-Cd batteries.

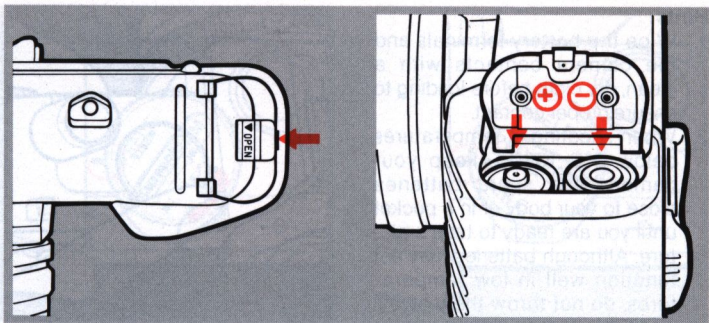

Push the battery chamber cover opening latch. The battery chamber cover will flip open.

Load the batteries so that their terminals face the directions indicated on the back of the battery chamber cover.

The camera will not function if the batteries are loaded incorrectly.

4. Checking the Batteries

Hints:

1. Wipe the battery terminals and the camera contacts with a clean, dry cloth before loading to ensure proper contact.
2. When shooting in temperatures below 0°C (32°F), keep your camera and spare batteries close to your body or in a pocket until you are ready to take a picture. Although batteries may not function well in low temperatures, do not throw them away. They may work perfectly again once they are restored to room temperature.
3. Remove the batteries if you do not expect to use the camera for about three weeks or longer.

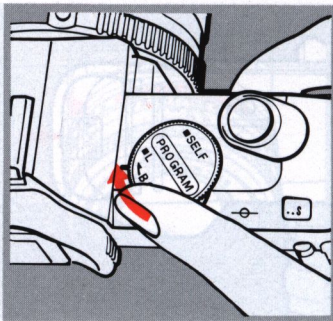

Rotate the selector dial to "B.C."

If you hear beeping sounds, you can start taking pictures. If the beeping sounds are not emitted, battery power is insufficient. In this case, replace the batteries. (The selector dial automatically returns to "L" when you remove your finger.)

Battery Life

	Alkaline Batteries	Carbon-zinc Batteries
24-exposure rolls	75 (9)	45 (4.5)
36-exposure rolls	50 (6)	30 (3)

Large Figures = shooting in normal temperatures (20°C, or 68°F)

Figures in Parentheses = shooting in low temperatures (-10°C, or 14°F)

5. Selector Dial

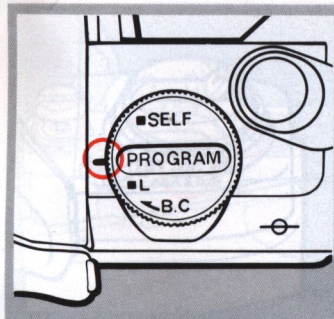

"PROGRAM" is the picture-taking position.

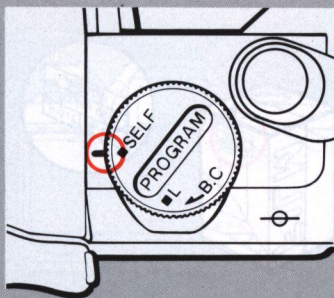

"SELF" is the position for self-timer photography.

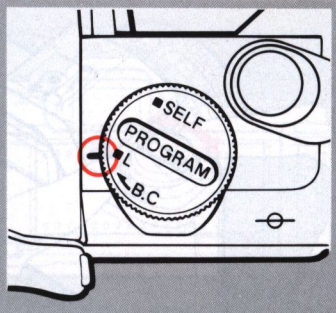

"L" locks the shutter to prevent accidental shutter release. Turn the dial to "L" when not using the camera; this conserves battery power.

6. Setting the Film Speed

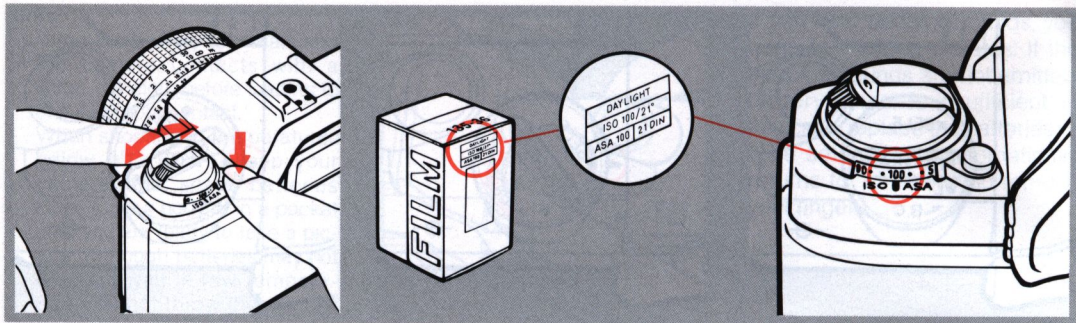

12

While pressing the lock release button, rotate the film speed dial until the ISO/ASA of your film is aligned with the green index. This is necessary for getting correct exposure.

A film's ISO/ASA number (for example, ISO/ASA 100) represents its sensitivity to light. The higher the number, the less light needed for an exposure. Thus, with ISO/ASA 400 film you can shoot even in dim light.

(32)(40) (64)(80) (125)(160) (250)(320) (500)(640) (1000)(1250)
ISO/ASA 25 . . 50 . . 100 . . 200 . . 400 . . 800 . . 1600
(Figures in parentheses are intermediate film speeds represented by dots on the film speed dial.)

7. Loading the Film

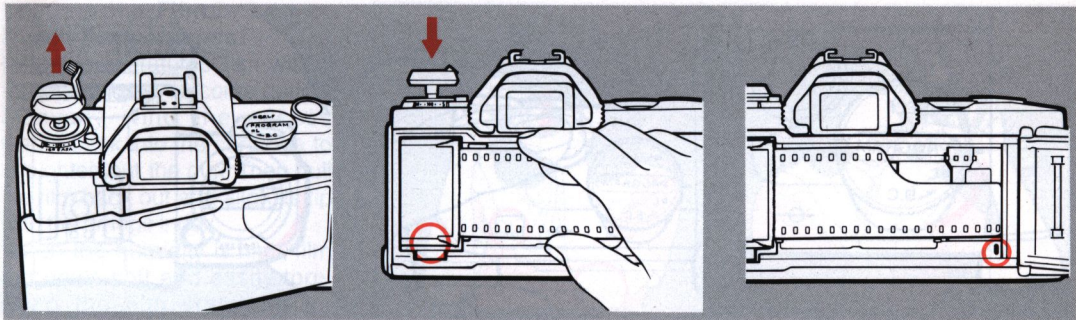

Pull up the rewind knob until the back cover pops open.

The T50 uses color or black and white film (negative or slide) in standard 35 mm cartridges. Place the cartridge in the film chamber as shown. Then push the rewind knob down, turning it until it drops into its normal position.

Pull the film leader across the camera so that its tip is aligned with the orange index in the lower right-hand side of the film chamber. If the film leader extends past the orange line, manually wind the excess film back into the film cartridge. Make sure the film perforations are engaged with the sprocket teeth. Then close the back cover.

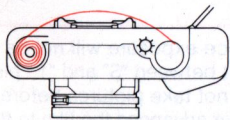

×

Too much film slack.

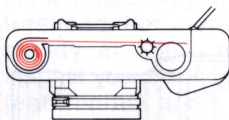

OK

Shield the film from direct sunlight while loading it.

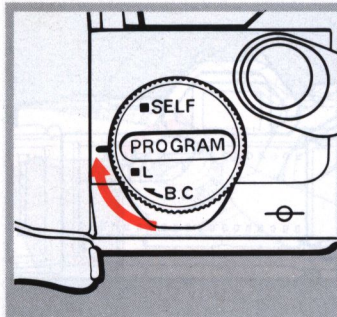

Turn the selector dial to "PROGRAM."

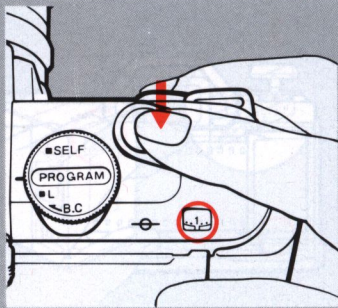

Keep your finger pressed on the shutter button until the frame counter automatically stops at "1." While doing this, keep an eye on the rewind knob. If it rotates in the direction of the arrow (see above right), the film is loaded correctly.

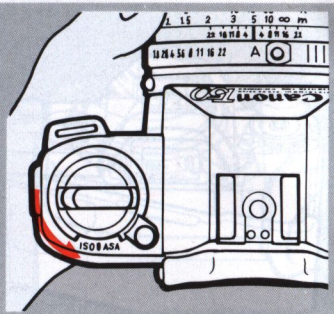

Each time you advance the film, the frame counter also advances to the next frame. It can count up to 36 frames. The numbers 12, 20, 24, and 36 are in orange to call your attention to the fact that rolls with those numbers of frames are or are almost finished.

While loading the film, take care not to touch the shutter curtain (shown in red).

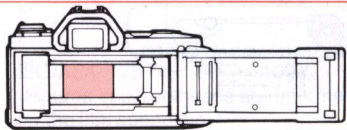

Since exposure will not be correct between "S" and "1," please do not take pictures before you have advanced the film to frame "1."

Loading the Film in Low or Humid Temperatures

In low temperatures, film with a long leader may become curled. Manually wind the excess leader back into the cartridge to straighten out the curl. Then pull the film back out and align its tip with the orange index.

When the humidity is high, film becomes soft and easily torn. Keep the film stored in its canister until just before you load it to keep it from tearing.



The slightest movement of your body during shutter release may cause blur in the picture. The best way to prevent camera movement is to hold the camera firmly, with your left hand supporting the camera and lens. Press your left elbow to your body and lightly press the camera against your cheek or forehead. For a vertical shot, steady at least one elbow against your body. Spread your feet slightly apart, one foot ahead of the other, and relax.

Hints:

1. Lean against a steady support like a tree, a wall, or a table, if available. This way your pictures will be just that much sharper.
2. There is, of course, no one correct way to hold the camera. Experiment to find the most suitable way for you. Select a method that provides comfort in addition to stability. It may help to practice in front of a mirror.

Take care not to touch the rewind knob and button when taking vertical shots.

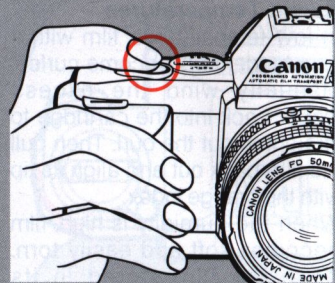
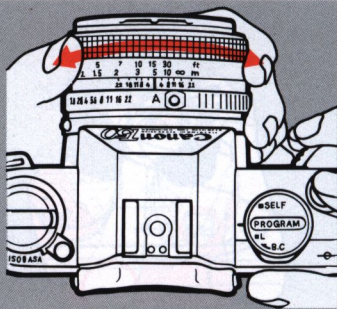
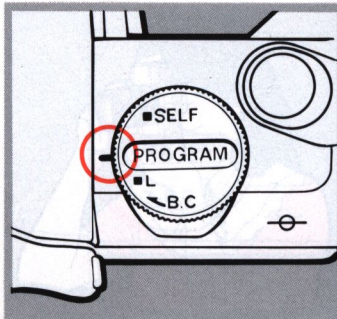

16

Make sure that the selector dial is set to "PROGRAM."

Look into the viewfinder. Turn the focusing ring until the main subject is sharp and compose the picture.

Gently press the shutter button halfway to check for correct exposure. If a solid green "P" appears in the right side of the viewfinder, exposure will be correct.

Shutter speed is the amount of time the shutter remains open for exposure. Aperture in photo terminology refers to the size of the lens opening. Shutter speed and aperture are the variables forming

the basis of exposure. Since the T50 is programmed to select and set the best aperture/shutter speed combination for you automatically, you will not have to worry about making any manual settings.

A slowly blinking "P" (about 2 times per second) is a camera shake warning. This means the shutter speed is 1/30 sec or slower, so it is best to use flash. If flash is not available, bring more light into the picture, or mount your camera on a tripod.

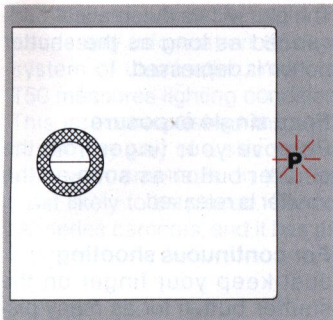

A rapidly blinking "P" (about 8 times per second) means shooting is not possible without the use of flash. See p. 24 for more on photography with the Canon Speedlite 244T.

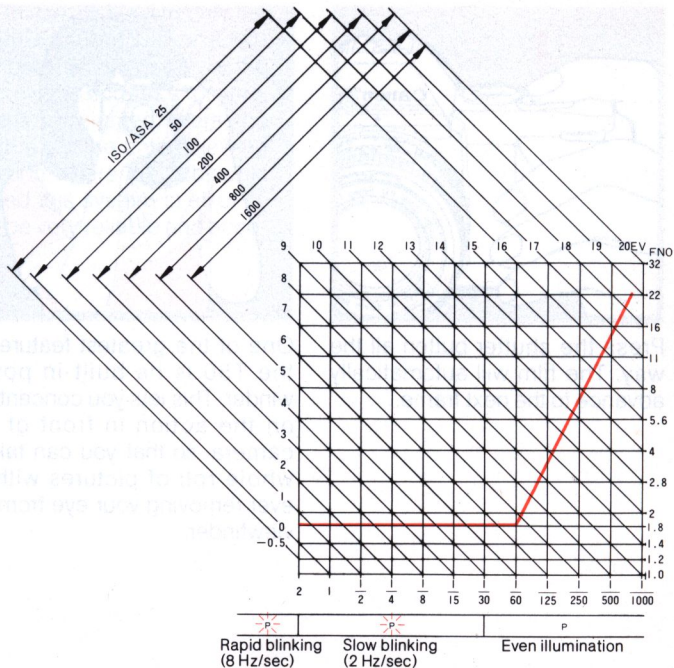

Rapid blinking (8 Hz/sec) Slow blinking (2 Hz/sec) P Even illumination

The solid line indicates the meter coupling range in programmed AE when the FD 50 mm f/1.4 is used.

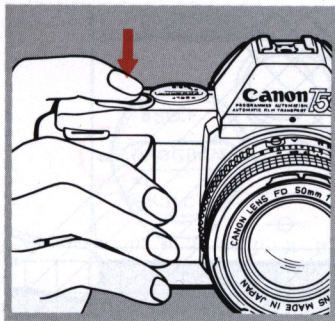

The film will be automatically advanced as long as the shutter button is depressed.

For a single exposure:

Remove your finger from the shutter button as soon as the shutter is released.

For continuous shooting:

Just keep your finger on the shutter button for as many pictures as you wish to take. Continuous shooting takes place at a maximum speed of 1.4 fps (frames per second).

18

Press the shutter button all the way. The film will automatically advance to the next frame.

One of the greatest features of the T50 is its built-in power winder. This lets you concentrate on the action in front of the camera, so that you can take a whole roll of pictures without ever removing your eye from the viewfinder.

11. The T50's Viewfinder

The T50's viewfinder is bright and easy to use, displaying only the necessary information through a Light-Emitting Diode (LED) system of illumination. You may have been wondering how the T50 measures lighting conditions and provides correct exposure. This is accomplished through the Center-Weighted Averaging System by way of a silicon photocell. It reads the entire viewing area with emphasis on the central portion where the subject is most likely to be placed. Canon has used this system in all of its "A" series cameras, and it has proven to be very reliable and accurate.

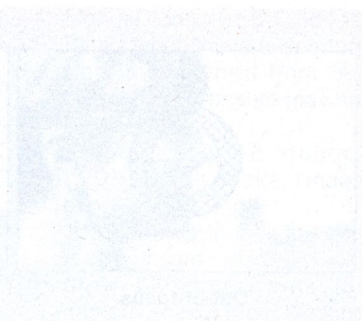

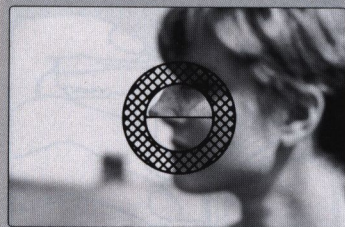

Out-of-focus

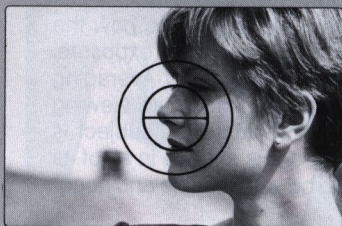

In-focus

20

The focusing aids in the center of the viewfinder will help you focus all your pictures sharply. They can be used alone or in combination. See the illustration on the facing page.

The center of the view finder is enlarged for your easy understanding.

1. **Laser Matte Screen**
When it is difficult to focus the subject, use the laser matte screen. It appears fuzzy until the subject is in focus.
2. **Microprism Rangefinder**
Shimmers when the subject is out of focus. It is clear and steady when in focus.
3. **New Split Rangefinder**
Divides the subject in half horizontally. Especially useful for subjects with vertical lines. The subject is in focus when the two halves merge to become one unbroken image.

Note:

When using a lens with a maximum aperture of $f/5.6$ or smaller, half of the split-image rangefinder may take on a slight color.

13. Viewfinder Information

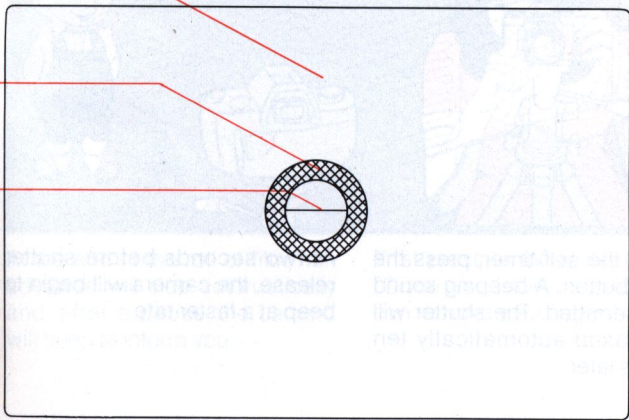

- 4. Manual control LED
Blinks when the lens aperture ring is detached from "A."
Warns that exposure may not be correct.
- 5. Programmed AE control LED/Camera shake, Under-exposure warning
"P" lights up to indicate correct exposure.
Slow blinking warns for camera shake; rapid blinking means shooting not possible.
- 6. Flash-charge completion LED; with 244T, also flash exposure confirmation.
Lights up when flash is charged, and with the 244T, confirms auto flash exposure.

M

P

⚡

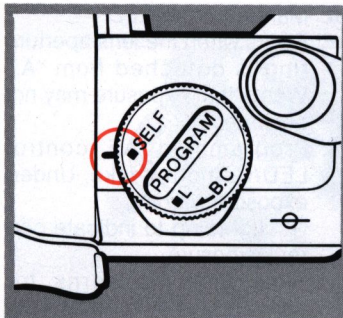

22

Set the selector dial to "SELF" and focus your picture.



To start the self-timer, press the shutter button. A beeping sound will be emitted. The shutter will be released automatically ten seconds later.

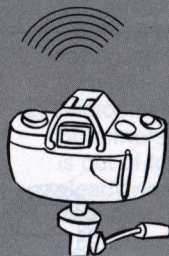

At two seconds before shutter release, the camera will begin to beep at a faster rate.

Hint:

When a tripod is not available, put the camera on a table for self-timed photography.

The T50 sets the exposure the moment you press the shutter button. To ensure correct exposure, be sure to look through or cover the viewfinder when pressing the shutter button to avoid stray incoming light. Also, do not stand in front of the lens.

If you have started the self-timer and wish to cancel it before shutter release, rotate the selector dial back to "PROGRAM" or "L."

Following exposure, unless you want to use the self-timer for the next frame, reset the selector dial to "PROGRAM" or "L."

15. Rewinding the Film

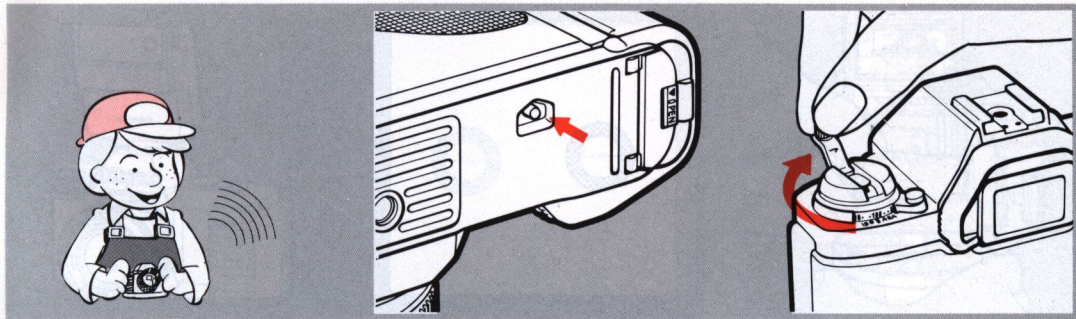

At the end of the roll of film, film advance will stop automatically and, after a pause, the camera will beep to inform you.

First press in the rewind button. (Once you have pressed it, you can remove your finger.)

Then turn the rewind crank in the direction of the arrow. Keep turning until you feel no further pressure on the rewind crank.

If you do not remove your finger from the shutter button after film advance has stopped, the camera will continue to beep until you let go of the shutter button.

DO NOT open the back cover until the film is completely rewound. Doing so may ruin most or all of your film.

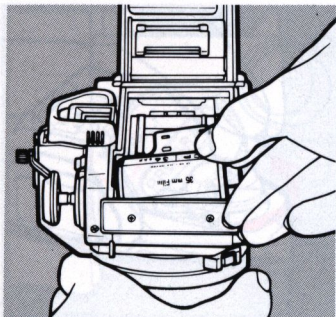

24

When the rewind crank feels loose, open the back cover. The frame counter will automatically return to "S." Remove the film cartridge and place it back in its canister. It should be developed as soon as possible.

Note:

There is an extremely rare possibility that, when the film advance stops at the end of the film, the mirror inside the camera body may not flip back to its normal position. If this happens, simply press the rewind button. The mirror will then return to its normal position.

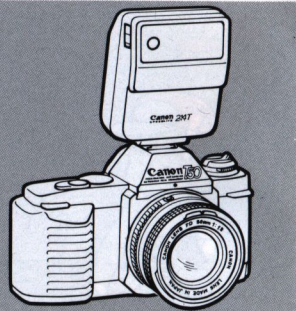
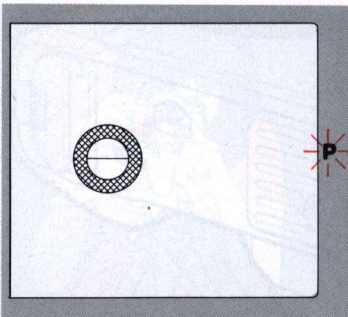

Switch to flash photography when the green "P" starts to blink. For best results, we recommend using the 244T* with the T50. It is incredibly easy to use, and has been designed exclusively to go along with the T50.

Turn the main switch ON and set the ISO/ASA film speed on the flash.

* The 244T should only be used with the T50.

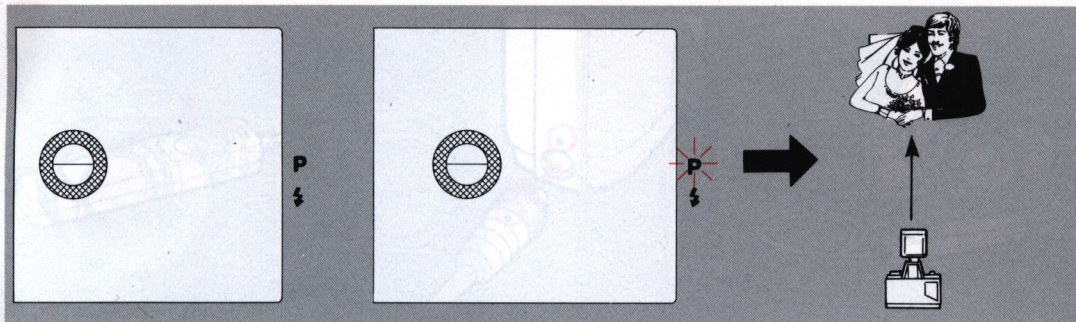

Depress the shutter button half-way; once the " ⚡ " mark signals that the flash is charged, you are ready for flash photography.

You need not make any settings. The aperture is automatically set for the best exposure results. The shutter speed is also set automatically to X-sync (1/60 sec).

If the subject is too far from the flash, the green "P" will blink rapidly to warn you. Move closer to your subject in such cases.

When using "A" series Speedlites and the 533G or 577G with the T50, the shutter speed is set automatically to X-sync (1/60 sec), and the aperture is adjusted automatically to the aperture value of the flash as soon as the pilot lamp glows.

It is recommended to use a Canon flash unit on the T50. Using a flash or flash accessory of another make may cause the camera to work improperly or even possibly damage the camera itself.

17. Photography with the Remote Switch 60 T3

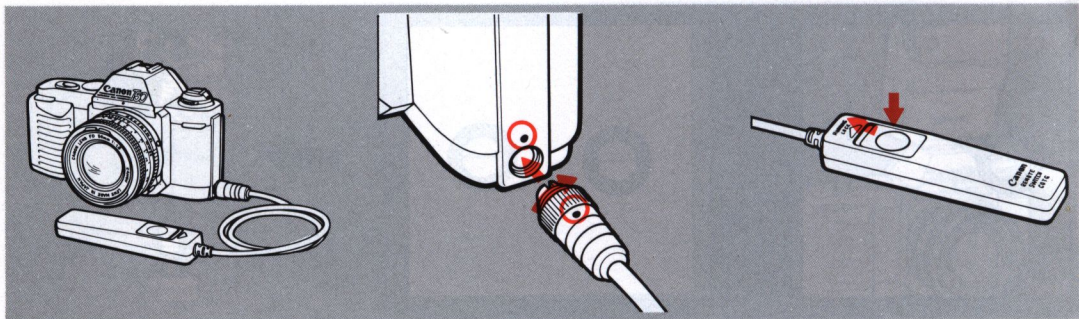

26

The Remote Switch 60 T3 is a useful accessory that has also been designed exclusively for the T50. Attached directly to the camera body, it enables you to shoot by remote control. And since the T50 has a built-in power winder, you do not need an extra accessory to advance the film. With the optional Extension Cord 1000 T3 (approximately 10 m, or 30 ft), you can shoot from a distance, especially useful when photographing wildlife.

Attach the 60 T3 to the remote control socket of the camera body.

Depress the remote switch release button to take a picture. For continuous shooting, slide the release button to the running lock position.

Since the remote switch shutter button and the camera shutter button are independent of each other, the camera's shutter button may be used, even if the Remote Switch 60 T3 is attached.

Lens Hood

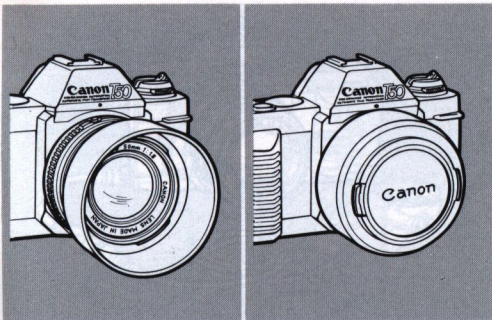

We strongly recommend the use of a lens hood to keep out side light which may cause flare and ghost images to form on the image. Rigid Canon hoods also help to protect the lens from shock. Use only a hood which is specified for your particular lens. Most Canon hoods fit into the bayonet mount and are fixed by turning. For more details, please see the lens instruction manual.

Dioptric Adjustment Lenses S

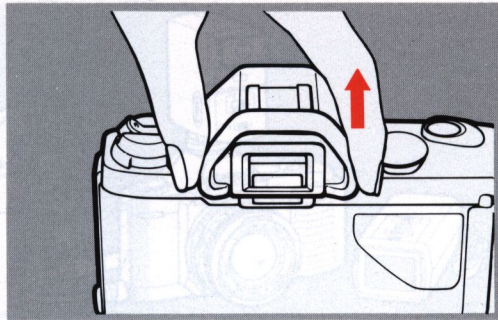

Ten eyesight correction lenses are available in the powers of +3, +2, +1.5, +1, +0.5, 0, -0.5, -2, -3 and -4 diopters. They may make viewing and focusing easier if you are near- or farsighted. Slide the Eyecup T up to remove it before you attach the dioptric adjustment lens to the camera. Choose the one which is closest to your eyeglass prescription, and make a practical test if possible.

Note:

Attaching the dioptric adjustment lens with the Eyecup T is not possible.

Canon Wireless Controller LC-1

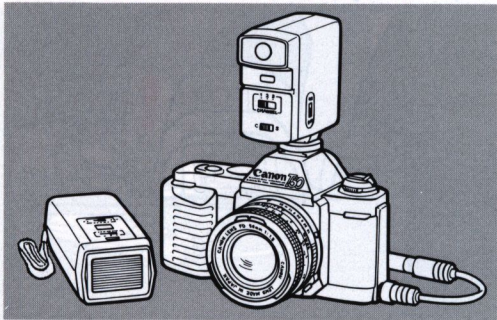

28 This accessory is a remote control photography device using infrared rays to control cameras from a distance. The LC-1 is particularly useful in sports photography, wildlife photography, news coverage, and for numerous other fields. The Wireless Controller LC-1 consists of a transmitter and a receiver. Up to three cameras can be operated in series when the receivers are set to different channels.

Interval Timer TM-1 Quartz

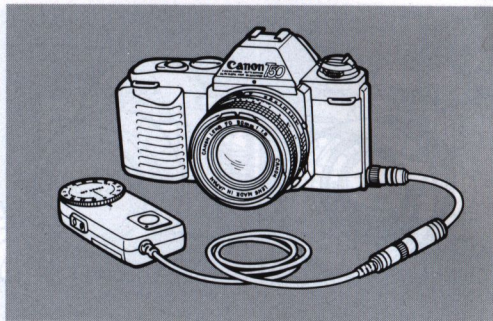

The Canon Interval Timer TM-1 Quartz allows unmanned shooting at timed intervals between 1 second and 30 minutes in fourteen steps. Its quartz control assures a precise time interval. It is especially handy for the observation, recording, and analysis of plant and animal life.

Note:

Attach the Remote Switch Adapter T3 when using the camera with the Wireless Controller LC-1, Interval Timer TM-1 Quartz, or older remote control accessories. Also, cover the viewfinder of the camera when using those accessories to avoid stray incoming light.

19. Carrying the Camera

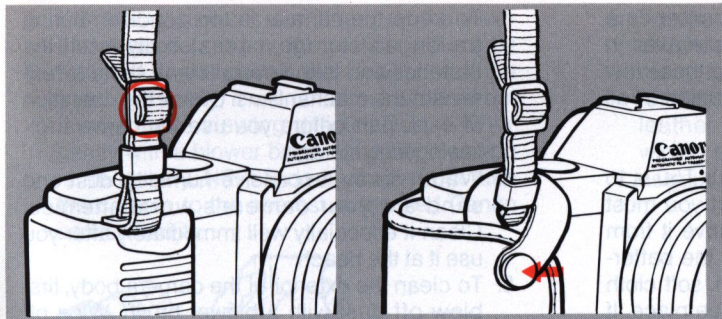

Thread the ends of the strap through the rings on the camera as shown.

For carrying the camera, in particular, insert it into its semi-hard case (optional accessory) as shown.

Unsnap the top cover of the case to remove it. Turn the lens focusing ring to infinity (∞) before closing the top cover again.

Do not forget to turn the selector dial to "L" to prevent accidental shutter release while carrying the camera.

20. Caring for Your Camera

As with any precision instrument, proper care and maintenance involve a few simple rules in addition to common sense. Observing these few rules will keep your T50 in top condition at all times.

1. The best thing you can do for your T50 is to use it regularly. In the event that you must store it for quite a while, first remove it from its case or camera bag. Remove the batteries. Wrap the camera in a clean, soft cloth and place it in a cool, dry, dust-free place. If you store the body and lens separately, attach both the body and rear lens caps.



2. Keep the camera and lens out of direct sunlight and away from "hot spots," such as the trunk, rear window shelf or glove compartment of a car. Do not store the camera in a laboratory or other such area where chemicals may cause corrosion.

3. To keep the camera in top condition during prolonged storage, occasionally insert the batteries and take several blank shots to "exercise" the mechanisms. Check the operation of each part before you use the camera following long storage.
4. Water, spray, excessive humidity, dust and sand are your camera's worst enemies. Clean it especially well immediately after you use it at the beach.
5. To clean the exterior of the camera body, first blow off dust with a blower brush. Wipe off smudges with a silicone cloth or chamois leather. If smudges remain on the eyepiece after using a blower brush, wipe it lightly with lens cleaning tissue which has been moistened with a couple of drops of lens cleaner.

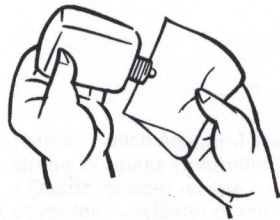

6. If the lens surfaces are clean, yet the viewfinder appears dusty, the picture will not be affected by the dust in the viewfinder. If the mirror gets dirty, it will not affect pictures but it may make viewing difficult. Dust it VERY gently with a blower brush. If further cleaning is necessary, NEVER do it yourself but take the camera to the nearest authorized Canon service facility.

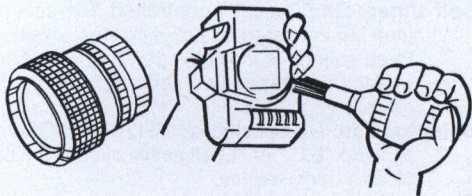

7. The film chamber needs cleaning from time to time to remove film dust which may scratch the film. Gently dust it out with a blower brush. Be careful NEVER to press on the shutter curtain.

8. To clean the lens surfaces, use only a blower brush, cleaning fluid and tissue made specially for cleaning camera lenses. Carefully follow the lens instruction manual. Chamois leather or a silicone cloth may be used for wiping smudges off the lens barrel—NEVER use such cloths on the glass surfaces!

Aerosol spray dust removers are not recommended for the shutter curtain area. If used, hold the can at least 20 cm (8 inches) away from the curtain.

Type: 35 mm SLR (Single-Lens Reflex) camera with electronically-controlled programmed AE (Automatic Exposure).

Exposure Modes: Programmed AE and programmed AE flash photography with Canon Speedlite 244T.

Format: 24 × 36 mm.

Usable Lenses: Canon FD series lenses only.

Viewfinder: Fixed eye-level pentaprism.

Field of View: 92% vertical and 93% horizontal coverage of the actual picture area.

Magnification: 0.83X at infinity with a standard lens.

Viewfinder Information: Information is displayed by way of LED digital display positioned to the right of viewing area.

(P): Programmed AE indicator. 2 Hz flashing indicates camera shake warning; 8 Hz flashing indicates underexposure warning.

(M): Manual aperture setting. 4 Hz flashing indicates exposure may be incorrect.

($\frac{1}{2}$): Flash charge-completion display.

AE Mechanism: Electronically-controlled programmed AE.

Light Metering System: TTL (Through-The-Lens), Center-weighted average by SPC (Silicon Photocell). Stopped-down metering is impossible and Non-FD lenses and close-up system accessories without AE signal pins cannot be used.

Meter Coupling Range: EV 1 to EV 18 with ISO 100/21°, ASA 100 film.

Film Speed Scale: ISO 25/15°, ASA 25—ISO 1600/33°, ASA 1600.

Shutter: Vertical travel focal-plane, electromagnetic attraction shutter. Electronically controlled.

Shutter Speed: Automatically controlled from 2 sec to 1/1000 sec at "A." 1/60 sec when disengaged from "A."

Mirror: Instant-return, with shock and noise absorber.

Self-timer: Electronically controlled. Ten-second time lag activated by pressing shutter button. Beep sounds to indicate operation; sound frequency increases two secs before shutter release.

Selector Dial: Four positions: "SELF," "PROGRAM," "L," and "B.C." At "L" all active circuits are cut off as a safety feature.

Shutter Button: Two-step, electromagnetic shutter button. Pressing it halfway activates the indicators. Pressing it all the way sets shutter in operation.

Flash Synchronization: X-sync at 1/60 sec. Direct contact at accessory shoe for hot-shoe type flash. When used with Canon "A" series Speedlites, 533G, or 577G, shutter speed is automatically set and aperture is also automatically set to the aperture value of the flash when the pilot lamp glows.

Automatic Flash: Programmed with the Canon Speedlite 244T. After infrared light is radiated, shutter speed and aperture (f/2.8, f/4, f/5.6) are automatically set according to the shooting distance and the reflectivity of subject.

Remote Control: Possible. With three-terminal contact for remote control.

Remote Switch 60 T3 exclusive is required.

Power Source: Two size-AA alkaline-manganese or carbon-zinc batteries.

Ni-Cd batteries cannot be used.

Battery Check: Beep sounds when rotating selector dial to "B.C." Absence of sounds indicates insufficient power.

Back Cover: Opened by pulling up rewind knob. Unremovable.

Film Loading: Loaded automatically. Automatically advances to "1" at 1/1000 sec by keeping the shutter button pressed.

Film Advance: Advanced automatically by a built-in power winder.

Approximately 0.7 sec for film advance. Continuous shooting is possible by keeping the shutter button pressed.

Film End Warning: Warned by beep sounds.

Film Rewind: By pressing rewind button and cranking rewind knob.

Frame Counter: Additive type. Automatically resets to "S" upon opening back cover.

Dimensions: 150.2mm × 87mm × 48.4mm (5-15/16" × 3-7/16" × 1-15/16") body only.

Weight: 490 g (17-5/16 ozs.) body only.

Subject to change without notice.

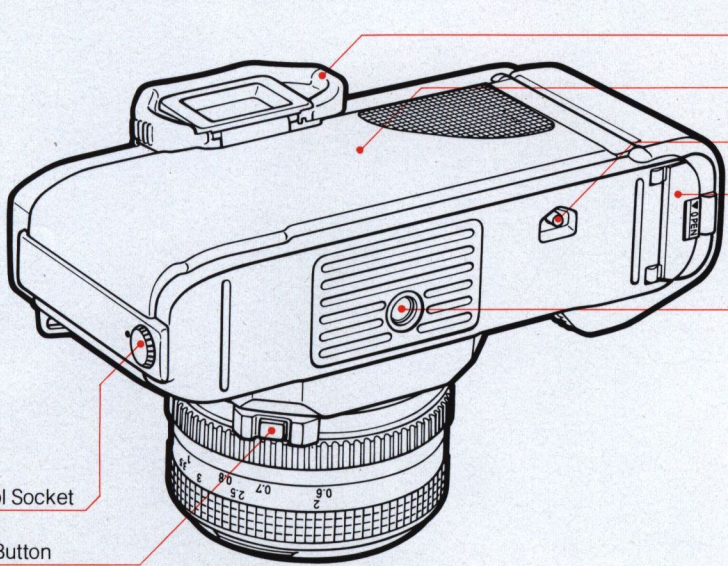

Detachable Eyecup T

Back Cover

Film Rewind Button

Battery Chamber Cover

Tripod Socket

Remote Control Socket

Lens Release Button



Canon

CANON INC. 7-1, Nishi-Shinjuku 2-Chome, Shinjuku-ku, Tokyo 160, Japan
Mailing address: P.O. Box 5050, Dai-ichi Seimei Building, Tokyo 160, Japan

U.S.A. **CANON U.S.A., INC. HEADQUARTERS**
One Canon Plaza, Lake Success, N.Y. 11042, U.S.A.
CANON U.S.A., INC. MANHATTAN SERVICE CENTER
600 Third Avenue, New York, N.Y. 10016, U.S.A.
CANON U.S.A., INC. ATLANTA BRANCH
6380 Peachtree Industrial Blvd., Norcross, Georgia 30071, U.S.A.
CANON U.S.A., INC. CHICAGO BRANCH
140 Industrial Drive, Elmhurst, Illinois 60126, U.S.A.
CANON U.S.A., INC. LOS ANGELES BRANCH
123 Paularino Avenue East, Costa Mesa, California 92626, U.S.A.
CANON U.S.A., INC. LOS ANGELES SERVICE CENTER
3321 Wilshire Blvd., Los Angeles, California 90010, U.S.A.
CANON U.S.A., INC. SAN FRANCISCO OFFICE
776 Market Street, San Francisco, California 94102, U.S.A.
CANON U.S.A., INC. DALLAS OFFICE
2035, Royal Lane, Suite 290, Dallas, Texas 75229, U.S.A.
CANON U.S.A., INC. HONOLULU OFFICE
Bldg. B-2, 1050 Ala Moana Blvd., Honolulu, Hawaii 96814, U.S.A.

CANADA **CANON CANADA INC. HEADQUARTERS**
3245 American Drive, Mississauga, Ontario L4V 1N4, Canada
CANON CANADA INC. MONTREAL SERVICE CENTRE
10652 Côte de Liesse, Lachine, Quebec H8T 1A5, Canada
CANON CANADA INC. CALGARY OFFICE
2828, 16th Street, N.E. Calgary, Alberta T2E 7K7, Canada

EUROPE, AFRICA
& MIDDLE EAST **CANON EUROPA N.V.**
P.O. Box 7907, 1008 AC Amsterdam, The Netherlands
CANON FRANCE-PHOTO CINEMA S.A.
30, boulevard Vital-Bouhot, Ile de la Jatte, 92521 Neuilly-sur-Seine, France
CANON UK LTD.
Units 4 & 5, Brent Trading Centre, North Circular Road, London NW10 0JF, United Kingdom

CENTRAL &
SOUTH AMERICA **CANON LATIN AMERICA, INC. DEPTO. DE VENTAS**
Apartado 7022, Panamá 5, República de Panamá
CANON LATIN AMERICA, INC. CENTRO DE SERVICIO Y REPARACION
Apartado 2019, Zona Libre de Colón, República de Panamá

SOUTHEAST ASIA **CANON HONGKONG TRADING CO., LTD.**
Golden Bear Industrial Centre, 7/F, 66-82 Chei Wan Kok Street,
Tsun Wan, New Territories, Hong Kong
CANON SINGAPORE PTE. LTD.
80-B Main Road, #1J-01/06, Singapore Warehouse, Block C, Singapore 0923

OCCEANIA **CANON AUSTRALIA PTY. LTD.**
Unit 1/37, Waterloo Road, North Ryde (Macquarie Park), N.S.W. 2113, Australia

JAPAN **CANON SALES CO., INC.**
11-28, Mita, 3-Chome, Minato-ku, Tokyo 105, Japan

PUB.C-IE-105U
0484B45

© CANON INC. 1982

PRINTED IN JAPAN