

Canon

F-1

INSTRUCTIONS

We are highly gratified that you have selected the Canon F 1—a wise choice that promises you many delightful years of photographic experiences. Canon is recognized the world over as the foremost pioneer in the development of photographic equipment of the highest quality and performance. Whether your new F 1 is for the home, laboratory or for traveling, make the most of your opportunities!

Before Using

Please read this instruction booklet carefully and master the manipulations of the various parts of the F-1 completely. Once thoroughly versed in the correct handling of this camera, you can use the Canon F 1 to the fullest extent of its capabilities.



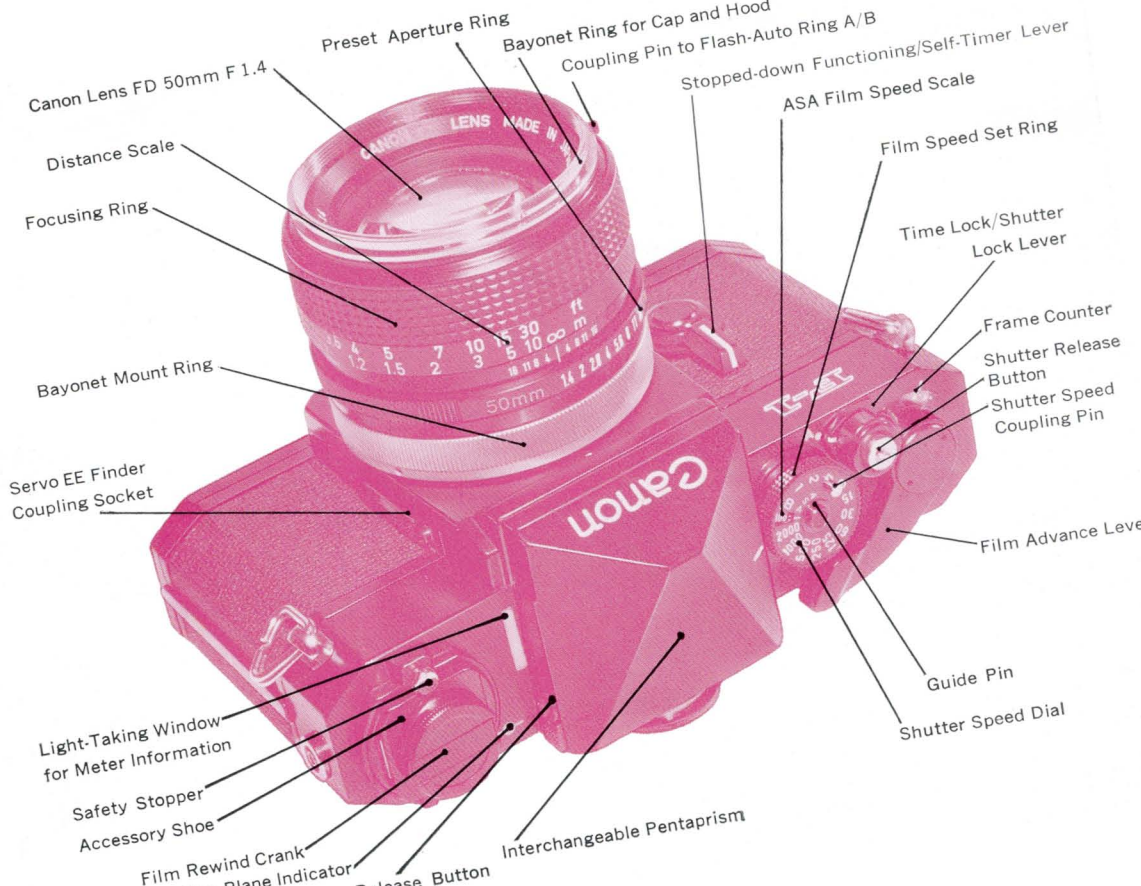

Canon F-1 System

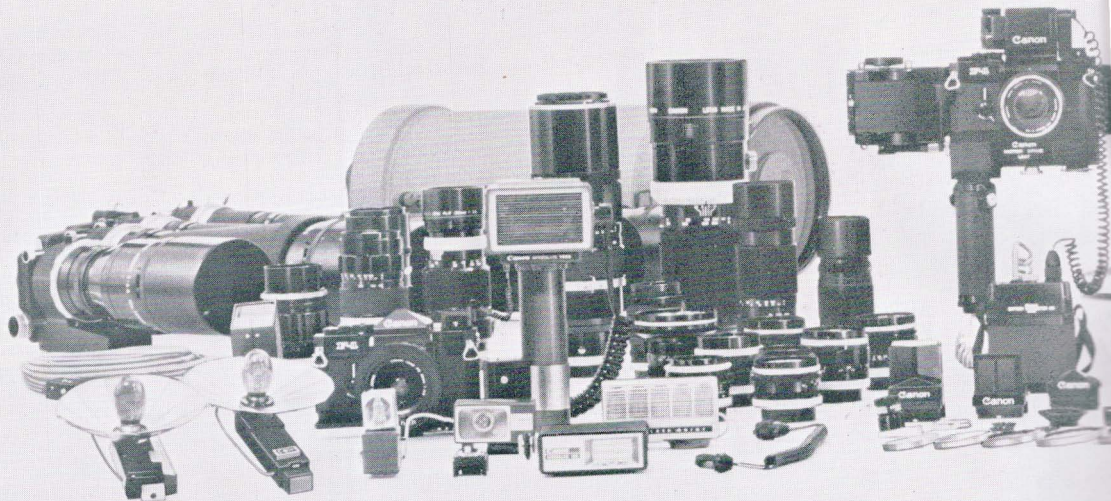

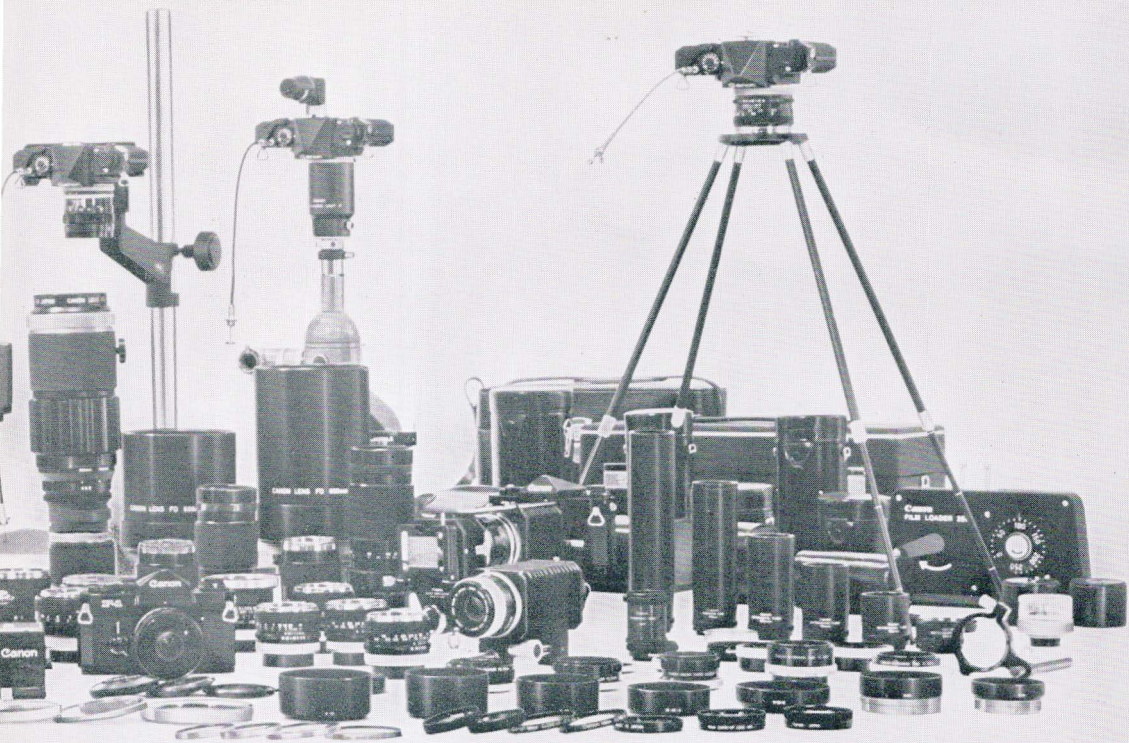

Technical Data

- Type: 35mm single-lens reflex camera with focal plane shutter. Picture size; 24 x 36mm.
- Interchangeable Lenses: Canon FD series lenses with aperture signal lever.
- Standard Lens: Canon FD 55mm F1.2, FD 50mm F1.4, FD 50mm F1.8.
- Viewfinder: Removable pentagonal prism viewfinder. Interchangeable with Servo EE Finder, Booster T Finder, Speed Finder, Waist-Level Finder.
- Viewfinder Attachments: Angle Finder B, Magnifier, Dioptic Adjustment Lenses, Eyecup.
- Focusing Screen: Using Fresnel lens, standard focusing glass with microprism screen rangefinder and three other interchangeable types. With metering beam-splitting condenser.
- Field-of-View: 97% of actual picture area. 0.77X with standard 50mm lens at infinity.
- Finder Information: Meter needle and aperture needle, outside shutter speed coupling range indicator, fixed dot for stopped-down metering use and battery check mark, shutter speed scale, metering limit marks.
- Dioptic Adjustment Lenses: Standard -1.2 diopter (R-1). Interchangeable with R+3, R+2, R+1, R0, R-2, R-3, and R-4.
- Mirror: Quick return mirror with shock-absorbing mechanism. Mirror can be fixed in upper position. Aperture is manually operated when mirror is fixed in upper position.
- Lens Mount: Bayonet type FD mount. FL and R series of lenses mountable.
- Function: FD lenses; Full aperture metering, coupled with automatic diaphragm. FL lenses; Stopped-down metering, coupled with automatic diaphragm. R lenses; Stopped-down metering, manually operated diaphragm.
- Shutter: Focal plane shutter using super thin titanium screen. Designed for elimination of functioning noise. Shutter release button can be locked.
- Shutter Speed Dial: Single shaft non-revolving type with shutter scales and ASA film speed scales. Two coupling pins for setting attachments are provided.
- Shutter Speeds: B, 1-1/2000. Multiple series. Equiinterval index. X contact at "60".
- Film Speed Scale: ASA 25-2000.
- Self-Timer: Built in. Activate with shutter release button. Approx. 10 sec. time lag. Self-timer lever is used in common as stopped-down functioning lever.
- Exposure Adjusting Mechanism: Built in. Using CdS photocell. Coupled to shutter speeds, film speeds and f/stop. Match needle type TTL full aperture metering mechanism. Center-

spot metering system, measures 12% of picture area. Stopped-down metering possible. Fixed dot type metering using stopped-down functioning lever. Locking of the lever possible.

- Exposure Meter Coupling Range: With ASA 100 film, EV 2.5 (f/1.2 at 1/4 sec.)–EV 18 (f/11 at 1/2000 sec.). Meter information window turns red when outside of coupling range.
- Meter Battery: One 1.3V M20 (#625) mercury battery used.
- Battery Checker: Built in. Check at ASA 100, shutter speed at 1/2000 sec.
- TTL Full Aperture Metering System EE: Uses exclusive Servo EE Finder and Battery Case in combination. Full aperture metering with FD lens. Shutter priority type EE. Functioning range; with ASA 100 film, EV 2.5 (f/1.2 at 1/4 sec.)–EV 18 (f/11 at 1/2000 sec.).
- Ultra-low Illumination Metering: Metering possible, with ASA 100 film, between EV 15 (f/22 at 1/60 sec.) and EV–3.5 (f/1.2 at 15 sec.) with use of exclusive Booster T Finder.
- Synchronized Flash: FP and X contact. Automatic time lag adjusting type.
- Flash Socket: On side body. Two contacts on film rewind knob for flash circuit for directly connected adapter, and meter circuit.
- Canon Auto Tuning (CAT) System: Diaphragm control by recharge completion signal and focusing distance signal. Proper aperture is established by the meter matching needle system through the connection of the Speedlite 133D, Flash Auto Ring, Flash Coupler L and prescribed FD 50mm F 1.4, FD 50mm F 1.8, or FD 35mm F 2 lens.
- Synchronizing Range: FP class; 1/2000–1/125 sec. and 1/30 sec. or under. Speedlite; 1/60 sec. or under. M, MF class; 1/30 sec. or under.
- Film Loading: With multislit film spool.
- Film Winding: Short-stroke winding possible. Single operation 180° winding lever. Play; 15°.
- Film Rewinding: Performed by rewind button and crank.
- Double Exposure: Possible by operating film rewind button.
- Back Cover: Crank pull-up type. Removable for Film Chamber 250.
- Bottom Cover: Motor Drive Unit can be attached after removing bottom cover.
- Frame Counter: Self-resetting type activated by opening back cover.
- Accessory Shoe: Exclusive. Flash Couplers D, L, and other couplers can be attached.
- Size: 98.7 x 146.7 x 43mm (3⁷/₈" x 5³/₄" x 1¹¹/₁₆").
- Weight: Body; 820 g (1.80 lbs.). With FD 50mm F 1.4 Lens; 1,180 g (2.60 lbs.).

Subject to alterations.

Four Main Accessories

- Canon Booster T Finder with electronic timer for insufficient light photography
 - Canon Servo EE Finder for shutter priority EE photography
 - Canon Motor Drive Unit for timer photography and high speed photography
 - Canon Film Chamber 250 for shooting 250 frames
- Unmanned photography is possible in combination of these accessories.



*For details, please refer to pages 49-52.

Contents

Mercury Battery Loading and Checking	12
Film Winding	14
Shutter and Aperture Adjustment	16
Using Built-In Exposure Meter	20
Exposure Settings	22
Coupling Range of Built-In Exposure Meter	25
Viewing and Focusing	26
Holding the Camera	29
Film Loading	31
Film Rewinding	34
Synchronizing Flash Unit	35
Uses of Lenses	37
Using Self-Timer	44
Double Exposures	45
Interchangeable Lenses FD	46
Bottom Cover and Back Cover	48
Accessories for the F 1	49-57
Motor Drive System and Power System	50
Viewfinder System	52
Flash Photography System	54
Close-up, Macrophotography and Photomicrography	55
Filters	56
Other Accessories	57
Proper Care of the Camera	59

Follow these simple steps for normal photography:

- 1** Load the film. (See pages 31–32.)
- 2** Set the ASA film speed. (See page 21)
- 3** Wind the film advance lever (See page 14.)
- 4** Remove the lens cap.

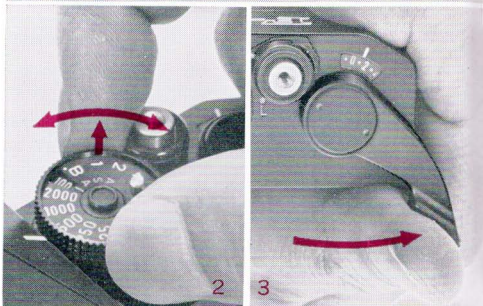
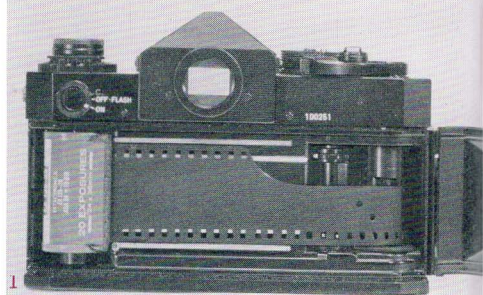

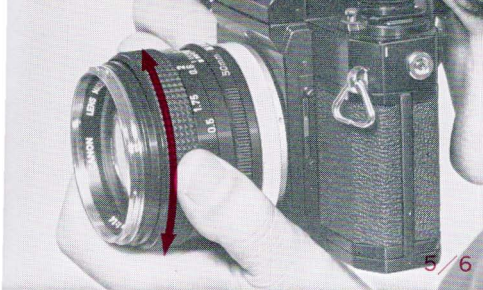

5 Look through the viewfinder and focus. (See page 26.)

6 Compose the picture.

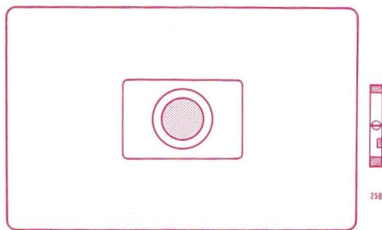

7 Determine the exposure with built-in meter (See pages 22-24.)



8 Press the shutter release button gently.

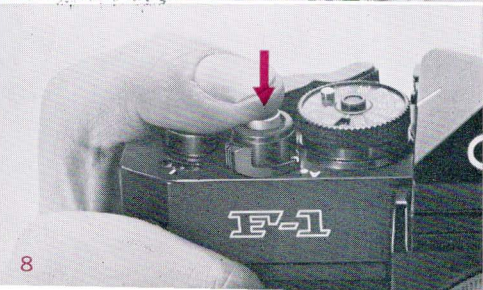

Mercury Battery Loading and Checking

The built-in exposure meter of the Canon F 1 functions only when the mercury battery is properly loaded.

- 1 Insert a coin into the groove of the battery compartment cover and turn it to the left to remove.
- 2 Face the central contact of the mercury battery inwards and insert.
- 3 Replace the cover by turning it to the right.

■ Before inserting battery wipe off fingerprints or stains on battery poles with a dry cloth. Unclean poles may cause corrosion and damage the contact points of the camera.

■ A 1.3 v M20 (#625) mercury battery should be used—equivalent to Mallory PX-625, Eveready EPX 625.

■ Be sure to insert the battery in the correct direction, referring to the diagram on the compartment cover. Otherwise, the meter will not function properly and the cover cannot be screwed in.

■ When the camera is not going to be used for a long period, remove the mercury battery and keep it in a dry place.

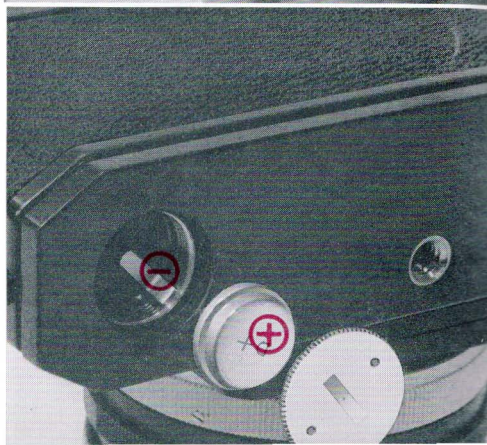
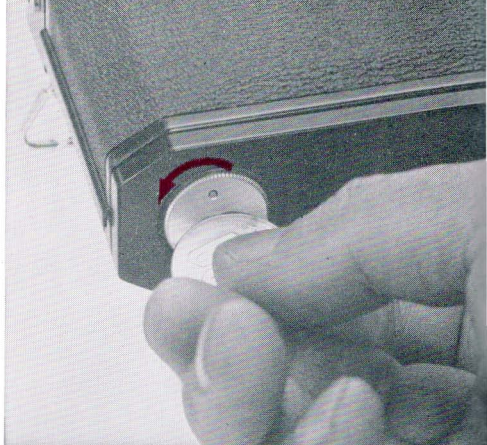

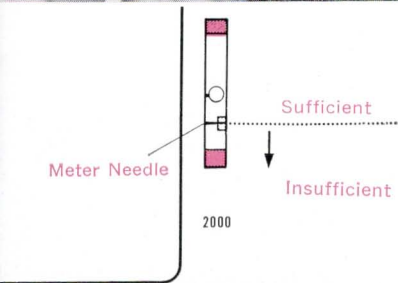
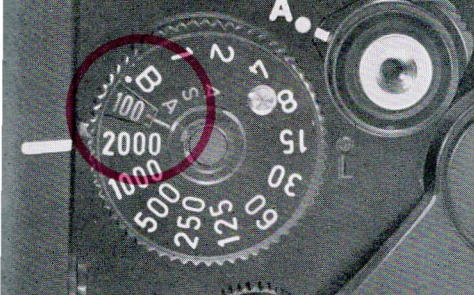

Battery Check

Check the mercury battery after loading it. Especially when loading a new battery be sure to check the power level.

1 Set the film speed scale at ASA 100 and the shutter speed dial at '2000' To set the film speed, lift up the outer ring on the shutter speed dial and turn. See page 21

■ A correct check cannot be made if other settings are used.

2 Turn the meter switch, situated on the back side of the camera near the film rewind crank, to the "C" index mark.

3 If the meter needle inside the viewfinder swings to the meter index, the battery has sufficient power. If the needle stays below the meter index, voltage is insufficient and the battery must be replaced.

■ Life of the battery in normal use is approximately one year

4 When using the camera, be sure to turn the meter switch to "ON"

Film Winding

The film advance lever winds the film, cocks the shutter and prepares the aperture and mirror for the next shutter release all in one motion.

1 Turn the film advance lever until it stops. The film will be advanced one frame and the shutter cocked. The frame counter is simultaneously advanced to the next number

2 When the shutter release button is pressed, the mirror flips up, the diaphragm simultaneously closes down to the preset f/stop and the shutter operates. After the shutter is operated, the advance lever can be wound for the next frame.

- Be sure to set the shutter lock lever at A''
- Winding may be accomplished by moving the lever with several short strokes.
- After loading the film, make another wind, because the first winding may not be complete.
- The shutter will not function when the shutter release button is pressed unless winding is completed. In such cases, check the winding once more.

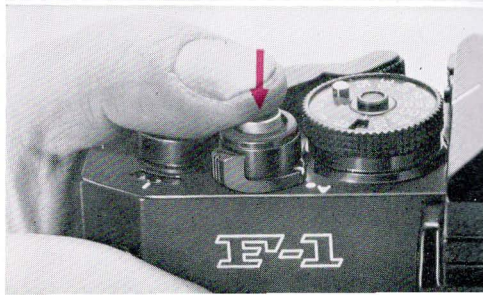
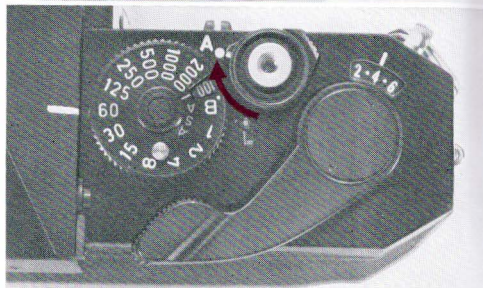
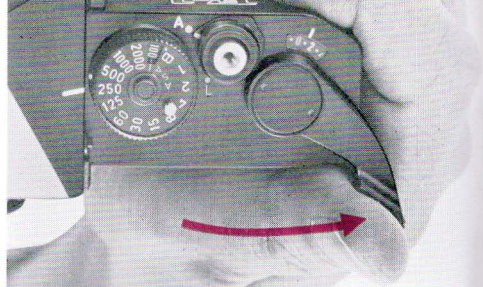

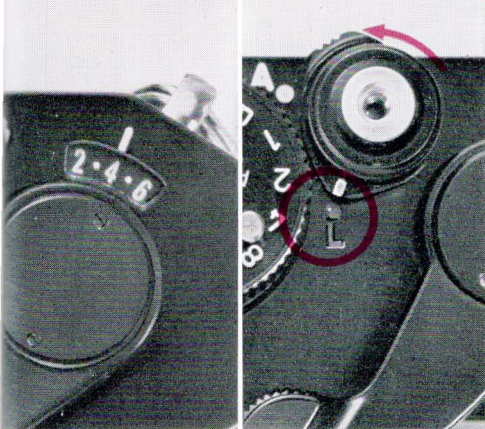

Frame Counter

Each winding will advance the number of the frame counter indicating the number of pictures taken. When the back cover is opened, the counter automatically returns to the starting position "S"

Safety Device for Shutter

When the shutter lock lever around the shutter release button is turned to "L" position, the shutter is locked and will not move. This device may be used when the camera is carried in a wound condition.



Attaching the Cable Release

The optional Canon Release can be attached to the F1 by screwing it into the threaded hole in the center of the shutter release button. Even if the shutter lock lever is at "L" position, the shutter will operate when using the cable release.

Shutter and Aperture Adjustment

Exposure is adjusted by the shutter speed and the aperture. The shutter speed controls the exposure time and the aperture controls the amount of incoming light.

Shutter Speed Dial

Adjust the shutter speed by turning the shutter speed dial to the desired index number. The index on the dial shows the denominators of 1/1000 sec. 1/500 sec. etc.

- The shutter speed dial can not be revolved between the indexes "2000" and B"

- Be sure to set the index at a position where the click-stop catches. In case of B" index, adjust it to the white dot just below the B" index.

- "B" indicates bulb exposure, and is used when making exposures of more than one second. When the shutter speed dial is set at B" the shutter remains open as long as the shutter release button is depressed.

- When time exposure is necessary to make an exposure over an extended time, first set the shutter speed dial at "B". Keep the shutter release button depressed, and turn the time lock lever to L. The shutter remains open even if the finger is removed from the button. When the lever is returned to "A" the shutter closes.

- Time exposure is also possible by using a lockable cable release.

- It is possible to perform a long-time exposure by using

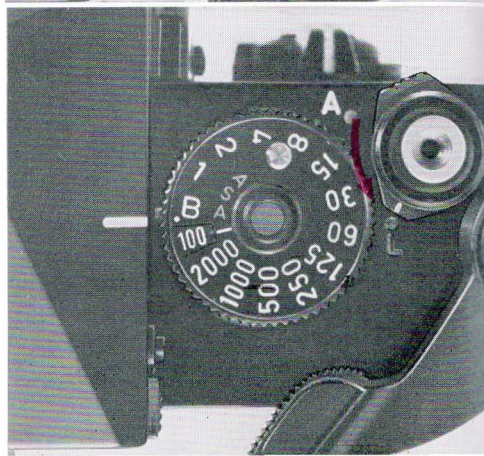
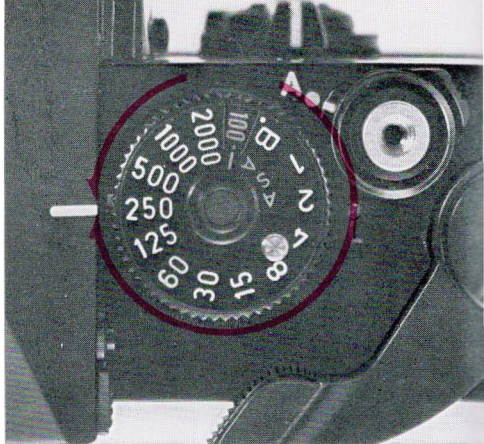

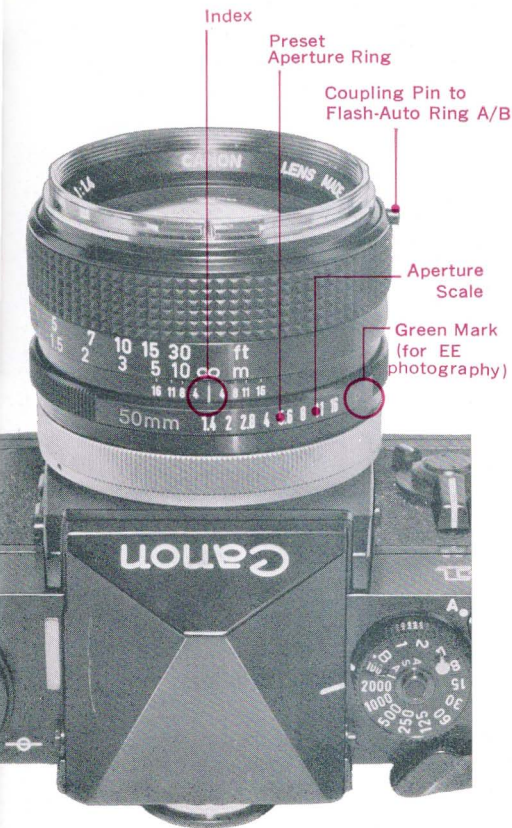

the optional Booster T Finder an auxiliary meter for measuring subjects under dim light.

■ The “60” index is used for synchronizing with an electronic flash unit such as the Canon Speedlite. It is equivalent to a very short exposure during the flash of the flash unit.

Aperture

Incoming light and depth-of-field are adjusted by turning the preset aperture ring to the desired f/stop.

■ As the f/stop value gets larger the amount of light reaching the film plane becomes correspondingly less. For each f/stop increase, the light is reduced one-half. Accordingly when the aperture is increased by one f/stop, the exposure is doubled, and when it is increased by two f/stops the exposure is quadrupled.

■ Certain lenses, however have no relation to the lightness being halved between the maximum and the next f/stops on the preset aperture ring.

■ The preset aperture ring can also be set between two f/stops.

■ The ratio between the aperture and the exposure volume, using f/2 as a basis, is as follows

f/stop

1.2 1.4 1.8 2 2.8 3.5 4 5.6 8 11 16 22

Exposure Ratio

3 2 1.25 1 1/2 1/3 1/4 1/8 1/16 1/32 1/64 1/128

Presetting of Aperture: In the case of the FD lens, the field-of-view can always be seen through the viewfinder at full aperture opening even after the f/stop has been set with the preset aperture ring. Set the desired f/stop, on the preset aperture ring, to the index. The diaphragm will close down to the preset f/stop only for the instant that the shutter is released. Except for that instant, the diaphragm remains fully open.

Checking the Depth-of-Field: The manually operated aperture is used for checking the depth-of-field when the aperture is stopped down and also when performing close-up photography and macrophotography

The FD lens has only one aperture ring. When this lens is mounted on an F 1 or FTb camera body the diaphragm is operated by locking the stopped-down functioning lever. Therefore, the aperture can be closed down to any desired f/stop by turning the preset aperture ring.

■ When an accessory is to be used between the lens and the camera body turn the automatic/manual aperture lever of the lens counterclockwise all the way before mounting the lens. This locks the lever and the aperture is set for manual operation. For releasing the lever turn it clockwise.

With the use of this lock, photography using manually operated aperture can also be performed on Canon single-lens reflex cameras besides the F 1 FTb and Pellix.

■ Refer to pages 40–41 concerning depth-of-field.



Automatic/Manual Aperture Lever

Relationship Between the Shutter, Diaphragm, and Mirror

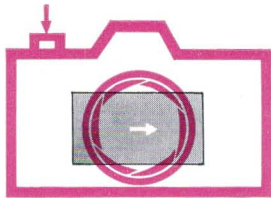

Press the shutter release button.



The shutter clicks.
The diaphragm closes
down to preset f/stop.

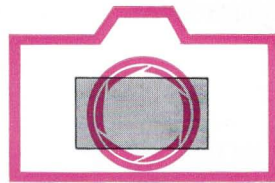

The diaphragm returns
to full aperture opening.

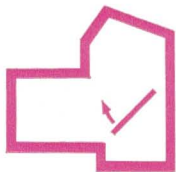

Mirror begins to snap up.



Mirror is up.



Mirror returns to
the former position.

Using Built-In Exposure Meter

Canon F 1 provides the most accurate light measurement possible with its unique TTL (Through-The-Lens) system. The built-in exposure meter which is of match needle type, is coupled to the shutter speed dial and preset aperture ring.

The CdS photocell of the exposure meter is placed in a position closest to the beam-splitting condenser lens. The semi-spot metering system enables accurate measurement of the main subject even in back lighting conditions. The rectangular frame in the viewfinder represents the light measurement area of the CdS photocell. Place the main subject within this frame and measure the intensity of light so as to obtain the proper exposure.

■ The correction of the full aperture opening of the lens is performed automatically. Therefore, the operation does not change regardless of the speed of the lens used. An FL lens can be used only with stopped-down metering.

■ Due to the characteristics of the CdS photocell, the movement of the meter needle may occasionally become sluggish, owing to changes in the intensity of light.

■ When not using the camera, set the meter switch at "OFF" or attach the lens cap so as to prevent unnecessary consumption of the mercury battery

■ Metering at "B" on the shutter speed dial is not possible with the built-in exposure meter because "B" is used for

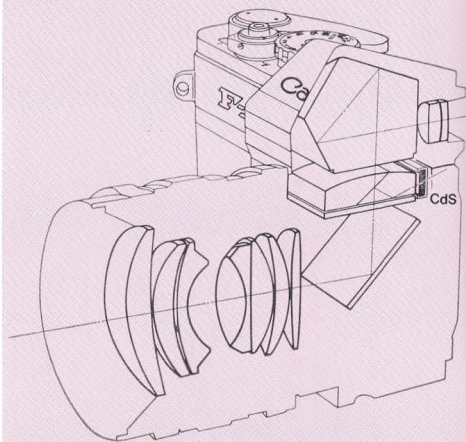

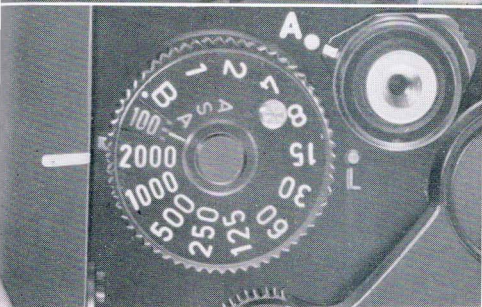
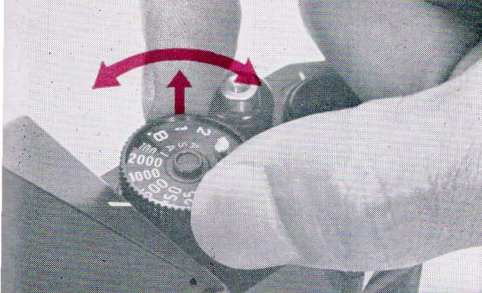

long exposures over one second.

- Always use a lens hood when shooting against the light.

Film Speed Setting

Set the ASA film speed scale to the speed of the film being used. Film speeds are normally shown on the film box cover and/or explanatory sheet.

Lift and turn the film speed set ring around the shutter speed dial. If the film is ASA 100, for example, make the correct setting by showing 100 in the small window

- The following film speeds may be used

	(32)	(40)	(64)	(80)	(125)	(160)	(250)	(320)	(500)	(640)
ASA	25	50	100	200	400	800				
DIN	15	18	21	24	27	30				
	(16)	(17)	(19)	(20)	(22)	(23)	(25)	(26)	(28)	(29)
	(1000)	(1250)	(2000)							
		1600								
		33								
	(31)	(32)	(34)							

Figures in parentheses represent intermediate film speeds.

- When 25 appears in the small window this is as far as the film speed set ring turns to the left. White dot at the right turn extremity reads ASA 2000.

Exposure Settings

Full Aperture Metering

Full aperture metering can be performed with FD lenses which has an aperture signal lever and pin.

- 1 Set the meter switch at 'ON'
- 2 Set the shutter speed dial at the desired speed.
- 3 Face the camera towards the subject, look into the viewfinder and check the needles in the meter reading window
- 4 Turn the preset aperture ring and align the aperture needle with the meter needle.

- The green mark (circle) on the aperture ring is for the Servo EE Finder use only

- The meter needle is coupled to the film and shutter speeds, and moves vertically according to the brightness of the subject. The aperture needle, with a round mark, is coupled to the preset aperture ring of the FD lens.

- In the case of f/stop priority turn the shutter speed dial and align the meter needle with the aperture needle.

- If the aperture needle cannot be aligned with the meter needle by turning the aperture ring, it means that the shutter speed is not properly set. In this case, align the two needles by turning the shutter speed dial.

When the shutter is set at a higher speed, the meter needle moves downward. When it is set at a slower

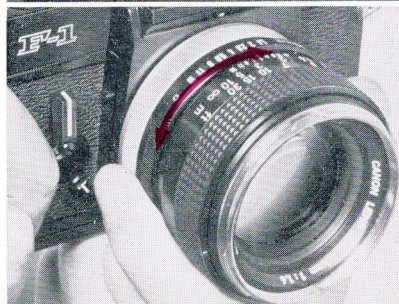
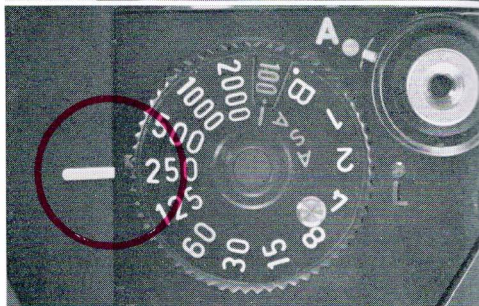
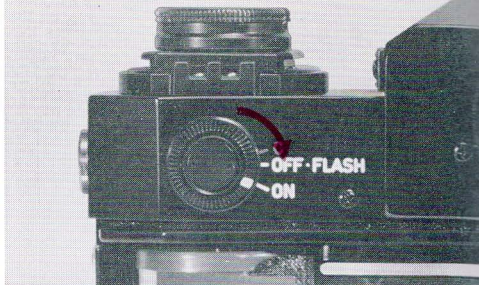

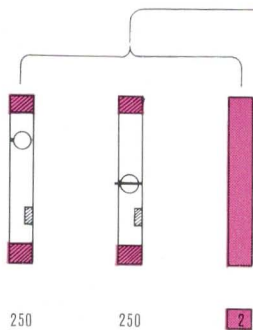
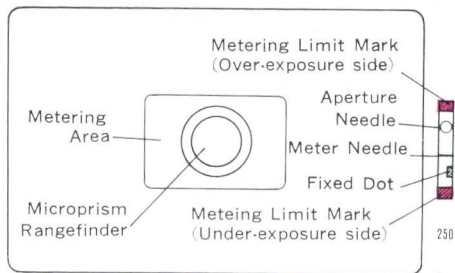

Properly Adjusted

speed, the needle moves upward. When the shutter is set at a slow speed outside the coupling range (slower than 1/2 sec. in case of ASA 100), the meter reading window turns red, and metering will become impossible even if the aperture is changed. When the window turns red and metering cannot be performed, use high-speed film or the optional Booster T Finder. Refer to 'Coupling Range of Built-in Exposure Meter' on page 25.

- Select a faster shutter speed when the meter needle swings all the way up, and a slower speed when it swings all the way down.

- The movement range of the aperture needle inside the meter reading window changes according to the lens speed. Thus, it will not always move vertically the full length of the meter reading window. Change the shutter speed when the aperture needle cannot be aligned with the meter needle.

- Since the shutter speed dial cannot be set at intermediate positions, the shutter speed priority method is recommended when exposure accuracy is a crucial factor.

Stopped-Down Metering

When using a lens, such as FL lenses, having no full aperture metering system stopped-down metering should be done. Stopped-down metering is performed by pushing down the stopped-down functioning lever.

The stopped-down functioning lever can be fixed for continuous light measurement by pressing it towards the lens after setting the lever lock at the 'L' position. If the lock

is returned to the white dot position the lever will return to its original position.

- 1 Set the meter switch at 'ON'
- 2 Set the shutter speed dial at the desired speed.
- 3 Face the camera towards the subject, look into the viewfinder and press the stopped-down functioning lever all the way. The aperture needle will point to the lower metering limit mark and only the meter needle remains.
- 4 Turn the preset aperture ring and make the meter needle stop within the meter index situated in reading window.
 - In the case of f/stop priority adjustments can be made with the shutter speed dial.
 - Full aperture metering is preferred with FD lenses, because the FD lenses have a full aperture system so as to fully compensate the built-in exposure meter. When performing stopped-down metering, be sure to close down the aperture f/2.8 or further
 - With the fixing of the metering lever shooting subjects with different light intensities or telephoto lenses can be conveniently handled.

How to "Average" Exposures

When measuring a subject with greatly different dark and bright parts, take two measurements, one each of the dark and bright parts. Then obtain the average value and set the f/stop or shutter speed accordingly

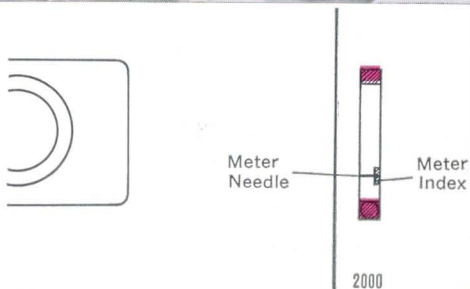
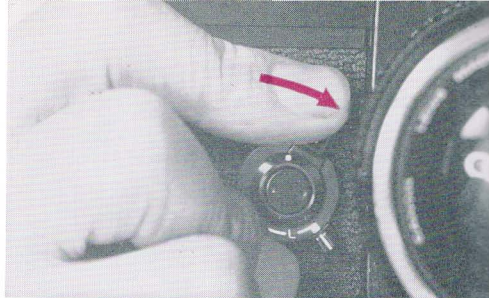

Coupling Range of Built-In Exposure Meter

The built-in exposure meter couples within the following range of f/stops and shutter speeds at respective film speeds. When using the Canon Lens FD 50mm F 1.4 and ASA 100 film, for example, the exposure meter couples fully within the range of EV 3 f/1.4 at 1/4 sec. to EV 18 f/11 at 1/2000 sec.

Film Speed	Shutter Speed											
	1	$\frac{1}{2}$	$\frac{1}{4}$	$\frac{1}{8}$	$\frac{1}{15}$	$\frac{1}{30}$	$\frac{1}{60}$	$\frac{1}{125}$	$\frac{1}{250}$	$\frac{1}{500}$	$\frac{1}{1000}$	$\frac{1}{2000}$
ASA 25	1	$\frac{1}{2}$	$\frac{1}{4}$	$\frac{1}{8}$	$\frac{1}{15}$	$\frac{1}{30}$	$\frac{1}{60}$	$\frac{1}{125}$	$\frac{1}{250}$	$\frac{1}{500}$	$\frac{1}{1000}$	$\frac{1}{2000}$
ASA 50	$\frac{1}{2}$	$\frac{1}{4}$	$\frac{1}{8}$	$\frac{1}{15}$	$\frac{1}{30}$	$\frac{1}{60}$	$\frac{1}{125}$	$\frac{1}{250}$	$\frac{1}{500}$	$\frac{1}{1000}$	$\frac{1}{2000}$...
ASA 100	$\frac{1}{4}$	$\frac{1}{8}$	$\frac{1}{15}$	$\frac{1}{30}$	$\frac{1}{60}$	$\frac{1}{125}$	$\frac{1}{250}$	$\frac{1}{500}$	$\frac{1}{1000}$	$\frac{1}{2000}$
ASA 200	$\frac{1}{8}$	$\frac{1}{15}$	$\frac{1}{30}$	$\frac{1}{60}$	$\frac{1}{125}$	$\frac{1}{250}$	$\frac{1}{500}$	$\frac{1}{1000}$	$\frac{1}{2000}$
ASA 400	$\frac{1}{15}$	$\frac{1}{30}$	$\frac{1}{60}$	$\frac{1}{125}$	$\frac{1}{250}$	$\frac{1}{500}$	$\frac{1}{1000}$	$\frac{1}{2000}$
ASA 800	$\frac{1}{30}$	$\frac{1}{60}$	$\frac{1}{125}$	$\frac{1}{250}$	$\frac{1}{500}$	$\frac{1}{1000}$	$\frac{1}{2000}$
ASA1600	$\frac{1}{60}$	$\frac{1}{125}$	$\frac{1}{250}$	$\frac{1}{500}$	$\frac{1}{1000}$	$\frac{1}{2000}$
Minimum f/stop	f/22	f/22	f/22	f/22	f/22	f/22	f/22	f/22	f/16	f/11	f/8	f/5.6

Viewing and Focusing

The exact picture image to be photographed can be seen on the focusing screen of the viewfinder without any parallax. This enables you to determine the exact composition of your scene before pressing the shutter release button. The center of the viewfinder (circular section) is a micro-prism screen rangefinder made up of microscopic prisms for fast and precise focusing.

While looking through the viewfinder revolve the focusing ring. It is in focus when the image in the rangefinder becomes sharp and clear

■ An optical curve may sometimes be visible in the lower part of the viewfinder according to the angle of the incoming light. This is a reflection of the beam-splitting mirror added onto the condenser lens in the TTL light measurement system.

Viewfinders

The Eye-Level Finder can be removed and interchanged with another viewfinder. To remove the Finder pull it towards the rear while pressing the two stopper buttons on both sides of the Finder.

When attaching a viewfinder slide it in from the rear side of the camera so that the attachment rails of the viewfinder are inserted on a level with the camera body. Push it all the way in and it will lock with a clicking sound.

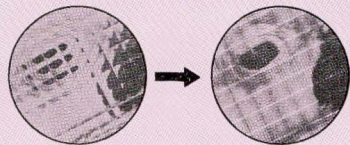
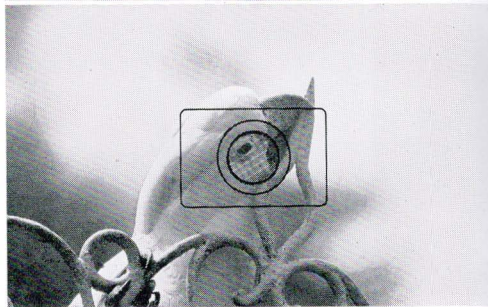

Out of Focus

In Focus

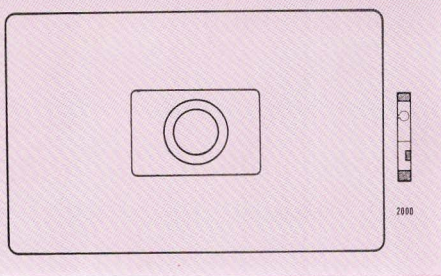

Interchangeable viewfinders that can be mounted include Booster T Finder Servo EE Finder Speed Finder and Waist-Level Finder (See page 52.)

Focusing Screens

The focusing screen inside the finder box can also be interchanged. The standard focusing screen has a prism screen rangefinder. There are three other types available. They are the split-image rangefinder type, the all-mat type, and the section type. (See page 53.)

1 The focusing screen can be lifted by inserting your fingernail into one of the two notches on the rear end of the focusing screen and pulling upwards. Remove the focusing screen from the finder box by picking up its metallic edges.

The screen can be inserted as follows.

2 Face the protruding part toward the front, insert it under the holder on the camera body side and then press down on the rear end of the focusing screen so that it drops into a horizontal position.

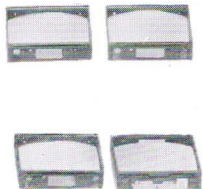
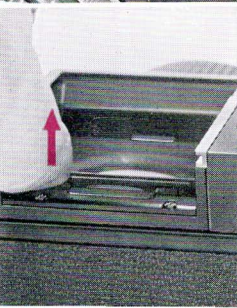
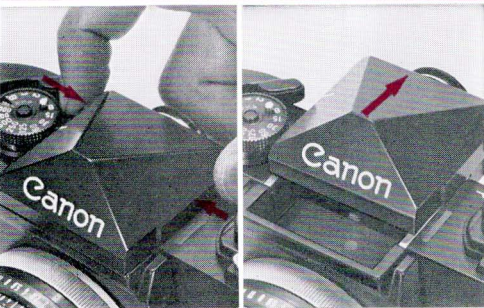

Dioptric Adjustment Lenses

The screw-in type dioptric adjustment lenses are interchangeable. A standard -1.2 dioptric adjustment ring is attached to the viewfinder while four other kinds of dioptric adjustment lenses for farsightedness and three others for nearsightedness are available as optional attachments. The diopters of these lenses are composite numbers of those when attached to the camera. A corresponding chart of the diopters is shown right.

- Dioptric adjustment lenses are also used when a magnifier is attached to the Eye-Level Finder
- Dioptric adjustment lenses should be removed when an Angle Finder B is attached.
- The Eyecup can be snapped on the dioptric adjustment ring.

Angle Finder B

Canon Angle Finder B can be attached to the eyepiece for copying, macrophotography and photomicrography work.

Magnifier

The optional Canon Magnifier can be attached to the viewfinder eyepiece of the F 1 which magnifies the rangefinder section for accurate focusing. Because it can be swung up and clamped, the entire field of view can easily be viewed after focusing.

Eyecup

The covering type eyecup can be attached to the ring section.

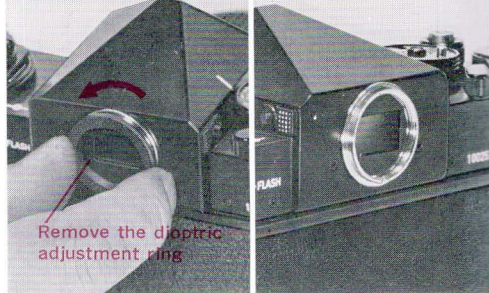

Dioptric Adjustment Lenses	R+3	R+2	R+1	R0	R-1*	R-2	R-3	R-4
Diopter in Inches	+3	+2	+1	0	-	-2	-3	-4

* Standard Ring

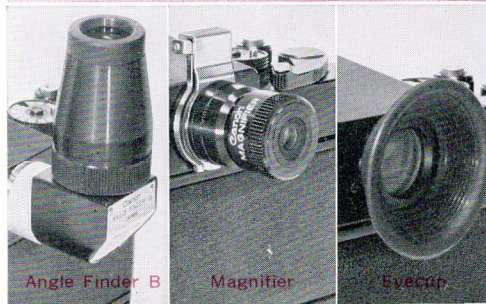

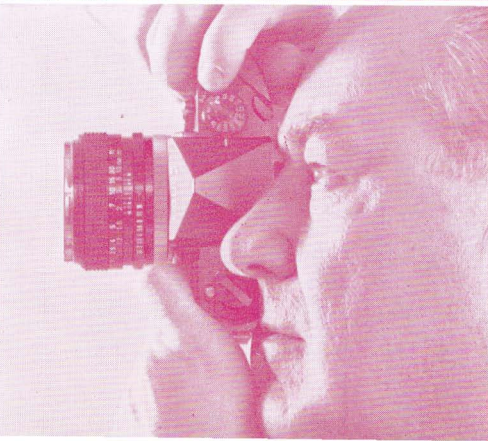

Holding the Camera

Hold the camera firmly to take a clear picture. Hold the camera either in a vertical or horizontal position, look through the viewfinder and focus. Then press the shutter release button gently. The following steps are important.

- 1** Hold the camera snugly in both hands. The camera should be pressed firmly to your cheek or forehead.
- 2** When the camera is in a horizontal position, both elbows should be firmly pressed against the body and at least one elbow should be resting against the body when the camera is in a vertical position.
- 3** Hold your breath and press the shutter release button with a smooth, steady stroke. Otherwise, you will have a blurred picture.
 - When using slow shutter speeds below 1/30 sec. you had better use a tripod and cable release.
 - When taking pictures against the light, always use a lens hood.
 - Camera Holder F for attaching a tripod and Canon Release are separately available.

Safety Stopper

Film Rewinding Crank

Film Inserting Slit

Take-up Spool

Film Advance Sprocket

Cartridge Compartment

Position in which film is placed in camera
(emulsified surface facing towards the lens)

← Leader part of the film →

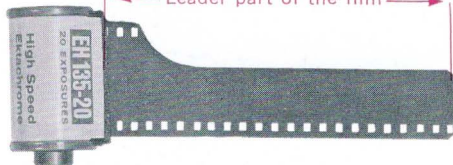

Film Loading

Canon F 1 accepts any standard 35mm film roll in daylight loading cartridge. Be sure not to load film in direct sunlight.

- 1** Pull out the film rewind crank while pressing the safety stopper. The cover will rise slightly.
- 2** Open the cover fully. Face the film cartridge as illustrated, and insert it into the cartridge compartment. Push the film rewind crank back into its former position. The crank fork will slip into the axis of the film cartridge. In case the crank does not fully return, turn it slightly to the left or right.

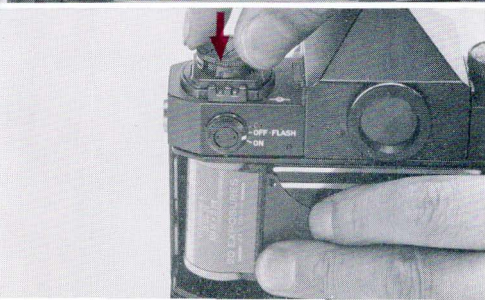
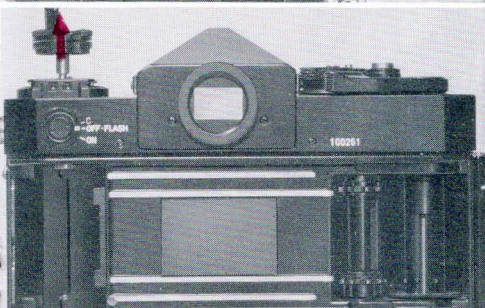
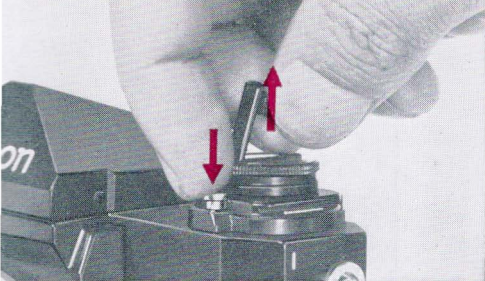

3 Pull the film out from the cartridge and insert the film tip into the slit of the film take-up spool for a length of approximately two perforations.

4 Turn the film advance lever and wind the film around the film take-up spool.

■ At this time, engage the sprockets of the film take-up spool and the teeth of the film advance sprocket with the film perforations.

5 Press down on the back cover and close it.

If the film is sagging, the cartridge will rise and the back cover will not close.

6 Leave the lens cap on and take two blank shots, each time turning the film advance lever and releasing the shutter

The frame counter will advance from the "S" mark to " " With one more advance, the camera will be ready for the first shot.

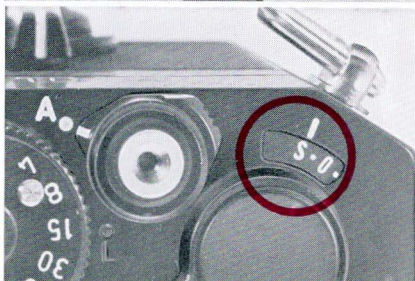
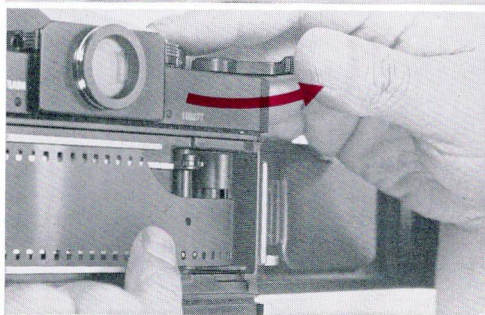
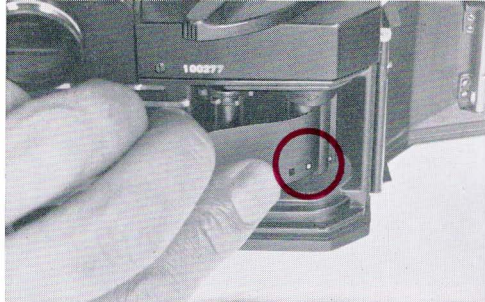

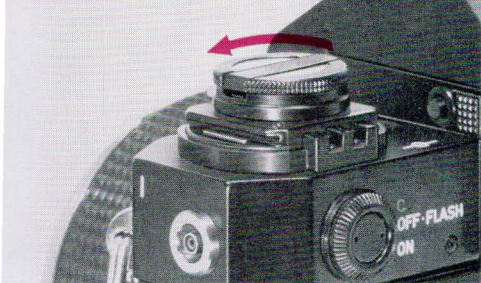

Checking Correct Film Loading

The film is properly loaded and advanced if the film rewind crank rotates when you wind the film advance lever. If the film rewind crank does not rotate, take out the film, as explained on the following page, and reload.

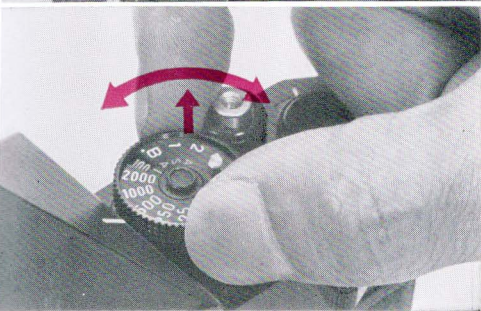

Setting the Film Speed

When loading the film, be sure to set the film speed scale at the proper position. Refer to page 21 for setting the film speed.

Repacking a Long-Wound Film

When repacking a long-wound film for darkroom loading into an ordinary cartridge, be sure to trim the tip of the leader between perforations.

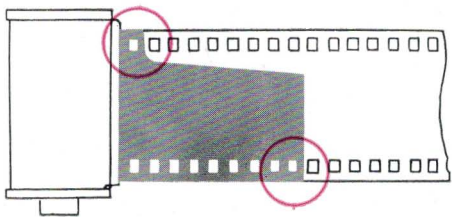

Film Rewinding

When the film reaches the end and the film advance lever stops, rewind the film into the cartridge as soon as possible. Be sure not to open the back cover before rewinding. Otherwise, the entire roll will be exposed and ruined as the exposed film is uncovered within the camera.

- 1 Press the film rewind button.
- 2 Raise the film rewind crank, turn it in the direction of the arrow and rewind the film into the cartridge. When the film rewind button stops revolving and rewinding resistance becomes light, stop rewinding immediately
- 3 Open the back cover
- 4 Pull up the rewind knob fully and remove the cartridge.
 - Once the film rewind button has been pressed, your finger may be removed from it. The button will pop out automatically when the film advance lever is wound.
 - If you force the film advance lever after the film reaches its end, the film will become detached from the cartridge spool or tear and rewinding will become impossible. If this happens, open the back cover and remove the film in a dark place.

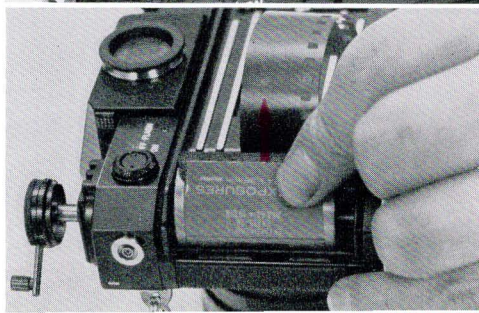

Synchronizing Flash Unit

Canon F 1 is designed so that two systems of flash photography can be used with it—the match needle type automatic flash photography using Canon Speedlite 133D, and ordinary synchronizing flash photography.

Type		Synchronized Shutter Speeds
Flash	FP class (#6, Press 26)	1/125 or faster 1/30 or slower
	M class (M3, #5, Press 25)	1/30 or slower
	MF class (AG-1, AG-3, M2, Flashcube)	1/30 or slower
Electronic Flash Unit	Speedlite	1/60 or slower

1 The Canon Auto Tuning (CAT) System is connected exclusively to the FD 50mm F 1.4, FD 50mm F 1.8 and FD 35mm F 2 lenses which have a flash adapter coupling pin. In connecting the flash unit, first attach the Speedlite 133D onto the accessory shoe with the Flash Coupler L. Attach the Flash-Auto Ring to the lens, and connect the cord of Flash-Auto Ring to the 133D.

When viewed from behind the camera, the contact for the CAT System is on the right side and the contact for flash unit is on the left side of the camera.

Canon Speedlite 133D



Canon Flash V-3



Contact for
Flash Unit

Contact for
CAT System

2 When using an ordinary flash unit, or a Speedlite other than the 133D, insert the Flash Coupler D into the accessory shoe. Then attach the flash unit onto this coupler and connect the cord to the flash socket of the camera.

■ Flash Coupler D has a direct-coupled contact, like Canolite D, to which a direct-coupled type flash unit can be attached.

Deciding the Exposure

In the case of the Canon Auto Tuning System, the power level of the Speedlite 133D is continuously transmitted to the meter circuit of the camera. Thus, the correct exposure can be decided as follows. First set the dial at meter switch to "OFF FLASH" and the shutter speed 60". Set the distance so that the meter needle in the meter reading window moves. Then turn the preset aperture ring until the aperture needle aligns with the meter needle.

In all other cases, exposure is decided by dividing the guide number of the flash unit by the focusing distance and obtaining the proper f/stop. The X contact of Canon F 1 is 1/60 sec.

■ A lens hood should be attached when taking pictures with a flash unit.

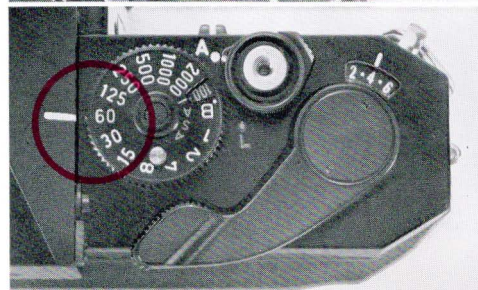
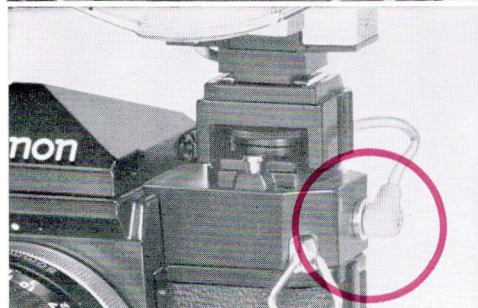
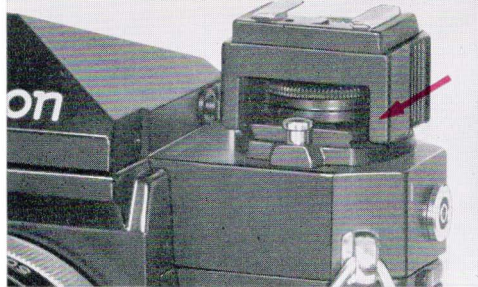



Uses of Lenses

Changing Lenses

1 Be sure to unlock the stopped-down functioning lever lock. If the lever is pressed or is locked, a red dot appears inside the camera mount. The automatic/manual aperture lever at the back end of the lens, cannot be connected to the coupling on the camera body and the preset aperture will not function.

- To remove the dust cap of the lens, turn the bayonet ring fully to the left. In this case, mount the lens onto the camera body as is.

2 Remove the lens from the camera body by turning the bayonet ring of the lens to the left until the red dot on the lens coincides with the red dot on the camera mount.

3 Set the preset aperture ring of the lens to be used within the f/stop indexes. If the ring is set at the green mark (circle) for EE photography, the lens cannot be properly mounted on the bodies other than the F-1 body.

4 Mount the lens by matching the red dot of the lens to the red dot on the camera mount. Turn the bayonet ring to the right and fasten. Before mounting, turn the bayonet ring of the lens sufficiently to the left and align the red dot and guide pin of the lens.

- Attach the lens quickly in the shade. The film will sometimes become foggy if the lens is left unattached.

- Whenever a lens is removed, be sure to put on the dust cap to protect the various signal levers and pins.

- When the camera is not in use for a long time, protect the mirror with a flange cap.

Lens Signal Couplings

Aperture Signal Lever: Transmits the preset f/stop of the automatic aperture to the camera body. It is on a one-to-one movement basis with the preset aperture through lever manipulation. When the preset aperture ring is set at the green mark for EE photography the aperture signal lever is disconnected from the aperture ring. The aperture opening can be set automatically using the Servo EE Finder. The aperture signal lever has a safety device so that the lever is set at the starting position when the bayonet mount ring is turned to the attachment position.

Full Aperture Signal Pin: Transmits the full aperture stop when a lens with a different full aperture number is mounted. It also compensates the meter deviation of the aperture metering.

Automatic/Manual Aperture Lever: Stops down the aperture to the preset position. Clamp it to the right full side for manually operated aperture.

EE Switch Pin: When the preset aperture ring is set at the green mark for EE photography the lens can be attached only to the F 1 camera. If the lens is attached to the cameras other than the F 1 it cannot be set at the green mark.

Pin: Reserved.

■ When the lens being taken off the signal levers and signal pin will not move even if the aperture signal lever is moved.

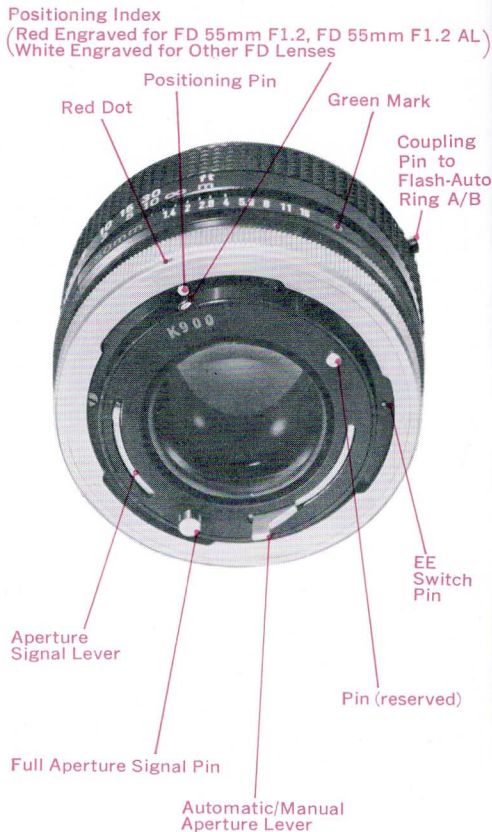

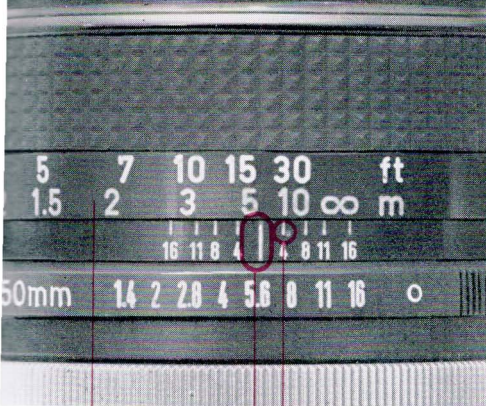

Distance Scale

Infrared Index

Index (orange line)

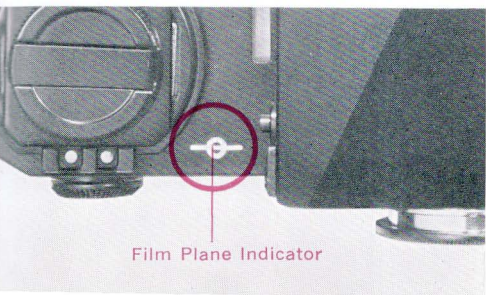

Film Plane Indicator

Distance Scale

The distance scale indicates the distance between the focused subject and the film plane. The scale is necessary for checking the depth-of-field, for flash and for infrared photography

- The correct position of the scale is in the center of each value. The correct position of a two-digit value is the center of the two figures.

Infrared Index “ ”

For infrared photography correction of the distance scale is necessary because the focal point deviates slightly from ordinary photography. Focus first in the ordinary manner then adjust that distance scale to the infrared mark “ ” in red. For instance, if the distance scale reads 10m after focusing, merely shift the 10 scale to “ ” position. The position of “ ” on the F 1 is based on using film with a highest wave-length sensitivity figure of 800m μ , such as Kodak IR 135 film and Wratten 87 filter

Film Plane Indicator

In case the focusing is done by actual measurement, measure the distance from the film plane indicator and set the measured distance on the distance scale.

Depth-of-Field Scale

The depth-of-field scale indicates the range of subjects which will be in focus sharply on the film. This range will vary with the following factors. The depth-of-field will be deeper the smaller the f/stop , the further the distance of the subject, and the shorter the lens focal length. The depth-of-field will be shallower the larger the f/stop , the nearer the distance of the subject, and the longer the lens focal length. For example, if the lens used is 50mm and the subject has been focused at a distance of 3m (10') with an $f/8$ value, read off from both indexes on either side of the indicator (orange line). The depth-of-field is from approximately 2.3m (8') to 4.3m (14').

If the aperture is closed down to $f/16$, the picture will become sharp between 1.9m (6') to 7.6m (25') from the camera. This range will vary with the f/stop selected.

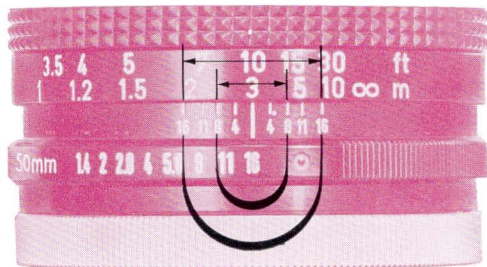

50mm Lens $f/8$

Depth-of-field 2.3-4.3m (8'-14')
Focused at 3m (10')



50mm Lens $f/16$

Depth-of-field 1.9m-7.6m (6'-25')
Focused at 3m (10')



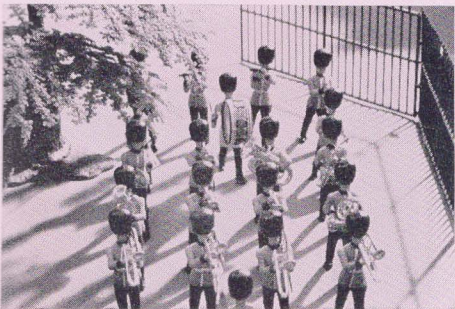
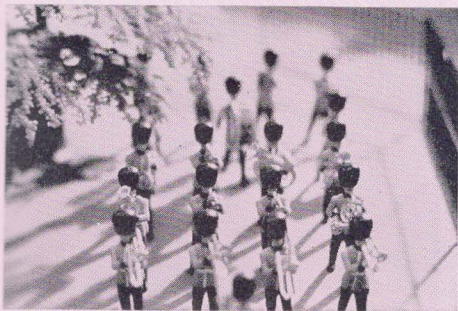

- In the case of Canon FD lenses, you can see the actual sharpness through the viewfinder by pressing the stopped-down functioning lever
- Although air bubbles may sometimes be seen in a lens, they do not affect the resolving power or the sharpness of the picture.

FD Lens Mount (FL and R Series Lenses)

All Canon FD and FL lenses which have the FD and FL mounts can be used with the Canon F 1 except the FLP 38 mm F 2.8.

- It is also possible to attach and use all the R lenses for Canonflex use. However as the preset aperture mechanism differs, pictures must be taken by controlling the aperture manually.

Fixing Mirror Upwards

In performing super-wide or photomicrography the Canon F 1 can be operated with the mirror locked in the up-position after the picture has been composed in the viewfinder in order to eliminate mirror vibration.

To lock the mirror in the up-position, push down the stopped-down functioning lever lock to "M". The aperture is now stopped-down and controlled manually.

The mirror can be locked independently from film advance and shutter speed operations.

When the mirror is locked in the up-position, SLR viewing is not possible, distance must be estimated by eye, and the 1/2000 second shutter speed cannot be used.

When the mirror is locked always keep the lens covered. The film will sometimes become foggy if the lens cap is left unattached.

■ After the mirror lock device has been used, be sure to return the mirror lock lever to its original position. Failure to do this will result in inexact focusing.

■ When Canon Lens FL 19 mm F 3.5 (former type) is used, the mirror should be fixed, and use of the exclusive viewfinder for this lens becomes necessary.

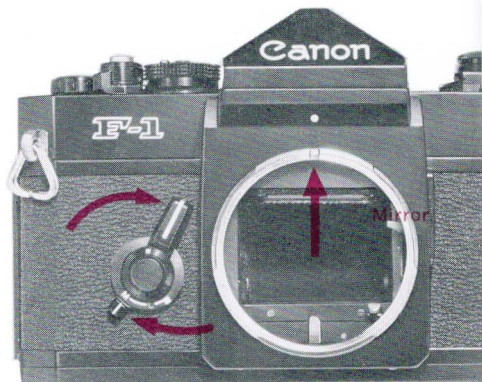



Lens Cap

When taking off the lens cap, push in the lock on the both sides of the lens. When attaching the lens cap, do the same. The lens cap can also be attached on the filters which have inner threads



Lens Hood

When attaching the lens hood on the lens, align it with the bayonet ring on the lens and turn it clockwise. With some exceptions of standard and wide angle lenses, a lens hood can be stored in the camera case. When do this, put the lens hood on the lens in the inverted and align it to the bayonet ring and turn in the counterclockwise direction.



Using Self-Timer

- 1 Wind the film advance lever
- 2 Turn the self-timer lever in the direction of the bold arrow (counterclockwise) line until it stops.
- 3 Depress the shutter release button. The shutter will be actuated approximately 10 seconds later
 - Be sure to wind the film advance lever. Otherwise, the self-timer will act but the shutter will not be actuated.
 - The stopped-down functioning lever can be used in a normal manner even after the self-timer is cocked.
 - The self-timer lever can be used as the stopped-down functioning lever as soon as it is returned to its original position.
 - If the self-timer lever is set while the mirror is in an up position, the mirror-up position is released. Therefore, always set the mirror in an upward position after setting the self-timer.



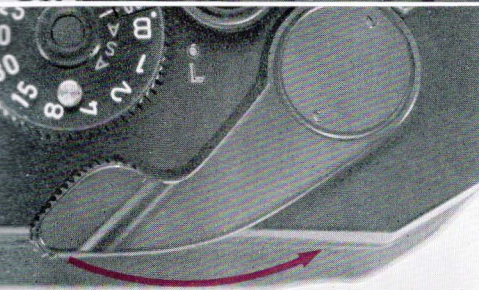
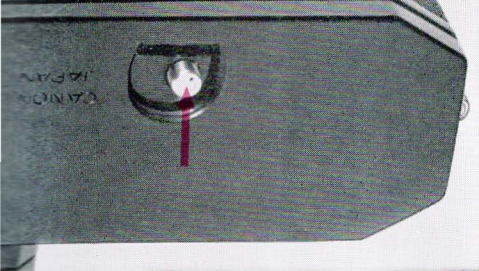

Double Exposures

Although the Canon F 1 is designed to prevent double exposures made by mistake, a double exposure can be made by the following steps

- 1 When the first exposure has been made, press in the film rewind button.
- 2 Rewind the film with the film rewind crank by watching the green mark on the film rewind button carefully.
- 3 Stop rewinding when the green mark has made a $1/2$ turn, i.e. 180°
- 4 Next, wind the film advance lever while lightly holding the rewinding crank. When resistance is felt on the film rewind crank, stop winding.
- 5 Wind the film advance lever once more. The camera is ready for another exposure.
 - By repeating the above process, any number of exposures on the same frame can be made. The frame counter will, however continue to advance with each exposure.

- Note:** a) When rewinding, be careful not to turn the film rewind button more than $1/2$ revolution.
- b) In the above mentioned No. 3, in the case of a camera with a red mark on the film rewind button, stop rewinding when the mark has made a $7/8$ turn.

Interchangeable Lenses FD/FL

Canon F 1 is a highly versatile system camera with a wide range of interchangeable lenses from 7.5mm to 1200mm. These, together with the 180 available accessories, including Motor Drive Unit, Servo EE Finder Booster T Finder and Film Chamber 250, make possible all kinds of photography. Select the interchangeable lens and accessories that meet your need.

Canon Interchangeable Lenses

FISHEYE 7.5mm F 5.6	FD 135mm F 2.5
FD 17mm F 4	FD 200mm F 4
FD 24mm F 2.8	FD 300mm F 5.6
FD 28mm F 3.5	FL 55-135mm F 3.5
FD 35mm F 3.5	FD 100-200mm F 5.6
TS 35mm F 2.8 (Tilt & Shift)	FL 85-300mm F 5
FD 35mm F 2	FL 400mm F 5.6
FL 50mm F 3.5 (Macro)	FL 600mm F 5.6
FD 50mm F 1.8	FL 800mm F 8
FD 50mm F 1.4	FL 1200mm F 11
FD 55mm F 1.2	FLM 100mm F 4
FD 55mm F 1.2AL	(for Bellows)
FD 100mm F 2.8	FLF 300mm F 5.6
FD 135mm F 3.5	FLF 500mm F 5.6

Note: Some lenses are not available but will be marketed soon.

All Canon FL and R Lenses can be used with the F 1 except the FLP 38 mm F 2.8.



Canon

FD

INTERCHANGEABLE LENSES



Bottom Cover and Back Cover

The bottom cover can be removed for use of the Motor Drive Unit. When removing it, take off the battery compartment, and pull it all the way

The back cover can be removed for attaching the Film Chamber 250. When removing it, push down the pin of the hinge.

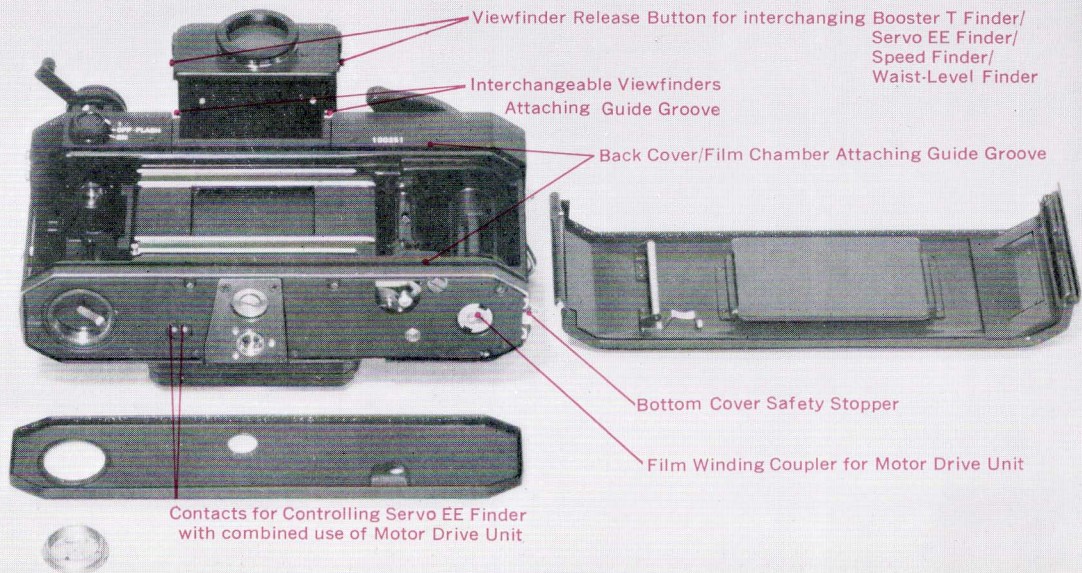
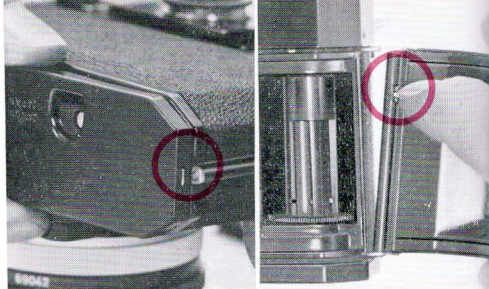

Canon

F-1

ACCESSORIES

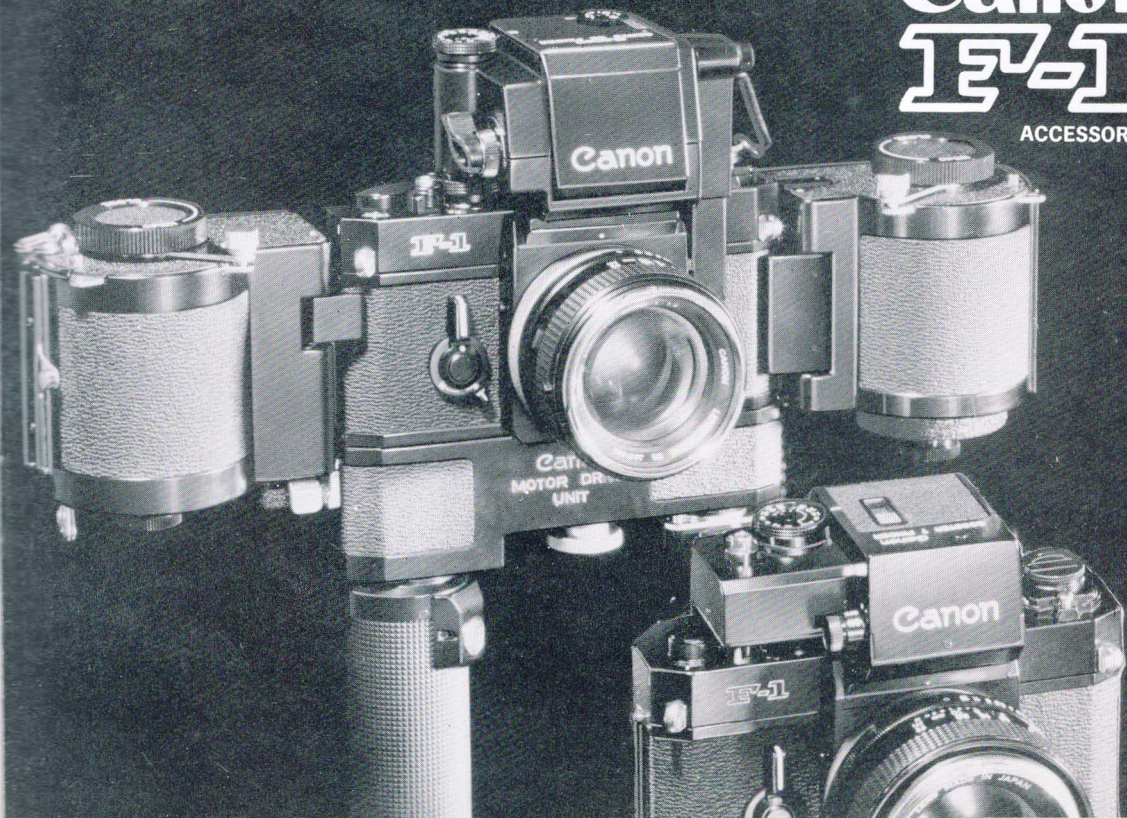

Motor Drive System and Power System

Motor Drive Unit ①

The Motor Drive Unit is a precision made powered film advance apparatus which can be possible not only a wide range of photography with the timer but also short interval photography of three exposures per second and continuous photography of 36 exposures, or 250 exposures with the Film Chamber 250. The timer can also be set at seven intervals up to 60 seconds. It also enables unmanned EE photography when jointly used with the Servo EE Finder. Can be easily attached to the base of the camera.

Film Chamber 250 ②

The Film Chamber 250 is an exclusive long-length roll film magazine designed to a maximum capacity of 250 exposures. Also made to guarantee single-frame exposures. With the combined use of the Motor Drive Unit, it is effective for shooting sports events and copying documentary pictures.

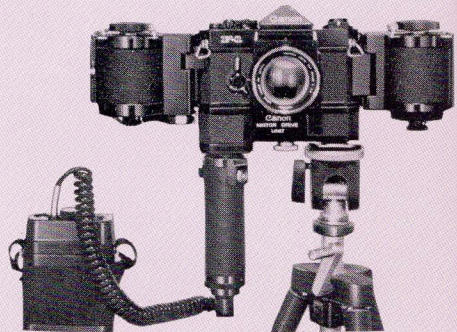
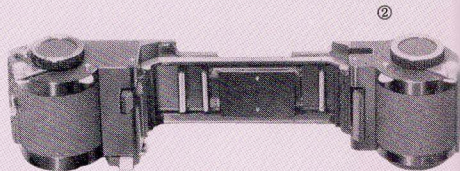
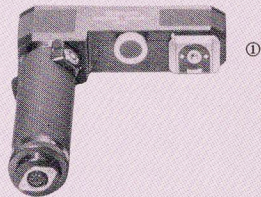

Battery Case ③

The Battery Case for an external power source is used for power drive accessories; Motor Drive Unit, Servo EE Finder, Booster T Finder and Speedlite 133D, an exclusive electronic flash unit. According to the multiple purpose, this Battery Case can use the Battery Magazine 15V containing 10 penlight batteries, Battery Magazine 12V containing 8 penlight batteries, or 12V NiCd Battery 500 FZ.

Battery Connector MD ④

The Battery Connector MD is used for connecting the Motor Drive Unit to the Battery Case. Without this connector the Motor Drive Unit cannot be used.

Battery Checker MD ⑤

The Battery Checker MD is used for checking power level of battery. Connected to the cord of Battery Connector MD.

Cord 12V 2E ⑥

The Cord 12V 2E is used for connecting the Servo EE Finder to the Battery Case or to the Battery Connector MD.

Cord 6V 2B ⑦

This cord is used for connecting the Booster T Finder to the Battery Case.

Remote Switch MD ⑧

The Remote Switch MD with 5 meter (16 feet) length cord is usable for photographing with the Motor Drive Unit. It is connected to the Battery Connector MD. Single frame, and continuous photography are possible.

Film Loader 250 ⑨

The Film Loader 250 is a wind-up device to load strip film into the Film Magazine 250 for the Film Chamber 250.

Film Magazine 250 ⑩

The Film Magazine 250 is for the Film Chamber 250. A maximum of 250 exposures of film can be contained.

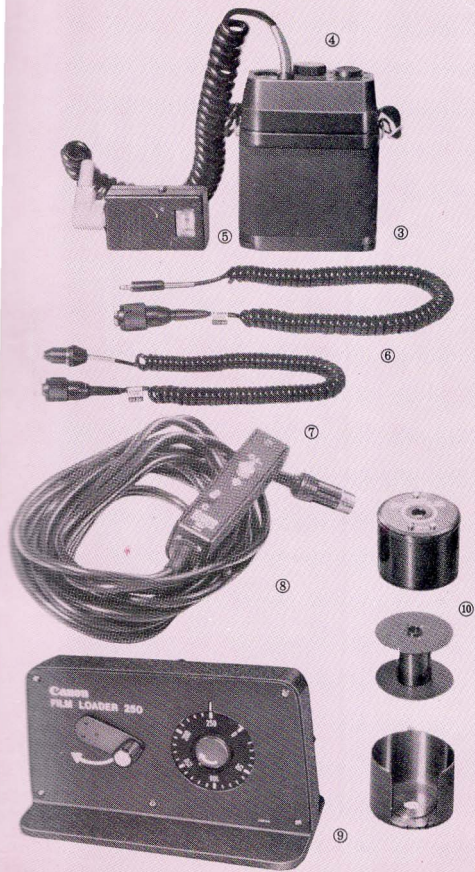

Viewfinder System

Servo EE Finder ①

The Servo EE Finder is an EE functioning interchangeable viewfinder which is coupling to the full aperture metering mechanism of the FD lenses. It presets the proper f/stop automatically with shutter speed priority.

Booster T Finder ②

The Booster T Finder is used for reading precise exposure with its built-in electronic timer down to 60 sec. under extreme dim light condition. Metering range is from EV 10 (f/22 at 1/2 sec.) to EV-3.5 (f/1.2 at 15 sec.) with ASA 100 film.

Speed Finder ③

The Speed Finder is used for all kinds of photography, from over head shots to copy work. This viewfinder can be changed into an Eye-Level Finder or Waist-Level Finder by simply turning the rear section of the optical system.

The eye point of the Speed Finder is located 60mm in back of the eyepiece.

Waist-Level Finder ④

The Waist-Level Finder is an interchangeable viewfinder with built-in 5x magnifier glass. This viewfinder is very effective for low position photography and for focusing in copy work.

Angle Finder B ⑤

The Angle Finder B is a viewfinder attachment so that the left and right, and the top and bottom of the image can be seen as it actually is, and the entire field-of-view can be observed. It is very convenient for copy work, close-up photography and shooting a subject from low angle.



⑥



⑦



⑨



⑧

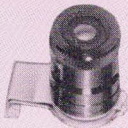

⑨



Focusing Screens ⑥

Four types of focusing screens are available: Focusing Screen A (micropism type), B (split-image type), C (all-mat type) and D (section-mat type). Usually F-1 is supplied with Focusing Screen A.

Dioptric Adjustment Lenses ⑦

Three kinds of interchangeable dioptric adjustment lenses for near-sightedness and four kinds for far-sightedness are available: R-2, R-3 and R-4 for near-sightedness RO, R+1, R+2 and R+3 for far-sightedness.

The F-1 comes with standard R-1.

Magnifier ⑧

The Magnifier is used for magnifying the focusing screen so that accurate focus can be obtained. It can be attached to the eyepiece of the Eye-Level Finder, Booster T Finder or Servo EE Finder

Magnifier Adapters ⑨

There are two magnifier adapters; one is for the Eye-Level Finder and the other is a clip-on type magnifier adapter for the Servo EE Finder and Booster T Finder

Eyecup F-1 ⑩

The Eyecup F-1 is an eyepiece hood for light shield. This is attached over the eyepiece ring.

⑩



Flash Photography System

Speedlite 133D ①

The Speedlite 133D is a cordless electronic flash unit for the matching-needle type automatic exposure control in flash photography with the F-1.

Flash-Auto Ring A and B ②

The Flash Auto Ring A is attached when the Canon Lens FD 50mm F 1.8 or FD 35mm F2 is mounted. The Flash-Auto Ring B is used for the FD 50mm F 1.4, or FD 35mm F2. They are the matching-needle type automatic flash photography accessories which are attached in front of the lens and transmit the rotating angle of the lens as a distance signal to the meter circuit of the F-1.

Flash Coupler D and L ③

The Flash Coupler D is used for the ordinary or direct contact flash unit. When the ordinary flash unit is mounted onto this coupler its cord should be connected to the flash socket of the camera.

The Flash Coupler L which has a direct-coupled contact for automatic flash photography is an accessory shoe specially for attaching the Speedlite 133D to the F-1.

Other Flash Units ④

The Speedlite 102, Flash V-3 or Flash J-3 can be attached to the F-1. In this synchronized flash photography, it is necessary to set the proper f /stop by calculation.



Close-up, Macrophotography and Photomicrography

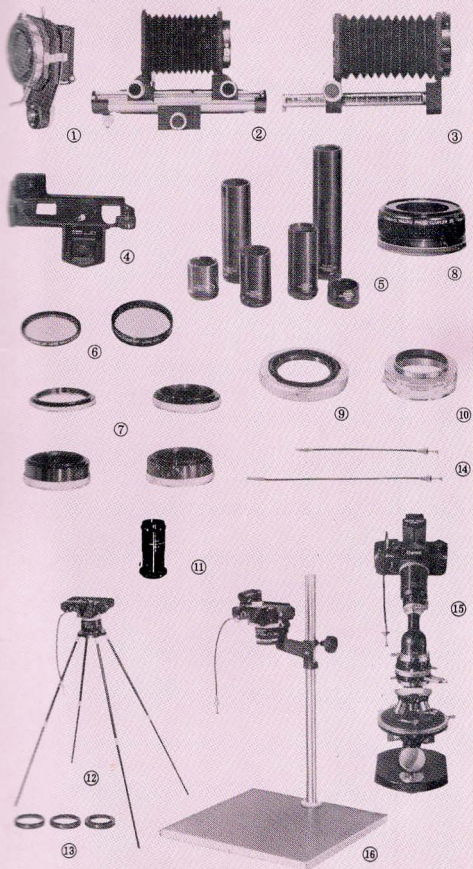

Slide Duplicator ①

The Slide Duplicator is used for duplicating color slides or black-and-white slides. It is attached to the tip of the Bellows FL.

Bellows FL ②

The Bellows FL is used for the extreme close-up photography. It has a shooting distance precision adjustment mechanism and a mechanism coupled to the automatic diaphragm of the FD and FL lens.

Bellows M ③

The Bellows M is a handy bellows for macrophotography. This is used to attach a Macro Canon Lens FL 50mm F 3.5 or a Canon Bellows Lens FLM 100mm F4 to the F-1.

Camera Holder F ④

The Camera Holder F is used in combination with a tripod or a Copy Stand 4 for macrophotography and copy work.

Extension Tubes from 6mm to 200mm ⑤

Close-Up Lenses ⑥

Extension Tubes M5, M10, M20 ⑦

Macrophoto Coupler FL55, FL58 ⑧

Lens Mount Converter A ⑨

Lens Mount Converter B ⑩

Microphoto Hood ⑪

Handy Stand F ⑫

F Rings 55mm, 58mm ⑬

Canon Releases 30, 50 ⑭

Photomicro Unit F ⑮

Copy Stand 4 ⑯

Filters

Type	Effectiveness of Filters
○● UV	Absorbs only ultra-violet rays. Especially effective at seaside, and in high mountains. Recommended for use in color photography.
○ Y1 Y3	Increases contrast of black and white film. Enhances clouds, darkens the blue sky. Brightens red and yellow.
○ O1	Darkens blue, increases yellow and red perceptibly. Good for contrasts especially in distant landscapes.
○ R1	Makes strong contrasts. May also be used with infrared film.
○ G1	Prevents red from turning radically into white. Lightens sky and face appropriately, and reflects the lightness of fresh greenery.
○● ND 4 ND 8	ND 4 reduces light values by 1/4, ND 8 by 1/8. No effect on the reproduction of colors.
● SKYLIGHT	Acts to harmonize the blue sky and shade.
● CCA 4	For use with daylight type film under the cloudy conditions.
● CCA 8	For use with universal type (color negative) film under the cloudy conditions or tungsten type film under the morning sun or sunset.
● CCA (12)	For use with tungsten type film in sunlight.
● CCB 4	For use with daylight type film under the morning sun or sunset.
● CCB 8	For use with daylight type film and clear flash bulb.
● CCB (12)	For use with daylight type film under tungsten light.

○ For black-and-white film. ● For color film.



Various types of filters, for different lens thread diameters, are available for special effects in both color and black-and-white photographs. The through-the-lens exposure measurements system of Canon F1 does not require exposure factor compensation for filter

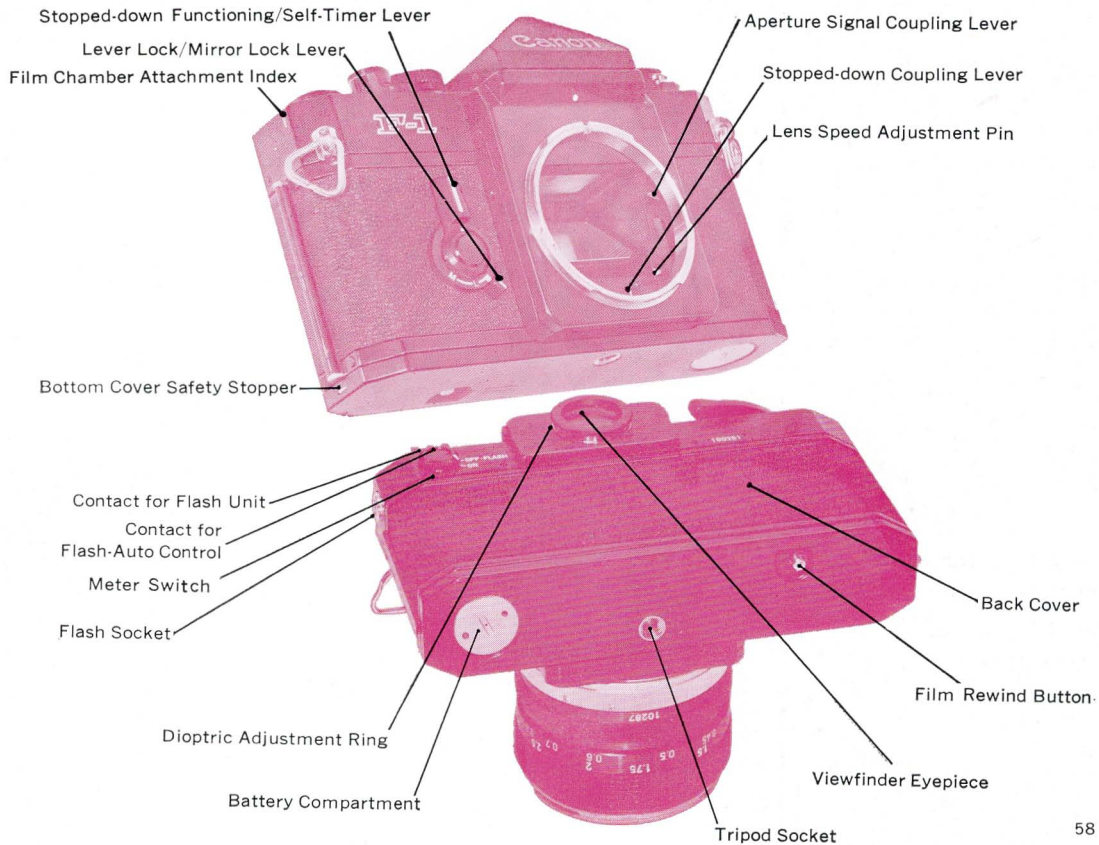

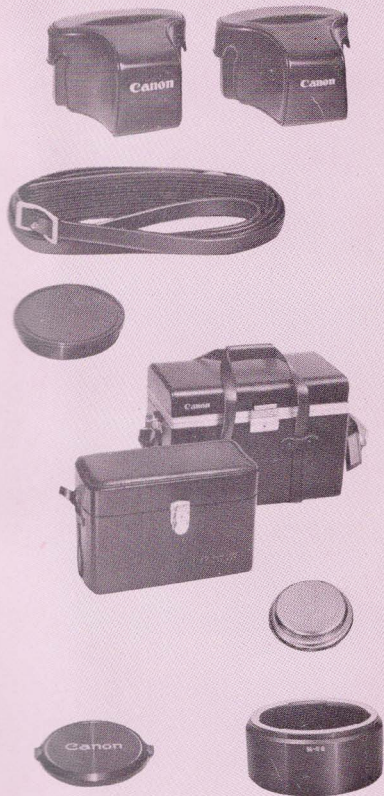

Other Accessories

Case S for FD 50mm F1.8, FD 50mm F1.4

Case L for FD 55mm F1.2

Finder Dust Cover

Lens Hood BW-55A

Lens Hood BW-55B

Lens Hood BS-55

Lens Hood BS-58

Lens Hood BT-55

Lens Cap C 55

Lens Cap C 58

Lens Dust Cover

55mm Close-up Lens 240, 450

58mm Close-up Lens 240, 450

Neck Strap 5 w/pad

Gadget Bag 4

Gadget Bag G-1

M 20 (#625) Mercury Battery

Camera Body Number _____

Lens Number _____

Date of Purchase _____

Dealer's Name _____

Proper Care of the Camera

Moisture and dust are harmful to your camera. If your camera is to be stored for a long time, it should be removed from its case, and silica gel or another drying agent should be placed alongside it.

When you use your camera on a rainy day, or at the beach, moisture and salt air adhere to it, which can result in stains, rust, and corrosion. Use a soft brush to get rid of dust and a soft dry cloth for wiping.

- In extremely cold areas, expose the camera to the outer air only when in use. When using, expose the camera gradually to the outer air to prevent the lens from clouding.

- Do not keep the camera in a hot place such as a car globe compartment or the rear window shelf. It will cause a trouble with the camera.

- Do not expose the camera leaving it without the lens cap directly to the sun. It will cause a fog on the film and a pin-hole on the shutter curtain when fixing the mirror upwards.

Cleaning the Lens

Use a blower to remove dust on the lens or brush lightly with a brush. If you should inadvertently get a fingerprint on the lens, use a little pure alcohol or ether on lens cleaning tissue, then wrap the tissue around a matchstick and wipe the lens lightly with a circular motion.

Canon

CANON INC.

9-9, Ginza 5-chome, Chuo-ku, Tokyo 104, Japan

CANON U.S.A., INC.

64-10 Queens Blvd., Woodside, Queens, New York 11377 U.S.A.

CANON U.S.A., INC., CHICAGO OFFICE

457 Fullerton Avenue, Elmhurst, Illinois 60126, U.S.A.

CANON OPTICS & BUSINESS MACHINES CO., INC.

3113 Wilshire Blvd., Los Angeles, California 90005, U.S.A.

CANON AMSTERDAM N.V.

Gebouw 70, Schiphol Oost, Holland

CANON LATIN AMERICA, INC.

Apartado 7022, Panama 5, Panama

