

Canon AE-1

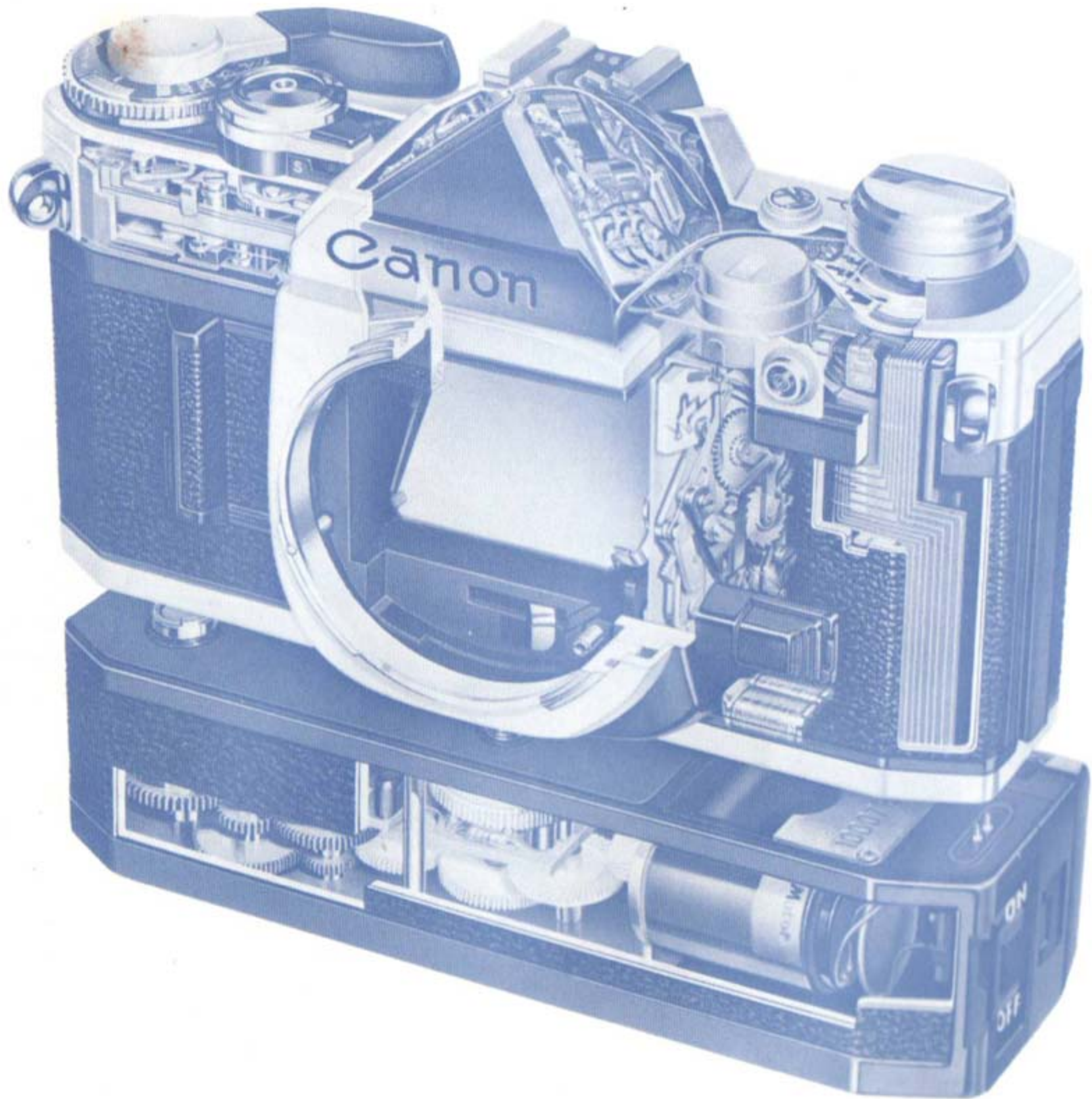

E

English Edition
INSTRUCTIONS



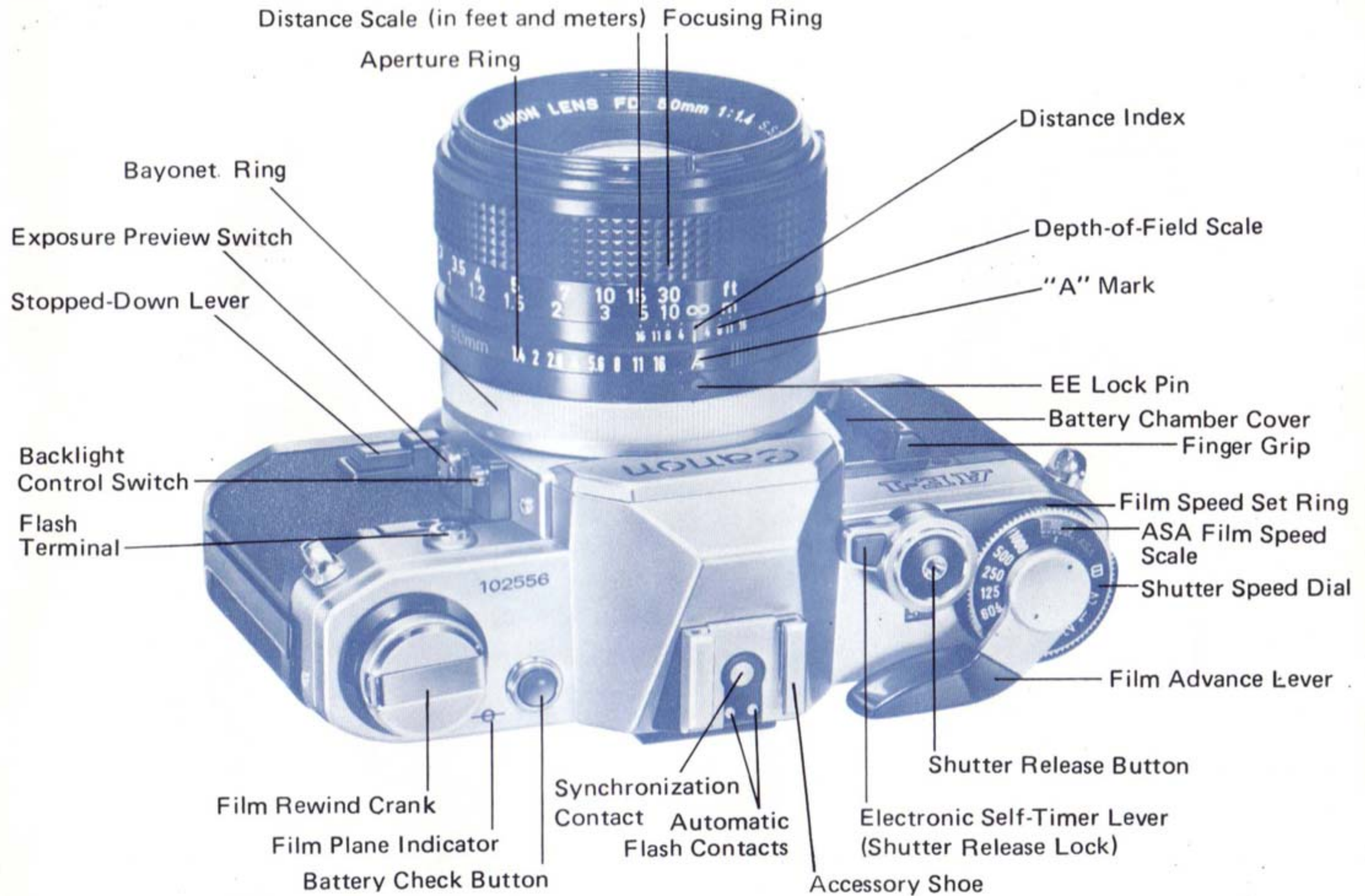

While reading the instruction booklet, unfold this flap and the flap on the back cover to facilitate your understanding of the instructions.

PICTORIAL OUTLINE FOR USING THE CAMERA

- 1 Set the aperture ring of the lens to the "A" mark.



- 2 Load the battery.



- 4 Set the ASA film speed.
Select a shutter speed.

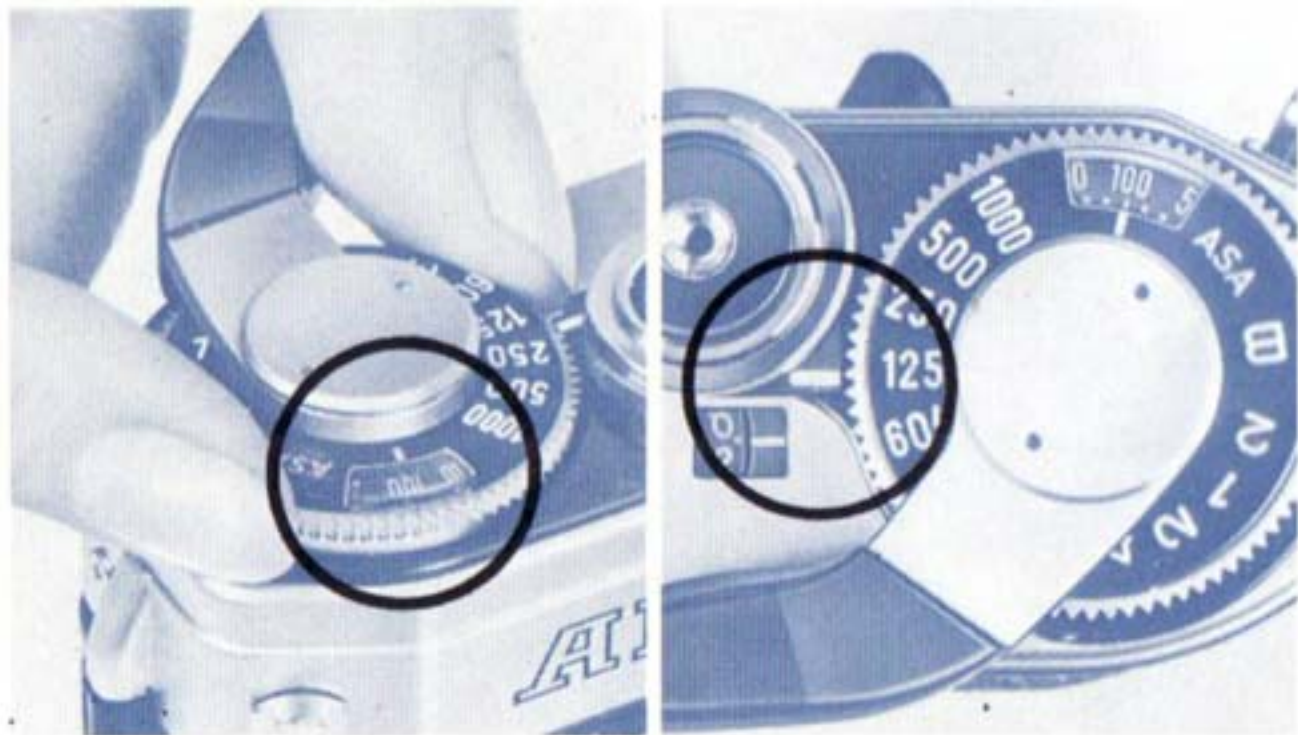

- 5 Look into the viewfinder.
Compose the picture and focus.

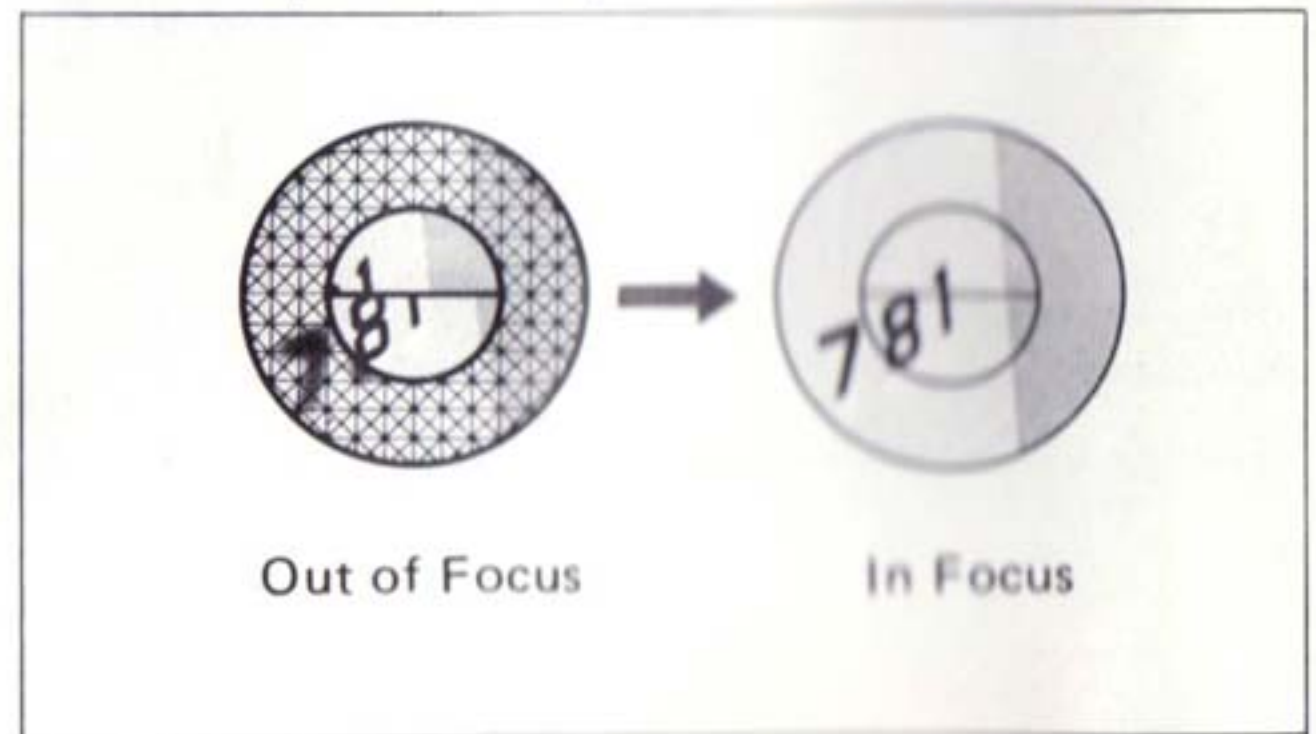

3 Load the film.

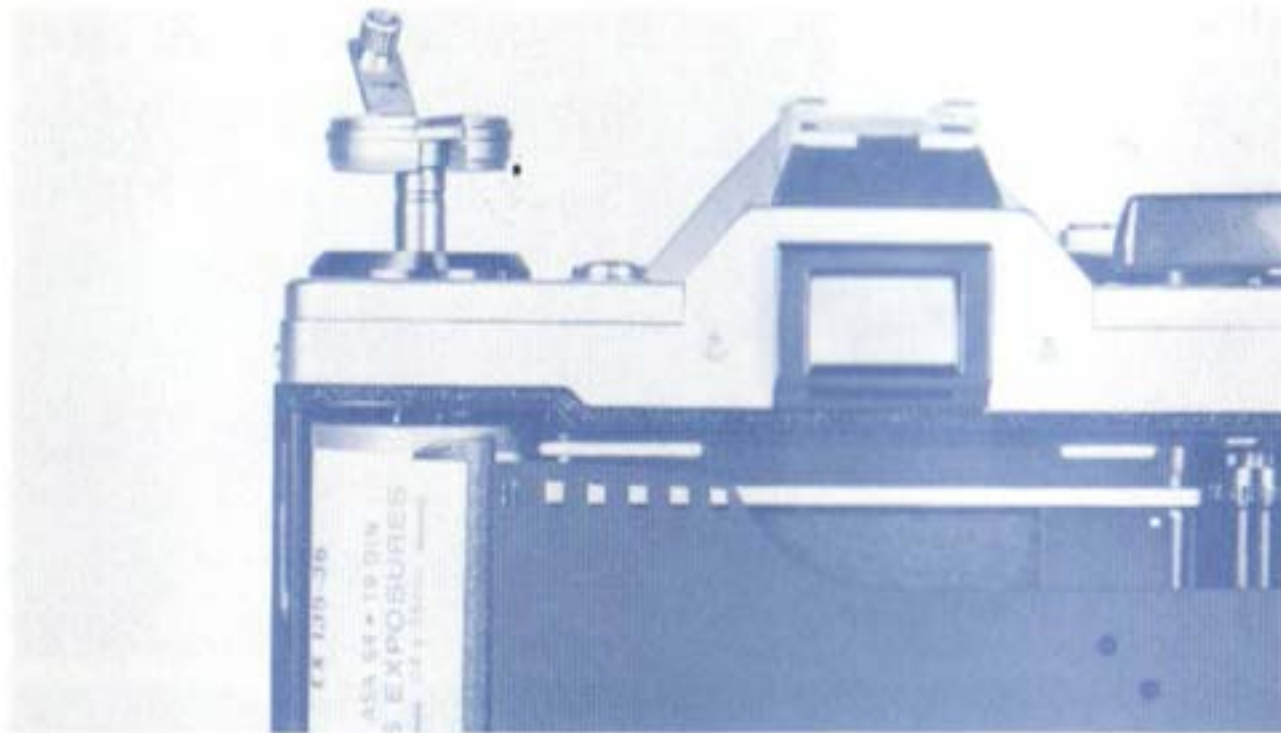

6 Advance film; Check exposure. Press the shutter button.

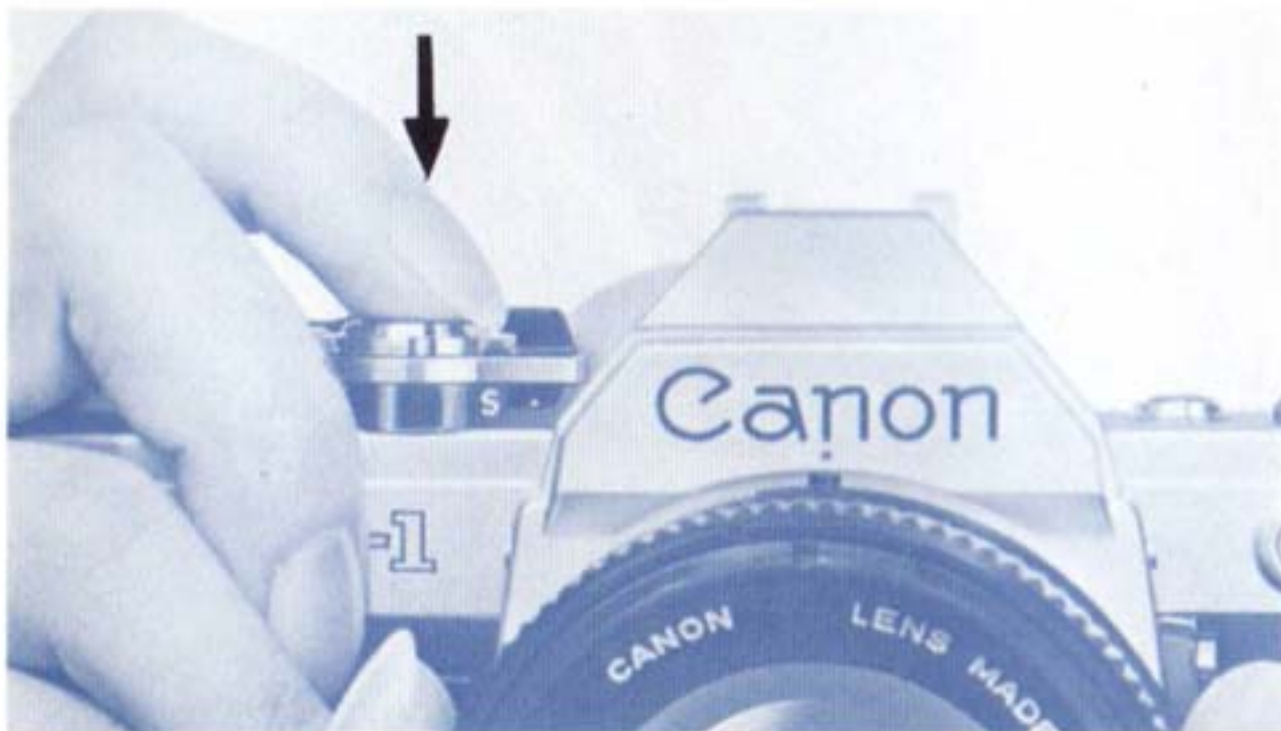

Photography with the Canon Speedlite 155A

1. Load the batteries.
2. Set the ASA film speed.
3. Mount the Speedlite 155A on the AE-1.
4. Turn the main switch on.
5. Set the AUTO/MANU. switch.
6. Focus and press the shutter button.

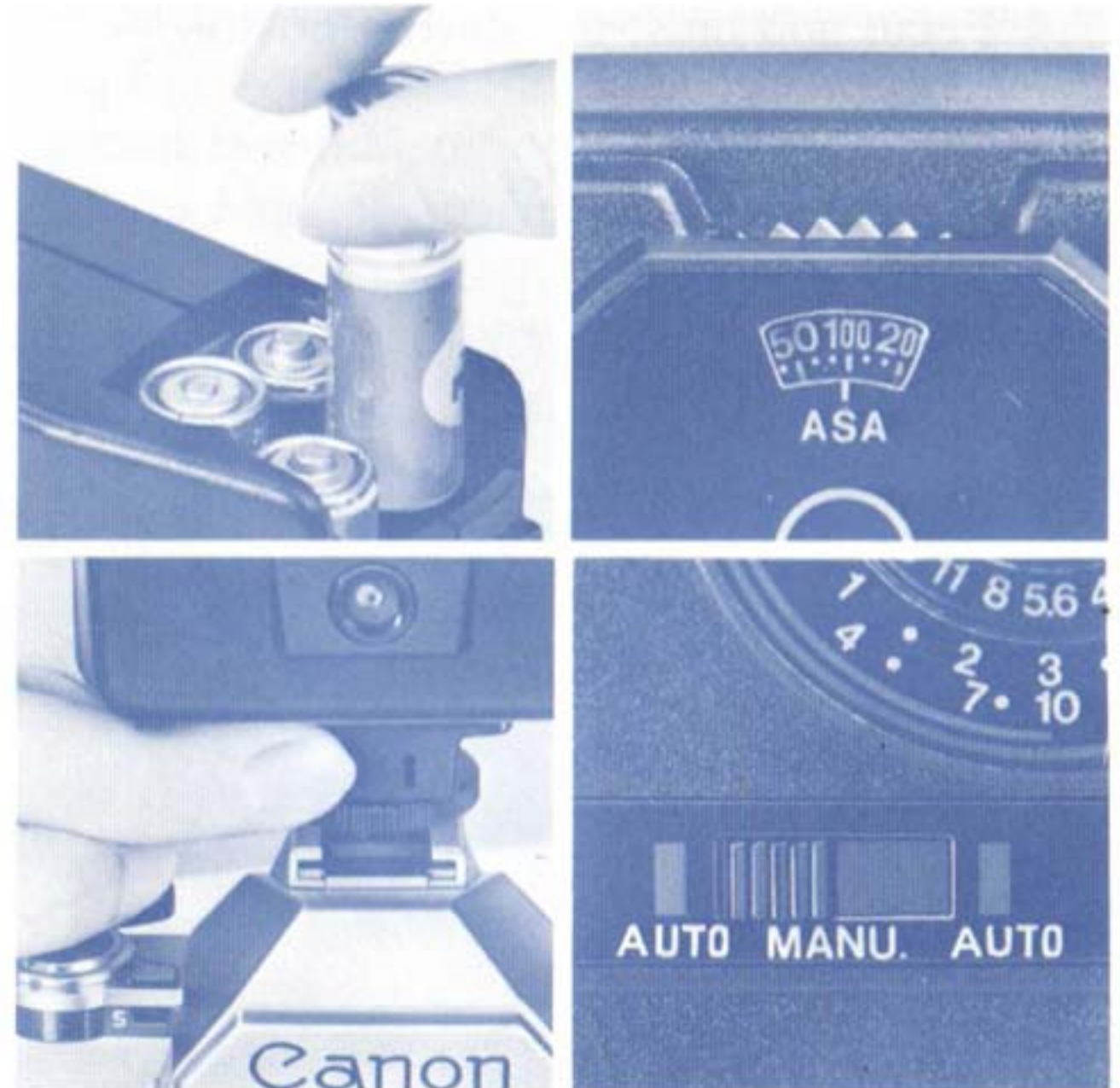

Photography with the Canon Power Winder A

1. Remove the Battery Pack A.
2. Load the batteries into the Battery Pack A.
3. Attach the Battery Pack A to the Power Winder A.
4. Take off the winder coupler cover.
5. Attach the Power Winder A to the AE-1.
6. Turn the main switch on.
7. Focus and press the shutter button.

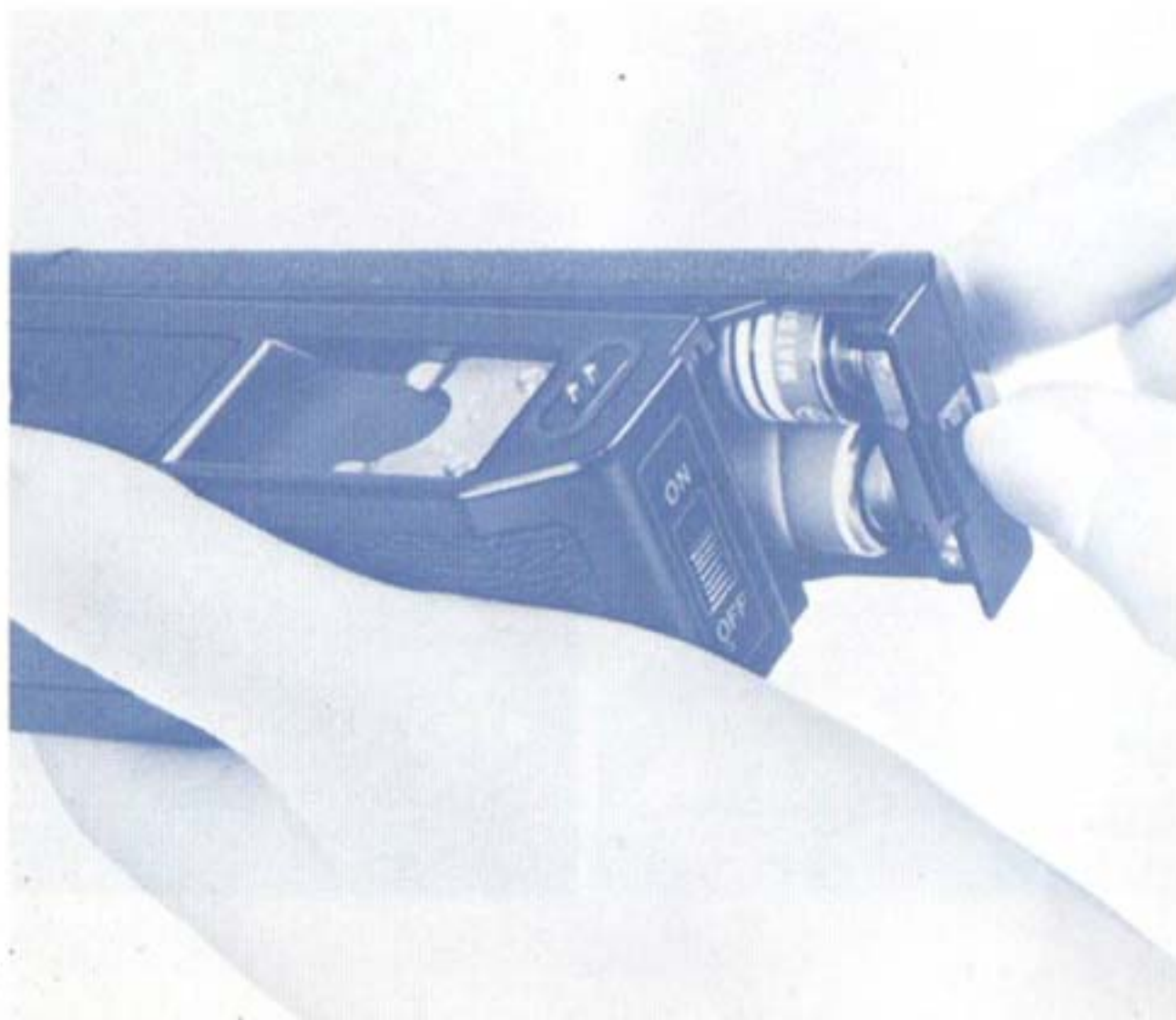

TABLE OF CONTENTS

SPECIFICATIONS	8-11
PRELIMINARY PREPARATION	12
Mounting the Lens and Setting the Aperture Ring to the "A" Mark	13
Loading the Battery and Battery Check	14-16
Loading the Film and Setting the ASA	17-20
OPERATION FOR GENERAL PHOTOGRAPHY	23
Selecting the Shutter Speed	25
Focusing and Dioptic Adjustment Lenses	27-28
Holding the Camera	31
Rewinding the Film	33
Double-Check Before Shooting	34
DETAILED OPERATION OF THE AE-1	35
Viewfinder Information and Meter Sensitivity Pattern	37
AE Coupling Range and Overexposure Warning Mark	38
Underexposure and Coupling Range Warning LED Lamp	39

Stopped-Down Metering Index Mark and Manual Aperture Control "M" Signal	40
Effects of Changing the Shutter Speed and the Aperture	41-42
Depth-of-Field	43-44
Shooting against the Light and Manual Override	45
Exposure Compensation by Changing the ASA Setting and Using the Self-Timer	46-47
Long Exposures and "B" Setting	48
Stopped-Down Metering Lock for Manual Aperture Control	49
Lenses	50-51
ACCESSORIES, CARE OF THE CAMERA, MAINTENANCE, AND MISCELLANEA	57
Canon Speedlite 155A	59
Flash Photography with the AE-1	60
Canon Power Winder A	61
Canon Data Back A and Auto Bellows	63
Other Accessories	64-65
Characteristics	66-69
Care and Storage of the Camera	71-72
Using the Camera in Very Cold Conditions	73

SPECIFICATIONS

Type: 35mm SLR (Single-Lens-Reflex) camera with electronically controlled AE (Automatic Exposure) and focal plane shutter.

Picture Size: 24 x 36mm

Interchangeable Lenses: Canon FD series with full aperture metering and AE coupling.
Canon FL series with stopped-down metering.

Standard Lenses: Canon FD 55mm f/1.2 S.S.C.

Canon FD 50mm f/1.4 S.S.C.

Canon FD 50mm f/1.8 S.C.

Lens Mount: Canon Breech-Lock mount.

Canon FD, FL and R lenses can be used.

Viewfinder: Fixed eye-level pentaprism.

Field of View: 93.5% vertical and 96% horizontal coverage of the actual picture area.

Magnification: 1:0.86 at infinity with a standard 50mm lens.

Viewfinder Information: Split-image/micro-prism rangefinder, aperture scale with meter needle and stopped-down metering

index mark which also serves as battery charge level check mark. Besides, there are two red zones at the top of the aperture scale to warn of overexposure.

Below the aperture scale, a red warning LED lamp blinks to indicate underexposure. This lamp also indicates that the selected shutter speed is outside the AE coupling range with respect to the ASA of the film being used.

Above the aperture scale, a manual aperture control "M" signal (red LED) blinks as a warning that the aperture ring is not set at the "A" mark for AE photography.

Viewfinder Attachments: Angle Finder A2 and B, Magnifier S, Dioptic Adjustment Lenses (10 kinds), and Eyecup 4S.

Mirror: Instant-return, large reflector mirror with shock absorbing mechanism.

AE Mechanism: Shutter priority, electronically controlled AE metering system incorporating two ICs and one LSI equipped with I²L (Integrated Injection Logic)

Light Metering System: TTL (Through-The-Lens) Central Emphasis Metering

method employing a Silicon Photocell as photosensitive element.

Exposure Meter Coupling Range: With ASA 100 film, EV1 (f/1.4 at one second) to EV18 (f/16 at 1/1000 second).

Film Speed Range: ASA 25 to ASA 3200.

Exposure Correction: By pressing the back-light control switch, exposure is corrected by the automatic opening of the diaphragm 1.5 stops more on the aperture scale than the actual setting.

Exposure Preview: The meter needle will indicate in the viewfinder when the shutter release button is depressed halfway or the exposure preview switch is depressed.

Shutter: Cloth focal plane shutter with four spindles. Shock and noise damping mechanisms are incorporated. All shutter speeds are electronically controlled.

Shutter Speeds: 1/1000, 1/500, 1/250, 1/125, 1/60, 1/30, 1/15, 1/8, 1/4, 1/2, 1, 2 (seconds) and B. X synchronization is at 1/60 seconds.

Shutter Speed Dial: The shutter speed dial is on the same axis as the film advance

lever. The number 2 for two seconds is marked in orange; other numbers as well as X synchronization are in white.

There is a shutter dial guard to prevent unintentional movement of the dial. The ASA dial is located underneath the shutter speed dial.

Shutter Release Button: It is a large, button type magnetic release switch. Depressing the shutter release button halfway switches on the light metering circuit, while full depression releases the shutter. The shutter release button has a locking device, besides a socket for the cable release in the center.

Self-Timer: Electronically controlled self-timer. After the self-timer lever is pushed forward, the self-timer is activated by the shutter release button. The self-timer releases the shutter after a time lag of 10 seconds. A self-timer lamp (red LED) blinks on and off to indicate when the self-timer is in operation.

Stopping-Down the Lens: Stopping-down the lens can be performed by pushing the stopped-down lever after setting the

aperture ring.

Power Source: One 6V silver oxide battery (Eveready No.544, UCAR No.544, JIS 4G13, or Mallory PX28) or alkaline manganese battery (Eveready No.537, UCAR No.537). The battery lasts approximately one year under normal use.

Battery Check: Battery power level can be checked by the meter needle in the viewfinder when the battery check button is pressed.

Flash Synchronization: X synchronization is at 1/60 second.

M synchronization is at 1/30 second and below.

Flash Terminal: The accessory shoe has a direct flash contact and automatic flash control contacts. On the front of the camera body is the flash terminal, JIS-B type for flash units with a cord. It has a built-in protective rim to prevent electrical shock.

Automatic Flash: With the exclusive Canon Speedlite 155A, the shutter speed and aperture are automatically set. The amount of light is automatically con-

trolled for correct flash exposure.

Back Cover: The camera's back cover has a memo holder for your convenience. The cover can be removed for attaching the Canon Data Back A. To open, pull the rewind crank up.

Film Loading: Easy film loading with multi-slot take-up spool.

Film Advance Lever: Single stroke with 120° throw and 30° stand-off. The film can be wound with several short strokes. The Canon Power Winder A also can be mounted for automatic winding of the film.

Frame Counter: Additive type. Automatically resets when the back cover is opened. While rewinding film, it counts back the frame numbers.

Film Rewinding: Performed by pressing the rewind button on the bottom and by using the rewind crank on the top. The rewind button is automatically reset when the film is advanced with the film advance lever.

Safety Devices:

- The shutter does not drain battery power when not released.
- The film cannot be wound while the shutter is in operation.

Size: 141 x 87 x 47.5mm (5-9/16" x 3-7/16" x 1-7/8") body only.

Weight: 590g (20-13/16 ozs.) body only.
790g (27-7/8 ozs.) with the 50mm f/1.8 S.C. lens.
895g (31-9/16 ozs.) with the 50mm f/1.4 S.S.C. lens.



Subject to change without notice.

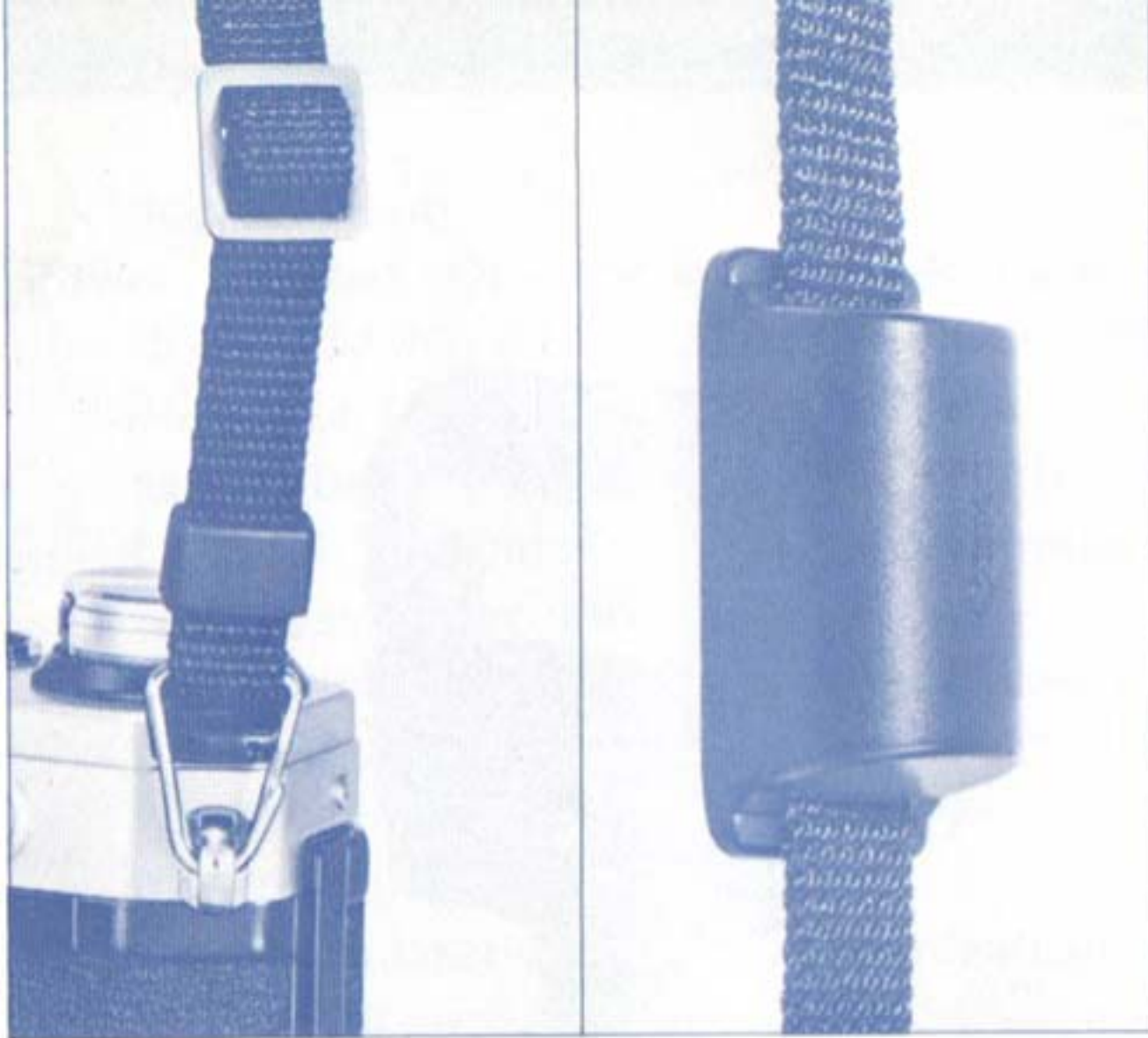

PRELIMINARY PREPARATION

Attaching the Neckstrap

Attach the Canon AE-1's neckstrap by threading it through the rings and adjusting it to the desired length as indicated in the photos. A case for a spare battery can be attached to the neckstrap.

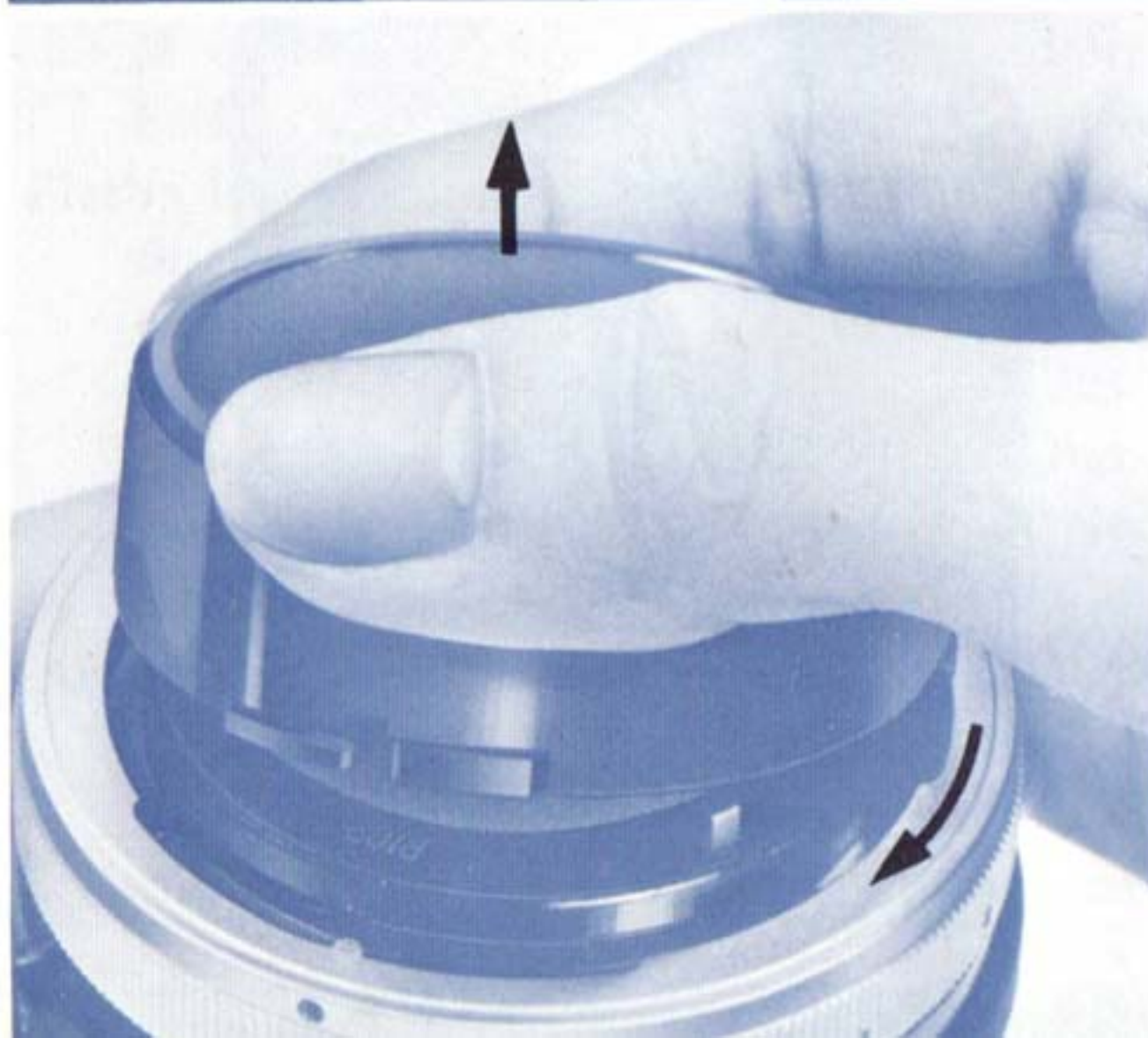

Handling the Lens Cap

The lens cap can be removed from the front of the lens after pressing in the tabs on both sides of the cap. The rear dust cover can be removed by turning the bayonet ring in the direction of the arrow. To attach the dust cover, align its slot with the positioning pin below the red dot of the bayonet ring, and press it in. When the dust cover is removed, the bayonet ring is locked.

For an explanation of how the lens mechanisms function, see page 52.

1 Mounting the Lens

Remove the body cap and mount the lens onto the camera. The lens is mounted by aligning the red dot of the body with the red dot of the bayonet ring, and then turning the bayonet ring clockwise, pressing gently until it locks into position. Reverse the procedure to dismount the lens.

FD series lenses must not be mounted on the camera when the film is partially advanced.

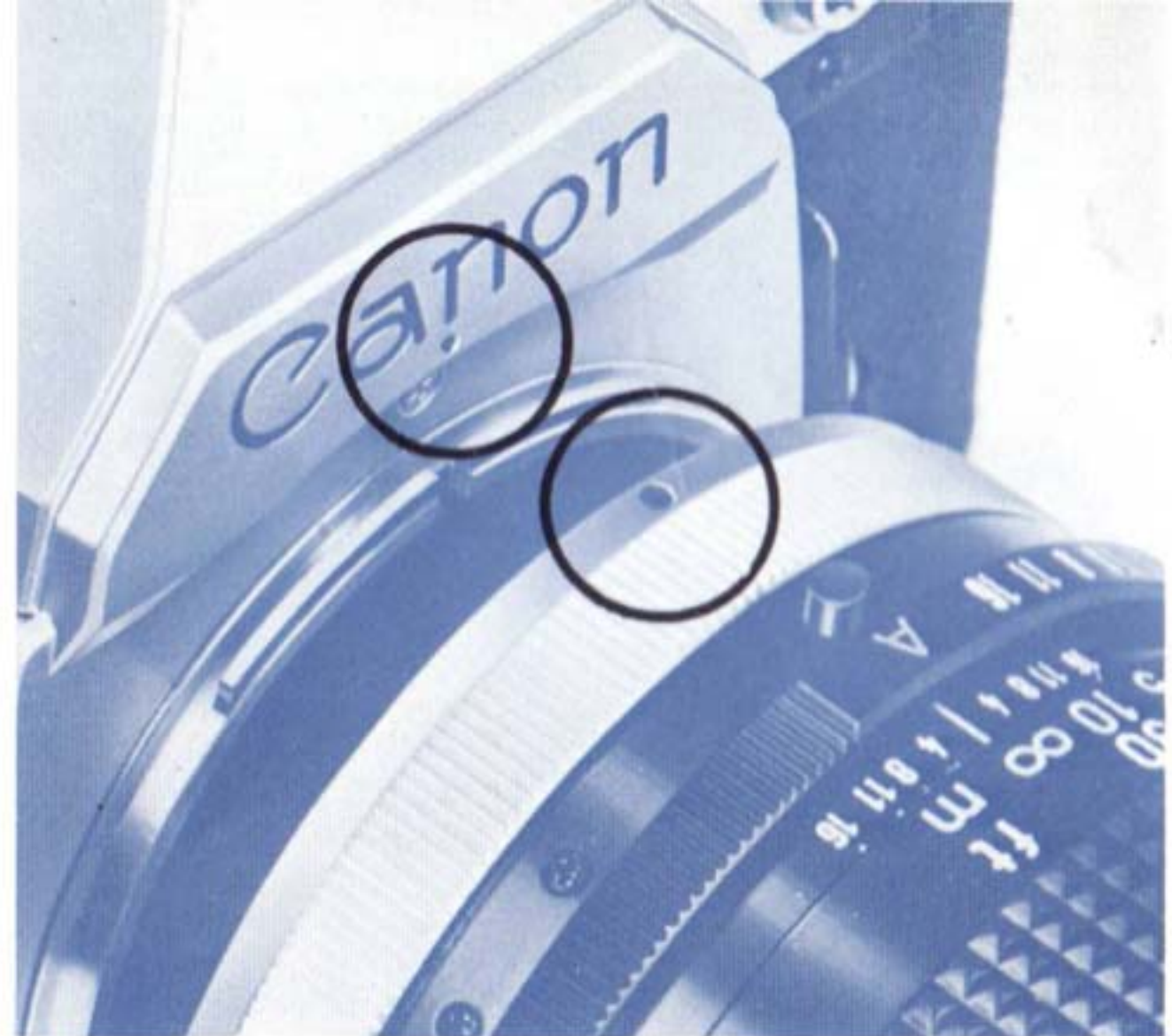

2 Setting the Aperture Ring to the "A" Mark

The AE-1 delivers perfect AE photography when the aperture ring is set for automatic exposure. The "A" mark on the aperture ring should be set to the EE position. Hold in the EE lock pin while turning the aperture ring to the "A" mark. This can be done either before or after the lens is mounted on the camera. This setting can be unlocked by pressing the EE lock pin in and turning the aperture ring away from the "A" mark.



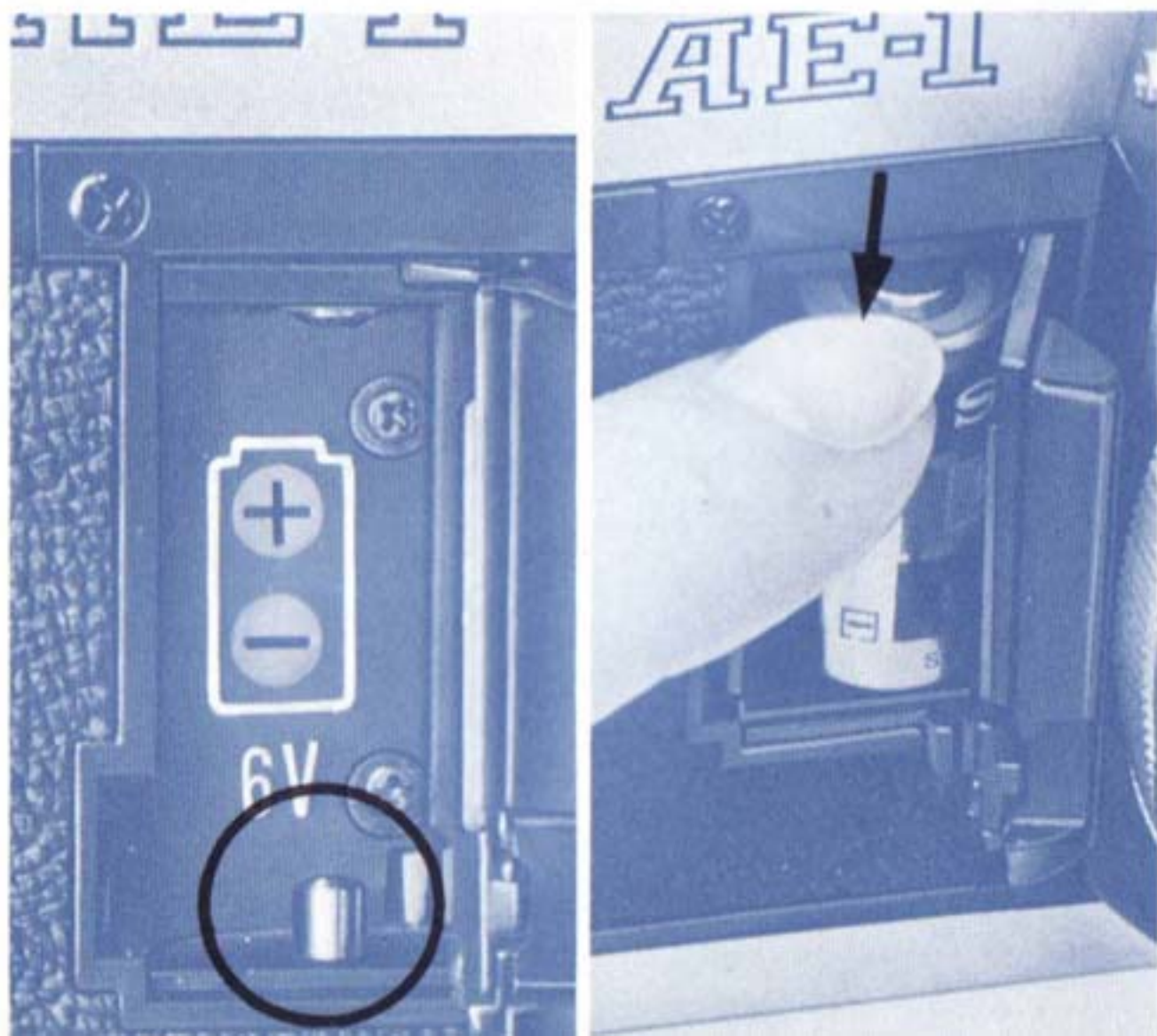

3 Loading the Battery

This camera will not function without battery power. A 6V silver oxide battery is loaded into the battery chamber after opening the battery chamber cover. It can be opened more easily by using the viewfinder cover that is inserted into the accessory shoe.

Be careful to load the battery correctly with the "+" side up as indicated in the diagram. Load the battery by inserting first the "-" contact in the battery chamber. The battery can be unloaded in a similar way by pulling it out from the top. The battery can be loaded and unloaded more easily when the lens is dismounted. The battery should last for approximately one year under normal use. Refer to page 73 about the details of the battery when the camera is used in extremely cold conditions.

4 Checking the Battery

Since the AE-1 is an electronically controlled camera, the shutter will not function without sufficient battery power.

The battery requires checking in the following circumstances:

1. When a new battery is loaded.
2. When the shutter does not function.
3. When long exposures are frequently performed.
4. When the camera is used very frequently.
5. When the camera is used after it has been stored for a long period.
6. When the camera is used in extremely cold conditions.



Alkaline Manganese Battery

Silver Oxide Battery



Usable Batteries	
Silver Oxide Battery (6V)	Eveready (UCAR) No.544 JIS 4G13, Mallory PX28
Alkaline Manganese Battery (6V)	Eveready (UCAR) No.537

How to Check the Battery

To check the charge level of the battery, press the battery check button on the top of the camera while watching the meter needle in the viewfinder. If the meter needle rests below or coincides with the index opposite the 5.6 f/stop, the power level is sufficient. If the needle rests above the index, replace the battery with a new one of the prescribed type. When a new battery with full voltage is used, the needle will swing below the 4 f/stop. The weaker the battery, the closer the needle comes to the index.

- If the meter needle fails to stabilize within about three seconds, the battery is near exhaustion and should be replaced.

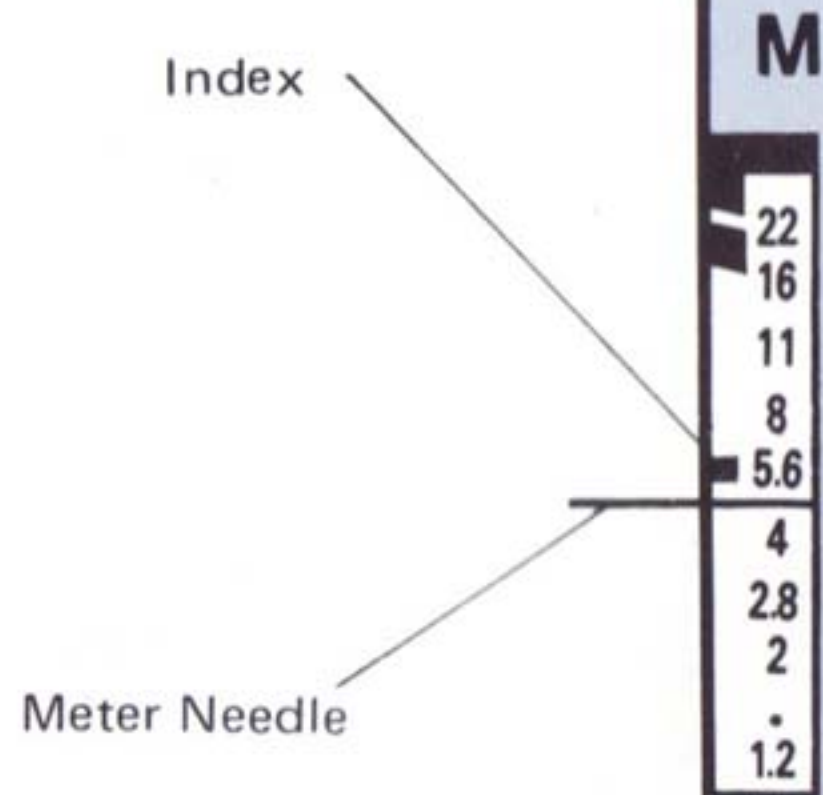

5 Loading the Film

The Canon AE-1 uses color or black and white film in standard 35mm cartridges.

Opening the Back Cover

To load a cartridge of film into the camera, first open the camera's back cover. Pull up the rewind crank and the back cover will pop open. The back cover can be securely closed simply by pressing it until it locks.

The Canon Data Back A, an accessory for imprinting data such as the day, month and year, can be attached to the AE-1 in place of the back cover. (See page 63.)

How to Load the Film

Avoid direct sunlight when loading or unloading the film.

Put the cartridge into the film cartridge chamber and press down while rotating the rewind knob until it drops securely into position. The protruding part of the cartridge should be on the bottom. Pull the film leader across and insert the end into one slot of the multi-slot take-up spool. Turn the film advance lever and wind the film around the take-

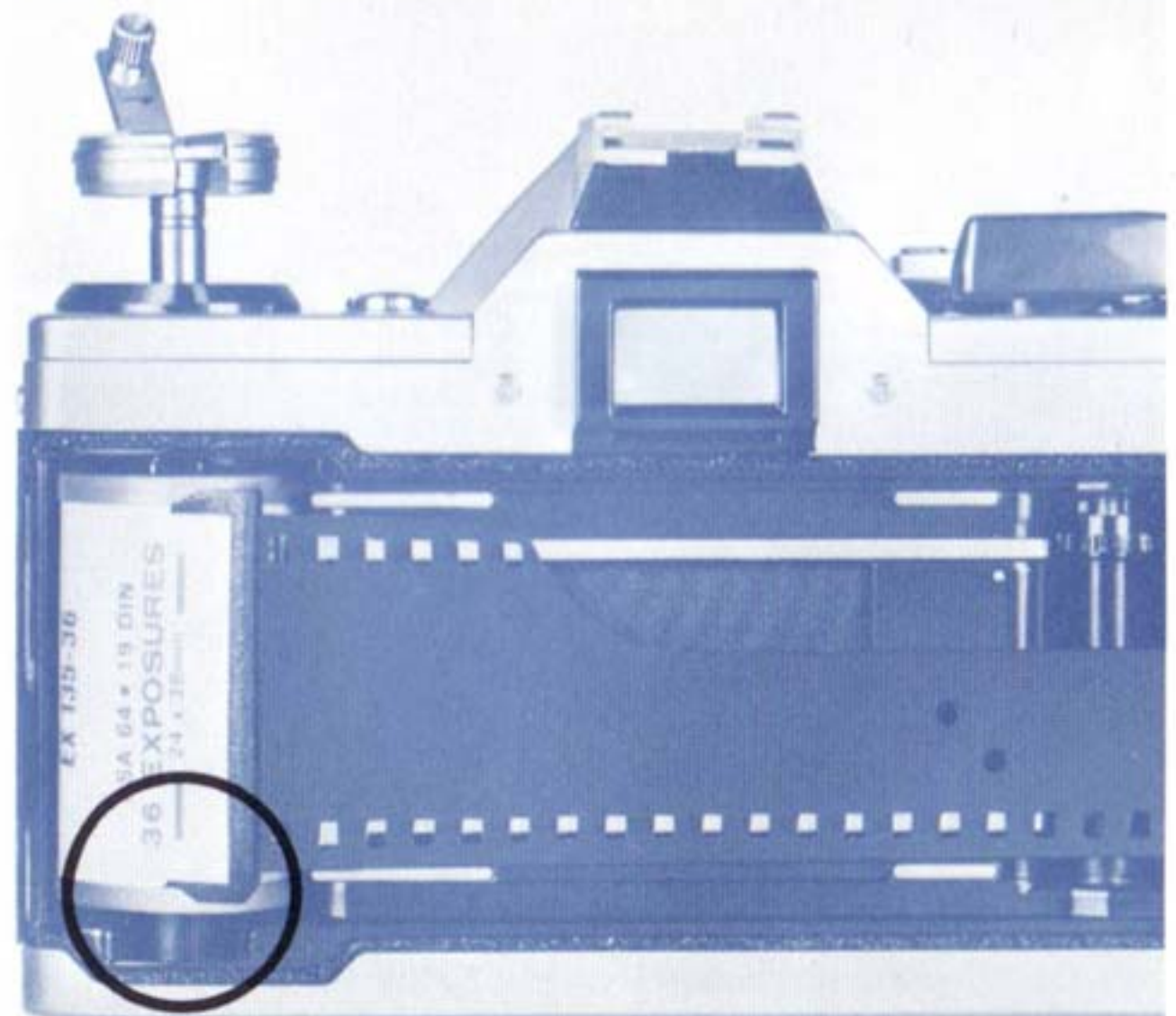
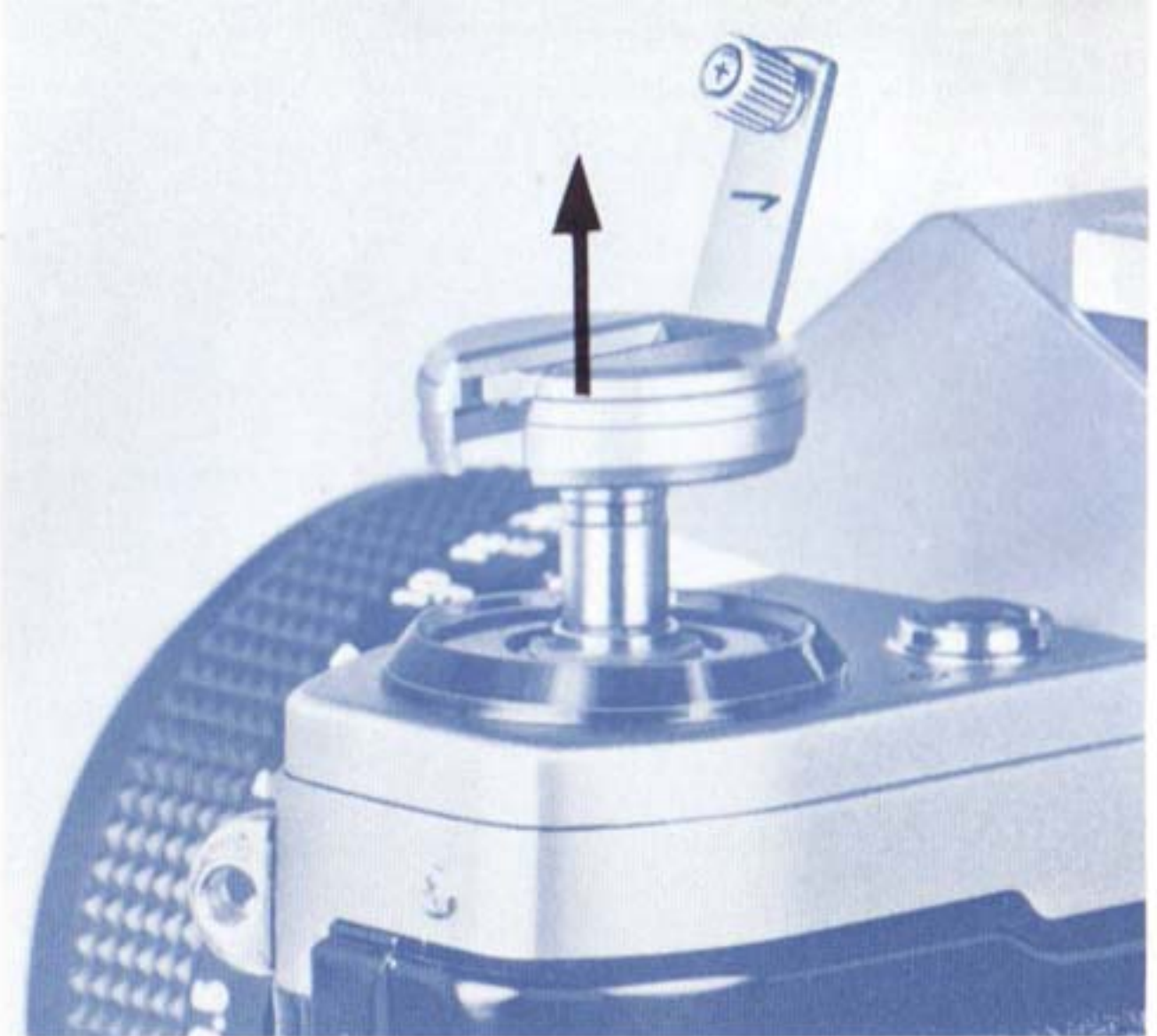



up spool making sure that the perforations of the film are engaged in the teeth of the film transport sprocket.

Then, make sure that there is no film slack. In case there is, gently turn the film rewind crank in the direction of the arrow to obtain proper film tautness and the film advance lever to ensure that the leader is wound fully on to the take-up spool before the camera back is closed.

When loading the film into the camera, do not touch the shutter curtain, the film rails or the pressure plate.

Closing the Back Cover

Close the back cover until it snaps shut. Gently turn the film rewind crank clockwise in the direction of the arrow to take up the film slack. Then, advance the film a couple of times pressing the shutter button until the first exposure appears in the frame counter.

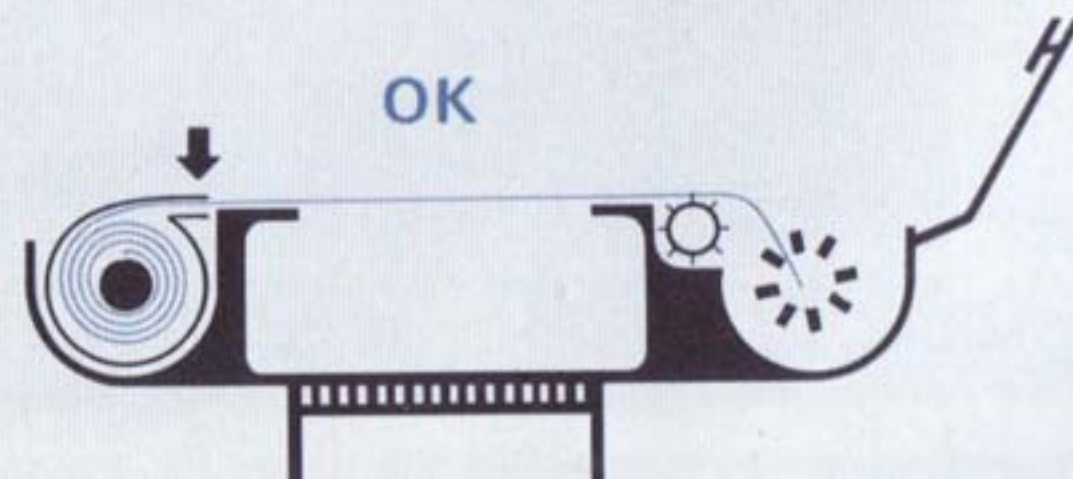
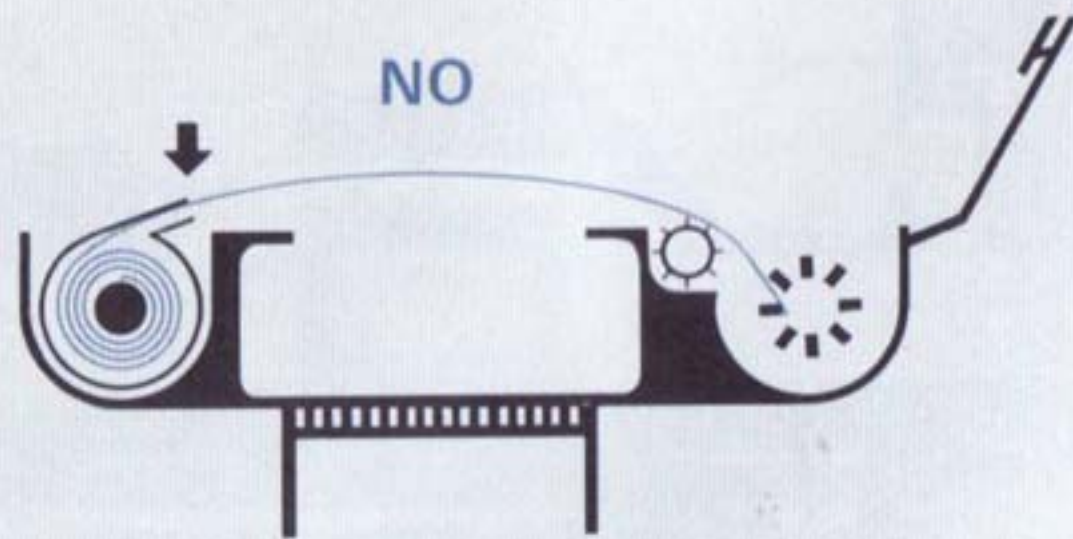

Checking Film Winding

Operate the film advance lever while watching the film rewind knob. If it rotates, the film is properly loaded. If the rewind knob does not rotate, open the back cover and load the film again from the start.

6 Setting the ASA Film Speed

After loading the film, set the ASA film speed according to the ASA speed of the film in use. To set the ASA, first push the film advance lever out to its 30° stand-off position away from the camera body, then lift up the ASA ring around the shutter dial and rotate it in either direction until the proper number is aligned with the green index mark. ASA is a numerical rating of a film's sensitivity to light. A higher ASA number indicates a faster film which is more sensitive to light. On the other hand, a lower ASA number indicates a slower film which is less sensitive to light. The ASA rating recommended by the manufacturer is printed on the film box, e.g., ASA 100.

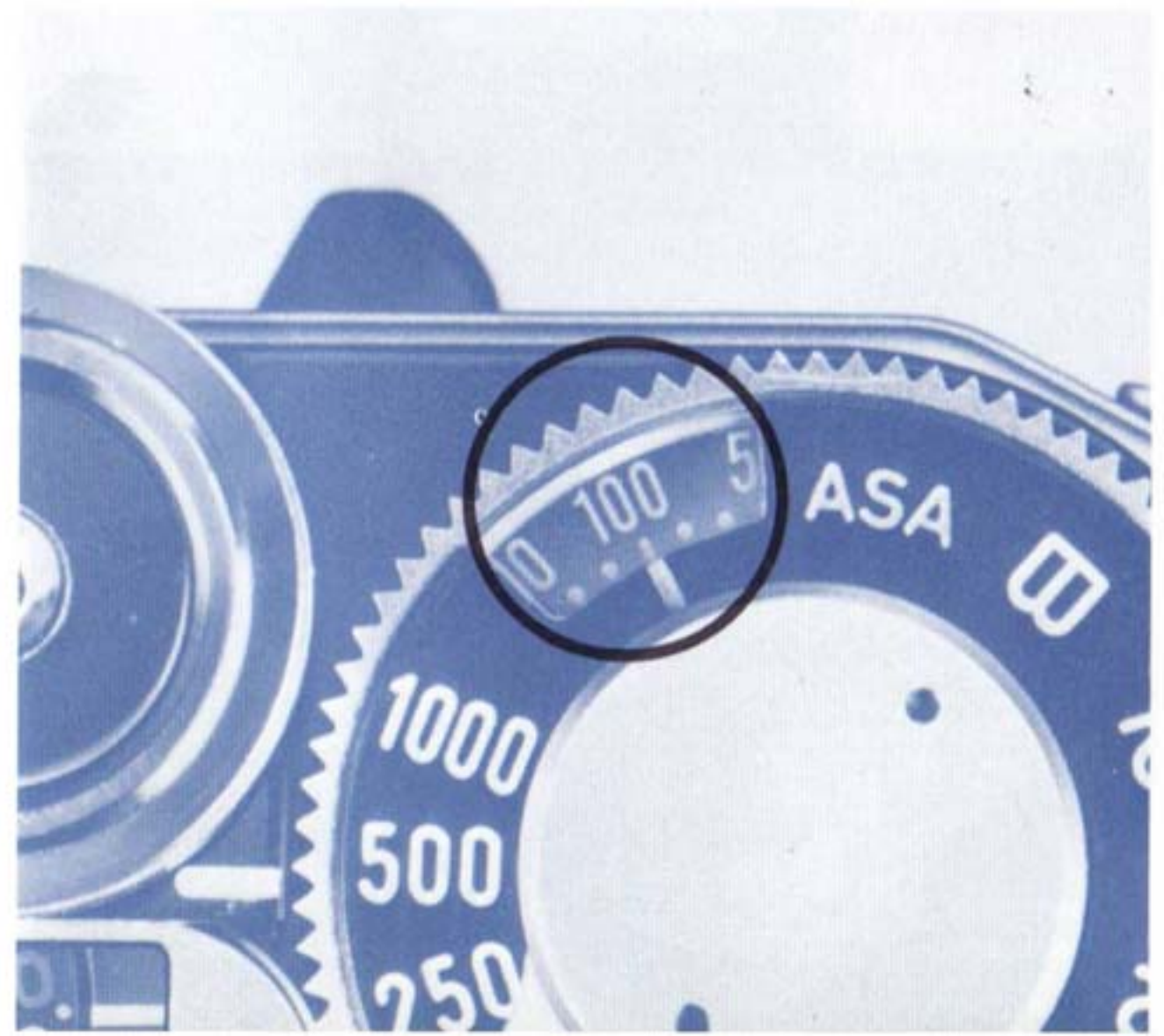
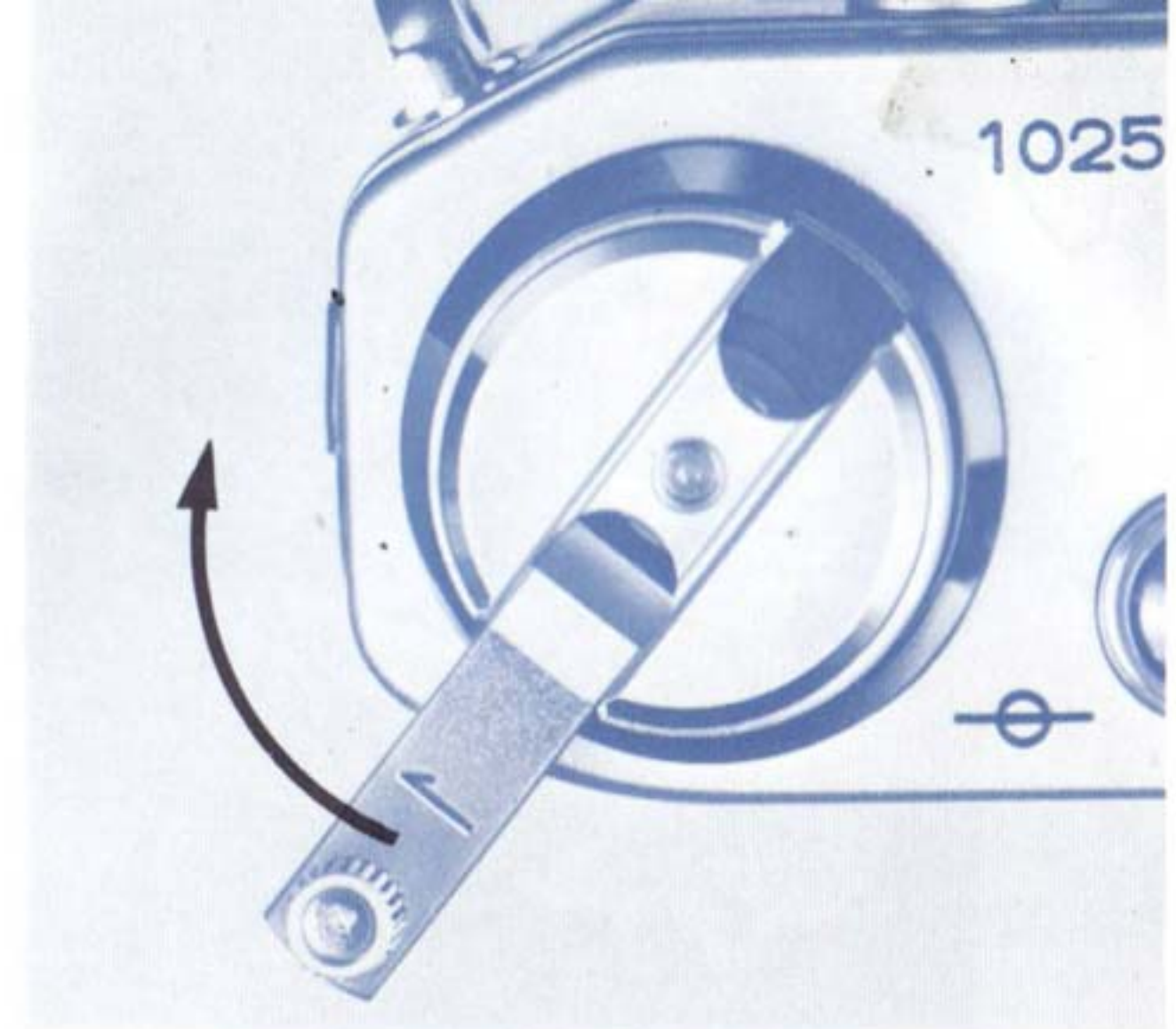

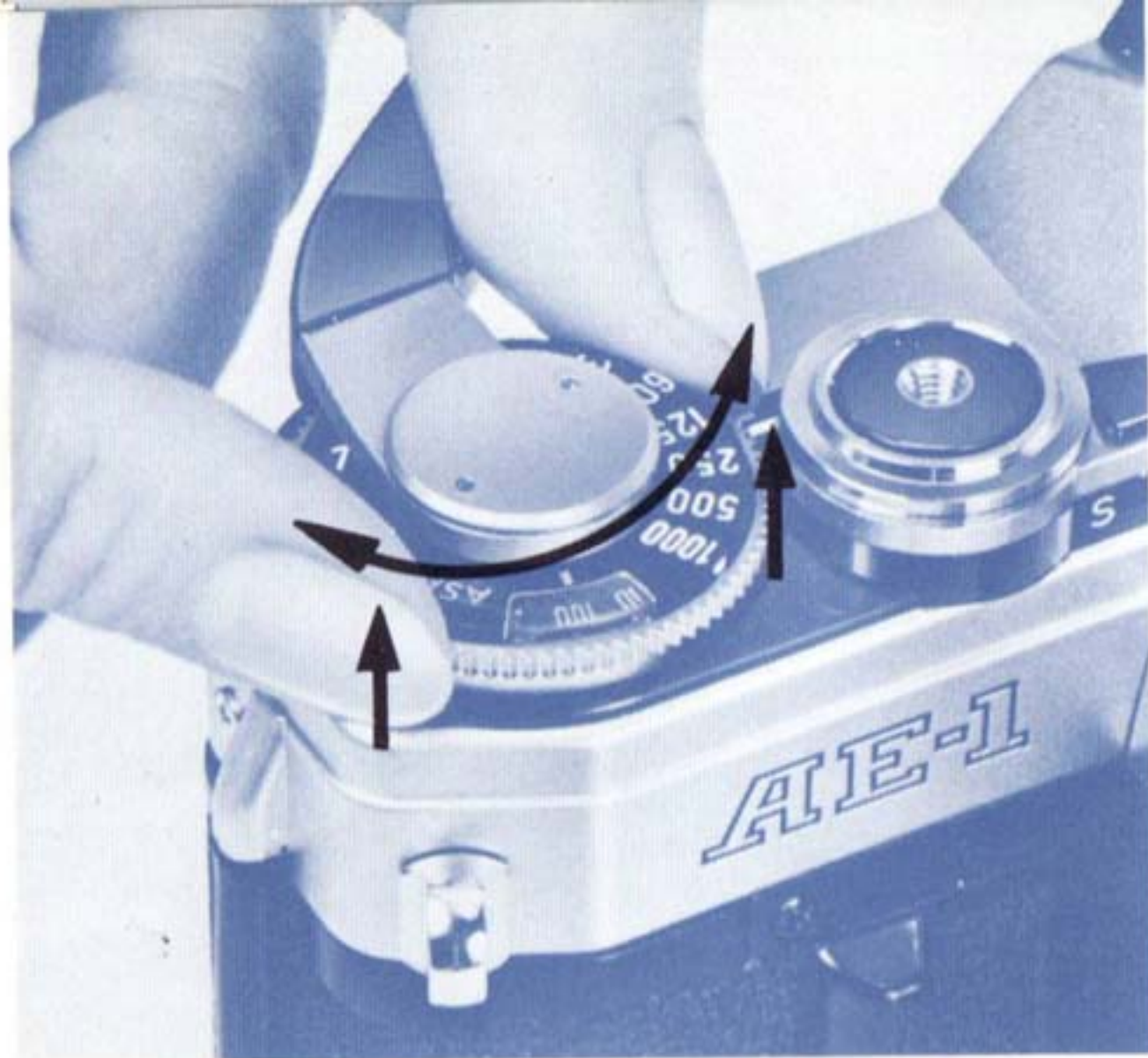

The following ASA ratings can be set on the camera. Figures in parentheses indicate intermediate film speeds.

ASA 25 • ⁽³²⁾ • ⁽⁴⁰⁾ • 50 • ⁽⁶⁴⁾ • ⁽⁸⁰⁾ • 100 • ⁽¹²⁵⁾ • ⁽¹⁶⁰⁾ • 200 • ⁽²⁵⁰⁾ • ⁽³²⁰⁾ • 400
• ⁽⁵⁰⁰⁾ • ⁽⁶⁴⁰⁾ • 800 • ⁽¹⁰⁰⁰⁾ • ⁽¹²⁵⁰⁾ • 1600 • ⁽²⁰⁰⁰⁾ • ⁽²⁵⁰⁰⁾ • 3200



Use of the Memo Holder

The memo holder on the camera's back cover is useful for keeping data like film speed, location, shooting. For example, after tearing off the part of the film box which specifies the type of the film being used, it can be inserted into the memo holder as a constant reminder.

Film Advance and Shutter Release

Turn the film advance lever until it stops, so the film will advance one frame all in one motion. The shutter will cock, and the diaphragm and mirror will be ready for the next shutter release, while the frame counter advances simultaneously to the next number. By pushing the film advance lever lightly with the tip of your thumb, it will open to its 30° stand-off position away from the camera body for easy film advance.

While the film is advancing, the shutter will not be released. Film winding can also be accomplished by advancing the lever in short strokes.

Canon has developed the Power Winder A to be used with the AE-1 for automatic film winding. It greatly increases the automation and mobility of the AE-1. (See page 61.)

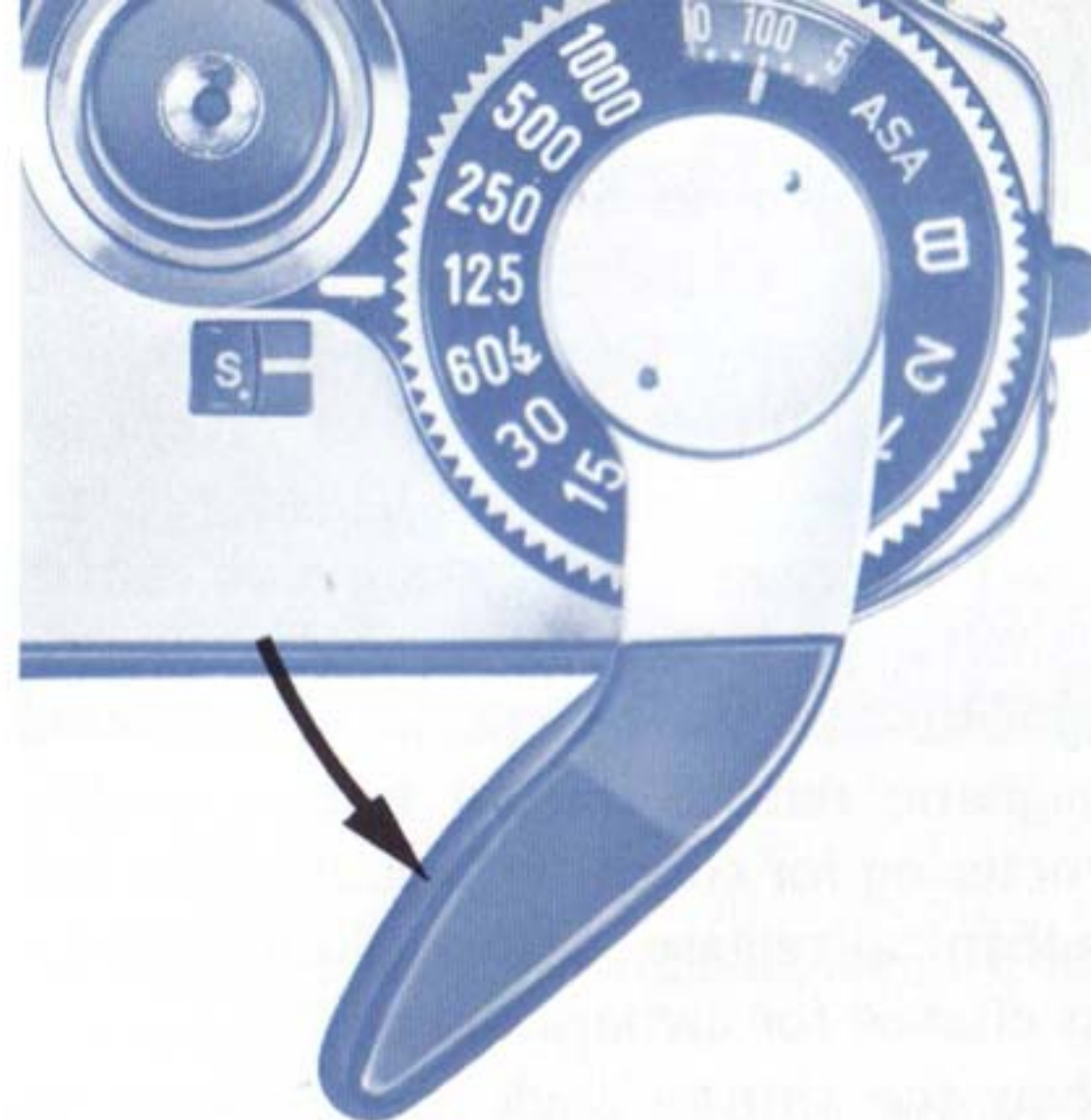

Shutter Button and Shutter Lock

The shutter release button is designed to function as the main switch of the camera to activate the AE meter and shutter operation. The shutter has a magnetic release, so the meter can be read by pressing the shutter button halfway with light pressure. By depressing it further, the shutter will be released. The magnetic release shutter button enables faster metering for shooting in succession than the mechanical release method does. There is also less chance for camera shake.

When the shutter lock lever around the



shutter release button is turned to the "L" position, the shutter button will be locked to prevent unintentional shutter release. Keep the shutter release button locked while carrying the camera to prevent film waste.

When the power level of the battery is insufficient, a safety mechanism will keep the shutter from being released.

Frame Counter

The frame counter is an additive type which counts one frame every time the film advance lever winds the film. When the camera's back cover is opened, the frame counter automatically resets itself to the "S" position.

While rewinding film, the frame counter counts back the frame numbers. The starting position "S", 0, and the even numbers 2 to 38 are displayed by the counter. Numbers 20 and 36 are marked in orange to call your attention to the end of film cartridges such as are today commercially available. The frame counter cannot count higher than 38.

Operation for General Photography

The AE-1 is an Automatic Exposure camera with a shutter speed priority system which electronically controls the aperture for the given shutter speed to ensure the optimum exposure. Canon's shutter speed priority system has been used in this camera in the idea that a photograph is an instant snatched from elapsing time.

The shutter speed priority system is ideal

for catching fast-moving subjects, especially at the decisive moment.

Furthermore, the shutter speed priority system allows you to control image blur at will and to emphasize the movement of the subject. For action or other such situations, you can realize all photographic aspirations.



1 Setting the Shutter Speed

The shutter dial controls the length of time that light is allowed to reach the film. On the shutter speed dial, shutter speeds from 1/1000 to "B" are marked in white, while the 2-second speed is marked in orange. Each shutter speed gradation is twice or approximately twice the preceding speed, beginning with 1/1000 sec. (1000).

Thus, the light reaching the film at 1/250 second is half the light reaching it at 1/125. The numbers on the shutter speed scale represent the corresponding fraction of a second ($125 = 1/125$), with the exception of 1 and 2 (marked in orange) which stand for 1 and 2 seconds respectively.

The "B" setting is for long exposures. At the "B" setting, the shutter remains open while the shutter button is depressed and closes when it is not depressed. See page 48 for more details concerning long exposures.

To set the shutter speed, rotate the dial in either direction until the desired number clicks into place next to the white index mark. An in-between setting should not be used, and the shutter speed dial cannot be

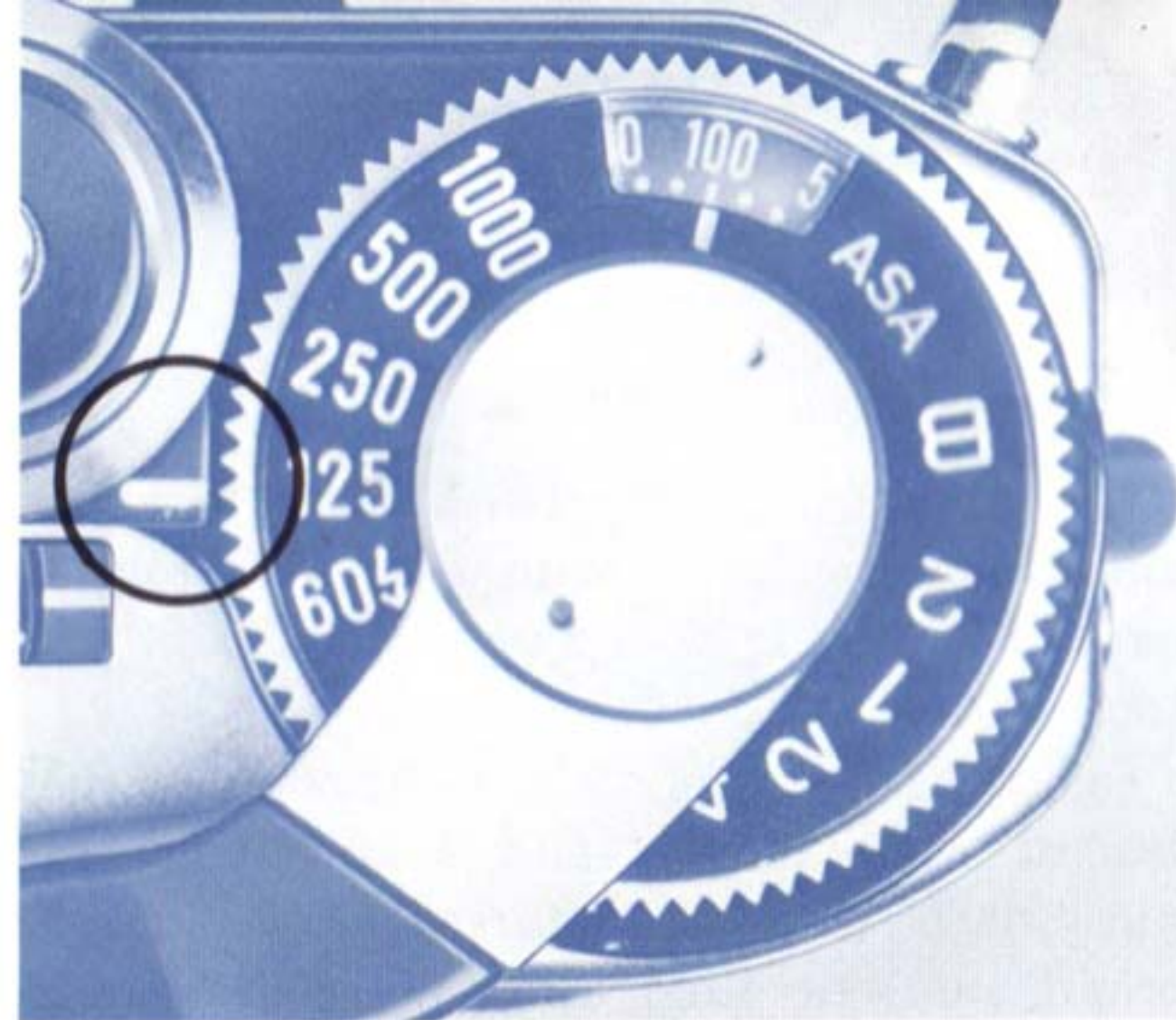

rotated between "B" and "1000".

Brightness	Shutter Speed (Seconds)
Indoors	1/30 to 1/60
Outdoors	1/125 to 1/250
Mid-summer Beach • Snow-covered Mountains	1/500 to 1/1000

Selecting the Shutter Speed

Shutter speed is determined in accordance with the brightness of the scene and the speed with which the main subject is moving. You can use the above table as a general guide to help you select an appropriate shutter

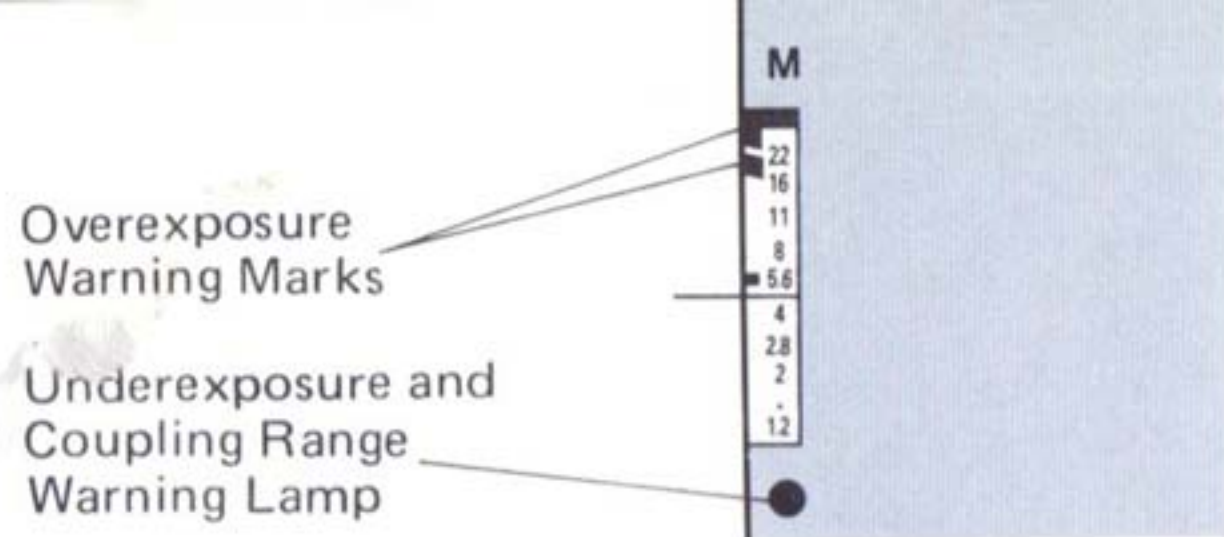

speed when using a standard 50mm lens. For indoor photography, with no special illumination, choose 1/30 of a second and 1/60 of a second in a brightly lit room.

For outdoor photography, select 1/125 second when cloudy and 1/250 second in sunshine. To take pictures in particularly bright sunshine such as at a beach in mid-summer or in snow-covered mountains, use shutter speeds of 1/500 sec. or 1/1000 sec.

The above mentioned shutter speeds apply when using a standard 50mm lens, but it is necessary to choose faster shutter speeds when using lenses of longer focal lengths because they are more difficult to hold steady. It is generally said that the shutter speed figure should be greater than 1 divided by the focal length of the lens in order to obtain sharp images.

For example, when using a 200mm telephoto lens, shutter speed should be faster

than 1/200 second, therefore the shutter speed in this particular case should be set at 1/250 sec. Image blur can also arise if the camera is not properly held. See page 31.

2 Reading the Exposure

This camera incorporates a magnetic release system using an electromagnetic switch to effectively perform instantaneous light metering. The shutter release button activates light metering and exposure in succession and practically simultaneously.

This is a two-step shutter button. The exposure can be confirmed by the meter needle inside the viewfinder by pressing the shutter button halfway.

When the meter needle inside the viewfinder stays within the proper range and the underexposure warning LED lamp below the aperture scale inside the viewfinder does not blink, the exposure is correct. See page 39 about the underexposure warning lamp.

When the underexposure warning lamp inside the viewfinder blinks, or when the meter needle moves into the upper overexposure warning zone in red, the exposure is incorrect. When this is the case, turn the

shutter speed dial until the meter needle inside the viewfinder moves into the proper exposure range. To confirm this, turn the shutter speed dial while looking into the viewfinder and pressing the exposure preview switch at the same time. It is convenient to turn the shutter speed dial with your forefinger in order to swiftly cope with the speed of fast moving subjects. When using shutter speeds slower than 1/30 second, the camera should be placed on a tripod to avoid the possibility of camera shake.



3 Viewing and Focusing

Focusing is performed in the small round area in the center of the viewfinder. The smaller central circle is a split-image focusing screen and around it is the microprism ring. The split-image rangefinder ascertains that the image is "in focus" when the image divided horizontally in half matches and becomes one complete image.

The microprism rangefinder presents a clear and steady image when in focus. The microprism conveys a broken, shimmering

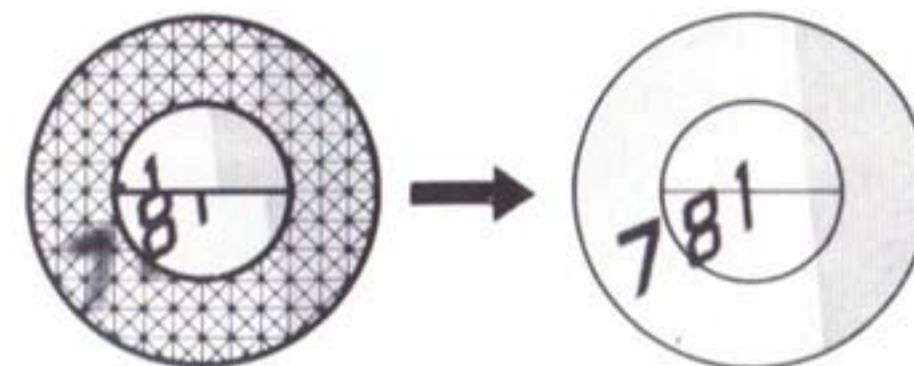

Out of Focus

In Focus

image when not accurately in focus. It is also possible to focus with the matte screen outside the smaller central area. You can focus with either of these focusing aids as you like, depending on the subject condition and your preference.

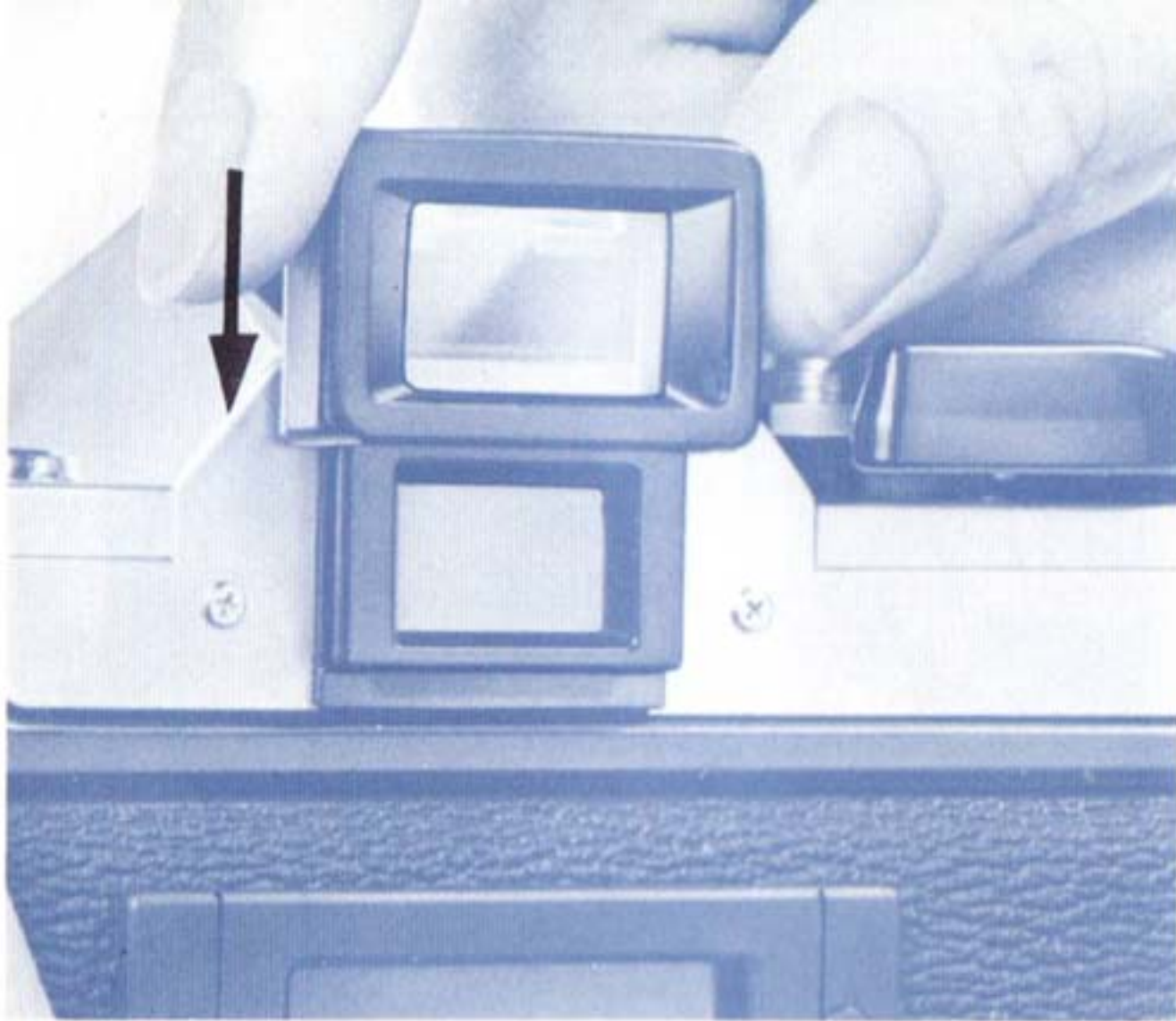

Accessories such as an eyecup, dioptic adjustment lenses, angle finders, and magnifier can be attached to the viewfinder eyepiece.

Dioptic Adjustment Lenses

Dioptic adjustment lenses can be attached by inserting them from above into the grooves in the viewfinder eyepiece to compensate for the individual eyesight. With them, near-sighted or far-sighted persons can perform photography without glasses.

The built-in eyepiece lens of the AE-1 has -1 diopter. The following 10 kinds of dioptic adjustment lenses are optional accessories: $+3$, $+2$, $+1.5$, $+1$, $+0.5$, 0 , -0.5 , -2 , -3 and -4 (diopters).

One way of selecting the correct dioptic adjustment lens for you is to select the one that is the closest to your glasses in regard to number of diopters. But, we propose that, when you select the most appropriate dioptic adjustment lens, you actually look into the viewfinder through it after placing it over the eyepiece.

Because the camera itself has -1 diopter, the diopters of the lenses are recorded as the real power when attached to the camera, thus reflecting the power of the camera's viewfinder.

Angle Finder A2 and B

The angle finder slips over the viewfinder eyepiece. It rotates 90 degrees so that the image on the viewfinder can be viewed directly from the side or above whenever it is inconvenient or impossible to look directly through the eyepiece. This is very helpful in copying, close-ups, macrophotography, and photomicrography. There are two types, the A2 whose image is reversed as in a mirror, and the more advanced Angle Finder B with the normal camera image.

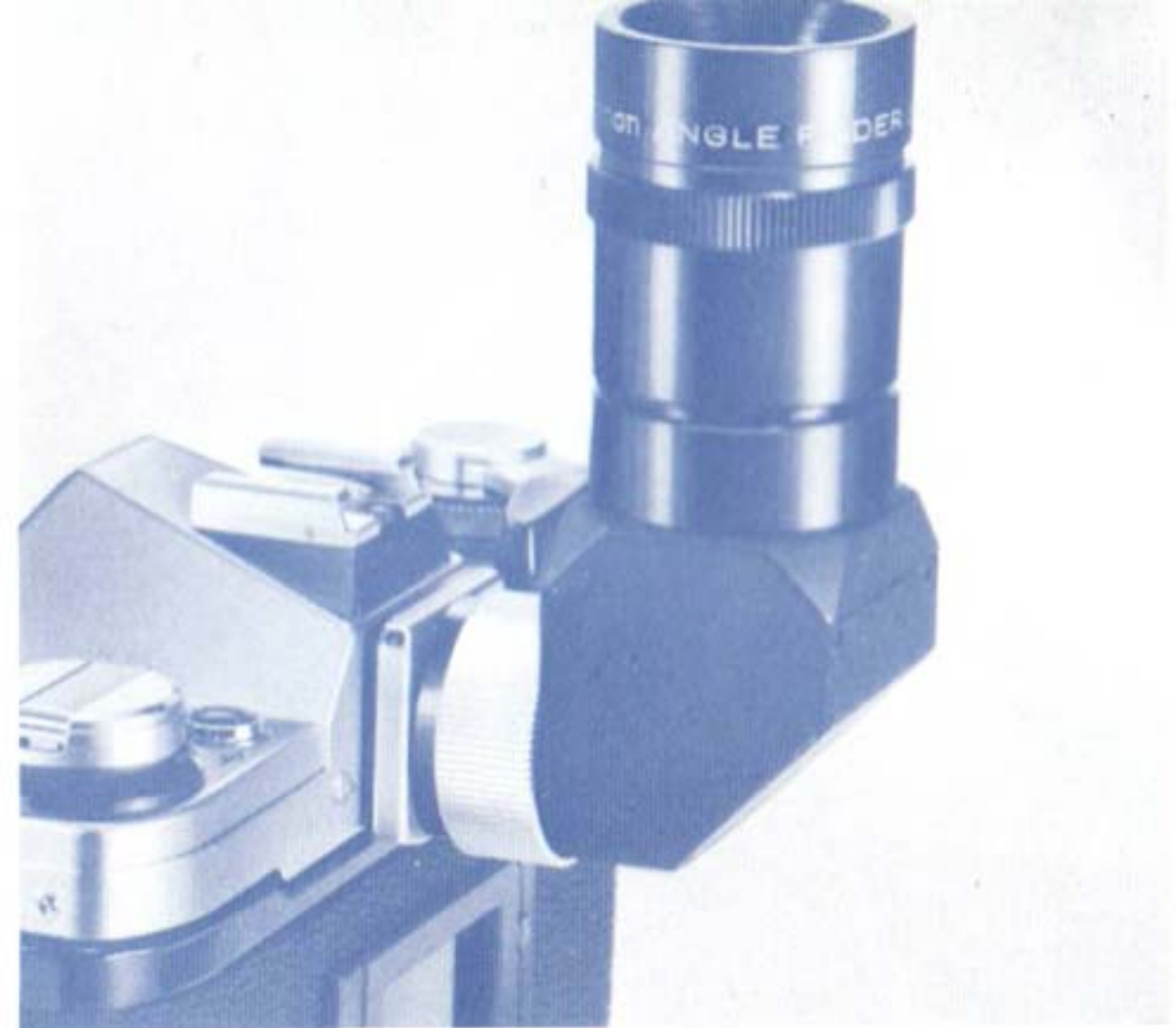

Magnifier S

The Canon Magnifier S gives 2.5X magnification of the viewfinder center for precision focusing in close-up work. The power can be adjusted to your eyesight within the range of +4 to -4 diopters.

The Magnifier S combined with its adapter can be inserted into the grooves of the viewfinder eyepiece. The adapter of the Magnifier S is hinged to allow the magnifier to swing upward from the eyepiece leaving the whole screen image visible after focusing.

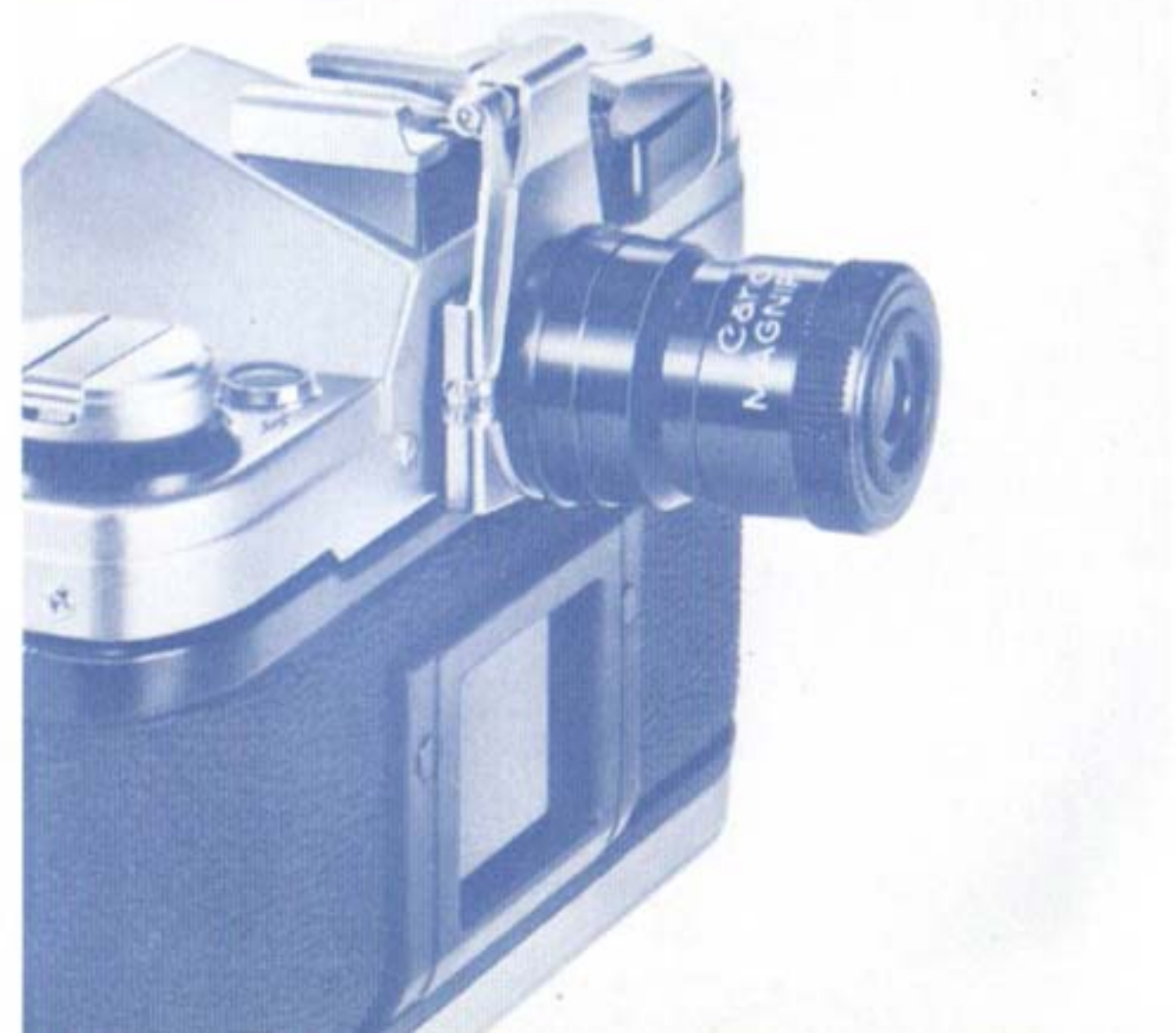

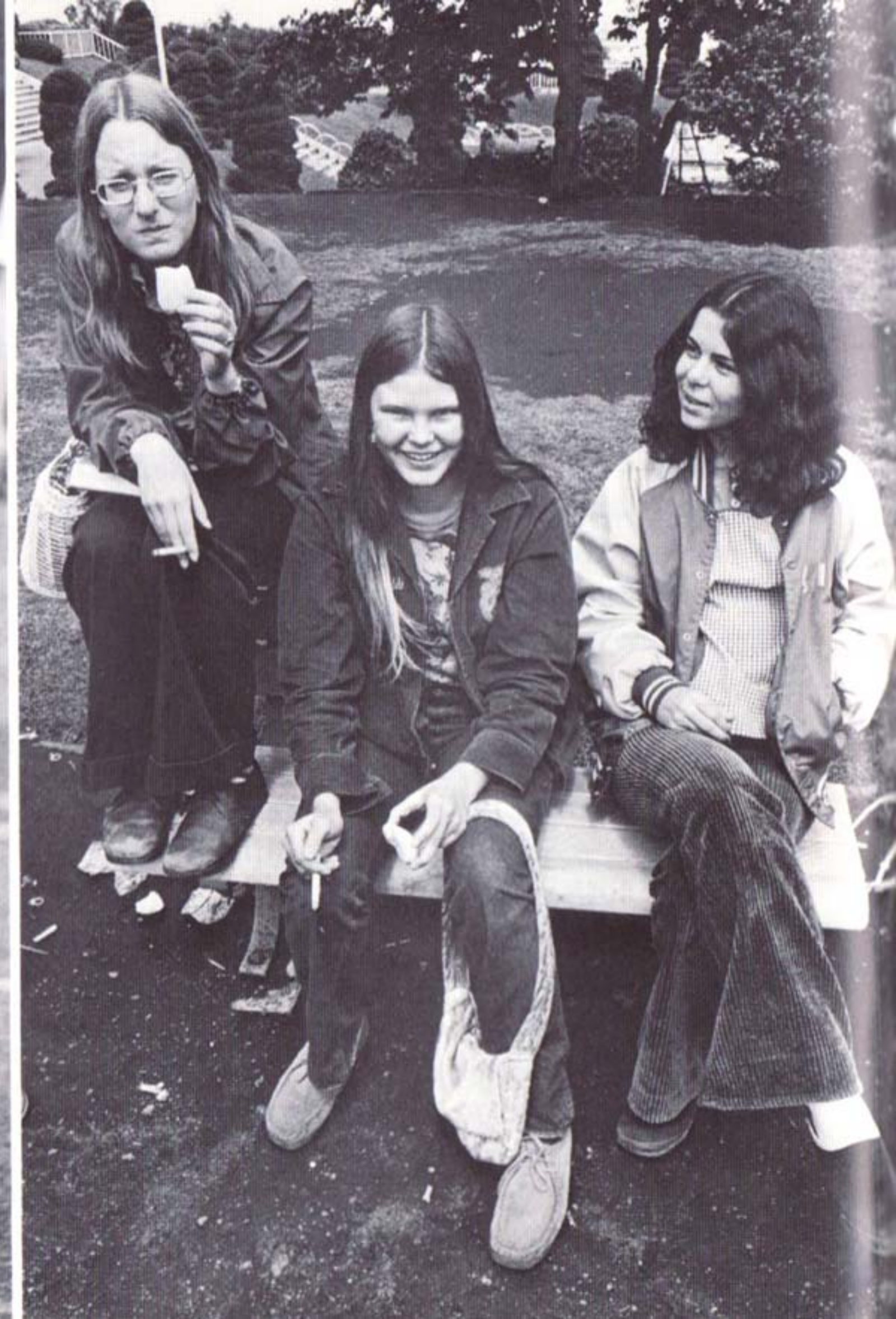

Holding the Camera

Unlike the mechanical release system, the magnetic release system of the Canon AE-1 electronically controls the shutter. The shutter button moves with a very light touch and its travel is very short. The shutter will be released by lightly depressing the shutter button so as to prevent camera shake. But, unsteady holding of the camera will cause camera shake in spite of the magnetic release system.

Therefore, be sure to hold the camera firmly. Rest the camera on your left palm and grasp the lower part of the lens focusing ring between your thumb and forefinger or middle finger. Hold the right end of the camera firmly, with your right thumb behind the tip of the film advance lever and your right forefinger on the shutter button, while the other fingers hold the camera's finger grip.

To reduce camera shake, press your left elbow strongly against your body and look into the viewfinder steadying the camera against the forehead. The right arm should be relaxed while holding the camera.

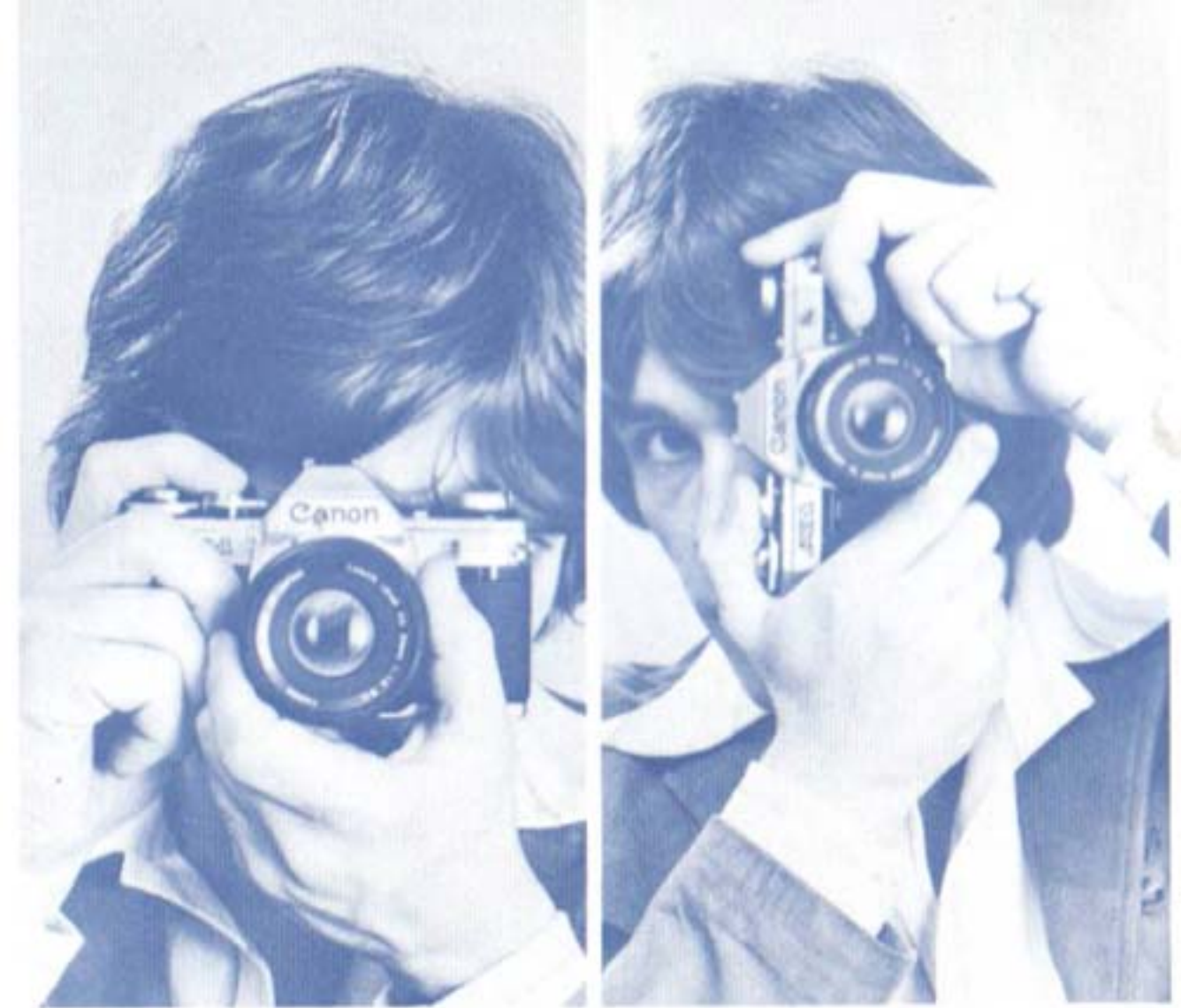

When you use comparatively slow shutter speeds or when you use telephoto lenses, it is advisable to lean against a wall, a tree trunk or some fixed object for a steadier grip. The above describes the fundamentals of how to hold the camera. You may find yourself the most appropriate grip for you and get accustomed to it through constant practice.



Adapter A for Tripod

When using a great diameter lens, depending on the tripod being used, it may be difficult to hold the adjustment in the case of accidental bumping of the lens. In such cases, the rubber Adapter A for Tripod may be placed between the tripod head and the camera.

Composition

Since the AE-1 has automatic exposure control with shutter priority, you can concentrate on the actual picture you are going to take without worrying about exposure differences that may occur with changing subjects. Viewing is performed through the lens, and there is no difference between the viewfinder image and the image exposed on the film, as opposed to the image provided by a separate viewfinder which is affected by the parallax between the viewfinder and the camera lens.



Releasing the Shutter

The Canon AE-1's shutter button uses a magnetic release system. The shutter button travel is very short and activated by a very gentle touch. When you press the shutter button, try to squeeze the shutter button gently with your finger. Avoid hitting or pressing the shutter button suddenly particularly when using slow shutter speeds, otherwise blur may result.

At the moment of shooting, you should hold your breath while the shutter button is being pressed.

Rewinding the Film

When the film advance lever cannot travel all the way to the end of its stroke, the frame counter tells you that you have reached the end of the film. You have to rewind the film in its protective cartridge, before you can remove it from the camera.

You must not open the camera before rewinding the film. Since it is not protected, any exposure to light will "fog" the film and cause a drastic color shift and loss of image.

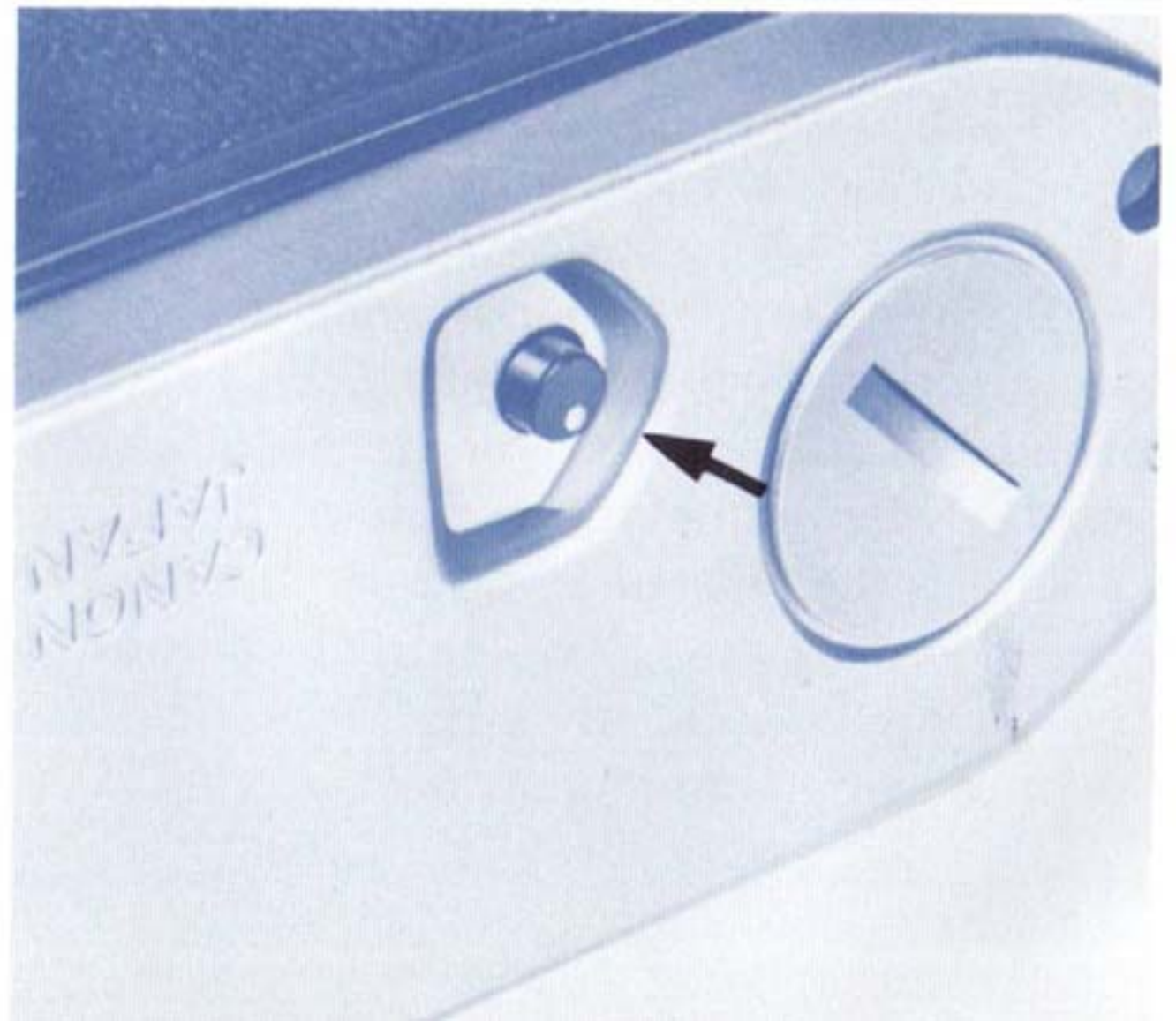
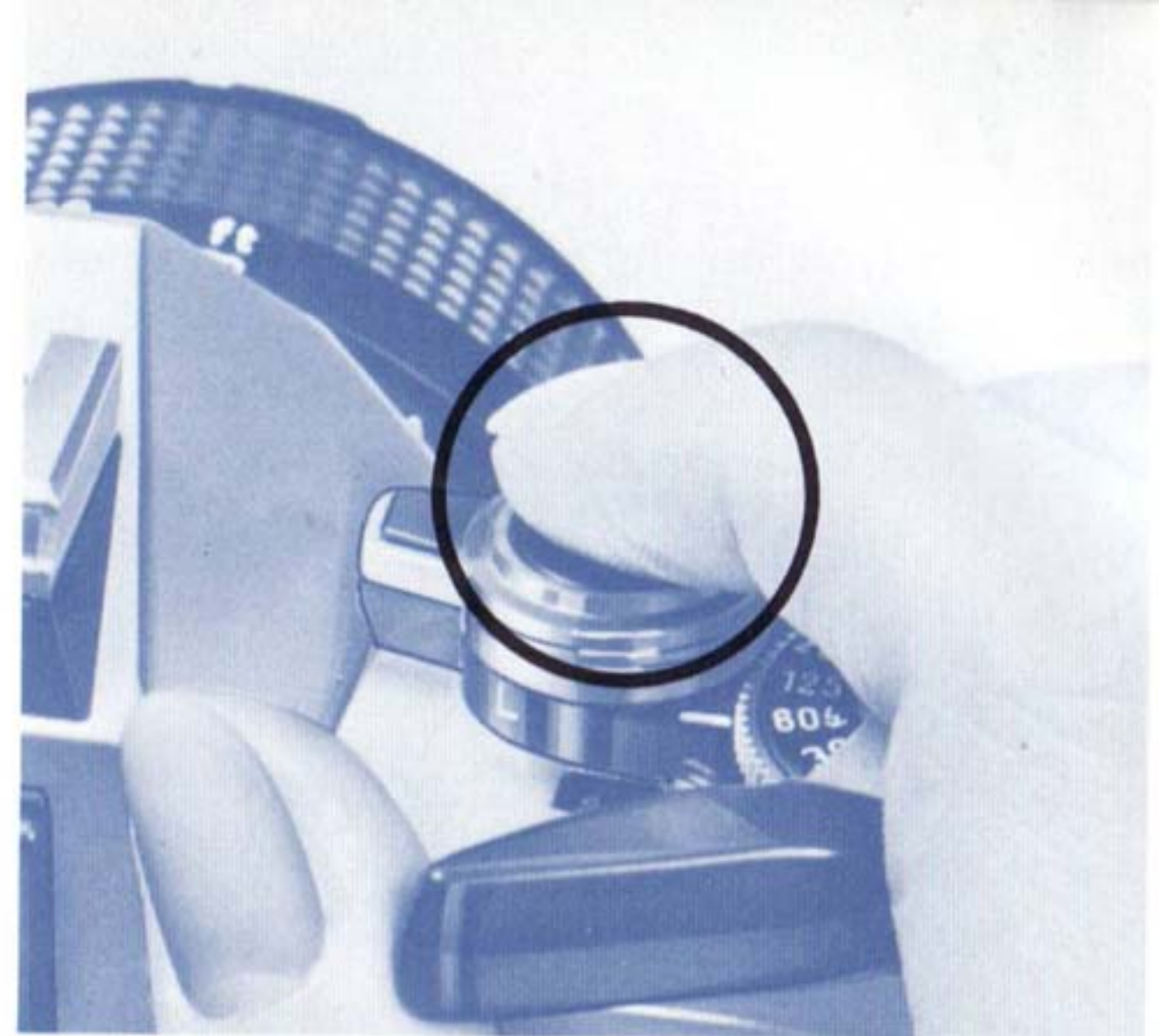

To rewind the film, press in the small rewind button on the bottom of the camera, unfold the rewind crank and turn it in the direction of the arrow on top of the rewind crank. When the frame counter has reached the "S" mark, you should stop rewinding. Then pull up the rewind knob to open the

camera back and lift the cartridge out.

If you stop rewinding the moment the frame counter has reached the "S" mark, the film will not be completely rewound into the cartridge and the film leader may still be outside the cartridge.

Double-Check Before Shooting

If you hurry to release the shutter, you may make an unexpected error due to carelessness.

The following points should be double checked:

1 Is the aperture ring of the lens set to the "A" mark?

Press in the EE lock pin while turning the aperture ring to the "A" mark. This specific setting is a requisite for beautiful color pictures with automatic exposure. If you fail to adjust the aperture ring to this setting when appropriate, the correct automatic exposure will not be obtained. When the aperture ring of the lens is not set to the "A"

mark, the manual aperture control "M" signal above the aperture scale in the viewfinder flashes on and off as a warning that the aperture ring is not set at the "A" mark. (See page 40.)

2 Did you set the film speed properly?

It is necessary to set the film speed properly according to the film in use in order to obtain the correct exposure.

3 Is the film properly loaded?

You can use the rewind knob as an indicator that the perforations of the film are properly engaged on the sprocket and the film is actually advancing. Every time you advance the film, the rewind knob should turn.

Detailed Operation of the AE-1

Up to this point you have been reading about the fundamental principles of AE photography. We ask you to continue reading through the following, more detailed description of AE photography for a fuller understanding. This information will prove helpful to you.

A silicon photocell is used as the photosensitive element in the camera. If you compare the silicon photocell (SPC) with

other existing photosensitive elements, you will find it covers a greater range of lighting situations and allows for greater accuracy. In order to provide the AE-1 with the best possible magnetic release system, Canon developed a special circuit for instantaneous light metering. Due to this innovation, even in place as dark as EV1 (at ASA 100, f/1.4, 1 sec.), metering can be performed in only 0.04 second.

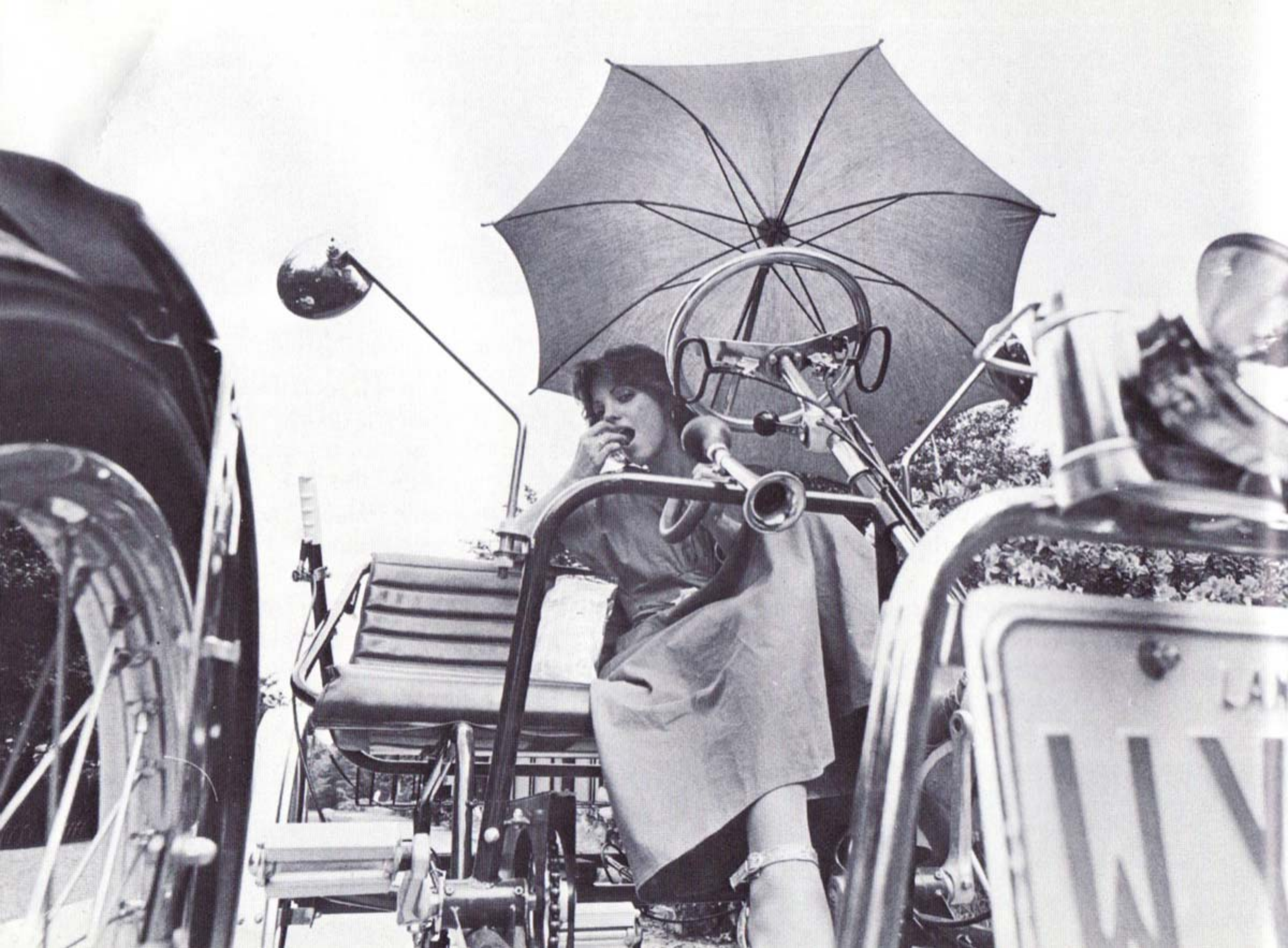

Viewfinder Information

In keeping with Canon's standard of providing all relevant information in an easily readable format, all information is displayed on the right side of the viewfinder. The diagram below indicates the information provided and where it can be seen in the viewfinder.

Meter Sensitivity Pattern

In a great variety of lighting situations, the carefully designed Central Emphasis Metering system simplifies problems to ensure that the subject is correctly exposed.

Metering Range

TTL metering is possible with a f/1.4 lens at ASA 100 from EV 1 (1 sec., f/1.4) to EV 18 (1/1000 sec., f/16).

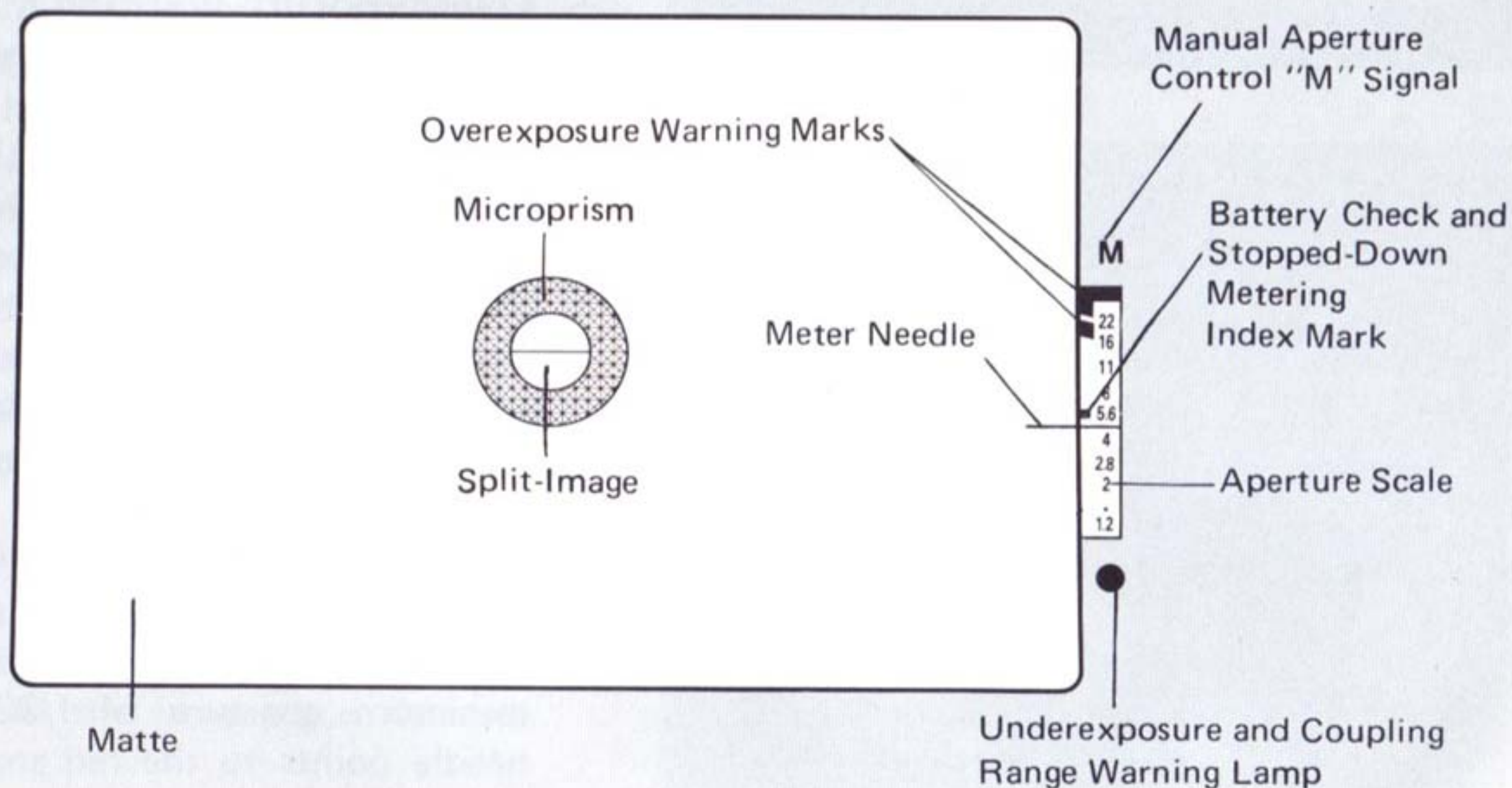

ASA Film Speed	Coupling Range
25 • 50	2 to 1/1000sec.
• • 100	1 to 1/1000sec.
• • 200	1/2 to 1/1000sec.
• • 400	1/4 to 1/1000sec.
• • 800	1/8 to 1/1000sec.
• • 1600	1/15 to 1/1000sec.
• • 3200	1/30 to 1/1000sec.

Shutter Speed and AE Coupling Range

The shutter speed and AE coupling range are indicated in the table. If any combination outside the coupling range is made, the coupling range warning lamp will blink, as it does when warning of underexposure. **Since the lamp serves a dual function, check that the shutter speed is within the coupling range before assuming that the light level is too low.**

Overexposure Warning Mark

When the lighting of the subject is too bright, the meter needle will rise into the red zones of the aperture scale. The red area is divided into two parts. The top part is a warning for use with a lens having a minimum aperture of f/22, while the bottom part is for use with a f/16 minimum aperture lens.

When the meter needle enters the red area, increase the shutter speed and correct the exposure.

With the FD 100mm f/4 S.C. Macro lens, which offers a minimum aperture of f/32 available, if you want to photograph at its minimum aperture of f/32 and the meter needle points to the red area, do the follow-

ing: Increase the shutter speed until the meter needle indicates $f/22$ and then decrease the shutter speed by one gradation so that the exposure will be correct.

Underexposure and Coupling Range Warning LED Lamp

This lamp blinks on and off as a warning of incorrect exposure. If you reduce the shutter speed by turning the shutter speed dial so the underexposure warning lamp will stop blinking, the correct exposure will be obtained.

Under dim light with a slow speed lens, there is a case when the meter needle will point at the aperture scale inside the viewfinder although it will exceed the maximum aperture of the lens. In this case, turn the shutter speed dial to a slower setting so that the underexposure warning lamp stops blinking.

For example, when you use an $f/2.8$ lens and the meter needle exceeds the aperture scale of $f/2.8$ inside the viewfinder, reduce the shutter speed until the lamp stops flashing.

When the shutter speed is set at "B" (Bulb) and the shutter button is pressed halfway, this warning lamp will also flash on and off.



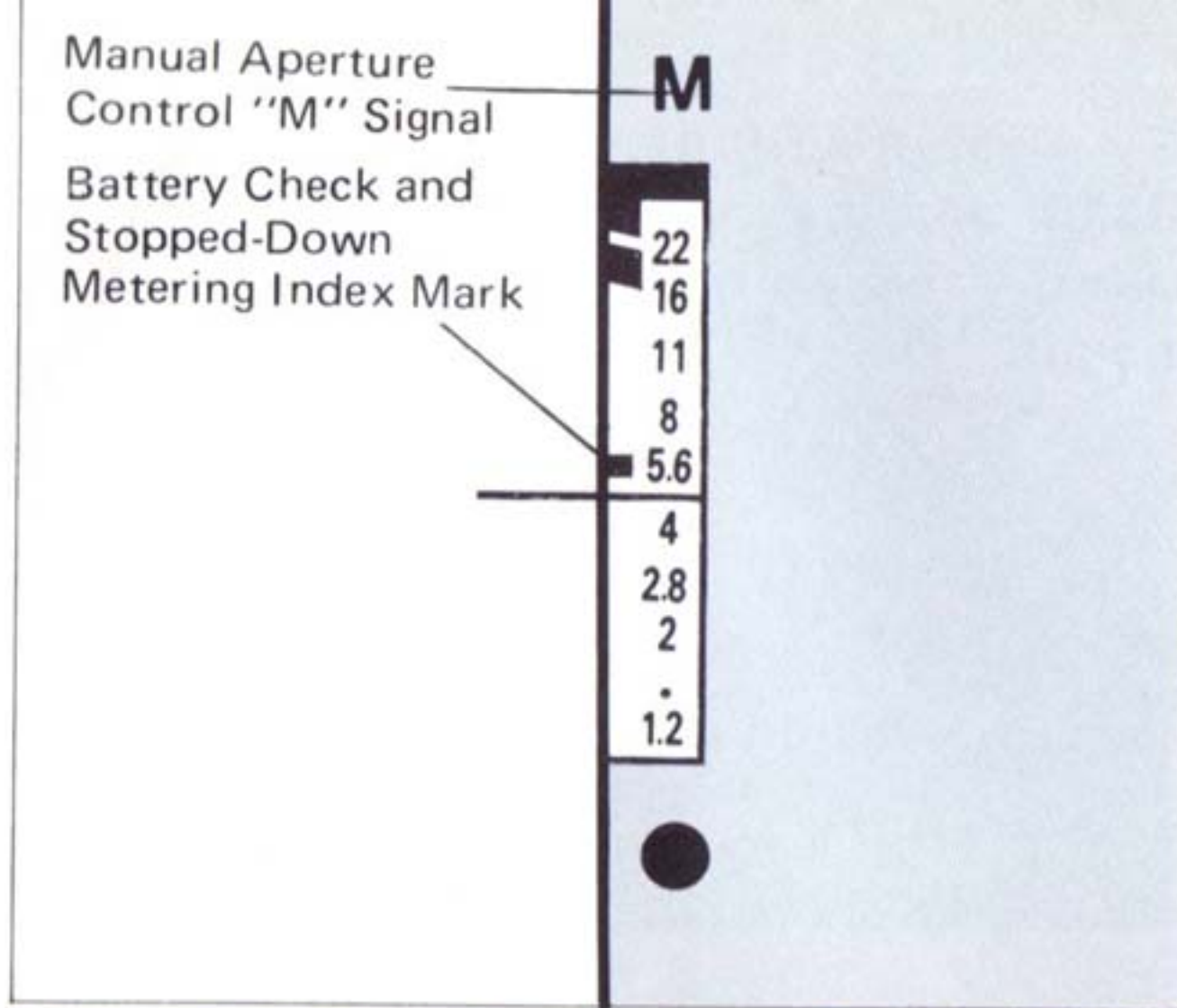

Battery Check and Stopped-Down Metering Index Mark

This battery check index mark serves also as the stopped-down metering index mark for use with Canon FL lenses and other similar manual lenses, when exposure measurement is performed with a stopped-down diaphragm. (See page 49.)

Manual Aperture Control "M" Signal (LED)

When the aperture ring is not set at the "A" mark, you cannot get the correct exposure in AE photography. When the aperture ring is set at any position other than the "A" mark, the manual aperture control "M" signal will blink as a warning. Also, when Canon FL lenses, Bellows or the like are used, this warning signal flashes on and off when exposure measurement is performed.



Concerning the Exposure (Shutter Speed and Aperture Coupling)

In order to obtain the correct exposure, it is necessary to correctly match the shutter speed with the aperture. The shutter speed and the aperture are the main factors in controlling the amount of light which is allowed to strike the film, and when they change, the quality of the image upon the film also changes.

1 Effects of Changing the Shutter Speed

The explanations below are pertinent to photography with fast moving subjects or when it is intended to convey the feeling of movement in a photograph.

If, as in example A, the photo is taken at a shutter speed of 1/250 sec., the movement will be frozen.

If, as in example B, with the same subject, the photo is taken at a speed of 1/60 sec. though the subject is somewhat blurred, movement is well expressed. It is only a matter of aesthetics as to which of these photographs is the best.

Depending on the selection of the shutter speed, you can freely control the expression of movement.





2 Effects of Changing the Aperture

Because this camera is an AE camera with shutter speed priority, when you change the shutter speed, the aperture will also change. If you change the speed by one gradation, the aperture also changes the equivalent of one gradation. Aperture changes have an effect on the photographic expression as follows:

In example C, the aperture was set at $f/1.8$ with the shutter speed dial adjusted before shooting. In example D, a $f/16$ setting was used to clearly demonstrate the difference. In C, the chesspieces in the back and front are blurred and only the chesspiece in the center is in focus. In D, most of the chesspieces are sharp and clear and only those in the back are blurred. Thus, the lens aperture controls the zone of sharpness in the subject field which is observed in the viewfinder or recorded on the film.

Aperture Priority Photography

After having given careful thought to the results of aperture adjustments, when the f /stop has been determined before shooting, press the exposure preview switch while looking into the viewfinder. Then turn the

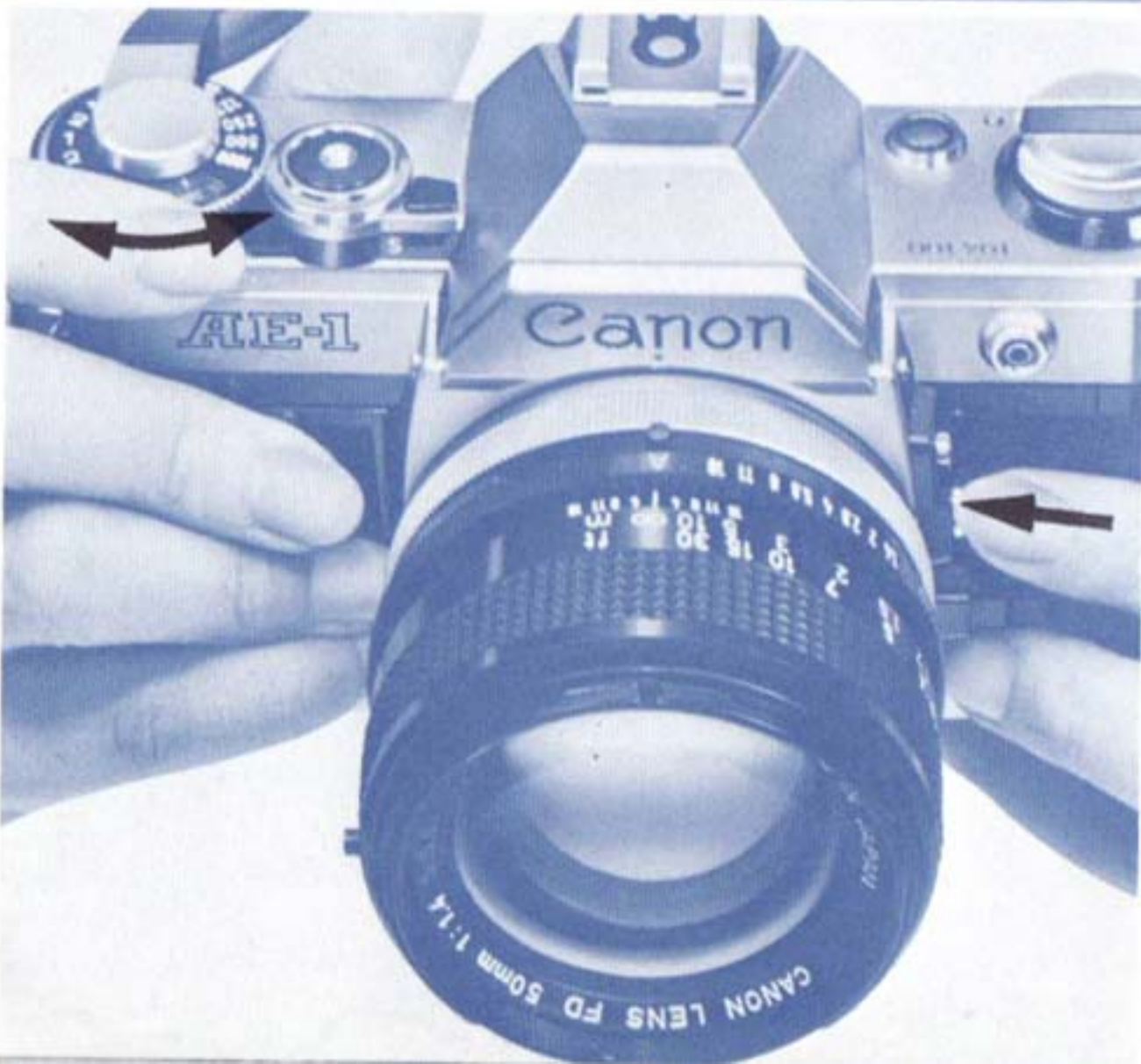

shutter speed dial until the meter needle on the right of the viewfinder reaches the f/stop desired.

Depth-of-Field

When a certain subject is brought into focus, there is only a limited range in the foreground and background of the subject which can be kept clearly in focus. This zone of sharpness in the subject field is depth-of-field.

There are two methods of confirming the extent of the depth of the field: by stopping down the lens diaphragm or by reading a value from the depth-of-field scale on the lens.

1 Confirming the Depth-of-Field by Stopping-Down the Lens Diaphragm

1. Wind the film and take an exposure reading for the subject you wish to shoot.
2. Move the aperture ring off the "A" mark and then set the aperture ring to the aperture indicated in the viewfinder during the exposure reading (or to the desired aperture).
3. Press the stopped-down lever until it locks. Look into the viewfinder to visually check the depth of field.

■ Stopping-down the FD lens should only

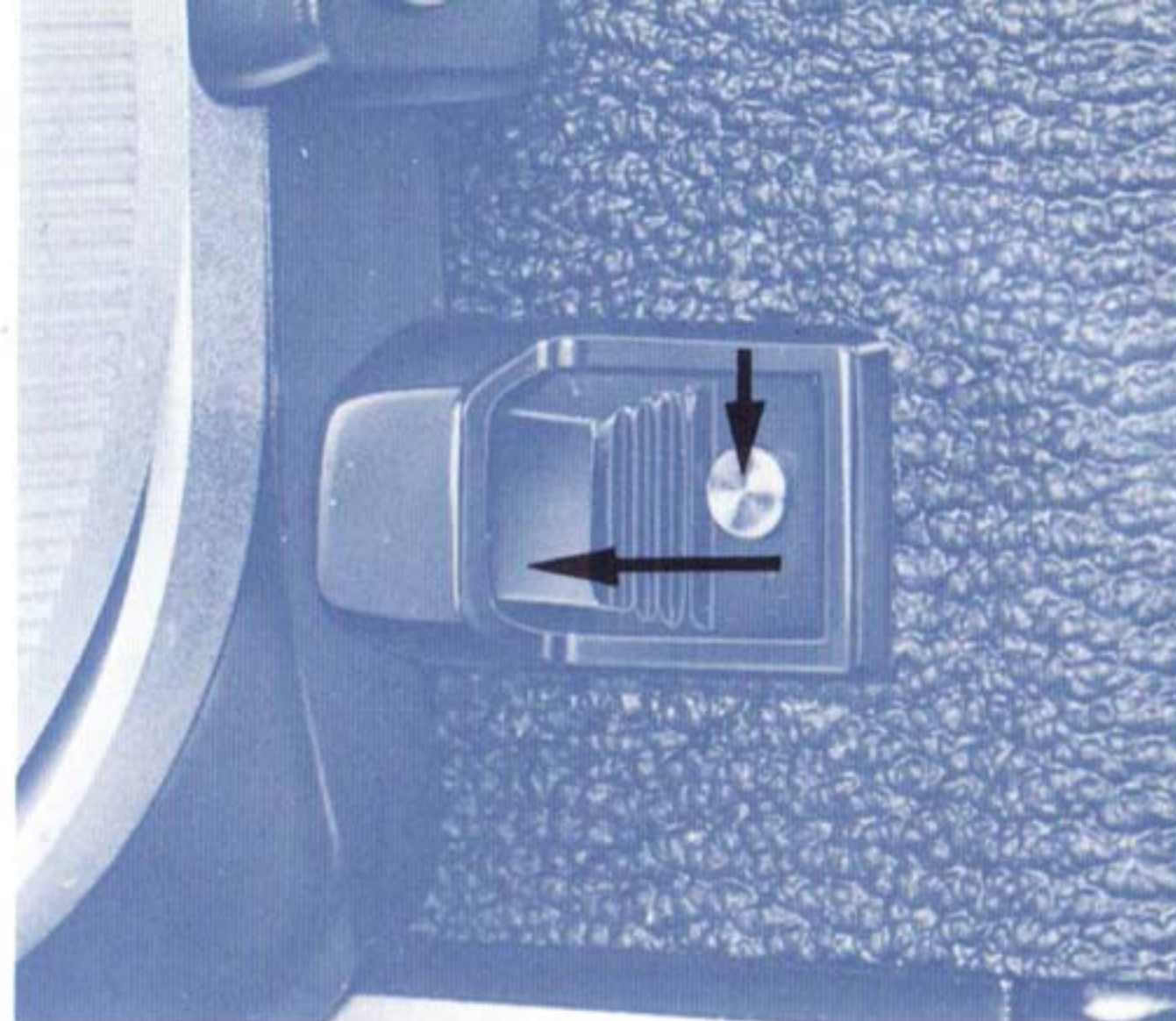

be done after advancing the film. If the film is not advanced, the stopping-down of the lens diaphragm would only be possible down to the aperture of the previous exposure. Also, when the aperture ring is set at the "A" mark, the stopped-down lever cannot be pressed in. Please note that stopped-down metering is impossible when the FD lens is mounted on the AE-1.

4. To cancel the stopping-down of the lens, press the stopped-down lever's release button.
5. Be sure to turn the aperture ring to the maximum aperture before resetting it to the

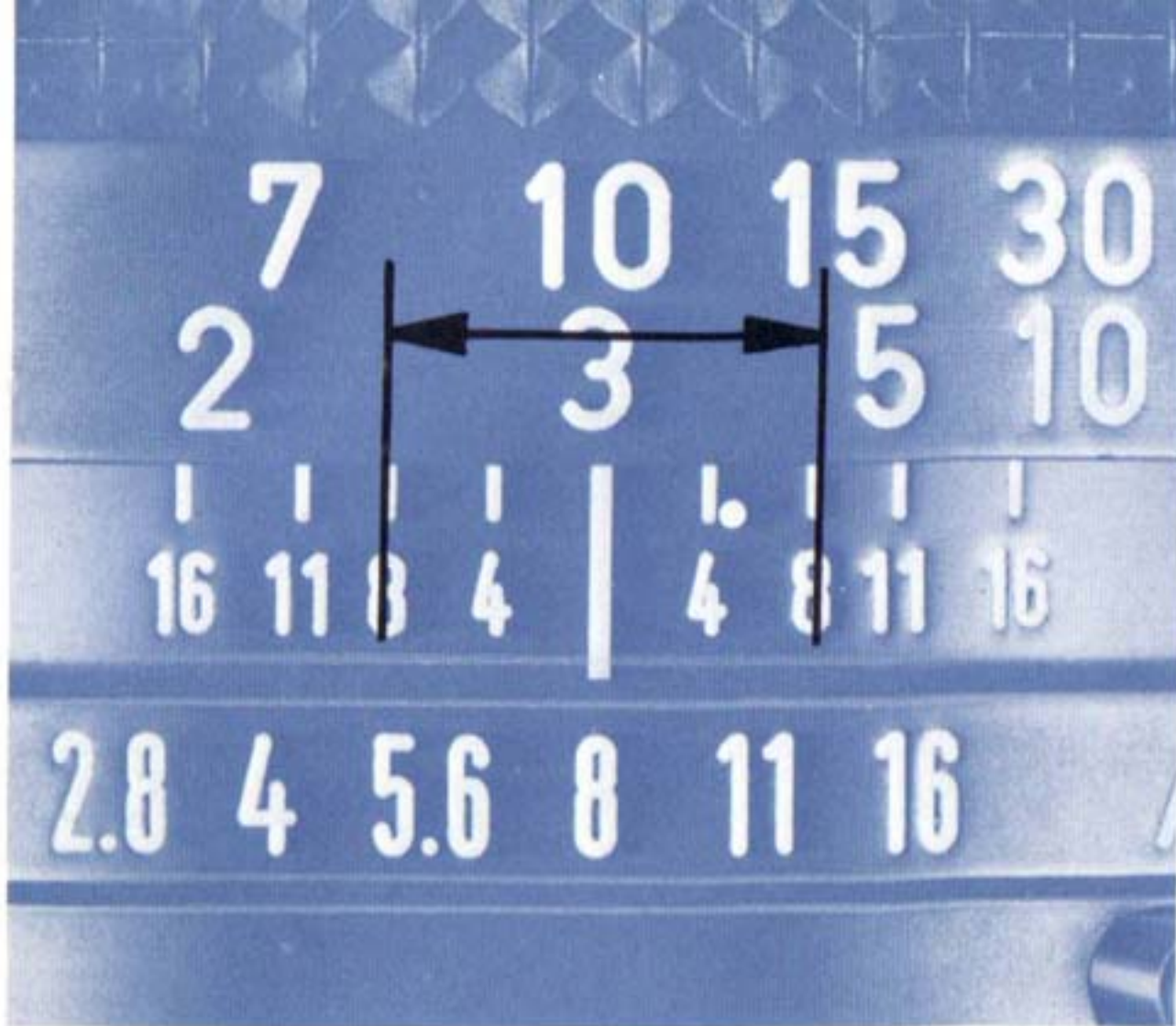

“A” mark.

This is because the aperture value is stored in the AE circuit as a result of stopping-down the lens, and you will end up getting incorrect automatic exposure for the next shot, if you fail to do that.

Generally, the depth-of-field will become deeper as the aperture becomes smaller, and shallower as the aperture becomes larger. A shorter focal length as well as a greater subject distance will also deepen the depth-of-field.

Comparing an interchangeable 28mm lens with a standard 50mm lens set at the same

f/stop, the 28mm lens’s depth-of-field will be greater. And when the photographic distance changes, the depth-of-field changes, too. For example, if the same subject is photographed from three and then from seven meters away, the foreground and background of the subject will be deeper at the greater distance.

2 Depth-of-Field Scale on the Lens

A depth-of-field scale is engraved on the lens barrel, shown as a series of f/numbers on each side of the distance index mark opposite the distance scale. Focusing and depth-of-field are so closely interrelated that the depth-of-field scale is engraved together with the distance scale.

You can tell the extent of depth-of-field from the distance scale. For example, if you use the camera with a standard 50mm lens that is focused on a subject at medium distance, say 3m with the aperture set at f/8, the depth-of-field extends from 2.4m to 4.5m. This tells you that with the 50mm lens focused at 3m and the subject between 2.4m and 4.5m the film image will be reasonably sharp.

Shooting Against the Light with the Backlight Control Switch

In most cases, the Canon AE-1's Central Emphasis Metering system will give correct exposure readings in AE photography. However, you will occasionally encounter situations in which normal AE photography would not provide a correct exposure reading of the main subject. For example, when you photograph a person standing in a room with a brightly lit window at his back, the subject will be underexposed. In order to properly expose the main subject, the backlight control switch is provided. When it is held in as the shutter is released, the aperture is automatically opened up by one and a half f/stops more than normal.

Manual Override

You may occasionally wish to override the camera's AE control to compensate for unusual lighting conditions, such as in taking high-key, low-key or backlit shots. This is possible by disengaging the aperture ring of the FD lens from the "A" mark and turning the ring to the aperture you wish to use for

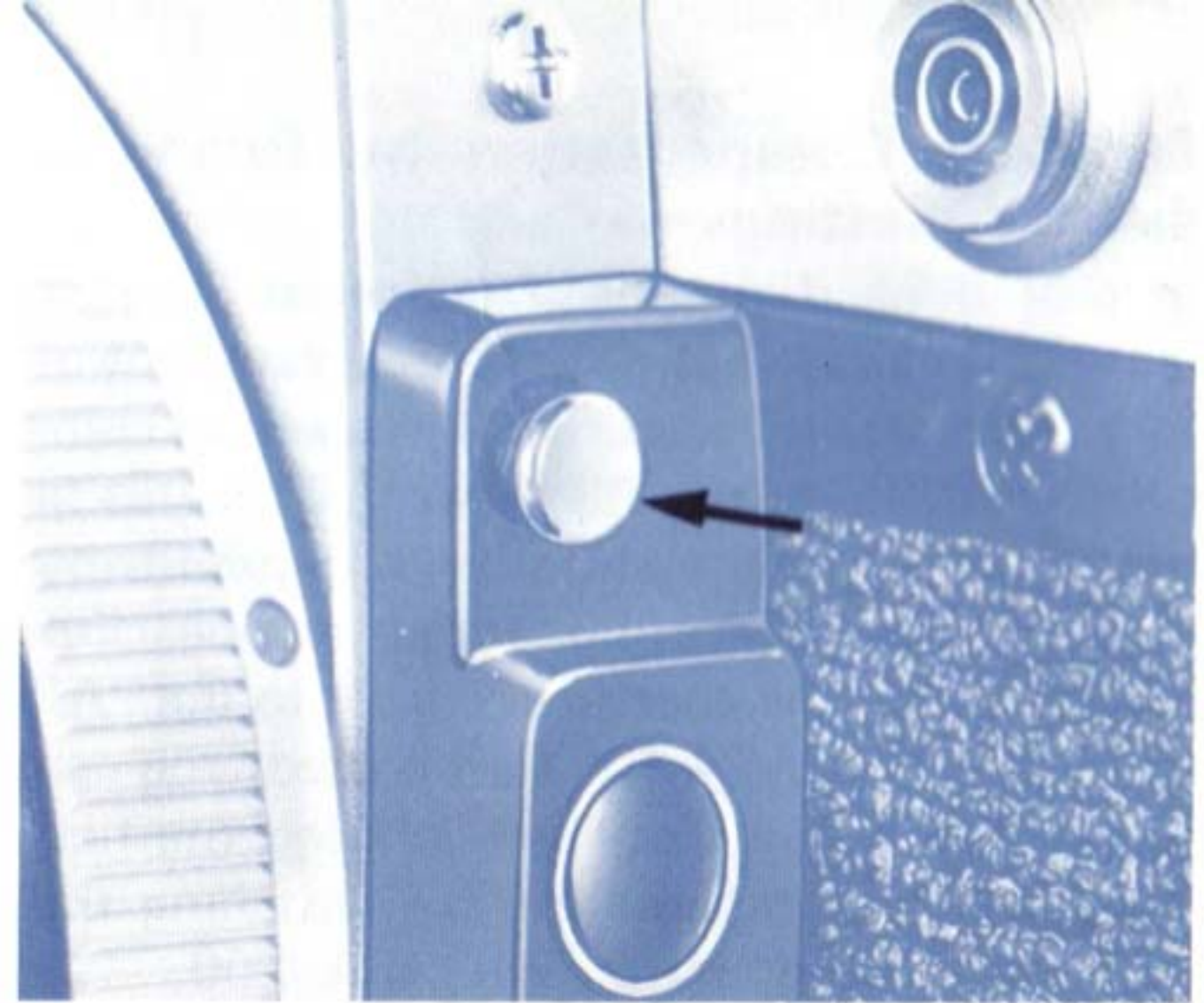

desired exposure compensation. When you take an exposure reading either by pushing the shutter button halfway or by using the exposure preview switch, the meter needle in the viewfinder will show the aperture the camera would use on Auto.

To switch back to Auto, simply reset the aperture ring to the "A" mark while pressing the EE lock pin.

Exposure Compensation by Changing the ASA Setting

An ASA film speed twice as fast as another denotes that only half the amount of light is necessary for correct exposure as compared with the other film speed. With this in mind, you can compensate for exposure by changing the ASA film speed setting. For example, with the aperture ring set to the "A" mark, when an ASA 400 film is used, you can double the amount of light striking the film for exposure compensation by switching the ASA film speed setting to ASA 200.

Using the Self-Timer

Obvious uses for the self-timer are self-portraits and the inclusion of the photographer in the picture. The self-timer, though, can also be used in place of a cable release to release the shutter gently and smoothly in close range work like photomicrography or copying.

Push the electronic self-timer lever forward, then press the shutter button, and the shutter will be released 10 seconds later. The camera memorizes the exposure value the very instant the self-timer is activated by

pressing the shutter button. While the self-timer is in operation, the self-timer lamp flashes on and off.

After you finish taking a picture, the self-timer lever should be reset to its original position. Otherwise, it will function again the next time you press the shutter button. Exposure will be automatically determined at the instant the shutter button is pressed, and not when the picture is actually taken. Therefore, avoid standing directly in front of the lens when you press the shutter button as the AE control may miscalculate exposure.

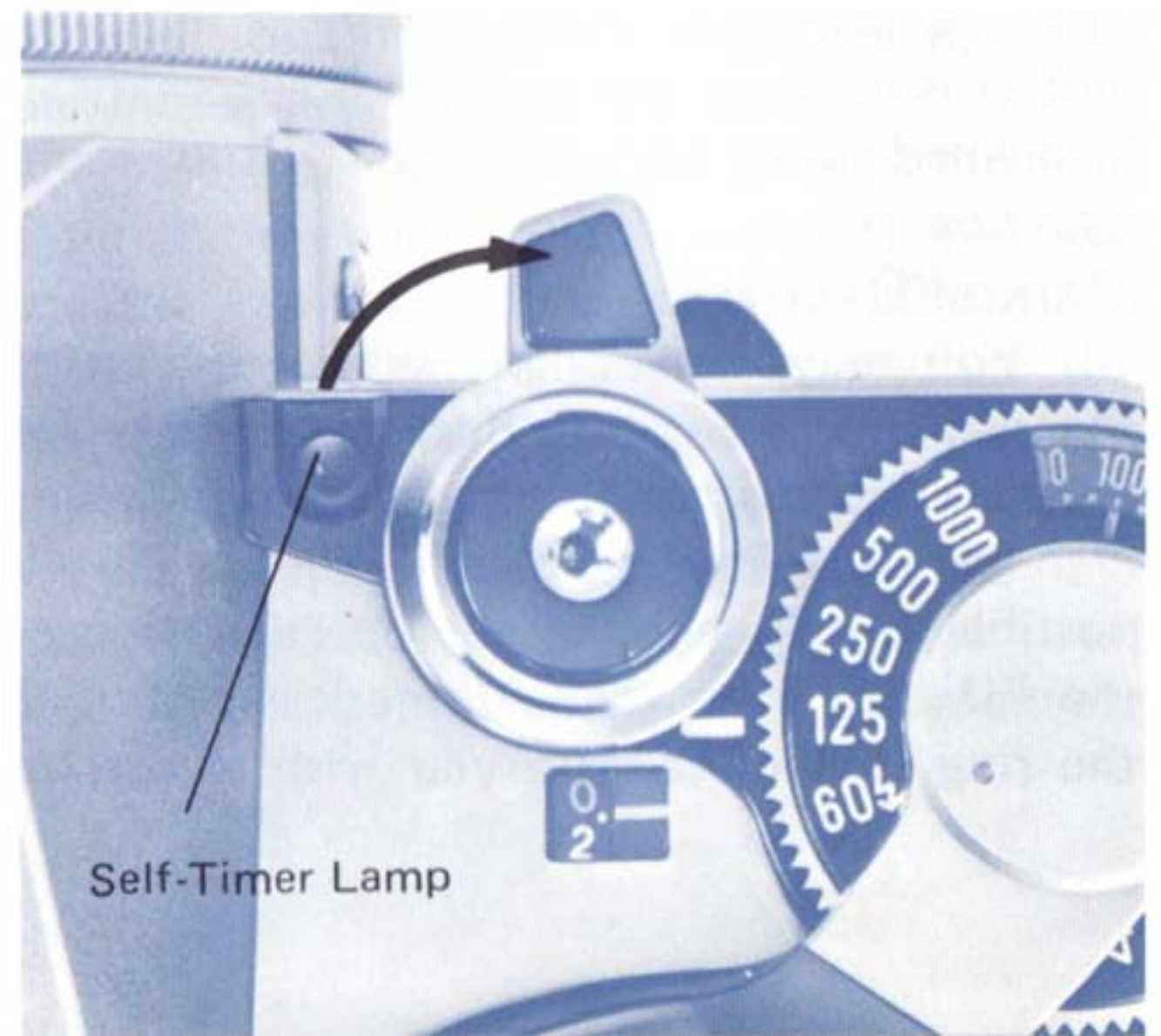

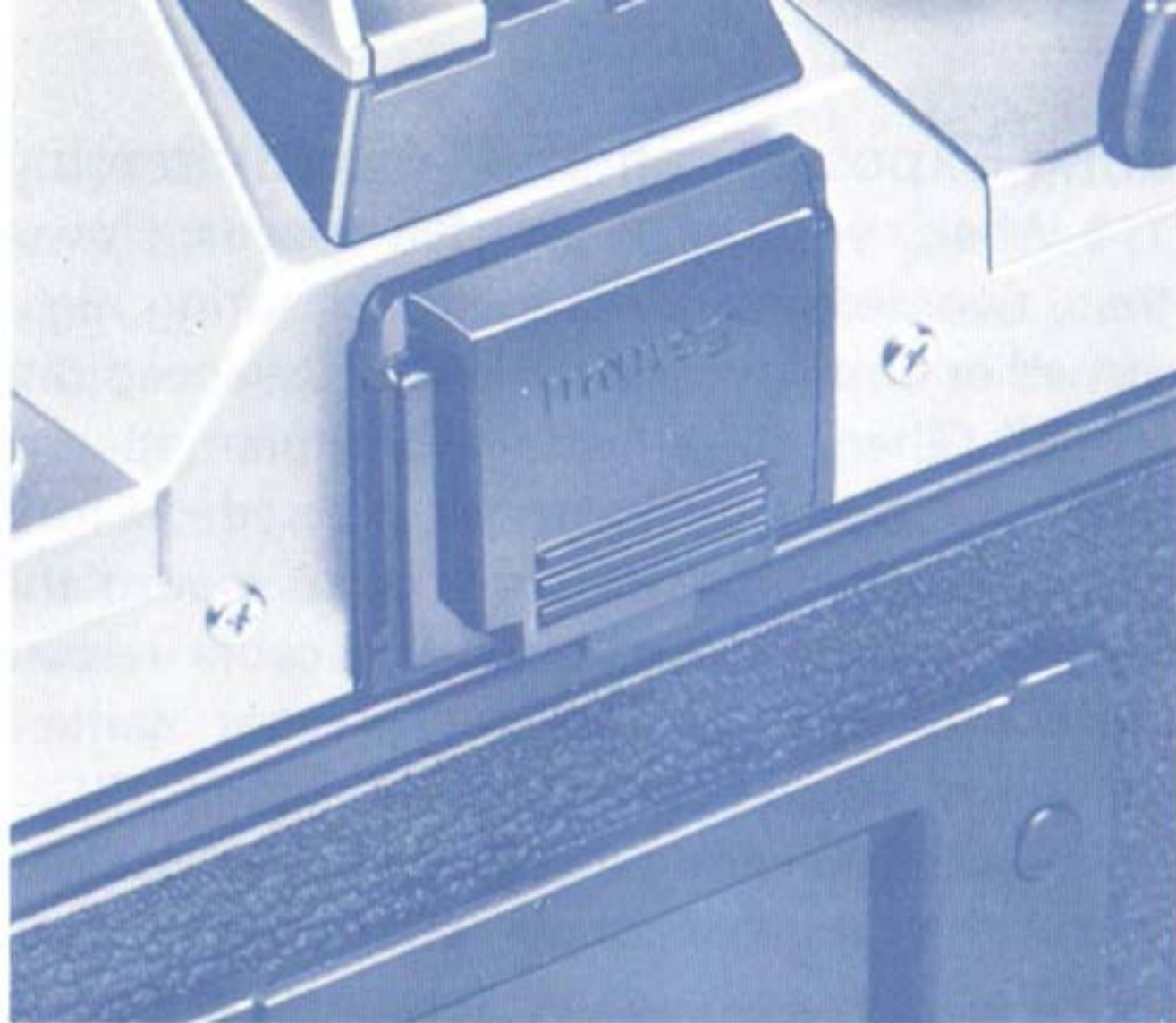

To prevent stray light from entering the viewfinder from the rear and possibly affecting the meter reading, it is a good idea to cover the eyepiece with the viewfinder cover which is inserted into the accessory shoe. This cover can be attached to the holder on the viewfinder eyepiece. After doing so, press the shutter button.



Cancelling the Self-Timer Operation

If you should want to cancel the self-timer operation after having pressed the shutter button, depress the battery check button on the top side of the camera. Then, the self-timer lamp stops blinking and the self-timer operation will be cancelled.

If the battery check button is not depressed and the self-timer lever is returned to its original position, the shutter will be released.

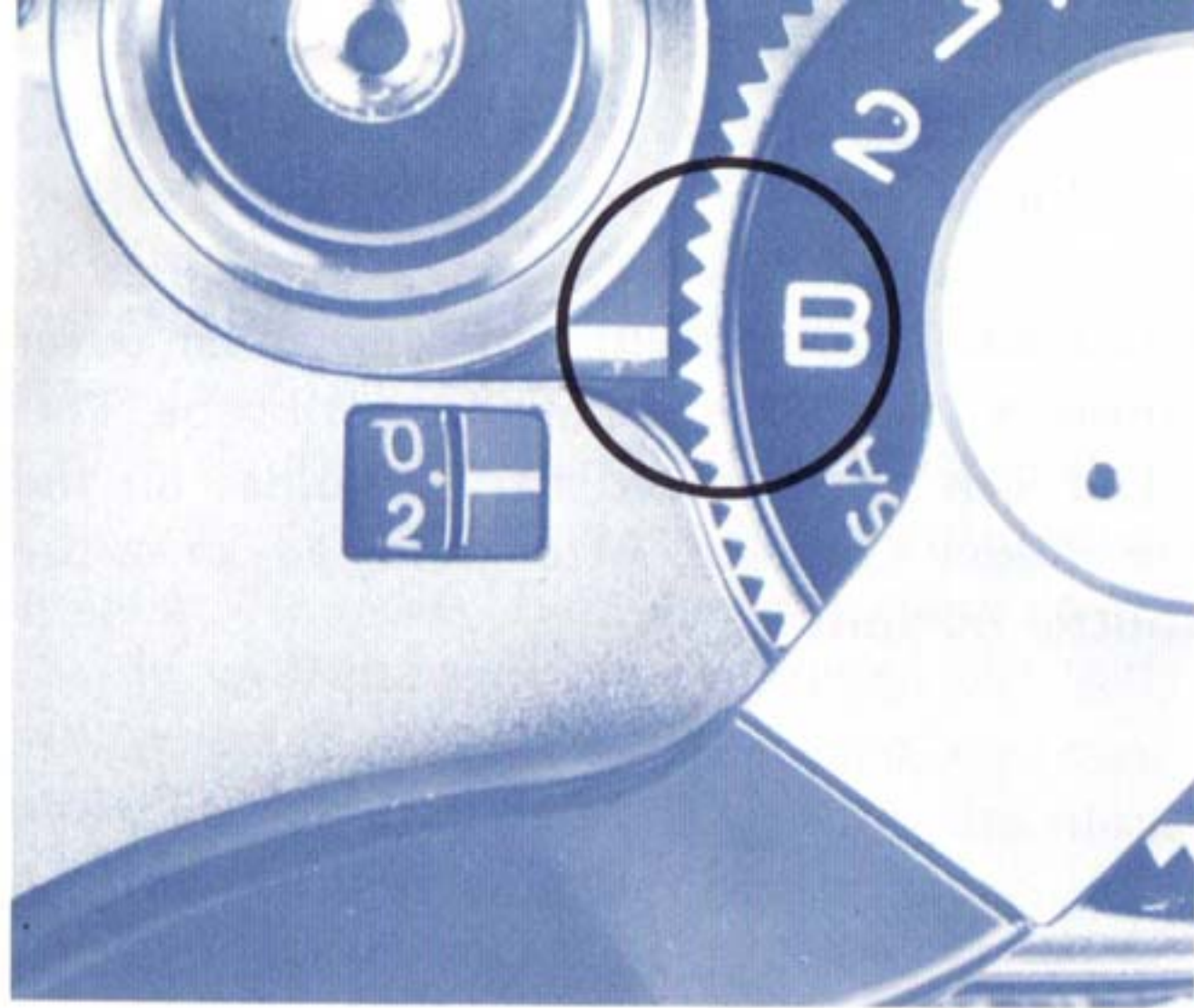

Long Exposures and “B” (Bulb) Setting

When you need shutter speeds slower than two seconds such as for shooting night scenes or fireworks, set the shutter speed dial at “B”. Then, the shutter will remain open as long as the shutter button is pressed. In long exposures, it becomes essential to mount the camera on a tripod and use a cable release preferably with a lock to prevent camera shake and attain best results.

A cable release with a locking device can keep the shutter open even though the operator leaves the cable release unattended. Unlock the cable release when the shutter should be closed.

Photography using the “B” setting will accelerate battery consumption since it requires continuous battery power. When necessary, the battery should be replaced with a new one having a full charge.

Stopped-Down Metering

When the AE-1 is used with Canon FD lenses, photography can be performed with through-the-lens (TTL) metering and with AE coupling. However, with the Canon FL lenses and most accessories such as bellows, extension tubes, or a microscope adapter, it is necessary to take a stopped-down meter reading.

Stopping down the lens can be done by pushing the stopped-down lever until it locks. When the lens is stopped-down, press the shutter button halfway or depress the exposure preview switch and adjust the aperture ring and/or shutter speed dial until the meter needle inside the viewfinder is aligned with the stopped-down metering index mark.

Press the shutter button and the photograph will be perfectly exposed. **If the lens should be mounted on the camera with the stopped-down lever locked, correct exposure will not be obtained.** In this case, a red warning mark by the stopped-down coupling lever inside the camera body is visible. After removing the lens, on the lower part of the camera body, just below the mirror, this

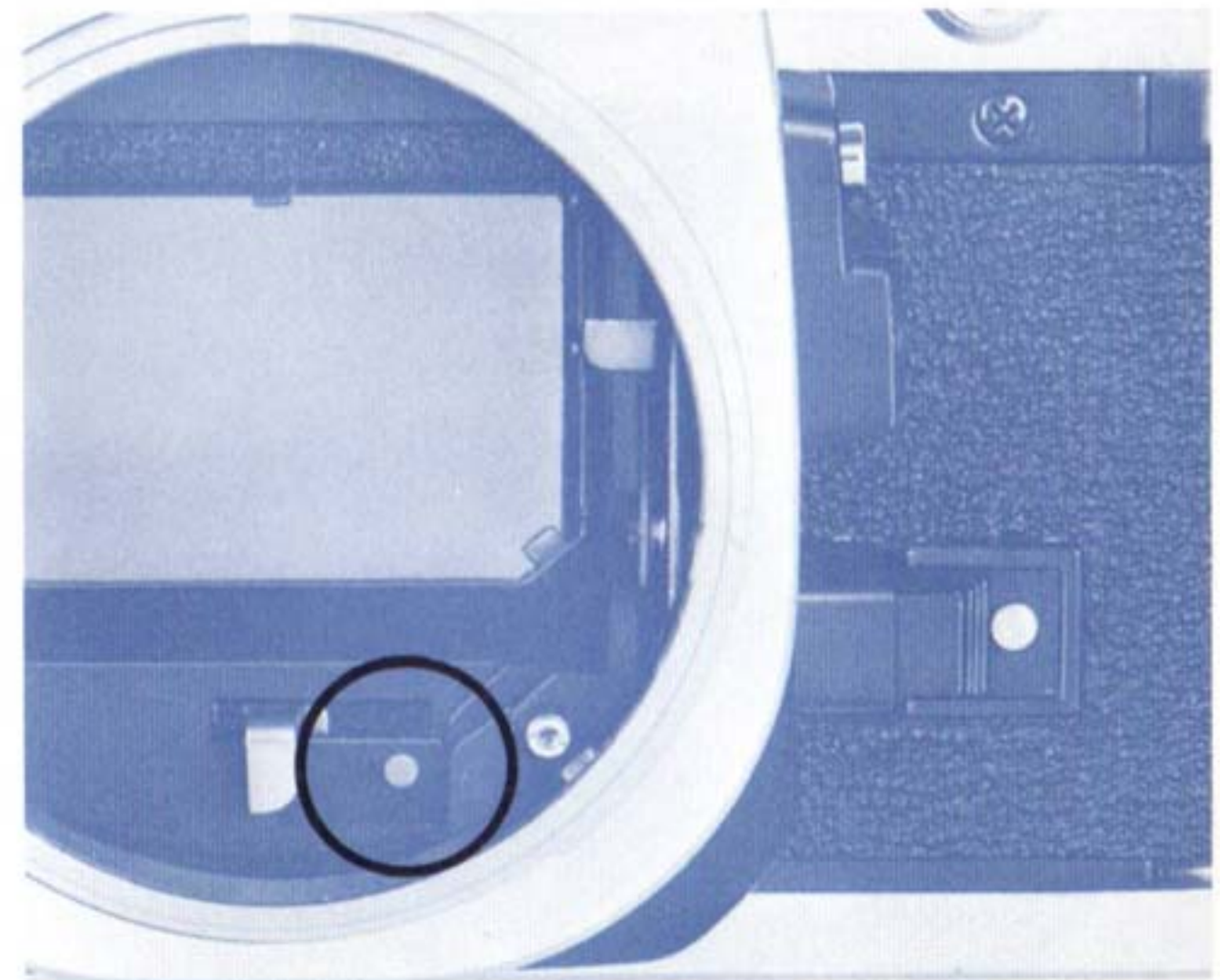

stopped-down coupling lever becomes visible, as does the red mark in the case described above.

When FD lenses are directly mounted on the AE-1, metering should always be done at full aperture. Stopped-down metering would give the wrong exposure. The only exception to this rule is the use of non-coupled accessories between lens and camera body.

Manual Aperture Control

When accessories requiring manual aperture control are used between the camera body and a lens, lock the automatic aperture lever in the manual position before mounting the lens.

1 Lock for Manual Aperture Control (1)

For manual aperture control, push the automatic aperture lever counterclockwise until it stops and locks. When accessories such as extension tubes are attached to a lens that has been set for manual control, the diaphragm blades of the lens open or close as the aperture ring is turned. To revert from manual control, reset the automatic aperture lever in its original position.

2 Lock for Manual Aperture Control (2)

There are some FD lenses with the manual lock lever requiring a different procedure for manual control setting. With these particular lenses, the automatic aperture lever must be turned fully counterclockwise while the manual lock lever is brought to the "L" position. Once this has been done, when the



lens is mounted on the camera, the diaphragm blades will open or close by turning the aperture ring. To revert from manual aperture control, reset the manual lock lever at the position of the white dot.

3 Lock for Manual Aperture Control When Using the Macrophoto Coupler (3)

In close-up photography of high magnification with a lens reversed on the Macrophoto Coupler, the automatic diaphragm mechanism is not coupled. You must, therefore, remember to close down the diaphragm manually after having locked the automatic aperture lever in the manual position as explained above in (1) and (2). Then, fix the Macrophoto Hood on the lens mount by turning the bayonet ring.

When you are taking stopped-down meter readings, the manual aperture control "M" signal above the aperture scale inside the viewfinder flashes on and off only when the shutter release button is depressed halfway.



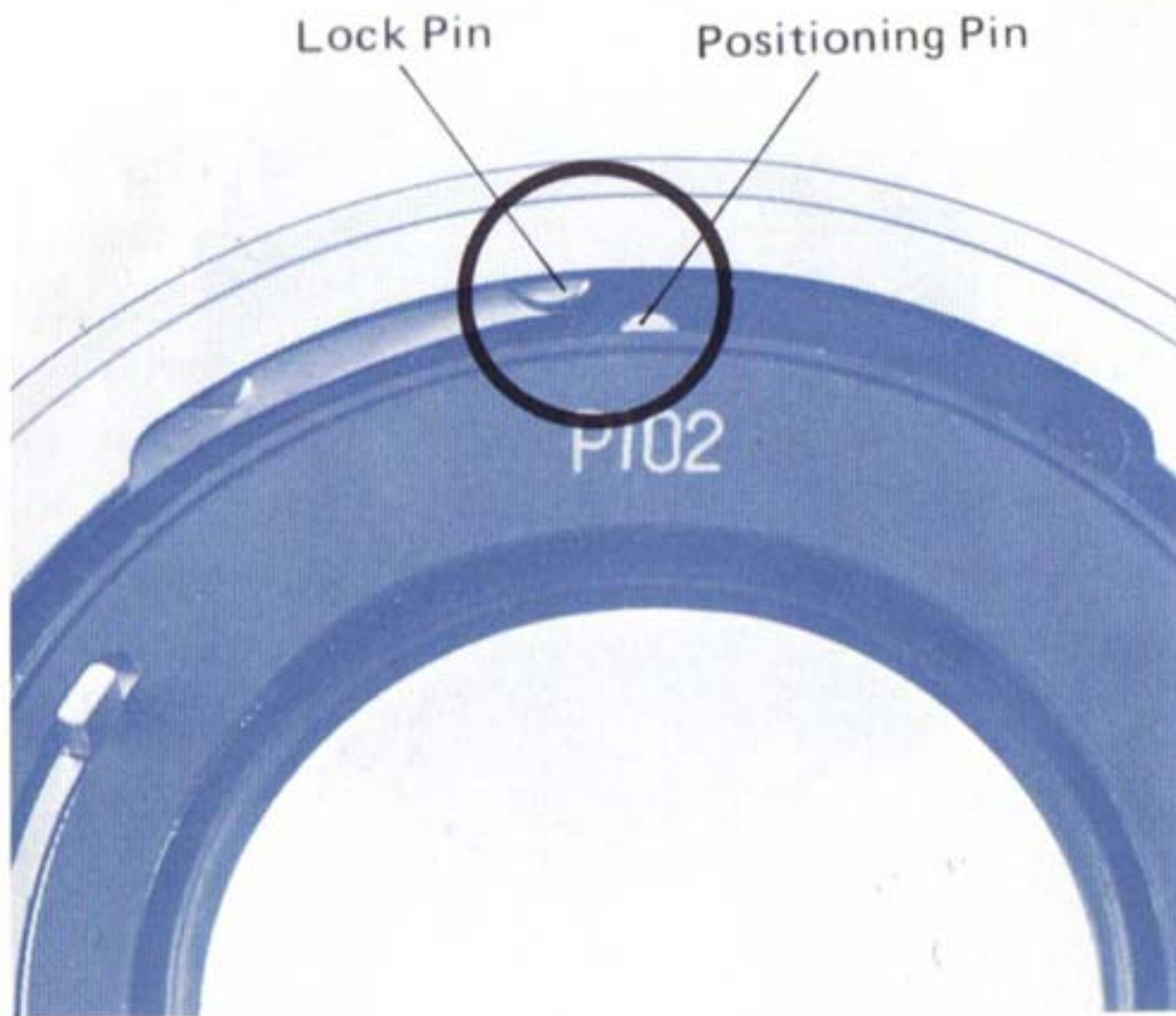

Changing the Lens

FD lenses incorporate a safety mechanism to prevent the bayonet ring and the diaphragm blades from moving when the lens is not mounted on the camera. To bypass this safety mechanism, press the lock pin in the top recess of the bayonet mount while turning the bayonet ring. Once this safety mechanism has thus been cancelled, you can see the diaphragm blades move when activated.

Since FD lenses have signal pins and levers which couple with the camera body, special care must be taken not to damage them. One basic precaution is to always put the lens down facing down whenever you must change lenses.

The following lenses can be mounted but for technical reasons cannot be used with the camera's built-in meter.

FL 19mm f/3.5	R 35mm f/2.5
FL 35mm f/2.5	R 50mm f/1.8
FL 50mm f/1.8	R 100mm f/2
FL 58mm f/1.2	

These lenses should only be mounted on the camera after the film has been advanced.

Lens Signal Coupling

Aperture Signal Lever

This lever transmits the actual f/stop to the exposure meter. It is coupled to the aperture ring.

Full Aperture Signal Pin

This pin transmits a signal indicating the maximum aperture of the lens.

Automatic Aperture Lever

This lever closes down the aperture, coupled with the stopped-down coupling lever.

EE Switch Pin

This pin protrudes when the aperture ring is locked at the "A" mark. In this position, it transmits a signal for AE photography.

Reserved Pin

This pin is designed for use with accessories that may be developed in the future.

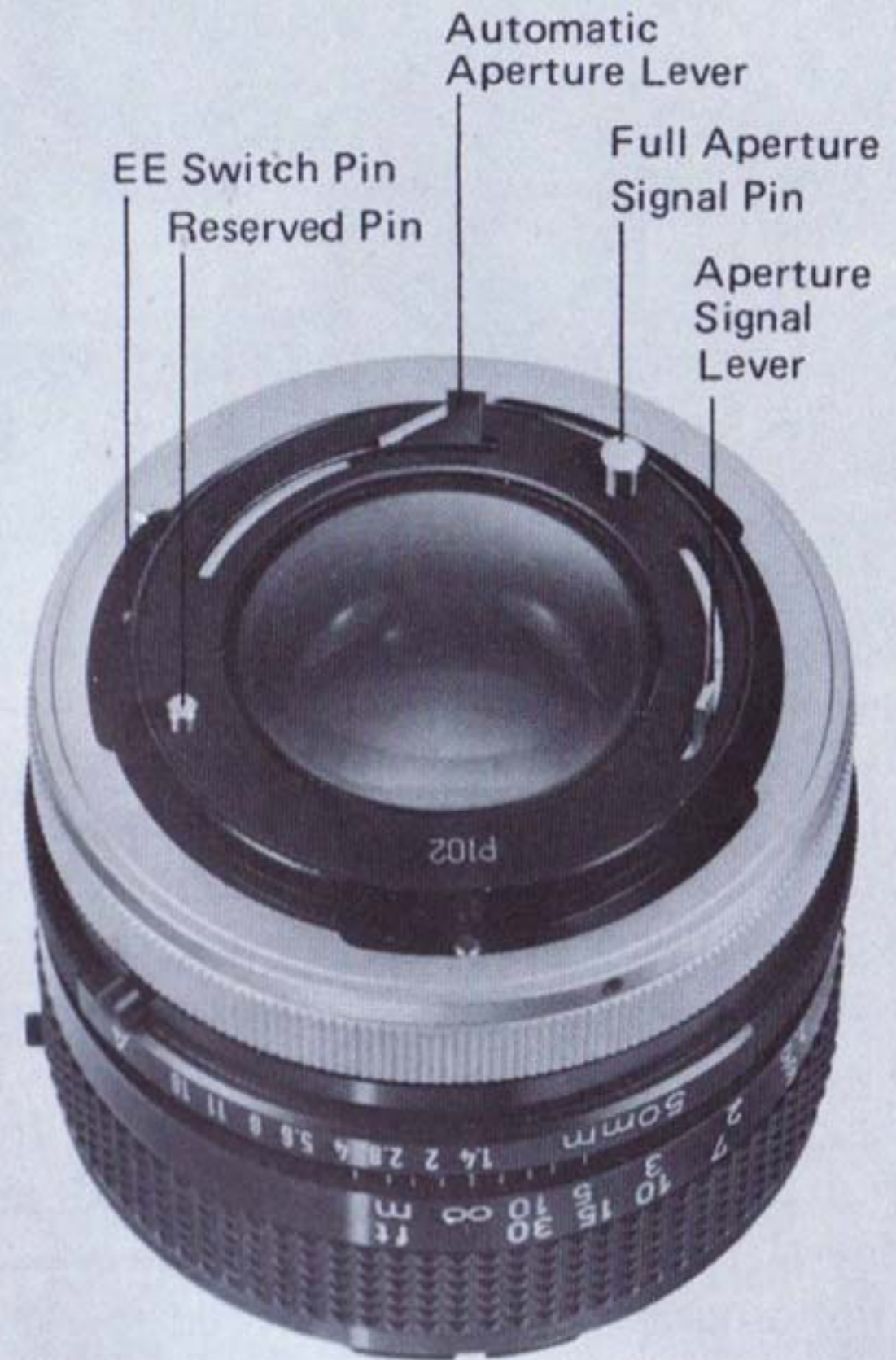



Film Plane Indicator

This mark is engraved on the top of the camera between the film rewind crank and the battery check button, just to the left of the pentaprism, to indicate the exact position of the film plane. The distance scale on the lens shows subject distances measured from the film plane indicator. This mark is not used in general photography, but in close-ups and macrophotography it is often used to obtain the exact subject distance.

Scales on the Lens

Aperture Scale

The aperture of the lens is the opening of the diaphragm blades, like the iris of the human eye. It controls the amount of light passing through the lens to the film surface.

The f/number is a numerical expression of the effective aperture. It is obtained by dividing the focal length of the lens by the diameter of the effective aperture. When the f/number is set one scale gradation higher, the lens allows in half the light it would at the previous gradation. Intermediate settings of the aperture scale can be used, too. In some lenses, the f/number setting one gradation higher than the first f/number setting does not necessarily allow only half the amount of light of the previous setting through the lens to expose the film as is the case at the other settings. This should be taken into consideration when necessary.

The aperture ring usually has gradations marked as follows, taking f/2 as a basic unit:

Brightness (f/stop)	1.2	1.4	2	2.8	4	5.6	8	11	16
Ratio	3	2	1	1/2	1/4	1/8	1/16	1/32	1/64

Distance Scale

The distance scale is for distances measured from the film plane. This scale is not generally used except for confirming the depth-of-field, performing guide number calculations in flash photography, or photographing with infrared film.

Read one-digit distances in the middle of the number marked on the scale. Two-digit distances should be read at the point in the middle of the two digits.

Depth-of-Field Scale

You can determine the depth-of-field by checking the depth-of-field scale and the distance scale on the lens barrel. Both are closely interrelated.

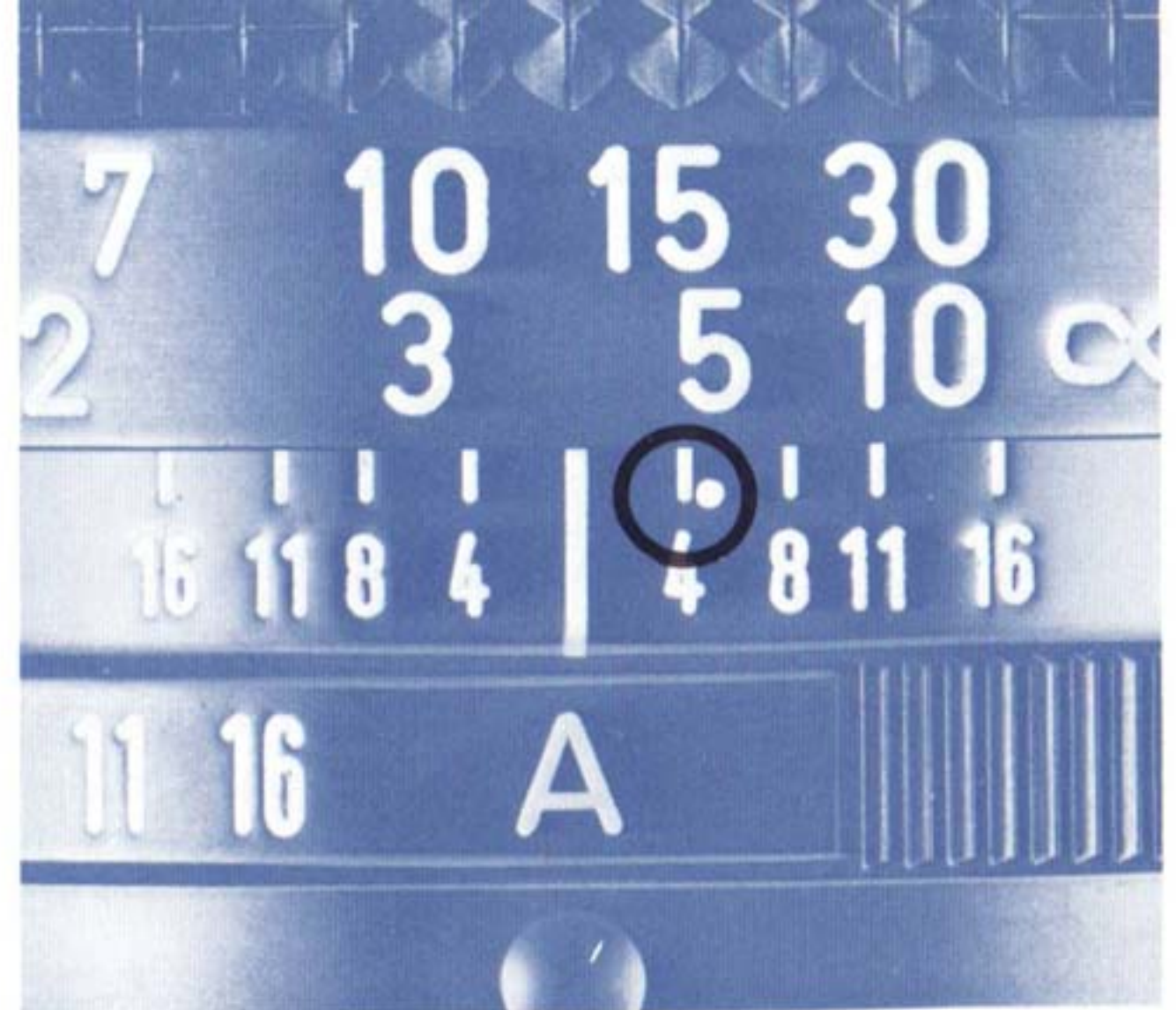

Infrared Index Mark

The red dot infrared index mark engraved on the lens barrel is a focusing correction index mark for infrared film. Because infrared light rays have longer wavelengths, they focus on a plane slightly behind that of ordinary visible light rays. Therefore, it is necessary to slightly modify the normal method of focusing the lens. After focusing the same as usual, note the tiny red dot engraved on the lens barrel just to the right of the distance index and turn the focusing ring slightly to align the

focused distance with this red dot.

For instance normally, when the focus is adjusted at 5m on the distance scale, you turn the focusing ring slightly so that the 5 on the distance scale matches the red dot infrared index mark.

When photographing with infrared black and white film, visible light rays must be kept out by means of a deep red filter (R1) over the lens. The position of the infrared index mark is fixed for infrared film most sensitive to the $800\text{m}\mu$ wavelength and use of a red filter. For example, the Kodak Film IR 135 and the Wratten Filter 87.

Please follow the directions of the specific instructions of the film manufacturer when performing infrared color photography.

**Accessories, Care of the Camera,
Maintenance and Miscellanea**

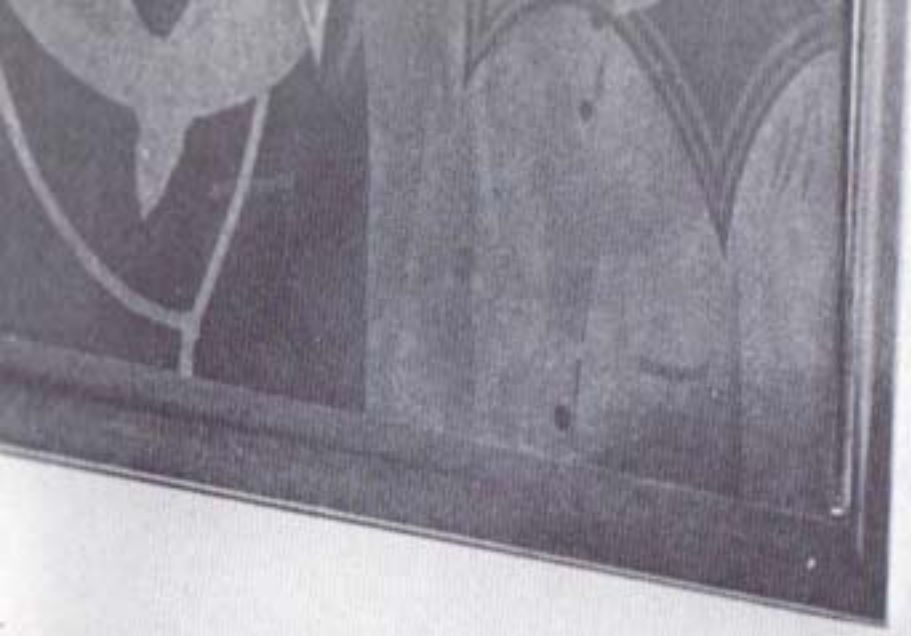

Canon Speedlite 155A

The versatile circuitry of the Canon AE-1 allows it to perform fully automatic flash photography with the Speedlite 155A especially designed for this camera. It is not necessary to set the shutter speed or the aperture on the camera as, up to now, flash photography required.

When the 155A is attached to the AE-1, set the aperture ring of the lens to the "A" mark and the shutter speed dial to any position other than "B" (Bulb). With the pilot lamp of the 155A lighting up, the 155A functions to automatically adjust the camera's shutter speed to the X synchronization speed as well as the aperture to the prescribed f/stop value.

After it flashes, the camera automatically switches over to the AE photography mode until the pilot lamp lights up again during which period AE photography can be continued. A steady support may be required if shutter speeds are slower than 1/30 of a second.

Like ordinary flash units, you can also perform flash photography by operating the aperture ring manually. When you are using a



Canon FL lens which does not allow full aperture metering, automatic flash photography can be performed by setting the prescribed f/stop on the lens manually. In both cases, the shutter speed is automatically adjusted to the X synchronization speed of 1/60 sec.

This flash employs a unique light sensing system, so excessive reflection from the central area is reduced giving better overall exposure.

Moreover, when the main switch of the Speedlite 155A is turned off, the flash circuitry is completely cut off and the AE-1

switches over to function as an AE camera even when the 155A is mounted on it.

The Canon Speedlite 199A also makes AE flash photography possible with the AE-1 and can be used in the same way as the 155A. See instruction booklet for Speedlite 199A for detailed explanation.

Flash Photography with the AE-1

Flash Synchronization: X Synchronization Speed (1/60 sec.)

1. When the AE-1 is used with the Canon



Speedlite 155A or 199A, the shutter speed is automatically adjusted to the X synchronization speed at the time the pilot lamp lights up.

2. **Flash Terminal:** The AE-1 offers a choice of two kinds of flash terminals; one is a directly coupled contact of the hot shoe type, and the other is of the B type terminal, as determined by Japanese Industrial Standards (JIS) for use with flash units with a cord. When both flash terminals are used, two flash units can be fired simultaneously.

3. Flash Synchronization Range

Synchronized shutter speed		1/1000	1/500	1/250	1/125	1/60	1/30	1/15	1/8	1/4	1/2	1	2	B
Type														
Flash Bulbs	FP class						△	○	○	○	○	○	○	○
	M and MF class						△	○	○	○	○	○	○	○
Electronic Flash						○	○	○	○	○	○	○	○	○

(△ mark indicates possible unevenness in the picture depending on the flash bulb.)

4. When the AE-1 is used with a flash unit other than the Canon Speedlite 155A or 199A, be sure to set the shutter speed at 1/60 sec. and the aperture manually to the f/stop prescribed for automatic flash photography or to a proper f/stop as indicated by guide number calculation.

Canon Power Winder A

The Canon Power Winder A is an automatic film winder which makes the functions of automatic photography of the Canon AE-1 outstandingly effective. It can be attached to any Canon AE-1 directly, without any other accessory or attachment. When you attach the Power Winder A to the Canon AE-1 and press the shutter button, the film will be immediately wound after being exposed. Furthermore, with the Power Winder A you can catch subjects' movements and changing expressions because you are able to take continuous or single frame photography at your pleasure. When you perform continuous photography, the Power Winder A couples with shutter speed from 1/60 to 1/1000 seconds while, in single frame photography, any shutter speed can be used.

The Canon AE-1 is a very compact, lightweight camera whose main functions respond to the electronic circuitry built into the camera body. It is possible to photograph just the same as in general photograph even when the Canon Power Winder A is attached.





Data Back A

This is an interchangeable back cover with a built-in data imprinting mechanism. It can imprint the day, month and year on the lower right hand corner of the photograph at the moment of the shutter's release, as well as other data to identify or classify the pictures you take. It has letters and Roman numerals for greater versatility and convenience.



Auto Bellows

The Canon Auto Bellows is a sophisticated bellows for use with any Canon single-lens reflex camera. Automatic diaphragm coupling is possible with the Auto Bellows when the Canon Double Cable Release is jointly used. The Auto Bellows is considered the true center of Canon photomacrographic system which includes accessories for every application in high-magnification photography.

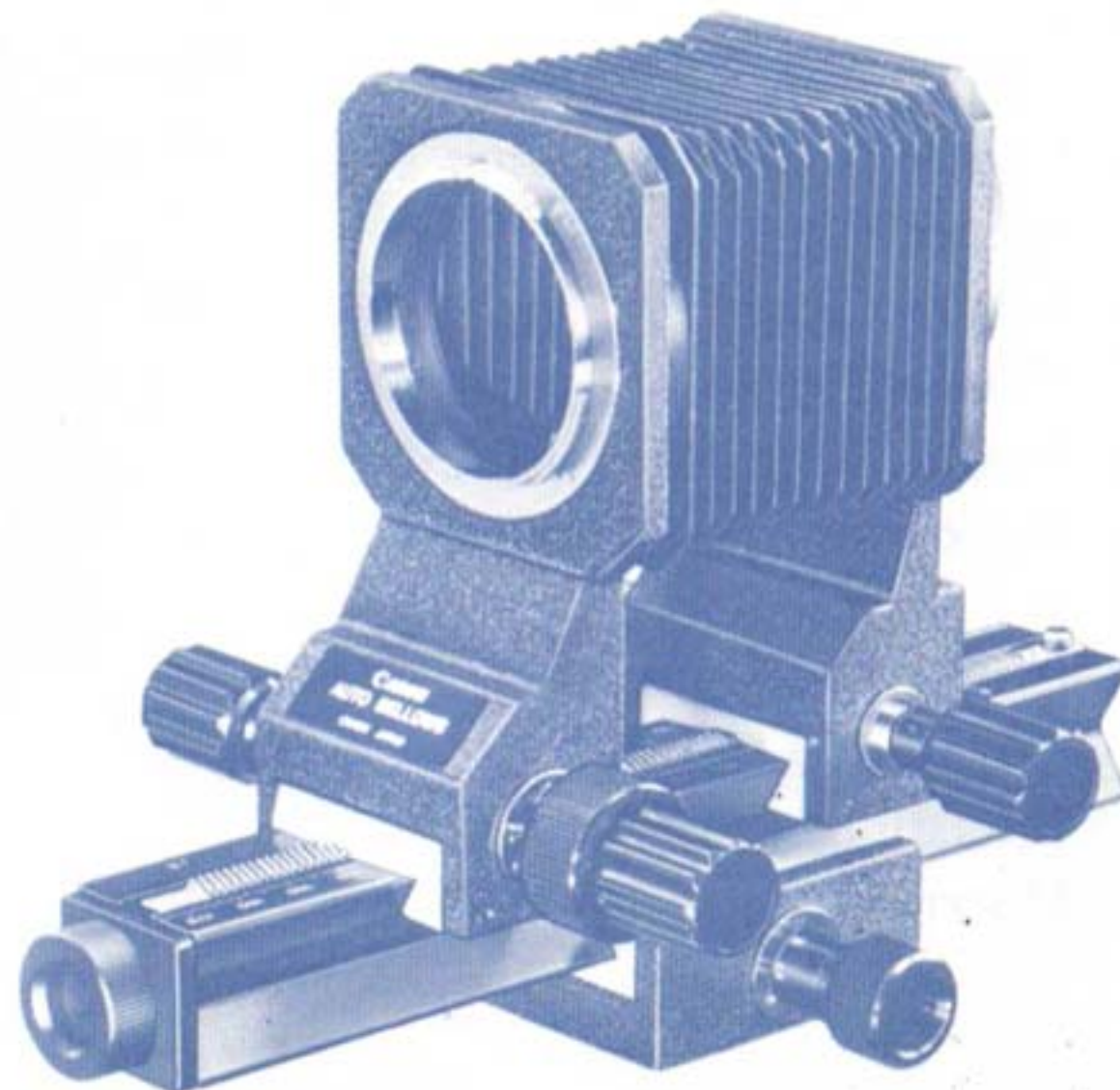

Accessories

1. Angle Finder A2 and B
2. Eyecup 4S
3. Magnifier S
4. Camera Holder F3
5. Macrophoto Coupler FL55 and FL58
6. Lens Hood BS-55
7. Microphoto Hood
8. Photomicro Unit F
9. Slide Duplicator
10. Handy Stand F
11. Gadget Bag 4-type
12. Gadget Bag G-1
13. Canon Release 30
14. Canon Release 50
15. 55mm filters
16. 58mm Close-up Lenses (240, 450)
17. 55mm Close-up Lenses (240, 450)
18. Macrophoto Lens 20mm f/3.5
19. Macrophoto Lens 35mm f/2.8
20. Duplicator 8
21. Duplicator 16
22. Duplicator 35
23. Focusing Rail
24. Macro Stage



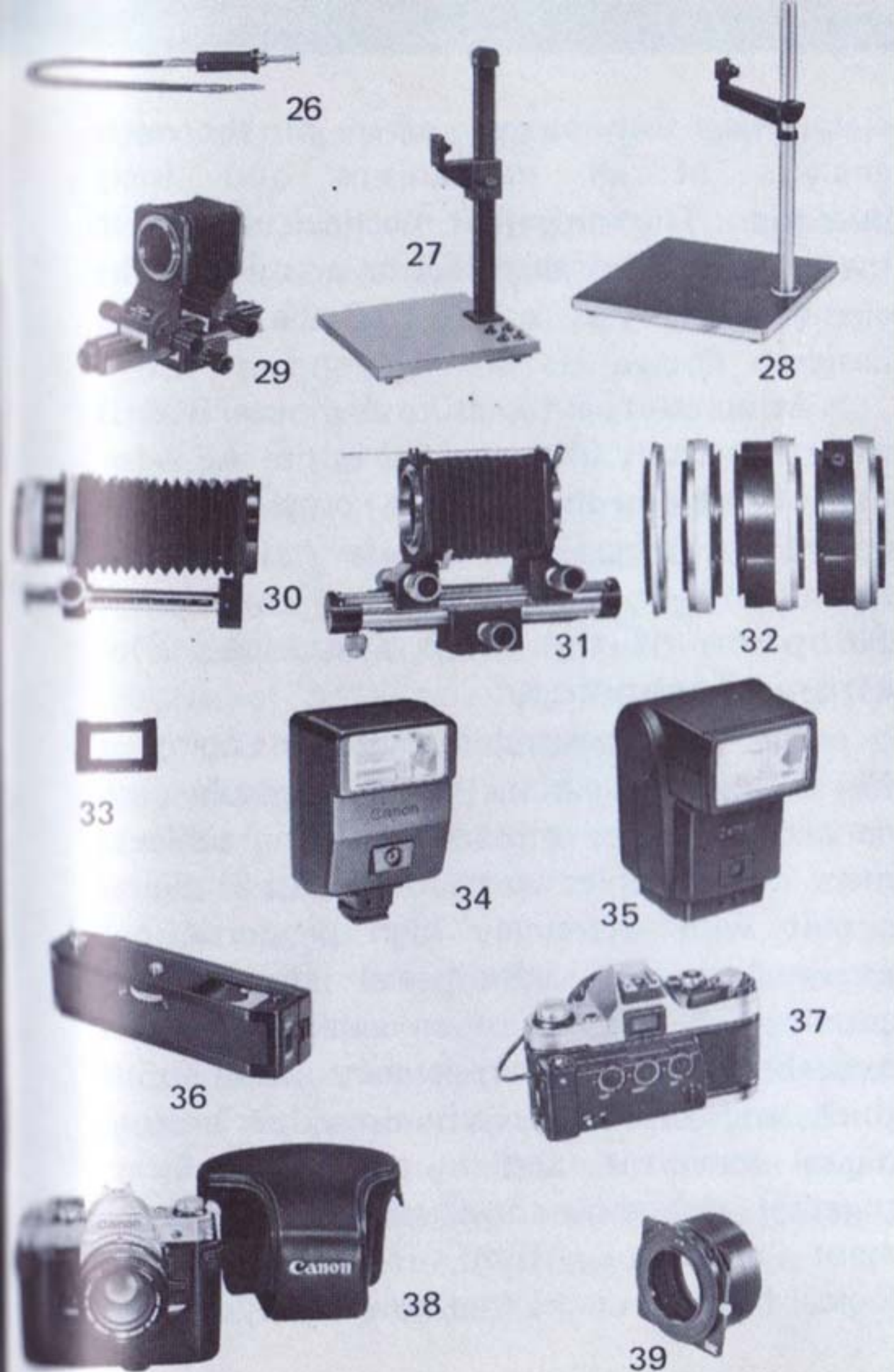

- 25. Roll Film Stage
- 26. Double Cable Release
- 27. Copy Stand 5
- 28. Copy Stand 4
- 29. Auto Bellows
- 30. Bellows M
- 31. Bellows FL
- 32. Extension Tube M Set
- 33. Dioptric Adjustment Lenses (10 kinds)
- 34. Speedlite 155A
- 35. Speedlite 199A
- 36. Power Winder A
- 37. Data Back A
- 38. Action Case A
- 39. Holder for Gelatin Filter with Filter Holder Adapter and Hoods

Characteristics

The Canon AE-1 represents a landmark in the history of SLR (Single-Lens-Reflex) cameras.

Up to now, electronic control in SLR cameras was limited, for example, to the mechanism that decides exposure, but the AE-1 is the first camera in the world to incorporate a CPU (Central Processing Unit) by means of which automatic exposure, memoery, transmission of signals, display, regulation of time and completion signal are all electronically controlled. It is an entirely new kind of SLR camera.

A high degree of automation has not been restricted only to the camera. It extends to the various accessories with the same standard of precision.

The AE-1 is the first camera to offer a totally automated electronic photographic system. It takes its name, AE-1, from this concept.

Application of Electronics is the Cornerstone of the Entire Design

Automation in the AE-1 was made possible by the application of the latest

electronic technology, after a thorough analysis of all mechanisms and their operation. The important mechanical features made way for the electronic ones, thus changing the very essence of the camera's design.

As a result, a miniature computer (CPU) was successfully incorporated in the AE-1 for the first time in the world to compute, judge, control, display and regulate required information.

Adoption of the Most Advanced Electronic Technology

The I²L (Integrated Injection Logic), as far as its applications in photography are concerned, is the most outstanding achievement in electronics up to date. An LSI digital circuit with extremely high properties of accumulation, an operational amplifier, a circuit with full use of an analog switch, a hyperbolic function resistance using both thick and thin film technology, an analog-digital convertor, and the proper interfaces, together with their construction and arrangement in modular form, represent technological breakthroughs that go well beyond the

concept of a camera as we have known before.

Exceptional Reliability through Application of Electronics

The Canon AE-1, since it employs computer technology and its overall design is based on electronics, opens the doors to a new age in the camera world.

In order to make an interrelated whole out of all the inner mechanisms and to automatize the assembly process, each and every part must be built with a very high degree of precision. And Canon extensively used computers to automate the design of the modules as well as the assembly, manufacturing and finishing processes within the strict accuracy requirements the AE-1 called for.

Modular construction allows Canon to thoroughly check each function and to accelerate production with the best quality control. Furthermore, computers were used not only in the design but also in the manufacturing, assembling and quality control, to insure that the outcome would be a uniform quality product.

By new production methods and the adoption of highly advanced packaging techniques in the manufacture of electronic circuitry, the vital parts were completely sealed to keep out dust and humidity and reduce the effects of temperature.

Weather Proofing

The IC and resistance circuits were built as units. Not only was the wiring streamlined to increase efficiency, but also the new modular joints and all other main parts were completely sealed to obtain the best possible weather proofing.

Shutter Priority System to Let No Chance Go By

This camera automatically decides the correct diaphragm opening of the lens you are using according to the light the subject is reflecting, once the shutter speed has been previously set. This is the meaning of shutter speed priority. The structure of all FD lenses allows the AE-1 to couple with the functions of the shutter speed priority. Therefore, as you compose the picture, you can freely choose the shutter speed that corresponds to the speed at which the subject is moving.

A Gentle Touch Activates the Shutter Button

This unique shutter button activates a complex of electronically controlled functions.

As opposed to the conventional mechanical systems, it serves as a switch to turn the electric circuitry on or off, and operates magnetically, in order to make the shutter release extremely fast and smooth.

Immediate Response Metering for Any Situation

From light metering to exposure setting, all functions are electronically controlled. With this astounding, revolutionary system, at the very instant the shutter button is pressed, the electronic brain (CPU) immediately computes the photographic information and produces the operating command. In EV 1 lighting conditions, light metering takes but only 0.04 sec.

There is no need to worry about inaccuracies in metering and exposure timing. No matter how suddenly the chance to shoot

avails itself to you, a gentle pressure on the shutter button will do the trick.

Silicon Photocell and Logarithmic Amplifier In a Single IC

The silicon photocell is well known for its outstanding photosensitive characteristics.

The AE-1 has a logarithmic amplifier and a special, immediate response circuit, integrated into a single IC in order to obtain the speediest responsiveness while at the same time ensuring remarkable overall durability.

Power-Saving Circuit

The main parts were designed so as to require the minimum of energy while a sequential command controls energy cut-off and supply. Thus, there is no unnecessary battery consumption.

A battery lasts the equivalent of 20,000 shutter releases in continuous photography, or one year under normal use.

Compact, Lightweight Design for Great Handling Ease

Body dimensions have been reduced to a minimum, and the lightweight structure, with a special finger grip and rounded back contours, allows you to be right with the fastest action by virtue of its truly great handling ease.

Automatic Film Winding with the Canon Powerwinder A

The Power Winder A, extremely easy to attach, enables the AE-1 to photograph continuously at up to 2 frames per second. This feature is enhanced by the fact that actual handling of the AE-1 is very much the same with or without this accessory attached.

Canon Speedlite 155A, the World's First AE Computer Flash

When the Speedlite 155A is used with the AE-1, flash photography can be performed with the aperture ring set at the "A" mark for automatic exposure. When the pilot lamp lights to indicate the proper charging level has been reached, the shutter speed is auto-

matically set and the aperture automatically determined. After the flash, the camera returns to its original AE setting.

Using the Sharp FD and Special Lenses

FD lenses are the outcome of the application of the latest electronic technology in the field of optics. Their image sharpness and color reproduction ability are unmatched. Canon offers a full array of interchangeable lenses ranging from the 7.5mm fisheye to the 1200mm super telephoto, totaling as many as 40 lenses including the special purpose lenses. They will certainly sharpen up your photography.

Data Imprinting Mechanism

The Data Back A, when attached in place of the AE-1 back cover, can directly imprint the date and other information on the negative at the very moment the picture is taken. This information is imprinted in the lower right hand corner of the picture and is most convenient for keeping track of the dates of your photographs or classifying them in general.



Care and Storage of the Camera

No matter how exceptional the camera may be, it will not give you all it can unless it is taken care of properly. Please make sure to keep the camera clean all the time. Acquire a blower brush, cleaning liquid, lens tissue, silicone cloth, etc.

Care of the Camera

Dust on the lens or the viewfinder should first be blown off with a blower brush. Use lens tissue or a clean, soft cloth to remove fingerprints or smudges with a gentle circular motion, if necessary after breathing on the surface. It is best to wipe the surface with lens tissue impregnated with one or two drops of cleaning liquid. After the camera has been used on a beach or near the sea, clean it well because salt can affect its mechanisms. A blower brush should also be used to clean the mirror box inside the camera body. If the mirror box should require wiping, by all means, please take the camera to a Canon authorized distributor.

The film compartment has to be cleaned with a blower because it easily collects film dust. If the dust contains sand, the film is easily scratched. When cleaning the rail

surface or the pressure plate, please use cleaning paper and cleaning liquid. Be careful not to touch the shutter curtain when doing so.

Maintenance

Keep the camera in a place with low humidity and no dust. After removing the camera from the case, take the battery out. When you are going to store the camera for a long time without using it, the shutter release button must be activated now and then, to prevent mold and mechanical trouble.

Please avoid storing the camera in places such as mentioned below.

1. Inside the trunk or rear window of a car in the direct sun because the temperature can rise to an extremely high degree and this may give rise to trouble in the camera.
2. Places such as laboratories where chemicals are around may cause rust or corrosion.

To safeguard the durability of the camera, please take it to the closest Canon authorized distributor once every three years at least. If the camera is not in use for a long time, please use it only after closely checking each and every part of it.

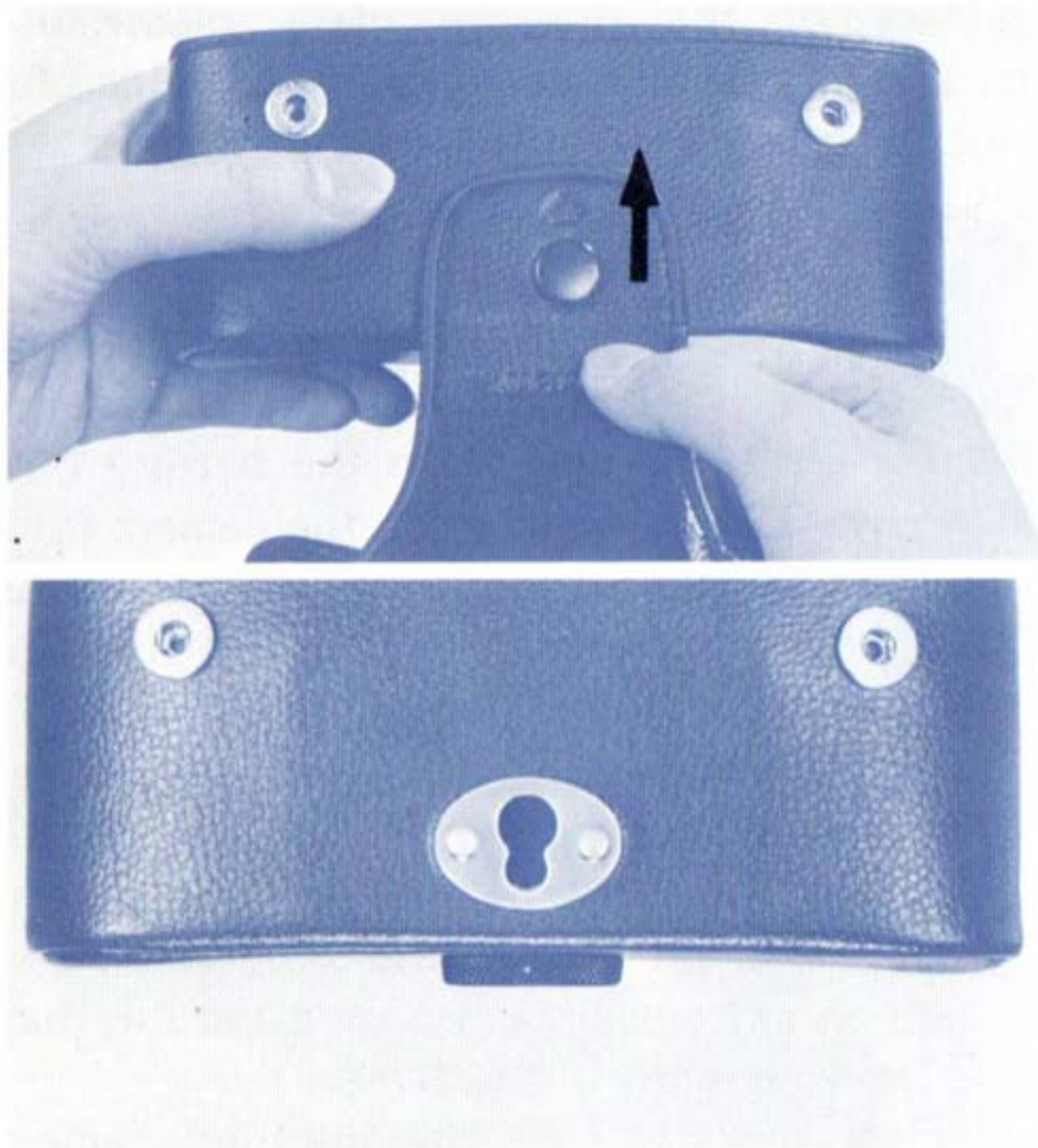

Note: When taking off the top cover of the soft case, turn the top cover to the bottom then slide the cover straight up and pull it out of the hole as shown in the photo.

To guard against the inconvenience of loss, theft or other unforeseen problems, fill in the form below to keep as a record of your camera for use in such circumstances.

Name of the Camera: Canon AE-1

Body Number: _____

Lens Number: _____

Name: _____

Address: _____

Telephone Number: _____

Note: _____

When the camera is used in very cold conditions:

Battery performance is usually affected by temperatures below zero C. It is always necessary to use a new battery for photography in such extreme cold. Moreover, an extra battery should be taken along and kept warm by placing it next to your body.

The battery may not function well at low temperatures but it may well work perfectly under normal conditions, so don't throw it away.

In sudden changes of temperature from cold to hot, the viewfinder or the lens may get moist and fog. Therefore, the camera should be exposed to the temperature change gradually. The camera has to be kept in a plastic bag completely sealed and then taken out once it has been adjusted to the outside temperature little by little.



Self-Timer Lamp

Shutter Speed Index

Frame Counter

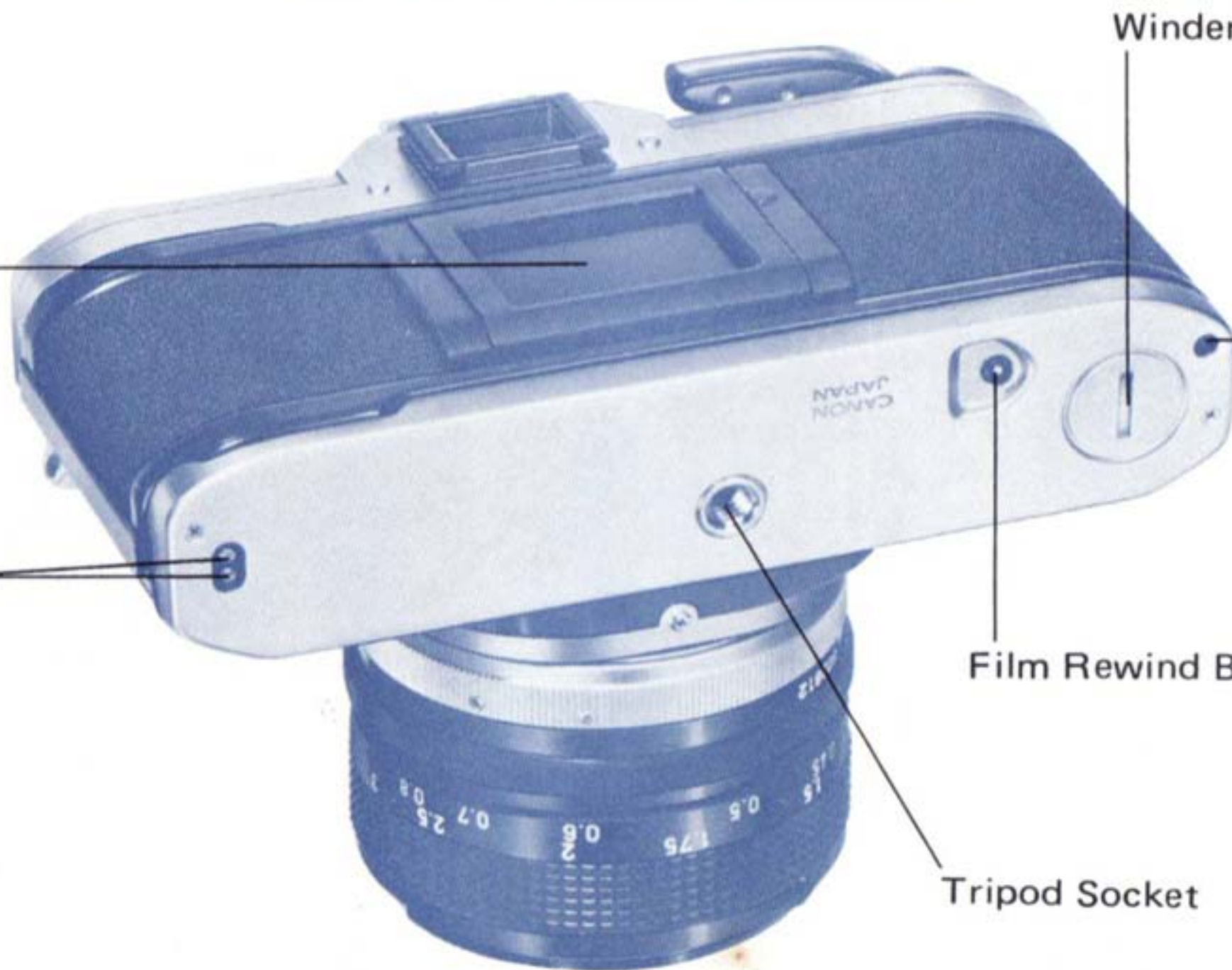

Memo Holder

Winder Coupler Cover

Winder Guide Hole

Winder Terminals

Film Rewind Button

Tripod Socket

Canon

CANON INC. 11-28, Mita 3-chome, Minato-ku, Tokyo 108, Japan

U.S.A. ————— **CANON U.S.A., INC. HEAD OFFICE**
10 Nevada Drive, Lake Success, Long Island, N.Y. 11040, U.S.A.
CANON U.S.A., INC. MANHATTAN OFFICE
600 Third Avenue, New York, N.Y. 10016, U.S.A.
CANON U.S.A., INC. ATLANTA SERVICE STATION
7000 Peachtree Industrial Blvd., Suite 200 Norcross, Georgia 30071, U.S.A.
CANON U.S.A., INC. CHICAGO OFFICE
140 Industrial Drive, Elmhurst, Illinois 60126 U.S.A.
CANON U.S.A., INC. LOS ANGELES OFFICE
123 Paularino Avenue East, Costa Mesa, California 92626, U.S.A.
CANON U.S.A., INC. LOS ANGELES SERVICE STATION
3407 West 6th Street, Los Angeles, California 90020, U.S.A.
CANON U.S.A., INC. SAN FRANCISCO SERVICE STATION
776 Market Street, San Francisco, California 94102, U.S.A.
CANON U.S.A., INC. HAWAII OFFICE
Bldg. B-2, 1050 Ala Moana Blvd., Honolulu, Hawaii 96814, U.S.A.

CANADA ————— **CANON OPTICS & BUSINESS MACHINES CANADA, LTD.**
HEAD OFFICE
3245 American Drive, Mississauga, Ontario, L4V 1N4, Canada
CANON OPTICS & BUSINESS MACHINES CANADA, LTD.
MONTREAL OFFICE
3070 Brabant-Marineau Street, St. Laurent, Quebec, H4S 1K7, Canada
CANON OPTICS & BUSINESS MACHINES CANADA, LTD.
VANCOUVER OFFICE
5900A, No.2 Road, Richmond, B.C. V7C 4R9, Canada

EUROPE, AFRICA & MIDDLE EAST ————— **CANON AMSTERDAM NV**
P.O. Box 7907, 1008 AC Amsterdam, The Netherlands
CANON AMSTERDAM NV CAMERA SERVICE CENTER
Gebouw 70, Schiphol Oost, The Netherlands

CENTRAL & SOUTH AMERICA ————— **CANON LATIN AMERICA, INC. SALES DEPARTMENT**
P.O. Box 7022, Panama 5, Rep. of Panama
CANON LATIN AMERICA, INC. REPAIR SERVICE CENTER
P.O. Box 2019, Colon Free Zone, Rep. of Panama

SOUTHEAST ASIA ————— **CANON INC. HONG KONG BRANCH**
5th Floor 2-6, Fui Yiu Kok Street, Tsuen Wan, New Territories, Hong Kong