

H A S S E L B L A D

503CWD

Digital Anniversary Kit



User Manual

English, version 2.0

C O N T E N T S

Please see the 'bookmark' list in the PDF document for a comprehensive and interactive list.

Introduction	3	Removing the lens	14	Initial general menu settings	26
Special considerations	6	Exposure	14	Storage-working with media and batches	31
System requirements	6	Warning mark	14	Overview of viewing, deleting and transferring images	37
Warnings and restrictions	6	Exposure values	14	Working with the menu	43
Before you start	7	Interlocked shutter speed /aperture	15	STORAGE	48
Working digitally	8	Focusing and depth of field	14	SETTINGS	57
Parts & components	9	Depth of field preview	14	Flash / strobe	69
Camera body	11	Pre-release and cable release	14	Cleaning	71
Front protective cover	10	Flash synchronization	14	Film magazine use	73
Rear cover Multicontrol	10	The Viewfinder System	16	Accessories	76
Opening the focusing hood	10	Changing the focusing hood or viewfinder	16	Technical specifications	78
Built-in magnifier	12	Changing the magnifier	16	Equipment care, service and guarantee	80
Focusing screen and viewfinder image	12	Changing the focusing screen	17	Further reading	81
Closing the focusing hood	12	The Digital Back	18		
Winding crank	12	General overview	19		
Accessory rail	12	Parts, components & control panel buttons	20		
Strap attachment and removal	12	Shooting / image storage modes	23		
Left hand grip	12	Selecting the current medium	23		
Lenses	13	Using compact flash memory cards	24		
Shutter speed and aperture	14	Working with an Imagebank	24		
Attaching the lens	14	Tethered to a computer	25		

PLEASE NOTE!

The menu on the digital back can be set to seven different languages:



503CWD

H A S S E L B L A D



Welcome to the HASSELBLAD 503CWD !

The year 2006 marks the centenary of Victor Hasselblad, the founder of the world famous Hasselblad camera . It is therefore fitting that in commemoration of this anniversary, a camera should be dedicated to his memory and with links to the both the past and the future. The Hasselblad 503CWD is just that.

The Hasselblad 503 CW is an extremely popular model from the 500 series. Soon after it was launched it became the workhorse for so many photographers, professional and amateur alike. It is an all-rounder, being as easy to use on location as in the studio. Entry into the new millenium naturally offered the opportunity of digital capture. Even though the camera design is mechanical, the modular concept allows the integration of a digital back to secure the optimal combination.

There are many who prefer a more traditional design of camera while wishing to exploit the latest in technology and that is where the Hasselblad 503 CWD comes in. It offers the best from both worlds, mechanical and electronic.

Hasselblad is the choice of the world's leading photographers, and the name is synonymous with compatability, reliability and image quality, reaching beyond the ends of the earth and into space.

The System

The Hasselblad 500 system is the most comprehensive medium-format photographic system in the world. It offers magazines for different image formats and films, viewfinders with or without exposure metering capabilities, a number of focusing screens to mention just a few items to suit your special requirements.

The Camera

The 503CWD features the sophisticated GMS (Gliding Mirror System) which provides a full viewfinder image with virtually all Hasselblad 'C' lenses. The bright viewfinder image is further enhanced by the improved focusing screen from the brilliant 'Acute-Matte D' range. The completely mechanical camera body boasts a one-piece aluminium alloy construction for



serious work. The Winder CW, specifically designed for the 503CW models, provides fast sequential photography and various choices of remote control, including IR. Altogether, a winning combination for professional or dedicated amateur use.

The Lenses

You have access to the whole range of Hasselblad 'C' series lenses both old and new. Lenses are specially manufactured for Hasselblad by Carl Zeiss of Germany – the indisputable leader in camera optics. The Hasselblad specifications of these lenses exceeds the demands made by digital capture to ensure the optimum in performance whatever the chosen medium. The Hasselblad V system features more than a dozen different lenses, as well as 1.4x and 2x teleconverters. The integral shutter feature combines with the TTL/OTF facility to provide tremendous flash freedom.

The Digital Back

The 16 Mpix based digital back is custom built to fit the design and functionality of Hasselblad V cameras with its range of high performance, leaf-shutter based lenses. However, it can also fit onto view cameras using the V-system interface plate for mechanical attachment and flash sync connection to trigger the digital capture for optimum compatibility and economy. It provides both cable free and computer tethered options to suit all types of work. The back offers an ultra high level of integration, image quality and flexibility to the specialist professional photographer or highend amateur user.



Instant Approval Architecture: Limitless digital image capture loses some of its potential if the photographer cannot quickly review and select the best image. Building on the success of its Audio Exposure Feedback technology, Hasselblad has created Instant Approval Architecture (IAA), an enhanced set of feedback tools, designed to liberate the photographer to focus on the shoot rather than the selection process. IAA triggers audible and visible signals for each image captured, telling the photographer immediately whether the image has a red, yellow or green light status. The information is recorded both in the file and in the file name, providing a quick and easy way to classify and select images, in the field or in the lab. A larger, enhanced OLED display provides a realistic, high quality and perfect contrast image view, even in bright sunlight, to allow instant on-site image approval. IAA is a Hasselblad trademark and is patent pending.

Large format digital capture: Today's photographers demand higher resolution, less noise, and improved flexibility, all of which the 503CWD addresses. The 503CWD uses an optical format allowing for digital capture with sensors more than twice the physical size of today's 35mm sensors. The sensor can therefore hold more and larger pixels, which secure a high-end image quality in terms of moiré free color rendering without gradation break-ups in even the finest lit surfaces.

"Instant" user interface: The 503CWD is operated with a straight forward user interface with a series of "instant" one-button-click operations including: instant capture, instant browse, instant approval, instant zoom, and instant image info.

Three modes of operation and storage: Optimum portability and image storage are critical for the professional photographer. 503CWD offers a choice of portable CF card storage, flexible FireWire drive, or tethered operation with extended, special capture controls. With these three operating and storage options, the photographer is able to select a mode to suit the nature of the work at hand, whether in the studio or on location.





Hasselblad 3F RAW files: Hasselblad 3F image raw files carry full sets of metadata, including capture conditions, keywords and copyright, facilitating work with image asset management solutions. The files also define the colours in the Hasselblad RGB colour space, removing the need for experimenting with different colour profiles to get optimal colours and the need for selective colour corrections.

FlexColor workflow: FlexColor offers an image processing workflow with the highest degree of control for the studio photographer. In tethered operation tools like live video and overlay masking help bring productivity to advanced set composition. The newest FlexColor version allows the photographer to manipulate colour temperature and compare image details across multiple images for precise image selection. FlexColor works on the basis of the 3FR RAW files generated by the 503CWD. FlexColor runs natively on both Macintosh and Windows platforms and is licensed to allow you to provide free copies for all your co-workers and production partners.

Colour refinement – new colour handling concept: Colour management solutions have in the past imposed limitations on professional digital photographers, particularly when capturing various skin tones, metals, fabrics, flowers etc. To combat this, Hasselblad has developed a new, powerful colour engine in its FlexColor workflow software. With one camera set up, the new optimised colour engine produces reliable out-of-the-box colour without gradation reproducing skin tones and other difficult colours accurately.



This instruction manual describes in detail how to operate your camera, so please read it carefully. If you have a query do not hesitate to contact your dealer – we want you to be 100% satisfied!

You may also contact us directly over usability, construction, design, etc as we welcome your feedback in order to improve our products. Your dealer can also provide you with the latest in news and technical developments from Hasselblad.

A quarterly magazine – FORUM – is published with the emphasis on photographic imagery featuring photographers from all over the world to provide you with inspiration!

Our internet site – www.hasselblad.com – is a source of general and technical information and you can e-mail us for further inquiries – info@hasselblad.se.

Your new Hasselblad camera provides access to the Hasselblad potential. The realization of this potential is only dependant upon your skill, care and judgement as a photographer. We wish you great success and welcome you to Hasselblad, the most comprehensive medium-format system in the world.



The supreme Hasselblad potential is there, it's up to you to exploit it!

1

Special considerations

503CWD



Computer system requirements

Whichever mode you choose, final image-storage and correction requires a certain minimum standard regarding computer capabilities. Large images will require a high-performance computer with plenty of memory, advanced graphics capabilities and a recent operating system. In most cases, you will want your computer to include a FireWire 800/400 connector, which will enable you to load images directly from the camera or Imagebank. To load images stored on the removable compact-flash card, you could instead use a compact-flash card reader, but we still recommend FireWire for maximum flexibility.

The 503CWD saves images as 3FR or 3F files which are Hasselblad raw digital-camera capture standards. From FlexColor, you can optimize and then export the files to DNG or TIFF or JPEG formats instead if you wish. The 503CWD includes the Hasselblad FlexColor image-capture and editing application and native versions of FlexColor are provided for both Macintosh and Windows platforms. Please see your FlexColor manual for complete system requirements.

Warnings and restrictions

- *Keep your 503CWD (and all computer equipment) away from moisture wherever possible. If your camera becomes wet, disconnect from power and allow it to dry before attempting to operate again.*
- *Always take great care when you remove the sensor back for cleaning—the exposed CCD sensor is vulnerable to damage.*
- *Keep all cables connected to or from your camera and computer out of the way where they will not be tripped over.*
- *Never cover the ventilation openings on the 503CWD when it is turned on.*

Before you start

Leave protective covers on as much as possible and avoid touching glass surfaces and inserting fingers into the camera body etc. The 503CWD has a robust construction and is capable of withstanding fairly rough treatment but nevertheless is a precision instrument and will serve you longer if treated with respect from the beginning.

In addition to the 503CWD (camera body, digital back and lens), Quick Start Guide and User Manual CD, the items illustrated below are also included in the kit. If anything is missing or seems faulty in any way then you should contact your Hasselblad dealer immediately.

Please keep purchase details and the warranty in a safe place.



Protection cover CFV

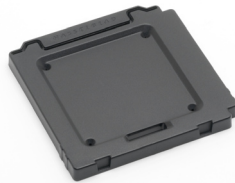

Rear cover Multicontrol



Front protective cover



FireWire cable



Flash input sync cable



Flash output sync cable



CF-Flash card (1GB)



Camera strap



Grey card



E-wipes



Anniversary book

Working digitally

If you have only worked with film before, you will find that working with a digital back is not so very different in many ways. Several changes in routine are needed and a certain amount of experience with digital products and computers is advantageous to lower the learning curve in the beginning. However, practically all of your analogue photographic knowledge is still relevant to achieve optimum results.

The following is in no way intended to be a digital primer but simply aims to highlight some main differentiating points to get started. There are many excellent books on the market that explain in great detail the various aspects of digital photography and post-capture processing.

1. **It is absolutely essential that you ensure you have a fully-charged battery, a spare fully-charged battery, access to battery re-charging or access to a computer, depending on how you work. However, in the case of the 503CWD, a film magazine can act as reserve for emergencies.**
2. **If you intend to work with a CF card, you must ensure you either have enough capacity on the card for the job in hand or have access to a card reader/separate hard disk/computer to off-load the images.**
3. **The sensitivity ("ISO /film speed") of the sensor can be altered according to circumstances just as you would choose a fast or slow film, thereby providing a range of "speeds". Just as with film, the lower "speed" settings produce finer quality.**
4. **Always check the three basic settings before starting:**
 - ISO ("film speed")
 - White balance (colour temperature)
 - Media (where the captured images will be stored).
5. **Remember the size of the sensor causes an 'increase' in the focal length of lenses in practical terms. Compose within the masking on the focusing screen.**
6. **Remember there can be specific restrictions regarding longer exposure times and working with flash.**
7. **The monitor produces an image as a visual guide only. A histogram display will provide you with the technical information about the optimum exposure.**
8. **Minor colour casts on the monitor can be ignored as there are opportunities to adjust the files later in processing.**
9. **Be extra aware when photographing surfaces with a small regular pattern in the colouring or structure (for example, fine-weave fabrics) as a moiré effect can be produced in certain circumstances.**
10. **Most other usual photographic practices apply such as using a lens shade, using a tripod when you can, checking for depth of field etc. However good your post-capture skills are on the computer, for optimum results you should still aim for optimum image capture!**



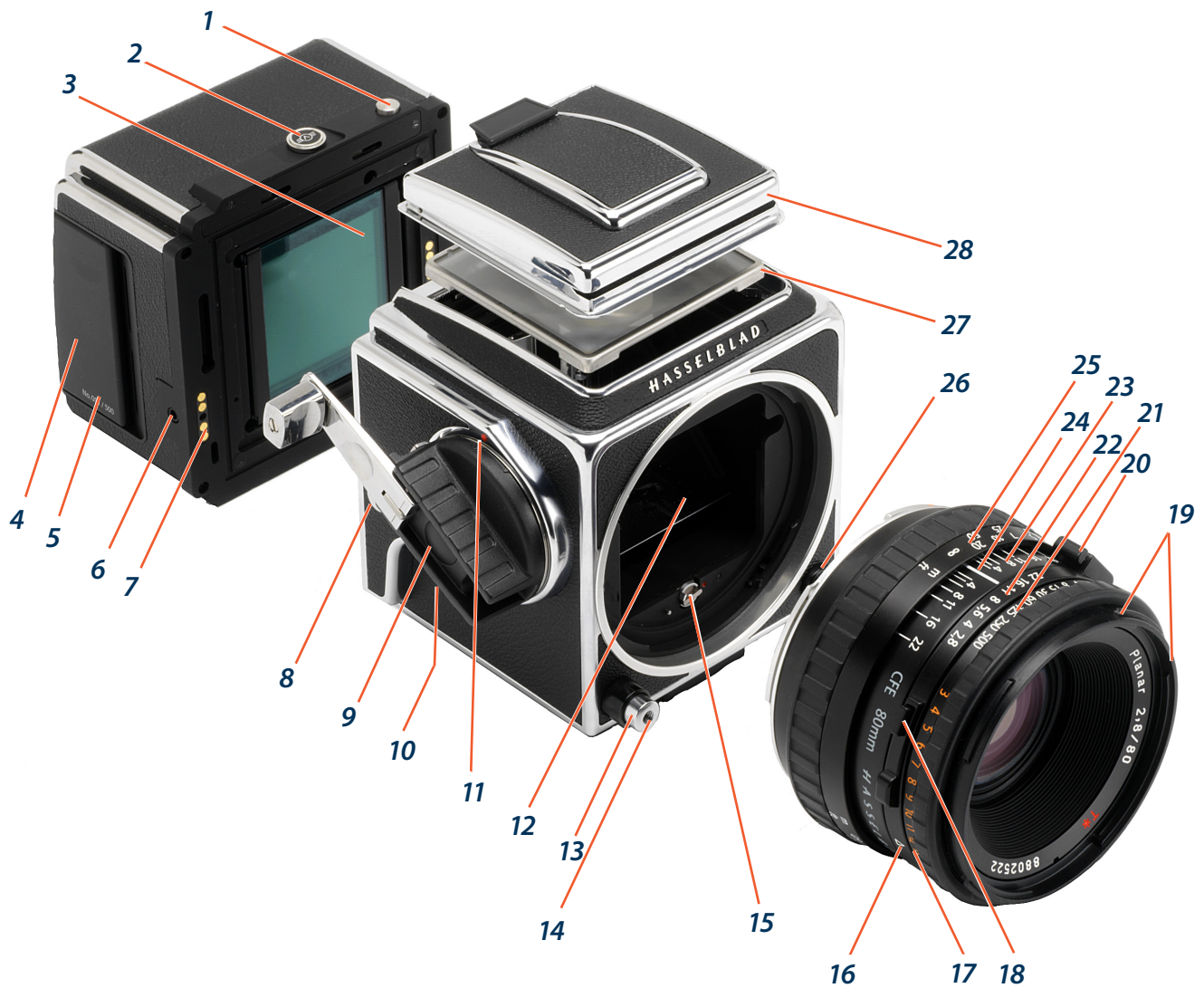

- | | |
|---|---|
| 1. Magazine catch lock | 15. Drive shaft |
| 2. Magazine catch | 16. Exposure value index |
| 3. Sensor (covered by glass IR filter) | 17. Exposure value scale |
| 4. CF card cover | 18. Shutter speed and aperture interlock button |
| 5. Limited Edition number | 19. External and internal lens accessory mount |
| 6. Sync socket (for use with Winder CW and EL-type cameras) | 20. PC flash terminal |
| 7. Databus contacts | 21. Shutter speed ring |
| 8. Strap lug | 22. Aperture ring and scale |
| 9. Winding crank | 23. Depth-of-field scale |
| 10. Pre-release button | 24. Central lens index |
| 11. Winding crank index | 25. Focusing ring and scale |
| 12. Viewfinder mirror | 26. Lens release button |
| 13. Shutter release button | 27. Focusing screen: Acute-Matte D screen |
| 14. Threaded cable release socket | 28. Focusing hood |

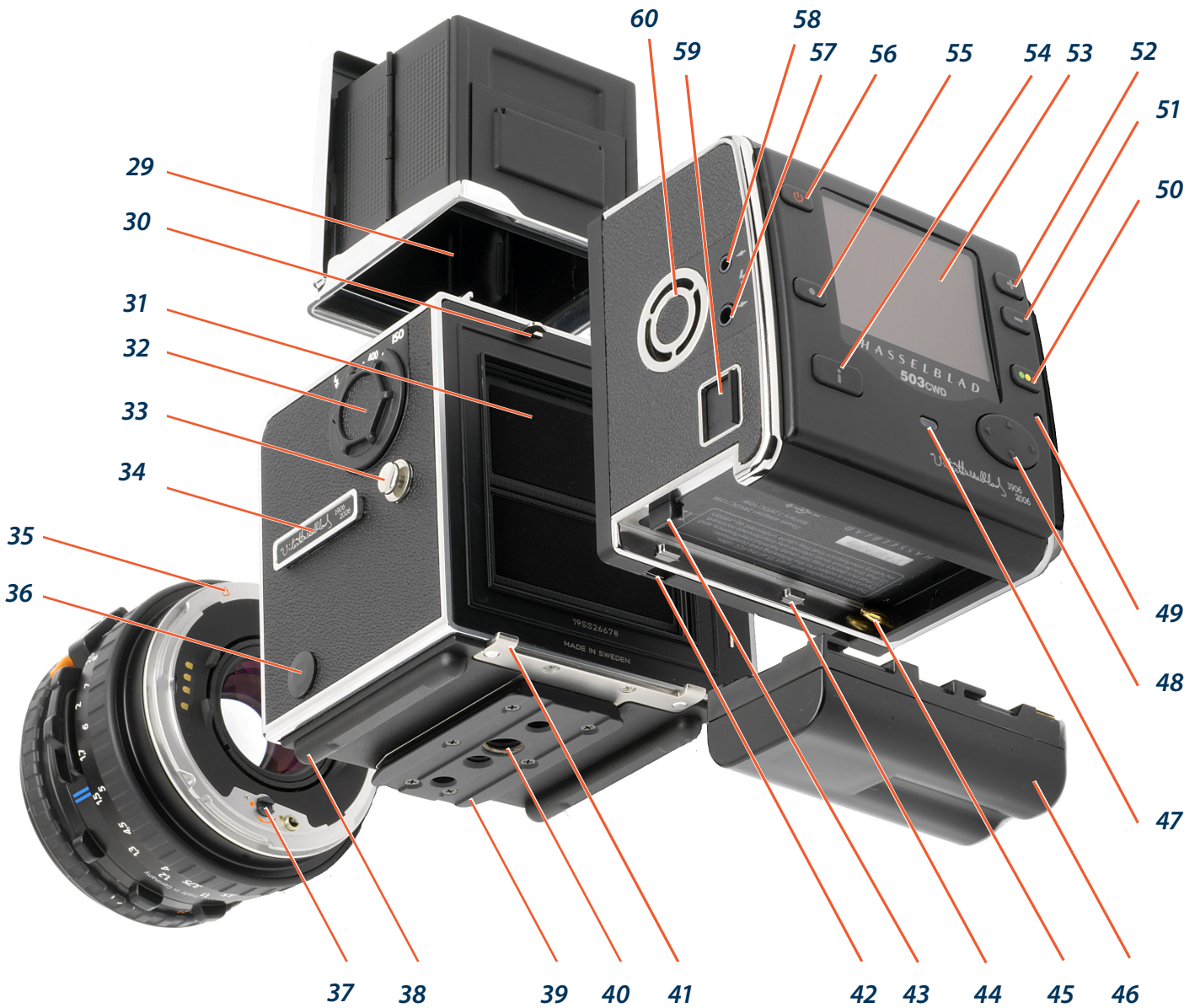

- 29. Focusing hood magnifier
- 30. Magazine hook
- 31. Auxiliary shutter
- 32. Film speed selector
- 33. Strap lug
- 34. Accessory rail
- 35. Lens locating index
- 36. Dedicated flash connector
- 37. Lens drive shaft
- 38. Camera support
- 39. Quick-coupling plate
- 40. Tripod threads, 1/4" & 3/8"
- 41. Digital back / magazine supports
- 42. Digital back support slots
- 43. Battery release catch
- 44. Battery support lugs

- 45. Battery contacts
- 46. Battery (not supplied)
- 47. Ready light indicator
- 48. Navigation button
- 49. Busy light indicator
- 50. Instant Approval button
- 51. Zoom out / Value change button
- 52. Zoom in / Value change button
- 53. OLED
- 54. Display button
- 55. Menu button
- 56. ON / OFF button
- 57. Flash sync OUT terminal
- 58. Flash sync IN terminal
- 59. Firewire 800 socket
- 60. Ventilator

2

Camera Body

This section describes the basic operations. Follow the instructions step-by-step to avoid damaging the equipment. Check that the winding crank on the right hand side of the camera is locked thus ensuring that the camera is fully wound. If the crank is not locked, rotate it clockwise until it does lock, thereby winding the camera.

503 CWD



Front protective cover

1

Always fit the front protective cover when no lens is attached to protect the mirror and interior.

Attach the cover as you would a lens, see below. To remove, turn the cover (bayonet fitting) in the direction of the arrow and lift it out.

The front protective cover can only be removed when the camera is fully wound.



Rear cover Multicontrol

2

Always fit the rear cover Multicontrol when no back is attached to protect the auxiliary shutter. Attach the cover as you would a back, see below.

To remove, depress the top part, tilt the cover backwards, and lift it off. See later sections on the other uses of the Rear cover MultiControl.



Opening the focusing hood

3

Lift the lid by firmly gripping the tab on its rear edge, and swinging it up to a vertical position. The hood unfolds automatically and locks in the open position.



Built-in magnifier

4

The magnifier flips up into the viewing position when the oval button inside the lid is moved to the right, as in the illustration. To fold the magnifier down simply press it back down towards the lid until it locks into place. It can easily be exchanged to suit individual eyesight (see “Changing the magnifier”).

Focusing screen and viewfinder image

The 503CWD is fitted with an Acute-Matte D focusing screen for unrivalled brightness and sharpness. The markings on the screen indicate the format of the sensor for correct composition with digital capture. The screen can easily be exchanged for others specially designed for various applications (see “Changing the focusing screen”).

Closing the focusing hood

5

Fold away the magnifier by pressing it back down towards the lid until it locks into place. ‘Pinch’ in the side plates at the hinge points and then push the lid lightly backwards. The hood then automatically folds back down.

Winding crank

6, 7

The winding crank can be removed. Push the catch lever downwards while rotating the crank counter-clockwise and pull the crank straight out from the shaft. To attach it, align the small triangular index mark against the red dot on the camera body. Keep the crank pushed against the camera while turning it clockwise until the larger triangular mark is aligned with the red dot where it will click into position.

Accessory rail

The camera has an accessory rail on the left hand side for the spirit level and the adjustable flash shoe (for small flash units).

Strap attachment and removal

8, 9, 10

Place the main body of the strap clip over one of the camera’s strap lugs. Press the tip of the clip towards the camera while pulling back on the strap so that the clip slides over the lug and locks into position. To remove the strap, lift the clip locking plate high enough to be able pass over the camera lug. Slide the clip in the direction away from the strap until it is free.

Left hand grip

Without a Winder CW (3044105) attached, you may find that holding the camera in your left hand is the most convenient grip; operating the exposure release button with your index finger. Your right hand is then free for focusing, setting the exposure, rewinding, and changing the lens or magazine. The Snap-lock flash grip (3045169) also acts as an ergonomic camera grip, see under ‘Accessories’.

3

Lenses

The 503CWD is compatible with lenses that have an integral leaf shutter, namely, all C series lenses. CFi/CFE lenses are the latest developments and are mentioned and illustrated here as the conventional choice. C, CF and CB lenses, although differing in specification and appearance to CFi/CFE lenses, are operated in a very similar manner but please see the relevant instruction manuals for complete details.

503CWD

1. Shutter speed ring
2. F-setting button
3. Warning mark
4. Depth-of-field preview knob
5. PC-socket with positive lock
6. Central lens index
7. Focusing distance scale
8. Lens bayonet plate with red index
9. External and internal front bayonets
10. EV index
11. Exposure value (EV) scale
12. Shutter speed/aperture interlock button
13. Shutter speed scale
14. Aperture ring and scale
15. Depth-of-field scale
16. Infrared focusing index
17. Focusing ring



The illustration shows the Planar CFE 2.8/80 mm lens but the layout of the parts is identical on all CFi /CFE lenses.



Shutter speed and aperture

1

The shutter speed selector ring is the ring located closest to the front of the lens. To set the speed, turn the ring until the desired marked shutter speed position aligns with the central lens index. The white scale shows the shutter speeds, and the orange scale the exposure values (EV). The aperture setting ring is the second closest ring to the front of the lens. The aperture value is also set against the central lens index. The diaphragm is automatic and stops down to the preset working aperture at the start of the exposure sequence. Therefore in the illustration, the exposure setting is 1/60 second at f/11.

The orange 'F' setting is used only when the lens is attached to a Hasselblad camera in the 200 or 2000 series with a focal plane shutter. The operation of the diaphragm is not affected. The 'F' setting can only be engaged/disengaged when the orange lever is pressed.

 *If the F setting is used, exposure errors will occur since the shutter remains open.*

Attaching the lens

2, 3

Make sure that both camera and lens are fully wound. Illustration 2 shows the correct relationship between the drive shaft, the lens drive coupling and their indexes. If the lens is not wound, you can insert a small coin or similar in the coupling slot and rotate it clockwise until it locks (about 4/5 of a turn) When you have aligned the red index on the lens with the one on the camera (illus 3), the lens will drop easily into the bayonet fitting. You can then rotate it clockwise until it stops with a faint click as the lens catch locks it in place.

Removing the lens

4

Depress the lens release button and rotate the lens counter-clockwise until it stops and lift it out of the mount.

 *You can only remove the lens when the camera is fully wound and not in the pre-released mode (see "pre-release and cable release").*

Exposure

As a general rule for all shutter speed settings except B, you should keep the release button depressed until the lens shutter has opened and closed fully. This is especially important at shutter speeds from 1s to 1/4s, as the auxiliary shutter remains open only when the button is kept depressed (see also 'Warning Mark' below). If you remove the magazine, you can see the auxiliary shutter, consisting of two blinds, covering the rear opening of the camera body. It protects the film from unwanted exposure as the lens' shutter normally is open for focusing.

 *With longer exposure times, connect the flash sync input cable between the PC-socket (flash sync contact) on the lens and the flash sync IN terminal on the digital back. This eliminates any conflict between the shutter setting and the digital back 'time-out' setting.*

Warning mark

5

You will find an orangeline on the shutter speed scale above the 1, 1/2, and 1/4s settings. This is to warn you of possible exposure errors as detailed above. The auxiliary shutter will terminate the exposure prematurely if you relax the pressure on the button too soon. Listen to the buzzing sound of the delay escapement in the lens' shutter and maintain the pressure on the release button until the sound stops.

Exposure values

6

The aperture and shutter speed combination set opposite the central lens index determines the exposure. Every combination of shutter speed/ aperture has an equivalent exposure value (EV) which you can read and set against the red EV index on the right hand side of the lens.

Interlocked shutter speed /aperture

7

If you want to change the shutter speed or aperture while still keeping the same shutter speed/aperture combination (EV), you can interlock the speed and aperture setting rings by holding down the interlock button which is on the right of the aperture scale. When interlocked, the rings move together, increasing or decreasing the aperture to compensate for a decrease or increase of speed respectively.



Focusing and depth of field

8

The focusing ring is closest to the camera body. It has a knurled rubber grip and engraved distance scales in feet and metres. Focus the lens by rotating the focusing ring until you obtain a sharp image of the subject in the viewfinder. The distance between the subject and the film plane is read off the focusing ring's distance scale opposite the central lens index. Objects closer or further away than the selected distance will be sharp, within certain limits. The limits of this field of sharp focus—depth of field—vary with the aperture. The depth of field available at any given aperture can be read off the depth of field scale on both sides of the central index. As an example, the illustration indicates how to read the depth of field scale at an aperture of f/11. The depth of field will in this case range from ca 6 metres to infinity.



Depth of field preview

9

Depth-of-field can be visually checked on the focusing screen. The diaphragm can be stopped down to the preset aperture from its normally wide open position simply by pushing the depth-of-field preview lever downwards until it locks. To reopen the diaphragm, depress the lower part of the lever.



Pre-release and cable release

10

Considerable efforts have been made to reduce camera vibrations caused by moving parts in the exposure sequence. However, if you wish to avoid these vibrations completely, you can pre-release the mechanism by pushing the pre-release button upwards. This causes the following sequence:

1. The mirror folds up
2. The shutter closes and remains closed
3. The diaphragm closes to its preset aperture
4. The auxiliary shutter opens

When you subsequently press the release button, only the shutter then operates at the preset speed. As shown in the illustration, you can also attach a cable release to further reduce vibrations.



Flash synchronization

11

The C series lenses have built-in leaf shutters with speeds from 1s to 1/500s and B. Flash synchronization occurs at full shutter opening via the PC flash terminal. Suitable electronic flash units can be used at all shutter speeds from 1s -1/500s as well as B. Please see under 'Flash' the sections on the use of a Hasselblad Flash adapter SCA 390.



4

The Viewfinder System

The 503CWD is supplied with a light, compact and foldable viewfinder, providing a through-the-lens laterally reversed image. It is easily interchangeable with alternative viewfinders including the prism finders, which produce a laterally corrected image. Please see 'Accessories' for further details about prism finders.

503CWD

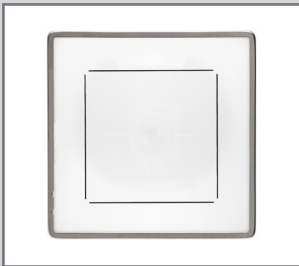

The focusing hood on the standard viewfinder has a built-in 4.5x magnifier for accurate focusing and this can easily be changed to suit individual eyesight. The 503CWD is equipped with an Acute-Matte D focusing screen which produces an exceptionally bright and sharp image. The markings on the screen indicate the format of the sensor for correct composition with digital capture. While this normally covers most needs, the Hasselblad system offers a range of alternative screens for various specific applications. Each item is easily and quickly interchangeable without the need for special tools or facilities.

1



Changing the focusing hood or viewfinder

1

To remove the focusing hood so as to attach any other viewfinder in the Hasselblad system, proceed as follows:

1. Detach the digital back.
2. Fold down the focusing hood to protect it from damage and remove it by sliding it to the rear in its guide slots.
3. Slide the replacement viewfinder into the slots and push it forward until it stops.

2



When fully inserted the viewfinder is retained in position by a spring-loaded catch until you have reattached the magazine.

Changing the magnifier

2

Mounted lenses with dioptré correction from +3 to -4 are available, and are easily interchanged as follows:

1. Remove the focusing hood from the camera and open it by lifting the lid.
2. Release the magnifier by pushing the catch to the right.
3. Push the magnifier halfway back down to its folded position.

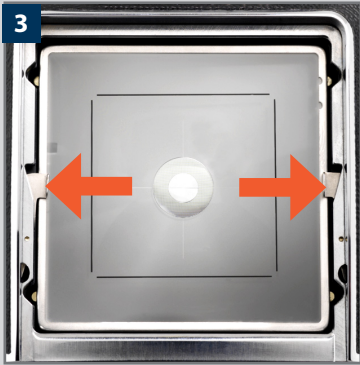
3

4. Grip the lower edge of the magnifier plate (through the underside of the hood), and pull firmly.
5. Keep the plate holder halfway down and insert the replacement lens plate with the printed side up. Fold the hood down and replace on the camera.

Changing the focusing screen

3

1. Detach the magazine and viewfinder.
2. Push the two screen clips to the side into their recesses.
3. Place your hand over the screen, and invert the camera. The screen will now drop into your hand.
4. Insert the replacement screen, ensuring that the smooth flat side is uppermost and the sharp-edged corners down. Ensure that all four corners of the screen are positively seated on their supports.

You need not return the screen latches. This is done automatically when the viewfinder is replaced.

Should the screen refuse to drop out by itself, ensure that the camera is fully wound, remove the lens and check that the mirror is in the down position. Put a finger through the lens mount and push gently on the screen from underneath, preferably with a soft cloth between the screen and the finger.

 Do not immerse the screen in water, or use any kind of cleaning fluid.

 Do not use hot air to dry the screen if it becomes damp.

5

The Digital Back

The 16 million pixel digital back can produce 16 bit raw files at 33 Mbytes each at a rate of 35 frames per minute.

FlexColor then processes these files to produce the quality expected from Hasselblad.

503CWD

General overview

In very simple terms, the 503CWD digital back holds a light sensitive sensor in place at the film plane. The electronic signals from the sensor are then processed and stored as a digital file.

As an electronic colour image is made up of three components – red, green and blue which combine to form a so-called RGB image – the sensor's task is to convert a multi spectrum light image into three digital files (red, green and blue) for combination later on.

The 503CWD uses a CCD (Charged Couple Device) type sensor that has 16 million light sensitive areas on its surface each of which creates a pixel.

Each pixel in the sensor is filtered to create the three separate red, green and blue files. Software then processes these electronic files as a package to produce the various formats – RAW, TIFF, JPEG etc.

The three components of the image file are later recombined on the computer screen to produce the familiar full colour image.

The image file can be temporarily stored either in the 503CWD digital back with a CF card, on a Hasselblad Imagebank or the hard disk on a computer. Processing of these images is carried out in conjunction with the included FlexColor software. See the separate FlexColor manual for further details

The 503CWD's digital back is designed to also fit other Hasselblad V model cameras. Please check the connectivity diagram in this manual for further details about the various models, including the possibility of connectivity to large format cameras.

Bear in mind that the sensor is 37mm x 37mm in size. This results in a smaller image (compared to the approx. 60mm x 60mm format produced with a film magazine) and the markings on the focusing screen should be used as the guide for composition. This smaller format also in effect 'lengthens' the focal length of the lens in use with a lens factor of 1.5. So, for example, a 50mm lens together with the digital back will produce a similar apparent perspective as a 75 mm lens would produce if the full 60mm x 60mm format was used.

The 503CWD is an electronic device and consequently attention to power access is vital. When working untethered it is therefore important to plan either battery charging or battery replacement to ensure continued workflow.

Likewise, image storage is limited, particularly when using flash cards and appropriate steps should also be taken when planning a shoot.

External storage is accomplished by FireWire connection to a separate hard disk or a computer.

When attaching and removing the back, pay particular attention to the image sensor area. The sensor itself is covered and therefore protected by the glass IR filter but take great care when handling. If you need to clean the filter, see later section for specific details. When storing separated from the camera, always ensure you have replaced the protective cover.

If you scratch or mark the filter in any way, it will show up on every shot. Replacements are expensive so treat the glass surface with at least as much care as you would a lens.

The sensor itself is not accessible for any kind of cleaning or maintenance by a user. Do not attempt any such action as you will almost certainly damage it irreparably.

As is the case with all electronic devices pay extra care when working in damp environments and avoid damp conditions for storage.

The menu can be displayed in one of seven different languages:

English, French, German, Italian, Spanish, Japanese or Chinese

Language:	English
Sprache:	Deutsch
Langue:	Français
Lingua:	Italiano
Idioma:	Español
言語:	日本語
语种:	汉语



Parts, components & control panel buttons

The control panel has an OLED screen that provides a bright, high-contrast view even in bright surroundings and at fairly acute angles. The panel is the main graphical interface for image checking and settings changes when not connected to a computer.

The buttons are used for browsing images and navigating the menu system. Two of the buttons, located at the bottom-right and -left of the screen, are given an on-screen label that changes according to the current context (e.g., the bottom-right button sets the approval rating when browsing images, but confirms settings when using the menus).

Digital back retaining catch lock

Ensures that the digital back is not unintentionally removed.

ON /OFF button



Powers the digital back.

OLED preview screen

Displays preview images and the menu system even in bright light and from acute angles.

1 Menu / (Menu Exit) button

4



Opens and closes the menu system. Also used for various other tasks (Exit button, for example) as you issue commands within the menu system indicated by a label beside the button on the preview screen.

2





3

Display mode button

5



Steps through the various view modes for the preview image: standard, histogram overlay, image details, screen off and full-screen.

Ready light indicator	6	Navigation button	15
Flashes yellow to indicate that the digital back is performing an operation and is not available for new commands. Flashes green when the back is ready.		 A four-way rocker button enabling you to step through preview images and navigate the menu system. To use it, press the side of the button that corresponds to what you wish to do (e.g., move up, left, right or down).	
Digital back retaining hook slots	7	Digital back retaining catch	16
Accepts digital back/magazine retaining hooks on camera body.		Locks the mounted digital back onto the camera body..	
CCD and IR filter	8	Ventilator	17
This is the light-sensitive element, which is positioned behind a permanently mounted IR filter. Usually, this assembly will either be inside the camera or protected by the cover. Always be very careful not to touch or scratch the surface of the filter when it is exposed and to replace the plastic cover whenever the digital back is not mounted on a camera.		Ensures the processor is kept cool.	
 WARNING: never attempt to remove the glass filter—you will probably ruin the CCD if you do so.		Flash sync IN terminal	18
See 'Cleaning the CCD' section for details.		Used when working with studio / strobe flash units. Allows connection to the unit via the flash sync protector cable to ensure correct synchronisation as well as providing protection for the digital back.	
Databus connectors	9	Flash sync OUT terminal	19
For communicating with a Hasselblad ELD model camera body or with a modified Hasselblad 202/203/205 model camera body.		Used when working with studio / strobe flash units. Allows connection to the lens sync contact via the flash sync cable to ensure correct synchronisation	
Battery (not supplied)	10	FireWire connector	20
7.2V InfoLithium L type (Sony NP-F550 or similar)		Allows the connection to a computer or Imagebank. The digital back requires an 800 connector whereas the computer can be either an 800 or 400.	
Zoom-in button / SELECTION (+ button)	11	Battery retaining catch	21
Zoom-in button (to make the view larger) for the preview image.  Also acts as a selection button when viewing available image batches, media and value setting on the menu.		Ensures secure mounting of battery.	
Zoom-out button / SELECTION (- button)	12	CF card slot cover	22
Zoom-out button (to make the view smaller) for the preview image. You can continue to zoom out to view several small images at once and finally to view and select batches and media. Also acts as a selection button for value setting on the menu. 		Protects card slot.	
Instant Approval / (OK) button	13	Winder / EL terminal	23
This button steps through the three approval levels, thereby assigning an approval status to the image currently displayed (or selected) in the preview screen (part of the Instant Approval Architecture system). The colour coding is based on the traffic signal convention of green, amber (yellow) and red. 		Terminal for connection to a Hasselblad CW winder or Hasselblad EL model camera body. Requires the camera sync cable (supplied).	
Also acts as a confirmation button (OK button) for some types of menu operations, such as deleting images; indicated by a label beside the button on the preview screen.		Digital back support slots	24
		Accepts digital back/magazine support hooks on camera body.	

Although the 503 CWD digital back is primarily designed for use with the 503 CWD camera body, it can also be used with other Hasselblad camera models as well as other camera brands that have been fitted with an adapter for mounting Hasselblad film magazines.

This manual assumes that you are using the digital back in conjunction with the 503 CWD body camera.

As with all digital products, it is essential that you maintain a constant check on battery condition and preferably have a fully-charged reserve battery with you at all times when not tethered to a computer.



 **CAUTION**

If you remove the digital back, be very careful not to touch or scratch the CCD/filter surface while it is exposed.

Always attach the protective cover for transportation or storage.

Powering the digital back

The digital back requires power either from the battery (7.2V Sony InfoLithium L type – NP-F550 for example) or from a computer via a FireWire cable.

To attach a battery:

1. Firstly, ensure the battery is fully charged (see user appropriate manual for battery and charger).
2. Position the battery as in the illustration.
3. Press the battery towards the camera. This automatically depresses the battery retaining catch.
4. Slide the battery into the final position ensuring the contact prongs on the camera are inserted into the battery. The battery retaining catch will now return to the safety position

To remove a battery:

1. Depress the battery retaining catch and slide the battery over it. It will then be freely removed.

FireWire connection:

1. Simply connect the FireWire cable between the FireWire port on the digital back and the FireWire port on the computer. You will not need to attach a battery with a FireWire connection.

ON / OFF button

With a fully charged battery fitted or FireWire cable attached, press the ON/OFF to activate the digital back. An audible signal will be heard and a Hasselblad logo splash screen will appear on the OLED. The back will enter standby mode after the preset time to save the battery. Press the ON/OFF button again to turn the digital back off. An audible signal will be heard again to confirm this. However, you will not need to use this button with a FireWire connection as the active mode is instigated automatically.



Shooting/image storage modes

The 503 CWD can store captured images in three ways:

1. Untethered / Compact flash card mode

In this mode the 503 CWD acts independently of other connections. Images are stored on the internal, removable compact-flash card.

- *The main advantage with this mode is the freedom of cables and extra equipment.*
- *The main disadvantages with this mode in the field are the battery power capacity and the size of the card's holding capacity.*

2. Semi-tethered / Imagebank mode

This mode enables you to attach the camera to a portable Hasselblad Imagebank via a FireWire cable. The Imagebank features massive storage capacity and high-speed data transfer. It is small, lightweight, battery powered and easily clips to your belt, so the solution is just as portable as the untethered option.

- *The main advantage with this mode is the great number of images that can be stored without a pause.*
- *The main disadvantage with this mode is the extra equipment and cabling needed that might restrict mobility in some cases.*

3. Tethered / Studio mode

This mode enables you to connect your 503 CWD directly to a computer and to operate the system using Hasselblad FlexColor software and store images on a computer hard-disk.

- *The main advantages with this mode are the almost limitless storage capacity and being able to work on the images (with Hasselblad FlexColor) on a large screen.*
- *The main disadvantage with this mode is the lack of mobility to any great extent.*

Selecting the current medium

A choice has to be made concerning where the captured images will initially be stored. The current storage medium is the location to which new shots are saved and from which you can browse using the navigation button. In many cases, the destination medium is selected automatically, for example:

- *When you are connected to a computer, then images are always saved directly to the computer hard disk.*
- *When only one medium is connected (e.g., a compact-flash card), then this medium is automatically selected.*

However, if you are working away from your computer and have several media attached (e.g., both a card and an Imagebank, then you may need to select a medium explicitly if you want to browse its contents and store images new to it.

There are two ways of selecting the current storage medium:

- *See "Selecting the Current Storage Medium" for details.*
- *Use the zoom-out button to zoom all the way up to the top level, which shows all connected media, and then zoom in on the appropriate medium and batch.*
See "Navigating Media and Batches" for more information about selecting media and batches in this way.





Using compact flash memory cards

When shooting to a compact-flash card, the H2D is completely self-contained. No additional wires or connectors need to be attached.

The 503 CWD is shipped with a 1GB compact-flash card, which is able to hold over 45 shots. Lossless compression is applied to the images, so the actual size of each capture can vary, thereby affecting the total number of shots you can fit on the card. You can purchase additional, possibly larger-capacity, cards and change them as each card becomes full.

 Note that the camera can copy the contents of its compact flash card to an Imagebank even when no computer is attached. This enables you to backup your shots and then clear space on the card to keep on shooting. See section on “Transferring Images”.

Inserting a card

1. Open the CF card cover to reveal the CF slot.
2. Hold the CF card so that the connector holes face into the slot in the 503 CWD, with the brand label facing in the same direction as the 503 CWD preview screen. Gently press the card into the slot.

If you encounter resistance, it might be because you are holding the card backwards or upside down. Experiment until you find the orientation that allows the card to slide in easily.

Swing the cover shut again.

Removing a card

1. After opening the CF card cover, press gently on the card removal button and then release it.
2. The button will now extend out from its original position, as in the illustration.
3. Press firmly on the card removal button to eject the card for removal.

Working with an Imagebank

There are no practical differences between shooting to the internal card or to an Imagebank. However, when several media are mounted, you must be sure to select the correct destination medium (see also “Working with Media and Batches”).

Working with a Hasselblad Imagebank

The Imagebank is an optional add-on for your digital camera system. It is essentially an external FireWire hard disk optimized for digital photography, providing extensive storage space and high-speed data transfer. It is small, light and battery powered. You can easily clip it to your belt, so the solution is nearly as portable as the stand-alone camera.

 Older digital backs in the ‘iXpress’ line used a different external disk and controller called simply the “Image Bank”. This older Image Bank is not compatible with the 503 CWD. Use only the Hasselblad Imagebank with a 503 CWD.



To use an Imagebank with the 503 CWD, simply assemble the Imagebank as described in its manual and connect the two with a standard FireWire 800 (IEEE 1394b) cable. See the Imagebank manual for complete details.

To remove the Imagebank, simply disconnect the FireWire cable. The back will then revert to saving and browsing images on the internal flash card (if available).

Tethered to a computer

Even if you never shoot while connected, you will probably connect the camera to your computer each time you want to download your images, though you might instead use a compact-flash card reader and/or connect your Imagebank or FireWire disk directly.

Connecting to a computer

To connect to a computer, simply attach a FireWire cable from the FireWire port on your computer to the port on the side of the 503 CWD. The port on the 503 CWD is protected behind a sliding cover.

Removing from a computer

To remove the camera from a computer, simply disconnect the FireWire cable when all image loading activity has finished.

Shooting with FlexColor running

When you are connected to a computer, the following rules apply:

- ***A Winder CW and the special cable must be attached.***
- ***The destination medium and location are controlled from FlexColor.***
- ***The screen and menu system on the sensor unit are disabled.***
- ***The sensor unit will take power from the FireWire cable if it is available (not all computers supply power here, notably PC laptops).***

When initiating a shot from FlexColor, the computer sends a signal to the sensor unit, which triggers the Winder CW which in turn triggers the shutter and flash/strobe lights (if any). The sensor unit then sends the image back over the FireWire connection to the computer, where it is displayed on the computer screen and saved as a 16-bit-per-color 3F file in the currently selected folder of the computer hard disk.

3F is a proprietary Hasselblad format for storing raw captures. It contains the complete raw image exactly as it was captured by the camera, plus technical details that enable FlexColor to process and display the image correctly. It furthermore stores a complete history of the FlexColor settings that you have applied to each image and stores meta-data such as camera settings, image name, photographer, copyright, etc. When you load images into FlexColor from the camera or external media, the 3FR files are converted into the 3F format. If you prefer not to use FlexColor, then you can export files directly to DNG or other format and use Adobe Photoshop, for example.

Please refer to the FlexColor Software Reference manual for further instructions about taking pictures using FlexColor.



Initial General Menu Settings

503 CWD



General

Using the menu on the 503 CWD is very similar to using a menu on a cell phone or similar. When you first enter the menu you will see an initial list:

ISO
White Bal.
Media
Browse

Storage
Settings

The first four items are immediately accessible for changes, indicated by the appearance of a plus and minus sign in the highlight frame meaning the settings can be altered by the Zoom in / Zoom out buttons. Storage and Settings are more detailed and therefore require further navigation.

It is advisable to quickly skim through this section of the manual initially to see build up a picture of the menu structure with its various sections

On the following pages you will see an illustration of the philosophy behind the menu, its structure and how changes in settings are made and stored.

Some of the buttons have a double function while others remain single function. For example, the navigation button always leads you through the menu in the direction that the arrow illustrates. The Zoom in/out buttons though, for example, act as image enlargers and reducers as well as confirmation buttons, according to where you are on the menu.

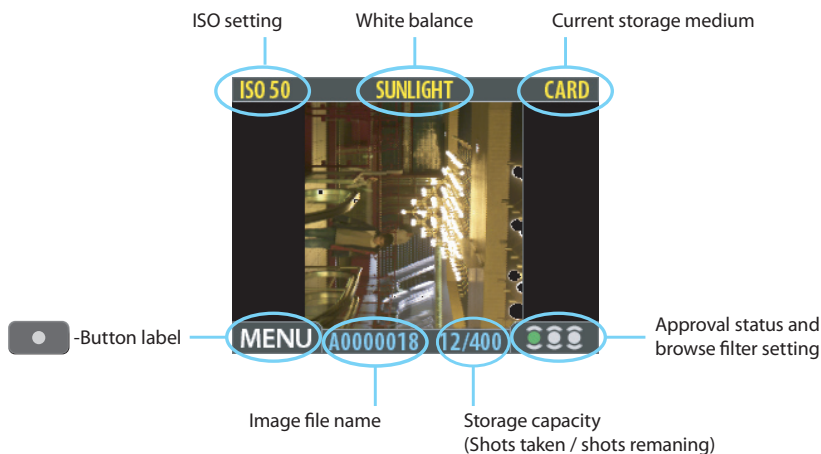

The standard preview display is the one shown when you first turn on the camera and is probably the view you will use most often. It features a preview of your most recent shot and basic information about the sensor unit settings and the image itself. Several other display modes are also available, including histogram, capture details, full-screen and battery saver. Please see **Preview Modes** for details.

The display furthermore enables you to navigate the menu system and make camera settings; see **Working with the Menus** for details



Inset photo: Deepanita Sharma photographed by Tarun Khivwal / Hasselblad Master 2005 / ©

By using the buttons on the control panel you can navigate down through the various levels in the menu. It provides the source of information about image files and also provides a way of making custom settings so the digital back suits your way of working.

Below is a simple overview of what is available and where it is situated on the menu.

Overview of menu structure

MENU

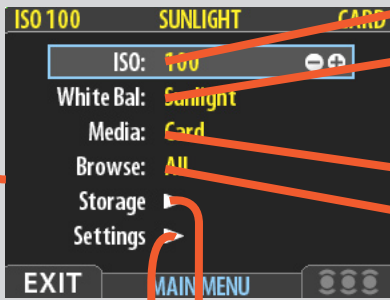

ISO
Sets the light sensitivity of the sensor. Equivalent to 'film speed'.

WHITE BALANCE
Set to match the colour temperature of light used.

MEDIA
Determines where files will be stored (flash card, Imagebank).

BROWSE
Sets the approval status (classification) filter for easier and quicker image browsing.

STORAGE

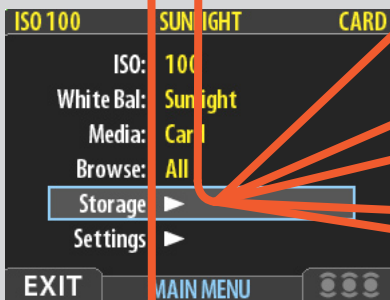

DELETE
For single or multiple deletion of images.

FORMAT
Used to format compact flash cards and Imagebanks for optimum use.

COPY
Used for off-loading images from a flash card to an Imagebank.

BATCH
Used to create new storage folders (batches) and name them.

DEFAULT APP LEVEL
Assigns a default approval status (classification) to all new images.

SETTINGS

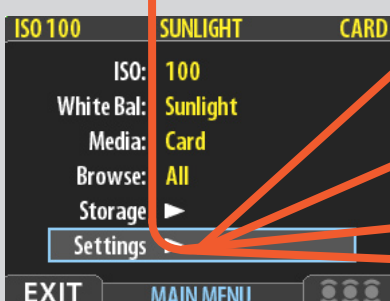

USER INTERFACE
Sets menu language, power down, sound, date & time and several other custom settings.

CAMERA
Sets which type of camera body is being used with the digital back.

MISCELLANEOUS
Sets the way the camera/digital back appears to a computer. Also displays firmware version.

DEFAULT
Resets all custom settings back to the original factory settings.

Introductory overview of menu access, navigation and settings choice.

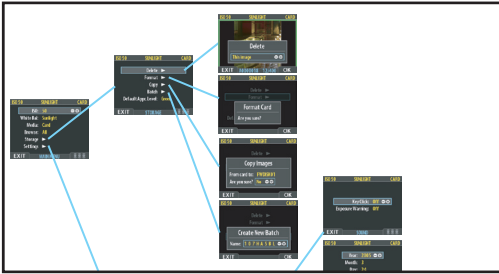

The menu is structured in a manner similar to cell phones and similar electronic devices.

Various branches within the tree system are accessed by pressing the navigation button until you reach the point where a choice has to be made.

The OK (Approve) button or SELECTION (Zoom-in/Zoom-out) buttons are then used to confirm choice.

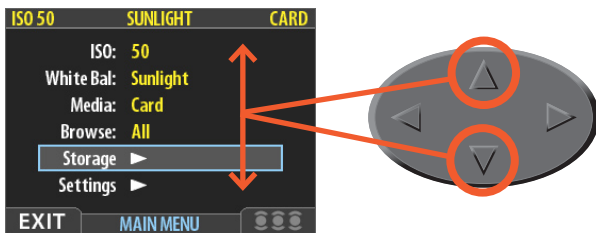

After pressing the MENU button, the main menu list appears. The blue frame highlights where you are on the menu. Press on the 'up' and 'down' symbols on the navigation button to move up and down the list.

You can return to the standard image view by pressing either on the 'left' symbol on the navigation button or on the EXIT/MENU button again.

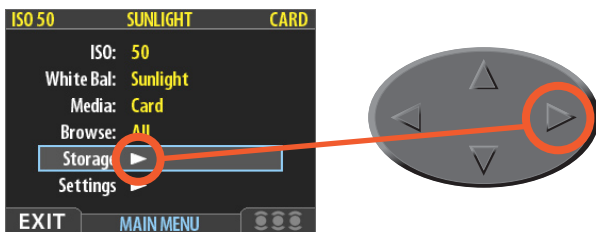

The need to continue further into the menu is indicated by the arrow symbol beside the menu item.

Press the 'right' arrow symbol on the navigation button to access the next part of the menu.

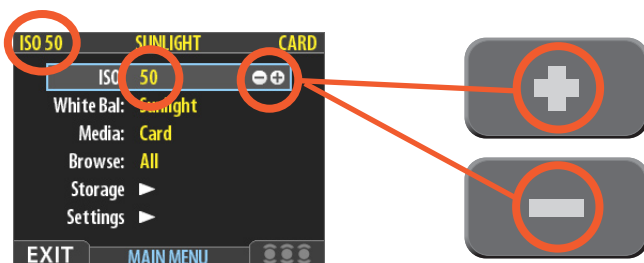

When you reach the final destination of your choice (this might take several moves), PLUS and MINUS symbols appear to the right in the frame round the item.

You then press the Zoom-in /Zoom-out /SELECTION buttons to access a loop list of choices.

In the example on the left, 50 is the ISO value shown. By pressing either button the alternatives appear – 100, 200, 400 and then back to 50 again – both on the list as well as on the upper row to the left (in the case of ISO value).

Pressing the EXIT/MENU button will then confirm the new setting.



In the next example on the left, the name of a new batch is changed by pressing a combination of the Zoom-in /Zoom-out /SELECTION buttons as well as the navigation button. You can then confirm your choice with the OK (Approve) button or revert to the previous status by pressing the EXIT/MENU button.

See later sections for more comprehensive information.

Setting the menu language

The menu is available in English, French, German, Italian, Spanish, Japanese and Chinese.

To choose any of the above languages, proceed as follows:

1. Press the **MENU** button to open the menu.
2. Press **▲** and **▼** to select the **SETTINGS** sub-menu.
3. Press **▶** to open the **SETTINGS** menu.
4. Press **▶** to select the **USER INTERFACE** sub-menu.
5. Press either the **+** or **-** button to choose a new language.
6. Press the **MENU/EXIT** button again to close the menu.

Setting ISO and white balance

The two digital settings that are most relevant for taking pictures are:

- the **ISO setting** ('speed')
- and
- the **white balance setting** ('colour temperature')

These are therefore available at the top level of the menu system so you can get to them quickly and easily. They are also shown on-screen in most preview modes, so you can easily keep an eye on them as your work.

Selecting the ISO rating:

The 503 CWD can be set to use a light-sensitivity rating equivalent to ISO 50, 100, 200 or 400 film. Note, however, that the “natural” sensitivity of the CCD is ISO 50, so you will get best results with this setting if your lighting allows it. As with film, which becomes grainier at higher ISO ratings, the camera will reveal progressively more noise in pictures taken at higher sensitivities.

The rating can be changed in a similar manner as the **Language** change described above or see **MAIN MENU > ISO** for a detailed procedure.

or

Make a setting on the camera grip menu. (**MENU > DIGITAL > ISO**)

Setting the white balance:

When you are looking at a scene, your eyes naturally adapt to the ambient light colour (provided it is nearly white) — your brain then interprets all other colours according to how they relate to this “neutral” colour. However, this means that when you take a photo and then look at it later, you might not get the colours you expect because the camera has an absolute idea of what “white” is. The digital back therefore provides a white balance setting, which sets the hue that it should consider to be white and interprets all other colours proportionately.

Unlike many digital backs, the 503 CWD stores images as raw captures, which means they contain an exact image of the CCD (including its original mosaic colour filter). You are therefore able to adjust the white balance at any time to equal effect. When you set a colour balance, your setting is saved with the image as pair of light temperature and tone values — the colour values measured by each pixel are not altered. Your white balance setting affects the way colours are shown in the digital back screen and will still have the same effect when you first open images on your computer. You



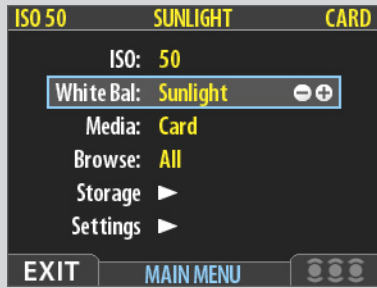

can change the setting later using FlexColor or another program that reads DNG files and the effect will be the same as though you had set it before shooting.

The 503 CWD provides several options for establishing the white balance, including:

- **Sunlight, cloudy, shadow, flash, fluorescent and tungsten**

 Please note that white balance settings are for your viewing convenience only. The setting is temporary and in no way affects the raw file permanently.



The rating can be changed in a similar manner as the **Language** change described above or see **MAIN MENU > White Bal** for a detailed procedure.

Menu Shortcuts !

To help you work faster, the digital back provides shortcuts to some of the most commonly used menu commands that do not otherwise have a dedicated button on the front panel. These are accessible by

pressing and holding one of the front-panel buttons for a second or so. These are mentioned where appropriate elsewhere in this manual, but we summarize them here for your convenience.

The following shortcuts are available:

	<p>• To set the browse filter</p>	<p>Press and hold until your preferred filter is indicated. Repeat if necessary. See also Using Instant Approval Architecture.</p>
	<p>• To delete images</p>	<p>Select the target image and then press and hold ▼ until the delete dialog opens. See also MAIN MENU > Delete.</p>
	<p>• To toggle the overexposure indicator</p>	<p>Press and hold ▲ until the display begins to flash (or stops flashing) its overexposed areas. See also Overexposure Indicator.</p>

Storage overview— Working with media and batches

503 CWD

General

Whichever way you choose to store your images, they should be filed in batches for efficient workflow.

Organizing your work with batches

Batches help you to organize your shots as you work. They function just like folders on a computer. Batches have the following properties:

- *When you create a new batch, you assign a name to it and it is created as a new folder.*
- *When you copy images from a compact-flash card, each batch is saved as a sub-folder on the destination disk.*
- *When deleting multiple images, you are able to restrict your delete command so that it affects just a single batch.*
- *When browsing images, you will only see images from the current batch.*
- *You can change between batches by using the navigation controls of the digital back front panel.*
- *The OLED shows the date on which each batch was created.*

 Please note that each new image will be saved in the latest created batch only. You cannot select any other batch to save a new image in.

Navigating media and batches

The camera always works with a **current medium** and a **current batch**. This is the location at which the camera will save all new shots and the location in which you can browse using the navigator button on the front panel. There are two ways of selecting the current medium and/or batch:

- *Using the zoom and navigator buttons of the front panel. This method enables you to select any existing batch and is therefore useful even when only one type of medium is attached. This method is explained in the procedure below.*
- *Using the MAIN MENU > Storage entry of the menu system to choose a medium. This is only relevant when more than one medium is attached (e.g., both a compact flash card and an Imagebank). When you use this function, you will always go to the most recently created batch from the medium you select. Please see Selecting the Current Storage Medium for a complete description of this method.*

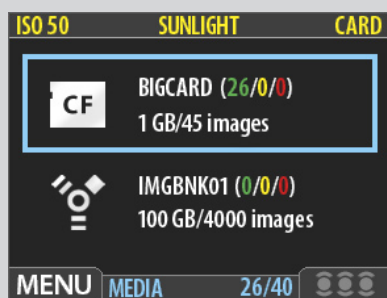
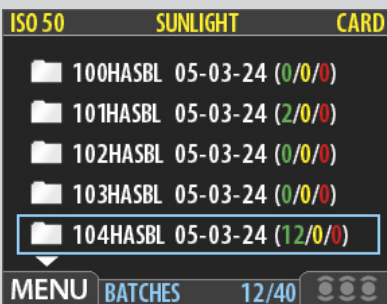

The MEDIA list.

In this example a CF card and a FireWire disk are illustrated and therefore connected.

The blue frame around the CF card symbol tells you that captured images will be saved to the CF card and not the FireWire disk. This is the **Current Medium**

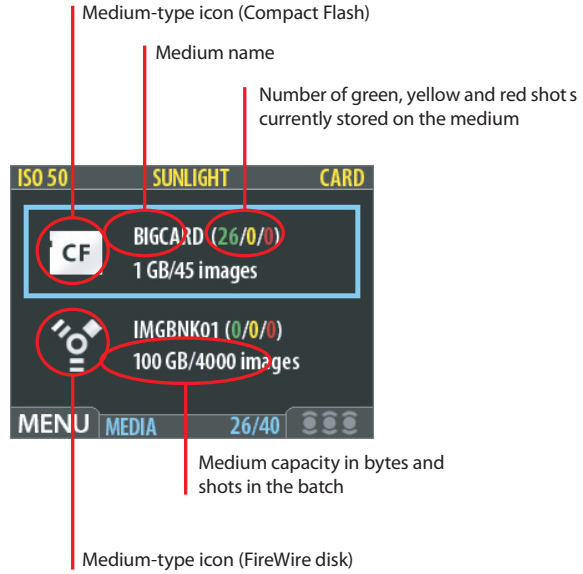

The BATCH list.

The blue frame around the middle folder tells you that it is the **Current Batch**.

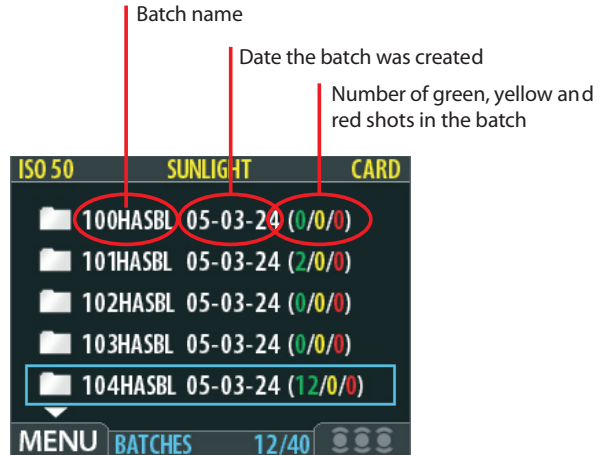

You work your way deeper into the menu branching off the selected item (framed in blue) each time you press the '+' button to view media, batch, thumbnail view etc.

Conversely, you work your way back out of the menu each time you press the '-' button.

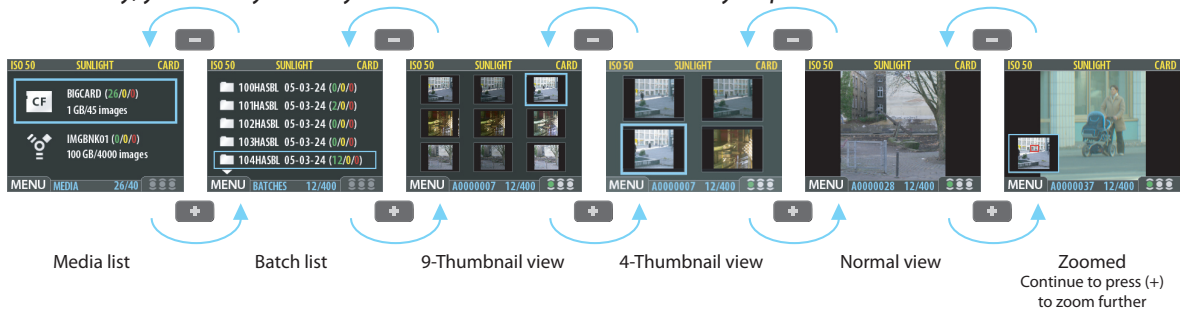

To select the current medium and batch using the browse controls:

1. Press the zoom-out (◀) button repeatedly until you are all the way at the top zoom level. If you start with the single-image preview view, then you pass through the following views to get there:

- Single-image preview
- Four-thumb-nail view
- Nine-thumb-nail view
- Batch list
- Media list

2. The screen now shows a list of media devices currently connected to the digital back. Often, there is only one.

Each medium shows a name, total size and an estimate for how many images will fit on it. To the right of the medium name is a set of three coloured numbers in parentheses. These indicate the total number of images of each approval status (green, yellow and red) that currently exist on that medium.

For example, if you see a card that shows (18/5/3), then that card contains a total of 26 images:

18 green (approved),
5 yellow (unclassified) and
3 red (delete).

3. If more than one medium is listed, then use ▲ and ▼ to highlight the medium you wish to use.

4. The currently selected medium shows a blue border.

5. Press the zoom-in (▶) button to zoom-in on the currently highlighted medium.

6. A list of batches on this medium now appears. Each batch shows a folder icon, a name and the date on which it was created. As with the media list, you can read the number of shots of each approval status that are stored in each batch.

7. As with media, use ▲ and ▼ to highlight the batch you wish to use.

8. The currently selected batch shows a blue border.

9. Press the zoom-in (▶) button to zoom in on the currently highlighted batch.

10. The nine-thumb-nail view of your selected batch now appears.

Creating new batches

You can create any number of batches on each medium. To create a new batch, first make sure you have selected the correct current medium (see **Navigating Media and Batches**) and then use the **MAIN MENU > STORAGE > BATCH** entry of the menu system to create the new batch. See **Creating Batches** for a detailed procedure.

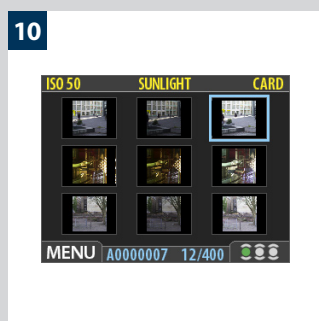
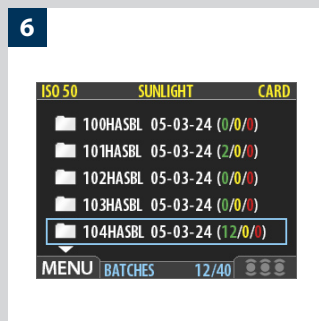
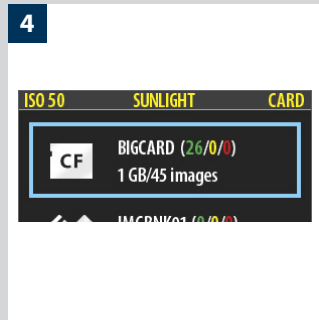
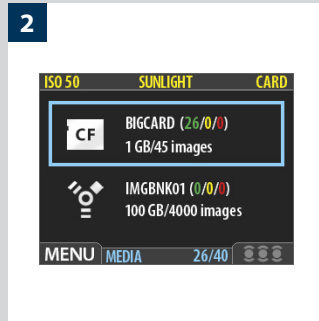

Using Instant Approval Architecture

The Instant Approval Architecture system helps you to classify your images as quickly as you take them. It works by supplying immediate audio feedback, which tells you instantly whether each new picture is exposed correctly or likely to be over- or underexposed. Thereafter, the system enables you to assign each image one of three status levels. Though you can use the system any way you like, the intention (based on the 'traffic light' principle) is that you should assign the levels as follows:

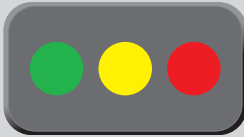

- **GREEN** for your best shots.
- **YELLOW (AMBER)** for images that need closer inspection.
- **RED** for images that should probably not be used.

 Please note, when the current storage medium is full, red-status images will be deleted (one at a time) to make room for new shots. You can continue shooting until no red-status images remain; if you then try to take additional new shots you will get a medium-full message.



Image File Name
Green images start with "A",
yellow with "B" and red with "C"

Current approval status (green)
and browse-filter setting (show all)



Press the approve button to change the status of the currently selected image.



Press and hold the approve button to scroll through the browse filter settings; release when your preferred setting is shown



Show all



Show green and yellow only



Show green only



Show yellow only



Show red only

 Please note the two different actions of pressing (or quickly clicking) the approve button to change the status and pressing and holding to change the browse filter!

One of the greatest advantages of digital photography compared to film is that it costs no more to shoot 100 images that it does to shoot one. Photographers therefore tend to take many more pictures when shooting digitally. By assigning approval levels as you work, it can be much easier to sort through and select images when you get back to your computer.

Standard Instant Approval workflow

The standard method of working with the Instant Approval Architecture is as follows:

1. Take a shot.
2. The camera analyzes the shot to find out if it seems to be over- or underexposed. If it suspects a problem, it does the following:
 - Provides audio feedback (if this option has been chosen) by making a warning sound, which immediately alerts you to a possible problem even if you are not looking at the screen. The warning sound is a rapid string of notes going up the musical scale if the image is judged as overexposed or conversely a rapid string of notes going down the musical scale if the image is judged as underexposed
 - Downgrades the approval status to yellow (if Approval is set to 'Auto').



Note that some shots may trigger the warning even though they are exposed according to your intentions. You should consider these warnings only as a guideline. This feature can be turned off.

3. If no problem is detected, then the image is saved with green status.

If you set Approval to 'Auto', all images will be stored as Green if judged as correct and Yellow if judged as technically doubtful. No images are ever stored as Red automatically!

4. When you are browsing through your shots, keep an eye on the approval status of each and consider whether you should promote or demote each shot based on its appearance on the preview screen. You can also apply a browse filter to, for example, browse only red shots when looking for images to delete or to browse only green shots to make sure you have a good version of each shot that you need.

5. When you begin working with the images on your computer, use the approval status as a guide for organizing your work. For example, you might begin by opening and optimizing the green shots and then go to the yellow shots only if you still need more images and then, finally, check the red shots as a last resort.

Note that the system is very flexible so you can use it in any way that you like. For example, you can set the camera to assign all new images a yellow or green status regardless of the exposure warning. Be careful when assigning red status because red images may be deleted if the current storage medium becomes full.

Reading and changing the approval status

The current approval status of each shot is indicated in two ways:

- **In most preview modes, the current status is indicated by a coloured dot in the bottom-right corner of the screen.**
- **Each image is given a name that indicates its approval status. Approved (green) image names start with "A" (e.g., "A0000043"); warning (yellow) images start with "B" (e.g., "B0000043"); and images marked for delete (red) start with "C". Because of this naming convention, you will also be able to sort your image files by status after you have copied them to your computer (e.g., by listing the folder by file name).**



See also the diagram showing where you can read the image name and approval status on the screen.

By keeping an eye on the file name and/or coloured dot as you browse your images at the single-image, four-thumbnailed or nine-thumbnailed level, you can easily see the current approval status of each of them.

To change the approval status of the currently displayed/selected image, simply press the approval button until the desired approval status is shown.

Note that you can set the camera to filter by approval status as you browse, which means that some images may be hidden (though they are still there). See "Browsing by Approval Status", below, for details about how to work with the filter.

Be careful when assigning red status because red images may be deleted if the current storage medium becomes full.

Browsing by approval status

You can set the camera to browse by approval status, which means, for example, that you will see only green-status images as you browse a batch (or both green and yellow, or only red, etc.). The current filter setting is indicated on-screen, as illustrated. Filtered images are still there, but they will not be shown until you change the filter setting. Also, if you change the status of an image, the image may 'disappear' if it no longer passes the filter. For example, if you have set the camera to browse only green-status images and then change an image to yellow status, that image will not be shown again until you change the browse filter.



There are many ways to make use of this feature. For example:

- *Set the filter to show only yellow images. Then step through each image and decide whether any of them should be promoted to green or demoted red.*
- *If you are running out of space, set the filter to show only red images and then step through to find shots you can delete.*
- *Set the filter to show only green images. Then step through to make sure you have at least one 'good' example of each shot that you need.*

There are two ways to set the browse filter:

- *Press and hold  until the filter you want to use is shown by the indicator.*
- *Use the MAIN MENU > Browse entry of the menu system. See **Setting the Browse Filter** for a detailed procedure.*

Deleting by approval status

There are many ways to delete images, including one-at-a-time and multiple delete by batch, media and/or approval status. When deleting several images, you first pick the medium or batch from which you want to delete and then use the **MAIN MENU > STORAGE > Delete** entry to specify the status of the images to delete. You can choose to delete:

- *All red-status images from the selected batch or medium*
- *All red- and yellow-status images from the selected batch or medium*
- *All images from the selected batch or medium*

See **MAIN MENU > Delete** for detailed procedures describing each of the delete options.

Setting the default status

As outlined in “Standard Instant Approval Workflow”, the camera normally works by assigning a green status to all images that pass a basic exposure test and a yellow status to all images that fail the test. However, you can change this behaviour if you prefer an alternative workflow. You have the following options:

- **Auto:** *works as described in Standard Instant Approval Workflow .*
- **Green:** *gives all new images a green status, regardless of the exposure warning.*
- **Yellow:** *gives all new images a yellow status, regardless of the exposure warning.*

Regardless of this setting, audio feedback will still be provided if an image is judged to be badly exposed.

Use the **MAIN MENU > BROWSE** entry to make this setting. See also **Setting the Default Approval Status** for a detailed procedure.

Overview of viewing, deleting and copying images

503 CWD



Basic image browsing

The large, full-colour OLED display enables you to inspect your shots while you are still on-location. The display offers full-screen previews, high-magnification zoom, two levels of thumbnails and analysis tools including a full histogram and camera settings.

When you first turn on the camera, the display opens in standard browse mode, showing the last image taken (if any) for the current medium and batch. Likewise, after each new shot, the display shows a preview of the shot.

To browse the images of the current batch, simply press the left ◀ and right ▶ arrows of the navigator button.

Choosing the current batch

When you browse using the navigator button, you will only see images from the current batch on the current medium. To view another batch, you must navigate to it by zooming out to the batch or media level and then zooming in on the appropriate folder. See **Navigating Media and Batches** for complete details about how to select the current medium and/or batch.

Browsing by approval status

It is possible to set the camera to browse only images of one or more specific approval levels from the current batch. You can use this, for example, to review all of your red-status shots to make sure you don't need them or to review all of your yellow-status shots to decide whether they should be moved to green or red status. When you use the browse filter, you will not see images excluded by the filter, but they are still there.

See **Using Instant Approval Architecture** for complete details about how to check and set the browse filter.

Zooming in and out

As illustrated below, you can use the **+** or **-** button to see various levels of detail in your images. You can furthermore zoom all the way out to view and select batches and media.

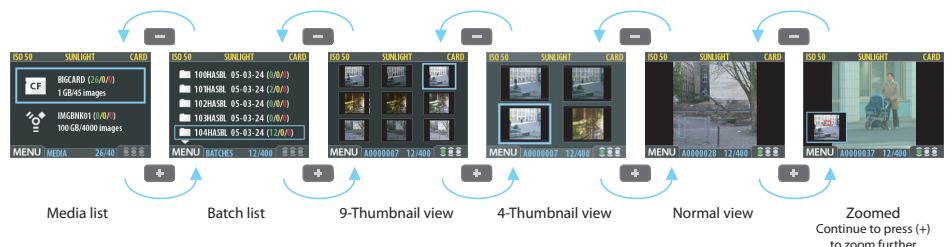

Zooming in for more detail

The preview display has a much lower resolution than your images. You can therefore zoom very far into the images to inspect small details. To do this:

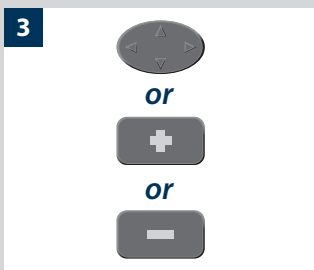

1. Browse to the image you wish to zoom into with the navigation button.
2. Press the zoom-in (+) button to zoom in one step. The screen updates to show both a zoomed image and a thumbnail image that includes a red box outlining the portion of the images currently shown.
3. You can now do the following as needed:
 - Use the navigator button to move the zoom area if you wish to inspect a different part of the image.
 - Zoom further by pressing the zoom-in (+) button more times.
 - Zoom back out one step by pressing the zoom-out (-) button.
4. When you are finished, press and hold the zoom-out (-) button to return to browsing at the standard zoom level.

Thumbnail views

Preview thumbnails are small versions of each preview, sized to fit either four or nine images on the screen at once. Use them to get an overview of your work so far and to help find specific shots.

To see the thumbnails, start with the standard preview display and press the zoom-out button once to see four thumbnails or twice to see nine.

When viewing thumbnails, the selected image shows a blue border. When an image is selected, you can zoom in on it using the zoom-in button or delete it using **MAIN MENU > STORAGE > Delete** (see also **MAIN MENU > STORAGE > Delete** for a detailed procedure). Use ▲ and ▼ to scroll the thumbnails when you have more shots than can be shown.

*✎ If you continue to zoom out beyond the nine-thumb view, you will come to the batch list and then to the media list. You can use this to select the current medium and batch for browsing and for storing new images. See **Working with Media and Batches** for details.*

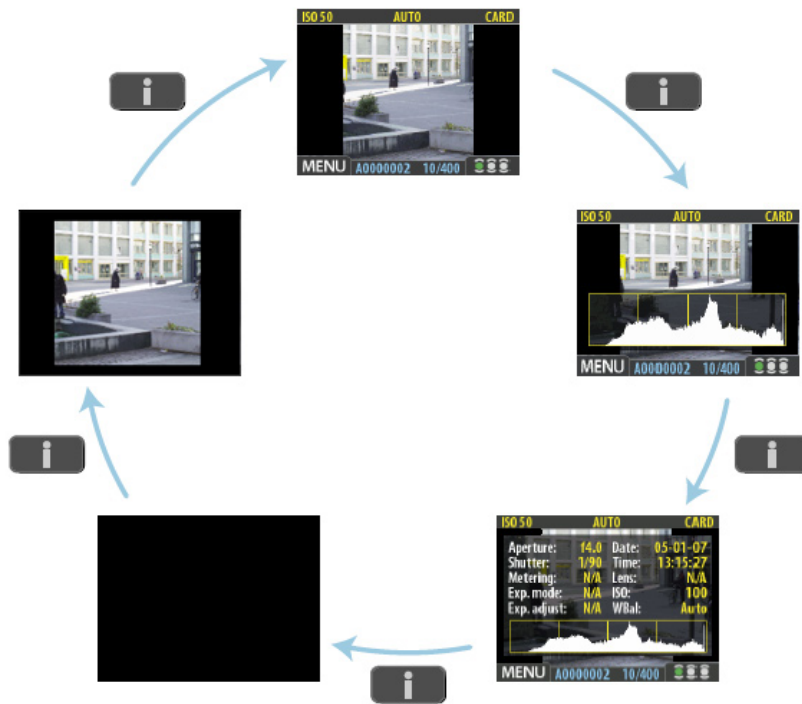

You can cycle through all the available preview modes by pressing the **View-Mode** button.

Preview Modes

Choosing the Preview mode

You can use the view-mode button to cycle through the available preview modes. The preview screen works in several different modes:

- **Standard preview:**
shows a preview image surrounded by a display of few important settings.
- **Histogram:**
shows a preview image overlaid with a histogram.
- **Histogram and full details:**
shows a preview image overlaid with both a histogram and camera-setting details.
- **Battery saver:**
turns off the screen, but you can still use the menus and take pictures.
- **Full-screen preview:**
shows the preview only, with no frame or settings information.

To cycle through the various modes, press the view-mode button on the front panel. The order is circular, as listed above. Each mode is described in detail in the sub-sections below.

Regardless of the current mode, if you zoom in on the image or zoom out to the thumbnails, the display reverts to showing the “standard” preview frame, which shows information about the current image and camera settings around the edges. When you return to the standard zoom level, however, you will then also return to your last-selected preview mode.

Note that the screen can also operate in menu mode, which does not show a preview, but enables you to make digital back settings. To enter menu mode, press the menu button. See ‘Working with the Menus’ for details.



The standard preview display

The standard preview display is the one shown when you first turn on the camera. It features a preview of your most recent shot and basic information about the digital back settings and the image itself.

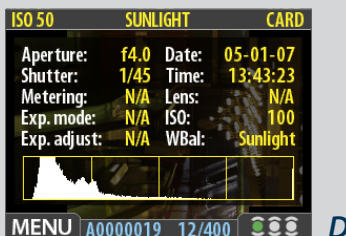
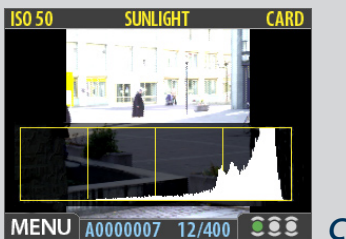
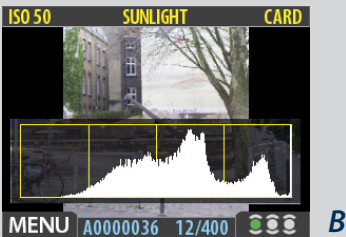
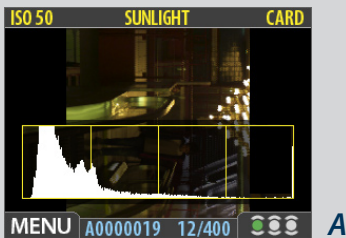
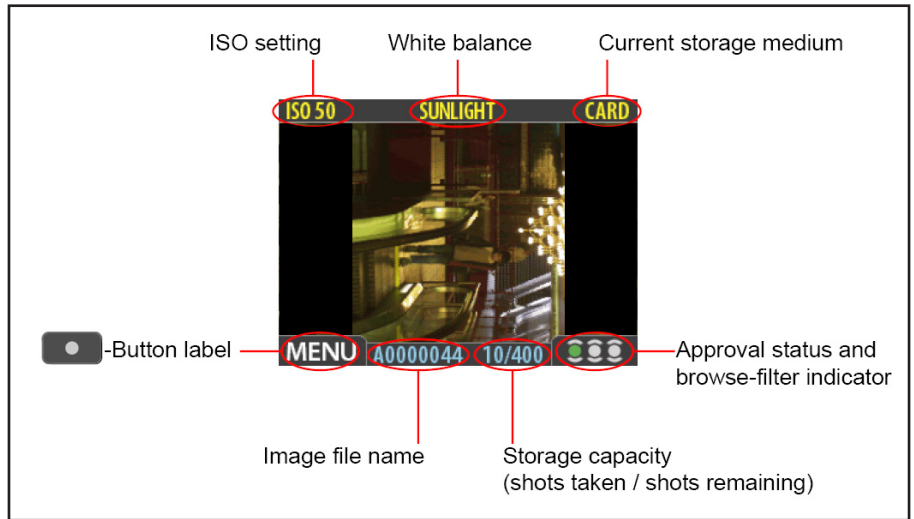

Using the histogram

The histogram provides a graph that indicates the total number of pixels at each brightness level, with brightnesses going from black on the left to white on the right. It is a valuable tool for evaluating your exposure. A well-exposed shot usually has a full range of levels, while under- and overexposed shots tend to show levels concentrated at the left or right part of the scale, respectively.

For example:

Underexposure **A**

A histogram that is cut-off at the left with few pixels elsewhere indicates a likely underexposure. Many details will be lost in the shadows.

Even exposure **B**

A histogram that is spread across the full range indicates a likely good exposure. There may still be a few pixels at the extremes, indicating a few spectral highlights and saturated shadows, but this is often normal in a good exposure.

Overexposure **C**

A histogram that is cut-off at the right with few pixels elsewhere indicates a likely overexposure. Many details will be lost in the highlights.

 *The histogram is only an indicator that should be interpreted—there are many situations in which a questionable histogram will match an exposure that is perfectly fine for the intended effect (and vice-versa).*

Full-details mode **D**

In full-details mode, you can read a complete list of camera settings, plus see the histogram and, in the background, a darkened preview of the image.

The camera-setting details are stored with the image, so you can refer to them using FlexColor even after you have loaded the image to your computer and stored it in your archive.

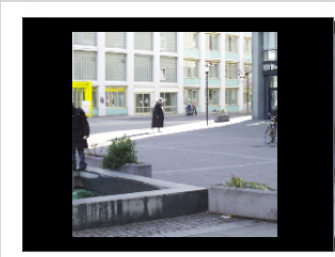

Battery-saver mode

In this mode, the digital back is fully responsive, so you can take pictures but the screen is not lit up, thereby saving battery power.

You can enter the menu system while shooting in this mode (which activates the screen until you exit the menu system again) but the approval, zoom and navigator buttons have no effect.

 You can also save battery power by turning down the brightness and/or contrast of the display using the entries of the **MAIN MENU > SETTINGS > USER INTERFACE > DISPLAY** menu. See **Making Display Settings** for details.

 Other ways to save battery power include setting a display time-out and/or a power-down time-out (each of these is disabled by default). Use **MAIN MENU > SETTINGS > USER INTERFACE > Power Down** to set a power-down time out. Use **MAIN MENU > SETTINGS > USER INTERFACE > DISPLAY > Timeout** to set a display time-out. See also **Entries of the USER INTERFACE Menu** and **Making Display Settings** for details about these settings.

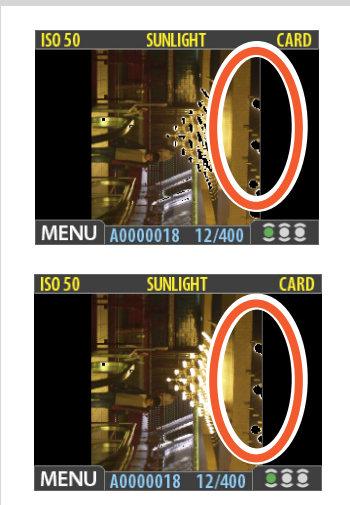

Full-screen mode

In full-screen mode, you can browse your images at standard preview resolution without any distracting data surrounding them.

Because the current approval setting is not shown in full-screen mode, the approval button has no effect. This will prevent you from accidentally assigning the wrong status without knowing it.

Overexposure indicator

Though the histogram shows you when some of your pixels are overexposed, it does not tell you which ones. In a shot with many bright areas, it can be hard to know whether the key parts of your image are just bright or completely overexposed. To help you find them, the digital back can provide an overexposure indicator, which shows precisely which areas of your shot are overexposed (i.e., pixels that are at maximum brightness, thereby eliminating details).

When enabled, the overexposure indicator flashes the overexposed pixels from black to white.

To enable or disable the overexposure indicator, use the **MAIN MENU > SETTINGS > USER INTERFACE > Mark Overexp.** entry.

Please see **Entries of the USER INTERFACE Menu** for a detailed procedure.

Overexposure indicator shortcut!



There is also a one-button shortcut for toggling the overexposure marker on and off.

To use it, press and hold **▲** until the indicator is working as you would like (enabled or disabled).

Delete shortcut!

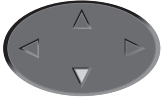

There is also a one-button shortcut for deleting single images. To use it, select a target image and then press and hold the ▼ until the confirm-delete dialog opens.

Deleting images – general

The CFV enables you to delete images using any of the following techniques:

- **Delete the currently selected image only.**
- **Delete all images from the current batch**
- **Delete all images from the current medium**
- **Delete all red-status images from the current batch**
- **Delete all red-status images from the current medium**
- **Delete all red- or yellow-status images from the current batch**
- **Delete all red- or yellow-status images from the current medium**

 Another way of working is to simply assign unwanted images as Red. In this way, you retain the option (for a while) of changing your mind later while allowing the system to automatically delete the unwanted images as the storage medium fills up.

 You will always be asked to confirm each delete operation.

For complete details about how to use the menu system to delete single or multiple images, please see **MAIN MENU > STORAGE > Delete**.

Transferring / Copying images – general

Transferring to a computer

To transfer images stored on the compact-flash card to your computer, simply connect the digital back to a computer using a FireWire cable and then run FlexColor, which will automate the process. See your FlexColor manual for details.

See also **Connecting to the Computer** for details about how to connect to a computer.

Another way to transfer images to your computer is to remove the compact-flash card from the digital back and insert it into a compact-flash card reader connected to a computer. See **Using Compact Flash Memory Cards** for details about how to remove and insert the card.

The 503CWD can also function as a CF card reader for file transference. Select **MAIN MENU > SETTINGS > Misc > Interface > Disk**.

Images that you have stored on an Imagebank can also be transferred to a computer by connected the external disk to the computer with a FireWire cable and then copying the files using the file system. See your Imagebank or hard disk documentation for details.

Transferring to an Imagebank

The CFV enables you to work in the field, shooting to the internal card, and then transfer images to an external hard disk even if you do not have a computer with you. In this way, you can combine the total flexibility of shooting without any external connections with the massive storage capacity of an external hard disk.

When the internal card gets full, just connect the camera to a Imagebank, transfer the images, clear the card and return to shooting.

Images are not automatically deleted from the card after copying. If you want to delete some or all images to free up some space, then use **MAIN MENU > STORAGE > Delete**.

See also **MAIN MENU > STORAGE > Delete**.

Working with the menu settings

503 CWD

Menu system overview

The main menu contains those settings that you will need to access most often as you work on an assignment. It also provides sub-menus that give you access to all other settings, most of which you will need less often.

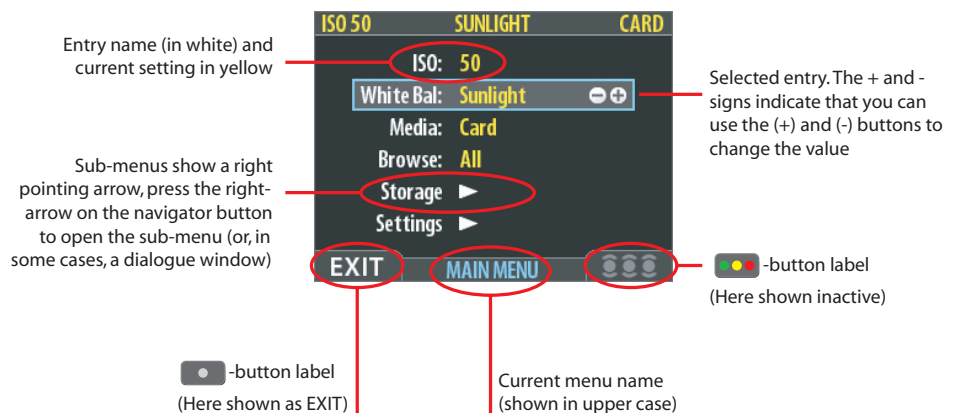

Navigating the menu system

To enter to the menu system, press the **MENU** button on the panel. Any image visible is then replaced by the first level of the menu. Use the navigator button to scroll through the menu items and use the **+** and **-** buttons to change the selected setting. See also **The Control Panel** for button diagrams and descriptions.

Any given menu may include both entries and/or sub-menus.

- **Entries are settings that are available at the current menu level; they show their current settings next to the entry name. To make an entry setting, use the navigator (◂) button to select the entry and then use the zoom (+ and -) buttons to select the desired option for that entry**
- **Sub-menus do not have settings at the current level; they lead to another menu or dialog. Sub-menus show a right-pointing arrowhead (▶) instead of a value. To open a sub-menu, use the up/down arrowheads (▲ and ▼) of the navigator button to select the sub-menu and then press the right side of the button to open it. There can be several levels of sub-menus.**
- **When you are in a sub-menu, you can go back to the parent menu by pressing the left arrowhead (◀) of the navigator button.**
- **Some sub-menus open a dialog. Dialogs require that you either make a setting or exit the dialog (e.g., to confirm or cancel a delete command). The left arrowhead will have no effect.**

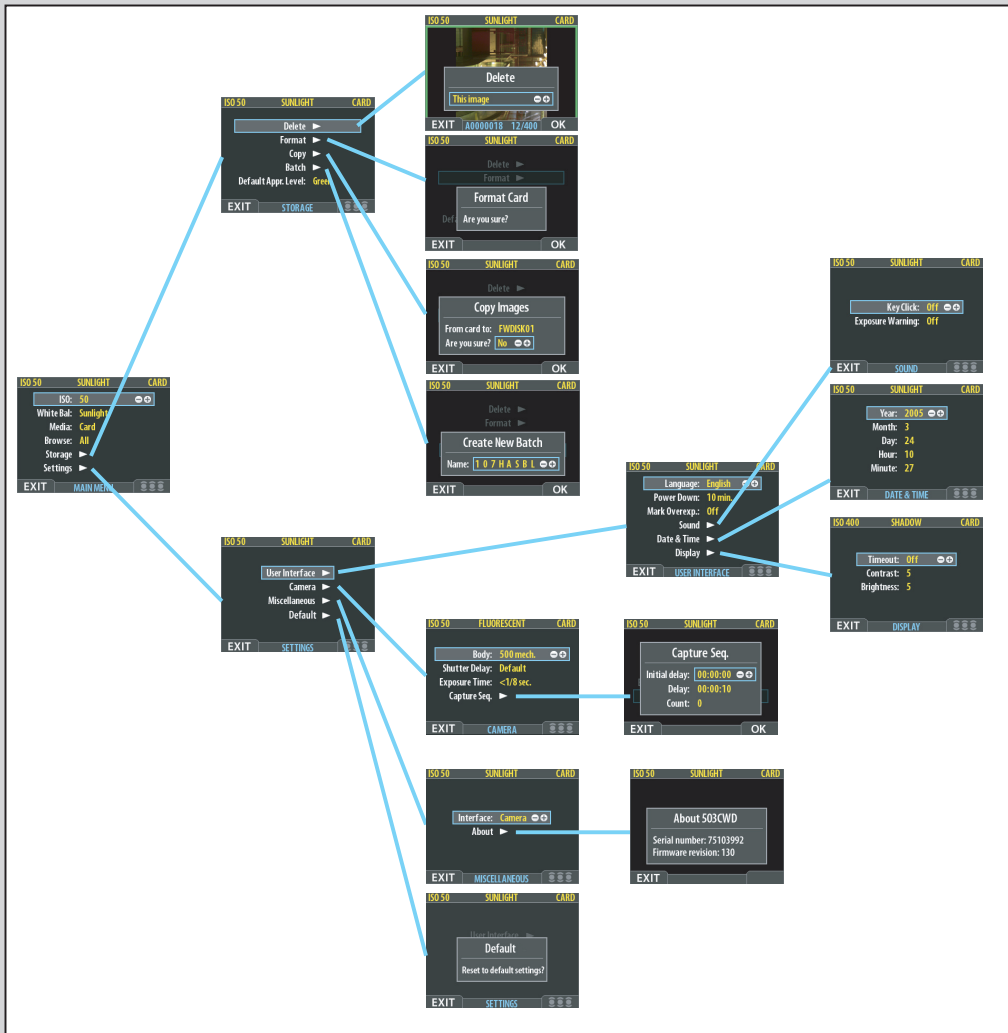

Menu structure

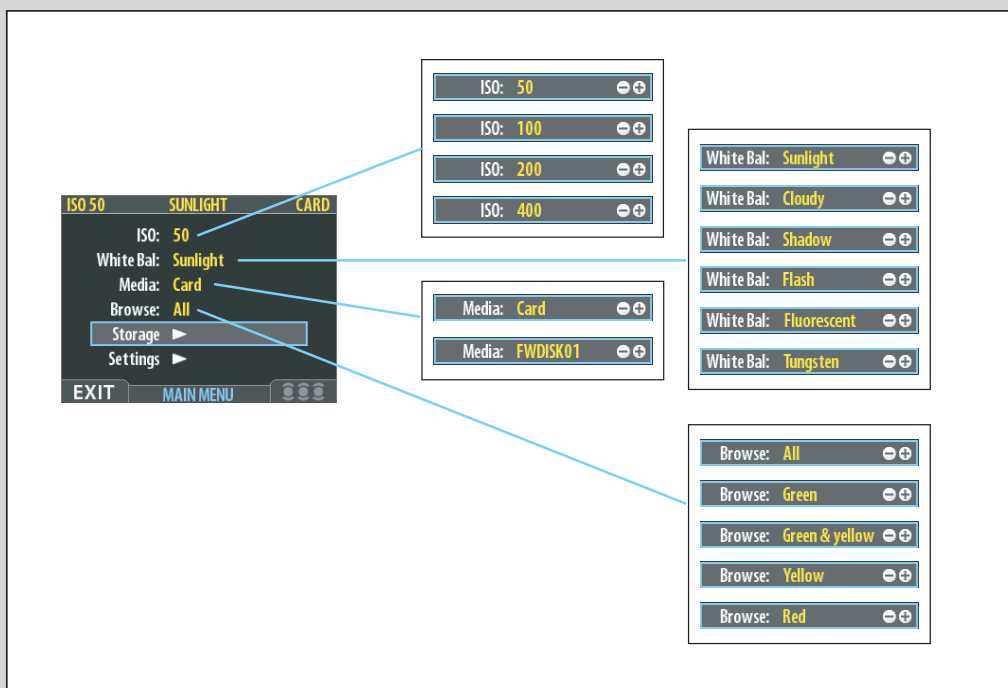

Entries of the main menu

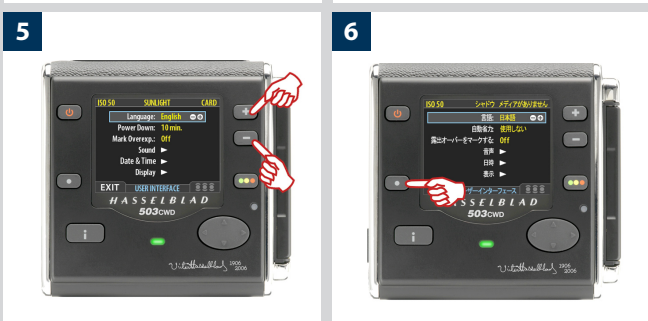

So, for example, when the text says to select the **MAIN MENU > SETTINGS > USER INTERFACE > Language** entry, you should do the following:

1. Press the menu (**MENU**) button to open the menu.
2. Use **▲** and **▼** to select the **SETTINGS** sub-menu.
3. Press **▶** to open the **SETTINGS** menu.
4. Press **▶** to select the **USER INTERFACE** sub-menu.
5. Press either the **+** or **-** button to choose a new language (in this case Spanish).
6. Press the **MENU/EXIT** button again to close the menu.

Note also that the menu and approval buttons are situated just outside the bottom-left and bottom-right corners of the screen. As you work through the various menu entries, the screen shows a label for each of these buttons. In the text, we therefore give the generic name for the button and the screen name. For example we will refer to: the menu (**MENU**) button, the menu (**EXIT**) button, or the approval (**OK**) button.

ISO

You are able to set the light sensitivity of the digital back to match an equivalent ISO rating for standard film.

The ISO rating can be set to 50, 100, 200 or 400.

To set the ISO:

1. Select the **MAIN MENU > ISO** entry. This is the top entry of the top menu, so it will be selected by default when you enter the menu system. (See also **Navigating the Menu System** for details about how to find this setting.)
2. Use the **+** or **-** button to step through the available ISO settings until the setting you want is shown.
3. Either move on to another setting by using the navigator button or press the menu button to exit the menu system and keep your setting.

 Note that the default sensitivity of the CCD sensor is ISO 50. Higher ISO settings result in progressively noisier images (just as higher ISO film become grainier). It is recommended that you use the lowest ISO setting possible for the lighting situation.



There are six 'White Balance' settings to choose from.

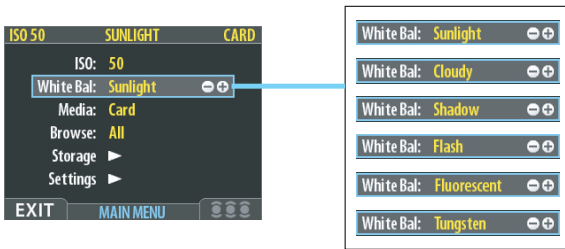

Sunlight	For general outdoor use in direct sunlight.
Cloudy	For general outdoor use in cloudy weather.
Shadow	For general outdoor use in shady locations out of direct sunlight.
Flash	For general indoor use when using a typical flash system.
Fluorescent	For use when using fluorescent lighting.
Tungsten	For use when shooting indoors under standard tungsten lamps.

White balance

Use this entry to set the white balance saved with the image and applied to the preview.

To select a preset white balance:

1. Select the **MAIN MENU > White Bal** entry. The current setting is displayed here. (See also **Navigating the Menu System** for details about how to find this setting.)
2. Use the **+** or **-** button to step through the available white balance settings until the setting you want is shown.
3. Either move on to another setting by using the navigator button or press the menu button to exit the menu system and keep your setting.

 Please note that white balance settings are for your viewing convenience only. The setting is temporary for preview display reasons and in no way affects the file which remains neutral awaiting further processing.

Media

The storage setting controls where your digital back will store new images and which stored images will be visible in the browse window.

Often, you have just one type of storage media available—the internal compact-flash card. However, if you have several media attached (e.g., a card and one or more external disks), then you may need to switch between them.

If your selected storage medium has more than one batch (folder) on it, then the batch selected when you use the storage menu entry will be the one you most recently created.

To select the medium to which to save new shots and from which to browse previous shots:

1. Press the **MENU** button.
2. Use **▲** and **▼** to select the **MEDIA** sub-menu.
3. Use the **+** or **-** button to step through the available media until the name for destination/source you wish to use is shown.
4. Either move on to another setting by using the navigator button, or:
5. Press the **MENU** button to exit the menu system and keep your setting.

Note that you can also select media using just the **+** and **-** buttons while browsing images. This method also enables you to select a batch as you zoom in from media to batch to thumbnails to preview. See **Navigating Media and Batches** for complete details about this method.

 Note that you can also select media using just the **+** and **-** buttons while browsing images. This method also enables you to select a batch as you zoom in from media to batch to thumbnails to preview. See **Navigating Media and Batches** for complete details about this method.

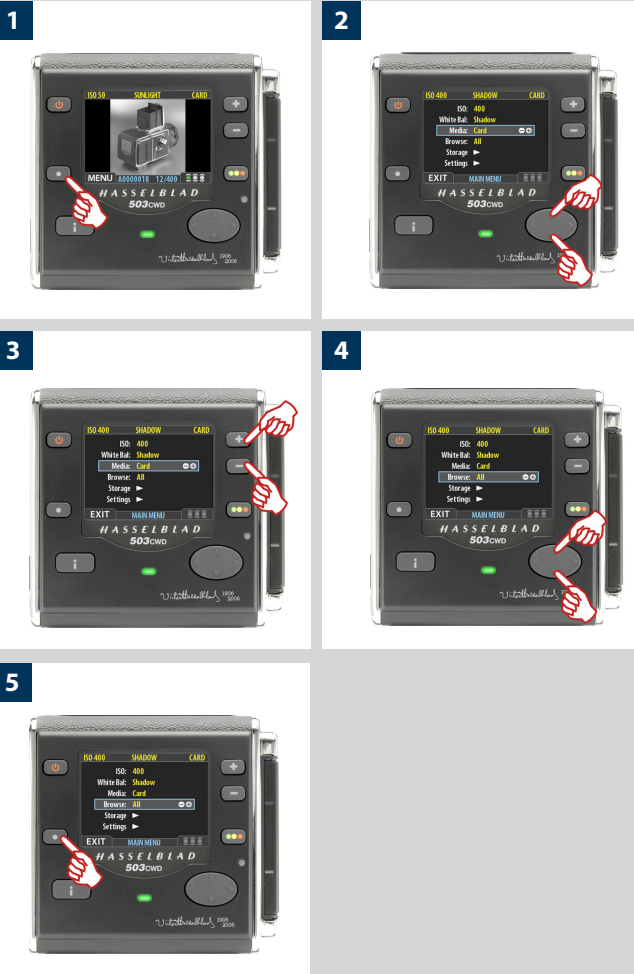

1



2

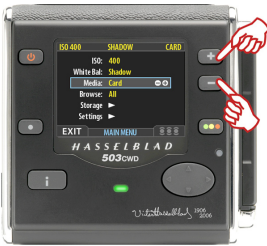

3



Browse shortcut !



There is also a one-button shortcut for changing the browse filter.

To use it, press and hold (do not click!) the Instant Approval button until the approval status colour appears. Browsing will then only display the images with that classification.

Browse

The browse filter complements the instant-approval system by enabling you to browse through images according to their approval status. You have the following choices:

- **All:** browses all of the images in the current batch, regardless of their approval status. This is the default.
- **Red:** browses only red-status images from the current batch. These are images that you have marked for likely deletion. You might browse these images to make sure you have not eliminated any usable images and/or to find images that you can delete to make room for new shots.
- **Green:** browses only green-status images from the current batch. These are either new shots that did not trigger an exposure warning or shots that you manually assigned to green after overriding an exposure warning.
- **Green & Yellow:** browses green and yellow-status images, but does not show red-status images. These are probably images that you have either decided to keep or not yet checked for approval status.

For more information about using the instant-approval system, please see **Using Instant Approval Architecture**.

To set the browse filter using the menus:

1. Select the **MAIN MENU > Browse** entry. The current setting is displayed here.
2. Use the **+** or **-** button to step through the filter options (described above) until you have selected the filter you wish to use.
3. Either move on to another setting by using the navigator button or press the menu button to exit the menu system and keep your setting.

The appearance of the 'Empty Browse Filter' message signifies that there are no images with that particular approval status.

STORAGE

This section describes file storage, file transference, storage organization, file classification and related subjects.

503 CWD

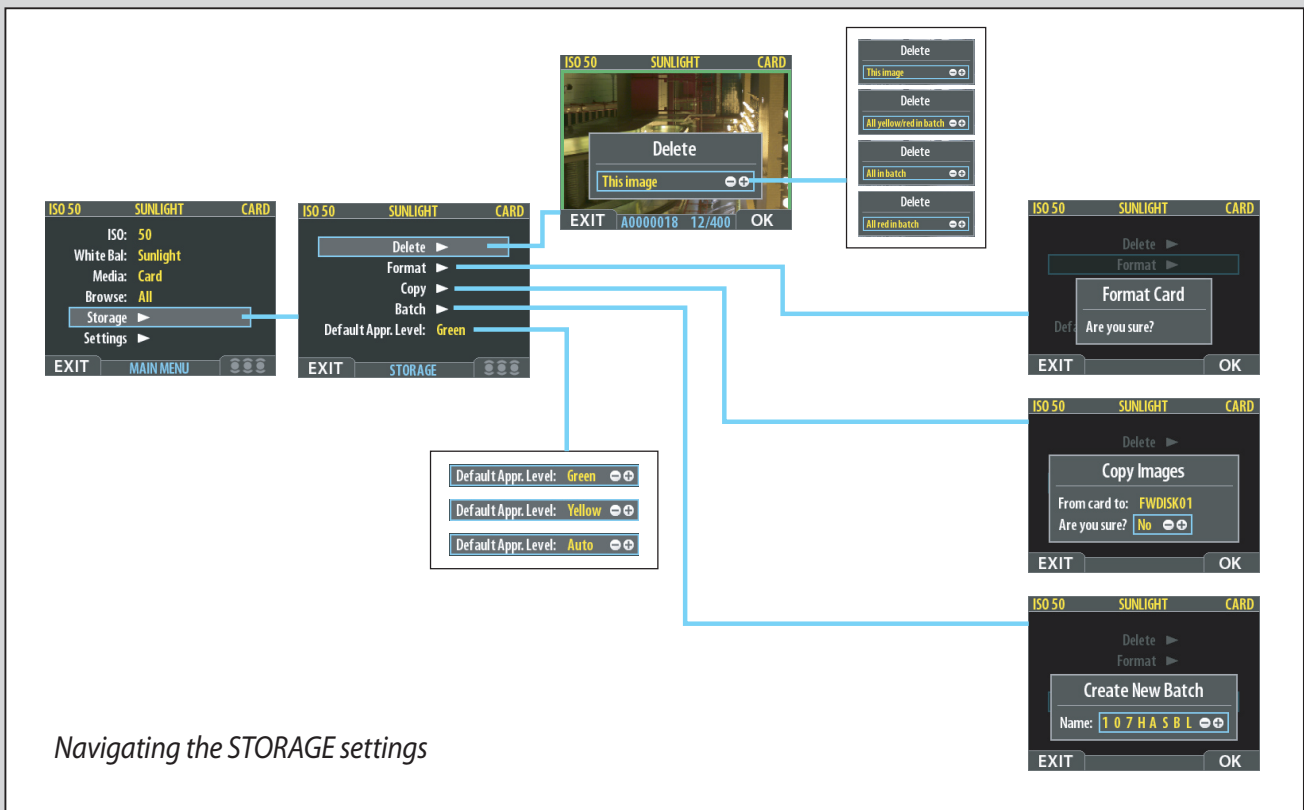

MAIN MENU > STORAGE > Delete

Use the **MAIN MENU > STORAGE > Delete** menu to delete images that you do not need, thereby making room for more captures. There are several ways to delete images:

- **Delete a single selected image**
- **Delete all images from a given batch**
- **Delete all images from a given medium**
- **Delete all images of a specified approval status (e.g., red) from a given batch or medium.**

Deleting single images

 There is a one-button shortcut for deleting images. To use it, first select the image you want to delete and then press and hold the **▼** button for a second or so. You will then be asked to confirm the delete. Alternatively, you can use the full procedure described below.

To delete a single image:

1. With the menu closed (e.g., with a preview image showing), use the **+** or **-** button to go to the single-image, four-thumb-nail or nine-thumb-nail view.
2. Use the navigator button to select the image you wish to delete. When you are viewing thumbnails, the selected image has a coloured border around it. When you are viewing single images, the selected image is the one currently shown.
3. Select **MAIN MENU > STORAGE > Delete**. (See also **Navigating the Menu System** for details about how to find this setting.)
4. Press **▶** to open the Delete Image dialog. You are now shown a full-size preview of the selected image and asked to confirm the delete.
5. Press **OK**.
6. You now return to the main menu. Either move on to another setting by using the navigator button or press the menu button to exit the menu system.

1



2



3



4



5



6



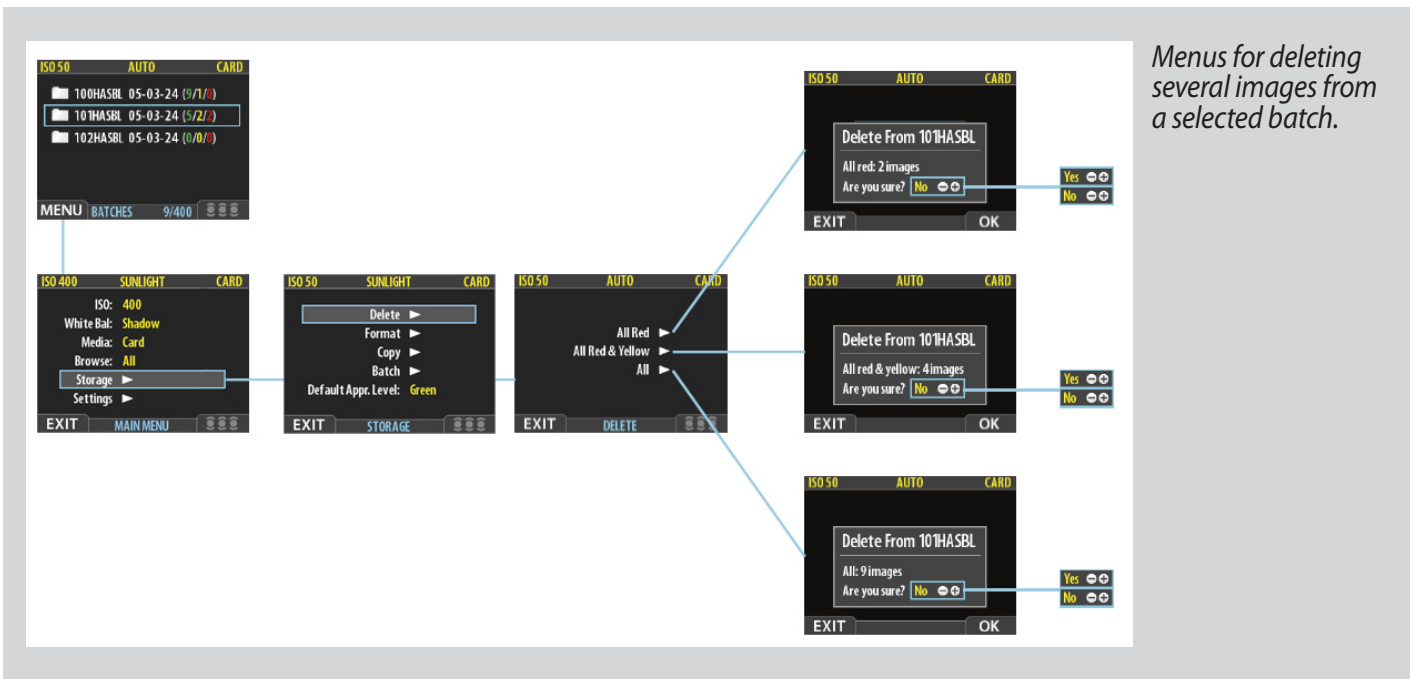

Menus for deleting several images from a selected batch.

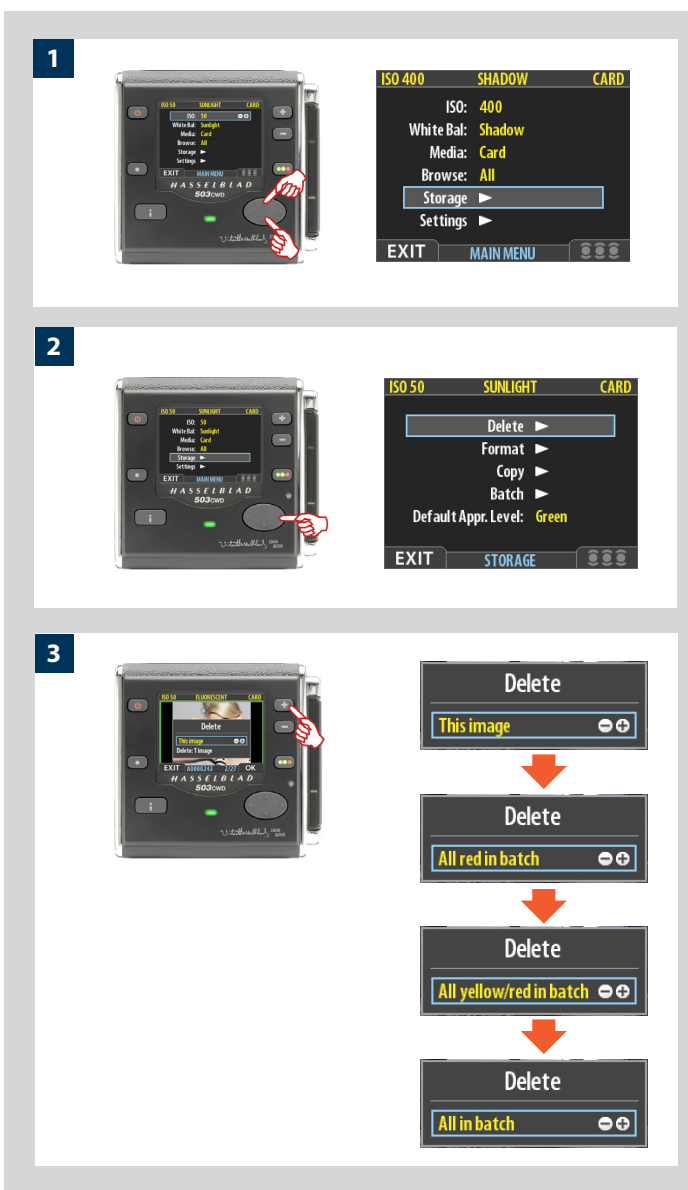

Deleting several images from a selected batch

To delete several images from a selected batch:

- Starting at the single-image preview display, Select MAIN MENU > STORAGE > Delete. (See also Navigating the Menu System for details about how to find this setting.)
- Use ► to enter the Delete submenu.
- Use the + or - button to select:
 - This image - deletes the current image only
 - All Red in batch - deletes all red images in the current batch
 - All yellow/red in batch - deletes all yellow and red images in the current batch
 - All in batch - deletes all images in the current batch

4



5



6



4. Press OK to confirm the delete. To exit without delete, press EXIT.

5. You now return to the main menu. Either move on to another setting by using the navigator button or

6. Press the menu (EXIT) button to exit the menu system.

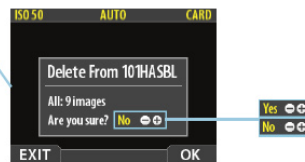
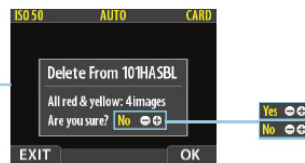
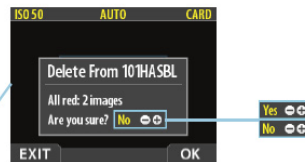
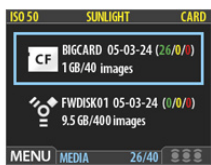

Menus for deleting several images from all batches from a selected storage medium.

Deleting several images from a selected medium

To delete several images at once:

1. Starting at the single-image preview display, press the **[-]** button three times to go to the list of media.
2. Use **▲** and **▼** to select the medium from which you wish to delete. You will be deleting from all batches stored on that item.

 Note that both each listed medium shows a set of three coloured numbers in parentheses to the right of the medium name. These indicate the total number of images of each approval status (green, yellow and red) that exist on the medium. For example, if you see a medium that shows (18/5/3), then the medium contains a total of 26 images: 18 green (approved), 5 yellow (unclassified) and 3 red (marked for probable delete).

3. Select **MAIN MENU > STORAGE > Delete**. (See also **Navigating the Menu System** for details about how to find this setting.)

4. Press **▶** to open the Delete Image dialog.

5. You must now select the approval status that you wish to delete. All images from the selected medium that are also of the status that you select here will be deleted by the operation.

Use **▲** and **▼** to select **All Red**, **All Red & Yellow** or **All**.

6. Then press **▶** to open the delete dialog for your selected status.

You are now asked to confirm the delete.

7. To confirm, press the **[+]** button to change the status to **Yes** and then press the approve button to execute the delete.
- To cancel, press the menu button to exit; or press the **[-]** button to set the status to **No** and then press the approval button to cancel.

You now return to the main menu. Either move on to another setting by using the navigator button or

8. Press the menu (EXIT) button to exit the menu system.

1

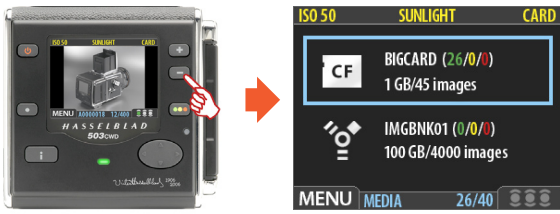

2



3

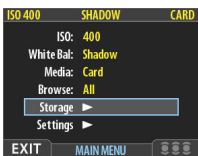

4

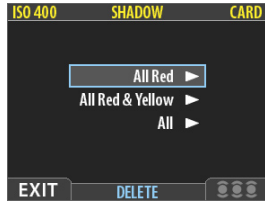

5



6

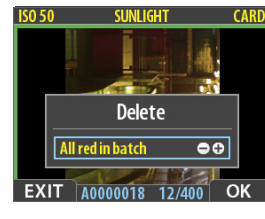

7



8



1



2

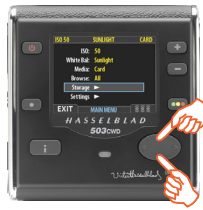

3



4



5



FORMAT

The digital back is only able to read and write to media that have been formatted.

However, new cards or disks sometimes arrive without any formatting, or you might want to convert media that are currently using a format that the camera cannot read.

Each time you get a new compact-flash card, we recommend that you format it using the digital back as described below, even if the digital back is already able to read it. This will enable the digital back to use the card more efficiently.

The digital back is capable of formatting any type of medium connected to it, including compact flash cards and Imagebank units. When you do this, you will erase all data contained on the target medium.

You can also use the format command for the purpose of deleting all images on a disk. This is sometimes faster than using the delete function, but it is not as flexible because all data from all batches will always be erased.

To format media:

1. If you have more than one type of medium connected (e.g., a compact-flash card and Imagebank), then start by selecting the medium you wish to format using the Storage entry of the main menu (see also **Selecting the Current Storage Medium**).
2. Select **MAIN MENU > STORAGE > Format**. (See also **Navigating the Menu System** for details about how to find this setting.)
3. Press the ► to open the **Format Card** dialog.
4. You are now asked to confirm the operation.
 - To confirm, press the **OK** button. This will execute the format and delete all data on the current medium.
 - To cancel, press the **EXIT**.
5. You now return to the **STORAGE** menu. Either move on to another setting by using the navigator button or press the menu (**EXIT**) button to exit the menu system.

COPY

Usually, you will copy images from a card by connecting the camera to a computer and using FlexColor. However, you might also want to load images from a card to a portable FireWire hard disk or Imagebank, allowing you to erase the card and keep shooting even when you do not have a computer with you.

After the copy, the destination disk will have a folder named CARDXXX, where XXX is a number that increments with each new copy operation (e.g., CARD001 for the first copy, CARD002 for the next, etc.). Previous copies are therefore never overwritten (provided you have fewer than 1000 folders of them). Within each CARD folder is a sub-folder for each batch. You cannot use the digital back to browse images copied in this way; you must connect the disk to a computer to browse the copied folders. This operation does not delete the copied images from the card—you must do this manually if you want to free card space after the copy.

To copy images from the compact-flash card to external media, use a FireWire cable to connect the external media to the CFV and then.

1. Press the **MENU** button.
2. Press **▼** to navigate down and select the **Storage** dialog.
3. Press **▶** and then **▼** to navigate down and select the **Copy** dialog. Press **▶** to open the **Copy** dialog.

4. If you have only one disk attached, then skip this step.

If you have more than one disk attached, then press **▲** to select the **From card** to entry. Then use the **+** or **-** button to select the name of the medium you want to copy to. Finally, press **▼** to go back to the **Are you sure?** entry.

With the **Are you sure?** entry selected, you must now confirm the operation.

- To confirm, press the **+** button to change the status to **Yes** and then press the approve (**OK**) button to execute the copy.
- To cancel, press the menu (**EXIT**) button to exit; or press the **-** button to set the status to **No** and then press the approve (**OK**) button to cancel.

If you chose to confirm, then the CFV now tracks the progress of the copy operation, which can take a few minutes. You can stop the copy at any time by pressing and holding the menu (**STOP**) button.

5. You now return to the **STORAGE** menu. Either move on to another setting by using the navigator button or press the menu (**EXIT**) button to exit the menu system.

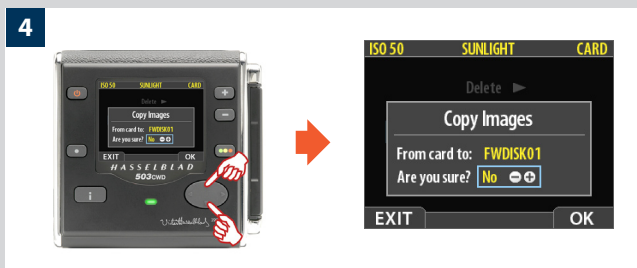

1



2



3



4



5



BATCH

Batches help you to organize your work. They are very similar to folders on a computer hard disk. Use the **Batch** command of the **STORAGE** menu each time you want to create a new batch.

For more information about batches, please see **Working with Media and Batches**.

To create a new batch:

1. Press the **MENU** button.
2. Press **▼** to navigate down and select the **Storage** dialog. Press **▶** and then **▼** to navigate down and select **Batch**.
3. Press **▶** to open the **Batch** dialog. The new batch name will always begin with a three-digit number, which automatically increments by one with each new batch. Following this is five letters, which you can assign yourself to help make the batch easier to identify. To set the letters:
 - Use **◀** and **▶** to select one of the five letters.
 - Use the **+** or **-** button to step the currently selected letter up or down the alphabet until you have found the letter you want.
 - Continue working until you have set the name you want.
4. Press the approve (**OK**) button to save the new batch with the name you selected.
5. You now return to the **BATCH** menu. Either move on to another setting by using the navigator button or press the menu (**EXIT**) button to exit the menu system.

 Remember that all new images are stored automatically in the latest batch. It is not possible to store new images in older batches.

1



2



3



DEFAULT APPR. LEVEL

The Instant Approval Architecture system helps you to evaluate and mark each image based on how well it has come out. By default, the system assigns an initial approval status for each new shot based on an analysis of the distribution of exposure levels. In the factory configuration, the status of each new shot is assigned as follows:

- **Green (approved):**
The new shot seems to have been exposed correctly.
- **Yellow / Amber (unclassified):**
The new shot seems to have been over- or under-exposed.

However, you might choose instead to override this system and have all new shots assigned either as green or yellow, regardless of the exposure analysis results. A typical strategy could be to assign all shots to yellow and then review all of the shots later and promote only the best ones to green status. At the same time you might demote the most doubtful shots to red status.

See also **Using Instant Approval Architecture** for complete details about working with the approval system.

To change the default status assigned to each new image:

1. Press the **MENU** button.
2. Press **▼** to navigate down and select the **Storage** level.
Press **▶** and then **▼** to navigate down and select **Default Appr. level**. Press **▶** to open the **Default Appr. level dialog**.
3. Use the **◀** or **▶** button to step through the available settings until the default status you wish to use (auto, green or yellow) is shown.
4. Either move on to another setting by using the navigator button or press the menu (**EXIT**) button to exit the menu system and keep your setting.

SETTINGS

There are a number of settings grouped under the general 'Settings' heading which are:

- User Interface
- Camera
- Miscellaneous
- Default

503CWD

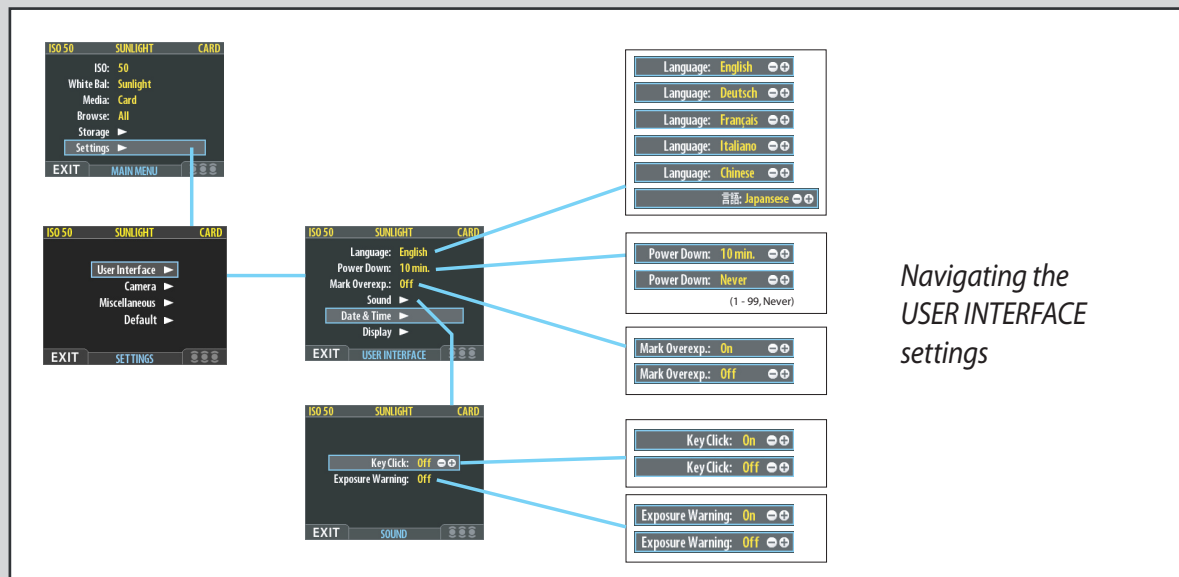

MAIN MENU > SETTINGS > User Interface

By altering the **User Interface** settings, you can control the way the digital back interacts to suit you and your preferred way of working. It also includes date and time settings.

Entries of the USER INTERFACE Menu

The user interface menu includes both entries and sub-menus. The following entries are available here:

- **Language:**

The menu system can be displayed in any of seven languages. This menu entry enables you to select your preferred language for the menus.

- **Power Down:**

To help preserve the charge of the battery, you can set the back to power down after a specified period of inactivity. The effect is exactly the same as though you had pressed the off button on the camera. Once it has powered down, you must turn the CFV on before you can continue working. Set this to **Never** to disable this feature (this is the default setting). Set to a value between 3 and 99 minutes to establish a time-out. (*Note the difference between Display 'timeout' and Power Down.*)

- **Mark Overexp.:**

This feature helps draw your attention to areas of your images that are overexposed. When this feature is enabled, the single-image preview display will highlight each overexposed pixel by flashing it white and black.

Set this entry to **On** to enable the feature; set to **Off** to disable it.

- **Sound:**

The CFV uses audio feedback to help let you know if each new image is exposed correctly. This is described in **Using Instant Approval Architecture**.

This menu entry has **Volume** (choose between *High*, *Low* and *Off*), **Key Click** (choose between *On* and *Off*) and **Exposure Warning** (choose between *On* and *Off*).

- **Date & Time:**

The CFV has an internal clock that keeps track of the date and time. This information is used to mark each shot with the date and time at which it was taken. It is also used to label batches with the date on which each batch was created.

- **Display:**

This feature sets the **Timeout (2-30 seconds)** on the display, which behaves very much like a screen saver on a computer. When the timeout is reached, the display will be turned off, but the back will still be running, so it will immediately respond to a press of the buttons. (*Note the difference between Display 'timeout' and Power Down.*)

This feature also sets the level of **Contrast** (on a scale of **1-10**) on the display. Usually, you should leave this set to the default level of 5; however in some viewing environments and/or with some types of images you may wish to increase or decrease this value. A value of 10 provides maximum contrast; a value of 0 provides no contrast (a black screen). You can also help save battery power by using a low value here.

This feature also sets the **Brightness** (on a scale of **1-10**) on the display. This sets the brightness shown on the screen. Usually, you should leave this set to the default level of 5, however in some viewing environments and/or with some types of images you may wish to increase or decrease this value. A value of 10 provides maximum brightness; a value of 0 provides minimal brightness. You can also help save battery power by using a low value here.

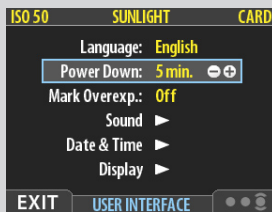
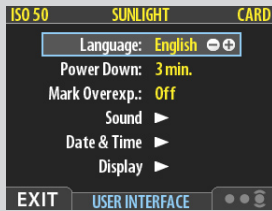

Setting the options under the User Interface menu

Each of the above entries can be set by similar menu navigation. Language, Power Down and Mark Overex can be set immediately by the **+** or **-** buttons while Sound, Date & Time and Display require another move to sub menu for final choice.

Proceed as follows:

1. Press the menu (**MENU**) button to open the menu.
2. Use **▲** and **▼** to select the **SETTINGS** sub-menu.
3. Press **▶** to open the **SETTINGS** menu.
4. Press **▶** to select the **USER INTERFACE** sub-menu.
5. Use **▲** and **▼** to select the required entry.
6. Press either the **+** or **-** button to make the new settings in the case of Language, Power Down and Mark Overex or Press **▶** again to access Sound, Date & Time and Display
7. Press the **MENU/EXIT** button again to save the new settings and close the menu.





Navigating the CAMERA settings

MAIN MENU > SETTINGS > Camera

All Hasselblad V-system cameras can communicate with the 503CWD digital back without the need for extra cable connections except:

- *Unmodified 200 series models using CF lenses in C-mode*
- *ArcBody*
- *Flexbody*

View cameras (with the appropriate adapter and cables) can also be used.

The exposure time set on the 503CWD digital back sets the maximum length of exposure. The default setting is 1/8 sec and this is the setting that can be kept for all exposures from 1/8 sec through 1/2000sec. However, this setting should be changed in accordance with the time required if it exceeds 1/8 sec. Times of up to 32 seconds can be set.

If you prefer, you can connect the 'Flash sync input cable' between the lens PC socket and the 503CWD digital back which allows you to retain the default setting of 1/8 second while still being able to use exposure times longer than 1/8 second. This method also allows the use of the B setting.

Model setting variations

Look in the list below for the camera model you are using and make the appropriate settings change. Don't forget to change the setting if you change camera model!

Exposure Cable 503



Hasselblad 503CW plus winder CW

CW

For use with 503 CW models:

- *Make a CW setting.*
- *If you want to control the camera from FlexColor, connect the 'Exposure cable 503' between the 503CWD digital back and the Winder CW as in the illustration.*
- *Do not use the winder at rapid sequence setting.*

ELD

For use with ELD models:

- *Make an ELD setting.*
- *A B setting exposure can be made by choosing the "Bulb" in the "Exposure Time" setting. The maximum exposure time remains at 32 seconds however.*

Adapter EL



All Hasselblad EL models

Exposure Cable EL



All Hasselblad EL models except ELD

- The **Exposure Cable EL** (supplied) should be connected.
- Only the single shot function (A or AS mode camera settings) should be set on the camera. Rapid sequence shots are not possible.
- Use the **Adapter EL** (supplied) to provide the necessary extension beyond the motor housing of the EL models for battery attachment. It is attached to the 503CWD digital back in the same manner as a battery, and the battery itself is then attached to the adapter as in the illustration.

ELX

For use with 500EL/ELM and 500/553ELX models:

- Make an **ELX** setting.
- The **Exposure Cable EL** (supplied) should be connected.
- All exposures times, including the B setting, function correctly without having to alter the “Exposure Time” setting.
- Rapid sequence shots are not possible.
- Use the **Adapter EL** (supplied) to provide the necessary extension beyond the motor housing of the EL models for battery attachment. It is attached to the 503CWD digital back in the same manner as a battery, and the battery itself is then attached to the adapter as in the illustration.

Pinhole

For use with lenses/cameras with no shutter. Intended primarily for use in a studio environment where complete darkness can be achieved and exposures made accordingly (also useful for ‘light painting’). In this mode the 503CWD digital back uses the exposure time (as well as other required stages in a capture sequence) set in the Capture Sequence dialog. The back can be triggered either via the **START** (MENU/EXIT) button or from FlexColor (see later section for full description of Capture Sequence settings procedure).

Flash sync

For use with non-modified 200 series models (together with C-lenses in C-mode), an ArcBody, a FlexBody or view cameras with a Hasselblad adapter.

- Make a **Flash sync** setting.
- A **Flash sync input cable** should not be used.
- All exposures times, including the B setting, function correctly without having to alter the “Exposure Time” setting.
- Do not use a winder at rapid sequence setting.

SWC

For use with 903 SWC and 905 SWC models.

- Make an **SWC** setting.

PLEASE NOTE: Due to the mechanical design of the SWC, pressing the exposure release button too slowly may cause a faulty capture with a magenta cast. Either press the button much more distinctly or alternatively change the setting from **SWC** to **Flash sync** and use the flash sync cable to connect the lens to the digital back.

200

For use with modified 202, 203 and 205 models together with F-lenses or CF-lenses in F-mode. (Only these three models can be modified for cable-free compatibility with the 503CWD digital back. Please contact your Hasselblad dealer for further information)

- Make a **200** setting.
- A **Flash sync input cable** should not be used.
- All exposures times, including the B setting, function correctly without having to alter the “Exposure Time” setting.
- Do not use a winder at rapid sequence setting.

1



2

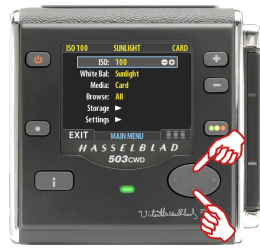

3



4



5



6



7



8



9



500

For use with 500C/CM, 501C/CM and 503 CX/CXi/CW models.

- Make a 500 setting.

Shutter Delay

There can be differences in the amount of time required in preparation (raising the mirror, opening/closing the shutter etc) for digital capture between various camera models. This corrective feature adjusts the time a little to ensure the image is read out from the sensor. The normal setting is Default and should only be changed if problems are encountered.

Exposure Time

This setting should be changed for cable-free exposure times longer than 1/8 second, ensuring that it matches the set shutter speed on the lens. The settings range from 1/8 second to 32 seconds (1/8 second is the default setting). The ELD also has a "Bulb" setting.

Capture Sequence

This feature functions in the same manner as an interval timer and only works in conjunction with a motor or winder driven camera model except in the case of the Pinhole setting where it is the only way of controlling such exposures (see later section for full details).

Initial delay: Controls the amount of time required to elapse before the first exposure.

Delay: Controls the amount of time required between each exposure.

Count: Controls the total number of exposures required.

Setting CAMERA model and options

Proceed as follows:

1. Press the menu (MENU) button to open the menu.
2. Use ▲ and ▼ to select the SETTINGS sub-menu.
3. Press ► to open the SETTINGS menu.
4. Use ▲ and ▼ to select CAMERA.
5. Press ► to open the CAMERA menu.
6. Press either the + or - button to select camera model.
7. Use ▲ and ▼ to select SHUTTER DELAY or EXPOSURE TIME if required.
8. Press either the + or - button to make new settings if required.
9. Press the menu (EXIT) button to exit the menu system and keep your settings.

Connectivity diagram

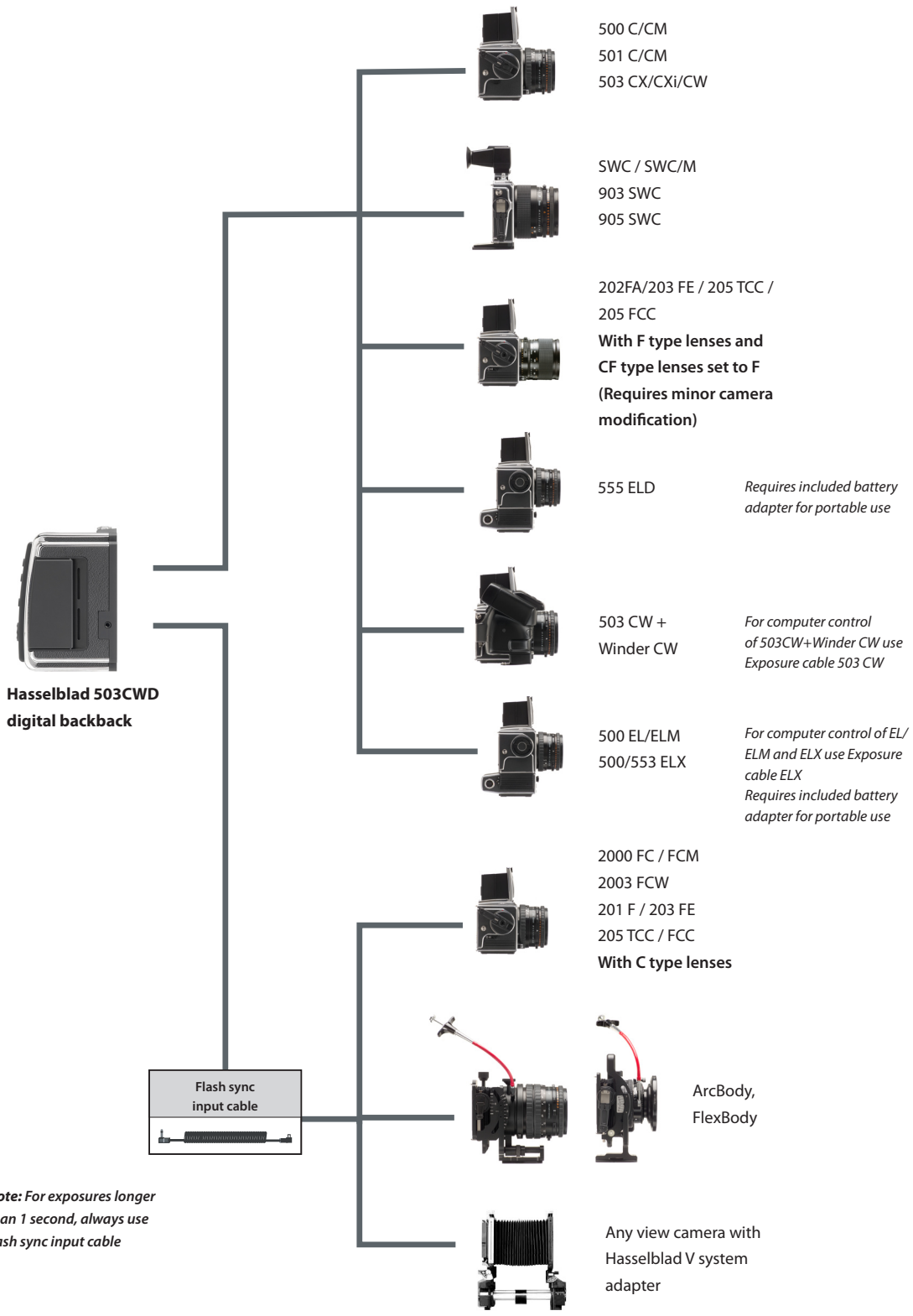

Note: For exposures longer than 1 second, always use flash sync input cable

Setting CAPTURE SEQUENCE

Proceed as follows:

1. Press the menu (MENU) button to open the menu.

2. Use ▲ and ▼ to select the SETTINGS sub-menu.

3. Press ► to open the SETTINGS menu.

4. Use ▲ and ▼ to select CAMERA.

5. Press ► to open the CAMERA menu.

6. Press either the + or - button to select PINHOLE.

7. Press ▲ or ▼ to select EXPOSURE TIME.

8. Press either + or - to make an exposure time setting.

9. Press ▼ to select CAPTURE SEQUENCE.

10. Press ► to open the CAPTURE SEQUENCE menu.

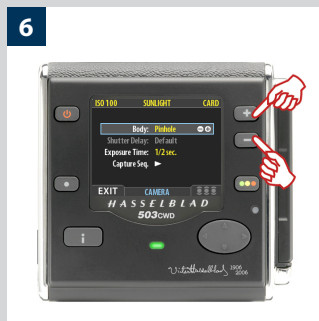

11



12



13



14

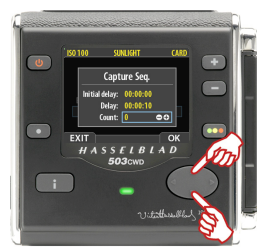

15



16



17



18



19



11. Press either the **+** or **-** button to make an INITIAL DELAY setting.

This setting controls the amount of time that elapses before the first exposure in the sequence.

12. Press **▼** to select DELAY.

13. Press either **+** or **-** to make a DELAY setting.

This setting controls the amount of time between each exposure in the sequence.

14. Press **▼** to select COUNT.

15. Press either **+** or **-** to make a COUNT setting.

This setting controls the number of exposures in the sequence.

16. Press OK to confirm all the settings.

17. The 503CWD digital back is now ready for sequence start. Note that the MENU/EXIT button now displays START instead:

18. Press START to set the sequence running.

19. Note that the MENU/EXIT button now displays STOP. The sequence can be stopped at any time by pressing this button and the standard menu display returns.

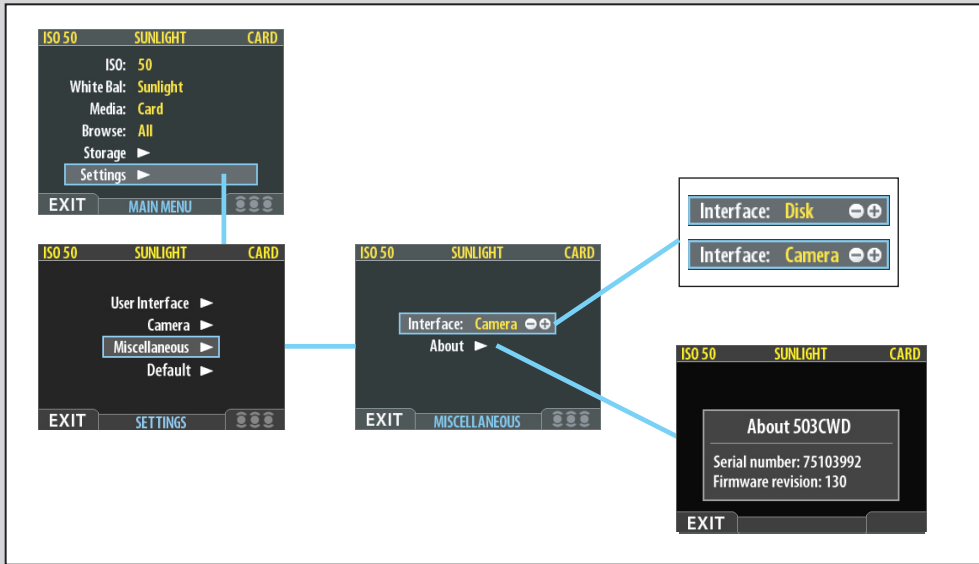

Navigating the MISCELLANEOUS settings

MAIN MENU > SETTINGS > Miscellaneous

The MISCELLANEOUS menu contains two settings:

Selecting an interface

The interface setting controls the way the camera will appear to your computer when you connect it. You have the following choices:

- **Camera:**

The camera will present itself to your computer as a camera. Depending on the way you have configured your computer, this may mean that when you connect the camera, your computer will automatically launch FlexColor, which may then begin importing images and converting them to 3F format.

- **Disk:**

The camera will present itself to your computer as a mass storage device. This means that it will look like a hard disk, which you can navigate to, open and read using the standard tools for your operating system (e.g., the Finder in Mac OS or the File Explorer in Windows).

To set the interface presented by the digital back to your operating system:

1. Select the **MAIN MENU > SETTINGS > MISCELLANEOUS > Interface** entry. The current setting is shown here. (See also *Navigating the Menu System* for details about how to find this setting.)
2. Use the or button to step through the available settings until the interface you wish to use (camera or disk) is shown.
3. Either move on to another setting by using the navigator button or press the menu (EXIT) button to exit the menu system and keep your setting.

1

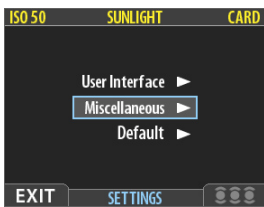

2



3



The About box

Occasionally, Hasselblad may release updates to the internal software of the digital back (this is called “firmware”). These updates may fix small errors and/or add new features. You will probably receive additional assistance from Hasselblad technical support if and when a new update is available. In this case, it may be important to know the serial number and current firmware revision of your digital back. To find this out:

1. Select **MAIN MENU > SETTINGS > MISCELLANEOUS > About**. (See also *Navigating the Menu System* or details about how to find this setting.)
2. Press ► to open the **About** dialog, which shows the serial number and firmware version.
3. When you are done reading the information, press the menu (**EXIT**) button to return to the **MISCELLANEOUS** menu. Either move on to another setting by using the navigator button or press the menu (**EXIT**) button again to exit the menu system.

1



2



3



MAIN MENU > SETTINGS > Default

The **DEFAULT** setting will reset all custom settings you have made back to the original default / factory settings.

To reset all settings:

1. Select the **MAIN MENU > SETTINGS > DEFAULT** entry.
2. Press the **OK** button and then the **EXIT** to return.

1

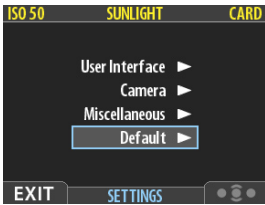

2



Flash / Strobe

The 503CWD can be used together with most studio or portable units.

It also offers a TTL function if required.

503CWD

Most flash units are suitable for use with the 503CWD. However, for the sake of safety, care should be taken when using studio flash units (strobe) and tethered to a stationary computer.

Portable units

Attach the flash sync cable to the lens (or camera body if you are using the 503CWD digital back on a Hasselblad 200 series model) and make the appropriate settings according to the unit.

This also applies when using studio units when:

- a) tethered to a computer not connected to a regular electricity supply system.
- or
- b) tethered to an Imagebank or laptop computer running on batteries.

With studio type flash units (strobe) and tethered to a computer

If the 503CWD is tethered to a computer that is connected to a regular electricity supply system as well as a studio flash/strobe unit that is also connected to a regular electricity supply system/generator system, then make the following connections instead:

- a) Connect the **flash sync input cable** from the sync contact (PC connector) on the lens to the **flash sync IN terminal** on the back.
- b) Connect the **flash sync output cable** from the **flash sync OUT terminal** on the back to a regular flash sync cable that is connected to the unit.

TTL function

The reflective characteristics of the digital sensor are different to film surface characteristics for which the TTL function was originally designed. However, by changing (in effect, 'tricking') the setting, TTL exposures can be made. Proceed as follows:

Move the ISO selector on the 503CWD so that it becomes approximately $1\frac{2}{3}$ f/stop higher than the ISO setting on the digital back. Therefore, for example, when the back is set at 50ISO, the 'film speed setting' on the camera should read 160ISO, and so on. Testing for the most suitable compensation that suits you is recommended.

Viewfinder indicator

Flash operation and flash battery-check are indicated by a red light, located under the left edge of the focusing screen. It is operative only when a dedicated flash is connected



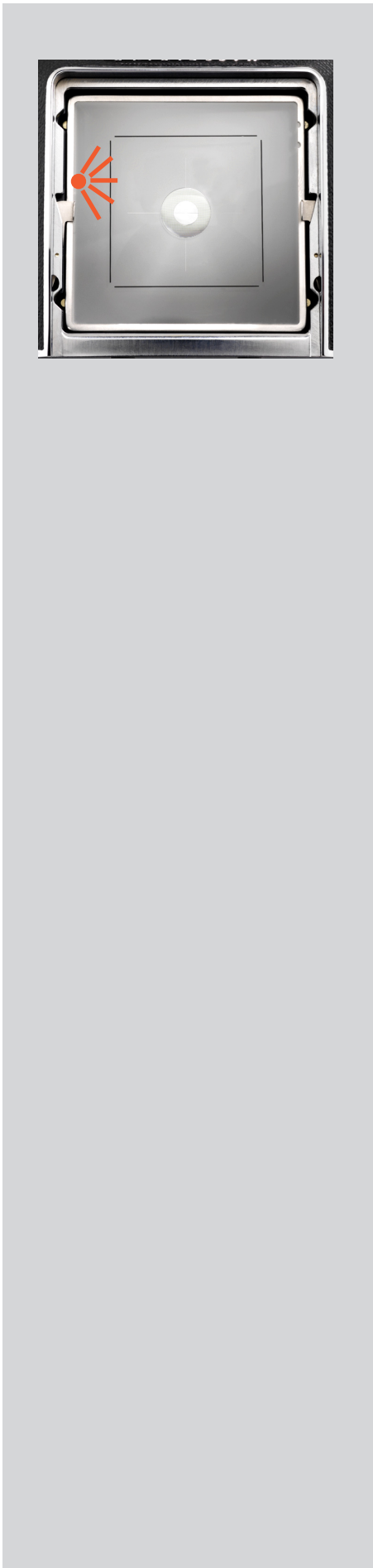

to the TTL socket. It indicates three separate states as described below.

Ready signal

A steady red light indicates that the flash unit is charged and ready to be fired. Absence of any signal indicates the need for fresh batteries.

Confirmation signal

A flashing red light occurring for just over a second immediately after exposure confirms that the light output was sufficient for a proper exposure. It then remains dark until the flash unit has recharged. The steady red light will then reappear indicating operative status again. The time of reappearance however may vary according to the condition of the batteries.

No result signal

Absence of the flashing confirmation signal after exposure indicates that the flash emitted was not sufficient for correct exposure. The aperture must then be opened more or the flash distance to the subject reduced. Changing to a faster ISO setting on the digital back is also a possibility.

See appropriate manuals for connection details regarding the various units and adapters.

Cleaning

Regularly check the surface of the sensor filter for dust specks that might cause time-consuming re-touching afterwards.

503CWD

Cleaning the CCD Infrared Filter

If you see dark or coloured spots or lines in your images, then you may need to clean the outer surface of digital back's infrared (IR) filter. In most cases, the careful use of compressed air will be adequate, but sometimes small particles will get stuck to the surface of the IR filter, requiring for a more thorough cleaning, involving either fluid or wipes. For a good safe cleaning, follow descriptions below.

 **WARNING:** never attempt to remove the glass filter from the front of the CCD—you will probably ruin the CCD if you do so. If dust manages to get between the IR filter and CCD, please contact your Hasselblad dealer for assistance.

Basic cleaning procedure

1. Discharge any static electricity that may have built up on your body by touching the digital back housing.
2. While keeping the magazine catch lock depressed, slide the magazine catch to the right.
3. The top of the digital back will be released (while it rests on the magazine retaining hooks) and it can be swung away from the camera body.
4. Clean the outside surface of IR Filter by spraying it with clean compressed air. If this is not enough, then use one of the procedures outlined below.
5. If you still see spots on your shot after you have cleaned the outside of the infrared filter, then you may have dust on either on the back side of the IR filter or on the CCD itself. This can only be removed at the Hasselblad factory. Contact your Hasselblad dealer for assistance.
6. When reattaching the digital back to the camera, keep the magazine catch lock depressed and the magazine catch to the right. Check that the back is firmly in place.

Cleaning using the HAMA Cleaning Fluid and tissues

Note! Hasselblad recommends HAMA Optic Cleaning Fluid 5902.

1. Carefully spray the fluid onto the IR filter at a distance of 10-15 cm (4-5 inches), so that the fluid is applied onto the filter as a thin, even haze. 1-2 sprays are enough. If you apply too little, the fluid will start to dry up before you start wiping the filter. As





an alternative you can spray the fluid onto the tissue first, and then apply it to the filter as you wipe it.

- 2. Fold the tissue several times to match the width of the IR filter—you might use two or three tissues at a time if necessary (to give you a better grip). Be sure to fold the paper so that the coated glossy side faces outwards—do not use the other side, as it can do more harm than good!*
- 3. Gently place the folded tissue onto the edge of the filter using two or three fingers. Be sure to wipe the entire surface evenly. Sweep the filter only once. Do not wipe the same area twice with the same tissue as you might reapply dirt removed in the first sweep.*
- 4. Finally check if the IR filter has been properly cleaned either by visual inspection or by mounting the digital back to the camera and making a shot. If further cleaning is needed, repeat cleaning procedure.*

Cleaning with an E-Wipe

E-wipes are individually packed wet tissues.

- 1. Tear at the notch to break seal.*
- 2. Remove e-wipe from its packaging and continue without delay.*
- 3. Fold the tissue to match the width of the IR filter.*
- 4. Apply firm pressure using two or three fingers at the edge of the wipe to ensure an even, firm contact with filter surface. Wipe the surface in one unbroken motion.*

 *Note! Do not use same side of the e-wipe twice as you will be likely to reapply any particles removed in the first pass.*

- 5. Finally check if the IR filter has been properly cleaned either by visual inspection or by mounting the digital back to the camera and making a shot. If further cleaning is needed, repeat cleaning procedure.*

Cleaning the housings

If the camera becomes dirty, clean it with a soft, clean cloth lightly moistened with water only. Do not use any other solvents and do not allow water to get.

7

Film Magazine Use

The 503CWD also accepts film magazines allowing for greater freedom and versatility.

503CWD

There are a number of reasons why using film might either be preferable or even necessary. For example you might want the specific results you know that a certain film emulsion can produce or you might want to use very long exposure times, etc. Don't forget that 6 x 6 cm film magazine use will also allow you to exploit the full focal length of your lenses.

As a rough guide, the following are some items regarding film use that differ from digital back use. Please see the film magazine user manual for full operational details.



Infrared photography with film

Infrared (IR) rays (wavelengths longer than 800 nm) form an image on a plane further away from the lens than the image plane for visible light. To compensate for this difference you have to align the chosen distance against the red IR index and not the normal central index. Proceed as follows:

1. *Focus as usual on the focusing screen.*
2. *Note the distance on the focusing scale that is opposite the central index line.*
3. *Now rotate the focusing ring to set this distance opposite the dashed IR index line instead of the central index line.*

 *Please observe the special information that came with your IR film regarding magazine loading, film development, etc.*

Double exposure with film

Double (or multiple) exposure is possible with a film magazine. However, as the camera has been designed to prevent accidental double exposure you will have to carry out the following procedure in order to make multiple exposures on the same frame:

1. *Make the initial exposure.*
2. *Insert the magazine slide and remove the magazine.*

3. *Wind the camera with one full revolution of the winding crank.*
4. *Replace the magazine and remove the slide.*
5. *Make the next exposure .*
6. *Repeat the procedure for further exposures on the same frame.*

Flash with film

Any flash unit can be connected to the 503 CWD via the PC flash terminal on the lens for manually controlled flash exposure with flash sync speeds are up to 1/500s.

Automatic flash control, or dedicated flash, is provided by the camera's built-in flash sensor and electronics (TTL/OTF) that measure the light reflected from the central portion of the film; a circle with a diameter of 40 mm.

The metering system is connected to a selector for setting film speed. When a Hasselblad D-Flash 40 is attached – or an SCA 300 compatible flash unit is connected through an SCA390 flash adaptor – the system controls the flash unit and cuts off the flash when the exposure is correct. Under the left hand edge of the focusing screen an indicator light shows when the flash is ready to be operated and also confirms if the flash output was sufficient to give a correct exposure. The flash unit powers the camera's electronics and also the flash adaptor, when that is used.

Setting the film speed for TTL/OTF flash

The film speed is set via the ISO selector. This is marked in ISO/ASA settings from 64 – 4000. Note that certain films require compensation due to differences in reflective properties of various emulsions. In these instances, the compensation can be made by changing the film speed selector setting. The amount of compensation has to be determined by experiment. Alternatively you can replace the magazine with the Rear cover MultiControl for a few test exposures. The grey surface acts as an 18% grey card to provide a well-balanced starting point for exposures.

Please refer to your flash unit's operating instructions for more information about other functions when using the D-Flash 40, automatic flash light metering that conforms to System SCA flash photography with flash sensors, or with non-automatic flash units.

Rear cover MultiControl (supplied)

The Rear Cover MultiControl (3051070) not only provides protection for the camera body when the digital back is not attached but also provides flash check facility for cameras featuring TTL/OTF (described separately) as well as a vignetting check facility.

Checking for possible vignetting is useful when filter combinations, attachments or lens shades are used, to ensure the optimum from the accessories without the risk of inadvertent vignetting.

With the cover in position you can see the so-called 'exit pupil' of the lens through the small holes in the cover. A vignetting free lens has an exit pupil the exact shape of the lens aperture. At maximum aperture there is slight vignetting with all lenses but at f/11 to f/16 the majority of lenses are free of vignetting.

Corner illumination is dependent on the size of the exit pupil. If the filter or lens shade extends too far, the area of the exit pupil diminishes. The shading effect of a professional lens shade, for example, is optimal when it has been extended as far as possible without causing any visible corner vignetting. The amount of this extension is dependent on both the working aperture and the focusing distance for the lens used.

Use the following method when any kind of lens accessory is in place and you want to ensure a result free from vignetting:

1. *Fit the accessory. Remove the film magazine but do not attach a Rear Cover MultiControl just yet.*
2. *Set the shutter on a CF/CFi/CFE lens at the 'F' position and pre-release the camera to open both the lens shutter and the auxiliary shutter. C/CB lens shutters should be set at 'B' and a B exposure made. Use a cable release to lock the released position.*



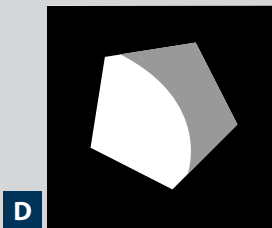
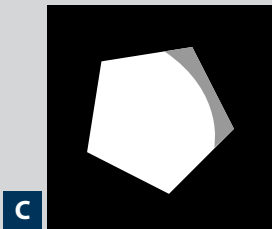
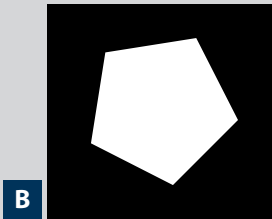

3. Look at the lens exit pupil. Use the stop-down button and change the aperture noticing as you do so the changes in the size of the exit pupil.
4. Look now at an angle roughly in a line from the exit pupil to one corner of the camera back opening. This helps in finding the exit pupil again when the RCMC is attached, which can be troublesome with wide-angle lenses in particular.
5. Attach the RCMC and observe the exit pupil again.
6. Select the working aperture and stop down manually.
7. Set the approximate focusing distance.
8. See the diagrams for a fuller explanation of what you can now see through one of the holes, and act accordingly.

In the diagrams, all exit pupils are viewed from the image corners.





Diagram A - Exit pupil for a wide-open lens

Diagram B - Exit pupil for a vignette-free stopped down lens

Diagram C - Exit pupil for a slightly vignetted lens (no visible effect on the image)

Diagram D - Exit pupil for a vignetted lens (clearly visible effect on the image)

General points for film magazine use

-  Before you can take a photograph, you must remove the magazine slide. The magazine will then be locked on the camera body, and the camera release button will be unblocked.
-  Film is automatically advanced in the magazine after a full turn of the crank.
-  You cannot remove a film magazine with re-inserting the magazine slide first.
-  Do not attach a magazine showing red to a fully wound camera! This could result in a double exposure.

8

Accessories

There are a good number of accessories and lenses compatible with the 503CWD to provide the optimal set up for almost all applications.

503CWD



As this camera is a further development of previous models, it features improvements and some differences in design. This means that certain older and now discontinued accessories cannot be used and any forced attempt at mounting them may damage your equipment, so please check carefully before trying.

For complete and up to date information please refer to the latest Hasselblad V System Product Catalogue or visit our website - www.hasselblad.com

The following list is just a selection.

Viewfinders

There is a comprehensive range of viewfinders to choose from to suit a variety of applications. The range includes two magnifying hoods and a reflex viewfinder. Also included are four prism viewfinders to laterally invert the image so it becomes 'correct'. Two of these have a metering capability as well for added convenience.



Winder CW

The Winder CW is a compact, economically designed unit providing not only a motor drive facility but also a comfortable and robust grip.

It features single exposure, continuous exposure as well as multi-exposure modes. Remote control is achieved by a simple release cord or by the unique infrared transmitter – the Hasselblad IR Remote control. Both provide considerable freedom, with the IR Remote control offering an extra remote mode choice facility. Each winder is governed by a unique code from the IR Remote control so there is no risk of controlling other cameras unintentionally. However, one IR Remote control can control several cameras at the same time if desired. As the winder is set close to the camera body, it produces stability and balance for optimum hand held efficiency.

Requires an 'Exposure Cable 503'. See MAIN MENU > SETTINGS > Camera for use.



Snap-lock flash grip

Primarily a portable flash unit support but also acts as an ergonomic camera-grip. It is fully adjustable and can be rapidly detached for flash-off-camera shooting. It also features an Integrated Quick coupling for optimal rapid use.



Tripod quick-coupling

The coupling plate on the bottom of the camera body has both a 1/4 in. and a 3/8 in. tripod thread. It also fits the useful and reliable Hasselblad Tripod Quick-Coupling (3043326). This facilitates rapid and repeatedly accurate attachment and removal of the camera from a tripod or support.



Professional lens shade

The Proshade 6093T (3040739) provides the ultimate in flare and stray light reduction. It is particularly useful if you have a number of lenses as it fits virtually all lenses in the range. It is supplied with a Proshade mask 6093/250 (3040312) which provides further control for longer lenses when the Proshade is fully extended. The Proshade also functions as a gelatine filter holder.



Close-up accessories

Four fully automatic extension tubes and an automatic bellows extension are available for close-up work.



Please see the Hasselblad V system catalogue or visit the Hasselblad website – www.hasselblad.com – for details of the complete range of accessories and lenses.



Technical specifications

Camera type:	Single lens reflex camera with 6 x 6 cm (2 ¼ x 2 ¼ in) max. film size. Interchangeable lenses, film magazines, viewfinders, and focusing screens.
Design:	Mechanical, with an aluminum alloy camera body shell cast in one piece.
Viewfinder:	Folding focusing hood interchangeable with reflex viewfinder, prism viewfinders with or without built-in light meter, or magnifying hood.
Film advance:	Manual advance or motor driven with Winder CW. Simultaneous shutter winding. Winder CW winding time: 1.05 s, approx. 0.8 frames/sec in continuous mode.
Flash control:	TTL/OTF-metering. ISO 64–4000 with flash adaptors SCA390 for connection with flash units from the SCA 300 systems. Metering area within 40 mm diameter in the centre of the image area.
Tripod coupling:	¼ in. and ¾ in. socket threads and base plate for quick coupling attachment.
External dimensions:	Complete camera with Planar CFE 2.8/80 mm lens: 193mm L x113mm W x110mm H
Weight:	1620 g (Excluding battery and CF card).
Focusing screen:	Hasselblad Acute-Matte D focusing screen with sensor format markings.
Sensor size	16 million pixels
Sensor dimensions	36.7 x 36.7 mm
Lens factor with V camera	1.5
Shooting mode	single shot
Multi shot upgrade	not available
1 GB CF card holds	45 images
File format	Lossless compressed Hasselblad 3F RAW format (3FR) or 3F
Capture rate	35 frames per minute
Image storage	<ul style="list-style-type: none">. CF card type II. 100 GB portable Imagebank. computer disk with tethered shooting mode
Software	FlexColor (included) 3FR to Adobe DNG converter utility
Colour definition	16 bit
Dynamic range	12 f-stop

Technical specifications — continued

Color management	Hasselblad RGB . full dynamics . reproduction dynamics
Color display	OLED type, 2.2 inch, 24 bit color
IR filter	Mounted on CCD sensor
ISO speed range	50, 100, 200, 400
Longest shutter speed	32 seconds
Battery power	SONY InfoLithium L, up to 8 hours of shooting capacity
IAA - Instant Approval Architecture . Histogram analysis . Acoustic feed back	Included, with: yes yes
Computer support	Macintosh: OSX PC: NT, 2000, XP
Host connection	Firewire 800 (IEEE1394b)
Operating temperature	0 – 45 deg. C / 32 – 113 deg F

Equipment care, Service and Guarantee

503CWD

EQUIPMENT CARE

- *Keep all equipment and accessories out of the reach of small children.*
- *Do not place heavy objects on the equipment.*
- *Do not use the batteries except as specified.*
- *Use only the batteries specified for use with the 503CWD.*
- *Remove the batteries when cleaning the camera or if you intend to leave it unused for a long period.*
- *If you use spare (standard or rechargeable) battery packs be particularly careful to use the supplied protective cap when storing. There is a potential fire risk if the contacts are short circuited across a conductive object (such as keys in a pocket, for example).*
- *Take particular care when working with strobe / studio flash units to prevent damage to equipment and personal injury.*
- *Do not attempt to open the digital back on the 503CWD.*
- *Always replace the protective sensor filter cover when the digital back is not mounted on the camera.*
- *Do not touch the exposed sensor filter with your fingers.*
- *Ensure that the databus connections are not damaged or soiled in any way.*
- *Keep all foreign objects out of the 503CWD openings.*
- *Keep the original shipping boxes for storage.*
- *Keep your 503CWD and all other computer equipment away from moisture. If your 503CWD becomes wet, disconnect from power and allow it to dry before attempting to operate again.*
- *Never cover the ventilation openings on the 503CWD when in use.*
- *Never try to remove the glass IR filter from the front of the sensor; this will probably ruin the sensor. If dust manages to get between the sensor and IR filter, please contact your Hasselblad dealer for assistance.*
- *Avoid frequent and severe temperature changes and be particularly careful*

in humid environments. Allow the equipment to acclimatize whenever possible before use. Try to ensure the storage conditions in such environments are as dry as possible.

- *Prevent dust and grit from getting into your equipment. In coastal areas take measures to protect your equipment from sand and salt water spray.*
- *Avoid physical shocks to the 503CWD. Some form of protective case or camera bag is advised for transportation.*
- *Hasselblad equipment is much sought after and you should take obvious steps to prevent theft. Never leave it visible in an unattended car, for example. Separate and specific camera insurance cover should be considered by professional users.*

SERVICE

Return your equipment to a service centre for occasional checking and preventive maintenance to ensure optimal reliability.

GUARANTEE

Provided that you bought your equipment from an authorized Hasselblad outlet, it is covered by an international guarantee for one year. The guarantee document and a registration card are supplied with the 503CWD. Keep the guarantee document carefully, but fill in the registration card and return it to your Hasselblad distributor.

DISPOSAL

If you need to dispose of the 503CWD, Imagebank and/or batteries, please do so in an environmentally friendly manner at the local waste plant/ recycling centre or similar.



Further reading

World class results are possible with Hasselblad cameras, witnessed by so many front covers, international advertising campaigns, famous portraits, historical events, etc. But it is the combination of this fine equipment and the abilities of the photographer that produce memorable images. Some of this skill is just sound photographic practice and sometimes it is product specific. The following books are recommended for those that wish to immerse themselves in the world of Hasselblad. The information in them varies from general interest to completely invaluable.

“The Hasselblad Manual” (Fifth edition) by Ernst Wildi. Published by Focal Press - ISBN 0-240-80385-X.

Contains all the information you need to know about the operation of the analogue Hasselblad camera systems, including both recent and earlier equipment. Also contains excellent general practical photographic advice. Written by a world-renowned lecturer on the Hasselblad system and its practical application. A book for the practising Hasselblad photographer.

“HasselbladSystemCompendium” by Richard Nordin. Published by Hove Books - ISBN 1-897802-10-2.

A complete round up of the history of Hasselblad products until 1998. Contains photos and descriptions of rare items long since out of production. A mine of information for those interested in a chronicle of the company and the development of its products. It contains a unique collection of dates, lists and almost anything you would want to know about the history and background of Hasselblad equipment. A book more for the Hasselblad collector or as an informational source for used equipment. Both of the above books are highly recommended by Hasselblad and are available through your Hasselblad dealer, good bookshops or through several Internet bookshops.

The information in this manual is furnished for informational use only, is subject to change without notice, and should not be construed as a commitment by Victor Hasselblad AB & Hasselblad A/S.

Victor Hasselblad AB & Hasselblad A/S assumes no responsibility or liability for any errors or inaccuracies that may appear in this manual.

Victor Hasselblad AB & Hasselblad A/S assumes no responsibility or liability for loss or damage incurred during or as a result of using Hasselblad software or products.

Hasselblad, Imacon, iXpress and FlexColor are trademarks of Victor Hasselblad AB & Hasselblad A/S. Adobe and Adobe Photoshop are trademarks of Adobe Systems, Inc. Macintosh, Mac OS and FireWire are registered trademarks of Apple Computer, Inc. InfoLithium is a registered trademark of Sony Corporation.

Copyright © 2006

Victor Hasselblad AB & Hasselblad A/S

All rights reserved.

503 CWD

H A S S E L B L A D

Victor Hasselblad AB
Box 220,
SE - 401 23 Göteborg,
Sweden

Hasselblad A/S
Hejrevej 30,
DK - 2400 Copenhagen,
Denmark