

H A S S E L B L A D[®]



Instruction manual

2000FC

Hasselblad 2000FC

The Hasselblad 2000FC is a 2 1/4 × 2 1/4 single-lens reflex camera featuring lens, magazine, viewfinder and focusing screen interchangeability. Its unique design gives you a choice of shutter options, focal plane or leaf, depending on your requirements.

The '2000' in the designation 2000FC stands for the fastest shutter speed, 1/2000 s, the 'F' stands for focal plane shutter and the 'C' stands for the (Synchro-) Compur leaf shutter. So you can work with the camera's own focal plane shutter or with the leaf shutter built into lenses made for the Hasselblad 500C, 500C/M, 500EL and 500EL/M since 1957.

Lenses especially designed for the Hasselblad 2000FC will be referred to as F lenses in this instruction manual. Lenses with Synchro-Compur leaf shutters will be referred to as C lenses.

F lenses, which have no built-in shutter, can only be used with the camera's focal plane shutter. But when a C lens is attached to the Hasselblad 2000FC, you can either use the camera's focal plane shutter or the leaf shutter in the lens.

The focal plane shutter serves as a blind when the leaf shutter is the shutter of choice. The leaf shutter provides the advantage of flash synchronization at all shutter speeds down to 1/500 s.

The Hasselblad 2000FC has an electronically timed focal plane shutter with X synchronization at 1/90 s and slower. Electronic shutter timing makes for extremely accurate shutter operation.

A choice of mirror programs is another feature of the Hasselblad 2000FC. The photographer can select a program producing instant mirror return or a program in which the mirror remains in the raised position until the film is advanced after exposure.

The mirror can even be locked in the raised position for special purpose applications. The procedure for making intentional multiple exposures on the same frame has also been greatly simplified in the Hasselblad 2000FC.

This manual will explain camera operation and describe some of the ways to utilize the camera's many advanced features.

It is always advisable to thoroughly study a new or unfamiliar camera's instruction manual before the camera is put to use. The few minutes spent this way can save you a lot of time and trouble later on.

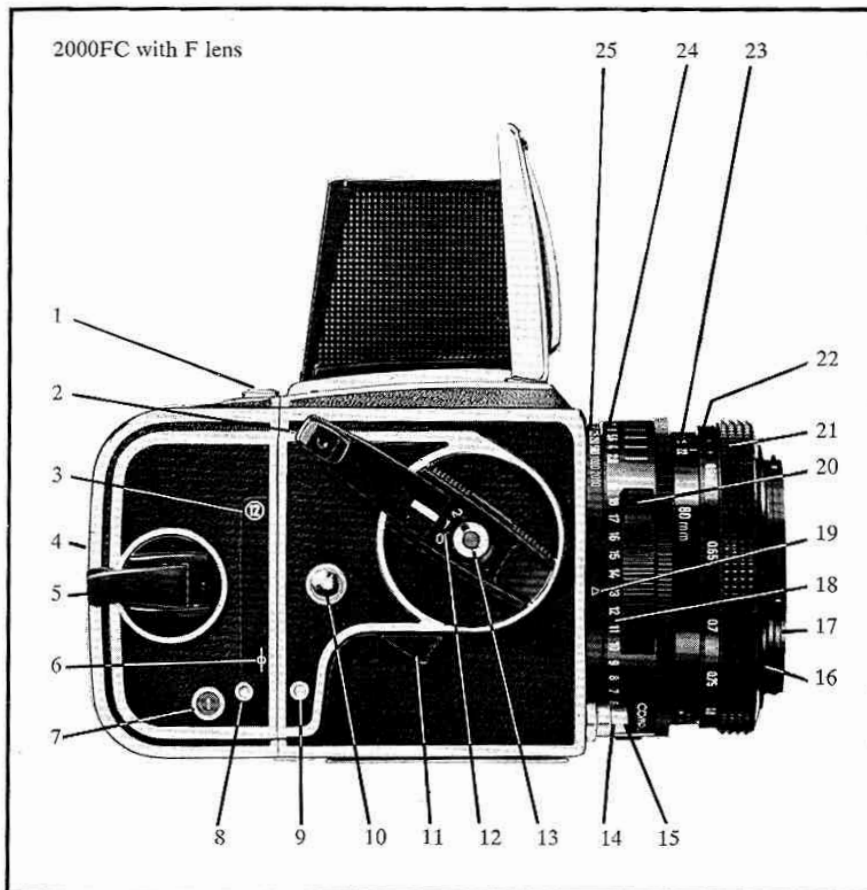

1. Magazine release catch
2. Folding crank for film advance and shutter cocking
3. Magazine designation
4. Film indicator
5. Film winding crank
6. Film plane marking
7. Frame counter window
8. Film advance indicator window
9. Shutter cocking indicator window
10. Strap lug
11. Pre-release latch
12. Mirror program settings
13. Mirror program disc
14. Shutter release button
15. Cable release socket
16. External bayonet accessory mount
17. Internal bayonet accessory mount
18. Exposure value scale
19. Exposure value index (red)
20. Button for cross-coupling of shutter and diaphragm
21. Focusing ring
22. Distance scale
23. Depth-of-field scale
24. Aperture ring with aperture scale
25. Shutter speed ring with shutter speed scale

26. Catch for focusing hood and fine-focus magnifier
27. Fine-focus magnifier
28. Focusing hood
29. Index for shutter speeds
30. Index for aperture scale
31. Index for distance scale
32. Synchronization terminal for focal plane shutter
33. Shutter speed prong
34. Depth-of-field preview catch
35. Fixed grip ring
36. Projecting aperture grip
37. Lens lock release button
38. Lever for locking shutter speed ring
39. Battery compartment with battery cassette
40. Tripod plate and $\frac{3}{8}$ " tripod socket
41. Accessory rail
42. Strap lug
43. Magazine support catches
44. Roll holder key
45. Film consumption indicator
46. Magazine slide
47. Focusing screen

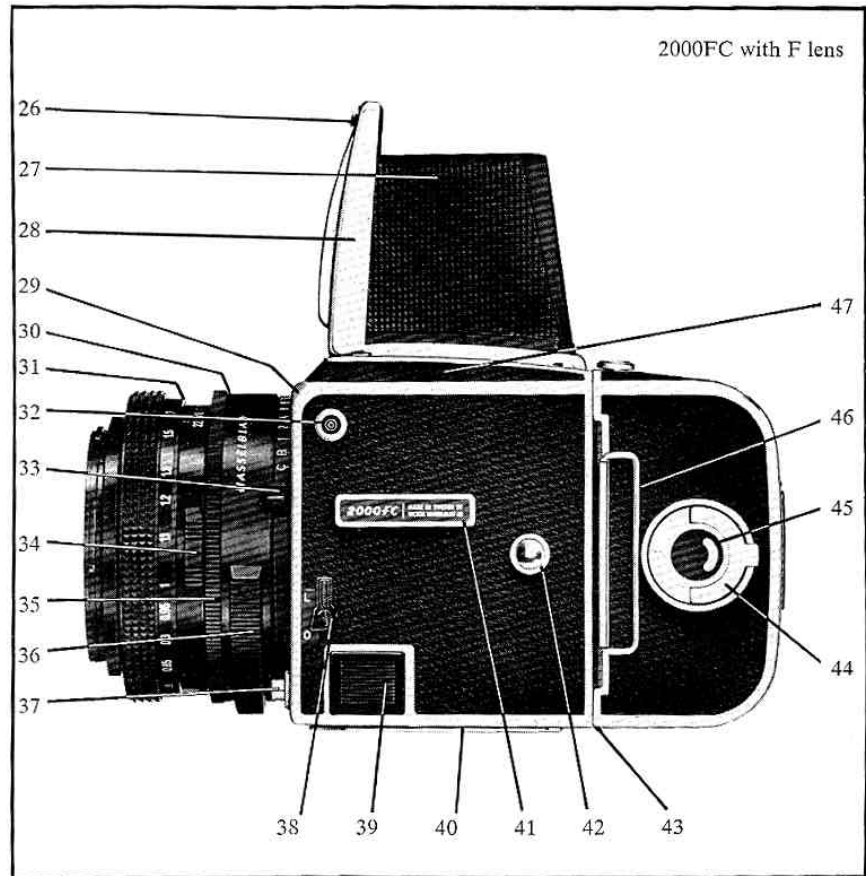

Fig. 2

Open the focusing hood (28) by sliding the catch (26) to the right.

The magazine slide (46) must be removed prior to exposure. A number should show in the frame counter window (7), and the indicator windows (8 and 9) should display white signals.

Button (20) for cross-coupling of shutter and diaphragm.

Folding crank (2) which is wound one full turn to advance the film and cock the shutter.

Mirror program disc (13). To be pressed at the start of shutter cocking with the crank (2) when intentional double exposures are desired. Rotate the disc with a coin to select a mirror action program.

Pre-release operation using the latch (11) cuts camera reaction time to a minimum. Only actual shutter release then takes place when the camera is triggered.

The camera is released when the release latch (14) is pressed. The button contains a cable release socket.

CAMERA OPERATION IN BRIEF

The fine-focus magnifier (27) pops up when the catch (26) on an open focusing hood is again slid to the right.

The focusing hood (28) can be removed. Just slide it back off the camera body after first removing the film magazine. The focusing screen (47) is also interchangeable.

Aperture, shutter speed and distance are set against the indexes (29, 30, 31).

Focus by rotating the focusing ring (21).

Synchronization terminal (32). X synchronization at 1/90 s or longer.

Accessory rail (41) for e. g. a sports viewfinder, spirit level or adjustable flash shoe.

The depth-of-field preview catch (34) can be locked in the stopped down position.

Lever (38) for locking the shutter speed ring.

Battery cassette for 6 V battery.

The lens can be removed once the lens lock release button (37) is pressed. *It should never be removed unless the camera is cocked.*

Bayonet accessory mounts for supplementary lenses, filters and lens shades.

Tripod plate (40) with $\frac{3}{8}$ " tripod socket.

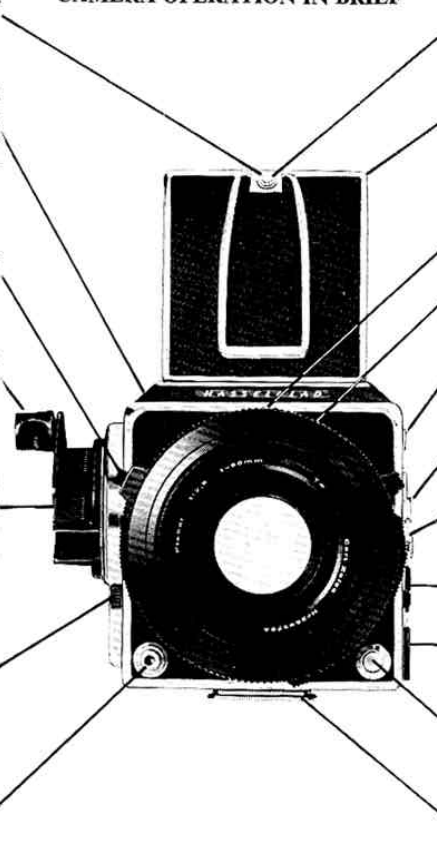

Fig. 3

Lens	F lens plus focal plane shutter	C lens plus focal plane shutter	C lens plus leaf shutter
Shutter	Focal plane	Focal plane	Leaf shutter
Shutter settings	—	Leaf shutter set at B. Leaf shutter's synchronization selector set at X.	Camera's shutter speed ring locked in position C.
Shutter speeds	Speeds: B, 1—1/2000 s set on the camera's shutter speed ring (25).	Speeds: B, 1—1/2000 s set on the camera's shutter speed ring (25).	Speeds: B, 1—1/500 s set on the shutter speed ring of the lens.
Flash synchronization	The flash contact is connected to the camera's flash terminal (32). Shutter speeds of 1/90 s or longer set on the camera's shutter speed ring (25).	The flash contact is connected to the camera's flash terminal (32). Shutter speeds of 1/90 s or longer set on the camera's shutter speed ring (25).	The flash contact is connected to the flash terminal of the lens. Optional shutter speed ranging from B, 1—1/500 s set on the shutter speed ring of the lens.

Fig. 4



Left-hand grip

Fig. 5 shows the best way to hold a Hasselblad 2000FC when photographing. Cradle the camera in your *left* hand with your left index finger resting lightly on the release button.

This leaves your right hand free for other operations such as film winding, shutter cocking, focusing etc. Make it a habit to use the left-hand grip when holding your camera.

Focusing hood (Fig. 6 and 7)

The focusing hood (28) opens automatically when the catch (26) is slid to the right. The hood's fine-focus magnifier is used for critical focusing. It pops up when the catch (26) is again slid to the right with the hood open. To close the hood, first flip the magnifier down until it clicks into place. Then fold the hood walls down over the focusing screen, side walls first, followed by the rear wall and finally the lid.

Changing viewfinders

1. Remove the film magazine.
2. Slide the finder back out of the grooves (only slight resistance should be felt).
3. Slide another finder forward into the grooves.
4. Reattach a film magazine.

Fig. 5

Fig. 6

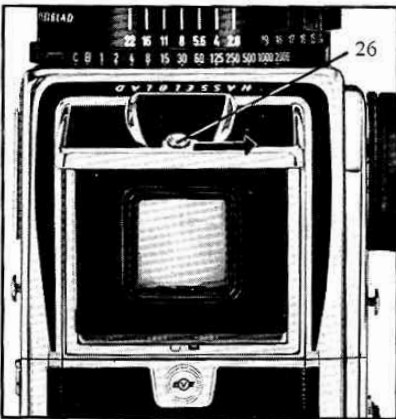
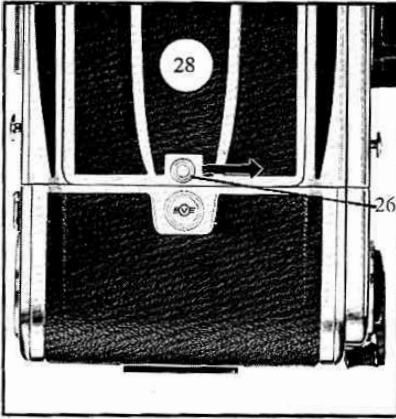

Fig. 7

LENSES

Introduction

All the lenses made for the Hasselblad 500C, 500C/M, 500EL and 500EL/M (C lenses in which the C stands for the built-in Synchro-Compur leaf shutters) also fit the Hasselblad 2000FC. However, a series of lenses (F lenses) have been especially designed for the 2000FC.

F lenses (Fig. 8)

Lenses for the Hasselblad 2000FC will be referred to as F lenses in this instruction manual (the 'F' stands for the focal plane shutter, but will not be found on the lenses themselves). Since F lenses have no built-in shutters, they can not be used with the Hasselblad 500C, 500C/M, 500EL or 500EL/M.

F lenses have diaphragms which automatically stop down to the preselected f/stop when the camera is triggered and reopen to the maximum aperture after concluded exposure. However, the depth-of-field yielded by the preselected f/stop can be previewed using the depth-of-field preview catch (34).

C lenses (Fig. 9)

Lenses made for the Hasselblad 500C, 500C/M, 500EL and 500EL/M will be referred to as C lenses in this instruction manual. (However, this designation will not be found on the lenses themselves). C lenses can even be used with the Hasselblad 2000FC.

Paragraphs printed in bold face indicate the use of C-lenses.

Fig. 8



Fig. 9

Fig. 10

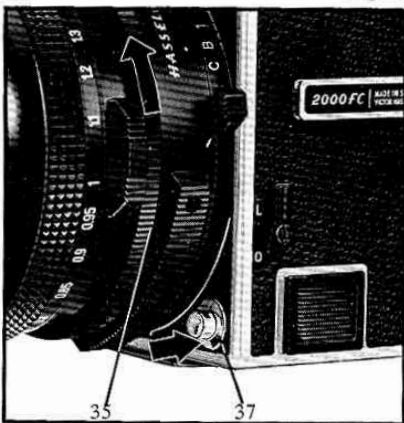

The C lenses have diaphragm which automatically stop down to the preselected f/stop when the camera is triggered. They also have built-in Synchro-Compur leaf shutters fully synchronized at all shutter speeds (1-1/500 s).

The shutter is cocked and the diaphragm reopens to its maximum aperture during the film advance sequence.

CHANGING LENSES

F lenses

Lens removal (Fig. 10)

Make sure the shutter is cocked (white signal in the shutter cocking indicator window 9).

Hold the lens by the fixed grip ring (35) but never press on the button for cross-coupling of shutter and diaphragm (20) during lens removal because this could cause damage to the cross-coupling mechanism. Press the lens lock release button (37) with your left index finger. Then remove the lens by turning it counter-clockwise one-fifth of a revolution using gentle pressure only.

Note: If the lens refuses to budge, the camera is in the pre-release mode. Restore it to the normal mode by depressing the slotted mirror program disc (13) and rotating the film advance crank (2) a full turn.

Lens attachment (Fig. 11)

Make sure the shutter is cocked and not in the pre-release mode (see p. 21). Otherwise the lens mechanism could be dam-

Fig. 11

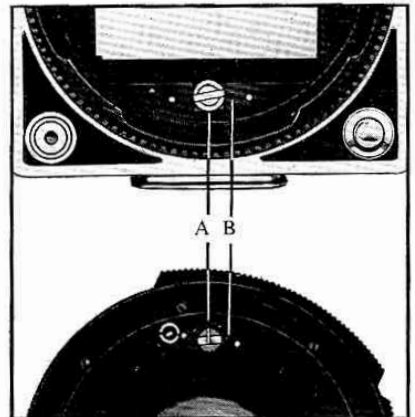

Fig. 12

aged when the lens is attached. Also make sure the diaphragm is cocked. The slot (A) on the head of the cocking shaft should point to the red dot (B). (Also see 'Diaphragm cocking' for details on the cocking of released lenses.)

Align the red triangle at the rear of the lens with the red dot (O) on the camera lens mount (Fig. 11). Then carefully insert the lens into the camera lens mount and rotate the lens *clockwise* one-fifth of turn—using *gentle* pressure—until the lens locks in place with an audible click.

Never press on the button for cross coupling of shutter and diaphragm (20) while changing lenses, since this could cause damage to the cross-coupling mechanism.

C lenses

C lenses are attached and removed in the same manner as F lenses.

Diaphragm cocking (Fig. 12)

F lenses

When an F lens is attached to the camera, the diaphragm mechanism in the lens is automatically cocked at the same time as the film is advanced with the folding crank (2).

Make sure the diaphragm is cocked before a lens is attached to the camera. The diaphragm is cocked when the slot (A) on the head of the cocking shaft points to the red dot (B). If the lens has been off the camera and the diaphragm inadvertently released the diaphragm must be recocked before the lens can be reattached to the camera.

The diaphragm is cocked by rotating the

cocking shaft *clockwise*, using e.g. a coin of suitable size in the shaft slot (A), slightly less than one full turn until the shaft stops in the cocked position. (This procedure should be carried out with great caution so that the coin or any other device used to cock the shaft does not skip out of the slot and damages the rear lens element.)

Note: The same cocking procedure is also employed for extension tubes.

C lenses

The shutter and diaphragm of C lenses are cocked in the same manner as in F lenses.

BATTERY (Fig. 13)

The electronics responsible for shutter timing are powered by a 6 V battery (e.g. PX-28).

Batteries marked with a lower voltage must not be used.

Loading or replacing battery

- Pull out the battery cassette.
 - Insert the battery with the (+) terminal facing the (+) marking in the cassette.
 - To avoid inserting a battery in a mechanically triggered camera, depress the slotted mirror program disc (13) and rotate the film advance crank (2) a full turn.
- (If a battery is inserted in a mechanically triggered camera, the life of the battery will be drastically reduced.)
- Reinsert the cassette containing the battery in the camera.

Fig. 13

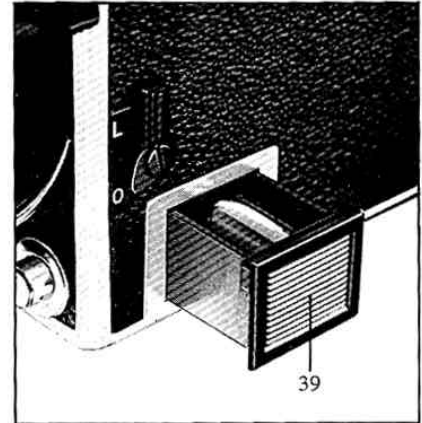

A fresh battery of the above type should last for at least 20,000 exposures. Check regularly to ensure that the battery is not leaking. To prevent the leakage which sometimes occurs after protracted storage, change the battery at least once a year.

Fig. 14

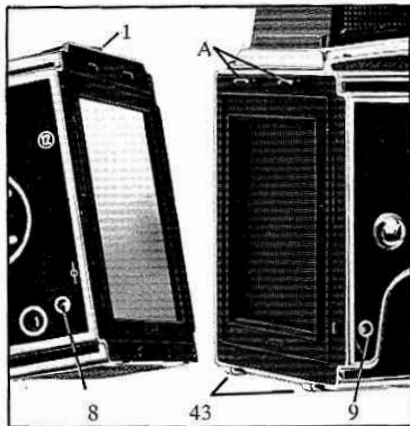
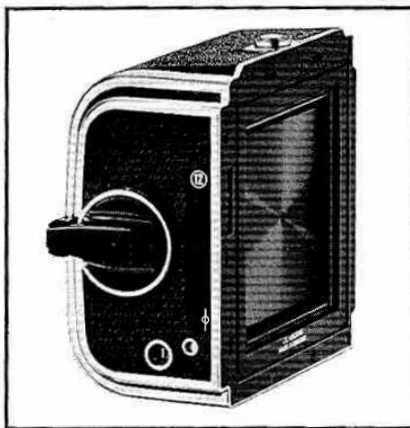

10

Fig. 15

FILM MAGAZINES

All the film magazines in the Hasselblad system fit the Hasselblad 2000FC *except the Magazine 80 for Polaroid film whose projecting glass plate will destroy the shutter curtains in the camera.*

Changing magazines (Fig. 15)

Make sure the indicator windows (8 and 9) display white signals before a magazine is switched.

The magazine slide (46) *must* be inserted before the magazine can be removed from the camera.

Slide the magazine release catch (1) to the right, swing down the magazine and lift it off the camera's two support catches (43). The magazine slide (46) protects the film from fogging when the magazine is off the camera.

A magazine is attached to the camera as follows:

Hook the magazine securely onto the two magazine support catches (43) and pivot the magazine up against the upper locking latches (A) while simultaneously sliding the magazine release catch (1) to the right. Release the release catch. *Then slide it back to the left for secure locking.*

Pull out the magazine slide. Your first exposure can now be made.

Note: A magazine can only be removed from the camera when the magazine slide is in place. *No exposure can be made when the slide is in an attached magazine.*

Fig. 16

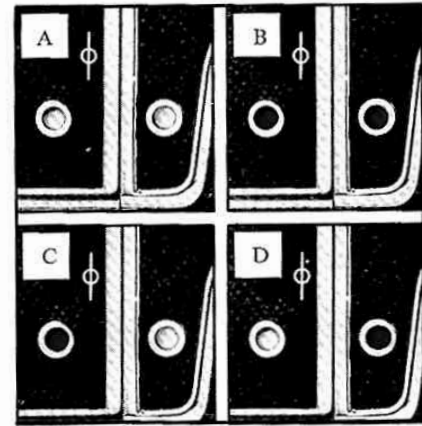
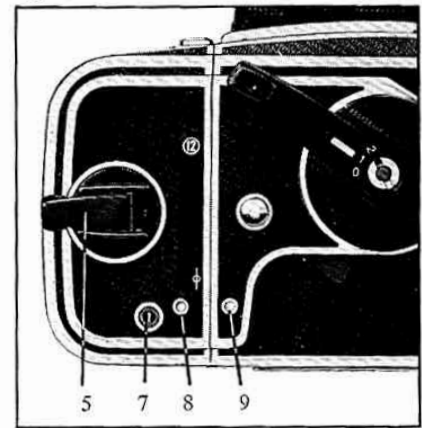

Fig. 17

Indicator signals (Fig. 16 and 17)

The camera body and film magazine have indicator windows (8 and 9) whose displays are affected by the film advance. The following signals can be displayed in the indicator windows:

A. Both windows white: Camera ready for exposure.

B. Both windows red: An exposure has been made but the film has not been advanced nor the shutter cocked. Advance the film and cock the shutter with the crank (2).

C. Film advance indicator window (8) red and shutter cocking indicator window (9) white: Magazine attached to a cocked camera with the exposed frame unadvanced. Remove the magazine, trigger the camera, replace the magazine and advance the film.

D. Film advance indicator window (8) white and shutter cocking indicator window (9) red: Magazine with advanced film attached to uncocked camera. Depress the mirror program disc (13), including the red center button, and wind the crank (2) one full turn. The disc (13) only has to be kept depressed during the initial phase of crank revolution.

General rule: Make sure the signals in the indicator windows (8 and 9) display the same color before attaching a magazine.

Miscellaneous

The film winding crank (5) is only blocked at frame 1. So you can wind film onto the magazine take-up spool any time after frame 1 is exposed.

The frame counter (7) is automatically reset when the roll holder key (44) is removed.

The center of the roll holder key (44) features a film consumption indicator (45) which is white when the film supply spool is full but which gradually turns red as each frame is advanced. A completely red film consumption indicator means that the final frame on a roll has been exposed or that there is no film in the magazine. The ASA or DIN film speed (B) can be set on the film indicator (4).

Settings are made by flipping down the indicator lid (4) and rotating the serrated ring. There is space behind the lid (4) for insertion of a film box tab as a reminder.

Fig. 18

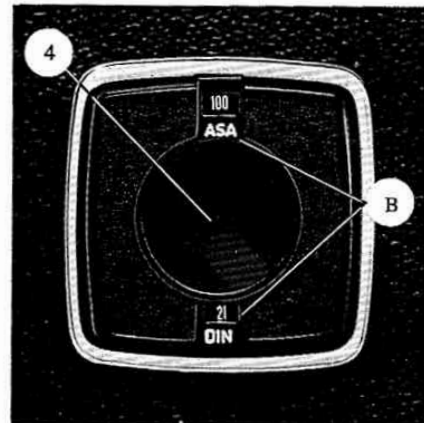
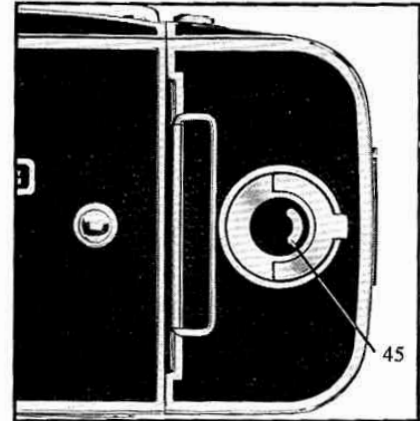

Fig. 19

Fig. 20

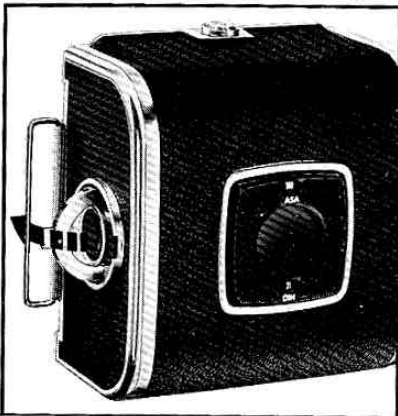

Fig. 21

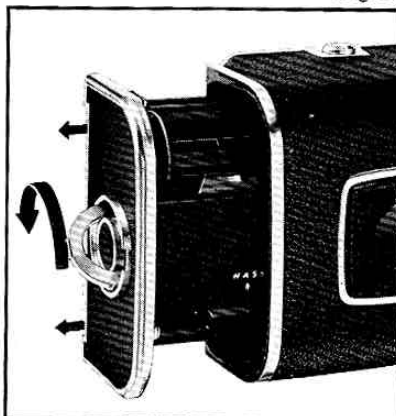
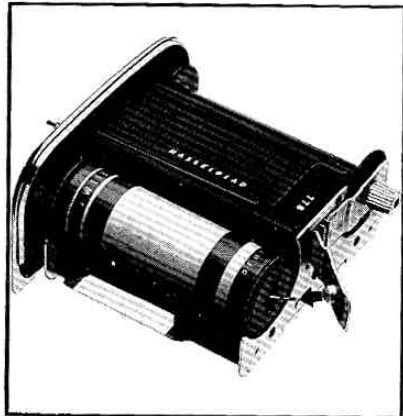
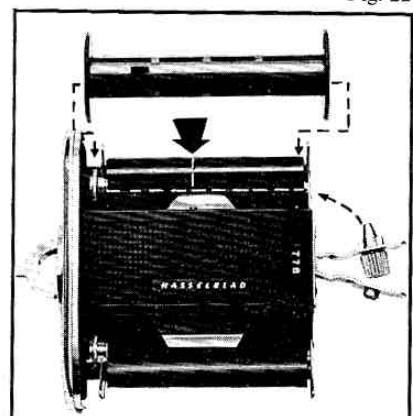

Fig. 22



12

Fig. 23

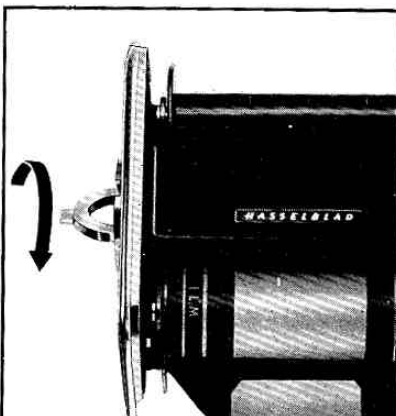

Fig. 24

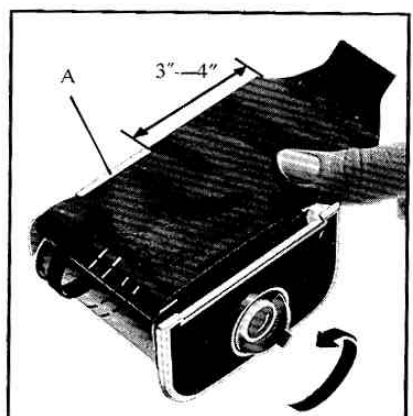

Fig. 25

Loading of Magazine A12

Fig. 20. Fold out the magazine's roll holder key.

Fig. 21. Turn the roll holder key *counter-clockwise*. Pull the roll holder out of the magazine.

Fig. 22. Flip up both spool clips. Insert an empty take-up spool onto the prong on the take-up side and flip down the take-up clip (with the knurled knob) onto the spool.

Fig. 23. Insert a roll of film onto the prong on the film side as shown in the photograph and flip down the film clip (with the red arrow) onto the film spool. Make sure the entire paper band around the film is removed first.

Fig. 24. Turn the roll film holder *clockwise* so that the film clamp (A, Fig. 25) opens.

Fig. 25. Pull out 3—4 inches of paper backing and guide the backing under the film clamp (A). Turn the roll holder key *counter-clockwise* so that the paper backing is held down by the film clamp (A).

Fig. 26. Insert the tongue of the paper backing into a take-up spool slit.

Fig. 27. Roll the paper backing onto the take-up spool, turning the clip knob *clockwise*, until the arrow on the paper backing is aligned with the arrow on the film clip.

Fig. 28. Carefully reinsert the roll holder into the magazine and lock it in place by turning the roll holder key (44) *clockwise*.

Fig. 29. Make sure the magazine slide (46)

Fig. 26

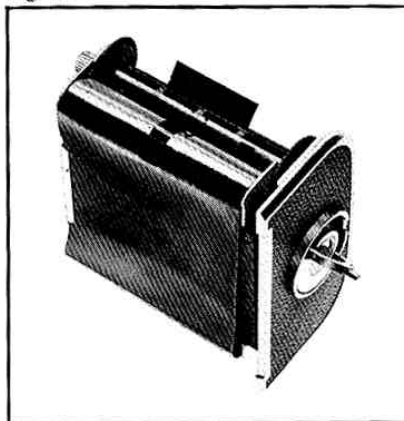

Fig. 27

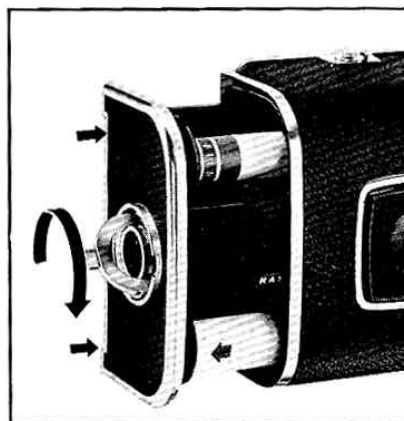
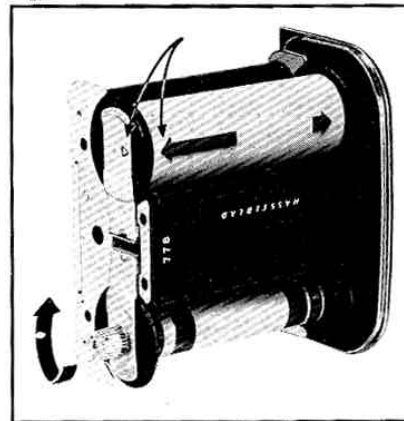

Fig. 28

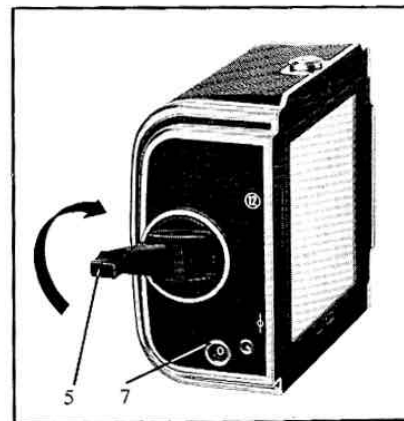

Fig. 29

13

is in place (i.e. that the magazine is attached to the camera).

Fold out the film winding crank (5) and turn it *clockwise* until it stops (about 10 turns). Fold the crank (5) back and flip it down. The number '1' will now be visible in the frame counter window (7). The magazine is loaded and ready for use.

Note: The magazine can only be removed from the camera when the magazine slide is in place. No exposure can be made with the slide inserted in an attached magazine.

After the final frame:

The camera exposure mechanism is blocked after the final frame has been exposed ('12' will be seen in the frame counter window of 12-exposure magazines). Fold out the film winding crank (5) and wind the film onto the take-up spool.

OPERATING THE 2000FC

This part of the instruction manual deals with subjects such as shutter speed and aperture setting, focusing, determining depth-of-field, film advance, mirror program selection, pre-release operation and intentional double exposure.

Using F lenses with the 2000FC

The *f/stop* is set using the aperture ring; this ring has two knurled projections (36, Fig. 30). The ring can be manipulated with the right hand while the camera is held in the left-hand grip.

The *shutter speed* is set against the index (29) with a prong (33) on the shutter speed

14

Fig. 30

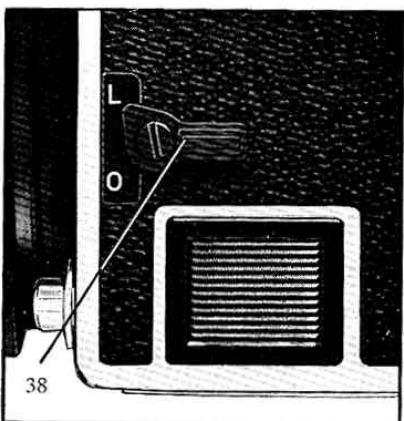
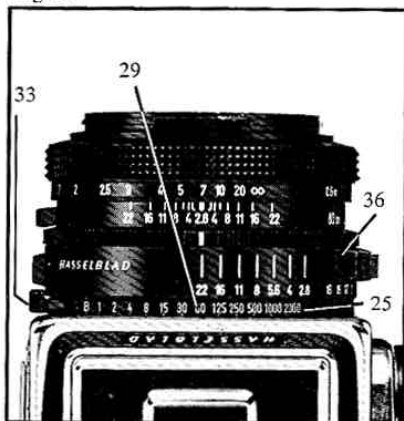

Fig. 31

ring. The most common shutter speeds can be conveniently set just using the thumb of your left hand. F lenses have shutter speeds of B and 1 to 1/2000 s. At the B setting, the shutter remains open as long as the release button is kept depressed. The shutter speed ring (25) has click stops for both engraved and intermediate speeds. Thus, you can set the shutter at 1/250s, 1/375 s, 1/500s, 1/750 s etc. No intermediate speed can be set between 1 and B or between B and C. (Intermediate speeds can not be set on the shutters of C lenses).

The 2000FC shutter speed ring (25) can be locked to prevent accidental displacement. The ring is locked using the lever (38). The lever pointer should point to L (=locked), Fig. 31.

The shutter and diaphragm controls (24 and 25), which normally operate independently, can be cross-coupled by pressing the cross-coupling button (20). With the shutter and diaphragm interlinked in this manner, shutter speed/aperture combinations can be altered with no change in the value set on the exposure value scale. The correct exposure value is obtained with an exposure meter such as the Hasselblad exposure meter or the meter prism finder.

Example: With the button (20) for cross-coupling of shutter and diaphragm depressed, change the aperture from f/8 to f/11. This automatically changes the shutter speed from e.g. 1/250 s to 1/125 s. (Cross-coupling is not possible when an extension tube or bellows extension is used.)

Fig. 32

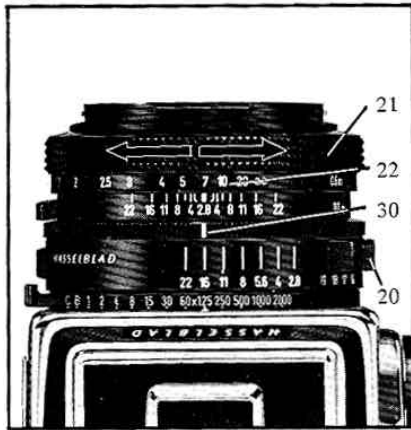

WARNING:

Never press the button (20) for cross-coupling of shutter and diaphragm when the shutter speed ring (25) is locked in the L position or when changing lenses because the cross-coupling mechanism could then be damaged.

Focusing

The lens is focused with the knurled ring (21) at the front of the lens barrel. The ring is rotated until the subject achieves maximum sharpness on the focusing screen.

The distance between the subject and film plane is then shown on the distance scale (22) opposite the distance index (31, Fig. 33).

There are limits to the distance within which close and remote objects can be reproduced sharply at a given f/stop. These limits, referred to as depth-of-field, vary with the aperture used. A small f/stop yields more depth-of-field than a large f/stop when the lens is focused on the same distance.

The depth-of-field at a given f/stop can be read off on the depth-of-field scale (23, Fig. 33) on either side of the distance index (31). In the example shown on this page, the lens is set at 15 ft. At f/16, depth-of-field would range from 10 ft to 50 ft.

Depth-of-field preview (Fig. 34)

A lens is usually focused wide open because the minimum depth-of-field yielded there makes viewfinder images snap in and out of focus more readily. But you can still check out the depth-of-field available at your preselected f/stop by pressing the upper part of the depth-of-field preview catch (34) with your left thumb. This stops the diaphragm down to your preselected f/stop. Pressure on the lower part of the catch restores the diaphragm to its maximum aperture. The lens automatically stops down to the preselected f/stop when the camera is triggered. After exposure the diaphragm reopens to the maximum aperture.

Advancing the film

The film is advanced and the shutter by cocked one full turn of the folding crank (2). Do not press the release button when turning the crank as this could cause an unintentional exposure.

Fig. 33

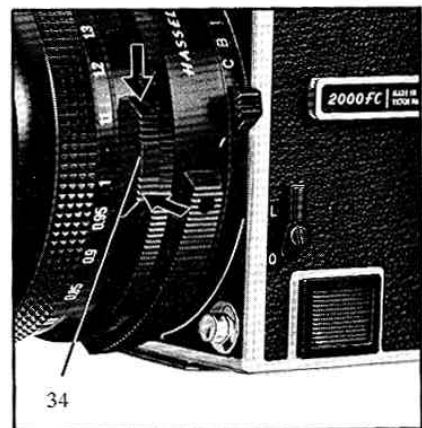
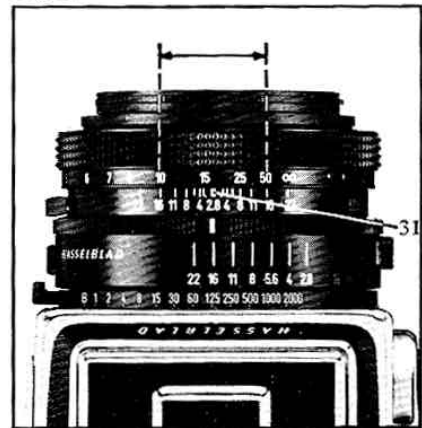

Fig. 34

15

Using C lenses with the 2000FC

Focal plane shutter and C lenses
Since the built-in leaf shutter in the C lens is not used when the photographer elects to work with the 2000FC's focal plane shutter, the shutter speed ring on the C lens must be set at B (green). The synchronization and self-timer selector on the C lenses must be set at X.

NOTE: If the synchronization selector is set at the M instead of the X setting, the catch (I) must be pressed forward before the selector will shift to X. (See Fig. 38.) Be careful not to dislodge the B (green) setting on the lens when setting an f/stop. The camera's shutter speed ring (25) can then be set at an appropriate speed (B, 1-1/2000 s).

Leaf shutter option

When the leaf shutter in a C lens is used in combination with the 2000FC, the camera's shutter speed ring (25) must be set at C (red) on the speed scale and locked at L with the lever (38). With this arrangement, the 2000FC's focal plane shutter serves as a blind, and the leaf shutter in the C lens handles the exposure and flash synchronization.

The shutter speed and f/stop are set on the C lens. The shutter speed ring (B) and diaphragm ring (C) are normally cross-coupled. However, when the cross-coupling release (D) is pressed back, the diaphragm is disengaged, permitting independent setting of aperture and shutter speed values opposite the index (A).

Fig. 35

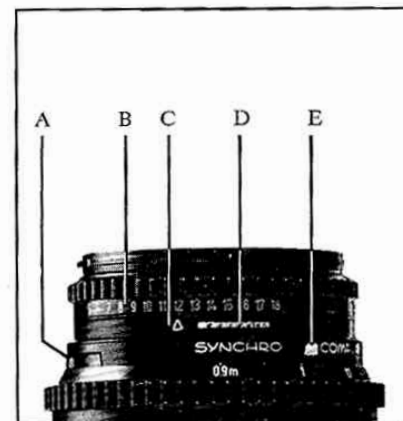

Fig. 36

Depth-of-field is previewed with the catch (E). Pressing on the top of the catch stops the lens down to the preselected f/stop. The diaphragm can be reopened to the maximum aperture by turning the diaphragm ring to the value denoting the maximum aperture.

NOTE: At shutter speeds of 1/4 s or longer, the exposure release button must be kept depressed until the leaf shutter has had time to open and close.

Self-timer

To operate the self-timer press the detent release (I, Fig. 38) forward and cock the self-timer by moving the lever (K) to the V setting. Pressure on the camera release button starts a mechanism which triggers the shutter after 8-10 s.

NOTE: The release button must be kept depressed (most conveniently with a locking cable release) until the shutter has been triggered.

If a locking cable release is used to make the exposure, the locking mechanism must be disengaged before the camera is re-cocked and the film advanced.

FLASH PHOTOGRAPHY

The Hasselblad 2000FC can be used with electronic or expendable flash with F or C lenses.

F lenses

The Hasselblad 2000FC has X synchronization. Flash units are triggered via the camera's recessed synchronization terminal (32, Fig. 37). The contact on the flash unit's synch cord is pressed with a twisting motion into the flash terminal (32) on the camera's left side. This flash terminal features a friction device which keeps the cord contact firmly in place.

The Hasselblad 2000FC synchronizes with electronic flash at shutter speeds of 1/90 s or longer (1/60 s, 1/30 s etc.). 1/90 s is designated with a red 'x' engraved on the shutter speed ring between 60 and 125. Flash operation at shutter speeds faster than 1/90 s (e.g. 1/125 s) is automatically blocked. Expendable flash, such as flash cubes, can also be used at shutter speeds of 1/30 s or longer (1/15 s, 1/8 s etc.)

C lenses (Fig. 38)

With a C lens on your 2000FC you can elect to use the synchronization available via the lens or via the camera. When you work with the leafshutter in the C lens, you have access to electronic flash synchronization at all shutter speeds (1-1/500 s). The flash unit's synch cord contact is attached to the flash terminal (F) on the lens. The leafshutter's X synchronization setting (H) is to be used for electronic flash (at all shutter speeds) and even for

Fig. 37

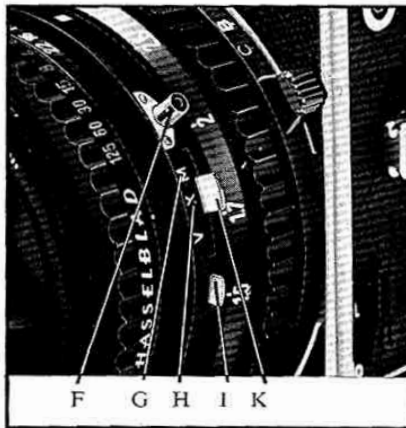
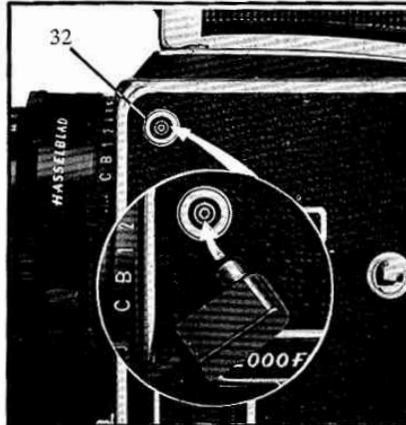

Fig. 38

expendable flash (at shutter speeds up to 1/30 s). When the camera's shutter speed ring (25) is set at C, the synch cord contact must *always* be connected to the synchronization terminal (F) on the C lens.

The leafshutter's M synchronization setting (G) is *only* for use with expendable flash (e.g. flash bulbs or cubes) at shutter speeds faster than 1/30s (1/60s—1/500s). The M synchronization setting delays shutter opening to take full advantage of the light output from expendable flash.

General rule:

Use the camera's flash terminal (32) for flash with the focal plane shutter.

Use the flash terminal on the lens for flash with the leaf shutter.

Fig. 39

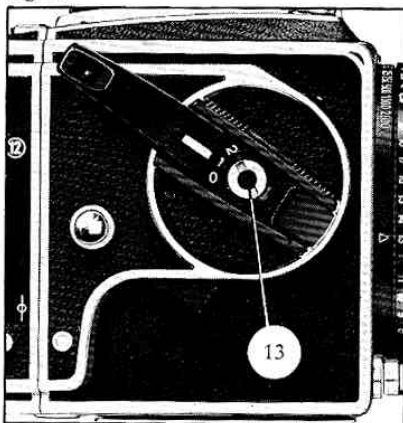

MIRROR PROGRAMS

The Hasselblad 2000FC has three different programs for mirror action. Programs are selected using the mirror program disc (13, Fig. 39).

Setting 2 Instant return mirror (viewfinder image restored instantly) after camera release (with F lenses only).

Setting 1 The mirror remains in the raised position following camera release. It flips down, thereby restoring the viewfinder image, when the film is advanced and the shutter cocked (with both F and C lenses).

Setting 0 Mirror locked in the raised position. The mirror flips down and the viewfinder image is restored only when another program is selected and the camera is cocked (with both F and C lenses).

Use a coin to rotate the mirror program disc (13) nested within the unfolded crank (2) to the desired program setting. When the disc has been correctly positioned, its slot pointing towards the chosen mirror setting, the red detent button in the middle of the disc (13) will pop up again to the same level as the disc.

Fig. 40

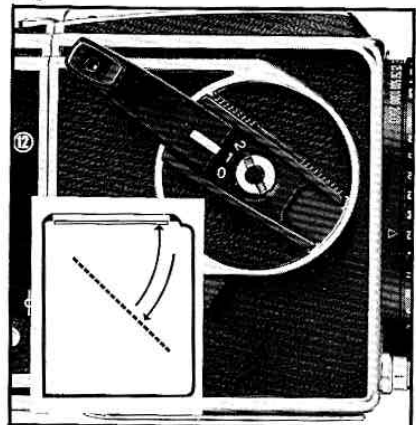

Mirror settings

Setting 2—Instant return mirror (Fig. 40) With mirror program 2, the mirror is raised when the camera is triggered and flips down again after concluded exposure. The viewfinder image is therefore instantly restored (with F lenses) and the diaphragm reopens to its maximum aperture after the exposure sequence.

(When C lenses are used with the 2000FC, the viewfinder image is not restored until the film is advanced and the shutter cocked following an exposure.)

Changes from another mirror program should be made with the camera in a triggered state. This will also cause the mirror to descend.

Fig. 41

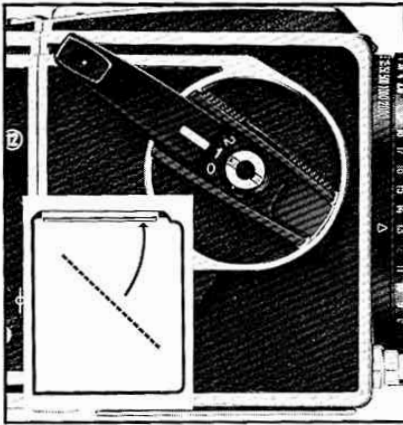

Setting 1—Non-return mirror (Fig. 41)
 With mirror program 1, the mirror remains in the raised position following camera release. It flips down, thereby restoring the viewfinder image, when the film is advanced and the shutter cocked. Setting 1 will appeal to photographers who prefer the viewfinder blackout you get with a non-return mirror as an indication that the camera has not been advanced.
You always get this blackout effect, irrespective of the shutter used or the program selected, when C lenses are used with the 2000FC.
 Changes in the mirror program should be made with the camera in a triggered state. The mirror will then not descend after an exposure.

Fig. 42

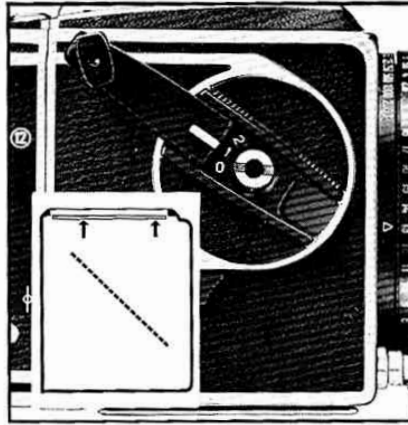

Setting 0—Mirror locked in raised position (Fig. 42)
 With mirror program 0, the mirror is locked in the raised position. Changes in the mirror program should be made with the camera in the cocked state. Raise the mirror by pressing the pre-release latch (11) and lock it in the raised position by turning the mirror program disc (13) to the 0 setting. Mirror program 0 *must* be selected when any special-purpose lens is used whose barrel projects into the camera body and obstructs mirror movement. The mirror must be raised before such lenses are mounted so as to prevent damage to the camera. Setting 0 must also be used when the camera is operated via an electric triggering device connected to the battery

compartment (39). In the case of electric triggering, the lens diaphragm must be locked at the preselected f/stop using the depth-of-field preview catch (34) before exposure can take place. An external viewfinder, such as the sports viewfinder, must be used since no viewfinder image will be shown.

Fig. 43

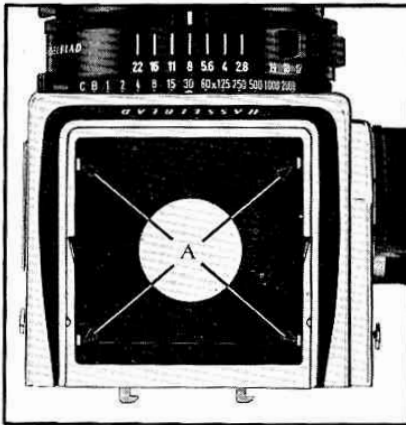

CAMERA BODY

Changing the focusing screen (Fig. 43 and 44)

The camera's standard focusing screen is interchangeable with other Hasselblad focusing screens. Screens are changed as follows:
 First remove the magazine and viewfinder. Slide the screen catches (B) to the side. Cup your hand over the focusing screen and turn the camera upside down. The focusing screen should then drop into your hand. If it fails to drop out, remove the lens and gently tap on the underside of the screen from inside the camera body. The mirror must be in the down position during this operation.
 Insert a new focusing screen, the red marking facing down. Make sure the base of the screen rests on all four support pins. When a finder is slid into place over the focusing screen, the catches (B) automatically lock the screen in place.

Fig. 45

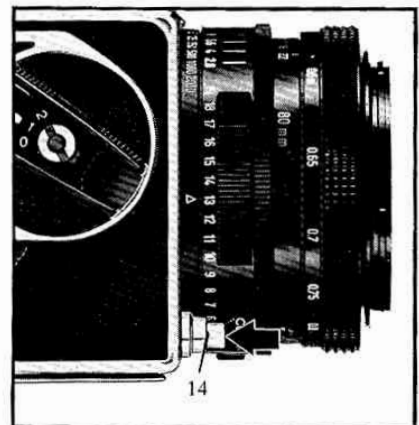
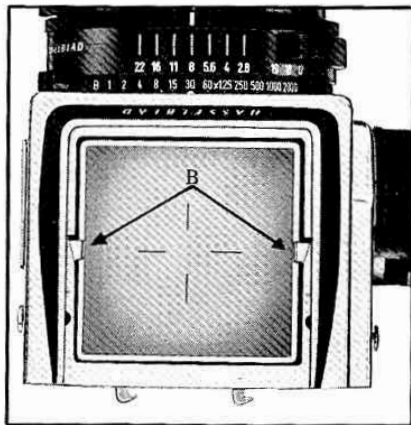
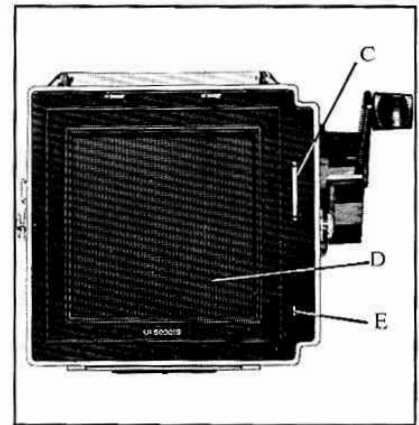

Fig. 46

Fig. 44

Camera body rear plate (Fig. 45)

The curtains of the focal plane shutter (D) can be seen through the opening in the camera body rear plate. These curtains are made of tough but extremely thin titanium (13/1000 mm) and must be protected against any damage. So always use a protective cover when there is no magazine on the camera.

NOTE: The Magazine 80 for Polaroid film must not be used with the Hasselblad 2000FC since its projecting glass plate will destroy the shutter curtains.

Gear (C) actuates film advance in the magazine. The pin (E) actuates the film advance indicator (8) and the double exposure prevention detent. Make sure (C) and (E) are kept free from dust and dirt which could hamper their important functions.

Camera release (Fig. 46)

Pressing the release button (14) triggers a sequence of operations. While part of this sequence is predetermined by the photographer (selection of shutter speed, diaphragm and mirror action program), part of it is governed by internal camera mechanisms (stopping down to a pre-selected aperture, film indication changes and reopening of the diaphragm to maximum aperture after exposure).

A cable release should be used to trigger the camera when long shutter speeds are employed. The camera should then be mounted on a sturdy tripod.

NOTE: When the leaf shutters of C lenses are used at long shutter speeds (1/4 s or

longer), the camera's release button must be kept depressed until the exposure has terminated fully. If the release button is released too soon, the focal plane shutter will interrupt the exposure before the leaf shutter has finished working.

Pre-release operation (Fig. 47)

Pressing the pre-release latch (11) to the rear pre-releases a number of camera operations which make up the normal release sequence.

Pre-release leaves only one such operation, actual shutter release, to be carried out when the release button is pressed. The shutter producing the exposure is the focal plane shutter with F lenses and the leaf shutter when C lenses are used.

The pre-release of certain camera functions reduces camera reaction time to a bare minimum. Blurring due to camera motion is also reduced to a minimum.

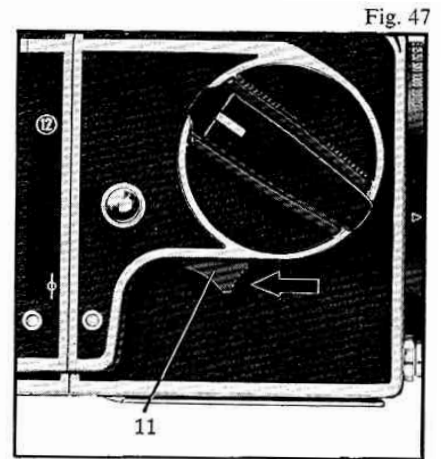
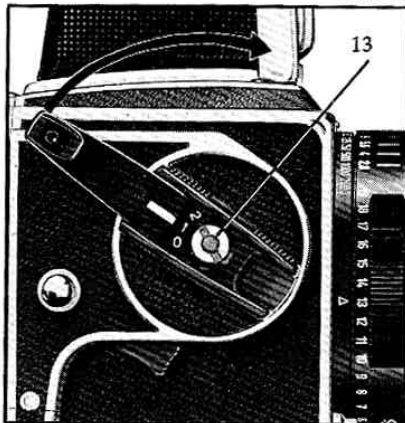

Fig. 47

Fig. 48



Resetting a pre-released camera

A pre-released camera can be reset for conventional operation without an exposure by depressing the slotted disc (13) in the center of the crank (2) and keeping it depressed as you start to wind the crank. Then take your finger away and continue winding the crank a full turn. (Also see 'Double exposure'.)

Double exposure (Fig. 48)

Each film magazine has a built-in double-exposure detent. This detent is easily disengaged with the Hasselblad 2000FC when intentional multiple exposures are desired on the same frame.

The procedure is as follows:

Make your first exposure in the usual manner. Then depress the slotted mirror program disc (13) with your finger. Keep it depressed as you start to wind the crank (2). Then take your finger away and carry on winding the crank a full turn. This procedure re-cocks the camera without advancing the film. So a new exposure can then be made on the exposed frame.

Strap lugs (Fig. 49)

Strap attachment

Hook the strap latch onto the camera strap lugs (10, 42). Press down on the front of the latch while pulling back on the strap. The strap latch should then click into place on the strap lug.

Strap removal

Lift the latch plate while simultaneously sliding the latch forward. The latch will then slip off the strap lug.

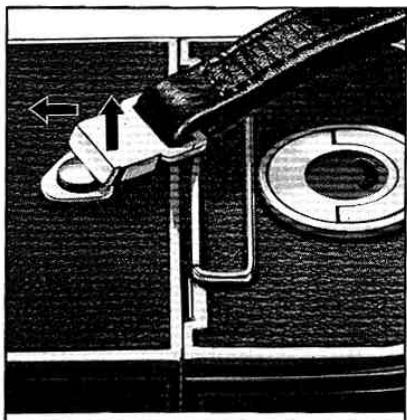
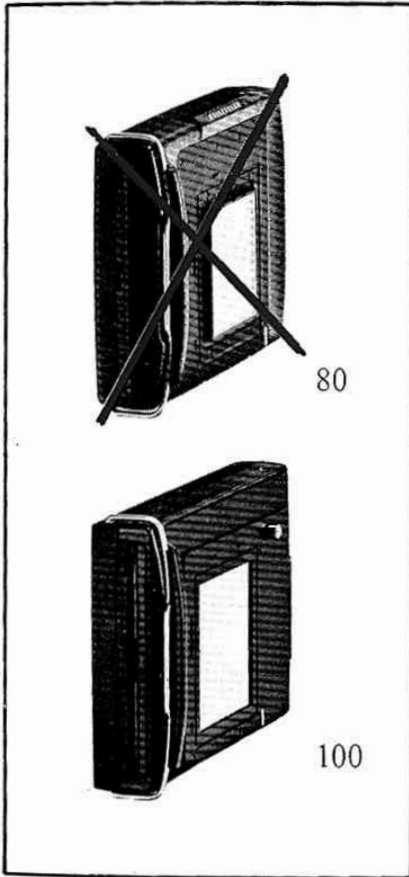

Fig. 50



ACCESSORIES

The Hasselblad 2000FC is part of the extensive Hasselblad system. It has been designed so that most of the accessories for the Hasselblad 500C/M also fit the Hasselblad 2000FC.

For technical reasons, there are a few exceptions, however. **The Magazine 80 for Polaroid film (Fig. 50) must not be used on the Hasselblad 2000FC.** Though it is physically possible to attach this magazine to the camera, the magazine's projecting glass plate would then impinge upon and destroy the shutter curtains. The magazine 100 for Polaroid film has a recessed glass plate and can therefore be used with the Hasselblad 2000FC.

The 10 mm and 21 mm extension tubes will only fit the Hasselblad 500C/M, 500C, 500EL/M and 500EL. The projecting shutter speed ring on the 2000FC prevents attachment of these tubes to the 2000FC camera's bayonet mount. However, the 55 mm extension tube will fit the 2000FC. Two extension tubes have been especially designed for the Hasselblad 2000FC. They are 16 and 32 mm long respectively (Fig. 51).

A number of new accessories for the 2000FC will be introduced to take advantage of the camera's electronics. These accessories will be designed for connection to the camera via the camera's battery compartment.

Lens accessories

The design of lenses made for the Hasselblad 2000FC differs from the design of other lenses in the Hasselblad system.

So a special program of accessories, including filters, lens shades etc., will be supplied for these lenses.

However, most of the accessories which fit the 80mm Planar f/2.8 for the 2000FC will also fit the 80mm Planar with a between-the-lens shutter.

Note: You can *not* use a quick-focusing handle on C lenses in focal lengths of 80mm or less in combination with the Hasselblad 2000FC. This is because of the limited space available between the camera's shutter speed ring and the distance scale on C lenses.



Fig. 51

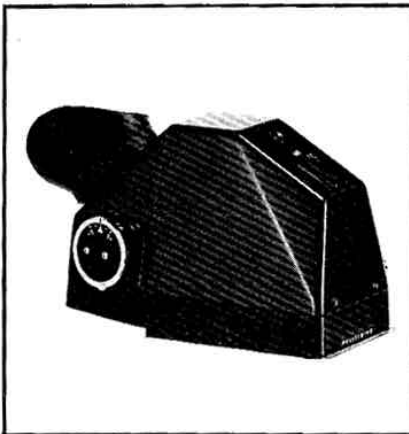

The Hasselblad meter prism finder is an excellent aid in determining correct exposure. The bright, unreversed viewfinder image is enlarged 3x. The finder's built-in CdS meter measures the light passing through the lens and falling on the focusing screen. Measurement results are displayed on an exposure value scale at the base of the viewfinder field. The displayed value is then transferred to the lens.

The meter is **center-weighted** so that 50% of its sensitivity is located in a circle 1 in in diameter at the middle of the focusing screen. Remaining meter sensitivity is evenly distributed over the surrounding field. The meter can be set for film speeds from 25 to 1600 ASA.

The Hasselblad meter prism finder fits the Hasselblad 500C, 500C/M, 500EL, 500EL/M as well as the Hasselblad 2000FC.

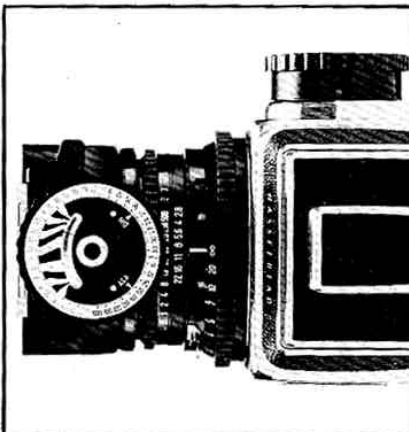

The Hasselblad system also features an exposure meter with a selenium cell. This meter works without batteries and can be used for close-up measurement of the light falling onto or reflected from your subject. The meter can also double as a film advance/shutter cocking knob on the Hasselblad 500C and 500C/M. With the aid of a special attachment, the exposure meter can also be mounted on the lens shade.

Service and maintenance

Cameras and lenses put to heavy-duty professional use should be given regular service at an authorized Hasselblad service center.

We recommend a check-up every 6 months or after about every 5000 exposures. Lubricants can dry out in cameras and lenses put aside for any length of time. The high-precision mechanism could then malfunction. The camera should periodically be cocked and released several times at every shutter speed. This is especially important when operating the camera for the first time after a long period of disuse. First give it a run through without magazine attached. Inspect the camera body and lens to make sure everything works at all shutter speeds.

WARRANTY

The Hasselblad camera is made in Göteborg, Sweden. It is a product of the highest quality and is therefore guaranteed to be free from defective material and workmanship for a period of twelve months from date of purchase. **As soon as you take delivery of your camera you should mail the enclosed registration card (name and address in block letters) to the factory or distributor in your country.** The warranty will be sent to you as soon as your registration card has been received. We will also put you on our mailing list and send you our printed matter. The warranty does not cover any damage caused to the camera as a result of abnormal use. Transportation costs to and from the nearest Hasselblad authorized service center will be defrayed by the camera owner.

VICTOR HASSELBLAD AKTIEBOLAG
Box 220, S-401 23 Göteborg, Sweden