

Canon

EOS-1D X



- This manual is for the EOS-1D X installed with firmware version 2.0.0 or later.
- The “Software Start Guide” is included at the end of this manual.

E

**INSTRUCTION
MANUAL**

Canon EOS-1D X

INSTRUCTION MANUAL **E**

Introduction

The EOS-1D X is the top-of-the-line EOS DIGITAL high-performance digital single-lens reflex camera featuring a full-frame (approx. 36 x 24 mm) CMOS sensor with approx. 18.1 effective megapixels, Dual DIGIC 5+, normal ISO speed range of ISO 100 - 51200, approx. 100% viewfinder coverage, high-precision and high-speed 61-point AF, approx. 12 fps high-speed continuous shooting, RGB metering sensor, 3.2-inch LCD monitor, Live View shooting, and Full High-Definition (Full HD) movie shooting.

The camera is highly responsive to any shooting situation, provides many features for demanding shots, is highly reliable even in harsh environments, and is compatible with a wide range of accessories that expand shooting possibilities.

Refer to This Manual while Using the Camera to Further Familiarize Yourself with the Camera

With a digital camera, you can immediately view the image you have captured. While reading this manual, take a few test shots and see how they come out. You can then better understand the camera.

To avoid botched pictures and accidents, first read the “Safety Warnings” (p.413, 414) and “Handling Precautions” (p.14, 15).

Testing the Camera Before Use and Liability

After shooting, play images back and check whether they have been properly recorded. If the camera or memory card is faulty and the images cannot be recorded or downloaded to a computer, Canon cannot be held liable for any loss or inconvenience caused.

Copyrights

Copyright laws in your country may prohibit the use of your recorded images of people and certain subjects for anything but private enjoyment. Also be aware that certain public performances, exhibitions, etc., may prohibit photography even for private enjoyment.

CF Card

In this manual, “card” refers to a CF card. **The CF card** (for recording images) **is not included**. Please purchase it separately.

Item Check List

Before starting, check that all the following items have been included with your camera. If anything is missing, contact your dealer.



Camera

(with body cap and battery compartment cap)



Eyecup Eg



**Battery Pack
LP-E4N**

(with protective cover)



**Battery Charger
LC-E4N**

(with protective covers)



Wide Strap L7



**Interface Cable
IFC-200U**

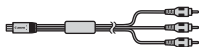

**Stereo AV Cable
AVC-DC400ST**



Cable Protector



**EOS DIGITAL Solution Disk
(Software)**



**Software Instruction
Manuals**



(1)

(2)

(3)

- (1) **Camera Instruction Manual** (this booklet)
- (2) **Wired LAN Instruction Manual**
- (3) **Quick Reference Guide**

* Attach Eyecup Eg to the viewfinder eyepiece.

* Be careful not to lose any of the above items.

Wired LAN

To set up a wired LAN using the Ethernet RJ-45 terminal (p.21), refer to the separate "Wired LAN Instruction Manual."





Software Instruction Manuals

The Software Instruction Manuals are included on the CD-ROM as PDF files. See page 425 for instructions to look up information in the Software Instruction Manuals.



Conventions Used in this Manual

Icons in this Manual

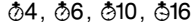
-  : Indicates the Main Dial.
-  : Indicates the Quick Control Dial.
-  : Indicates the Multi-controller.
-  : Indicates the Setting button.
-  : Indicates that the corresponding function remains active for 4 sec., 6 sec., 10 sec., or 16 sec. respectively after you let go of the button.

* In this manual, the icons and markings indicating the camera's buttons, dials, and settings correspond to the icons and markings on the camera and on the LCD monitor.

MENU : Indicates a function that can be changed by pressing the <MENU> button and changing the setting.

(p.**): Reference page numbers for more information.

 : Warning to prevent shooting problems.

 : Supplemental information.

 : Tips or advice for better shooting.

 : Problem-solving advice.

Basic Assumptions

- All operations explained in this manual assume that the power switch is already set to <ON> (p.38).
- It is assumed that all the menu settings and Custom Functions are set to their defaults.
- The illustrations in this manual show the camera attached with the EF50mm f/1.4 USM lens as an example.

Chapters

	Introduction	2
1	Getting Started	29
2	Setting the AF and Drive Modes	65
3	Image Settings	119
4	Exposure Control	169
5	Flash Photography	195
6	Shooting with the LCD Monitor (Live View Shooting)	205
7	Shooting Movies	225
8	Image Playback	251
9	Post-Processing Images	291
10	Sensor Cleaning	299
11	Printing Images and Transferring Images to a Computer	305
12	Customizing the Camera	323
13	Reference	365
14	Software Start Guide	425

Contents



Introduction 2

Item Check List.....	3
Conventions Used in this Manual.....	4
Chapters.....	5
Index to Features	12
Handling Precautions	14
Quick Start Guide	16
Nomenclature	18



1 Getting Started 29

Charging the Battery	30
Installing and Removing the Battery.....	34
Installing and Removing the Card	35
Turning on the Power	38
Setting the Date, Time, and Zone	40
Selecting the Interface Language.....	42
Attaching and Detaching a Lens	43
Basic Operation.....	45
Q Quick Control for Shooting Functions.....	51
MENU Menu Operations.....	53
Before You Start.....	55
Formatting the Card.....	55
Setting the Power-off Time/Auto Power Off	57
Setting the Image Review Time	57
Reverting the Camera to the Default Settings	58
Displaying the Grid and Electronic Level.....	61
? Feature Guide.....	63

2 Setting the AF and Drive Modes 65







AF : Selecting the AF Mode	66
 Selecting the AF Area	69
AF Area Selection Modes	73
About the AF Sensor	76
Lenses and Usable AF Points	77
Selecting AI Servo AF Characteristics (For a Subject)	85
Customizing AF Functions	94
Fine Adjustment of AF's Point of Focus (AF Microadjustment)	107
When Autofocus Fails	113
MF : Manual Focusing	114
DRIVE : Selecting the Drive Mode	115
 Using the Self-timer	117

3 Image Settings 119

Selecting the Card for Recording and Playback	120
Setting the Image-Recording Quality	123
ISO : Setting the ISO Speed	130
Selecting a Picture Style	135
Customizing a Picture Style	138
Registering a Picture Style	141
WB : Setting the White Balance	143
 Custom White Balance	144
 Setting the Color Temperature	149
 White Balance Correction	150
Correcting the Brightness and Contrast Automatically (Auto Lighting Optimizer) ..	152
Noise Reduction Settings	153
Highlight Tone Priority	156
Lens Peripheral Illumination / Chromatic Aberration Correction ...	157

Creating and Selecting a Folder	160
Changing the File Name	162
File Numbering Methods	164
Setting Copyright Information	166
Setting the Color Space	168



4 Exposure Control 169

P : Program AE	170
Tv : Shutter-Priority AE	173
Av : Aperture-Priority AE	175
Depth of Field Preview	176
M : Manual Exposure	177
 Selecting the Metering Mode	179
 Setting Exposure Compensation	181
 Auto Exposure Bracketing (AEB)	182
 AE Lock	183
Bulb Exposures	184
 Multiple Exposures	186
 Mirror Lockup	193

5 Flash Photography 195



 Flash Photography	196
Setting the Flash	199

6 Shooting with the LCD Monitor (Live View Shooting) 205









 Preparing for Live View Shooting	206
 Shooting with the LCD Monitor	207
Shooting Function Settings	211
Menu Function Settings	212





Using AF to Focus	215
Focusing Manually	222

7 Shooting Movies 225



 Preparing to Shoot Movies	226
 Shooting Movies	227
Autoexposure Shooting	227
Shutter-priority AE	228
Aperture-priority AE	229
Manual Exposure Shooting	231
Shooting Still Photos	236
Shooting Function Settings	238
Setting the Movie-Recording Size	239
Setting the Sound Recording	242
Silent Control	244
Setting the Time Code	245
Menu Function Settings	247

8 Image Playback 251

 Image Playback	252
INFO.: Shooting Information Display	254
  Searching for Images Quickly	257
 Magnified View	259
 Rotating the Image	261
Setting Ratings	262
 Quick Control During Playback	264
 Enjoying Movies	266
 Playing Movies	268
 Editing the Movie's First and Last Scenes	270
Slide Show (Auto Playback)	272

Viewing the Images on TV	275
 Protecting Images	279
 Recording and Playing Voice Memos	281
 Copying Images	283
 Erasing Images	286
Changing Image Playback Settings	288
Adjusting the LCD Monitor Brightness	288
Auto Rotation of Vertical Images	289





9 Post-Processing Images 291

  Processing RAW Images with the Camera	292
 Resize	297

10 Sensor Cleaning 299

 Automatic Sensor Cleaning	300
Appending Dust Delete Data	301
Manual Sensor Cleaning	303

11 Printing Images and Transferring Images to a Computer 305

Preparing to Print	306
 Printing	308
Trimming the Image	313
 Digital Print Order Format (DPOF)	315
 Direct Printing with DPOF	318
 Transferring Images to a Personal Computer	319

12 Customizing the Camera 323

Custom Functions	324
------------------------	-----

Custom Function Settings.....	326
C.Fn1: Exposure	326
C.Fn2: Exposure	330
C.Fn3: Drive	333
C.Fn4: Disp./Operation	334
C.Fn5: Operation.....	336
C.Fn6: Others.....	339
C.Fn5: Custom Controls	343
Registering My Menu	357
Saving and Loading Camera Settings	358
C : Registering Custom Shooting Modes	361

13 Reference 365

Function Availability Table According to Shooting Mode	366
System Map	368
INFO. Button Functions	370
Checking the Battery Information.....	372
Using a Household Power Outlet.....	373
Replacing the Date/Time Battery	374
Menu Settings	375
Troubleshooting Guide.....	384
System Status Display	398
Error Codes.....	401
Specifications	402
Safety Warnings.....	413

14 Software Start Guide 425

Software Start Guide.....	426
Index	429

Index to Features

Power

- Charging the battery → p.30
- Battery check → p.39
- Battery information check → p.372
- Power outlet → p.373
- Auto power off → p.57

Card

- Format → p.55
- Select card → p.120
- Release shutter without card → p.36

Lens

- Attaching/Detaching → p.43

Basic Settings

- Language → p.42
- Date/Time/Zone → p.40
- Beeper → p.376
- Copyright information → p.166
- Clear all camera settings → p.58

Viewfinder

- Diopter adjustment → p.45
- Eyepiece shutter → p.185
- Grid display → p.61
- Electronic level → p.61
- Focusing Screen → p.334

LCD monitor

- Brightness adjustment → p.288
- Electronic level → p.62
- Feature guide → p.63

AF

- AF mode → p.66
- AF area selection mode → p.69

- AF point selection → p.71
- AI Servo AF characteristics → p.85
- Auto AF point selection:
EOS iTR AF → p.97
- AF Custom Functions → p.94
- AF Microadjustment → p.107
- Manual focusing → p.114

Metering

- Metering mode → p.179
- Multi-spot metering → p.180

Drive

- Drive mode → p.115
- Self-timer → p.117
- Maximum burst → p.128

Recording Images

- Record func. → p.120
- Create/select a folder → p.160
- File name → p.162
- File numbering → p.164

Image Quality

- Image size → p.123
- JPEG quality (Compression rate) → p.129
- ISO speed → p.130
- Picture Style → p.135
- White balance → p.143
- Auto Lighting Optimizer → p.152
- Noise reduction for high ISO speeds → p.153
- Noise reduction for long exposures → p.154
- Highlight tone priority → p.156
- Peripheral illumination correction → p.157
- Chromatic aberration correction → p.158
- Color space → p.168

Shooting

- Shooting mode → p.24
- Multiple exposures → p.186
- Mirror lockup → p.193
- Depth-of-field preview → p.176
- Remote Switch → p.185
- Quick Control → p.51

Exposure Adjustment

- Exposure compensation → p.181
- AEB → p.182
- AE lock → p.183
- Safety shift → p.329

Flash

- External flash → p.195
- External flash function settings → p.199
- External Speedlite Custom Functions → p.204

Live View shooting

- Live View shooting → p.205
- Focusing → p.215

Movie Shooting

- Movie shooting → p.225
- Movie recording size → p.239
- Sound recording → p.242
- Time code → p.245
- Still photo shooting → p.236

Playback

- Image review time → p.57
- Single-image display → p.252
- Shooting information display → p.254
- Index display → p.257

- Image browsing (Jump display) → p.258
- Magnified view → p.259
- Image rotate → p.261
- Rating → p.262
- Movie playback → p.268
- Slide show → p.272
- Viewing images on TV → p.275
- Protect → p.279
- Voice memo → p.281
- Copying → p.283
- Erase → p.286

Image Editing

- RAW image processing → p.292
- Resize → p.297

Printing and Transferring Images

- PictBridge → p.306
- Print Order (DPOF) → p.315
- Image transfer → p.319

Wired LAN

- Wired LAN → Separate booklet

Customization

- Custom Functions (C.Fn) → p.324
- Custom Controls → p.343
- My Menu → p.357
- Saving camera settings → p.358
- Custom shooting mode → p.361

Sensor Cleaning and Dust Reduction

- Sensor cleaning → p.300
- Append Dust Delete Data → p.301

Error and Caution Messages

- System status display → p.398

Handling Precautions

Camera Care

- This camera is a precision instrument. Do not drop it or subject it to physical shock.
- The camera is not waterproof and cannot be used underwater. If you accidentally drop the camera into water, promptly consult your nearest Canon Service Center. Wipe off any water droplets with a dry cloth. If the camera has been exposed to salty air, wipe it with a well-wrung wet cloth.
- Never leave the camera near anything having a strong magnetic field such as a magnet or electric motor. Also avoid using or leaving the camera near anything emitting strong radio waves such as a large antenna. Strong magnetic fields can cause camera misoperation or destroy image data.
- Do not leave the camera in excessive heat such as in a car in direct sunlight. High temperatures can cause the camera to malfunction.
- The camera contains precision electronic circuitry. Never attempt to disassemble the camera yourself.
- Do not block the mirror operation with your finger, etc. Doing so may cause a malfunction.
- Use a blower to blow away dust on the lens, viewfinder, reflex mirror, and focusing screen. Do not use cleaners that contain organic solvents to clean the camera body or lens. For stubborn dirt, take the camera to the nearest Canon Service Center.
- Do not touch the camera's electrical contacts with your fingers. This is to prevent the contacts from corroding. Corroded contacts can cause camera misoperation.
- If the camera is suddenly brought in from the cold into a warm room, condensation may form on the camera and internal parts. To prevent condensation, first put the camera in a sealed plastic bag and let it adjust to the warmer temperature before taking it out of the bag.
- If condensation forms on the camera, do not use the camera. This is to avoid damaging the camera. If there is condensation, remove the lens, card and battery from the camera, and wait until the condensation has evaporated before using the camera.
- If the camera will not be used for an extended period, remove the battery and store the camera in a cool, dry, well-ventilated location. Even while the camera is in storage, press the shutter button a few times once in a while to check that the camera is still working.
- Avoid storing the camera where there are corrosive chemicals such as a darkroom or chemical lab.
- If the camera has not been used for an extended period, test all its functions before using it. If you have not used the camera for some time or if there is an important shoot coming up, have the camera checked by your Canon dealer or check the camera yourself and make sure it is working properly.

LCD Panel and LCD Monitor

- Although the LCD monitor is manufactured with very high precision technology with over 99.99% effective pixels, there may be a few dead pixels among the remaining 0.01% or less pixels. Dead pixels displaying only black or red, etc., are not a malfunction. They do not affect the images recorded.
- If the LCD monitor is left on for a prolonged period, screen burn-in may occur where you see remnants of what was displayed. However, this is only temporary and will disappear when the camera is left unused for a few days.
- In low or high temperatures, the LCD monitor display may seem slow or it may look black. It will return to normal at room temperature.

Cards

To protect the card and its recorded data, note the following:

- Do not drop, bend, or wet the card. Do not subject it to excessive force, physical shock, or vibration.
- Do not store or use the card near anything having a strong magnetic field such as a TV set, speakers, or magnet. Also avoid places prone to having static electricity.
- Do not leave the card in direct sunlight or near a heat source.
- Store the card in a case.
- Do not store the card in hot, dusty, or humid locations.

Lens

After detaching the lens from the camera, attach the lens caps and put down the lens with the rear end up to avoid scratching the lens surface and electrical contacts.

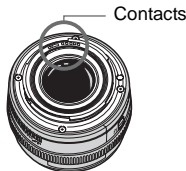

Cautions During Prolonged Use

If you use continuous shooting, Live View shooting, or movie shooting for a prolonged period, the camera may become hot. Although this is not a malfunction, holding the hot camera for a long period can cause slight skin burns.

Quick Start Guide

1

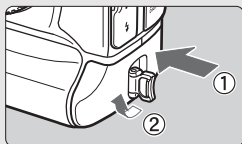

Insert the battery (p.34).

- To charge the battery, see page 30.

2

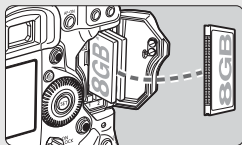

Insert a card (p.35).

- Two cards can be inserted.

3

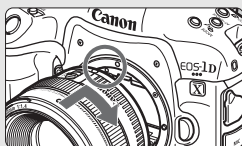

Attach the lens (p.43).

- Align it with the red dot.

4

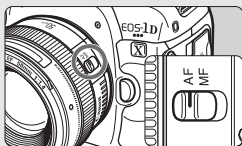

Set the lens focus mode switch to <AF> (p.43).

5

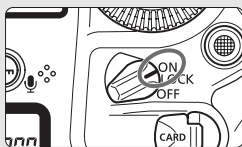



Set the power switch to <ON> (p.38).

6

**Set the shooting mode to <P>**

(p.170).

- Press the <MODE> button.
- Look at the top LCD panel and turn the <  /  > dial to select <P>.

7

**Focus the subject** (p.46).

- Look through the viewfinder and aim the viewfinder center over the subject.
- Press the shutter button halfway, and the camera will focus the subject.

8

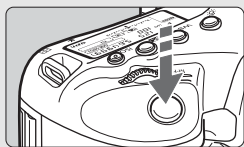
**Take the picture** (p.46).

- Press the shutter button completely to take the picture.

9

**Review the picture** (p.57).

- The captured image will be displayed for 2 sec. on the LCD monitor.
- To display the image again, press the <  > button (p.252).

- To shoot while looking at the LCD monitor, see “Live View Shooting” (p.205).
- To view the images captured so far, see “Image Playback” (p.252).
- To delete an image, see “Erasing Images” (p.286).

Nomenclature

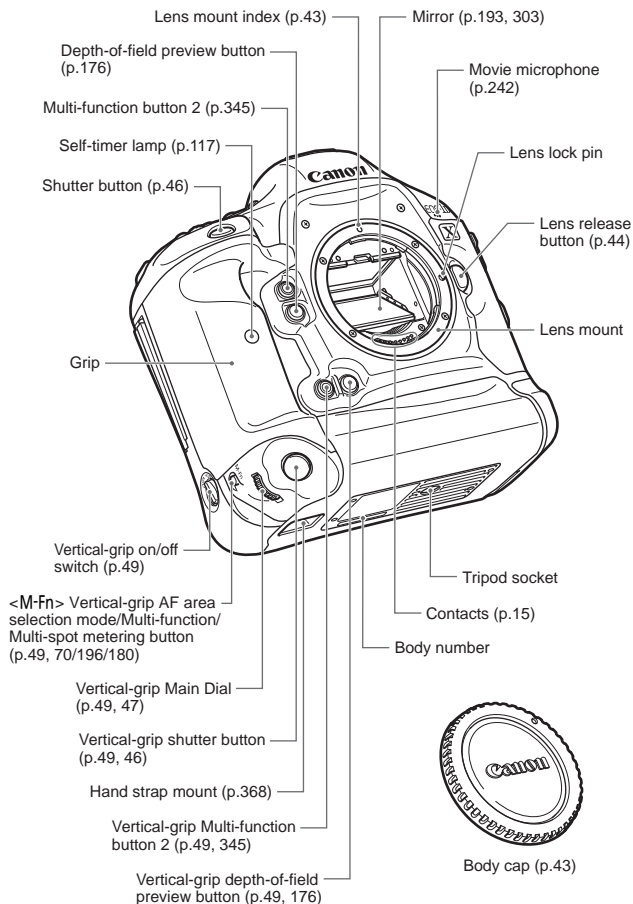

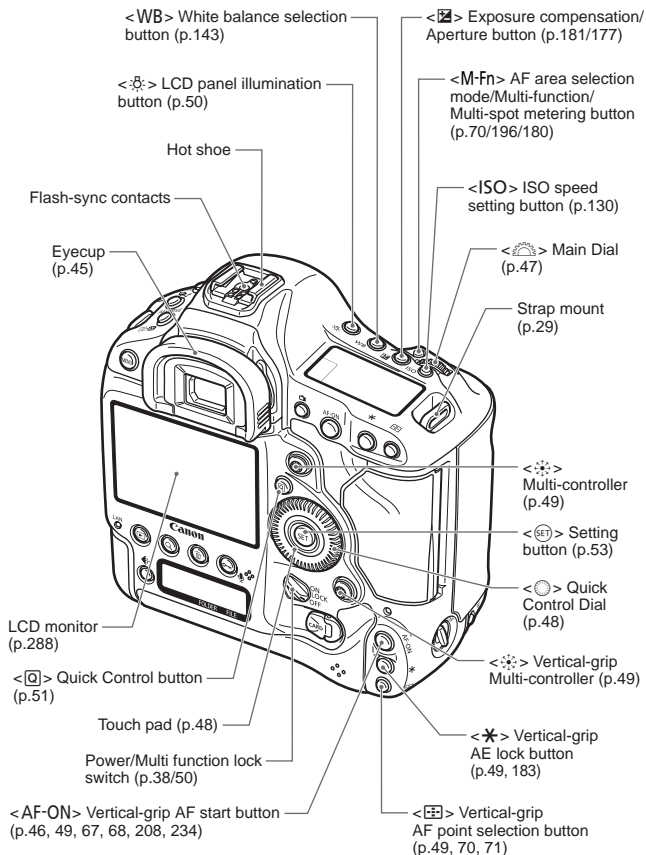

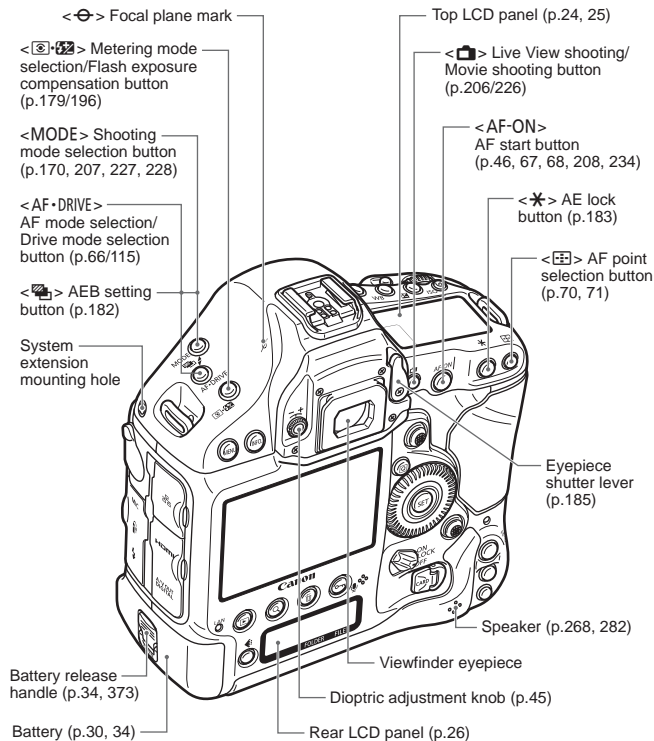

Battery compartment cap (p.34)

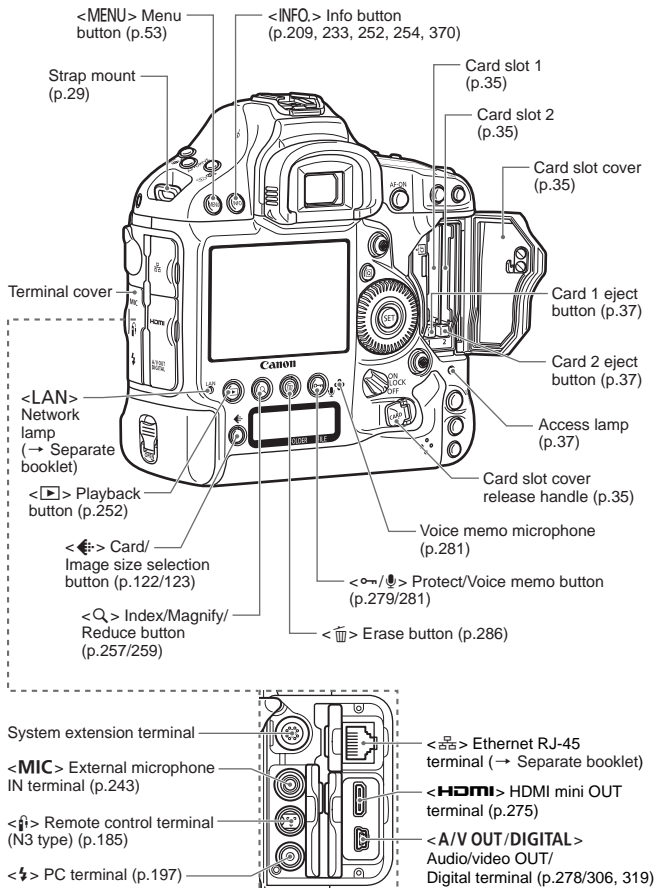

* Instructions for using the Cable Protector are on page 365.

Viewfinder Information

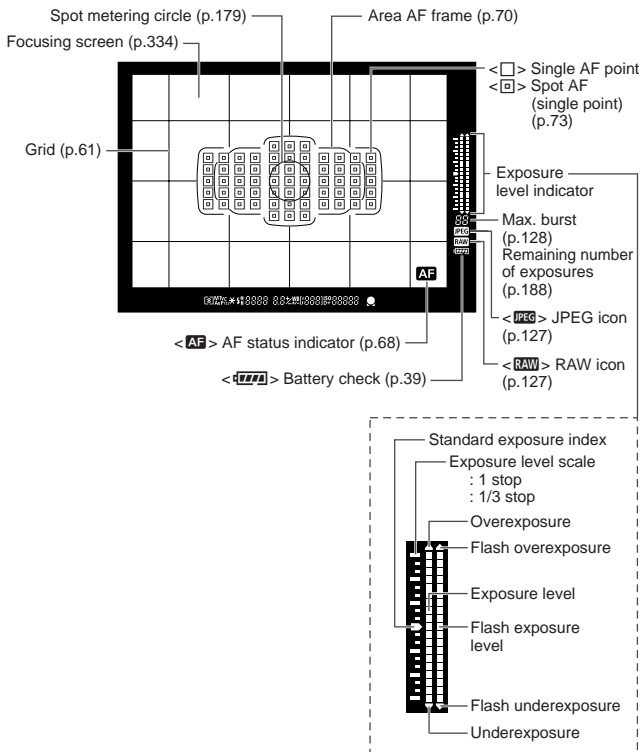

The display will show only the settings currently applied.

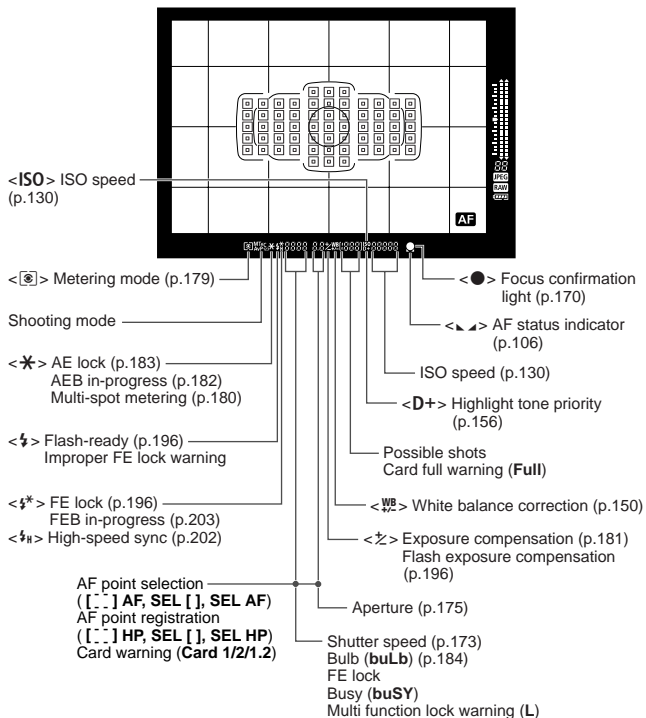

Top LCD Panel

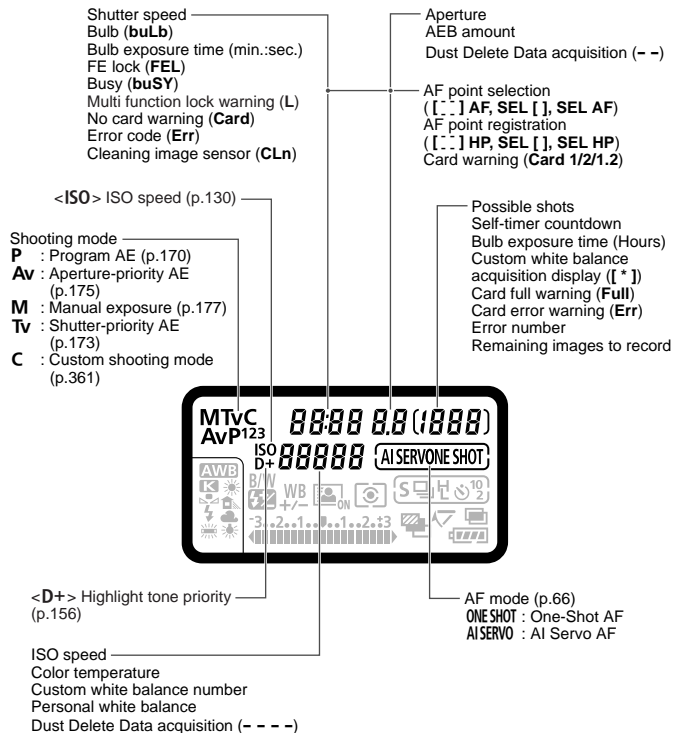

The display will show only the settings currently applied.

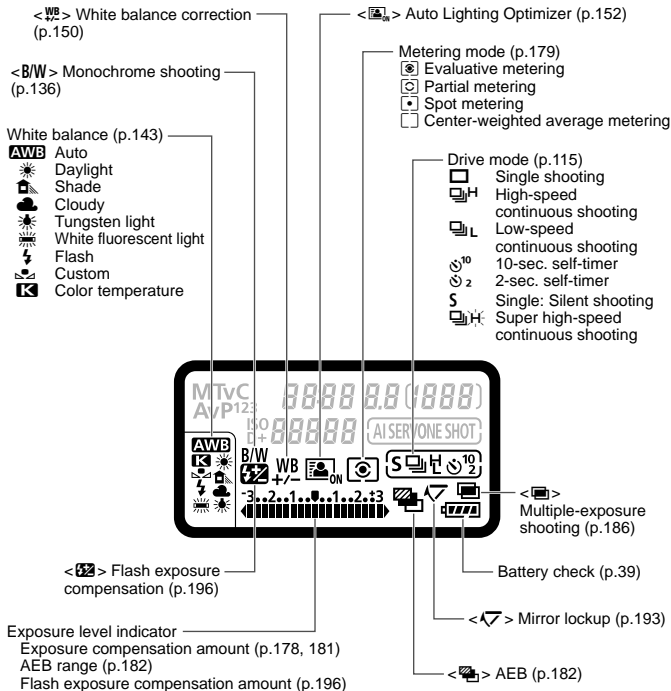

Rear LCD panel

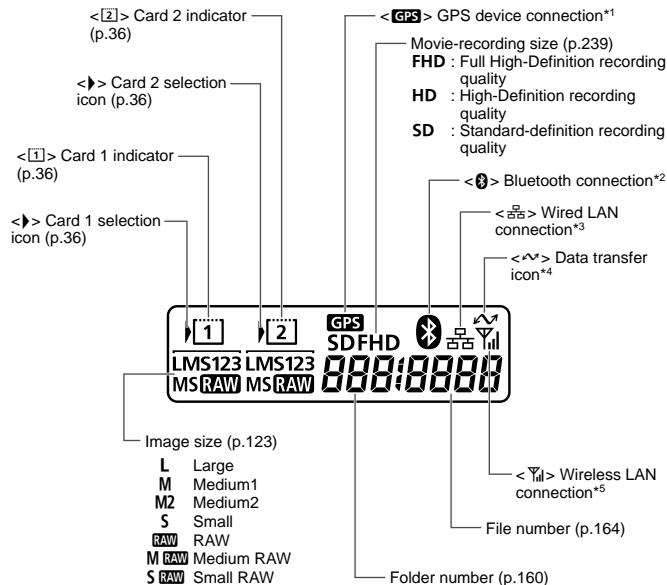

*1 : Displayed when GPS Receiver GP-E1/GP-E2 is attached to the camera or when a commercially-available Bluetooth GPS device is attached to Wireless File Transmitter WFT-E6.

*2 : Displayed when a commercially-available Bluetooth GPS device is attached to Wireless File Transmitter WFT-E6.

*3 : Displayed when the camera is connected to a wired LAN.

*4 : Displayed when the camera is connected to a personal computer or PictBridge printer.

*5 : Displayed when the camera is connected to a wireless LAN via Wireless File Transmitter WFT-E6.

The display will show only the settings currently applied.

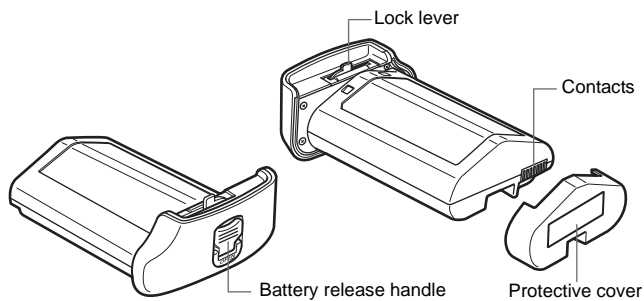
Battery Pack LP-E4N

Battery Charger LC-E4N

Charger for Battery Pack LP-E4N (p.30).

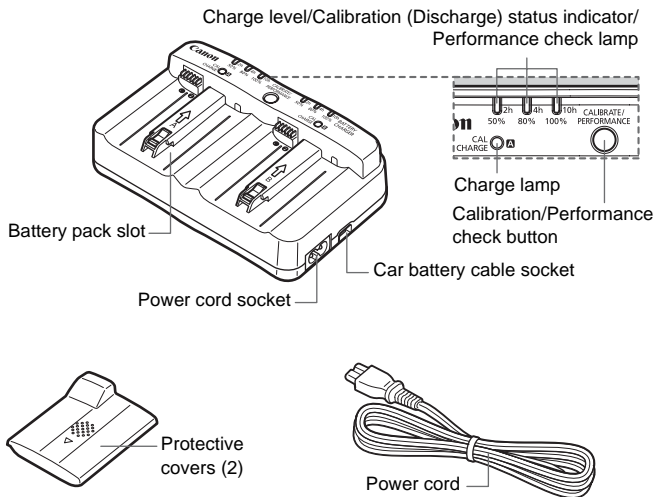

 The charger can also recharge the Battery Pack LP-E4.

1

Getting Started

This chapter explains preparatory steps before you start shooting and basic camera operations.

Attaching the Strap

Pass the end of the strap through the camera's strap mount eyelet from the bottom. Then pass it through the strap's buckle as shown in the illustration. Pull the strap to take up any slack and make sure the strap will not loosen from the buckle.

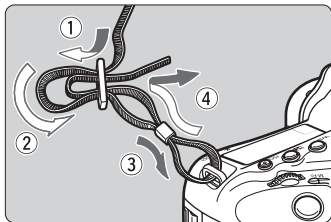

Charging the Battery

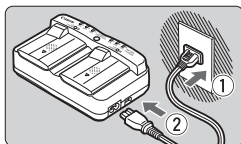

1 Connect the charger to a power outlet.

- Connect the power plug to a power outlet, and connect the power cord to the charger.
- When no battery is attached, all the indicator lamps will be off.

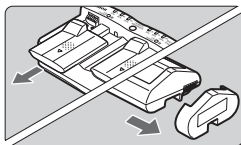

2 Remove the protective covers.

- As shown in the illustration, detach the charger's protective cover (provided) and the battery's protective cover (provided).

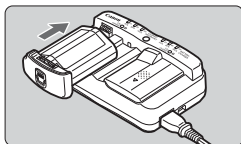

3 Recharge the battery.

- Slide the battery into the charger's slot as shown by the arrow, and make sure it is securely attached.
- You can attach the battery to slot A or B.
 - ▶ The battery will start recharging and the green status lamp will blink.
 - ▶ When the battery is fully charged, all three Charge level indicators will light up (50%/80%/100%).

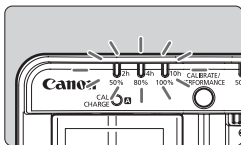

- It takes approx. 130 min. for LP-E4N and approx. 120 min. for LP-E4 to fully recharge a completely exhausted battery at 23°C/73°F.
- The time required to recharge the battery will vary greatly depending on the ambient temperature and the battery's remaining capacity.

- The LC-E4N charger cannot charge any battery other than the Battery Pack LP-E4N/LP-E4.
- Depending on the battery's condition, charge may not reach 100%.



Tips for Using the Battery and Charger

- **Upon purchase, the battery is not fully charged.**
Recharge the battery before using.
- **Recharge the battery on the day before or on the day it is to be used.**
Even during storage, a charged battery will gradually drain and lose its capacity.
- **After recharging the battery, detach it and disconnect the charger from the power outlet.**
When not using the battery and charger, attach the protective covers provided.
- **Use the battery in an ambient temperature range of 0°C - 45°C / 32°F - 113°F.**
To attain best battery performance, an ambient temperature of 10°C - 30°C / 50°F - 86°F is recommended. In cold locations such as snowy areas, battery performance and operation time may temporarily decrease.
- **When not using the camera, remove the battery.**
If the battery is left in the camera for a prolonged period, a small amount of power current is released, resulting in excess discharge and shorter battery life. Store the battery with the protective cover attached. Storing the battery when it is fully charged may lower the battery's performance.
- **The battery charger can also be used in foreign countries.**
The battery charger is compatible with a 100 V AC to 240 V AC 50/60 Hz power source. If necessary, attach a commercially-available plug adapter for the respective country or region. Do not attach any portable voltage transformer to the battery charger. Doing so can damage the battery charger.
- **Check the battery performance.**
While the battery is recharging, press the charger's <PERFORMANCE> button to check the battery's performance level indicated by the Charge level indicator.
 - ■ ■ (Green) : Battery's recharge performance is fine.
 - ■ □ (Green) : Battery's recharge performance is slightly degraded.
 - □ □ (Red) : Purchasing a new battery is recommended.
- **If the battery becomes exhausted quickly even after being fully charged, the battery has reached the end of its service life.**
Check the battery's recharge performance (p.372) and purchase a new battery.



Use a Car's Cigarette Lighter Socket to Recharge the Battery

With Car Battery Cable CB-570 (sold separately), you can connect the charger's car battery cable socket (<DC IN> terminal) to your car's cigarette lighter socket.

- When recharging the battery this way, be sure that the car's engine is running. Disconnect the car battery cable from the cigarette lighter socket when the car engine is off. If you leave the car battery cable connected to the cigarette lighter socket, it may drain the car battery.
- Do not use a transformer for the car with the battery charger.
- Battery charging from a car battery is possible only with a 12 V DC or 24 V DC car battery in a minus-grounded car. The shape or dimensions of the cigarette lighter socket in certain cars might not be compatible with the car battery cable.



The <CAL/CHARGE> Lamp Blinks in Red

- This indicates that you should calibrate the battery so that the correct battery level is detected and the camera's battery level indicator can display the correct battery level. Calibration is not a required operation. If you just want to recharge the battery, you can let the battery start recharging automatically after approx. 10 sec. If you want to perform calibration, press the <CALIBRATE> button while the <CAL/CHARGE> lamp is blinking in red. The Charge level indicator will blink in red and calibration (power discharge) will start.
- After calibration is complete, the battery will start recharging automatically. Note that the less depleted the battery is the longer calibration will take. The <2h>, <4h>, and <10h> figures on the side of the Charge level indicator indicate the approximate time it will take to complete calibration (power discharge). If the <10h> indicator blinks in red, it will take approx. 10 hours.
- After calibration is complete and the battery is totally drained, it will take a further 2 hours to recharge the battery fully. If you want to stop calibration before it is completed and start recharging the battery, remove the battery from the charger and attach it again.

**None of the Charger's Status Lamps Light Up**

- If the <CAL/CHARGE> lamp lights up but none of the status lamps do, the battery's internal temperature is outside the required 0°C - 40°C / 32°F - 104°F temperature range. The battery will start recharging when the internal temperature is within 0°C - 40°C / 32°F - 104°F.

**All Three Charge Level Indicators Blink**

- If any of the following occurs, remove the battery from the charger and consult your dealer or nearest Canon Service Center: All the Charge level lamps blink in green, all the Calibration (Discharge) status indicator lamps blink in red, or the indicators blink alternately in red and green (including the <CAL/CHARGE> lamp).
- Also, if a battery other than the Battery Pack LP-E4N/LP-E4 is attached to the charger, the indicators will blink in red and green (including the <CAL/CHARGE> lamp) and the battery cannot be recharged.



The charger cannot charge any battery other than the Battery Pack LP-E4N/LP-E4.



- When two battery packs are attached to the charger, the battery attached first will be charged first, then the other battery will be charged. Although one battery can be recharged and another calibrated at the same time, two batteries cannot be recharged or calibrated at the same time.
- It is best to perform battery calibration when the battery is nearly exhausted. If you try to calibrate the battery while it is fully charged, it can take as long as approx. 15 hours to calibrate and then fully charge the battery.

Installing and Removing the Battery

Load a fully charged Battery Pack LP-E4N/LP-E4 into the camera. The camera's viewfinder becomes bright when a battery is installed, and darkens when the battery is removed.

Installing the Battery

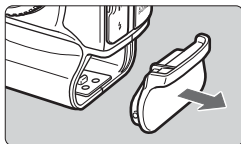

- 1 Remove the battery compartment cap.

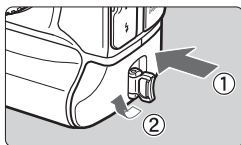

- 2 Insert the battery.
 - Insert the battery firmly all the way, and turn the release handle as shown by the arrow.

Removing the Battery

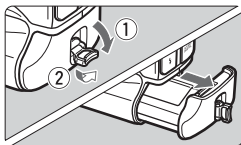

Turn the battery release handle and take out the battery.

- Check if the power switch is set to <OFF> (p.38).
- Flip out the battery release handle, turn it as shown by the arrow, and pull.
- To prevent short circuiting of the battery contacts, be sure to attach the protective cover (provided, p.27) to the battery.
- When not using the camera, attach the battery compartment cap (p.20).

ⓘ Only the Battery Pack LP-E4N/LP-E4 can be used.

🧼 If the battery's rubber lining (to repel water) is dirty, use a moist cotton swab to wipe it clean.

Rubber lining



Installing and Removing the Card

You can insert up to two cards. **Images can be recorded when at least one card is installed in either slot in the camera.**

If you insert two cards, you can select which card to record images to or record images simultaneously on both cards (p.120, 122).

Installing the Card

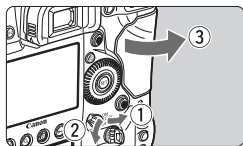

1 Open the cover.

- Flip out and turn the cover release handle, and open the cover as shown by the arrows.

Card 1

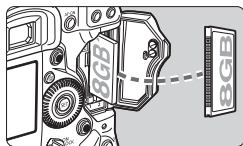

2 Insert the card.

- The card inserted in the left slot will be [1], and the card inserted in the right slot will be [2].
- **As shown by the illustration, face the label side toward you and insert the end with the small holes into the camera.**

Card 2

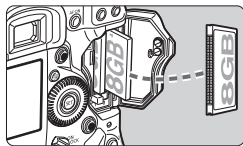

If the card is inserted in the wrong way, it may damage the camera.

- ▶ The card ejection button will stick out.

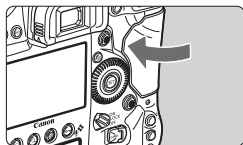

3 Close the cover.

- Press the cover until it snaps shut.

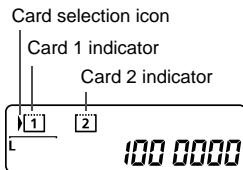
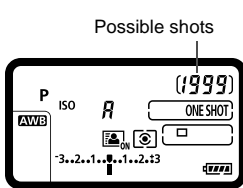

4 Set the power switch to <ON> (p.38).

- ▶ The number of possible shots will be displayed on the top LCD panel and in the viewfinder.
- ▶ The rear LCD panel will indicate which card(s) has been inserted.

The images will be recorded to the card with the <▶> icon next to the respective card's indicator.

 Hard disk-type cards cannot be used with this camera.

- Although the two types of CF (CompactFlash) cards have different thicknesses, either type can be inserted into the camera.
- Ultra DMA (UDMA) CF cards can also be used with the camera. UDMA CF cards enable faster data writing.
- The number of possible shots depends on the remaining capacity of the card, image-recording quality, ISO speed, etc.
- Setting [ 3: Release shutter without card] to [Disable] will prevent you from forgetting to insert a card (p.376).

Removing the Card

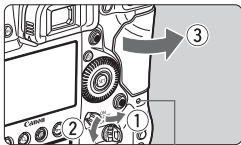

Access lamp

1 Open the cover.

- Set the power switch to <OFF>.
- **Make sure the access lamp is off, then open the cover.**
- If [Recording...] is displayed, close the cover.

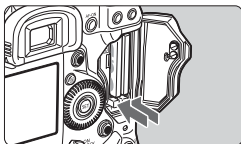

2 Remove the card.

- Push the eject button to eject the card.
- Pull the card straight out, then close the cover.



- **When the access lamp is lit or blinking, it indicates that images are being written to or read by the card, being erased, or data is being transferred. Do not open the card slot cover during this time. Also, never do any of the following while the access lamp is lit or blinking. Otherwise, it can damage the image data, card, or camera.**
 - Removing the card.
 - Removing the battery.
 - Shaking or banging the camera around.
- If the card already contains recorded images, the image number may not start from 0001 (p.164).
- If a card-related error message is displayed on the LCD monitor, remove and reinsert the card. If the error persists, use a different card. If you can transfer all the images on the card to a computer, transfer all the images and then format the card with the camera (p.55). The card may then return to normal.

Turning on the Power

If you turn on the power switch and the Date/Time/Zone setting screen appears, see page 40 to set the Date/Time/Zone.

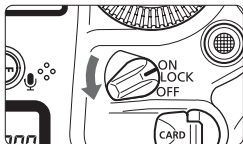

- <ON> : The camera turns on.
- <LOCK>: The camera turns on. The Multi-function lock will take effect (p.50).
- <OFF> : The camera is turned off and does not operate. Set to this position when not using the camera.

About the Automatic Self-Cleaning Sensor

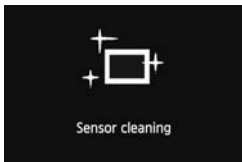

- Whenever you set the power switch to <ON/LOCK> or <OFF>, sensor cleaning will be executed automatically. (A small sound may be heard.) During the sensor cleaning, the LCD monitor will display <[Sensor Cleaning Icon]>.
- You can still shoot during sensor cleaning by pressing the shutter button halfway (p.46) to stop the sensor cleaning and take a picture.
- If you repeatedly turn the power switch <ON/LOCK>/<OFF> at a short interval, the <[Sensor Cleaning Icon]> icon may not be displayed. This is normal and not a problem.

MENU About Auto Power Off







- To save battery power, the camera turns off automatically after 1 minute of non-operation. To turn on the camera again, just press the shutter button halfway (p.46).
- You can change the auto power-off time with [**F2: Auto power off**] (p.57).

 If you set the power switch to <OFF> while an image is being recorded to the card, [**Recording...**] will be displayed and the power will turn off after the card finishes recording the image.

Checking the Battery Level

When the power switch is set to <ON>, the battery level will be indicated in one of six levels.



Icon	Level (%)	Indication
	100 - 70	Sufficient battery level
	69 - 50	Battery level exceeds 50%
	49 - 20	Battery level below 50%
	19 - 10	Battery level is low
	9 - 1	Battery will be exhausted soon
	0	Recharge the battery

Battery Life

[Approx. number of shots]

Temperature	At 23°C / 73°F	At 0°C / 32°F
Possible shots	1120	860

- The figures above are based on a fully-charged Battery Pack LP-E4N, no Live View shooting, and CIPA (Camera & Imaging Products Association) testing standards.



- The number of possible shots will decrease with any of the following operations:
 - Pressing the shutter button halfway for a prolonged period.
 - Activating the AF frequently without taking a picture.
 - Using the lens Image Stabilizer.
 - Using the LCD monitor often.
- The number of possible shots may decrease depending on the actual shooting conditions.
- The lens operation is powered by the camera's battery. Depending on the lens used, the number of possible shots may be lower.
- Regarding the number of possible shots with Live View shooting, see page 208.
- See [**f 3: Battery info.**] to check the battery's condition in detail (p.372).

MENU Setting the Date, Time, and Zone

When you turn on the power for the first time or if the date/time has been reset, the Date/Time/Zone setting screen will appear. Follow steps 3 to 6 to set the current date, time, and time zone.

Note that the date/time appended to recorded images will be based on this date/time setting. Be sure to set the correct date/time.

You can also set the time zone of your current address. Then if you travel to another time zone, you can simply set your destination's time zone so that the correct date/time is recorded.



1 Display the menu screen.

- Press the <MENU> button to display the menu screen.

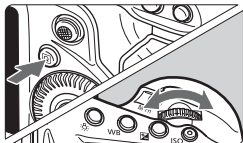

2 Under the [🕒] tab, select [Date/Time/Zone].

- Press the <Q> button and select the [🕒] tab.
- Turn the <🕒> dial to select the [🕒] tab.
- Turn the <🕒> dial to select [Date/Time/Zone], then press <SET>.

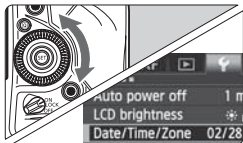

3 Set the time zone.

- [London] is set by default.
- Turn the <🕒> dial to select [Time zone].
- Press <SET> so <📍> is displayed.
- Turn the <🕒> dial to select the time zone, then press <SET>.

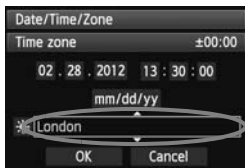

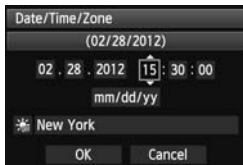

4 Set the date and time.

- Turn the <⊙> dial to select the number.
- Press <SET> so <⊙> is displayed.
- Turn the <⊙> dial to select the desired setting, then press <SET> (Returns to <□>).

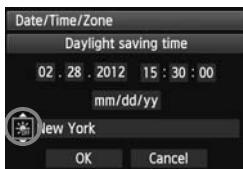

5 Set the daylight saving time.

- Set it if necessary.
- Turn the <⊙> dial to select [☀].
- Press <SET> so <⊙> is displayed.
- Turn the <⊙> dial to select [☀], then press <SET>.
- When the daylight saving time is set to [☀], the time set in step 4 will advance by 1 hour. If [☀] is set, the daylight saving time will be canceled and the time will go back by 1 hour.

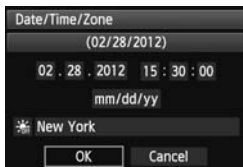

6 Exit the setting.

- Turn the <⊙> dial to select [OK], then press <SET>.
- ▶ The Date/Time/Zone will be set and the menu will reappear.



- The menu setting procedure is explained on pages 53-54.
- The date/time that was set will start from when you press <SET> in step 6.
- In step 3, the time displayed on the upper right is the time difference compared with Coordinated Universal Time (UTC). If you do not see your time zone, set the time zone while referring to the difference with UTC.
- To sync the time between two cameras with [Sync time between cameras] (Multi Camera Time Sync Function), use the [Communication settings] menu. For details, refer to the separate Wired LAN Instruction Manual.

MENU Selecting the Interface Language



1 Display the menu screen.

- Press the <MENU> button to display the menu screen.

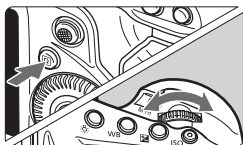

2 Under the [F2] tab, select [Language].

- Press the <Q> button and select the [F2] tab.
- Turn the <G> dial to select the [F2] tab.
- Turn the <DIAL> dial to select [Language] (the fourth item from the top), then press <SET>.

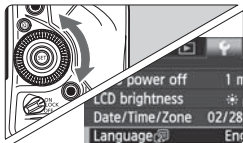

3 Set the desired language.

- Turn the <DIAL> dial to select the language, then press <SET>.
- ▶ The interface language will change.

English	Norsk	Română
Deutsch	Svenska	Türkçe
Français	Español	العربية
Nederlands	Ελληνικά	ελληνικά
Dansk	Русский	简体中文
Português	Polski	繁體中文
Suomi	Čeština	한국어
Italiano	Magyar	日本語
Українська		

Attaching and Detaching a Lens

The camera is compatible with all Canon EF lenses. **The camera cannot be used with EF-S or EF-M lenses.**

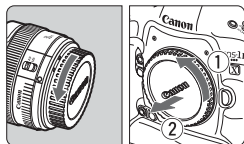

1 Remove the caps.

- Remove the rear lens cap and the body cap by turning them as shown by the arrows.

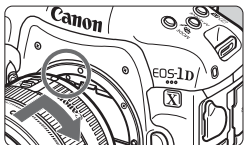

2 Attach the lens.

- Align the red dots on the lens and camera and turn the lens as shown by the arrow until it clicks in place.

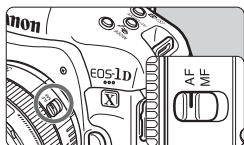

3 Set the lens focus mode switch to <AF>.

- <AF> stands for Autofocus.
- If it is set to <MF> (manual focus), autofocus will not operate.

4 Remove the front lens cap.

- Do not look at the sun directly through any lens. Doing so may cause loss of vision.
- If the front part (focusing ring) of the lens rotates during autofocus, do not touch the rotating part.

Minimizing Dust

- When changing lenses, do it quickly in a place with minimal dust.
- When storing the camera without a lens attached, be sure to attach the body cap to the camera.
- Remove dust on the body cap before attaching it.

Detaching the Lens

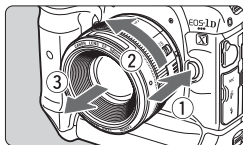

While pressing the lens release button, turn the lens as shown by the arrow.

- Turn the lens until it stops, then detach it.
- Attach the rear lens cap to the detached lens.

Basic Operation

Adjusting the Viewfinder Clarity

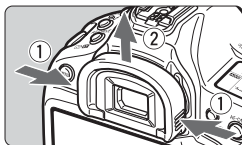

1 Remove the eyecup.

- While grasping both sides of the eyecup, slide it upward to remove.

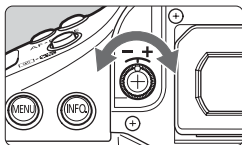

2 Make the adjustment.

- Turn the knob left or right so that the AF points in the viewfinder look sharp.
- Attach the eyecup.



If the camera's dioptic adjustment still cannot provide a sharp viewfinder image, using Eg-series Dioptic Adjustment Lenses (sold separately) is recommended.

Holding the Camera

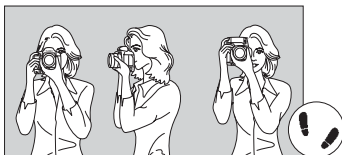

Horizontal shooting Vertical shooting

To obtain sharp images, hold the camera still to minimize camera shake.

1. Wrap your right hand around the camera grip firmly.
2. Hold the lens bottom with your left hand.
3. Rest your hand's right index finger lightly on the shutter button.
4. Press your arms and elbows lightly against the front of your body.
5. To maintain a stable stance, place one foot slightly ahead of the other.
6. Press the camera against your face and look through the viewfinder.



To shoot while looking at the LCD monitor, see page 205.

Shutter Button

The shutter button has two steps. You can press the shutter button halfway. Then you can further press the shutter button completely.

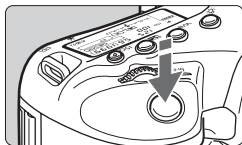

Pressing halfway

This activates autofocus and the automatic exposure system that sets the shutter speed and aperture.

The exposure setting (shutter speed and aperture) is displayed in the viewfinder and on the top LCD panel (ⓘ6).

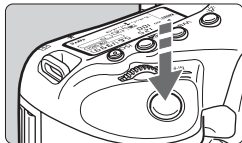

Pressing completely

This releases the shutter and takes the picture.

Preventing Camera Shake

Hand-held camera movement during the moment of exposure is called camera shake. It can cause blurred pictures. To prevent camera shake, note the following:

- Hold and steady the camera as shown on the preceding page.
- Press the shutter button halfway to autofocus, then slowly press the shutter button completely.



- Pressing the <AF-ON> button will execute the same operation as pressing the shutter button halfway.
- If you press the shutter button completely without pressing it halfway first or if you press the shutter button halfway and then press it completely immediately, the camera will take a moment before it takes the picture.
- Even during menu display, image playback, or image recording, you can instantly go back to shooting-ready by pressing the shutter button halfway.



Main Dial

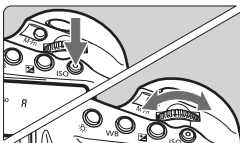

- (1) **After pressing a button, turn the <Main Dial> dial.**

When you press a button such as <MODE>, <AF•DRIVE>, <ISO>, or <ISO>, the respective function remains selected for 6 seconds (6). During this time, you can turn the <Main Dial> dial to set the desired setting.

When the function selection timer ends, or if you press the shutter button halfway, the camera will be ready to shoot.

- Use this dial to select or set the shooting mode, AF mode, metering mode, AF point, ISO speed, exposure compensation (when the <ISO> button is pressed), card, etc.

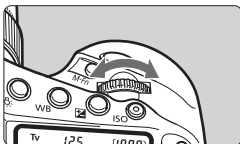

- (2) **Turn the <Main Dial> dial only.**

While looking at the viewfinder or top LCD panel, turn the <Main Dial> dial to set the desired setting.

- Use this dial to set the shutter speed, aperture, etc.





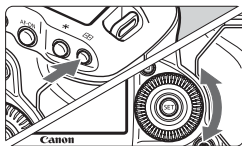

The operations in (1) are possible even when the power switch is set to <LOCK> (Multi function lock, p.50).

Quick Control Dial



(1) After pressing a button, turn the < > dial.

When you press a button such as <MODE>, <AF·DRIVE>, <·>, or <ISO>, the respective function remains selected for 6 seconds (). During this time, you can turn the <  > dial to set the desired setting.

When the function selection timer ends or if you press the shutter button halfway, the camera will be ready to shoot.

- Use this dial to select or set the shooting mode, drive mode, flash exposure compensation, AF point, ISO speed, exposure compensation (when the <> button is pressed), white balance, image size, etc.

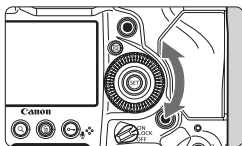



(2) Turn the < > dial only.

While looking at the viewfinder or top LCD panel, turn the <  > dial to set the desired setting.

- Use this dial to set the exposure compensation amount, the aperture setting for manual exposures, etc.

 The operations in (1) are possible even when the power switch is set to <LOCK> (Multi function lock, p.50).

Touch Pad

During movie shooting, the touch pad provides a quiet way to adjust the shutter speed, aperture, ISO speed, exposure compensation, and sound recording level (p.244). This function takes effect when [5: **Silent Control**] is set to [**Enable** ].

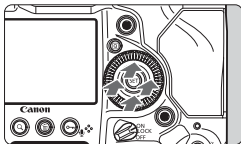

After pressing the **<Q>** button, tap the **<AF-ON>** dial's inner ring at the top, bottom, left, or right.

Multi-controller

The **<Multi-controller>** consists of an eight-direction key and a button at the center.

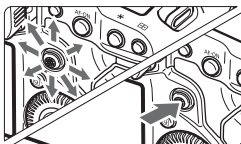

- Use it to select the AF point, correct the white balance, move the AF point or magnifying frame during Live View shooting, scroll around magnified images during playback, operate the Quick Control screen, etc.
- You can also use it to select or set menu options (except [**1: Erase images**] and [**1: Format card**]).
- For menus and the Quick Control screen, the Multi-controller works only in the vertical and horizontal directions. It does not work in diagonal directions.

Vertical Shooting

The camera bottom has vertical-grip buttons and a dial (p.18, 19).

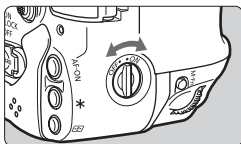

- Before using the vertical grip's buttons and dial, set the vertical-grip ON/OFF switch to **<ON>**.
- When not using the vertical shooting controls, set the switch to **<OFF>** to prevent accidental operation.

 The vertical grip's Multi-function button 2 and depth-of-field preview button (p.18) will function even when the Vertical-grip ON/OFF switch is set to **<OFF>**.

LOCK : Multi function lock

With [**5: Multi function lock**] set (p.337) and the power switch set to <LOCK>, you can prevent the current settings from changing due to accidental movement of the Main Dial, Quick Control Dial, or Multi-controller.

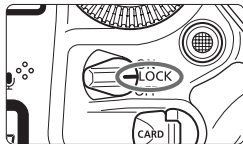

If the power switch is set to <LOCK> and you try to use one of the locked camera controls, <L> will be displayed in the viewfinder and on the top LCD panel. [LOCK] will also be displayed on the shooting functions' setting screen.

LCD Panel Illumination

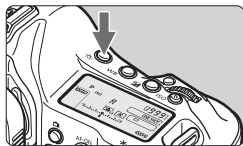

Press the <☀> button to turn the top and rear LCD panel illumination on (☀6) or off. During a bulb exposure, pressing the shutter button completely will turn off the LCD panel illumination.

Displaying Shooting Settings



If you press the <INFO.> button a number of times, the shooting settings will be displayed.

Pressing the <Q> button enables Quick Control of the shooting settings (p.51). Press the <INFO.> button again to turn off the display.

Q Quick Control for Shooting Functions

You can directly select and set the shooting functions displayed on the LCD monitor. This is called the Quick Control screen.

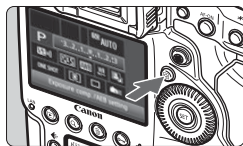

1 Press the <Q> button.

- ▶ The Quick Control screen will appear (10).

2 Set the desired function.

- Use <⊕> to select a function.
- ▶ The setting of the selected function is displayed at the bottom.
- ▶ Turn the <⊙> or <☀> dial to change the setting.



3 Take the picture.

- Press the shutter button completely to take the picture.
- ▶ The captured image will be displayed.

Function Setting Screen



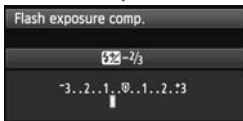

↓ <SET>

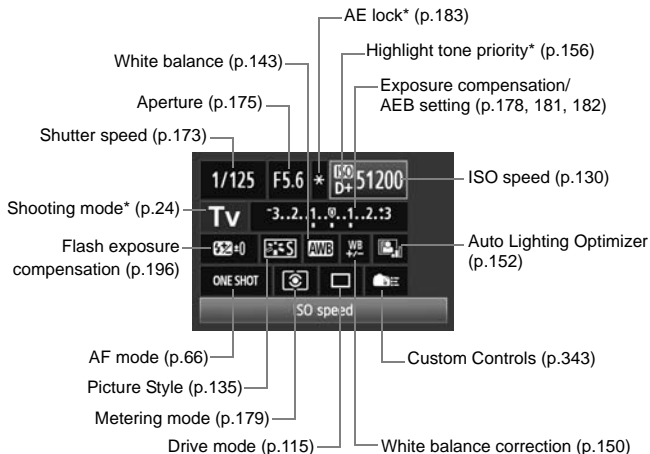

- Select the desired function and press <SET>. The function's setting screen will appear.
- Turn the <⊙> or <☀> dial to change the setting. There are also functions that are set by pressing the <INFO.> button.
- Press <SET> to finalize the setting and return to the Quick Control screen.
- When you select <CUSTOM> (Custom Controls, p.343) and press the <MENU> button, the shooting settings display will reappear.

Settable Functions on Quick Control Screen



 Asterisked functions cannot be set with the Quick Control screen.

MENU Menu Operations

You can set various settings with the menus such as the beeper, date/time, etc. While looking at the LCD monitor, use the <MENU> and <Q> buttons on the back of the camera and the <Main Dial> and <Quick Control Dial> buttons on the back of the camera and the <SET> button.

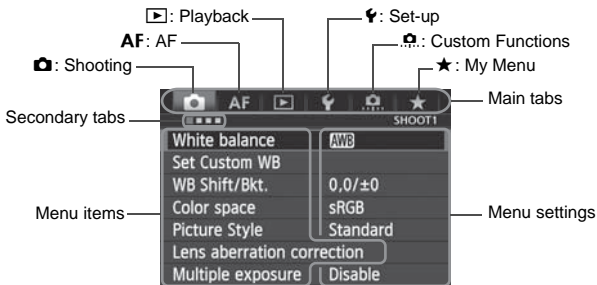
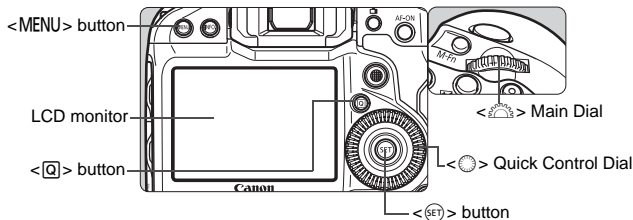

Menu Setting Procedure

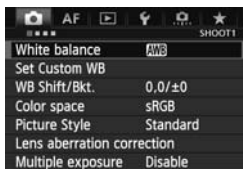

1 Display the menu screen.

- Press the <MENU> button to display the menu screen.

2 Select a tab.

- Each time you press the <Q> button, the main tab will switch.
- Turn the <DIAL> dial to select a secondary tab.
- For example, the [CAMERA 4] tab refers to the screen displayed when the CAMERA (Shooting) tab's fourth dot ■ from the left is selected.

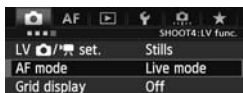

3 Select the desired item.

- Turn the <DIAL> dial to select the item, then press <SET>.

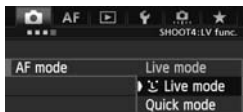

4 Select the setting.

- Turn the <DIAL> dial to select the desired setting.
- The current setting is indicated in blue.

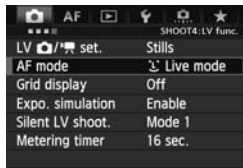

5 Set the desired setting.

- Press <SET> to set it.

6 Exit the setting.

- Press the <MENU> button to exit the menu and return to shooting-ready state.

- The explanation of menu functions hereinafter assumes that you have pressed the <MENU> button to display the menu screen.
- You can also use <INFO> to set menu functions. (Except [CAMERA 1: Erase images] and [CAMERA 1: Format card].)
- To cancel, press the <MENU> button.
- For details about each menu item, see page 375.

Before You Start

MENU Formatting the Card

If the card is new or was previously formatted by another camera or computer, format the card with the camera.

- !** When the card is formatted, all images and data in the card will be erased. As even protected images will be erased, make sure there is nothing you need to keep. If necessary, transfer the images to a personal computer, etc., before formatting the card.

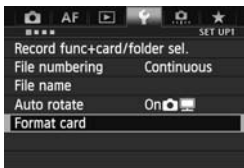

1 Select [Format card].

- Under the [**1**] tab, select [Format card], then press <[SET]>.

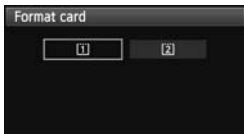

2 Select the card.

- [**1**] is Card 1, and [**2**] is Card 2.
- Turn the <[DIAL]> dial to select a card, then press <[SET]>.



3 Select [OK].

- Select [OK], then press <[SET]>.
- ▶ The card will be formatted.
- ▶ When the formatting is completed, the menu will reappear.



Format the card in the following cases:

- The card is new.
- The card was formatted by a different camera or a computer.
- The card is full with images or data.
- A card-related error is displayed (p.401).



- Cards with 128 GB or lower capacity will be formatted in FAT format. Cards with a capacity over 128 GB will be formatted in exFAT format. If you format a card with a capacity over 128 GB with this camera and then insert it into another camera, an error may be displayed and the card may become impossible to use. Depending on the personal computer's OS or card reader, it may not recognize a card formatted in exFAT format.
- When the card is formatted or data is erased, only the file management information is changed. The actual data is not completely erased. Be aware of this when selling or discarding the card. When discarding the card, destroy the card physically to prevent personal data from being leaked.



- The card capacity displayed on the card format screen may be smaller than the capacity indicated on the card.
- This device incorporates exFAT technology licensed from Microsoft.

MENU Setting the Power-off Time/Auto Power Off

To save battery power, the camera turns off automatically after a set time of idle operation elapses. If you do not want the camera to turn off automatically, set this to **[Disable]**. After the power turns off, you can turn on the camera again by pressing the shutter button or other buttons.

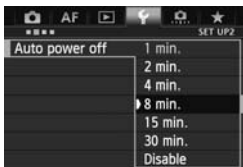

- 1 **Select [Auto power off].**
 - Under the [**2**] tab, select **[Auto power off]**, then press **<SET>**.
- 2 **Set the desired time.**
 - Select the desired setting, then press **<SET>**.



Even if **[Disable]** is set, the LCD monitor will turn off automatically after 30 min. to save power. (The camera's power does not turn off.)

MENU Setting the Image Review Time

You can set how long the image is displayed on the LCD monitor immediately after capture. To keep the image displayed, set **[Hold]**. To not have the image displayed, set **[Off]**.

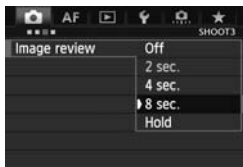

- 1 **Select [Image review].**
 - Under the [**3**] tab, select **[Image review]**, then press **<SET>**.
- 2 **Set the desired time.**
 - Select the desired setting, then press **<SET>**.



If **[Hold]** is set, the image will be displayed until the auto power off time elapses.

MENU Reverting the Camera to the Default Settings

The camera's shooting settings and menu settings can be reverted to their defaults.

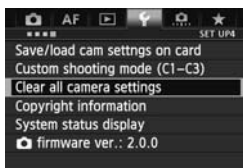

1 Select [Clear all camera settings].

- Under the [F4] tab, select [Clear all camera settings], then press <SET>.



2 Select [OK].

- Select [OK], then press <SET>.
- ▶ Setting [Clear all camera settings] will reset the camera to the following default settings:

Shooting Settings

Shooting mode	P (Program AE)
AF mode	One-Shot AF
AF area selection mode	Single-point AF (Manual selection)
AF point selection	Center
Registered AF point	Canceled
Metering mode	 (Evaluative metering)
ISO speed	Auto
ISO speed range	Minimum: 100 Maximum: 51200
Auto ISO range	Minimum: 100 Maximum: 25600
ISO Auto minimum shutter speed	Auto



Drive mode	 (Single shooting)
Exposure compensation	Canceled
AEB	Canceled
Flash exposure compensation	0 (Zero)
Multiple exposure	Disable
Mirror lockup	Disable
Custom Functions	Unchanged
Flash function settings	Unchanged

Image-recording Settings



Image type/size	L (Large)
JPEG quality	8
Picture Style	Standard
Auto Lighting Optimizer	Standard
Peripheral illumination correction	Enable/Correction data retained
Chromatic aberration correction	Enable/Correction data retained
White balance	AWB (Auto)
Custom WB data	Registered setting retained
Personal WB	Registered setting retained
White balance correction	Canceled
White balance bracketing	Canceled
Color space	sRGB
Long exposure noise reduction	Disable
High ISO speed noise reduction	Standard
Highlight tone priority	Disable
Record function	Standard
File numbering	Continuous
File name	Preset code
Auto cleaning	Enable
Dust Delete Data	Erase

AF Settings

Case 1 - 6	Case1/Parameter settings of all cases cleared
AI Servo 1st image priority	Equal priority
AI Servo 2nd image priority	Equal priority (0)
USM lens electronic MF	Enable after One-Shot AF
AF-assist beam firing	Enable
One-Shot AF release priority	Focus priority
Auto AF point selection: EOS iTR AF	Enable
Lens drive when AF impossible	Continue focus search
Selectable AF point	61 points
Select AF area selection mode	All modes selected
AF area selection method	M-Fn button
Orientation linked AF point	Same for both vertical/horizontal
Initial AF point,  AI Servo AF	Initial AF point selected when  is set
Manual AF point selection pattern	Stops at AF area edges
AF point display during focus	Selected (constant)
VF display illumination	Auto
AF status in viewfinder	Show in field of view
AF Microadjustment	Disable

* Default settings for Case 1-6 are shown on pages 86-89.

Camera Settings

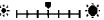
Auto power off	1 min.
Beep	Enable
Release shutter without card	Enable
Image review	2 sec.
Highlight alert	Disable
AF point display	Disable
Histogram display	Brightness
Playback grid	Off
Magnification (Approx.)	2x
Image jump with 	10 (10 images)
Auto rotate	On 
Movie playback count	Unchanged
LCD brightness	
Date/Time/Zone	Unchanged
Language	Unchanged
Video system	Unchanged
INFO button display options	All items selected
VF grid display	Disable
Communication settings	Unchanged
Custom shooting modes	Unchanged
Copyright information	Unchanged
Control over HDMI	Disable
System status display	Setting retained
My Menu settings	Unchanged
Display from My Menu	Disable

Live View Shooting Settings

LV  setting	Stills
AF mode	Live mode
Grid display	Off
Exposure simulation	Enable
Silent LV shooting	Mode 1
Metering timer	16 sec.

Movie Shooting Settings

LV  setting	Stills
AF mode	Live mode
Grid display	Off
Movie recording size	1920x1080/IPB
Sound recording	Auto
Silent LV shooting	Mode 1
Metering timer	16 sec.
Time code	
Count up	Unchanged
Start time setting	Unchanged
Movie recording count	Unchanged
Movie playback count	Unchanged
Drop Frame	Unchanged
Silent Control	Disable
Movie shooting button	M-Fn button

 For WFT and GPS settings, refer to the respective device's instruction manual.

Displaying the Grid and Electronic Level

You can display a grid and electronic level in the viewfinder and on the LCD monitor to help correct camera tilt.

Displaying the Grid in the Viewfinder

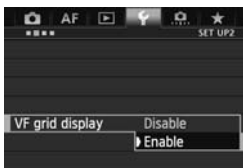

- 1 Select [VF grid display].**
 - Under the [**2**] tab, select [**VF grid display**], then press <SET>.
- 2 Select [Enable].**
 - Turn the <DIAL> dial to select [**Enable**], then press <SET>.
 - The grid will be displayed in the viewfinder.

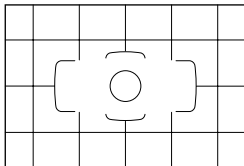

Displaying the Electronic Level in the Viewfinder

The viewfinder can display an electronic level using the AF points. For details, see Custom Controls (p.343).



A grid can also be displayed on the LCD monitor during Live View shooting and movie shooting (p.212, 247).

Displaying the Electronic Level on the LCD Monitor

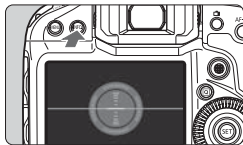

1 Press the <INFO.> button.

- Each time you press the <INFO.> button, the screen display will change.
- Display the electronic level.
- If the electronic level does not appear, set [**F2: INFO button display options**] so that the electronic level can be displayed (p.370).



2 Check the camera's tilt.

- The horizontal and vertical tilt are displayed in 1° increments.
- When the red line turns green, it indicates that the tilt is corrected.



Vertical level
Horizontal level



- Even when the tilt is corrected, there may be a margin of error of $\pm 1^\circ$.
- If the camera is very tilted, the electronic level's margin of error will be bigger.

 You can also use the procedure above to display the electronic level during Live View shooting and before shooting a movie (p.209, 233). Note that the electronic level cannot be displayed during movie shooting. (The electronic level will disappear when you start shooting a movie.)

? Feature Guide

When [INFO Help] is displayed at the bottom of the menu screen, the Feature guide, offering explanations of menu options, can be displayed. The Feature guide is displayed while you hold down the <INFO.> button. If it fills two or more screens, a scroll bar will appear on the right edge. To scroll, hold down the <INFO.> button and turn the <◁○> dial.

- Example: [AF1] tab [Case 2]

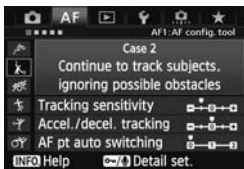

INFO.
→

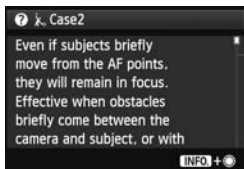

Scroll bar

- Example: [AF3] tab [AF-assist beam firing]

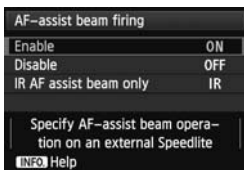

INFO.
→

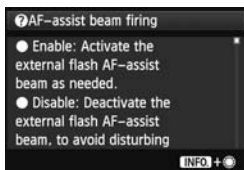

- Example: [◁.5] tab [Multi function lock]



INFO.
→

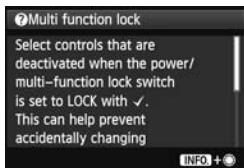

MEMO

2

Setting the AF and Drive Modes

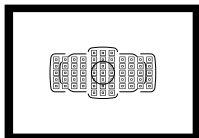

The 61 AF points in the viewfinder make AF shooting suitable for a wide variety of subjects and scenes.

You can also select the AF mode and drive mode that best match the shooting conditions and subject.



<AF> stands for autofocus. **<MF>** stands for manual focus.

AF: Selecting the AF Mode

You can select the AF mode to suit the shooting conditions or subject.

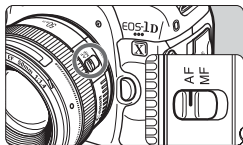

- 1 On the lens, set the focus mode switch to <AF>.

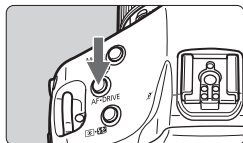

- 2 Press the <AF•DRIVE> button. (ⓘ6)

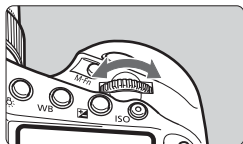

- 3 Select the AF mode.

- While looking at the top LCD panel, turn the <AF MODE> dial.

ONE SHOT : One-Shot AF

AI SERVO : AI Servo AF



 When the AF area selection mode is set to 61-point automatic selection AF (p.75) or Zone AF (p.74), AF is possible while using the subject's color and face detection information (p.97).

One-Shot AF for Still Subjects



AF point
Focus confirmation light

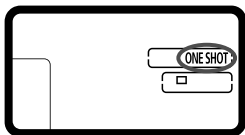

Suited for still subjects. When you press the shutter button halfway, the camera will focus only once.

- When focus is achieved, the AF point that achieved focus will be displayed, and the focus confirmation light <●> in the viewfinder will also light up.
- With evaluative metering, the exposure setting will be set at the same time focus is achieved.
- While you hold down the shutter button halfway, the focus will be locked. You can then recompose the shot if desired.
- AF is also possible by pressing the <AF-ON> button.



- If focus cannot be achieved, the focus confirmation light <●> in the viewfinder will blink. If this occurs, the picture cannot be taken even if the shutter button is pressed completely. Recompose the picture and try to focus again. Or see “When Autofocus Fails” (p.113).
- If [📷3: Beep] is set to [Disable], the beeper will not sound when focus is achieved.



Focus Lock

After achieving focus with One-Shot AF, you can lock the focus on a subject and recompose the shot. This is called “focus lock”. This is convenient when you want to focus a subject not covered by the Area AF frame.

AI Servo AF for Moving Subjects



This AF mode is suited for moving subjects when the focusing distance keeps changing. While you hold down the shutter button halfway, the subject will be focused continuously.

- The exposure is set at the moment the picture is taken.
- AF is also possible by pressing the <AF-ON> button.

Focus Tracking with AI Servo AF

If the subject approaches or moves away from the camera at a constant rate, the camera tracks the subject and predicts the focusing distance immediately before the picture is taken. This is for obtaining correct focus at the moment of exposure.

- When the AF area selection mode is set to 61-point automatic selection (p.69), the camera first uses the manually-selected AF point to focus. During autofocusing, if the subject moves away from the manually-selected AF point, focus tracking continues as long as the subject is covered by the Area AF frame.

 With AI Servo AF, the beeper will not sound even when focus is achieved. Also, the focus confirmation light <●> in the viewfinder will not light up.

AF Status Indicator



When you press the shutter button halfway and the camera is focusing with AF, the <AF> icon will appear on the lower right of the viewfinder.

In the One-Shot AF mode, the icon also appears after focus is achieved when you press the shutter button halfway.

 The AF status indicator can be displayed outside the viewfinder's image area (p.106).

Selecting the AF Area

61 AF points are provided for AF. You can select the AF point(s) suiting the scene or subject.

-  **Depending on the lens attached to the camera, the number of usable AF points and AF point patterns will differ. For details, see “Lenses and Usable AF Points” on page 77.**

AF Area Selection Mode

You can select one of six AF area selection modes. See the next page for the selection procedure.

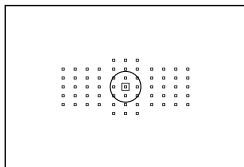

Single-point Spot AF (Manual selection)

For pinpoint focusing.

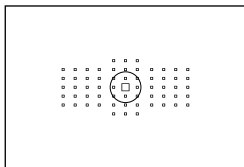

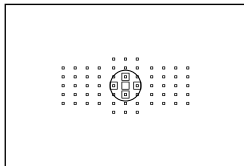

Single-point AF (Manual selection)

Select one AF point to focus.



AF point expansion (Manual selection)

The manually-selected AF point  and the surrounding AF points  (above, below, on the left and on the right) are used to focus.

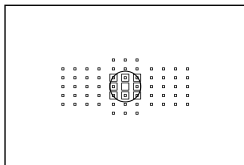

AF point expansion (Manual selection, surrounding points)

The manually-selected AF point <□> and the surrounding AF points <○> are used to focus.

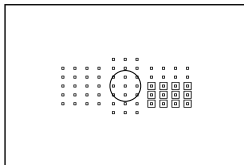

Zone AF (Manual selection of zone)

The 61 AF points are divided into nine zones for focusing.

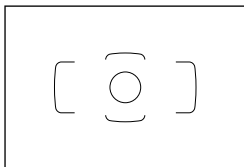

61-point automatic selection AF

All the AF points are used to focus.

Select the AF Area Selection Mode

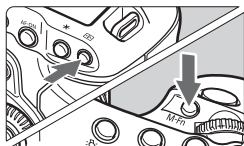

Select the AF area selection mode.

- Press the <☰> button.
- Look through the viewfinder and press the <M-Fn> button.
- ▶ Press the <M-Fn> button to switch the AF area selection mode.

- With [**AF4: Select AF area selec. mode**], you can limit the selectable AF area selection modes (p.100).
- If you set [**AF4: AF area selection method**] to [☰→Main Dial], you can select the AF area selection mode by pressing the <☰> button, then turning the <☺> dial (p.101).

Selecting the AF Point Manually

You can manually select the AF point or zone. When 61-point automatic selection AF and AI servo AF are set, you can set the starting AF point for AI Servo AF.

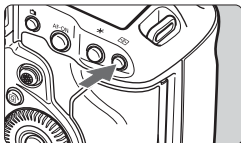





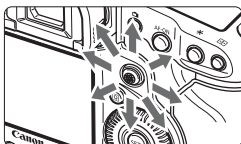

1 Press the button.

- ▶ The AF points will be displayed in the viewfinder.
- In AF point expansion modes, effective adjacent AF points will also be displayed.
- In the Zone AF mode, the selected zone will be displayed.



2 Select an AF point.

- The AF point selection will change in the direction you tilt the . If you press  straight down, the center AF point (or center Zone) will be selected.
- You can also select AF points in the vertical direction with  and in the horizontal direction with .
- In the Zone AF mode, turning the  or  dial will change the Zone in a looping sequence.

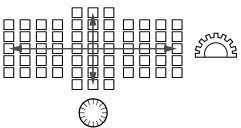

When you press the  button, the top LCD panel displays the following:



- 61-point automatic selection AF and Zone AF (manual selection of zone):
 AF
- Single-point Spot AF, Single-point AF, and AF point expansion:
SEL [] (Center)/SEL AF (Off-center)

AF Point Display Indications

Pressing the < > button lights up the AF points that are cross-type AF points for high-precision autofocusing. The blinking AF points are horizontal-line sensitive. For details, see page 76.

AI Servo AF starting position

When the AF area selection mode is set to 61-point automatic selection AF, you can manually select the AF point with which AI Servo AF is started (p.103).

If [**AF4: Initial AF pt.**,  **AI Servo AF**] is set to [**Manual**   **AF pt.**], the AF point which was selected before the AF area selection mode was switched to 61-point automatic selection can be used to start the AI Servo AF.

 With [**AF5: Manual AF pt. selec. pattern**], you can set either [**Stops at AF area edges**] or [**Continuous**] (p.104).

AF Area Selection Modes

Single-point Spot AF (Manual selection)

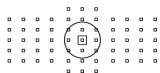

Although this is the same as Single-point AF (manual selection), the selected AF point <□> covers a smaller area to focus. Effective for pinpoint focusing of overlapping subjects such as an animal in a cage.

Since Single-point Spot AF (manual selection) covers a very small area, focusing may be difficult during hand-held shooting or for a moving subject.

Single-point AF (Manual selection)

Select one AF point <□> to be used for focusing.

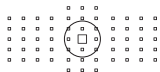

AF point expansion (Manual selection □□□)

The manually-selected AF point <□> and adjacent AF points <□> (above, below, on the left and on the right) are used to focus. Effective when it is difficult to track a moving subject with just one AF point.

With AI Servo AF, the manually-selected AF point <□> must focus-track the subject first. However, it is easier to focus the target subject than with Zone AF.

With One-Shot AF, when focus is achieved with an expanded AF point, the expanded AF point <□> will also be displayed along with the manually-selected AF point <□>.



AF point expansion (Manual selection, surrounding points)

The manually-selected AF point <□> and adjacent AF points <◁> are used to focus. The AF point expansion is larger than with AF point expansion (manual selection ◻◻◻), so the focusing is executed over a wider area. Effective when it is difficult to track a moving subject with just one AF point.

AI Servo AF and One-Shot AF work in the same way as with AF point expansion (manual selection ◻◻◻) mode (p.73).



Zone AF (Manual selection of zone)

The 61 AF points are divided into nine zones for focusing. All the AF points in the selected zone are used to automatically select the point of focus. It makes achieving focus easier than with Single-point AF or AF point expansion and it is effective for moving subjects.

However, since it is inclined to focus the nearest subject, focusing a specific target is harder than with Single-point AF or AF point expansion.

The AF point(s) achieving focus is displayed as <□>.



61-point automatic selection AF

All the AF points are used to focus.

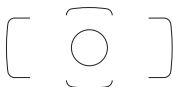

With One-Shot AF, pressing the shutter button halfway will display the AF point(s) $\langle \square \rangle$ that achieved focus. If multiple AF points are displayed, it means they all have achieved focus. This mode tends to focus the nearest subject.

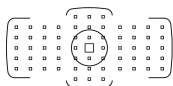

With AI Servo AF, the manually-selected (p.71) AF point $\langle \square \rangle$ is used first to achieve focus. The AF point(s) achieving focus is displayed as $\langle \square \rangle$.

- With 61-point automatic selection AF or Zone AF, the active AF point $\langle \square \rangle$ will keep switching to track the subject in AI Servo AF mode. However, under certain shooting conditions (such as when the subject is small), it may not be able to track the subject. Also, in low temperatures, the tracking response is slower.
- With Single-point Spot AF, focusing with the Speedlite's AF-assist beam may be difficult.
- If you are using a peripheral AF point or a wide-angle lens, achieving focus with the EOS-dedicated Speedlite's AF-assist beam may be difficult. In such a case, select an AF point close to the center.
- When the AF point(s) lights up, part or all of the viewfinder may light up in red. This is a characteristic of AF point display (using liquid crystal).
- In low temperatures, the AF point's blinking (p.72) may be difficult to see. This is a characteristic of AF point display (using liquid crystal).

- With [**AF4: Orientation linked AF point**], you can set the AF area selection mode + AF point (or only the AF point) separately for the horizontal and vertical orientations (p.101).
- With [**AF4: Selectable AF point**], you can change the number of manually selectable AF points (p.99).





About the AF Sensor

The camera's AF sensor has 61 AF points. The illustration below shows the AF sensor pattern corresponding to each AF point. With $f/2.8$ or larger maximum aperture lenses, high-precision AF is possible at the viewfinder center.

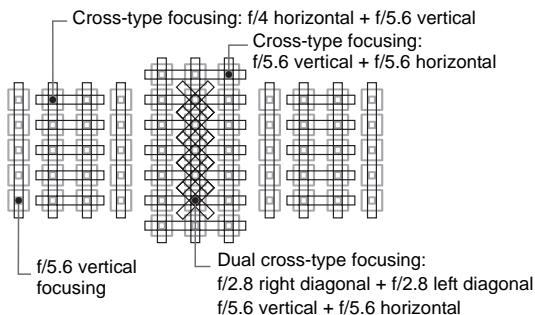
Depending on the lens attached to the camera, the number of usable AF points and AF pattern will differ. For details, see pages 77 to 84.

Diagram



	<p>These focusing sensors are geared to achieve higher precision focusing with $f/2.8$ or larger maximum aperture lenses. A diagonal cross pattern makes it easier to focus subjects that may be difficult to focus. They cover the five vertical AF points at the center.</p>
	<p>These focusing sensors are geared to achieve high-precision focusing with $f/4$ or larger maximum aperture lenses. Since they have a horizontal pattern, they can detect vertical lines.</p>
	<p>These focusing sensors are geared for $f/5.6$ or larger maximum aperture lenses. Since they have a horizontal pattern, they can detect vertical lines. They cover the three columns of AF points at the viewfinder's center. The center AF point, and the AF points above and under the center AF point are geared for $f/8$ or larger maximum aperture.</p>
	<p>These focusing sensors are geared for $f/5.6$ or larger maximum aperture lenses. They can detect horizontal lines and cover all 61 AF points in a vertical pattern. The center AF point, and the AF points on the left and right of the center AF point are geared for $f/8$ or larger maximum aperture.</p>

Lenses and Usable AF Points



- Although the camera has 61 AF points, the number of usable AF points and focusing patterns will differ depending on the lens. The lenses are thereby classified into nine groups from A to I. Check which group your lens belongs to.
- When using a lens from groups F to H, fewer AF points will be usable.



- When you press the button, the AF points indicated by the mark will blink. (The // AF points will stay lit.)
- “Extender EF1.4x” and “Extender EF2x” apply to all the I/II/III models.
- Regarding new lenses marketed after the EOS-1D X, check Canon’s Web site to see which group they belong to.
- Some lenses may not be available in certain countries or regions.

Group A

Autofocusing with 61 points is possible. All of the AF area selection modes are selectable.

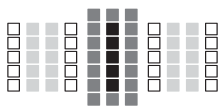

- : Dual cross-type AF point. Subject tracking is superior and the focusing precision is higher than with other AF points.
- : Cross-type AF point. Subject tracking is superior and high-precision focusing is achieved.
- : AF points sensitive to horizontal lines.

EF24mm f/1.4L USM	EF50mm f/1.8	EF200mm f/1.8L USM
EF24mm f/1.4L II USM	EF50mm f/1.8 II	EF200mm f/1.8L USM + Extender EF1.4x
EF28mm f/1.8 USM	EF85mm f/1.2L USM	EF200mm f/2L IS USM
EF35mm f/1.4L USM	EF85mm f/1.2L II USM	EF200mm f/2L IS USM + Extender EF1.4x
EF35mm f/2	EF85mm f/1.8 USM	EF200mm f/2.8L USM
EF35mm f/2 IS USM	EF100mm f/2 USM	EF200mm f/2.8L II USM
EF50mm f/1.0L USM	EF135mm f/2L USM	EF300mm f/2.8L USM
EF50mm f/1.2L USM	EF135mm f/2L USM + Extender EF1.4x	EF300mm f/2.8L IS USM
EF50mm f/1.4 USM	EF135mm f/2.8 (Softfocus)	EF300mm f/2.8L IS II USM

EF400mm f/2.8L USM	EF16-35mm f/2.8L USM	EF70-200mm f/2.8L USM
EF400mm f/2.8L II USM	EF16-35mm f/2.8L II USM	EF70-200mm f/2.8L IS USM
EF400mm f/2.8L IS USM	EF17-35mm f/2.8L USM	EF70-200mm f/2.8L IS II USM
EF400mm f/2.8L IS II USM	EF20-35mm f/2.8L	EF80-200mm f/2.8L
TS-E45mm f/2.8*	EF24-70mm f/2.8L II USM	
TS-E90mm f/2.8*	EF28-70mm f/2.8L USM	

* Manual focus without tilt/shift.

Group B

Autofocusing with 61 points is possible. All of the AF area selection modes are selectable.

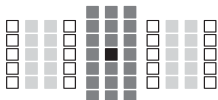

- : Dual cross-type AF point. Subject tracking is superior and the focusing precision is higher than with other AF points.
- : Cross-type AF point. Subject tracking is superior and high-precision focusing is achieved.
- : AF points sensitive to horizontal lines.

EF14mm f/2.8L USM	EF20mm f/2.8 USM	EF28mm f/2.8 IS USM
EF14mm f/2.8L II USM	EF24mm f/2.8	EF24-70mm f/2.8L USM
EF15mm f/2.8 Fisheye	EF24mm f/2.8 IS USM	

Group C

Autofocusing with 61 points is possible. All of the AF area selection modes are selectable.

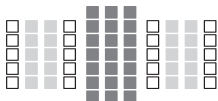

- : Cross-type AF point. Subject tracking is superior and high-precision focusing is achieved.
- : AF points sensitive to horizontal lines.

EF50mm f/2.5 Compact Macro	TS-E24mm f/3.5L II*	EF8-15mm f/4L Fisheye USM
EF100mm f/2.8 Macro	EF200mm f/2.8L USM + Extender EF1.4x	EF17-40mm f/4L USM
EF100mm f/2.8L Macro IS USM	EF200mm f/2.8L II USM + Extender EF1.4x	EF24-70mm f/4L IS USM
EF300mm f/4L USM	EF300mm f/2.8L USM + Extender EF1.4x	EF24-105mm f/4L IS USM
EF300mm f/4L IS USM	EF300mm f/2.8L IS USM + Extender EF1.4x	EF28-80mm f/2.8-4L USM
EF400mm f/4 DO IS USM	EF300mm f/2.8L IS II USM + Extender EF1.4x	EF70-210mm f/4
EF500mm f/4L IS USM	EF400mm f/2.8L USM + Extender EF1.4x	EF70-200mm f/4L USM
EF500mm f/4L IS II USM	EF400mm f/2.8L II USM + Extender EF1.4x	EF70-200mm f/4L IS USM
EF600mm f/4L USM	EF400mm f/2.8L IS USM + Extender EF1.4x	EF70-200mm f/2.8L USM + Extender EF1.4x
EF600mm f/4L IS USM	EF400mm f/2.8L IS II USM + Extender EF1.4x	EF70-200mm f/2.8L IS USM + Extender EF1.4x
EF600mm f/4L IS II USM	EF135mm f/2L USM + Extender EF2x	EF70-200mm f/2.8L IS II USM + Extender EF1.4x
TS-E17mm f/4L*	EF200mm f/1.8L USM + Extender EF2x	
TS-E24mm f/3.5L*	EF200mm f/2L IS USM + Extender EF2x	

* Manual focusing without tilt/shift.

Group D

Autofocusing with 61 points is possible. All of the AF area selection modes are selectable.

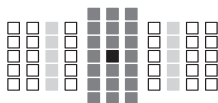

- : Dual cross-type AF point. Subject tracking is superior and the focusing precision is higher than with other AF points.
- : Cross-type AF point. Subject tracking is superior and high-precision focusing is achieved.
- : AF points sensitive to horizontal lines.

EF28mm f/2.8	EF40mm f/2.8 STM
--------------	------------------

Group E

Autofocusing with 61 points is possible. All of the AF area selection modes are selectable.

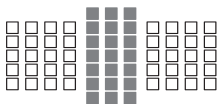

- : Cross-type AF point. Subject tracking is superior and high-precision focusing is achieved.
- : AF points sensitive to horizontal lines.

EF50mm f/2.5 Compact Macro + LIFE SIZE Converter	EF300mm f/2.8L IS USM + Extender EF2x	EF28-135mm f/3.5-5.6 IS USM
EF100mm f/2.8 Macro USM	EF300mm f/2.8L IS II USM + Extender EF2x	EF28-200mm f/3.5-5.6
EF400mm f/5.6L USM	EF400mm f/2.8L USM + Extender EF2x	EF28-200mm f/3.5-5.6 USM
EF500mm f/4.5L USM	EF400mm f/2.8L II USM + Extender EF2x	EF28-300mm f/3.5-5.6L IS USM
EF300mm f/4L USM + Extender EF1.4x	EF400mm f/2.8L IS USM + Extender EF2x	EF35-105mm f/3.5-4.5
EF300mm f/4L IS USM + Extender EF1.4x	EF400mm f/2.8L IS II USM + Extender EF2x	EF35-135mm f/3.5-4.5
EF400mm f/4 DO IS USM + Extender EF1.4x	EF20-35mm f/3.5-4.5 USM	EF35-135mm f/4-5.6 USM
EF500mm f/4L IS USM + Extender EF1.4x	EF24-85mm f/3.5-4.5 USM	EF38-76mm f/4.5-5.6
EF500mm f/4L IS II USM + Extender EF1.4x	EF28-90mm f/4-5.6	EF50-200mm f/3.5-4.5
EF600mm f/4L USM + Extender EF1.4x	EF28-90mm f/4-5.6 USM	EF50-200mm f/3.5-4.5L
EF600mm f/4L IS USM + Extender EF1.4x	EF28-90mm f/4-5.6 II	EF55-200mm f/4.5-5.6 USM
EF600mm f/4L IS II USM + Extender EF1.4x	EF28-90mm f/4-5.6 II USM	EF55-200mm f/4.5-5.6 II USM
EF200mm f/2.8L USM + Extender EF2x	EF28-90mm f/4-5.6 III	EF200-400mm f/4L IS USM Extender 1.4x: With built-in Ext. 1.4x
EF200mm f/2.8L II USM + Extender EF2x	EF28-105mm f/3.5-4.5 USM	
EF300mm f/2.8L USM + Extender EF2x	EF28-105mm f/3.5-4.5 II USM	EF200-400mm f/4L IS USM Extender 1.4x + Extender EF1.4x

EF70-200mm f/2.8L USM + Extender EF2x	EF70-300mm f/4.5-5.6 DO IS USM	EF80-200mm f/4.5-5.6
EF70-200mm f/2.8L IS USM + Extender EF2x	EF75-300mm f/4-5.6	EF90-300mm f/4.5-5.6
EF70-200mm f/2.8L IS II USM + Extender EF2x	EF75-300mm f/4-5.6 USM	EF90-300mm f/4.5-5.6 USM
EF70-200mm f/4L USM + Extender EF1.4x	EF75-300mm f/4-5.6 II	EF100-200mm f/4.5A
EF70-200mm f/4L IS USM + Extender EF1.4x	EF75-300mm f/4-5.6 II USM	EF100-300mm f/4.5-5.6 USM
EF70-210mm f/3.5-4.5 USM	EF75-300mm f/4-5.6 III	EF100-300mm f/5.6
EF70-300mm f/4-5.6 IS USM	EF75-300mm f/4-5.6 III USM	EF100-300mm f/5.6L
EF70-300mm f/4-5.6L IS USM	EF75-300mm f/4-5.6 IS USM	EF100-400mm f/4.5-5.6L IS USM

Group F

Only 47 of the 61 AF points can be used for autofocus. All of the AF area selection modes are selectable. During automatic AF point selection, the outer frame marking the AF area (Area AF frame) will be different from 61-point automatic selection AF.

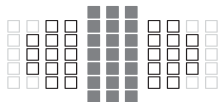

- : Cross-type AF point. Subject tracking is superior and high-precision focusing is achieved.
- : AF points sensitive to horizontal lines.
- : Disabled AF points (not displayed).

EF800mm f/5.6L IS USM	EF28-80mm f/3.5-5.6 III USM	EF35-80mm f/4-5.6 II
EF22-55mm f/4-5.6 USM	EF28-80mm f/3.5-5.6 IV USM	EF35-80mm f/4-5.6 III
EF28-70mm f/3.5-4.5	EF28-80mm f/3.5-5.6 V USM	EF35-80mm f/4-5.6 PZ
EF28-70mm f/3.5-4.5 II	EF28-105mm f/4-5.6	EF35-80mm f/4-5.6 USM
EF28-80mm f/3.5-5.6	EF28-105mm f/4-5.6 USM	EF35-350mm f/3.5-5.6L USM
EF28-80mm f/3.5-5.6 USM	EF35-70mm f/3.5-4.5	EF80-200mm f/4.5-5.6 II
EF28-80mm f/3.5-5.6 II	EF35-70mm f/3.5-4.5A	EF80-200mm f/4.5-5.6 USM
EF28-80mm f/3.5-5.6 II USM	EF35-80mm f/4-5.6	

Group G

Only 33 of the 61 AF points can be used for autofocus. All of the AF area selection modes are selectable. During automatic AF point selection, the outer frame marking the AF area (Area AF frame) will be different from 61-point automatic selection AF.

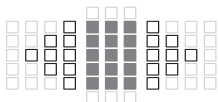

- : Cross-type AF point. Subject tracking is superior and high-precision focusing is achieved.
- : AF points sensitive to horizontal lines.
- ◻: Disabled AF points (not displayed).

EF180mm f/3.5L Macro USM	EF180mm f/3.5L Macro USM + Extender EF1.4x	EF1200mm f/5.6L USM
--------------------------	--	---------------------

Group H

Only the AF point at the center of the viewfinder, and the surrounding AF points (above, below, on the right and on the left) can be used for autofocus. Only the following AF area selection modes are selectable: Single-point AF (manual selection), Single-point Spot AF (manual selection), and AF point expansion (manual selection AF^*).

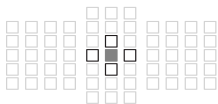

- : Cross-type AF point. Subject tracking is superior and high-precision focusing is achieved.
- : AF points sensitive to horizontal lines (on the right and on the left of the center AF point) or vertical lines (above and under the center AF point). Manual selection is not possible. Only available when “AF point expansion (manual selection AF^*)” is selected.
- ◻: Disabled AF points (not displayed).

EF35-105mm f/4.5-5.6	EF35-105mm f/4.5-5.6 USM
----------------------	--------------------------

● **AF when the maximum aperture is f/8**

When an extender is attached to the lens, AF is possible even when the maximum aperture value is larger than f/5.6 up to f/8. Selectable AF area selection modes are the same as that of group H (p.82).

EF400mm f/5.6L USM + Extender EF1.4x	EF400mm f/4 DO IS USM + Extender EF2x	EF70-200mm f/4L USM + Extender EF2x
EF500mm f/4.5L USM + Extender EF1.4x	EF500mm f/4L IS USM + Extender EF2x	EF70-200mm f/4L IS USM + Extender EF2x
EF800mm f/5.6L IS USM + Extender EF1.4x	EF500mm f/4L IS II USM + Extender EF2x	EF100-400mm f/4.5-5.6L IS USM + Extender EF1.4x
EF1200mm f/5.6L USM + Extender EF1.4x	EF600mm f/4L USM + Extender EF2x	EF200-400mm f/4L IS USM Extender 1.4x: With built-in Ext. 1.4x + Ext. EF1.4x
EF300mm f/4L USM + Extender EF2x	EF600mm f/4L IS USM + Extender EF2x	
EF300mm f/4L IS USM + Extender EF2x	EF600mm f/4L IS II USM + Extender EF2x	EF200-400mm f/4L IS USM Extender 1.4x + Extender EF2x



- If the maximum aperture is smaller than f/5.6 (the maximum aperture value is larger than f/5.6 up to f/8), focus may not be achieved with AF when shooting low-contrast or low-light subjects.
- When Extender EF2x is attached to the EF180mm f/3.5L Macro USM lens, AF is not possible.
- If the maximum aperture is smaller than f/8 (the maximum aperture value exceeds f/8), AF is not possible during viewfinder shooting. Also, AF is not possible with AF-ON during Live View shooting and movie shooting.

Group I

Autofocusing with 61 points is possible. All of the AF area selection modes are selectable.

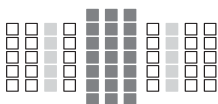

- : Cross-type AF point. Subject tracking is superior and high-precision focusing is achieved.
- : AF points sensitive to horizontal lines.
- : AF points sensitive to horizontal lines.

EF200-400mm f/4L IS USM Extender 1.4x



MENU Selecting AI Servo AF Characteristics (For a Subject)

You can easily fine-tune AI Servo AF to suit a particular subject or scene just by selecting a case from 1 to 6. This feature is called the “AF Configuration Tool”.









1 Select the [AF1] tab.

2 Select a case.

- Turn the <  > dial to select a case icon, then press <  >.
- ▶ The selected case will be set. The selected case is indicated in blue.

About Cases 1 to 6

As explained on pages 90 to 92, cases 1 to 6 are six combinations of subject-tracking sensitivity, acceleration/deceleration tracking, and AF point auto switching settings. Refer to the table below to select the case applicable to the subject or scene.

Case	Icon	Description	Applicable Subjects	Page
Case 1		Versatile multi purpose setting	For any moving subject.	86
Case 2		Continue to track the subjects, ignoring possible obstacles	Tennis players, butterfly swimmers, freestyle skiers, etc.	86
Case 3		Instantly focus on subjects suddenly entering AF points	Starting line of a bicycle race, alpine downhill skiers, etc.	87
Case 4		For subjects that accelerate or decelerate quickly	Soccer, motor sports, basketball, etc.	87
Case 5		For erratic subjects moving quickly in any direction	Figure skaters, etc.	88
Case 6		For subjects that change speed and move erratically	Rhythm gymnastics, etc.	89

Case 1: Versatile multi purpose setting

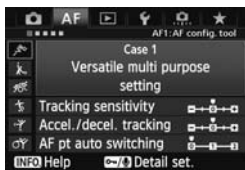

Standard setting suited for any moving subject. Works with many subjects and scenes.

Select **[Case 2]** to **[Case 6]** in the following cases: when obstacles enter AF points, when the subject tends to stray from AF points, when you want to focus a subject that suddenly appears, or when the subject moves dramatically up, down, left, or right.

Default settings

- Tracking sensitivity: [0]
- Accel./decel. tracking: [0]
- AF pt auto switching: [0]

When shooting a subject moving at a steady speed (minimal change in moving speed), if focus is unstable due to the subject's slight movement or an obstacle in front of the subject, setting **[Accel./decel. tracking]** to [-2] or [-1] may give better results (p.91).

Case 2: Continue to track subjects, ignoring possible obstacles

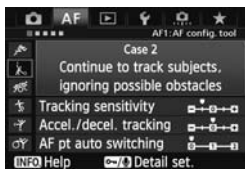

The camera will try to continue focusing the subject even if an obstacle enters the AF points or if the subject strays from the AF points. Effective when there may be an obstacle blocking the subject or when you do not want to focus the background.

Default settings

- Tracking sensitivity:
[Locked on: -1]
- Accel./decel. tracking: [0]
- AF pt auto switching: [0]

If an obstacle gets in the way or if the subject moves away from the AF points for a prolonged period and the focus on the target subject is lost with the default setting, setting **[Tracking sensitivity]** to **[Locked on: -2]** may give better results (p.90).

Case 3: Instantly focus on subjects suddenly entering AF points

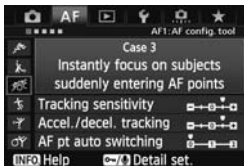

Once an AF point starts tracking the subject, this setting enables the camera to focus consecutive subjects at different distances. If a new subject appears in front of the target subject, the camera will start focusing the new subject. Also effective when you want to always focus on the closest subject.

Default settings

- Tracking sensitivity:
[Responsive: +1]
- Accel./decel. tracking: [+1]
- AF pt auto switching: [0]

If you want to quickly focus a subject appearing suddenly, setting [Tracking sensitivity] to [+2] may give better results (p.90).

Case 4: For subjects that accelerate or decelerate quickly

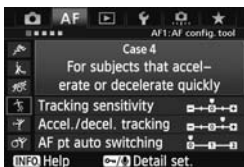

Geared for tracking moving subjects prone to sudden, dramatic changes in speed.

Effective for subjects with sudden movements, sudden acceleration/ deceleration, or sudden stops.

Default settings

- Tracking sensitivity: [0]
- Accel./decel. tracking: [+1]
- AF pt auto switching: [0]

If the subject is in motion, and prone to sudden, dramatic changes in speed, setting [Accel./decel. tracking] to [+2] may give better results (p.91).

Case 5: For erratic subjects moving quickly in any direction

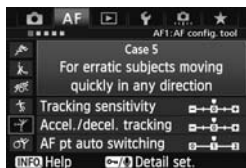

Default settings

- Tracking sensitivity: [0]
- Accel./decel. tracking: [0]
- AF pt auto switching: [+1]

Even if the target subject moves dramatically up, down, left, or right, the AF point will switch automatically to focus-track the subject. Effective for shooting subjects that move dramatically up, down, left, or right. This setting takes effect when the following AF area selection modes are set: AF point expansion (manual selection $\text{AF} \cdot \text{Exp}$), AF point expansion (manual selection, surrounding points), Zone AF (manual selection of zone), 61-point automatic selection AF.

This setting is not available with the Single-point Spot AF (manual selection) and Single-point AF (manual selection) modes.

 If the subject is prone to sudden, erratic movements up, down, left or right, setting [AF pt auto switching] to [+2] may give better results (p.92).

Case 6: For subjects that change speed and move erratically

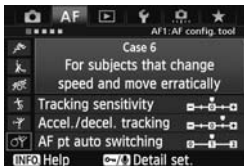

Default settings

- Tracking sensitivity: [0]
- Accel./decel. tracking: [+1]
- AF pt auto switching: [+1]

Geared for tracking moving subjects whose speed can change dramatically and suddenly. Also, if the target subject moves dramatically up, down, left or right and it is difficult to focus, the AF point switches automatically to track the subject.

This setting takes effect when the following AF area selection modes are set: AF point expansion (manual selection $\square \square \square$), AF point expansion (manual selection, surrounding points), Zone AF (manual selection of zone), 61-point automatic selection AF.

This setting is not available with the Single-point Spot AF (manual selection) and Single-point AF (manual selection) modes.



- If the speed of the moving subject suddenly changes greatly, setting [**Accel./decel. tracking**] to [+2] may give better results (p.91).
- If the subject moves suddenly and erratically up, down, left, or right, setting [**AF pt auto switching**] to [+2] may give better results (p.92).

About the Parameters

● Tracking sensitivity

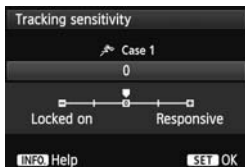

Sets the subject-tracking sensitivity during AI Servo AF when an obstacle enters the AF points or when the AF points stray from the subject.

[0]

Standard setting suited for most moving subjects.

[Locked on: -2 / Locked on: -1]

The camera will try to continue focusing the subject even if an obstacle enters the AF points or if the subject strays from the AF points. The -2 setting makes the camera track the target subject longer than with the -1 setting.

However, if the camera focuses the wrong subject, it may take slightly longer to switch subjects and refocus the target subject.

[Responsive: +2 / Responsive: +1]

Once an AF point tracks a subject, the camera can focus consecutive subjects at different distances. Also effective when you want to always focus on the closest subject. The +2 setting makes it quicker to focus the next consecutive subject than with +1.

However, the camera will be more prone to focus on the wrong subject.

 [Tracking sensitivity] is the parameter named [AI Servo tracking sensitivity] in the EOS-1D Mark III/IV, EOS-1Ds Mark III, and EOS 7D.

● Acceleration/deceleration tracking

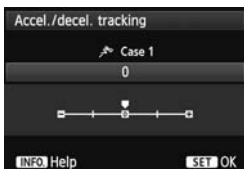

This sets the tracking sensitivity for moving subjects whose speed can suddenly change dramatically by starting or stopping suddenly, etc.

[0]

Suited for subjects that move at a steady speed (minimal change in moving speed).

[-2 / -1]

Suited for subjects that move at a steady speed (minimal change in moving speed). It is effective when 0 is set but focus is unstable due to the subject's slight movement or an obstacle in front of the subject.

[+2 / +1]

Effective for subjects having sudden movements, sudden acceleration/deceleration, or sudden stops. Even if the moving subject's speed suddenly changes dramatically, the camera continues to focus the target subject. For example, for an approaching subject, the camera becomes less prone to focus behind it, which would result in a blurred subject. For a subject stopping suddenly, the camera becomes less prone to focus in front of it. Setting +2 can track dramatic changes in the moving subject's speed better than with +1.

However, since the camera will be sensitive to even slight movements of the subject, the focusing may be unstable momentarily.

● AF point auto switching



This sets the switching sensitivity of the AF points as they track a subject that moves dramatically up, down, left, or right.

This setting takes effect in the following AF area selection modes: AF point expansion (manual selection \square), AF point expansion (manual selection, surrounding points), Zone AF (manual selection of zone), 61-point automatic selection AF.

[0]

Standard setting for gradual AF point switching.

[+2 / +1]

Even if the target subject moves dramatically up, down, left, or right and moves away from the AF point, the AF point switches to another one to continue focusing the subject. The camera switches to the AF point deemed most likely to focus the subject based on the subject's continual movement, contrast, etc. Setting +2 makes the camera more prone to switch the AF point than with +1.

However, with a wide-angle lens having a wide depth of field or if the subject is too small in the frame, the camera may focus with the wrong AF point.

Changing Cases' Parameter Settings

You can adjust each case's three parameters (1. Tracking sensitivity, 2. Accel./decel. tracking, and 3. AF pt auto switching) as desired.

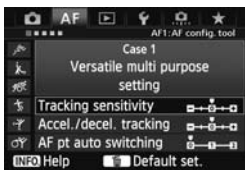

1 Select a case.

- Turn the <⦿> dial to select the icon of the case you want to adjust.

2 Press the <⦿/🔊> button.

- The selected parameter will have a purple frame.

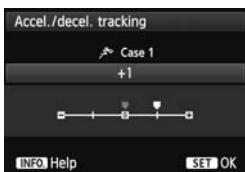

3 Select the desired item.

- Turn the <⦿> dial to select a parameter, then press <ⓈET>.

4 Make the adjustment.

- Turn the <⦿> dial to adjust the parameter as desired, then press <ⓈET>.
- ▶ The adjustment is saved.
- The default setting is indicated by the light gray [] mark.

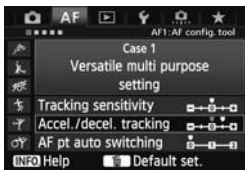

5 Exit the setting.

- To return to the screen in step 1, press the <⦿> button.



- In step 2, pressing the <⦿> button will reset the respective case's three parameters to their default settings.
- You can also register each of the three parameter settings to My Menu (p.357). Doing so will change the selected case's settings.
- When shooting with a case whose parameters you adjusted, select the adjusted case and then take the picture.

MENU Customizing AF Functions

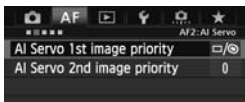

With the [**AF2**] to [**AF5**] menu tabs, you can set AF functions to suit your shooting style or subject.

AF2: AI Servo

AI Servo 1st image priority

You can set the AF operation characteristics and shutter-release timing for the first shot during continuous shooting with AI Servo AF.



/🎯: Equal priority

Equal priority is given to focusing and shutter release.

: Release priority

Pressing the shutter button takes the picture immediately even if focus has not been achieved. This gives priority to getting the shot rather than achieving correct focus.

: Focus priority

Pressing the shutter button does not take the picture until focus has been achieved. Effective when you want to achieve focus before capturing the shot.

AI Servo 2nd image priority

You can set the AF operation characteristics and shutter-release timing for subsequent shots during continuous shooting with AI Servo AF.

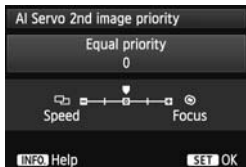

0: Equal priority

Equal priority is given to focusing and continuous shooting speed. In low light or with low-contrast subjects, shooting speed may slow down.

-2/-1: Shooting speed priority

Priority is given to the continuous shooting speed instead of achieving focus. With -2, decrease of continuous shooting speed can be better prevented than with -1.

+1/+2: Focus priority

Priority is given to achieving focus instead of the continuous shooting speed. The picture is not taken until focus is achieved. Although focus can be achieved easier in low-light conditions with +2 than with +1, continuous shooting speed may decrease.

If focus cannot be achieved in low-light conditions when **[0: Equal priority]** is set, setting **[Focus priority]** to **[+1]** or **[+2]** may give better results.

AF3: One Shot**USM lens electronic MF**

You can set whether and how to use the electronic focusing ring when using one of the electronic focusing ring-equipped lenses below.

EF50mm f/1.0L USM	EF300mm f/2.8L USM	EF600mm f/4L USM
EF85mm f/1.2L USM	EF400mm f/2.8L USM	EF1200mm f/5.6L USM
EF85mm f/1.2L II USM	EF400mm f/2.8L II USM	EF28-80mm f/2.8-4L USM
EF200mm f/1.8L USM	EF500mm f/4.5L USM	

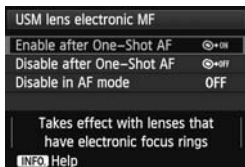
**ON: Enable after One-Shot AF**

If you keep pressing the shutter button halfway after AF operation, you can focus manually.

OFF: Disable after One-Shot AF

Manual focusing is disabled after AF operation.

OFF: Disable in AF mode

When the lens' focus mode switch is set to **[AF]**, manual focusing is disabled.

AF-assist beam firing

Enables or disables the EOS-dedicated Speedlite's AF-assist beam.

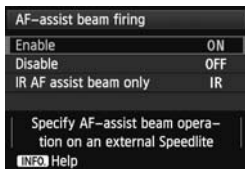

ON: Enable

The external Speedlite emits the AF-assist beam when necessary.

OFF: Disable

The external Speedlite will not emit the AF-assist beam. This prevents the AF-assist beam from disturbing others.

IR: IR AF assist beam only

Only external Speedlite models that have an infrared AF-assist beam will emit the AF-assist beam. Set this if you do not want the AF assist using small flashes to be emitted.

! If the external Speedlite's Custom Function [**AF-assist beam firing**] is set to [**Disable**], the AF-assist beam will not be emitted, regardless of this function's setting.

One-Shot AF release priority

You can set the AF operation characteristics and shutter-release timing for One-Shot AF.

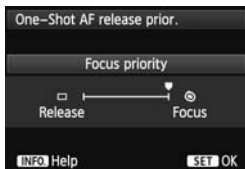

☺: Focus priority

The picture is not taken until focus is achieved. Effective when you want to achieve focus before capturing the shot.

☐: Release priority

Priority is given to taking the picture instead of achieving focus. This gives priority to getting the shot.

Note that the picture will be taken even if focus has not been achieved.

AF4

Auto AF point selection: EOS iTR AF

When the AF area selection mode is set to 61-point automatic selection AF or Zone AF, AF is possible while using the subject's color or face detection information.

Using this function makes it easier to continue focusing a moving subject with AI Servo AF. Using this function also makes it easier to focus human subjects in One-Shot AF mode.

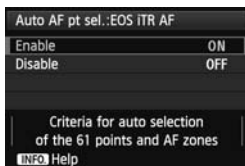
**ON: Enable**

The AF point is automatically selected based on the AF information combined with the color and facial information of the subject. With AI Servo AF, the color of the area where focus is initially achieved is recorded.

The camera then tracks that color by switching AF points. If a human face is detected, the AF tracking and AF point switching switch to this face. With 61-point automatic selection AF and AI Servo AF, you can manually select the initial AF point to be used to focus. If multiple faces are detected, the camera focuses using the AF point on the optimum face given current conditions.

With One-Shot AF, the camera selects the AF point based on face position information, and you can give priority to composition when taking the picture.

OFF: Disable

The AF point is selected automatically based only on the AF information.



- When [**Auto AF pt sel: EOS iTR AF**] is set to [**Enable**], focus will take slightly longer than with [**Disable**].
- Even if you set [**Enable**], the desired result may not be obtained depending on the shooting conditions and subject.
- Under low-light conditions when the flash emits the AF-assist beam automatically, the AF point is selected automatically based only on the AF information. (The AF does not use facial information.)
- Face detection may not work if the face is small or in low-light condition.

Lens drive when AF impossible

If focus cannot be achieved with autofocus, you can have the camera keep searching for the correct focus or have it stop searching.

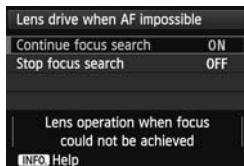

ON: Continue focus search

If focus cannot be achieved with autofocus, the lens is driven to search for the correct focus.

OFF: Stop focus search

If autofocus starts and the focus is far off or if focus cannot be achieved, the lens drive stops. This prevents the lens from becoming grossly out of focus due to focus searching.

 Super telephoto lenses can become grossly out of focus during continuous focus search, taking more time to achieve focus the next time. Therefore, setting [**Stop focus search**] is recommended for super telephoto lenses.

Selectable AF point

You can change the number of manually selectable AF points. With automatic AF point selection, all 61 AF points will remain active regardless of this setting.

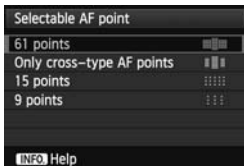

: 61 points

All 61 AF points will be manually selectable.

: **Only cross-type AF points**

Only cross-type AF points will be manually selectable. The number of selectable cross-type AF points will differ depending on the lens.



: 15 points

Fifteen main AF points will be manually selectable.

: 9 points

Nine main AF points will be manually selectable.

 With a lens from groups F to H (p.81-83), the number of manually selectable AF points will be fewer.

- 
- Even with settings other than **[61 points]**, AF point expansion (manual selection )¹, AF point expansion (manual selection, surrounding points), and Zone AF (manual selection of zone) are still possible.
 - When you press the  button, the AF points that are not manually selectable will not be displayed.

Select AF area selection mode

You can limit the selectable AF area selection modes to suit your shooting preferences. Turn the <◉> dial to select a selection mode, then press <Ⓢ> to append a checkmark <✓>. Then select [OK] to register the setting.

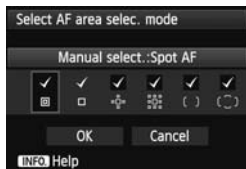

◻: Manual select.:Spot AF

For pinpoint focusing with a narrower AF point than Single-point AF (manual selection).

◻: Manual selection:1 pt AF

One of the AF points set by [Selectable AF point] setting can be selected.

⊕: Expand AF area:⊕

The camera will focus with the manually-selected AF point and the adjacent AF points (above, below, left and right).

⊕: Expand AF area:Surround

The camera will focus with the manually-selected AF point and the surrounding AF points.

(): Manual select.:Zone AF

The 61 AF points are divided into nine zones for focusing.

◉: Auto selection: 61 pt AF

All of the AF points are used for focusing.

- The <✓> mark cannot be deleted from [Manual selection:1 pt AF].
- If the attached lens belongs to group H (p.82, 83), you can only select [Manual select.:Spot AF], [Manual selection:1 pt AF], and [Expand AF area:⊕].

AF area selection method

You can set the method for changing the AF area selection mode.

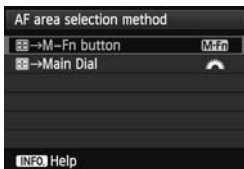

M-Fn : → **M-Fn button**

After you press the button, the AF area selection mode changes each time you press the button.

: → **Main Dial**

After you press the button, turning the dial changes the AF area selection mode.

When → **Main Dial** is set, use the to move the AF point horizontally.

Orientation linked AF point

You can set the AF point or a combination of AF area selection mode and AF point separately for vertical shooting and horizontal shooting.

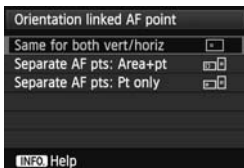

: **Same for both vert/horiz**

The same AF area selection mode and manually-selected AF point (or Zone) are used for both vertical shooting and horizontal shooting.

: **Separate AF pts: Area+pt**

The AF area selection mode and manually-selected AF point (or Zone) can be set separately for each camera orientation (1. Horizontal, 2. Vertical with the camera grip at the top, 3. Vertical with the camera grip at the bottom).

When you manually select the AF area selection mode and AF point (or zone) for each of the three camera orientations, they will be recorded for the respective orientation. Whenever you change the camera orientation during shooting, the camera will switch to the AF area selection mode and manually-selected AF point (or zone) set for that orientation.

: **Separate AF pts: pt only**

The AF point can be set separately for each camera orientation (1. Horizontal, 2. Vertical with the camera grip at the top, 3. Vertical with the camera grip at the bottom). While using the same AF area selection mode, the AF point will switch automatically for the respective camera orientation.

This works with Manual select.:Spot AF, Manual selection:1 pt AF, Expand AF area:, and Expand AF area:Surround.

When you manually select the AF point for each of the three camera orientations, it will be recorded for the respective orientation. During shooting, the manually-selected AF point will switch to match the respective camera orientation. Even if you change the AF area selection mode to Manual select.:Spot AF, Manual selection:1 pt AF, Expand AF area:, or Expand AF area:Surround, the AF point set for the respective orientation will be retained.

If you change the AF area selection mode to Zone AF (manual selection of zone), the zone will switch to match the respective camera orientation.

-  ● If you clear the camera settings to their defaults (p.58), the setting will be **[Same for both vert/horiz]**. Also, your settings for the three camera orientations will be cleared and all settings will revert to Single-point AF (manual selection) with the center AF point selected.
- If you set this and later attach a lens from a different AF group (p.77-84, especially Group H), the setting may be cleared.

Initial AF point, AI Servo AF

You can set the AI Servo AF's starting AF point for when the AF area selection mode is set to Auto selection: 61 pt AF.

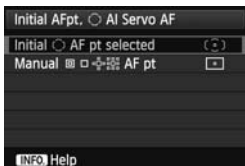

: Initial AF pt selected



AI Servo AF will start with the manually-selected AF point when the AF mode is set to AI Servo AF and the AF area selection mode is set to Auto selection: 61 pt AF.

: Manual AF pt

If you switch from Manual select.:Spot AF, Manual selection:1 pt AF, Expand AF area:, or Expand AF area:Surround to Auto selection: 61 pt AF, AI Servo AF will start with the AF point that was manually selected before the setting was switched. Effective if you want AI Servo AF to start with the AF point which was selected before the AF area selection mode was switched to Auto selection: 61 pt AF.

Under [**5: Custom Controls**], if [**AF area selection mode**] is set to Auto selection: 61 pt AF on the [**Switch to registered AF func.**] (p.350), or [**Register/recall shooting func**] (p.355) setting screen and you use Manual select.:Spot AF, Manual selection:1 pt AF, or Expand AF area:, you can press the function-assigned button to switch from the previous AF point to AI Servo AF that uses Auto selection: 61 pt AF.



When [**Manual   AF pt**] is set, AI Servo AF will start with the zone which has the manually-selected AF point. This will apply even when the AF area selection mode is switched to Zone AF (manual selection of zone).

AF5

Manual AF point selection pattern

During manual AF point selection, the selection can either stop at the outer edge of the area AF frame or it can move to the opposite AF point. This function works in AF area selection modes other than 61-point automatic selection AF and Zone AF. (It takes effect in 61-point automatic selection AF only with AI Servo AF.)

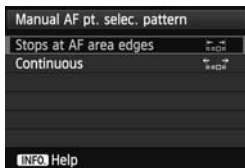
 : **Stops at AF area edges**

Convenient if you often use an AF point along the edge.

 : **Continuous**

Instead of stopping at the outer edge, the selected AF point continues to the opposite side of the area AF frame.

AF point display during focus

You can set whether or not to display the AF point(s) in the following cases: 1. When selecting the AF point(s), 2. When the camera is ready to shoot (before AF operation), 3. During AF operation, and 4. When focus is achieved.

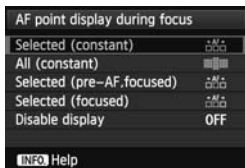
 : **Selected (constant)**

The selected AF point(s) is always displayed.

 : **All (constant)**

All 61 AF points are always displayed.

 : **Selected (pre-AF, focused)**

The selected AF point(s) is displayed for 1, 2, and 4.

 : **Selected (focused)**

The selected AF point(s) is displayed for 1 and 4.

OFF: Disable display

For 2, 3, and 4, the selected AF point(s) will not be displayed.

 If [Selected (pre-AF, focused)] or [Selected (focused)] is set, the AF point will not be displayed even when focus is achieved with AI Servo AF.

VF display illumination

The AF points and grid in the viewfinder can be illuminated in red when focus is achieved.

VF display illumination	
Auto	AUTO
Enable	ON
Disable	OFF
AF point during AI Servo AF OFF	
AF point during AI Servo AF	
Help	

AUTO: Auto

The AF points and grid are automatically illuminated in red under low light.

ON: Enable

The AF points and grid are illuminated in red regardless of the ambient light level.

OFF: Disable

The AF points and grid are not illuminated in red.

Press the button to set the AF points to be illuminated in red (blink) during AI Servo AF.

AF point during AI Servo AF	
Non illuminated	OFF
Illuminated (Normal)	
Illuminated (Brighter)	

OFF: Non illuminated

AF points are not illuminated in red during AI Servo AF.

: Illuminated (Normal)

AF points used for focusing are illuminated in red during AI Servo AF. The red illumination takes effect when [VF display illumination] is set to [Auto] or [Enable].

: Illuminated (Brighter)

The function is the same as that of [Illuminated (Normal)]. However, the illumination is brighter.



- The setting here is not applied to the electronic level display (p.61) in the viewfinder.
- Blinking interval depends on the shooting conditions.



The AF points and grid will always be illuminated in red when you press for AF point selection.

AF status in viewfinder

The AF status indicator indicating that AF is operating can be displayed in the viewfinder's field of view or outside the field of view.



: **Show in field of view**

The AF status icon <AF> is displayed in the lower right of the viewfinder's field of view.

: **Show outside view**

The <▲▶> icon is displayed below the focus confirmation light <●> outside the viewfinder's field of view.

 The AF status indicator will also be displayed when you hold down the shutter button halfway after focus is achieved or when you hold down the <AF-ON> button.

AF Microadjustment

You can make fine adjustments for the AF's point of focus. For details, see "Fine Adjustment of AF's Point of Focus" on the next page.

MENU Fine Adjustment of AF's Point of Focus

Fine adjustment of the AF's point of focus is possible for viewfinder shooting and in Live View shooting's **[Quick mode]**. This is called "AF Microadjustment". Before making the adjustment, read "Notes for AF Microadjustment" on page 112.

- !** Normally, this adjustment is not required. Do this adjustment only if necessary. Note that performing AF Microadjustment may prevent correct focusing from being achieved.

Adjust All by Same Amount

Set the adjustment value manually by adjusting, shooting, and checking the result. Repeat this until the desired adjustment is made. During AF, regardless of the lens used, the point of focus will always be shifted by the adjustment amount.

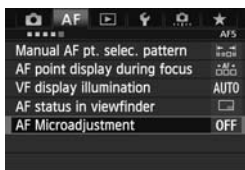

1 Select **[AF Microadjustment]**.

- Under the **[AF5]** tab, select **[AF Microadjustment]**, then press **<SET>**.

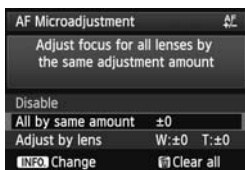

2 Select **[All by same amount]**.

- Turn the **<DIAL>** to select **[All by same amount]**.

3 Press the **<INFO.>** button.

- ▶ The **[All by same amount]** screen will appear.

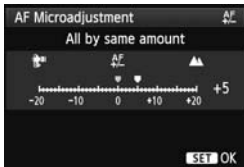

4 Make the adjustment.

- Turn the < > dial to make the adjustment. The adjustable range is ± 20 steps.
- Setting it toward “-: ” will shift the point of focus in front of the standard point of focus.
- Setting it toward “+: ” will shift the point of focus to the rear of the standard point of focus.
- After making the adjustment, press < >.
- Turn the < > dial to select **[All by same amount]**, then press < >. The menu will reappear.

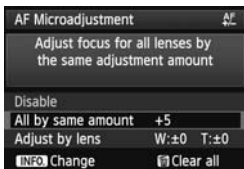

5 Check the result of the adjustment.

- Take a picture and play back the image (p.252) to check the adjustment result.
- When the resulting picture is focused in front of the targeted point, adjust toward the “+: ” side. When the resulting picture is focused behind the targeted point, adjust toward the “-: ” side.
- If necessary, repeat the adjustment.

If **[All by same amount]** is selected, AF adjustment will not be possible for the wide-angle and telephoto ends of zoom lenses.

Adjust by Lens

You can perform AF Microadjustment for each lens and register the adjustment in the camera. You can register the adjustment for up to 40 lenses. When you autofocus with a lens whose adjustment has been registered, the point of focus will always be shifted by the adjustment amount.

Set the adjustment manually by adjusting, shooting, and checking the result. Repeat this until the desired adjustment is made. If you use a zoom lens, make the adjustment for the wide-angle (W) and telephoto (T) ends.

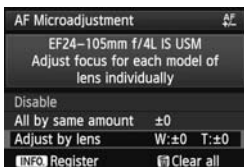

1 Select [Adjust by lens].

- Turn the <◉> dial to select [**Adjust by lens**].

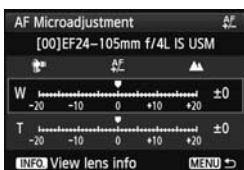

2 Press the <INFO.> button.

- ▶ The [**Adjust by lens**] screen will appear.

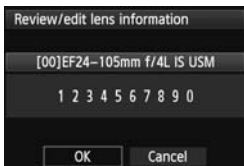

3 Check and change the lens information.

Check the lens information.

- Press the <INFO.> button.
- ▶ The screen will show the lens name and a 10-digit serial number. When the serial number is displayed, select [**OK**] and go to step 4.
- If the lens' serial number cannot be confirmed, "0000000000" will be displayed. Enter the number as indicated below. See the next page about the asterisk "*" displayed in front of the lens serial number.

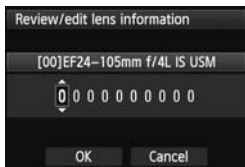

Enter the serial number.

- Turn the <⦿> dial to select the digit, then press <SET> to display <⏏>.
- Turn the <⦿> dial to enter the number, then press <SET>.
- After entering all the digits, turn the <⦿> dial to select [OK], then press <SET>.

About the Lens Serial Number

- In step 3, if “*” appears in front of the 10-digit lens serial number, you cannot register several copies of the same lens model. Even if you enter the serial number, “*” will remain displayed.
- The lens serial number on the lens may differ from the serial number displayed on the screen in step 3. This is not a defect.
- If the lens serial number includes letters, enter only the numbers in step 3.
- The location of the serial number differs depending on the lens.
- Some lenses may not have a serial number inscribed. To register a lens that has no serial number inscribed, enter any serial number in step 3.



- If [Adjust by lens] is selected and an Extender is used, the adjustment will be registered for the lens and Extender combination.
- If 40 lenses have already been registered, a message will appear. After you select a lens whose registration is to be erased (overwritten), you can register another lens.

Single focal length lens

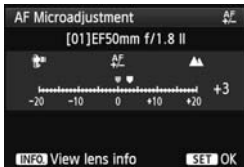

Zoom lens

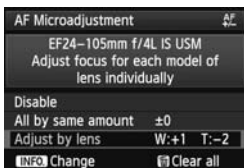
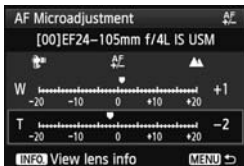

4 Make the adjustment.

- For a zoom lens, turn the $\langle \odot \rangle$ dial and select the wide-angle (W) or telephoto (T) end. Press $\langle \text{SET} \rangle$ to turn off the purple frame and make the adjustment.
- Turn the $\langle \odot \rangle$ dial to adjust as desired, then press $\langle \text{SET} \rangle$. The adjustable range is ± 20 steps.
- Adjusting toward “-: ⏏ ” will shift the point of focus in front of the standard point of focus.
- Adjusting toward “+: \blacktriangle ” will shift the point of focus to the rear of the standard point of focus.
- For a zoom lens, repeat step 4 and adjust it for the wide-angle (W) and telephoto (T) ends.
- After completing the adjustment, press the $\langle \text{MENU} \rangle$ button to return to the screen in step 1.
- Turn the $\langle \odot \rangle$ dial to select [**Adjust by lens**], then press $\langle \text{SET} \rangle$. The menu will reappear.

5 Check the result of the adjustment.

- Take a picture and play back the image (p.252) to check the adjustment result.
- When the resulting picture is focused in front of the targeted point, adjust toward the “+: \blacktriangle ” side. When the resulting picture is focused behind the targeted point, adjust toward the “-: ⏏ ” side.
- If necessary, repeat the adjustment.



When shooting with the intermediate range (focal length) of a zoom lens, the AF's point of focus is corrected relative to the adjustments made for the wide-angle and telephoto ends. Even if only the wide-angle or telephoto end has been adjusted, a correction will be made automatically for the intermediate range.

Clearing All AF Microadjustment data

When [Clear all] appears at the bottom of the screen, pressing the <Clear> button will clear all the adjustment data set for [All by same amount] and [Adjust by lens].

Notes for AF Microadjustment



- The AF's point of focus will vary slightly depending on the subject conditions, brightness, zoom position, and other shooting conditions. Therefore, even if you perform AF Microadjustment, focus may still not be achieved at the suitable position.
- The adjustment data will be retained even if you clear all the camera settings (p.58). However, the setting itself will be [Disable].



- It is best to make the adjustment at the actual location where you will shoot. This will make the adjustment more precise.
- Using a tripod when making the adjustment is recommended.
- To check the result of the adjustment, setting the image size to JPEG L (Large) and the JPEG quality (compression) to 8 or higher is recommended.
- The adjustment amount of one step varies depending on the maximum aperture of the lens. Keep adjusting, shooting, and checking the focus repeatedly to adjust the AF's point of focus.
- AF adjustment is not possible for Live View shooting's [Live mode] and [Live mode] (contrast AF).

When Autofocus Fails

Autofocus can fail to achieve focus (the viewfinder's focus confirmation light <●> blinks) with certain subjects such as the following:

Subjects difficult to focus

- Very low-contrast subjects
(Example: Blue sky, solid-color walls, etc.)
- Subjects in very low light
- Extremely backlit or reflective subjects
(Example: Car with a highly reflective body, etc.)
- Near and far subjects covered by an AF point
(Example: Animal in a cage, etc.)
- Repetitive patterns
(Example: Skyscraper windows, computer keyboards, etc.)

In such cases, do either of the following:

- (1) With One-Shot AF, focus on an object at the same distance as the subject and lock the focus before recomposing (p.67).
- (2) Set the lens focus mode switch to <MF> and focus manually (p.114).



For conditions where AF can fail to achieve focus with [Live mode]/[Live mode] during Live View shooting, see page 219.

MF: Manual Focusing

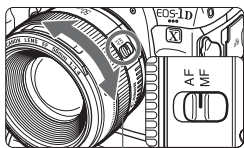

Focusing ring

1 Set the lens focus mode switch to <MF>.

2 Focus the subject.

- Focus by turning the lens focusing ring until the subject looks sharp in the viewfinder.

- 
- If you press the shutter button halfway while focusing manually, the focus confirmation light <●> will light up when focus is achieved.
 - With 61-point automatic selection, when the center AF point achieves focus, the focus confirmation light <●> will light up.

DRIVE: Selecting the Drive Mode

Single and continuous shooting drive modes are provided.

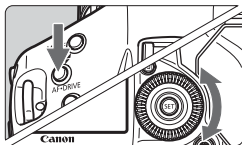

1 Press the **<AF·DRIVE>** button. (ⓘ6)

2 Select the drive mode.

- While looking at the top LCD panel, turn the **<ⓘ>** dial.



 : **Single shooting**

When you press the shutter button completely, only one shot will be taken.

 : **High-speed continuous shooting** (Max. approx. 12 shots/sec.)

 : **Low-speed continuous shooting** (Max. approx. 3 shots/sec.)

While you hold down the shutter button completely, shots will be taken continuously.

 When **<ⓘH>** is set, the maximum continuous shooting speed will be approx. 10 shots/sec. if the ISO speed is set to any of the following:

- ISO 32000 or higher is set manually.
- [Auto ISO range]'s [Maximum] is set to [51200] and Auto ISO automatically sets ISO 32000 or higher.
- [ⓘ1: Safety shift] is set to [ISO speed] and the safety shift automatically sets ISO 32000 or higher.

Note that if the camera's internal temperature is low, and when ISO 20000 or higher is set manually or automatically, the maximum continuous shooting speed for **<ⓘH>** will be approx. 10 fps.

¹⁰ : **10-sec. self-timer**

₂ : **2-sec. self-timer**



See page 117 for the self-timer procedure.

S : Single: Silent shooting

The shooting sound for single shooting is quieter than <□>. The internal mechanical operation is not executed until you return the shutter button to its halfway position.

 Super high speed continuous shooting

(Max. approx. 14 shots/sec.)

If you append a checkmark <✓> to [ **14fps super high speed**] under [**3: Restrict drive modes**], you can use Super high speed continuous shooting (p.333). When Super high speed continuous shooting is set, <H> will blink on the top LCD panel. On the LCD monitor, < H> will be displayed. While you hold down the shutter button completely, shots will be taken continuously. Since continuous shooting is done with the mirror locked up, the focus will be fixed during shooting and images will be recorded in JPEG. If RAW or RAW+JPEG is set, it will switch automatically to < H> (High-speed continuous shooting).

-  H: The maximum continuous shooting speed of approx. 12 shots/sec. is attained under the following conditions*: At ISO 25600 or lower, 1/1000 sec. or faster shutter speed, and at the maximum aperture (varies depending on the lens). The continuous shooting speed may be slower depending on the ISO speed, shutter speed, aperture, subject conditions, brightness, lens type, flash use, etc.

* With the AF mode set to One-Shot AF and the Image Stabilizer turned off when using the following lenses: EF300mm f/4L IS USM, EF28-135mm f/3.5-5.6 IS USM, EF75-300mm f/4-5.6 IS USM, EF100-400mm f/4.5-5.6L IS USM.

-  H: The maximum continuous shooting speed of approx. 14 shots/sec. is attained at the following conditions; 1/1000 sec or faster shutter speed.
- If [**Auto AF pt sel.: EOS iTR AF**] is set to [**Enable**] (p.97), the continuous shooting speed will decrease under low light conditions, such as indoors.
- If the image-recording quality settings of Card **1** and Card **2** are different when [**1: Record func.**] is set to [**Rec. separately**] (p.120), the maximum burst for continuous shooting will decrease greatly (p.126). When internal memory becomes full during continuous shooting, the continuous shooting speed may drop during shooting since shooting will be temporarily disabled (p.128).

📷 Using the Self-timer

Use the self-timer when you want to be in the picture.

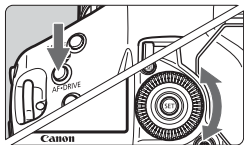

1 Press the **<AF•DRIVE>** button. (📷)

2 Select the self-timer.

- While looking at the top LCD panel, turn the **<📷>** dial to select the self-timer.

📷¹⁰ : **10-sec. self-timer**

📷₂ : **2-sec. self-timer**

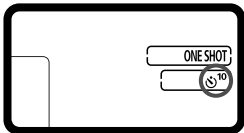

3 Take the picture.

- Look through the viewfinder, focus the subject, then press the shutter button completely.
- ▶ You can check the self-timer operation with the self-timer lamp and the countdown display (in seconds) on the top LCD panel.
- ▶ The lamp's blinking will become faster two seconds before the picture is taken.

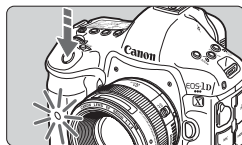

📷 If you do not look through the viewfinder when you press the shutter button, close the eyepiece shutter before shooting (p.185). If stray light enters the viewfinder when the picture is taken, it may throw off the exposure.

- 📷 ● The **<📷₂>** enables you to shoot while not touching the camera mounted on a tripod. This prevents camera shake when you shoot still lifes or bulb exposures.
- After taking self-timer shots, playing back the image (p.252) to check focus and exposure is recommended.
- When using the self-timer to shoot only yourself, use focus lock (p.67) on an object at about the same distance as where you will stand.
- To cancel the self-timer after it starts, set the power switch to **<OFF>**.

MEMO

3

Image Settings

This chapter explains image-related function settings: Image-recording quality, ISO speed, Picture Style, white balance, Auto Lighting Optimizer, lens peripheral illumination correction, chromatic aberration correction, and other functions.

MENU Selecting the Card for Recording and Playback

If a card is inserted in either Card [1] or Card [2], you can start shooting. When only one card is inserted, the procedures described on pages 120 to 122 are not necessary.

If you insert two cards, you can select the recording method and select which card to use to record and play back images.

Recording Method with Two Cards Inserted

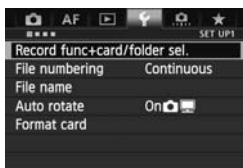

1 Select [Record func+card/folder sel.].

- Under the [P 1] tab, select [Record func+card/folder sel.], then press <SET>.

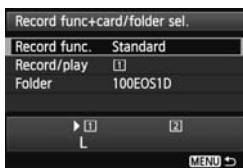

2 Select [Record func.].

- Turn the <DISP> dial to select [Record func.], then press <SET>.

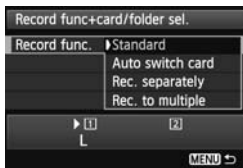

3 Select the recording method.

- Turn the <DISP> dial to select the recording method, then press <SET>.

- **Standard**

Images will be recorded to the card selected with **[Record/play]**.

- **Auto switch card**

Same as with the **[Standard]** setting, but if the card becomes full, the camera will automatically switch to the other card to record images. When the camera switches to the other card, a new folder will be created automatically.

- **Rec. separately**

You can set the image size for each card (p.123). Each image is recorded to both Card **[1]** and Card **[2]** at the image-recording quality you have set. You can freely set the image size to **L** and **RAW** or **M2** and **S RAW**, etc.

- **Rec. to multiple**

Each image is recorded to both Card **[1]** and Card **[2]** at the same image-recording quality you have set. You can also select RAW+JPEG.



When **[Rec. separately]** is set and the image-recording quality settings of Card **[1]** and Card **[2]** are different, the maximum burst will greatly decrease (p.126).



When **[Rec. separately]** or **[Rec. to multiple]** is set, the image will be recorded under the same file number to both Card **[1]** and Card **[2]**. Also, the top LCD panel will display the number of possible shots of the card having the lower number. If one of the cards becomes full, **[Card* full]** will be displayed and shooting will be disabled. If this happens, either replace the card or set the recording method to **[Standard]** or **[Auto switch card]** and select the card with remaining space to continue shooting.

Selecting the Card for Recording and Playback with Two Cards Inserted

If [Record func.] is set to [Standard] or [Auto switch card], select the card for recording and playing images.

If [Record func.] is set to [Rec. separately] or [Rec. to multiple], select the card for playing images.

If [Standard] or [Auto switch card] is set:

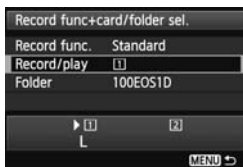

Select [Record/play].

- Turn the <⊙> dial to select [Record/play], then press <SET>.
 [1]: Record images to Card 1 and play images back from Card 1.
 [2]: Record images to Card 2 and play images back from Card 2.
- Turn the <⊙> dial to select the card, then press <SET>.

If [Rec. separately] or [Rec. to multiple] is set:

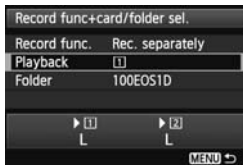

Select [Playback].

- Turn the <⊙> dial to select [Playback], then press <SET>.
 [1]: Play images back from Card 1.
 [2]: Play images back from Card 2.
- Turn the <⊙> dial to select the card, then press <SET>.

● Using the Rear LCD Panel to Select the Card

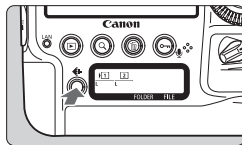

1 Press the <←> button. (⊙6)

2 Select the card.

- Turn the <☀> dial to select the card. The card marked with <▶> can be used for [Record/play] or [Playback].

Setting the Image-Recording Quality

You can set the image size (number of recorded pixels for JPEG/RAW) and JPEG quality (compression rate).

◀ Selecting the Image Size

L, **M1**, **M2**, or **S** will record the image as a JPEG image. With **RAW**, **M RAW**, or **S RAW**, use Digital Photo Professional (provided software, p.426) to process the image after shooting. **RAW** images can also be processed with the camera.

You can set the image size in one of the two ways below.

● Using the Rear LCD Panel to Select the Image Size

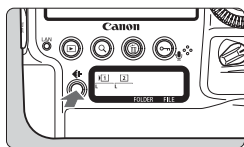

1 Press the <◀▶> button. (⓪6)

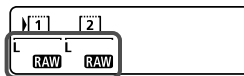

2 Select the desired image size.

- Turn the <◂◃> dial to select the image size.
- If **RAW/M RAW/S RAW** and **L/M1/M2/S** are displayed at the same time, the RAW and JPEG image will be recorded simultaneously on the card.
- Turn the <◂◃> dial to select the card to record or playback images (p.122).



- When [**Record func.**] is set to [**Rec. separately**] (p.121), turn the <◂◃> dial to select a card and set the image size for the respective card.
- In this manual, the image size and JPEG quality (compression rate, p.129) are commonly referred to as the image-recording quality.

● Using the Menu Screen to Set the Image Size

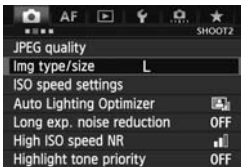

1 Select [Img type/size].

- Under the [2] tab, select [Img type/size], then press <SET>.

With [Standard / Auto switch card / Rec. to multiple] set:

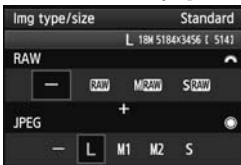

2 Set the image size.

- To select a RAW image size, turn the < > dial. To select a JPEG image size, turn the < > dial.
- On the screen, the “****M (megapixels) **** x ****” number indicates the recorded pixel count, and [****] is the number of possible shots (displayed up to 9999).
- Press <SET> to set it.

With [Rec. separately] set:

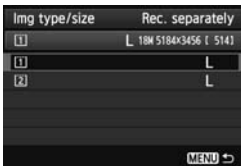

- Under [1: Record func+card/ folder sel.], if [Record func.] is set to [Rec. separately], turn the < > dial to select <[1]> or <[2]>, then press <SET>.

On the screen that appears, turn the < > dial to select the image size, then press <SET>.

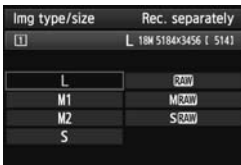
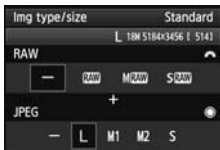
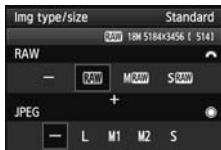

Image Size Setting Examples

L only



RAW only



RAW + L

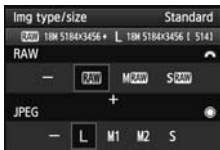

S RAW + M2

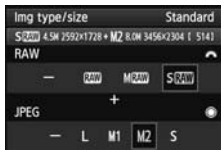

- If [-] is set for both RAW and JPEG, **L** will be set.
- The number of possible shots will be displayed up to 1999 on the top LCD panel and in the viewfinder.

Guide to Image Size Settings (Approx.)

Image Size	Pixels Recorded (megapixels)	Printing Size	File Size (MB)	Possible Shots	Maximum Burst
L	18M	Around A2	6.0	1200	100 (180)
M1	14M	A3 or larger	4.8	1470	150 (310)
M2	8.0M	Around A3	3.3	2170	290 (1390)
S	4.5M	Around A4	2.1	3290	1190 (6430)
RAW	18M	Around A2	23.2	280	35 (38)
RAW + L	18M+18M	—	23.2+6.0	230	17 (17)
RAW + M1	18M+14M		23.2+4.8	240	17 (17)
RAW + M2	18M+8.0M		23.2+3.3	250	17 (17)
RAW + S	18M+4.5M		23.2+2.1	260	17 (17)
M RAW	10M	Around A3	18.3	350	26 (28)
M RAW + L	10M+18M	—	18.3+6.0	270	19 (19)
M RAW + M1	10M+14M		18.3+4.8	280	18 (18)
M RAW + M2	10M+8.0M		18.3+3.3	300	18 (18)
M RAW + S	10M+4.5M		18.3+2.1	320	19 (19)
S RAW	4.5M	Around A4	13.0	490	39 (41)
S RAW + L	4.5M+18M	—	13.0+6.0	340	19 (20)
S RAW + M1	4.5M+14M		13.0+4.8	360	19 (19)
S RAW + M2	4.5M+8.0M		13.0+3.3	400	19 (19)
S RAW + S	4.5M+4.5M		13.0+2.1	420	19 (20)

- The file size, possible shots, and maximum burst during continuous shooting are based on Canon's 8 GB testing card and Canon's testing standards (JPEG quality 8, ISO 100, and Standard Picture Style). **These figures will vary depending on the subject, card brand, ISO speed, Picture Style, Custom Functions, and other settings.**
- The maximum burst applies to  high-speed continuous shooting. Figures in parentheses apply to an Ultra DMA (UDMA) mode 7, 128 GB card based on Canon's testing standards.



- If you select both RAW and JPEG, the same image will be recorded simultaneously to the card in both RAW and JPEG at the image-recording quality that was set. The two images will be recorded with the same file number (file extension .JPG for JPEG and .CR2 for RAW).
- In accordance with the selected image size, the <JPEG> or <RAW> icon will be displayed on the right side in the viewfinder.
- The image size icons indicate the following: **RAW** (RAW), **M RAW** (Medium RAW), **S RAW** (Small RAW), JPEG, **L** (Large), **M1** (Medium 1), **M2** (Medium 2), **S** (Small).

About RAW

A RAW image is raw data output by the image sensor converted to digital data. The image data is recorded to the card as is, and you can select the quality as follows: **RAW**, **M RAW**, or **S RAW**.

A **RAW** image can be processed with [▶] **2: RAW image processing** (p.292) and saved as a JPEG image. (**M RAW** and **S RAW** images cannot be processed with the camera.) While the RAW image itself does not change, you can process the RAW image according to different processing conditions to create any number of JPEG images from it. With all RAW images, you can use Digital Photo Professional (provided software, p.426) to make various adjustments and then generate a JPEG, TIFF, etc., image incorporating those adjustments.



Commercially-available software may not be able to display RAW images. Using the provided software is recommended.

One-touch Image Quality Setting

Custom Controls let you assign image-recording quality to the <M-Fn> button, Multi-function button 2, or depth-of-field preview button with [**One-touch image quality setting**], so that you can temporarily switch image quality settings at the touch of a button before shooting. For details, see Custom Controls (p.343).

ⓘ If [**1: Record func+card/folder sel.**] is set to [**Rec. separately**], you cannot switch to the One-touch image quality setting.

Maximum Burst During Continuous Shooting



The number of shots for the maximum burst is displayed on the right in the viewfinder. If the maximum burst for continuous shooting is 99 or higher, "99" will be displayed.

ⓘ The maximum burst is displayed even when a card is not inserted in the camera. Make sure that a card is inserted before taking a picture.

- If the viewfinder displays "99" for the maximum burst, it means the maximum burst is 99 or higher. If the maximum burst decreases to 98 or lower and the internal buffer memory becomes full, "buSY" will be displayed in the viewfinder and on the top LCD panel. Shooting will then be disabled temporarily. If you stop continuous shooting, the maximum burst will increase. After all the captured images are written to the card, the maximum burst will be as listed on page 126.
- The maximum burst indicator in the viewfinder will not change even when you use a UDMA CF card. However, the maximum burst shown in parentheses on page 126 will apply.

MENU Setting the JPEG Quality (Compression Rate)

For JPEG images, the recording quality (compression rate) can be set separately for each image size: **L**, **M1**, **M2**, and **S**.

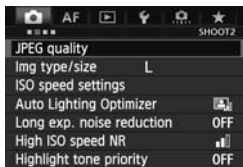
**1** Select [JPEG quality].

- Under the [CAMERA] tab, select [JPEG quality], then press <SET>.

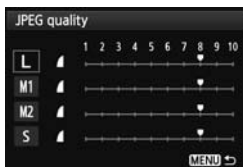
**2** Select the desired image size.

- Turn the <DIAL> dial to select the image size, then press <SET>.

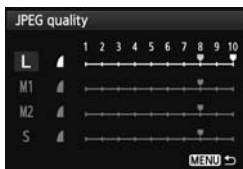
**3** Set the desired quality (compression rate).

- Turn the <DIAL> dial to select the setting, then press <SET>.
- The higher the number, the higher the quality will be (lower compression).
- For 6 - 10, <▲> is displayed. For 1 - 5, <▼> is displayed.

 The higher the recording quality, the fewer the number of possible shots will be. On the other hand, the lower the recording quality, the higher the number of possible shots will be.

ISO: Setting the ISO Speed

Set the ISO speed (image sensor's sensitivity to light) to suit the ambient light level. Regarding the ISO speed during movie shooting, see pages 230 and 232.

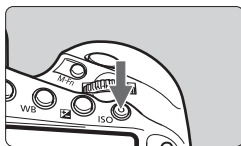

1 Press the <ISO> button. (ⓘ6)

2 Set the ISO speed.

- While looking at the top LCD panel or in the viewfinder, turn the <⚙> or <⦿> dial.
- ISO speed can be set within ISO 100 - 51200 in 1/3-stop increments.
- "A" indicates ISO Auto. The ISO speed will be set automatically (p.131).

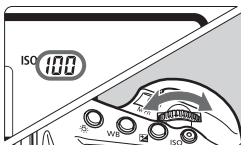



ISO Speed Guide

ISO Speed	Shooting Situation (No flash)	Flash Range
L, 100 - 400	Sunny outdoors	The higher the ISO speed, the farther the flash range will extend.
400 - 1600	Overcast skies or evening time	
1600 - 51200, H1, H2	Dark indoors or night	

* Higher ISO speeds will result in grainier images.

- If [**2: Highlight tone priority**] is set to [**Enable**], you cannot select "L" (equivalent to ISO 50), ISO 100/125/160, "H1" (equivalent to ISO 102400), and "H2" (equivalent to ISO 204800) (p.156).
- Shooting in high temperatures may result in images that look grainier. Long exposures can also cause irregular colors in the image.
- When you shoot at high ISO speeds, noise (such as dots of light and banding) may become noticeable.
- Shooting long exposures at high ISO speeds may result in irregular colors in the image.
- When shooting in conditions that produce an extreme amount of noise, such as a combination of high ISO speed, high temperature and long exposure, images may not be recorded properly.

- As H1 (equivalent to ISO 102400) and H2 (equivalent to ISO 204800) are expanded ISO speed settings, noise (such as dots of light and banding) and irregular colors will be more noticeable, and the resolution will be lower than usual.
- If you use a high ISO speed and flash to shoot a close subject, overexposure may result.
- If **[ISO speed range]** is set to **[Maximum: 51200]** and you shoot a movie while ISO 32000/40000/51200 is set, the ISO speed will switch to ISO 25600 (during manual-exposure movie shooting). Even if you switch to still photo shooting, the ISO speed will not switch back to the previous ISO speed.
- If L (equivalent to ISO 50) is set and you shoot a movie, the ISO speed will switch to ISO 100 (during manual-exposure movie shooting). Even if you switch to still photo shooting, the ISO speed will not switch back to L.
- If ISO 32000 or higher (when the camera's internal temperature is low, ISO 20000 or higher) is set, the maximum continuous shooting speed with H> will be approx. 10 shots/sec.

 Under **[2: ISO speed settings]**, you can use **[ISO speed range]** to expand the settable ISO speed range from equivalent to ISO 50 (L) to equivalent to ISO 204800 (H2) (p.132).

ISO Auto

If the ISO speed is set to “A” (Auto), the actual ISO speed to be set will be displayed when you press the shutter button halfway. As indicated below, the ISO speed will be set automatically to suit the shooting mode.

Shooting Mode	ISO Speed Setting
P/Tv/Av/M	Automatically set within ISO 100 - 51200*1
Bulb	Fixed at ISO 400*1
With flash	Fixed at ISO 400*1*2*3

*1: The actual ISO speed range depends on the **[Minimum]** and **[Maximum]** settings set in **[Auto ISO range]**.

*2: If fill flash results in overexposure, ISO 100 or a higher ISO will be set.

*3: When using bounce flash with an external Speedlite in the <P> mode, the ISO speed will be set automatically within ISO 400 - 1600.

- If **[Auto ISO range]**'s **[Maximum]** is set to **[51200]** (p.133) and ISO 32000 or higher (when the camera's internal temperature is low, ISO 20000 or higher) is set automatically, the maximum continuous shooting speed with H> will be approx. 10 shots/sec.

MENU Setting the ISO Speed Range

You can set the manually-settable ISO speed range (minimum and maximum limits). You can set the minimum limit within L (ISO 50) to H1 (ISO 102400), and the maximum limit within ISO 100 to H2 (ISO 204800).

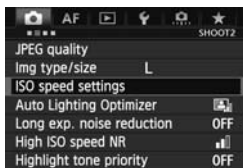
**1** Select [ISO speed settings].

- Under the [2] tab, select [ISO speed settings], then press <SET>.

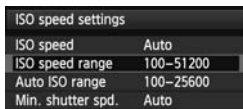
**2** Select [ISO speed range].

- Select [ISO speed range], then press <SET>.

**3** Set the minimum limit.

- Select the [Minimum] list box, then press <SET>.
- Turn the <DIAL> dial to select the minimum ISO speed limit, then press <SET>.

**4** Set the maximum limit.

- Select the [Maximum] list box, then press <SET>.
- Turn the <DIAL> dial to select the maximum ISO speed limit, then press <SET>.

5 Exit the setting.

- Turn the <DIAL> dial to select [OK], then press <SET>.
- ▶ The menu reappears.

MENU Setting the ISO Speed Range for Auto ISO

You can set the ISO speed range for Auto ISO within ISO 100 - 51200. You can set the minimum limit within ISO 100 - 25600, and the maximum limit within ISO 200 - 51200 in whole-stop increments.

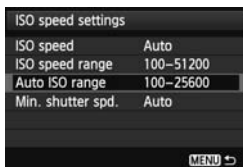
**1** Select **[Auto ISO range]**.

- Select **[Auto ISO range]**, then press **<SET>**.

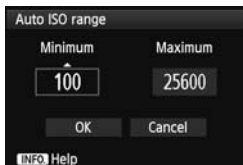
**2** Set the minimum limit.

- Select the **[Minimum]** list box, then press **<SET>**.
- Turn the **<DISP>** dial to select the minimum ISO speed limit, then press **<SET>**.

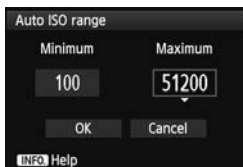
**3** Set the maximum limit.

- Select the **[Maximum]** list box, then press **<SET>**.
- Turn the **<DISP>** dial to select the maximum ISO speed limit, then press **<SET>**.

4 Exit the setting.

- Turn the **<DISP>** dial to select **[OK]**, then press **<SET>**.
- ▶ The menu reappears.



The **[Minimum]** and **[Maximum]** settings will also apply to the ISO speed safety shift's minimum and maximum ISO speed (p.329).

MENU Setting the Minimum Shutter Speed for Auto ISO

When Auto ISO is set, you can set the minimum shutter speed (1/8000 sec. to 1 sec.) so that the automatically-set shutter speed is not too slow.

This is convenient in the <P> and <Av> modes when you use a wide-angle lens to shoot a moving subject or when you use a telephoto lens. It helps to reduce camera shake and subjects' blur.

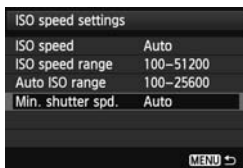
**1** Select [Min. shutter spd.].

- Select [Min. shutter spd.], then press <SET>.

**2** Set the desired minimum shutter speed.

- Turn the <DISP> dial to select the shutter speed, then press <SET>.
- ▶ The menu reappears.

- If a correct exposure cannot be obtained with the maximum ISO speed limit set in [Auto ISO range], a shutter speed slower than the [Min. shutter spd.] will be set to obtain a standard exposure.
- This function does not work with flash shooting.

MENU Selecting a Picture Style

By selecting a Picture Style, you can obtain image characteristics matching your photographic expression or the subject.



1 Select [Picture Style].

- Under [1], select [Picture Style], then press <SET>.
- ▶ The Picture Style selection screen will appear.



2 Select a Picture Style.

- Turn the < > dial to select the desired Picture Style, then press <SET>.
- ▶ The Picture Style will be set and the menu will reappear.

Picture Style Characteristics

Auto

The color tone will be adjusted automatically to suit the scene. The colors will look vivid, especially for blue skies, greenery, and sunsets in nature, outdoor, and sunset scenes.

Standard

The image looks vivid, sharp, and crisp. This is a general-purpose Picture Style suitable for most scenes.

Portrait

For nice skin tones. The image looks softer. Suited for close-up portraits.

By changing the [Color tone] (p.138), you can adjust the skin tone.



If the desired color tone is not obtained with [Auto], use another Picture Style.

 **Landscape**

For vivid blues and greens, and very sharp and crisp images. Effective for impressive landscapes.

 **Neutral**

This Picture Style is for users who prefer to process images with their computer. For natural colors and subdued images.

 **Faithful**

This Picture Style is for users who prefer to process images with their computer. When the subject is captured under a daylight color temperature of 5200K, the color is adjusted colorimetrically to match the subject's color. Images will appear dull and subdued.

 **Monochrome**

Creates black-and-white images.

 Black-and-white images shot in JPEG cannot be reverted to color. If you want to later shoot pictures in color, make sure the **[Monochrome]** setting has been canceled. When **[Monochrome]** is selected, <B/W> will appear on the top LCD panel.

 **User Def. 1-3**







You can register a basic style such as **[Portrait]**, **[Landscape]**, a Picture Style file, etc., and adjust it as desired (p.141). Any User Defined Picture Style that has not been set will have the same settings as the **[Standard]** Picture Style.

About the Symbols

The symbols of the Picture Style selection screen refer to parameters such as [**Sharpness**] and [**Contrast**]. The numerals indicate the parameter settings, such as [**Sharpness**] and [**Contrast**], for each Picture Style.



Symbols

	Sharpness
	Contrast
	Saturation
	Color tone
	Filter effect (Monochrome)
	Toning effect (Monochrome)

MENU Customizing a Picture Style

You can customize a Picture Style by adjusting individual parameters such as **[Sharpness]** and **[Contrast]**. To see the resulting effects, take test shots. To customize **[Monochrome]**, see page 140.



1 Select [Picture Style].

- Under **[01]**, select **[Picture Style]**, then press **<SET>**.
- ▶ The Picture Style selection screen will appear.



2 Select a Picture Style.

- Turn the **<DISP>** dial to select the desired Picture Style, then press **<INFO.>**.



3 Select a parameter.

- Turn the **<DISP>** dial to select a parameter such as **[Sharpness]**, then press **<SET>**.

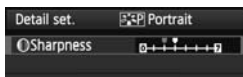

4 Set the parameter.

- Turn the <DIAL> dial to set the parameter as desired, then press <SET>.
- Press the <MENU> button to save the adjusted parameters. The Picture Style selection screen will reappear.
 - ▶ Any settings different from the default will be displayed in blue.

Parameter Settings and Effects

Sharpness	0: Less sharp outline	+7: Sharp outline
Contrast	-4: Low contrast	+4: High contrast
Saturation	-4: Low saturation	+4: High saturation
Color tone	-4: Reddish skin tone	+4: Yellowish skin tone



- By selecting [**Default set.**] in step 3, you can revert the respective Picture Style to its default parameter settings.
- To use the adjusted Picture Style, first select the adjusted Picture Style, then shoot.

Monochrome Adjustment

For Monochrome, you can also set **[Filter effect]** and **[Toning effect]** in addition to **[Sharpness]** and **[Contrast]** explained on the preceding page.

Filter Effect

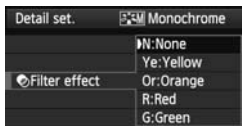

With a filter effect applied to a monochrome image, you can make white clouds or green trees stand out more.

Filter	Sample Effects
N : None	Normal black-and-white image with no filter effects.
Ye: Yellow	The blue sky will look more natural, and the white clouds will look crisper.
Or: Orange	The blue sky will look slightly darker. The sunset will look more brilliant.
R : Red	The blue sky will look quite dark. Fall leaves will look crisper and brighter.
G : Green	Skin tones and lips will appear muted. Tree leaves will look crisper and brighter.

 Increasing the **[Contrast]** will make the filter effect more pronounced.

Toning Effect

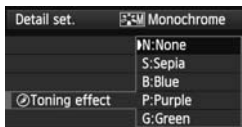

By applying a toning effect, you can create a monochrome image in that color. It can make the image look more impressive.

The following can be selected: **[N:None]**, **[S:Sepia]**, **[B:Blue]**, **[P:Purple]** or **[G:Green]**.

MENU Registering a Picture Style

You can select a base Picture Style such as [Portrait] or [Landscape], adjust its parameters as desired and register it under [User Def. 1], [User Def. 2], or [User Def. 3].

You can create Picture Styles whose parameter settings such as sharpness and contrast are different.

You can also adjust the parameters of a Picture Style that has been registered to the camera with EOS Utility (provided software, p.426).



1 Select [Picture Style].

- Under [**1**], select [Picture Style], then press <SET>.
- ▶ The Picture Style selection screen will appear.



2 Select [User Def. *].

- Turn the <DIAL> dial to select a [User Def. *] style, then press <INFO.>.



3 Press <SET>.

- With [Picture Style] selected, press <SET>.

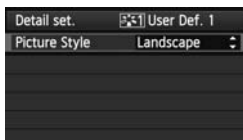

4 Select the base Picture Style.

- Turn the <DIAL> dial to select the base Picture Style, then press <SET>.
- To adjust the parameters of a Picture Style that has been registered to the camera with EOS Utility (provided software), select the Picture Style here.



5 Select a parameter.

- Turn the < > dial to select a parameter such as [**Sharpness**], then press < >.

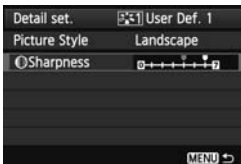

6 Set the parameter.

- Turn the < > dial to set the parameter as desired, then press < >.

For details, see “Customizing a Picture Style” on pages 138-140.

- Press the <MENU> button to register the modified Picture Style. The Picture Style selection screen will then reappear.
 - ▶ The base Picture Style will be indicated on the right of [**User Def. ***].
 - ▶ If the settings in a Picture Style registered under [**User Def. ***] have been modified from the base Picture Style settings, the Picture Style's name will be displayed in blue.



- If a Picture Style has already been registered under [**User Def. ***], changing the base Picture Style in step 4 will nullify the parameter settings of the registered Picture Style.
- If you execute [**Clear all camera settings**] (p.58), all the [**User Def. ***] settings will revert to their defaults. Picture Styles registered via EOS Utility (provided software) will have only their modified parameters reverted to their default settings.

- To use an adjusted Picture Style, select the registered [**User Def. ***], then shoot.
- Regarding the procedure to register a Picture Style file to the camera, refer to the EOS Utility Instruction Manual (p.428).

WB: Setting the White Balance

White balance (WB) is for making the white areas look white. Normally, the **<AWB>** (Auto) setting will obtain the correct white balance. If natural-looking colors cannot be obtained with **<AWB>**, you can select the white balance that matches the light source or set it manually by shooting a white object.

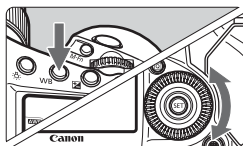

1 Press the **<WB>** button. (ⓘ6)

2 Select the white balance.

- While looking at the top LCD panel, turn the **<☉>** dial.



Display	Mode	Color Temperature (Approx. K: Kelvins)
AWB	Auto	3000 - 7000
☀	Daylight	5200
🏠	Shade	7000
☁	Cloudy, twilight, sunset	6000
💡	Tungsten light	3200
💡	White fluorescent light	4000
⚡	Flash use	Automatically set*
👤	Custom (p.144)	2000 - 10000
K	Color temperature (p.149)	2500 - 10000

* Applicable with Speedlites having a color temperature transmission function. Otherwise, it will be fixed to approx. 6000K.

About White Balance

To the human eye, a white object looks white regardless of the type of lighting. With a digital camera, the color temperature is adjusted with software to make the white areas look white. This adjustment serves as the basis for the color correction. The result is natural-looking colors in the pictures.



- You can also set the white balance under [**☷ 1: White balance**].
- To set a Personal WB, select [**PC-***]. Refer to the EOS Utility Instruction Manual for the procedure to register a Personal WB.

☑ Custom White Balance

Custom white balance enables you to manually set the white balance for a specific light source for better accuracy. Perform this procedure under the actual light source to be used.

Up to five sets of Custom white balance data can be registered to the camera. You can also append a name (caption) to the registered Custom white balance data.

MENU Registering Custom WB

There are two ways to register Custom white balance data. You can either take a picture and register it, or register an image already saved in the card.

● Record and register WB



1 Select [Set Custom WB].

- Under the [📷1] tab, select [Set Custom WB], then press <Ⓢ>.



2 Select the Custom WB number to be registered.

- Press <Ⓢ>.
- Turn the <⦿> dial to select 1 to 5 for <☑*>, then press <Ⓢ>. The Custom WB data will be registered under the selected number.

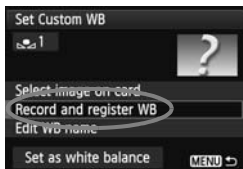

3 Select [Record and register WB].

- Turn the <⦿> dial to select [Record and register WB], then press <Ⓢ>.
- ▶ The LCD monitor will turn off, and the selected number [*] will blink on the top LCD panel.

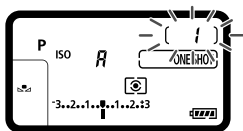

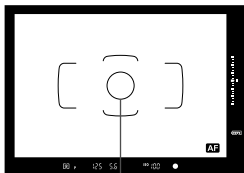

Spot metering circle

4 Photograph a solid-white object.

- The plain, white object should fill the spot metering circle.
- Focus manually and set the standard exposure for the white object.
- Any white balance setting can be set.



- ▶ The Custom WB data will be registered.
- To use the Custom WB, see “Selecting and Shooting with the Custom WB Data” (p.147).



- Custom WB data can also be registered as follows:
 1. Press the <WB> button and turn the <WB> dial to select <WB> (p.143).
 2. Then turn the <WB> dial to select the number under which the Custom WB is to be registered.
 3. Press the <WB> button.
→ [*] will blink on the top LCD panel.
 4. Follow step 4 above to photograph a solid-white object.
→ The Custom WB data will be registered under the selected number. When a picture is taken, the registered Custom white balance will be applied.
- If the exposure of the picture differs greatly from the standard exposure, a correct white balance might not be obtained. If [**Correct WB may not be obtained with the selected image**] is displayed in step 4, go back to step 1 and try again.
- The image captured in step 4 will not be recorded to the card.
- Instead of a white object, an 18% gray card can produce a more accurate white balance.

● **Select image on card**

First follow step 4 under “Record and register WB” (p.144) to take a picture of a plain, white object. This image saved in the card can then be registered for Custom WB. The procedure up to step 2 is the same as in “Record and register WB.”

1 Select [Set Custom WB].

2 Select the Custom WB number to be registered.

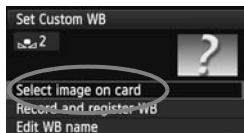

3 Select [Select image on card].

- Turn the <DISP> dial to select [Select image on card], then press <SET>.
- ▶ The images saved in the card will be displayed.

4 Select the image to be used for registering the Custom WB data.



- Turn the <DISP> dial to select the image to be registered for the Custom WB data, then press <SET>.

5 Select [OK].

- Turn the <DISP> dial to select [OK], then press <SET>.
- ▶ The Custom WB data will be registered. When the message appears, press <SET> to return to step 3.

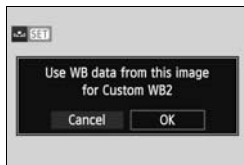

❗ In step 4, the following images cannot be selected: images captured while the Picture Style was set to [Monochrome], multiple-exposure images, and images taken with another camera.

📷 To shoot with the registered Custom WB, first select the registered Custom WB number, then shoot (p.147).

MENU Selecting and Shooting with the Custom WB Data

Registered image

**1** Select the Custom WB Number.

- On the Custom WB registration screen, select the number of the registered Custom WB.

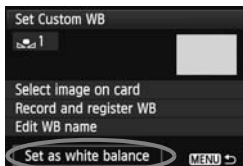
**2** Select [Set as white balance].

- Turn the <DIAL> dial to select [Set as white balance], then press <SET>.
- ▶ The WB will be set to the registered <WB>*.

3 Take the picture.

- ▶ The picture will be taken with the <WB>* setting.



You can also select the Custom WB number while looking at the top LCD panel. Press the <WB> button and turn the <DIAL> dial to select <WB>. Then turn the <DIAL> dial to select the registered Custom WB number.

MENU Naming the Custom WB Data

You can also append a name (caption) to the registered Custom white balance data.

**1** Select the Custom WB Number.

- On the Custom WB data registration screen, select the Custom WB number to be appended with a name.

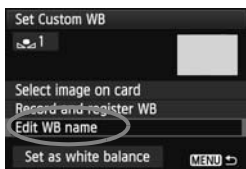

2 Select [Edit WB name].

- Turn the <◉> dial to select [Edit WB name], then press <SET>.

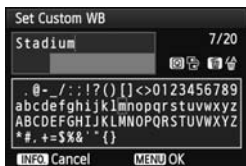

3 Enter text.

- Press the <Q> button, and the text palette will be highlighted in a color frame. Text can be entered.
- Operate the <◉/☀> dial or <☼> to move the and select the desired character. Then press <SET> to enter it.
- You can enter up to 20 characters.
- To delete a character, press the <🗑> button.



4 Exit the setting.

- After entering the text, press the <MENU> button.
- ▶ The name will be saved and the screen will return to step 2. The entered name will be displayed below <📷*>.

It is often convenient to name the Custom WB after the location or light source it is for.

K Setting the Color Temperature

You can set the white balance's color temperature numerically in Kelvins. This function is for advanced users.

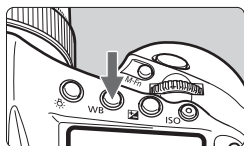

1 Press the **<WB>** button. (Ⓜ6)



2 Select **<K>**.

- Look at the top LCD panel and turn the **<☀>** dial to select **<K>**.



3 Set the color temperature.

- Turn the **<☀>** dial to set the color temperature.
- The color temperature can be set from 2500K to 10000K in 100K increments.

- When setting the color temperature for an artificial light source, set white balance correction (magenta or green) as necessary.
- If you set **<K>** according to the reading taken with a commercially-available color temperature meter, take test shots and adjust the setting to compensate for the difference between the color temperature meter's reading and the camera's color temperature reading.

 You can also set the color temperature under [**1**: White balance].

WB +/- White Balance Correction

You can correct the white balance that has been set. This adjustment will have the same effect as using a commercially-available color temperature conversion filter or color compensating filter. Each color can be corrected to one of nine levels.

This function is for advanced users who are familiar with using color temperature conversion or color compensating filters.

White Balance Correction



1 Select [WB Shift/Bkt.].

- Under the [📷1] tab, select [WB Shift/Bkt.], then press <SET>.

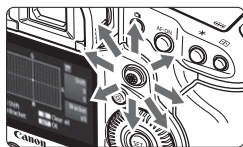

2 Set the white balance correction.

- Use <⬅➡> to move the "■" mark to the desired position.
- B is for blue, A for amber, M for magenta, and G for green. The color in the respective direction will be corrected.
- On the upper right, "Shift" indicates the direction and correction amount.
- Pressing the <🗑> button will cancel all the [WB Shift/Bkt.] settings.
- Press <SET> to exit the setting and return to the menu.

Sample setting: A2, G1

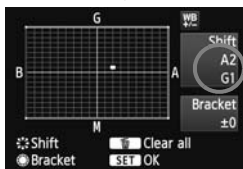

- When the white balance is corrected, <WB +/-> will be displayed in the viewfinder and on the top LCD panel.
- One level of the blue/amber correction is equivalent to approx. 5 mireds of a color temperature conversion filter. (Mired: Measuring unit indicating the density of a color temperature conversion filter.)

White Balance Auto Bracketing

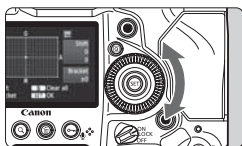

With just one shot, three images having a different color balance can be recorded simultaneously. Based on the color temperature of the current white balance setting, the image will be bracketed with a blue/amber bias or magenta/green bias. This is called white balance bracketing (WB-BKT). White balance bracketing is possible up to ± 3 levels in single-level increments.

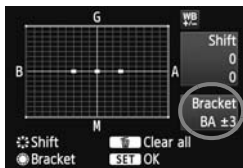

B/A bias ± 3 levels



Set the white balance bracketing amount.

- In step 2 for white balance correction, when you turn the  dial, the "■" mark on the screen will change to "■■■" (3 points). Turning the dial to the right sets the B/A bracketing, and turning it to the left sets the M/G bracketing.
- ▶ On the right, "**Bracket**" indicates the bracketing direction and correction amount.
- Pressing the  button will cancel all the [WB Shift/Bkt.] settings.
- Press  to exit the setting and return to the menu.

Bracketing Sequence

The images will be bracketed in the following sequence: 1. Standard white balance, 2. Blue (B) bias, and 3. Amber (A) bias, or 1. Standard white balance, 2. Magenta (M) bias, and 3. Green (G) bias.



- During WB bracketing, the maximum burst for continuous shooting will be lower and the number of possible shots will also decrease to approx. one-third the normal number.
- You can also set white balance correction and AEB together with white balance bracketing. If you set AEB in combination with white balance bracketing, a total of nine images will be recorded for a single shot.
- Since three images are recorded for one shot, the card will take longer to record the shot.
- When white balance bracketing is set, the white balance icon will blink.
- You can change the number of shots for white balance bracketing (p.327).
- "BKT" stands for bracketing.

MENU Correcting the Brightness and Contrast Automatically

If the image comes out dark or the contrast is low, the brightness and contrast can be corrected automatically. This function is called Auto Lighting Optimizer. The default setting is **[Standard]**. With JPEG images, the correction is applied when the image is captured.

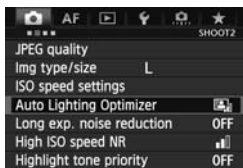

1 Select **[Auto Lighting Optimizer]**.

- Under the [**2**] tab, select **[Auto Lighting Optimizer]**, then press **<SET>**.



2 Select the setting.

- Turn the **<DISP>** dial to select the desired setting, then press **<SET>**.

3 Take the picture.

- The image will be recorded with the brightness and contrast corrected if necessary.

- If [**2: Highlight tone priority**] is set to **[Enable]**, the Auto Lighting Optimizer will be set automatically to **[Disable]** and the setting cannot be changed.
- Depending on the shooting conditions, noise may increase.
- If a setting other than **[Disable]** is set and you use exposure compensation or flash exposure compensation to darken the exposure, the image may still come out bright. If you want a darker exposure, set this function to **[Disable]**.
- If multiple exposure shooting (p.186) is set, the Auto Lighting Optimizer will be set automatically to **[Disable]**. When the multiple exposure shooting is canceled, the Auto Lighting Optimizer will revert to the original setting.

 In step 2, if you press the **<INFO>** button and uncheck **<✓>** the **[Disable during man expo]** setting, the Auto Lighting Optimizer can be set in the **<M>** mode.

MENU Noise Reduction Settings

High ISO Speed Noise Reduction

This function reduces the noise generated in the image. Although noise reduction is applied at all ISO speeds, it is particularly effective at high ISO speeds. At low ISO speeds, the noise in darker parts of the image is further reduced.

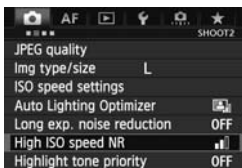

1 Select [High ISO speed NR].

- Under the [CAMERA 2] tab, select [High ISO speed NR], then press <SET>.

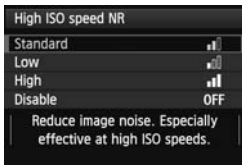

2 Set the desired setting.

- Turn the <DIAL> dial to select the desired noise reduction setting, then press <SET>.
- ▶ The setting screen closes and the menu will reappear.

3 Take the picture.

- The image will be recorded with noise reduction applied.



If you play back a **RAW** image with the camera, the effect of the high ISO speed noise reduction may look minimal. Check the noise reduction effect with Digital Photo Professional (provided software, p.426).

Long Exposure Noise Reduction

Noise reduction is possible with images exposed for 1 sec. or longer.

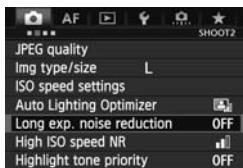

1 Select [Long exp. noise reduction].

- Under the [📷2] tab, select [**Long exp. noise reduction**], then press <SET>.

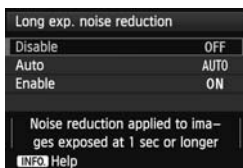

2 Set the desired setting.

- Turn the <☉> dial to select the desired setting, then press <SET>.
- ▶ The setting screen closes and the menu will reappear.

● [Auto]

For 1 sec. or longer exposures, noise reduction is performed automatically if noise typical of long exposures is detected. This [**Auto**] setting is effective in most cases.

● [Enable]

Noise reduction is performed for all exposures of 1 sec. or longer. The [**Enable**] setting may be able to reduce noise that otherwise cannot be detected with the [**Auto**] setting.

3 Take the picture.

- The image will be recorded with noise reduction applied.



- With **[Auto]** and **[Enable]**, after the picture is taken, the noise reduction process may take the same amount of time as the exposure. During noise reduction, shooting is still possible as long as the maximum burst indicator in the viewfinder shows “1” or higher.
- Images taken at ISO 1600 or higher may look grainier with the **[Enable]** setting than with the **[Disable]** or **[Auto]** settings.
- With **[Enable]**, if a long exposure is shot with the Live View image displayed, “**BUSY**” will be displayed during the noise reduction process. The Live View display will not appear until the noise reduction is completed. (You cannot take another picture.)

MENU Highlight Tone Priority

You can minimize overexposed highlight areas.

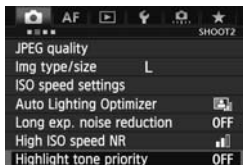

1 Select [Highlight tone priority].

- Under the [2] tab, select [Highlight tone priority], then press <SET>.



2 Select [Enable].

- Turn the <DIAL> dial to select [Enable], then press <SET>.
- Highlight details are improved. The dynamic range is expanded from the standard 18% gray to bright highlights. The gradation between the grays and highlights becomes smoother.

3 Take the picture.

- The image will be recorded with highlight tone priority applied.

- With [Enable], the Auto Lighting Optimizer (p.152) is automatically set to [Disable] and the setting cannot be changed. When [Highlight tone priority] is set to [Disable], the Auto Lighting Optimizer will revert to its original setting.
- With [Enable], image noise may increase slightly more than with [Disable].

- With [Enable], the settable range will be ISO 200 - 51200 (ISO 200 - 25600 for movie shooting). Also, the <D+> icon will be displayed in the viewfinder and on the top LCD panel when highlight tone priority is enabled.

MENU Lens Peripheral Illumination / Chromatic Aberration Correction

Peripheral light fall-off occurs in lenses whose characteristics make the image corners look darker. Color fringing along subject outlines is another chromatic aberration. Both lens aberrations can be corrected. The default setting is **[Enable]** for both corrections.

Peripheral Illumination Correction



1 Select **[Lens aberration correction]**.

- Under the [**1**] tab, select **[Lens aberration correction]**, then press **<SET>**.

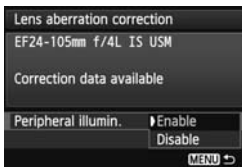

2 Select the setting.

- Check that **[Correction data available]** is displayed for the attached lens.
- Turn the **<DISP>** dial to select **[Peripheral illumin.]**, then press **<SET>**.
- Select **[Enable]**, then press **<SET>**.
- If **[Correction data not available]** is displayed, see “About the Lens Correction Data” on page 159.

3 Take the picture.

- The image will be recorded with the peripheral illumination corrected.



Depending on shooting conditions, noise may appear on the image periphery.



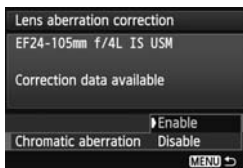

- The correction amount applied will be slightly lower than the maximum correction amount settable with Digital Photo Professional (provided software, p.426).
- The higher the ISO speed, the lower the correction amount will be.

Chromatic Aberration Correction



1 Select the setting.

- Check that [**Correction data available**] is displayed for the attached lens.
- Turn the <  > dial to select [**Chromatic aberration**], then press <  >.
- Select [**Enable**], then press <  >.
- If [**Correction data not available**] is displayed, see “About the Lens Correction Data” on the next page.

2 Take the picture.

- The image will be recorded with the chromatic aberration corrected.

 If you play back a **RAW** image shot with the chromatic aberration corrected, the image will be displayed on the camera without the chromatic aberration correction applied. Check the chromatic aberration correction with Digital Photo Professional (provided software, p.426).

About the Lens Correction Data

The camera already contains lens peripheral illumination correction data and chromatic aberration correction data for approx. 25 lenses. If you select [**Enable**], the peripheral illumination correction and chromatic aberration correction will be applied automatically for any lens whose correction data is registered in the camera.

With EOS Utility (provided software), you can check which lenses have their correction data registered in the camera. You can also register the correction data for unregistered lenses. For details, refer to the Software Instruction Manual (CD-ROM) for EOS Utility (p.428).

Notes for Peripheral Illumination Correction and Chromatic Aberration Correction



- Corrections cannot be applied afterwards to JPEG images captured when [**Disable**] was set.
- When using a non-Canon lens, setting the corrections to [**Disable**] is recommended, even if [**Correction data available**] is displayed.
- If you use the magnified view during Live View shooting, the peripheral illumination correction and chromatic aberration correction will not be reflected in the image.



- If the effect of the correction is not so visible, magnify the image and check it.
- The corrections are also applied when an Extender is attached.
- If the correction data for the attached lens is not registered to the camera, the result will be the same as when the correction is set to [**Disable**].
- If the lens does not have distance information, the correction amount will be lower.

MENU Creating and Selecting a Folder

You can freely create and select the folder where the captured images are to be saved.

This operation is optional since a folder will be created automatically for saving captured images.

Creating a Folder

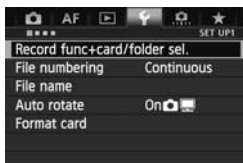

1 Select [Record func+card/folder sel.].

- Under the [**1**] tab, select [**Record func+card/folder sel.**], then press <SET>.

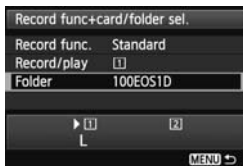

2 Select [Folder].

- Turn the <DIAL> dial to select [**Folder**], then press <SET>.

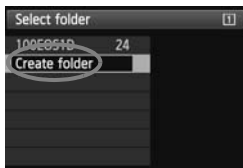

3 Select [Create folder].

- Turn the <DIAL> dial to select [**Create folder**], then press <SET>.

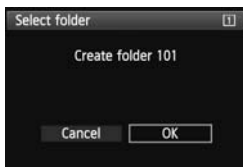

4 Create a new folder.

- Turn the <DIAL> dial to select [**OK**], then press <SET>.
- ▶ A new folder with the folder number increased by one is created.

Selecting a Folder

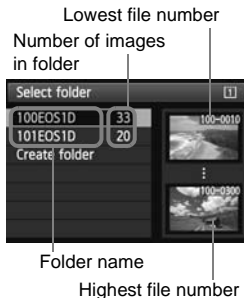

- With the folder selection screen displayed, turn the <⊙> dial to select the desired folder, then press <SET>.
- ▶ The folder where the captured images will be saved is selected.
- Subsequent captured images will be recorded into the selected folder.

About Folders

As with “100EOS1D” for example, the folder name starts with three digits (the folder number) followed by five alphanumeric characters. A folder can contain up to 9999 images (file number 0001 - 9999). When a folder becomes full, a new folder with the folder number increased by one is created automatically. Also, if manual reset (p.165) is executed, a new folder will be created automatically. Folders numbered from 100 to 999 can be created.

Creating Folders with a Personal Computer

With the card open on the screen, create a new folder named “DCIM”. Open the DCIM folder and create as many folders as necessary to save and organize your images. The folder name must follow the format “100ABC_D”. The first three digits are the folder number, from 100 to 999. The final five characters can be any combination of upper- and lower-case letters from A to Z, numerals, and the underscore “_”. The space cannot be used. Also note that two folder names cannot share the same three-digit folder number (for example, “100ABC_D” and “100W_XYZ”), even if the other five characters in each name are different.

MENU Changing the File Name

The file name has four alphanumeric characters followed by a four-digit image number (p.164) and extension. The first four alphanumeric characters are set upon factory shipment and unique to the camera. However, you can change them.

With “User setting1”, you can change and register the four characters as desired. With “User setting2”, if you register three characters, the fourth character from the left will be appended automatically to indicate the image size.

Registering or Changing the File Name

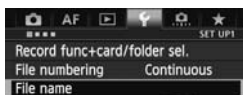

1 Select [File name].

- Under the [**1**] tab, select [**File name**], then press <SET>.

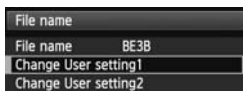

2 Select [Change User setting*].

- Turn the <DIAL> dial to select a [**Change User setting***] option, then press <SET>.

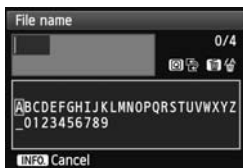

3 Enter any alphanumeric characters.

- For User setting1, enter four characters. For User setting2, enter three characters.
- Press the <DELETE> button to delete any unnecessary characters.
- Press the <Q> button, and the text palette will be highlighted in a color frame. Text can be entered.
- Operate the <DIAL> dial or <DIRECTIONAL KEYS> to move the cursor and select the desired character. Then press <SET> to enter it.



4 Exit the setting.

- Enter the required number of alphanumeric characters, then press the <MENU> button.
- ▶ The new file name will be registered and the screen in step 2 will reappear.



Settings

5 Select the registered file name.

- Turn the <DIAL> dial to select [File name], then press <SET>.
- Turn the <DIAL> dial to select the registered file name, then press <SET>.
- If User setting2 has been registered, select "****" (the 3 characters registered) + image size".



About User setting2

When you select the "**** + image size" registered with User setting2 and take pictures, a character that indicates image-recording quality will be automatically appended as the file name's fourth character from the left. The meaning of the image size characters is as follows:

"*** L" = L, RAW

"*** M" = M1, M RAW

"*** N" = M2

"*** S" = S, S RAW

When the image is transferred to a personal computer, the automatically appended fourth character will be included. You can then see the image size without having to open the image. RAW or JPEG images can be distinguished with the extension.



The first character cannot be an underscore "_".



- The extension will be ".JPG" for JPEG images, ".CR2" for RAW images, and ".MOV" for movies.
- When you shoot a movie with User setting2, the file name's fourth character will be an underscore "_".

MENU File Numbering Methods

The four-digit file number is like the frame number on a roll of film. The captured images are assigned a sequential file number from 0001 to 9999 and saved in one folder. You can change how the file number is assigned. (Ex.) BE3B0001.JPG

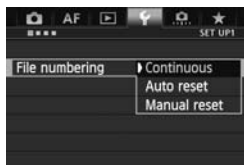

- 1 Select [File numbering].**
 - Under the [**1**] tab, select [**File numbering**], then press <[SET]>.
- 2 Select the file numbering method.**
 - Turn the <[DIAL]> dial to select the desired setting, then press <[SET]>.

Continuous

Continues the file numbering sequence even after the card is replaced or a new folder is created.

Even after you replace the card, create a folder, or switch the target card (such as [1] → [2]), the file numbering continues in sequence up to 9999 for the images saved. This is convenient when you want to save images numbered anywhere between 0001 to 9999 in multiple cards or folders into one folder in your personal computer.

If the replacement card or existing folder already contains images recorded previously, the file numbering of the new images may continue from the file numbering of the existing images in the card or folder. If you want to use continuous file numbering, you should use a newly-formatted card each time.

File numbering after replacing the card

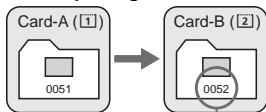

Next sequential file number

File numbering after creating a folder

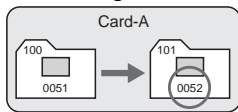

Auto Reset

The file numbering restarts from 0001 each time the card is replaced or a new folder is created.

When you replace the card, create a folder, or switch the target card (such as [1] → [2]), the file numbering restarts from 0001 for the new images saved. This is convenient if you want to organize images according to cards or folders.

However, if the replacement card or existing folder already contains images recorded previously, the file numbering of the new images may continue from the file numbering of the existing images in the card or folder. If you want to save images with the file numbering starting from 0001, use a newly formatted card each time.

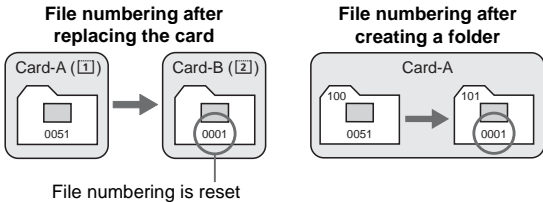

Manual Reset

To reset the file numbering to 0001 or to start from file number 0001 in a new folder.

When you reset the file numbering manually, a new folder is created automatically and the file numbering of images saved to that folder starts from 0001.

This is convenient if you want to use different folders for the images taken yesterday and the ones taken today, for example. After the manual reset, the file numbering returns to continuous or auto reset. (There will be no Manual reset confirmation screen.)



If the file number reaches 9999 in folder 999, shooting will not be possible even if the card still has storage capacity. A message explaining the need to replace the card will appear on the LCD monitor. Replace the card with a new one.

MENU Setting Copyright Information

When you set the copyright information, it will be recorded to the image as Exif information.

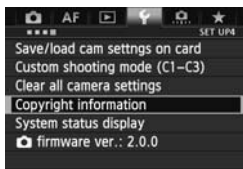

1 Select [Copyright information].

- Under the [**4**] tab, select [**Copyright information**], then press <SET>.



2 Select the option to be set.

- Turn the <DIAL> dial, select either [**Enter author's name**] or [**Enter copyright details**], then press <SET>.



3 Enter text.

- Press the <Q> button, and the text palette will be highlighted in a color frame. Text can be entered.
- Operate the <DIAL/TURNING DIAL> dial or <MULTI-selector> to move the and select the desired character. Then press <SET> to enter it.
- You can enter up to 63 characters.
- To delete a character, press the <DELETE> button.

4 Exit the setting.

- After entering the text, press the <MENU> button.
- ▶ The information will be saved and the screen will return to step 2.

Checking the Copyright Information



When you select [**Display copyright info.**] in step 2 on the preceding page, you can check the [**Author**] and [**Copyright**] information that you entered.

Deleting the Copyright Information

When you select [**Delete copyright information**] in step 2, you can delete the [**Author**] and [**Copyright**] information.



You can also set or check the copyright information with EOS Utility (provided software, p.426).

MENU Setting the Color Space

The range of reproducible colors is called the color space. With this camera, the color space for captured images can be set to sRGB or Adobe RGB. For normal shooting, sRGB is recommended.

1 Select [Color space].

- Under the [CAMERA 1] tab, select [Color space], then press <SET>.

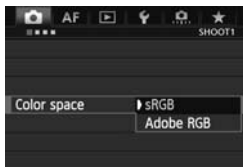

2 Set the desired color space.

- Select [sRGB] or [Adobe RGB], then press <SET>.

About Adobe RGB

This color space is mainly used for commercial printing and other industrial uses. This setting is not recommended if you do not know about image processing, Adobe RGB, and Design rule for Camera File System 2.0 (Exif 2.21 or higher). The image will look very subdued in a sRGB personal computer environment and with printers not compatible with Design rule for Camera File System 2.0 (Exif 2.21 or higher). Post-processing of the image with software will therefore be required.



- If the captured still photo was shot in the Adobe RGB color space, the first character in the file name will be an underscore “_”.
- The ICC profile is not appended. Refer to explanations about the ICC profile in the Software Instruction Manual (p.428) on the CD-ROM.

4

Exposure Control

Select the shooting mode to suit the subject or shooting objective. You can set the shutter speed and/or aperture to obtain the exposure you want.

- After you press the shutter button halfway and let go, the exposure values will remain displayed in the viewfinder and on the top LCD panel for approx. 6 sec. (ⓘ6).
- For the functions settable in each shooting mode, see page 366.



Set the power switch to <ON>.

P: Program AE

The camera automatically sets the shutter speed and aperture to suit the subject's brightness. This is called Program AE.

* <P> stands for Program.

* AE stands for autoexposure.

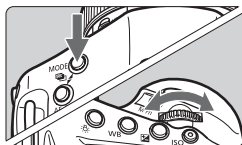

1 Set the shooting mode to <P>.

- Press the <MODE> button and turn the <mode dial> or <mode dial> dial to select <P>.

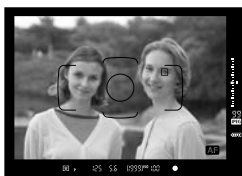

2 Focus the subject.

- Look through the viewfinder and aim the AF point over the subject. Then press the shutter button halfway.
- ▶ When focus is achieved, the focus confirmation light <●> on the viewfinder's bottom right will light up (in One-Shot AF mode).
- ▶ The shutter speed and aperture will be set automatically and displayed in the viewfinder and on the top LCD panel.



3 Check the display.

- A standard exposure will be obtained as long as the shutter speed and aperture display do not blink.

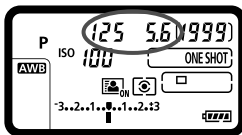

4 Take the picture.

- Compose the shot and press the shutter button completely.

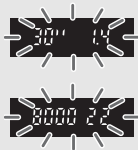

- If the “30” shutter speed and the maximum aperture blink, it indicates underexposure. Increase the ISO speed or use flash.
- If the “8000” shutter speed and the minimum aperture blink, it indicates overexposure. Lower the ISO speed or use an ND filter (sold separately) to reduce the amount of light entering the lens.



About Program Shift

- In the Program AE mode, you can freely change the shutter speed and aperture combination (Program) set automatically by the camera while maintaining the same exposure. This is called Program shift.
- To shift the program, press the shutter button down halfway, then turn the  dial until the desired shutter speed or aperture is displayed.
- Program shift is canceled automatically after the picture is taken.
- Program shift cannot be used with flash.

FAQ

- **The focus confirmation light <●> blinks and focus is not achieved.**
Aim the center of the Area AF frame over an area with good contrast, then press the shutter button halfway (p.46). If you are too close to the subject, move away and try again.
- **Sometimes multiple AF points light up simultaneously.**
All those AF points have achieved focus. As long as the AF point covering the desired subject lights up, you can take the picture.
- **The focus confirmation light <●> does not light up.**
In the AI Servo AF mode, it indicates that the camera is focusing continuously on a moving subject. (Although the AF status indicator <AF> is displayed, the focus confirmation light <●> does not light up.) Note that focus lock (p.67) will not work in the AI Servo AF mode.
- **Pressing the shutter button halfway does not focus the subject.**
If the focus mode switch on the lens is set to <MF> (Manual Focus), set it to <AF> (Auto Focus).
- **The shutter speed and aperture displays are blinking.**
Since it is too dark, taking the picture may result in a blurred subject due to camera shake. Using a tripod or a Canon EX-series Speedlite (p.196) (sold separately) is recommended.
- **When flash was used, the bottom part of the picture came out unnaturally dark.**
If a hood is attached to the lens, it can obstruct the flash coverage. If the subject is close, detach the hood before taking the picture with flash.

Tv: Shutter-Priority AE

In this mode, you set the shutter speed and the camera automatically sets the aperture to obtain the standard exposure suiting the brightness of the subject. This is called shutter-priority AE. A faster shutter speed can freeze the action or a moving subject. A slower shutter speed can create a blurred effect, giving the impression of motion.

* <Tv> stands for Time value.



Blurred motion
(Slow shutter speed: 1/30 sec.)



Frozen action
(Fast shutter speed: 1/2000 sec.)



1 Set the shooting mode to <Tv>.

- Press the <MODE> button and turn the <☀> or <⊙> dial to select <Tv>.

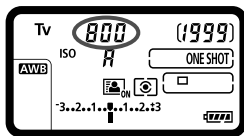

2 Set the desired shutter speed.

- While looking at the top LCD panel, turn the <☀> dial.

3 Focus the subject.

- Press the shutter button halfway.
- ▶ The aperture is set automatically.

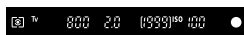

4 Check the viewfinder display and shoot.

- As long as the aperture is not blinking, a standard exposure will be obtained.

!

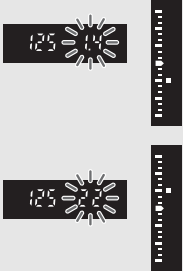

- If the maximum aperture blinks, it indicates underexposure. Turn the dial to set a slower shutter speed until the aperture stops blinking or set a higher ISO speed.
- If the minimum aperture blinks, it indicates overexposure. Turn the dial to set a faster shutter speed until the aperture stops blinking or set a lower ISO speed.

 **Shutter Speed Display**

The shutter speeds from “8000” to “4” indicate the denominator of the fractional shutter speed. For example, “125” indicates 1/125 sec. Also, “0”5” indicates 0.5 sec. and “15” is 15 sec.

Av : Aperture-Priority AE

In this mode, you set the desired aperture and the camera sets the shutter speed automatically to obtain the standard exposure suiting the subject brightness. This is called aperture-priority AE. A higher f/number (smaller aperture hole) will make more of the foreground and background fall within acceptable focus. On the other hand, a lower f/number (larger aperture hole) will make less of the foreground and background fall within acceptable focus. * <Av> stands for Aperture value (aperture opening).



Blurred background

(With a low aperture f/number: f/5.6)



Sharp foreground and background

(With a high aperture f/number: f/32)



1 Set the shooting mode to <Av>.

- Press the <MODE> button and turn the <mode dial> or <mode dial> to select <Av>.

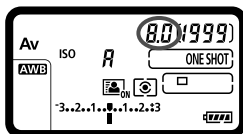

2 Set the desired aperture.

- While looking at the top LCD panel, turn the <mode dial>.

3 Focus the subject.



- Press the shutter button halfway.
- ▶ The shutter speed is set automatically.





4 Check the viewfinder display and shoot.

- As long as the shutter speed is not blinking, a standard exposure will be obtained.



- If the “30” shutter speed blinks, it indicates underexposure. Turn the dial to set a larger aperture (lower f/number) until the shutter speed blinking stops or set a higher ISO speed.

- If the “8000” shutter speed blinks, it indicates overexposure. Turn the dial to set a smaller aperture (higher aperture f/number) until the shutter speed blinking stops or set a lower ISO speed.

 **Aperture Display**

The higher the f/number, the smaller the aperture opening will be. The apertures displayed will differ depending on the lens. If no lens is attached to the camera, “00” will be displayed for the aperture.

Depth of Field Preview

The aperture opening (diaphragm) changes only at the moment when the picture is taken. Otherwise, the aperture remains fully open. Therefore, when you look at the scene through the viewfinder or on the LCD monitor, the depth of field will look narrow.

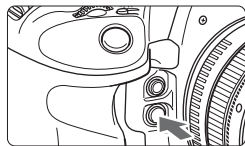

Press the depth-of-field preview button to stop down the lens to the current aperture setting and check the depth of field (range of acceptable focus).



- A higher f/number will make more of the foreground and background fall within acceptable focus. However, the viewfinder will look darker.
- The depth-of-field effect can be clearly seen on the Live View image as you change the aperture while pressing the depth-of-field preview button (p.207).
- The exposure will be locked (AE lock) while the depth-of-field preview button is pressed.

M: Manual Exposure

In this mode, you set both the shutter speed and aperture as desired. To determine the exposure, refer to the exposure level indicator in the viewfinder or use a commercially-available exposure meter. This method is called manual exposure.

* <M> stands for Manual.



1 Set the shooting mode to <M>.

- Press the <MODE> button and turn the <☀> or <⦿> dial to select <M>.

2 Set the ISO speed (p.130).

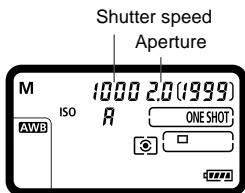

3 Set the shutter speed and aperture.

- To set the shutter speed, turn the <☀> dial.
- To set the aperture, turn the <⦿> dial.
- You can also set the aperture by pressing the <⦶> button, then turning the <☀> or <⦿> dial.
- If you cannot set the shutter speed or aperture, set the power switch to <ON>, then turn the <☀> or <⦿> dial.



4 Focus the subject.

- Press the shutter button halfway.
- ▶ The exposure setting will be displayed in the viewfinder and on the top LCD panel.
- On the right of the viewfinder, the exposure level indicator <■> indicates the current exposure level relative to the standard exposure index <■>.



5 Set the exposure.

- Check the exposure level and set the desired shutter speed and aperture.
- If the difference with the standard exposure exceeds ± 3 stops, the end of the exposure level indicator will display \blacktriangle or \blacktriangledown .

6 Take the picture.

Exposure Compensation with Auto ISO

If the ISO speed has been set to A (AUTO), you can set exposure compensation (p.181) as follows.

- Under [**5: Custom Controls**], use [**SET: Expo comp (hold btn, turn **)] (p.353).
- Quick Control (p.51).

- If Auto ISO is set, the ISO speed setting will change to obtain a standard exposure given the shutter speed and aperture set. Therefore, you may not obtain the desired exposure effect. In this case, set the exposure compensation.
- If flash is used when Auto ISO is set, exposure compensation will not be applied even if an exposure compensation amount is set.

- In [**2: Auto Lighting Optimizer**], if the checkmark \checkmark for [**Disable during man expo**] is removed, it can be set in the $\langle M \rangle$ mode (p.152).
- When Auto ISO is set, you can press the $\langle * \rangle$ button to lock the ISO speed.
- After recomposing the picture, you can see the exposure level difference on the exposure level indicator (p.22) compared to when you pressed the $\langle * \rangle$ button.
- If exposure compensation (p.181) was applied in $\langle P/Tv/Av \rangle$ mode, and then the shooting mode is switched to $\langle M \rangle$ and Auto ISO is set, the exposure compensation amount already set will be maintained.

Selecting the Metering Mode

You can select one of four methods to measure the subject's brightness.

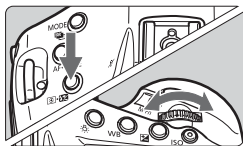

1 Press the   button. (06)

2 Select the metering mode.

- While looking at the top LCD panel, turn the  dial.

: Evaluative metering

: Partial metering

: Spot metering

: Center-weighted average metering



Evaluative metering

This is a general-purpose metering mode suited even for backlit subjects. The camera sets the exposure automatically to suit the scene.

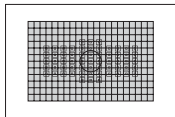

Partial metering

Effective when the background is much brighter than the subject due to backlighting, etc. Partial metering covers approx. 6.5% of the viewfinder area at the center.



Spot metering

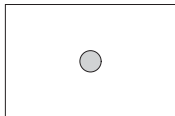

This is for metering a specific spot of the subject or scene. The brightness is metered at the center covering approx. 2.5% of the viewfinder area.



Center-weighted average metering

The brightness is metered at the center and then averaged for the entire scene.



 If [ 1: Spot meter. linked to AF pt] is set to [Linked to active AF point] (p.328), spot metering linked to any of the 61 AF points will be possible.

Multi-Spot Metering

With multiple spot meter readings, you can see the relative exposure levels of multiple areas in the picture and set the exposure to obtain the desired result. Multi-spot metering is possible in **P/Tv/Av** modes.

1 Set the metering mode to  spot metering.





2 Press the <M-Fn> button. (☞16)

- Aim the spot metering circle over the area where you want a relative exposure reading, then press the <M-Fn> button. Do this for all the multiple areas you want to meter.
- ▶ On the right of the viewfinder, the relative exposure level will be displayed for the spot meter reading taken at the respective spot. The spot meter readings will be averaged and used for the exposure setting.



- While referring to the exposure level indicator's three spot metering marks, you can set the exposure compensation to set the final exposure and obtain the desired result.



- You can take up to eight spot meter readings for one picture.
- The exposure setting obtained with multi-spot meter readings will be canceled in the following cases:
 - After taking the last spot meter reading, 16 seconds elapsed.
 - You pressed the <MODE>, <AF•DRIVE>, <☞•>, <ISO>, <☞•>, <☞•>, or <WB> button.
- Multi-spot metering will still be possible even if [ 1: Spot meter. linked to AF point] is set to [Linked to active AF point] (p.328).

Setting Exposure Compensation

Exposure compensation can brighten (increased exposure) or darken (decreased exposure) the standard exposure set by the camera.

Exposure compensation can be set in the **P/Tv/Av** shooting modes. Although you can set the exposure compensation up to ± 5 stops in 1/3-stop increments, the exposure compensation indicator in the viewfinder and on the top LCD panel can only display the setting up to ± 3 stops. If the exposure compensation amount exceeds ± 3 stops, setting it with the Quick Control (p.51) is recommended. If both the **<M>** mode and Auto ISO are set, see page 178 to set the exposure compensation.

1 Check the exposure.

- Press the shutter button halfway (6) and check the exposure level indicator.

2 Set the exposure compensation amount.

- While looking at the viewfinder or top LCD panel, turn the **<Q>** dial.
- If you cannot set the exposure compensation, set the power switch to **<ON>**, then turn the **<Q>** dial.
- ▶ When exposure compensation is set, the **<E>** icon will be displayed in the viewfinder.
- To cancel exposure compensation, set the exposure level indicator **<■/■>** to the standard exposure index (**<▶/▼>**).

3 Take the picture.

If [**2: Auto Lighting Optimizer**] (p.152) is not set to **[Disable]**, the image may still look bright even if a darker exposure compensation amount was set.

- The exposure compensation amount will remain in effect even after you set the power switch to **<OFF>**.
- After setting the exposure compensation amount, you can set the power switch to **<LOCK>** to prevent the exposure compensation amount from changing accidentally.
- If the exposure compensation amount exceeds ± 3 stops, the end of the exposure level indicator will display **<▶/▼>** or **<▶/▲>**.
- You can also set it by pressing the **<Q>** button and turning the **<Q>** or **<Q>** dial.

Auto Exposure Bracketing (AEB)

By changing the shutter speed or aperture automatically, the camera brackets the exposure up to ± 3 stops in 1/3-stop increments for three successive shots. This is called AEB. * AEB stands for Auto Exposure Bracketing.

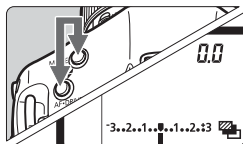

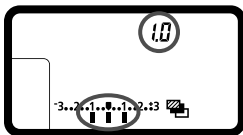

1 Hold down the <MODE> and <AF·DRIVE> buttons simultaneously. ()

- ▶ The  icon and “0.0” will appear on the top LCD panel.



2 Set the AEB range.



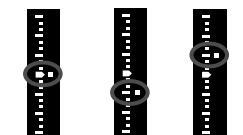







- Turn the  or  dial to set the AEB range.
- “1.0” is the AEB increment, and  is the AEB range.



Standard exposure Decreased exposure Increased exposure

3 Take the picture.

- In the current drive mode, the pictures will be taken in this sequence: Standard exposure, decreased exposure, and increased exposure.
- AEB will not be canceled automatically. To cancel AEB, set the AEB increment to “0.0”.

- During AEB shooting, the  icon in the viewfinder and the  icon on the top LCD panel will blink.
- If the drive mode is set to  or , press the shutter button three times for each shot. When , , or  is set and you hold down the shutter button completely, the three bracketed shots will be taken continuously and the camera will automatically stop shooting. When  or  is set, the three bracketed shots will be taken continuously after a 10-sec. or 2-sec. delay.
- You can set AEB in combination with exposure compensation.
- If the AEB range exceeds ± 3 stops, the end of the exposure level indicator will display  or .
- AEB cannot be set for bulb exposures or used with flash.
- AEB will be canceled automatically when you set the power switch to <OFF> or when the flash is ready to fire.

* AE Lock

Use AE lock when the area of focus is to be different from the exposure metering area or when you want to take multiple shots at the same exposure setting. Press the < * > button to lock the exposure, then recompose and take the shot. This is called AE lock. It is effective for backlit subjects.

1 Focus the subject.

- Press the shutter button halfway.
 - ▶ The exposure setting will be displayed.

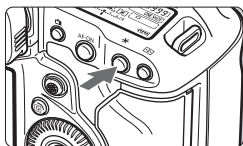

2 Press the < * > button. (⊙6)



- ▶ The < * > icon lights up in the viewfinder to indicate that the exposure setting is locked (AE lock).
- Each time you press the < * > button, the current autoexposure setting is locked.



3 Recompose and take the picture.

- The exposure level indicator on the right of the viewfinder will show the AE lock exposure level and the current exposure level in real-time.
- If you want to maintain the AE lock while taking more shots, hold down the < * > button and press the shutter button to take another shot.

AE Lock Effects

Metering Mode (p.179)	AF Point Selection Method (p.71)	
	Automatic Selection	Manual Selection
 *	AE lock is applied at the AF point that achieved focus.	AE lock is applied at the selected AF point.
	AE lock is applied at the center AF point.	

* When the lens' focus mode switch is set to <MF>, AE lock is applied at the center AF point.

 AE lock is not possible with bulb exposures.

Bulb Exposures

When bulb shooting is set, the shutter stays open as long as you hold down the shutter button completely, and closes when you let go of the shutter button. Use bulb exposures for night scenes, fireworks, the heavens, and other subjects requiring long exposures.

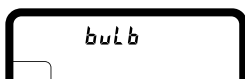

1 Set the shooting mode to <buLb>.

- Press the <MODE> button and turn the <☀> or <⊙> dial to select <buLb>.

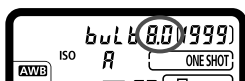

2 Set the desired aperture.

- While looking at the top LCD panel, turn the <☀> or <⊙> dial.

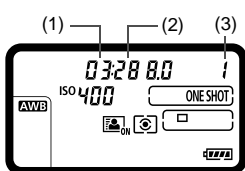

3 Take the picture.

- While you hold down the shutter button, the exposure will continue.
- ▶ The elapsed exposure time will be displayed on the top LCD panel.
1: min., 2: sec., 3: hour



- Long exposures produce more noise than usual.
- ISO speed is fixed to ISO 400 when ISO Auto is set (p.131).



- When [**2: Long exp. noise reduction**] is set to [Auto] or [Enable], noise generated by the long exposure can be reduced (p.154).
- For bulb exposures, using a tripod and Remote Switch RS-80N3 (sold separately) or Timer Remote Controller TC-80N3 (sold separately) is recommended (p.185).

Using the Eyepiece Shutter

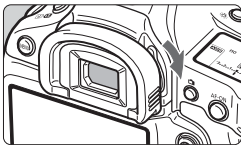

If you use the self-timer or bulb and take a picture without looking through the viewfinder, stray light entering the eyepiece can throw off the exposure and result in a dark picture. To prevent this, slide the eyepiece shutter lever as shown by the arrow to shutter the eyepiece.

You need not shutter the eyepiece during Live View shooting or movie shooting.

Using a Remote Switch

You can connect the Remote Switch RS-80N3 or Timer Remote Controller TC-80N3 (both sold separately) or any EOS accessory equipped with an N3-type terminal to the camera for shooting (p.369). To operate the accessory, refer to its instruction manual.

1 Open the terminal cover.

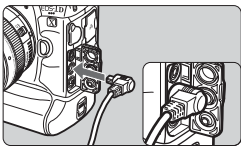

2 Connect the plug to the remote control terminal.



- Connect the plug as shown in the illustration.
- To disconnect the plug, grasp the silver part and pull.

Multiple Exposures

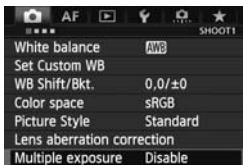
You can shoot two to nine exposures to be merged into one image. If you shoot multiple-exposure images with Live View shooting (p.205), you can see how the single exposures merge while shooting.



1 Select [Multiple exposure].

- Under [ 1], select [Multiple exposure] then press <  >.
- ▶ The multiple exposure setting screen will appear.



2 Set [Multiple exposure].

- Select [On:Func/Ctrl] or [On:ContShtng], then press <  >.
- To quit shooting multiple exposures, select [Disable].



● On: Func/Ctrl (Function and control priority)

Convenient when you want to shoot multiple exposures while checking the result as you proceed. During continuous shooting, the continuous shooting speed will decrease greatly.

● On: ContShtng (Continuous shooting priority)

Geared for continuous multiple-exposure shooting of a moving subject. Continuous shooting is possible, but the following operations are disabled during shooting: menu viewing, Live View display, image review after image capture, image playback, and undo last image (p.191).

Also, only the multiple-exposure image will be saved. (The single exposures merged in the multiple-exposure image will not be saved.)

- If you set white balance bracketing or if [LV  /  set.] is set to [Movies], multiple exposure shooting is not possible.
- If you perform Live View shooting while [On:ContShtng] is set, the Live View function will stop automatically after the first shot is taken. From the second shot onward, shoot while looking through the viewfinder.



3 Set [Multi-expos ctrl].

- Select the desired multiple-exposure control method, then press <SET>.

● Additive

The exposure of each single exposure is added cumulatively. Based on the [No. of exposures], set a negative exposure compensation. Refer to the basic guide below to set a negative exposure compensation.

Exposure Compensation Setting Guide for Multiple Exposures

Two exposures: -1 stop, three exposures: -1.5 stop, four exposures: -2 stops



If [On:Func/Ctrl] and [Additive] are both set, the image displayed during shooting may look noisy. However, when you finish shooting the set number of exposures, noise reduction will be applied and the final multiple-exposure image that is recorded will have less noise.

● Average

Based on the [No. of exposures], negative exposure compensation is set automatically as you shoot multiple exposures. If you shoot multiple exposures of the same scene, the exposure of the subject's background will be automatically controlled to obtain a standard exposure. If you want to change the exposure of each single exposure, select [Additive].

● Bright/Dark

The brightness (or darkness) of the base image and the images to be added are compared at the same position, and then the bright (or dark) part will be left in the picture. Depending on the overlapping colors, the colors may be mixed depending on the brightness (or darkness) ratio of the compared images.



4 Set the [No. of exposures].

- Turn the <DISP> dial to select the number of exposures, then press <SET>.
- You can set it from 2 to 9 exposures.

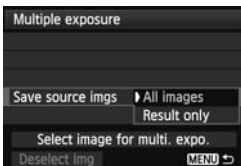

5 Set the images to be saved.

- To save all the single exposures and the merged multiple-exposure image, select [**All images**], then press <SET>.
- To save only the merged multiple-exposure image, select [**Result only**], then press <SET>.

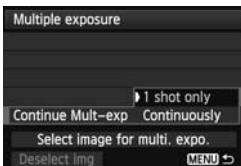

6 Select [Continue Mult-exp].

- Select either [**1 shot only**] or [**Continuously**], then press <SET>.
- With [**1 shot only**], multiple-exposure shooting will be canceled automatically after the shooting ends.
- With [**Continuously**], multiple-exposure shooting continues until the setting in step 2 is set to [**Disable**].



Remaining number of exposures

7 Take the first exposure.

- ▶ When [**On:Func/Ctrl**] is set, the captured image will be displayed.
- ▶ The <[]> icon will blink.
- The number of remaining exposures is displayed on the right of the viewfinder and in brackets [] on the screen.
- Pressing the <[]> button enables you to view the captured image (p.191).

- During multiple-exposure shooting, Auto Lighting Optimizer, highlight tone priority, peripheral illumination correction and chromatic aberration correction will be disabled.
- The image-recording quality, ISO speed, Picture Style, high ISO speed noise reduction and color space, etc. set for the first single exposure will also be set for the subsequent exposures.
- If the Picture Style is set to [**Auto**], the [**Standard**] Picture Style will be set for shooting.

8 Shoot subsequent exposures.

- ▶ When [**On:Func/Ctrl**] is set, the merged multiple-exposure image will be displayed.
- With Live View shooting, the multiple-exposure images merged so far will be displayed. By pressing the <INFO.> button, you can display only the Live View image.
- After you shoot the set number of exposures, multiple-exposure shooting will be canceled. With continuous shooting, after you finish shooting the set number of exposures while holding down the shutter button, the shooting will stop.



- With multiple exposures, the more exposures there are, the more noticeable the noise, irregular colors, and banding will be. Also, as noise increases with higher ISO speeds, shooting at low ISO speeds is recommended.
- If [**Additive**] is set, the image processing after taking the multiple exposures will take time. (The access lamp will light up for longer than usual.)
- If you perform Live View shooting while [**On:Func/Ctrl**] and [**Additive**] are both set, the Live View function will stop automatically when the multiple exposure shooting ends.
- In step 8, the brightness and noise of the multiple-exposure image displayed during Live View shooting will be different from the final multiple-exposure image recorded.
- If [**On:ContShtn**] is set, let go of the shutter button after shooting the set number of exposures.
- If the power switch is set to <OFF> or the battery is replaced after you set multiple exposure settings, multiple-exposure shooting will be canceled.
- If you switch the shooting mode to <C1/C2/C3> while shooting, multiple-exposure shooting will end.
- When multiple exposure is set or during multiple-exposure shooting, you cannot use the grayed out functions in the camera menu.
- If you connect the camera to a personal computer or printer, multiple-exposure cannot be set.



When [**On:Func/Ctrl**] is set, you can press the <▶> button during shooting to view the multiple exposures taken so far or delete the last single exposure (p.191).

Merging Multiple Exposures with an Image Recorded in the Card

You can select an image recorded in the card as the first single exposure. The original of the selected image will remain intact.

You can only select RAW images. You cannot select **M RAW/S RAW** or JPEG images.

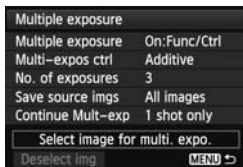

1 Select [Select image for multi. expo.].

- Select [**Select image for multi. expo.**], then press <SET>.
- ▶ The images in the card will be displayed.

2 Select an image.

- Turn the <DISP> dial to select the image to be used as the first single exposure, then press <SET>.
- Turn the <DISP> dial to select **[OK]**.
- ▶ The file number of the selected image will be displayed at the bottom of the screen.

3 Take the picture.

- When you select the first image, the number of remaining exposures as set with **[No. of exposures]** will decrease by 1. For example, if **[No. of exposures]** is 3, you can shoot two exposures.

- Images shot with highlight tone priority set to **[Enable]**, or with cropping information appended (p.339) cannot be selected as the first single exposure.
- Auto Lighting Optimizer, peripheral illumination correction and chromatic aberration correction will be disabled, regardless of the settings of the **RAW** image selected as the first single exposure.
- The ISO speed, Picture Style, high ISO speed noise reduction, and color space, etc., set for the first **RAW** image will also be set for the subsequent images.
- If the first **RAW** image's Picture Style is **[Auto]**, the **[Standard]** Picture Style will be set for the subsequent images.
- You cannot select an image taken with another camera.



- You can also select a **[RAW]** multiple-exposure image.
- If you select **[Deselect img]**, the selected image will be canceled.

Checking and Deleting Multiple Exposures During Shooting



When **[On:Func/Ctrl]** is set and you have not finished shooting the set number of exposures, you can press the **<▶>** button to view the merged multiple-exposure image so far. You can check how it looks and the exposure. (Not possible when **[On:ContShtng]** is set.)

If you press the **<🗑>** button, the operations possible during multiple-exposure shooting will be displayed.

Operation	Description
Return to previous screen	The operations will disappear and the screen before you pressed the <🗑> button will reappear.
Undo last image	Deletes the last image you shot (shoot another image). The number of remaining exposures will increase by 1.
Save and exit	If [Save source imgs: All images] is set, all of the single exposures and the merged multiple-exposure image will be saved before exiting. If [Save source imgs: Result only] is set, only the merged multiple-exposure image will be saved before exiting.
Exit without saving	None of the images will be saved before exiting.



During multiple-exposure shooting, you can only play back multiple-exposure images.

FAQ

● Are there any restrictions on the image-recording quality?

All JPEG image-recording quality settings can be selected. If **M RAW** or **S RAW** is set, the merged multiple-exposure will be recorded as a **RAW** image.

Image-Recording Quality Setting	Single Exposures	Merged Multiple-Exposure
JPEG	JPEG	JPEG
RAW	RAW	RAW
M RAW/S RAW	M RAW/S RAW	RAW
RAW +JPEG	RAW +JPEG	RAW +JPEG
M RAW/S RAW +JPEG	M RAW/S RAW +JPEG	RAW +JPEG

● Can I merge images recorded in the card?

With [**Select image for multi. expo.**], you can select the first single exposure from the images recorded on the card (p.190). Note that you cannot merge multiple images already recorded on the card.

● Are multiple exposures possible with Live View shooting?

With [**On:Func/Ctrl**] set, you can shoot multiple exposures with Live View shooting (p.205).

● What file numbers are used for saving merged multiple-exposures?

If all images are set to be saved, the merged multiple-exposure image file number will be the serial number coming after the file number of the final single exposure used to create the merged multiple-exposure image.

● Will auto power off take effect during multiple-exposure shooting?

As long as [**2: Auto power off**] is not set to [**Disable**], the power will turn off automatically after 30 min. of non-operation. If the auto power off takes effect, multiple-exposure shooting will end, and multiple-exposure settings will be canceled. Before starting the multiple-exposure shooting, the auto power off will take effect as set with the camera, and multiple-exposure settings will be canceled.

Mirror Lockup

Although using the self-timer or Remote Switch can prevent camera shake, using mirror lockup to prevent camera vibrations (mirror shock) can also help when you use a super telephoto lens or shoot close ups (macro photography).

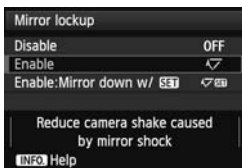

1 Set [Mirror lockup].

- Under the [ 3] tab, select [Mirror lockup], then press <[SET]>.
- Select [Enable] or [Enable: Mirror down w/[SET]], then press <[SET]>.

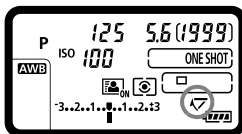



2 Focus the subject, then press the shutter button completely.

- ▶ The mirror will swing up, and the <[Mirror lockup icon]> will blink on the top LCD panel.

3 Press the shutter button completely again.

- ▶ The picture will be taken.
- With [Enable] set, the mirror will go back down when the shooting ends.
- If [Enable: Mirror down w/[SET]] is set, the mirror lockup will be maintained even after shooting. To cancel the mirror lockup, press <[SET]>.

- 
- In very bright light such as at the beach or a ski slope on a sunny day, take the picture promptly after mirror lockup.
 - Do not point the camera toward the sun. The sun's heat can scorch and damage the shutter curtains.
 - If you use the self-timer and mirror lockup in combination with bulb exposure, keep pressing the shutter button completely (self-timer delay time + bulb exposure time). If you let go of the shutter button during the self-timer countdown, there will be a shutter-release sound, but no picture will be taken.
 - During mirror lockup, shooting function settings and menu operations, etc. are disabled.

- 
- When **[Enable]** is set, single shooting will take effect even if the drive mode is set to continuous. When **[Enable: Mirror down w/SET]** is set, the current drive mode will take effect for the shooting.
 - You can also use the self-timer with mirror lockup.
 - If 30 seconds elapse after the mirror has locked up, it will go back down automatically. Pressing the shutter button completely again locks up the mirror again.
 - For mirror lockup shooting, using a tripod and Remote Switch RS-80N3 (sold separately) or Timer Remote Controller TC-80N3 (sold separately) is recommended (p.185).

5

Flash Photography

This chapter explains how to shoot with an EOS-dedicated, EX-series Speedlite (sold separately) or non-Canon flash unit and how to set flash functions on the camera's menu screen.

⚡ Flash Photography

EOS-dedicated, EX-series Speedlites

An EX-series Speedlite (sold separately) makes flash photography as easy as normal shooting.

For detailed instructions, refer to the EX-series Speedlite's instruction manual. This camera is a Type-A camera that can use all the features of EX-series Speedlites.

To set the flash functions and flash Custom Functions with the camera's menu, see pages 199-204.



- **FE lock**

This enables you to obtain a proper flash exposure for a specific part of the subject. Aim the viewfinder center over the subject, then press the camera's <M-Fn> button and take the picture.

- **Flash exposure compensation**

In the same way as normal exposure compensation, flash exposure compensation can be set. You can set flash exposure compensation up to ± 3 stops in 1/3-stop increments.

Press the camera's <[]•[]> button, then turn the <[]> dial while looking at the viewfinder or top LCD panel.

If [2: Auto Lighting Optimizer] (p.152) is not set to [Disable], the image may still look bright even if a darker flash exposure compensation amount was set.

When it is difficult to achieve focus with autofocus, the EOS-dedicated, external Speedlite may automatically emit the AF-assist beam.

Using Non-EX-series Canon Speedlites

- With an EZ/E/EG/ML/TL-series Speedlite set to A-TTL or TTL autoflash mode, the flash can be fired at full output only. Set the camera's shooting mode to <M> (manual exposure) or <Av> (aperture-priority AE) and adjust the aperture setting before shooting.
- When using a Speedlite that has manual flash mode, shoot in the manual flash mode.

Using Non-Canon Flash Units

Sync Speed

The camera can synchronize with non-Canon compact flash units at 1/250 sec. and slower speeds. With large studio flash units, since the flash duration is longer than compact flash units, set the sync speed within 1/125 sec. to 1/30 sec. Be sure to test the flash synchronization before shooting.

PC Terminal

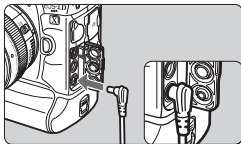

- The camera's PC terminal can be used with flash units having a sync cord. The PC terminal is threaded to prevent inadvertent disconnection.
- The camera's PC terminal has no polarity. You can connect any sync cord regardless of its polarity.

Cautions for Live View shooting

If you use a non-Canon flash unit with Live View shooting, set [**4**: Silent LV shoot.] to [Disable] (p.214). The flash will not fire if it is set to [Mode 1] or [Mode 2].

- ⚠ If the camera is used with a flash unit or flash accessory dedicated to another camera brand, the camera may not operate properly and malfunction may result.
- Do not connect to the camera's PC terminal any flash unit requiring 250 V or more.
- Do not attach a high-voltage flash unit on the camera's hot shoe. It may not fire.

📷 A flash unit attached to the camera's hot shoe and a flash unit connected to the PC terminal can both be used at the same time.

📷 Metered Manual Flash Exposure

This function is for close-up flash photography when you want to set the flash level manually. Use an 18% gray card and an EX-series Speedlite with manual flash mode. Follow the instructions below:

1. Set the camera and Speedlite settings.
 - Set the camera's shooting mode to **<M>** or **<Av>**.
 - Set the Speedlite to manual flash mode.
2. Focus the subject.
 - Focus manually.
3. Set up the 18% gray card.
 - Place the gray card at the subject's position.
 - In the viewfinder, the entire spot metering circle should cover the gray card.
4. Press the **<M-Fn>** button. (📷16)
5. Set the flash exposure level.
 - Adjust the Speedlite's manual flash level and the camera aperture so that the flash exposure level aligns with the standard exposure index.
6. Take the picture.
 - Remove the gray card and take the picture.

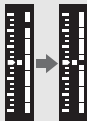

MENU Setting the Flash

With an EX-series Speedlite having compatible flash function settings, you can use the camera's menu screen to set the Speedlite's functions and Custom Functions. **Attach the Speedlite to the camera and turn on the Speedlite.**

For details on the Speedlite's functions, refer to the Speedlite's instruction manual.

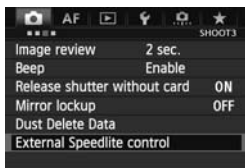

1 Select [External Speedlite control].

- Under the [CAM3] tab, select [External Speedlite control], then press <SET>.
- ▶ The external Speedlite control screen will appear.

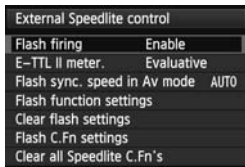

2 Select the desired item.

- Select the menu option to be set, then press <SET>.

[Flash firing]



To enable flash photography, set [Enable]. To enable only the AF-assist beam to be emitted, set [Disable].

[E-TTL II meter.]



For normal flash exposures, set it to [Evaluative]. If [Average] is set, the flash exposure will be averaged for the entire metered scene. Flash exposure compensation may be necessary. This setting is for advanced users.

[Flash sync. speed in Av mode]

Flash sync. speed in Av mode	
Auto	AUTO
1/250-1/60sec. auto	1/250-1/60A
1/250 sec. (fixed)	1/250
INFO Help	

You can set the flash-sync speed for flash photography in the aperture-priority AE (**Av**) mode.

- **AUTO: Auto**

The flash sync speed is set automatically within a range of 1/250 sec. to 30 sec. to suit the scene's brightness. High-speed sync is also possible.

- ^{1/250}/_{-1/60} **A: 1/250-1/60 sec. auto**

Prevents a slow shutter speed from being set in low-light conditions. It is effective for preventing subject blur and camera shake. However, while the subject will be properly exposed with the flash, the background may come out dark.

- **1/250: 1/250 sec. (fixed)**

The flash-sync speed is fixed at 1/250 sec. This more effectively prevents subject blur and camera shake than with [**1/250-1/60 sec. auto**]. However, in low light, the subject's background will come out darker than with [**1/250-1/60 sec. auto**].

ⓘ If [**1/250-1/60 sec. auto**] or [**1/250 sec. (fixed)**] is set, high-speed sync is not possible in the <**Av**> mode.

[Flash function settings]

The information and available functions displayed on the screen will differ depending on the Speedlite, current flash mode, flash Custom Function settings, etc.

For details on your Speedlite's flash functions, refer to the Speedlite's instruction manual.

Sample display

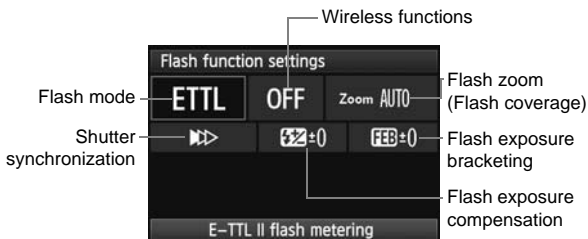

● Flash mode

You can select the flash mode to suit your desired flash shooting.

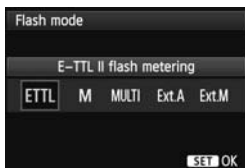

[E-TTL II flash metering] is the standard mode of EX-series Speedlites for automatic flash shooting.

The **[Manual flash]** mode is for setting the Speedlite's **[Flash output level]** yourself.

For other flash modes, refer to the Speedlite's instruction manual.

● **Wireless functions**



Wireless (multiple) flash shooting is possible with radio or optical transmission. For details on wireless flash, refer to the Speedlite's instruction manual.

● **Flash zoom (Flash coverage)**

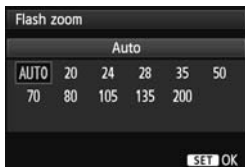

With Speedlites having a zooming flash head, you can set the flash coverage. Normally, set this to **[AUTO]** so that the camera will automatically set the flash coverage to match the lens focal length.

● **Shutter synchronization**

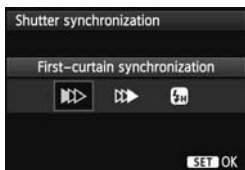

Normally, set this to **[First-curtain synchronization]** so that the flash fires immediately after the exposure starts.

If **[Second-curtain synchronization]** is set, the flash will fire right before the shutter closes. When this is combined with a slow shutter speed, you can create a trail of light such as from car headlights at night. With Second-curtain synchronization, two flashes will be fired: Once when you press the shutter button completely, and once immediately before the exposure ends.

If **[High-speed synchronization]** is set, the flash can be used at all shutter speeds. This is especially effective for portraits using fill flash when you want to give priority to the aperture setting.

● Flash exposure compensation



The same setting as “Flash exposure compensation” on page 196 can be set. For details, refer to the Speedlite’s instruction manual.

● Flash exposure bracketing

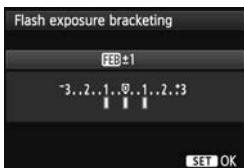

While the flash output is changed automatically, three shots are taken. For details on FEB (Flash Exposure Bracketing), refer to the Speedlite’s instruction manual.

⚠ When using second-curtain synchronization, set the shutter speed to 1/25 sec. or slower. If the shutter speed is 1/30 sec. or faster, first-curtain synchronization will be applied even if **[Second-curtain synchronization]** is set.

- 📄 ● By selecting **[Clear flash settings]**, you can revert the flash settings to their defaults.
- With an EX-series Speedlite not compatible with flash function settings, you can only set the following: **[Flash firing]**, **[E-TTL II meter.]**, and **[Flash exposure compensation]** under **[Flash function settings]**. (**[Shutter synchronization]** can also be set with certain EX-series Speedlites.)
- If flash exposure compensation is set with the Speedlite, you cannot set the flash exposure compensation on the camera (with the **<[]-[]>** button or flash function settings). If it is set with both the camera and Speedlite, the Speedlite’s setting overrides the camera’s.

Flash Custom Function Settings

For details on the Speedlite's Custom Functions, refer to the Speedlite's instruction manual.

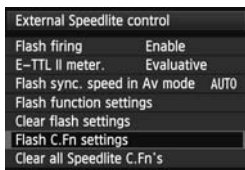



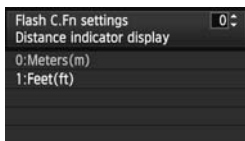

1 Select [Flash C.Fn settings].

- Select [**Flash C.Fn settings**], then press <  >.





2 Set the functions.

- Turn the <  > dial to select the number, then press <  >.
- Turn the <  > dial to select the menu option, then press <  >.

Clearing Flash Custom Function Settings

Selecting [**Clear all Speedlite C.Fn's**] will clear all the Speedlite's Custom Function settings (except [**C.Fn-00: Distance indicator display**]).

 With an EX-series Speedlite, if the [**Flash metering mode**] Custom Function is set to [**TTL**] (autoflash), the Speedlite will always fire at full output.

 The Speedlite's Personal Functions (P.Fn) cannot be set or canceled with the camera's [**External Speedlite control**] screen. Set it with the Speedlite.

6

Shooting with the LCD Monitor (Live View Shooting)

You can shoot while viewing the image on the camera's LCD monitor. This is called "Live View shooting".

Live View shooting is effective for photos of still subjects. If you handhold the camera and shoot while viewing the LCD monitor, camera shake can cause blurred images. Using a tripod is recommended.



About Remote Live View Shooting

With EOS Utility (provided software, p.426) installed in your computer, you can connect the camera to the computer and shoot remotely while viewing the computer screen. For details, refer to the Software Instruction Manual (p.428) on the CD-ROM.

📷 Preparing for Live View Shooting

During Live View shooting, you can take still photos. To shoot movies, see page 225.

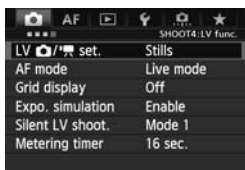

1 Select [LV camera/shooting set.].

- Under the [camera] tab, select [LV camera/shooting set.], then press <SET>.
- “LV” stands for Live View.

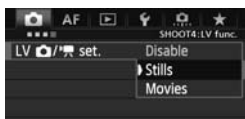

2 Select [Stills].

- Turn the <DIAL> dial to select [Stills], then press <SET>.



3 Display the Live View image.

- Press the <camera> button.
- ▶ The Live View image will appear on the LCD monitor.
- The Live View image will closely reflect the brightness level of the actual image you capture.
- If the standard exposure has not been obtained, turn the <WHEEL> or <DIAL> dial to adjust it.

Shooting with the LCD Monitor



1 Select the shooting mode.

- Press the <MODE> button and turn the < > or < > dial to select the shooting mode.



2 Focus the subject.

- When you press the shutter button halfway, the camera will focus with the current AF mode (p.215).

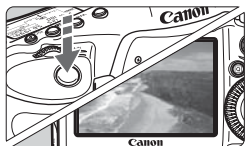

3 Take the picture.

- Press the shutter button completely.
- ▶ The picture will be taken and the captured image is displayed on the LCD monitor.
- ▶ After the image review ends, the camera will return to Live View shooting automatically.
- Press the < > button to end the Live View shooting.



- The image's field of view is approx. 100% (when the image size is set to JPEG L).
- The metering mode will be fixed to evaluative metering for Live View shooting.
- To check the depth of field, press the depth-of-field preview button.
- During continuous shooting, the exposure set for the first shot will also be applied to subsequent shots.
- If you switch from the **P/Tv/Av/M/BULB** shooting mode to the Custom shooting mode (or vice versa) (p.361), the Live View function display will end. Press the < > button again.

Battery Life with Live View Shooting [Approx. number of shots]

Temperature	At 23°C / 73°F	At 0°C / 32°F
Possible shots	290	250

- The figures above are based on a fully-charged Battery Pack LP-E4N and CIPA (Camera & Imaging Products Association) testing standards.
- With a fully-charged Battery Pack LP-E4N, continuous Live View shooting is possible for approx. 2 hr. 30 min. at 23°C / 73°F.

- Do not point the camera toward an intense light source, such as the sun on a sunny day or an intense artificial light source. Doing so may damage the image sensor or the camera's internal components.
- **Cautions for using Live View shooting are on pages 223-224.**

- You can also focus by pressing the <AF-ON> button.
- When flash is used, there will be two shutter sounds, but only one shot will be taken.
- If the camera is not operated for a prolonged period, the power will turn off automatically as set with [**2: Auto power off**] (p.57). If [**2: Auto power off**] is set to [**Disable**], Live View shooting will end automatically after 30 min. (camera power remains on).
- With the stereo AV cable (provided) or HDMI cable (sold separately), you can display the Live View image on a TV (p.275, 278).

About the Information Display

- Each time you press the <INFO.> button, the information display will change.

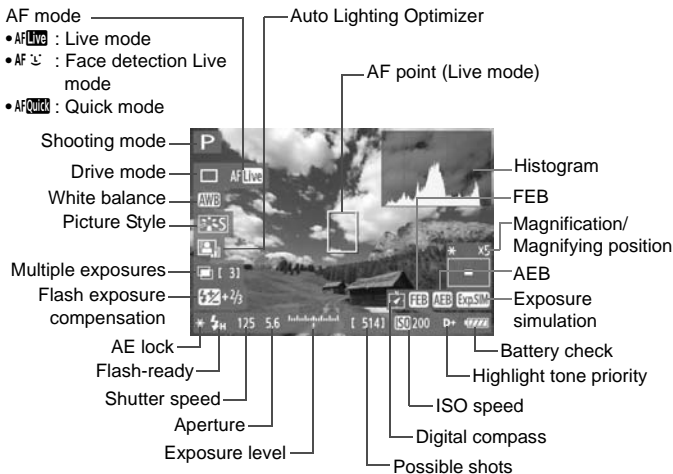

- The histogram can be displayed when [**Expo. simulation: Enable**] is set (p.213).
- You can display the electronic level by pressing the <INFO.> button (p.62). Note that if the AF mode is set to [**Live mode**] or the camera is connected to a TV set with an HDMI cable, the electronic level cannot be displayed.
- When <Exp.SIM> is displayed in white, it indicates that the Live View image brightness is close to what the captured image will look like.
- If <Exp.SIM> is blinking, it indicates that the Live View image is not being displayed at the suitable brightness due to low- or bright-light conditions. However, the actual image recorded will reflect the exposure setting.
- If flash is used or bulb is set, the <Exp.SIM> icon and histogram will be grayed out (for your reference). The histogram may not be properly displayed in low- or bright-light conditions.

Final Image Simulation

The final image simulation reflects the effects of the Picture Style, white balance, etc., in the Live View image so you can see what the captured image will look like.







During shooting, the Live View image will automatically reflect the function settings listed below.



Final image simulation during Live View shooting



- Picture Style
 - * All parameters such as sharpness, contrast, color saturation, and color tone are reflected.
- White balance
- White balance correction
- Exposure (with [**Expo. simulation: Enable**])
- Depth of field (with depth-of-field preview button ON)
- Auto Lighting Optimizer
- Peripheral illumination correction
- Highlight tone priority

Shooting Function Settings

MODE / AF / DRIVE / / / ISO / / WB Settings

While the Live View image is displayed, if you press the <MODE>, <AF•DRIVE>, <•>, <>, <ISO>, <>, or <WB> button, the setting screen will appear on the LCD monitor and you can turn the <> or <> dial to set the respective shooting function.

When **AF Quick** is set, you can press the <> button to select the AF area selection mode and AF point. The procedure is the same as with viewfinder shooting. Note that the <> metering mode cannot be set.

 If you switch from the **P/Tv/Av/M/BULB** shooting mode to the Custom shooting mode (or vice versa) (p.361), the Live View function display will end. Press the <> button again.

Quick Control



While the Live View image is displayed, you can press the <> button to set the AF mode, drive mode, white balance, Picture Style, and Auto Lighting Optimizer.



1 Press the <> button.

- ▶ The settable functions will be displayed.

2 Select a function and set it.

- Use <> to select a function.
- ▶ The setting of the selected function is displayed at the bottom.
- Turn the <> or <> dial to set it.

MENU Menu Function Settings

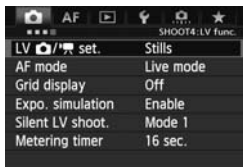

Function settings particular to Live View shooting are explained here. The menu options under the [CAMERA 4] tab are explained on pages 212-214.

The functions settable on this menu screen only apply during Live View shooting. These functions do not take effect during viewfinder shooting.

● LV [camera icon]/[video icon] setting

You can set Live View shooting settings. For details, see page 206.

● AF mode

You can select [Live mode] (p.215), [L Live mode] (p.216), or [Quick mode] (p.220).

● Grid display

By displaying a [3x3 3x3] or [6x4 6x4] grid, you can check for any picture tilting. Also, with [3x3+diag 3x3+diag], the grid is displayed together with diagonal lines to help you align the intersections over the subject for better balance in the composition.

- **Exposure simulation**

Exposure simulation displays and simulates how the brightness of the actual image (exposure) will look.

- **Enable** (Exp.SIM)

The displayed image brightness will be close to the actual brightness (exposure) of the resulting image. If you set exposure compensation, the image brightness will change accordingly.

- **During** (DISP)

Normally, the image is displayed at the standard brightness to make the Live View image easy to see. The image will be displayed close to the actual brightness (exposure) of the resulting image only while you hold down the depth-of-field preview button.

- **Disable** (DISP)



The image is displayed at the standard brightness to make the Live View image easy to see. Even if you set exposure compensation, the Live View image is displayed at the standard brightness.



- If you set an expanded ISO speed setting as **[Maximum]** in **[ISO speed range]**, Live View shooting will be possible under darker conditions.
- Even if a low ISO speed is set, noise may be noticeable in the displayed Live View image under low light. However, when you shoot, the image recorded will have minimal noise. (The image quality of the Live View image is different from that of the recorded image.)

● Silent LV shooting

• Mode 1

The shooting operation noise is quieter than with normal shooting. Continuous shooting is also possible. At <  H >, the maximum continuous shooting speed will be approx. 12 shots/sec. At <  H >, it will be approx. 14 shots/sec.



• Mode 2

When the shutter button is pressed completely, only one shot will be taken. While you keep holding down the shutter button, the camera operation will be suspended. Then when you return to the shutter button's halfway position, the camera operation will resume. The shooting noise is thereby minimized. Even if continuous shooting is set, only a single shot will be taken.

• Disable

Be sure to set this function to **[Disable]** if you use a TS-E lens (other than those listed in  below) for **shifting or tilting the lens** or if you use an Extension Tube. Setting it to **[Mode 1]** or **[Mode 2]** will result in incorrect or irregular exposures.

When you press the shutter button completely, the shutter will sound like it took two shots. However, only one shot will be taken.

-  ● If you use flash, silent shooting will not be possible regardless of the **[Silent LV shoot.]** setting.
- When using a non-Canon flash unit, set this function to **[Disable]**. The flash will not fire if it is set to **[Mode 1]** or **[Mode 2]**.
- If the ISO speed is set to ISO 32000 or higher (when the camera's internal temperature is low, ISO 20000 or higher), the maximum continuous shooting speed at <  H > will be approx. 10 shots/sec.

 With the TS-E17mm f/4L or TS-E24mm f/3.5L II lens, you can use **[Mode 1]** or **[Mode 2]**.

● Metering timer

You can change how long the exposure setting is displayed (AE lock time).

 If you select **[📷1: Set Custom WB]**, **[📷3: Dust Delete Data]**, **[🔧3: Sensor cleaning]**, **[🔧4: Clear all camera settings]**, or **[🔧4: 📷 Firmware ver.]**, the Live View shooting will end.

Using AF to Focus

Selecting the AF Mode

The AF modes available are [**Live mode**], [**Live mode**] (face detection, p.216), and [**Quick mode**] (p.220).

If you want to achieve precise focus, set the lens focus mode switch to <MF>, magnify the image, and focus manually (p.222).

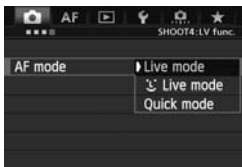

Select the AF mode.

- Under the [**4**] tab, select [**AF mode**].
- While the Live View image is displayed, you can also press the <AF•DRIVE> button to select the AF mode on the setting screen displayed.

Live Mode: AF Live

The image sensor is used to focus. Although AF is possible with the Live View image displayed, **the AF operation will take longer than with the Quick mode**. Also, achieving focus may be more difficult than with the Quick mode.



1 Display the Live View image.

- Press the <[camera icon]> button.
- ▶ The Live View image will appear on the LCD monitor.
- ▶ The AF point <[square]> will appear.

2 Move the AF point.

- You can use <[directional pad]> to move the AF point to where you want to focus. (It cannot go to the edges of the picture.)
- Pressing <[directional pad]> straight down will return the AF point to the image center.

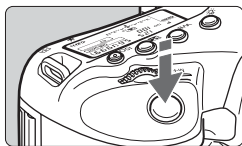

3 Focus the subject.

- Aim the AF point over the subject and press the shutter button halfway.
- ▶ When focus is achieved, the AF point will turn green and the beeper will sound.
- ▶ If focus is not achieved, the AF point will turn orange.



4 Take the picture.

- Check the focus and exposure, then press the shutter button completely to take the picture (p.207).

☺ (Face detection) Live Mode: AF ☺

With the same AF method as the Live mode, human faces are detected and focused. Have the target person face the camera.



1 Display the Live View image.

- Press the <📷> button.
- ▶ The Live View image will appear on the LCD monitor.
- When a face is detected, the <☺> frame will appear over the face to be focused.
- If multiple faces are detected, <☺☺> will be displayed. Use <🔍> to move the <☺> frame over the target face.

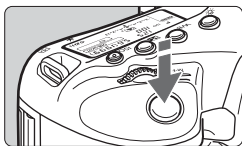

2 Focus the subject.

- Press the shutter button halfway and the camera will focus the face covered by the <[]> frame.
- ▶ When focus is achieved, the AF point will turn green and the beeper will sound.
- ▶ If focus is not achieved, the AF point will turn orange.
- If a face cannot be detected, the AF point <[]> will be displayed and AF will be executed at the center.



3 Take the picture.

- Check the focus and exposure, then press the shutter button completely to take the picture (p.207).



- If the focus is far off, face detection will not be possible. If the lens enables manual focusing even while the lens focus mode switch is set to <AF>, turn the focusing ring to attain rough focus. The face will then be detected and <[]> will be displayed.
- An object other than a human face may be detected as a face.
- Face detection will not work if the face is very small or large in the picture, too bright or too dark, tilted horizontally or diagonally, or partially hidden.
- The <[]> focusing frame may cover only part of the face.





- When you press <[]> straight down or press <SET>, the AF mode will switch to the Live mode (p.215). You can tilt <[]> to move the AF point. Press <[]> straight down again or press <SET> to return to the 'L' (face detection) Live mode.
- Since AF is not possible with a face detected near the edge of the picture, the <[]> will be grayed out. Then if you press the shutter button halfway, the center AF point <[]> will be used to focus.

Live Mode and (Face Detection) Live Mode Notes

AF operation

- Focusing will take slightly longer.
- Even when focus has been achieved, pressing the shutter button halfway will focus again.
- The image brightness may change during and after the AF operation.
- If the light source changes while the Live View image is displayed, the screen may flicker and focusing may be difficult. If this happens, exit Live View shooting and autofocus under the actual light source.
- If you press the <Q> button in the Live mode, the image will be magnified at the AF point. If focusing is difficult in the magnified view, return to the normal view and autofocus. Note that the AF speed may differ between the normal and magnified views.
- If you autofocus in the Live mode's normal view and then magnify the image, the focus may no longer be correct.
- In the  Live mode, pressing the <Q> button will not magnify the image.



- In the Live mode or  (face detection) Live mode, if you shoot a peripheral subject and it is slightly out of focus, aim the center AF point over the subject to focus, then take the picture.
- The external Speedlite will not emit the AF-assist beam. However, if an EX-series Speedlite (sold separately) equipped with a LED light is used, the LED light will turn on automatically for AF-assist when necessary in the Live mode and  (face detection) Live mode.

Shooting conditions that make focusing difficult

- Low-contrast subjects such as the blue sky and solid-color, flat surfaces.
- Subjects in low light.
- Stripes and other patterns where there is contrast only in the horizontal direction.
- Under a light source whose brightness, color, or pattern keeps changing.
- Night scenes or points of light.
- When the image flickers under fluorescent or LED light sources.
- Extremely small subjects.
- Subjects at the edge of the picture.
- Subjects strongly reflecting light.
- The AF point covers both a near and faraway subject (such as an animal in a cage).
- Subjects that keep moving within the AF point and cannot keep still due to camera shake or subject blur.
- A subject approaching or moving away from the camera.
- Autofocusing while the subject is very far out of focus.
- Soft focus effect is applied with a soft focus lens.
- A special effect filter is used.

 If you use AF with any of the following lenses, using **[Quick mode]** is recommended. If you use the **[Live mode]** or **[Live mode]** for AF, it may take a longer time to achieve focus or the camera may not be able to achieve correct focus.

EF50mm f/1.4 USM, EF50mm f/1.8 II, EF50mm f/2.5 Compact Macro,
EF75-300mm f/4-5.6 III, EF75-300mm f/4-5.6 III USM

For information on discontinued lenses, refer to your local Canon Web site.

Quick Mode: AFQuick

The dedicated AF sensor is used to focus in One-Shot AF mode (p.67), using the same AF method as with viewfinder shooting.

Although you can focus the target area quickly, **the Live View image will be interrupted momentarily during the AF operation.**

In AF area selection modes other than 61-point automatic selection AF, you can manually select the AF point or zone.

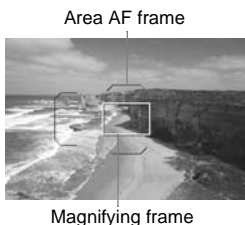
**1 Display the Live View image.**

- Press the <  > button.
- ▶ The Live View image will appear on the LCD monitor.
- If the AF area selection mode is set to “61-point automatic selection AF”, the Area AF frame will be displayed.
- In other modes, the AF point will be displayed as a small frame.
- The larger rectangular frame is the magnifying frame.

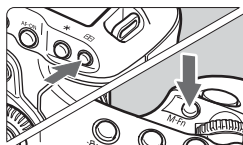
**2 Select the AF area selection mode.**

- Press the <  > button.
- Each time you press the <M-Fn> button, the AF area selection mode changes.



3 Select the AF point.

- Use the to select an AF point. If you press straight down, the center AF point (or center Zone) will be selected.
- You can also use the and dials to select the AF point. The dial selects an AF point in the horizontal direction, and the dial selects an AF point in the vertical direction.

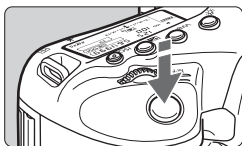
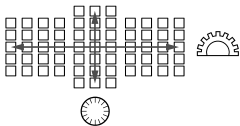

4 Focus the subject.

- Aim the AF point over the subject and press the shutter button halfway.
 - ▶ The Live View image will turn off, the reflex mirror will go back down, and AF will be executed. (No picture is taken.)
 - ▶ When focus is achieved, the beeper will sound and the Live View image will reappear.
 - ▶ The AF point used to focus will light up in green.
 - ▶ If focus is not achieved, the AF point will blink in orange.

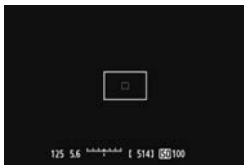

5 Take the picture.

- Check the focus and exposure, then press the shutter button completely to take the picture (p.207).



You cannot take a picture during autofocus. Take the picture while the Live View image is displayed.

Focusing Manually

You can magnify the image and focus precisely with manual focus.

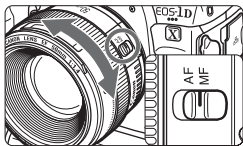

1 Set the lens focus mode switch to <MF>.

- Turn the lens focusing ring to focus roughly.

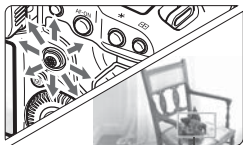

Magnifying frame

2 Move the magnifying frame.

- Use <MAGNIFY> to move the magnifying frame to the position where you want to focus.
- Pressing <MAGNIFY> straight down will return the magnifying frame to the image center.

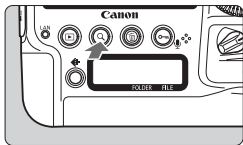

3 Magnify the image.

- Press the <Q> button.
- ▶ The area within the magnifying frame will be magnified.
- Each time you press the <Q> button, the view will change as follows:

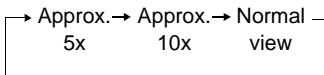

AE lock
Magnified area position
Magnification

4 Focus manually.

- While looking at the magnified image, turn the lens focusing ring to focus.
- After achieving focus, press the <Q> button to return to the normal view.

5 Take the picture.

- Check the focus and exposure, then press the shutter button completely to take the picture (p.207).

Live View Shooting Cautions

Image Quality

- When you shoot at high ISO speeds, noise (such as dots of light and banding) may become noticeable.
- Shooting in high temperatures may cause noise and irregular colors in the image.
- If Live View shooting is used continuously for a long period, the camera's internal temperature may rise, degrading image quality. Stop Live View shooting when not shooting images.
- If you shoot a long exposure while the camera's internal temperature is high, image quality may be degraded. Stop Live View shooting and wait a few minutes before shooting again.

White and Red Internal Temperature Warning

- If the camera's internal temperature increases due to prolonged Live View shooting or a high ambient temperature, a white icon will appear. If you continue shooting while this icon is displayed, the image quality may be degraded. It is recommended to temporarily exit Live View shooting and allow the camera to cool down before shooting again.
- If the camera's internal temperature further increases while the white icon is displayed, a red icon will start blinking. This blinking icon is a warning that the Live View shooting will soon end automatically. If this happens, you will not be able to shoot again until the camera's internal temperature decreases. Turn off the power and let the camera rest for a while.
- Using Live View shooting at a high temperature for a prolonged period will cause the and icons to appear earlier. When you are not shooting, turn off the camera.
- If the camera's internal temperature is high, the image quality of high ISO speed images or long exposures may be degraded even before the white icon is displayed.

Shooting Result

- If you take the picture in magnified view, the exposure may not come out as desired. Return to the normal view before taking the picture. In magnified view, the shutter speed and aperture will be displayed in orange. Even if you take the picture in magnified view, the image will be captured in the normal view.
- If [ 2: Auto Lighting Optimizer] (p.152) is not set to [Disable], the image may look bright even if a decreased exposure compensation or decreased flash exposure compensation was set.

Live View Shooting Cautions

Live View Image

- Under low- or bright-light conditions, the Live View image may not reflect the brightness of the captured image.
- If the light source within the image changes, the screen may flicker. If this happens, exit Live View shooting and resume shooting under the actual light source to be used.
- If you point the camera in a different direction, it may throw off the Live View image's correct brightness momentarily. Wait until the brightness level stabilizes before shooting.
- If there is a very bright light source in the picture, the bright area may appear black on the LCD monitor. However, the actual captured image will correctly show the bright area.
- In low light, if you set the [**F2: LCD brightness**] to a bright setting, noise or irregular colors may appear in the Live View image. However, the noise or irregular colors will not be recorded in the captured image.
- When you magnify the image, the image sharpness may look more pronounced than it really is.

Custom Functions

- During Live View shooting, certain Custom Function settings will not take effect (p.324).

Lens and Flash

- The focus preset function is possible during Live View shooting only when using a (super) telephoto lens equipped with the focus preset mode marketed since the second half of 2011.
- FE lock and modeling flash will not work if an external Speedlite is used.

7

Shooting Movies

The live image displayed on the camera's LCD monitor can be recorded as a movie to the card. The movie recording format will be MOV.

Cards that Can Record Movies

- When shooting movies, use a large-capacity card with a fast writing/reading speed as shown in the table.

Compression Method (p.239)	IPB	10 MB/sec. or faster
	ALL-I (I-only)	30 MB/sec. or faster

- If you use a slow-writing card when shooting movies, the movie may not be recorded properly. Also, if you play back a movie on a card with a slow reading speed, the movie may not play back properly.
- If you want to shoot still photos while shooting a movie, you will need an even faster card.
- To check the card's reading/writing speed, refer to the card manufacturer's Web site.

📷 Preparing to Shoot Movies

Set the camera so it can record the live image displayed on the LCD monitor as a movie. To shoot still photos, see page 205.



1 Select [LV [📷/📷] set.].

- Under the [📷4] tab, select [LV [📷/📷] set.], then press <SET>.
- “LV” stands for Live View.

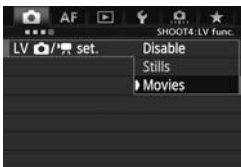

2 Select [Movies].

- Turn the <☉> dial to select [Movies], then press <SET>.



3 Set [Movie rec. size].

- For details on [Movie rec. size], see page 239.



4 Display the image.

- Press the <📷> button.
 - ▶ The image will appear on the LCD monitor.
- A semi-transparent mask will appear on the top/bottom or right/left. The image area surrounded by the masking will be recorded as the movie.
- In the <M> shooting mode, turn the <☉> or <☀> dial to adjust the brightness.

Shooting Movies

Autoexposure Shooting

When the shooting mode is set to <P> or <BULB>, autoexposure control will take effect to suit the scene's current brightness. Autoexposure control will be the same for <P> and <BULB>.



1 Set the shooting mode to <P/ BULB>.

- Press the <MODE> button and turn the <MODE> dial to select <P> or <BULB>.



2 Focus the subject.

- Before shooting, focus with AF or manual focus (p.215-222).
- When you press the shutter button halfway, the camera will focus with the current AF mode.

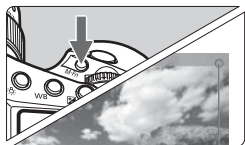

Recording movie

3 Shoot the movie.

- Press the <M-Fn> button to start shooting a movie.
- ▶ While the movie is being shot, the "●" mark will be displayed on the upper right of the screen.
- To stop shooting the movie, press the <M-Fn> button again.

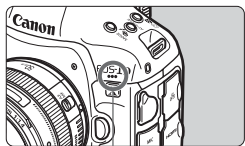

Movie microphone

Regarding the cautions for movie shooting, see page 234.

Shutter-priority AE

When the shooting mode is <Tv>, you can manually set the shutter speed for movie shooting. The ISO speed and aperture will be set automatically to suit the brightness and obtain a standard exposure.



1 Set the shooting mode to <Tv>.

- Press the <MODE> button and turn the <☀> or <⊙> dial to select <Tv>.



Shutter speed

2 Set the desired shutter speed.

- While looking at the LCD monitor, turn the <☀> dial. The settable shutter speeds depend on the frame rate <□* >.
- □30 □25 □24 : 1/4000 sec. - 1/30 sec.
- □60 □50 : 1/4000 sec. - 1/60 sec.



3 Focus and shoot the movie.

- The procedure is the same as steps 2 and 3 for “Autoexposure Shooting” (p.227).

- Changing the shutter speed during movie shooting is not recommended since the changes in the exposure will be recorded.
- When shooting a movie of a moving subject, a shutter speed of 1/30 sec. to 1/125 sec. is recommended. The faster the shutter speed, the less smooth the subject’s movement will look.
- If you change the shutter speed while shooting under fluorescent or LED lighting, image flicker may be recorded.

Aperture-priority AE

When the shooting mode is <Av>, you can manually set the aperture for movie shooting. The ISO speed and shutter speed will be set automatically to suit the brightness and obtain a standard exposure.



1 Set the shooting mode to <Av>.

- Press the <MODE> button and turn the <☀> or <⌚> dial to select <Av>.

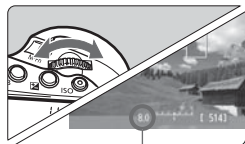

2 Set the desired aperture.

- While looking at the LCD monitor, turn the <☀> dial.



3 Focus and shoot the movie.

- The procedure is the same as steps 2 and 3 for "Autoexposure Shooting" (p.227).

⚠ Changing the aperture during movie shooting is not recommended since variations in the exposure, due to the drive of the lens aperture, will be recorded.

ISO speed in the P, Tv, Av, and BULB modes

- The ISO speed will be set automatically within ISO 100 - 25600.
- Under [**2: ISO speed settings**], if [**ISO speed range**]'s [**Maximum**] setting (p.132) is set to [**51200/H**] in the **P**, **Tv**, and **BULB** modes, the automatic ISO speed setting range's maximum will be expanded to H (equivalent to ISO 51200). Note that even if you set [**Maximum**] to [**51200**], the maximum will remain at ISO 25600 and will not be expanded.
- If [**2: Highlight tone priority**] is set to [**Enable**] (p.156), the ISO speed will be ISO 200 - 25600.
- Under [**2: ISO speed settings**], [**Auto ISO range**] and [**Min. shutter spd.**] cannot be set (p.133, 134) for movie shooting. Also, [**ISO speed range**] cannot be set in the **Tv** mode.

 If [**ISO speed range**]'s [**Minimum**] is set to [**L (50)**] and you switch from still photo shooting to movie shooting, the automatic ISO speed setting range's minimum for movie shooting will be ISO 100. It cannot be expanded to ISO 50.

Notes for Autoexposure, Shutter-priority AE, and Aperture-priority AE

- 
- You can lock the exposure (AE lock) by pressing the <★> button (p.183). After applying AE lock during movie shooting, you can cancel it by pressing the <☒> button. (AE lock setting is retained until you press <☒>.)
 - If you set the power switch to <ON> and turn the <☉> dial, you can set the exposure compensation.
 - Pressing the shutter button halfway displays the ISO speed and shutter speed at the screen bottom. This is the exposure setting for taking a still photo (p.233). The exposure setting for movie shooting is not displayed. Note that the exposure setting for movie shooting may differ from that for still photo shooting.

Using an EX-series Speedlite (Sold Separately) Equipped with an LED Light

During movie shooting in the **P**, **Tv**, **Av** or **BULB** mode, this camera supports the function that turns on the Speedlite's LED light automatically in low-light conditions. **For details, refer to the Speedlite's instruction manual.**

Manual Exposure Shooting

You can manually set the shutter speed, aperture, and ISO speed for movie shooting. Using manual exposure to shoot movies is for advanced users.



1 Set the shooting mode to <M>.

- Press the <MODE> button and turn the or dial to select <M>.

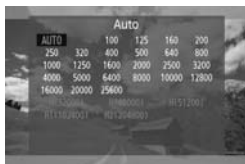

2 Set the ISO speed.

- Press the <ISO> button.
- ▶ The ISO speed setting screen will appear on the LCD monitor.
- Turn the or dial to set the ISO speed.
- For details on the ISO speed, see the next page.



Shutter speed

3 Set the shutter speed and aperture.

- Press the shutter button halfway and check the exposure level indicator.
- To set the shutter speed, turn the dial. The settable shutter speeds depend on the frame rate <[**]>.
 - : 1/4000 sec. - 1/30 sec.
 - : 1/4000 sec. - 1/60 sec.
- To set the aperture, turn the dial.
- If you cannot set the shutter speed or aperture, set the power switch to <ON>, then turn the or dial.

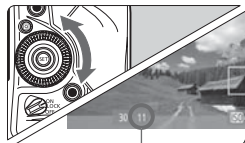

Aperture

4 Focus and shoot the movie.

- The procedure is the same as steps 2 and 3 for “Autoexposure Shooting” (p.227).

ISO speed during manual-exposure shooting

- With [**Auto**] (**A**), the ISO speed will be set automatically within ISO 100 - 25600.
- You can set the ISO speed manually within ISO 100 - 25600 in 1/3-stop increments. Under [**📷2: ISO speed settings**], if [**ISO speed range**]'s [**Maximum**] is set to [**51200/H**], the manual ISO speed setting range's maximum will be expanded to H (equivalent to ISO 51200). Note that even if you set [**Maximum**] to [**51200**], the maximum will remain at ISO 25600 and not be expanded. Setting [**Maximum**] to [**H1 (102400)**] or [**H2 (204800)**] will enable the setting range to be expanded up to ISO 102400/204800.
- If [**📷2: Highlight tone priority**] is set to [**Enable**] (p.156), you can set the ISO speed within ISO 200 - 25600 (depending on the [**ISO speed range**] setting).
- Under [**📷2: ISO speed settings**], [**Auto ISO range**] and [**Min. shutter spd.**] cannot be set (p.133, 134) for movie shooting.

- Since shooting a movie at ISO 32000/40000/51200 may result in substantial noise, these speeds are designated as expanded ISO speeds (displayed as [**H**]).
- If [**ISO speed range**]'s [**Minimum**] is set to [**L (50)**] and you switch from still photo shooting to movie shooting, the manual ISO speed setting range's minimum for movie shooting will be ISO 100. It cannot be expanded to ISO 50.
- Changing the shutter speed or aperture, or zooming the lens during movie shooting is not recommended since the changes in the exposure, or noise at high ISO speeds may be recorded.
- When shooting a movie of a moving subject, a shutter speed of 1/30 sec. to 1/125 sec. is recommended. The faster the shutter speed, the less smooth the subject's movement will look.
- If you change the shutter speed while shooting under fluorescent or LED lighting, image flicker may be recorded.

- If [**SET: Expo comp (hold btn, turn 🌞)**] is set under [**📷5: Custom Controls**] (p.353), exposure compensation is possible when Auto ISO is set.
- If ISO Auto is set, you can press the <★> button to lock the ISO speed.
- When you press the <★> button and then recompose the picture, you can see the exposure level difference on the exposure level indicator (p.25, 233) compared to when you first press the <★> button.
- By pressing the <INFO.> button, you can display the histogram.

Information Display

- Each time you press the <INFO.> button, the information display will change.

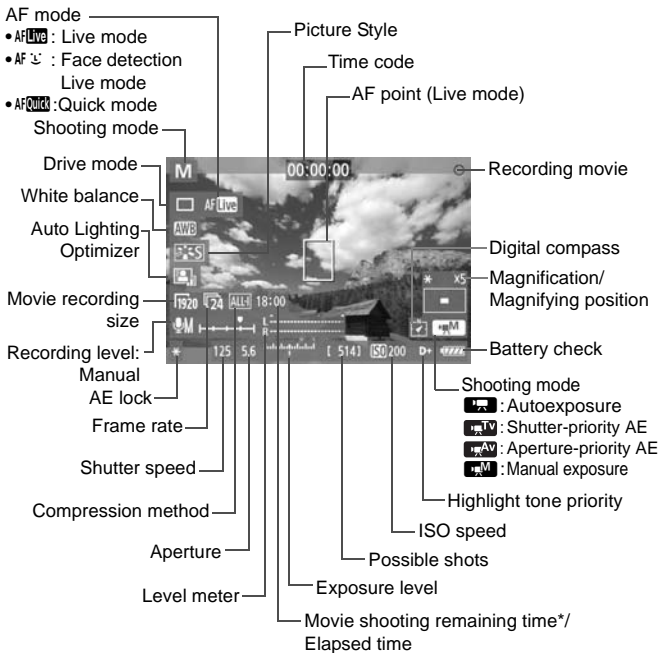

* Applies to a single movie clip.



- You can display the electronic level by pressing the <INFO.> button (p.62).
- If the AF mode is set to [**Live mode**] or if the camera is connected to a TV set with an HDMI cable (p.275), the electronic level is not displayed.
- If there is no card in the camera, the movie shooting remaining time will be displayed in red.
- When movie shooting starts, the movie shooting remaining time will change to the elapsed time.

Notes on Movie Shooting

- The camera cannot autofocus continuously like a camcorder.
- Autofocusing during movie shooting may momentarily throw the focus far off or change the exposure.
- When you autofocus during movie shooting under low-light conditions using a USM lens, horizontal stripes (noise) may be recorded. Note that with certain lenses equipped with the electronic focusing ring, similar noise may be recorded even with manual focusing (MF).
- Do not point the camera toward an intense light source, such as the sun on a sunny day or an intense artificial light source. Doing so may damage the image sensor or the camera's internal components.
- Under [**F1: Record func+card/folder sel.**], even if [**Record func.**] is set to [**Rec. to multiple**] (p.120), the movie cannot be recorded to both Card 1 <[1]> and Card 2 <[2]>. If [**Rec. separately**] or [**Rec. to multiple**] is set, the movie will be recorded to the card which is set for [**Playback**].
- If <**AWB**> is set and the ISO speed or aperture changes during movie shooting, the white balance may also change.
- If you shoot a movie under fluorescent or LED lighting, the movie may flicker.
- Zooming the lens during movie shooting is not recommended. Zooming the lens can cause changes in the exposure regardless of whether the lens' maximum aperture changes or not. Exposure changes may be recorded as a result.
- **Cautions for movie shooting are on pages 249 and 250.**
- **If necessary, also read the Live View shooting cautions on pages 223 and 224.**

- Movie-related settings are under the [**4**] and [**5**] tabs (p.247).
- A movie file is recorded each time you shoot a movie. If the file size exceeds 4 GB, a new file will be created.
- The movie image's field of view is approx. 100% (with movie recording size set to [**F20**]).
- You can also focus the image by pressing the <**AF-ON**> button.
- To focus during movie shooting, press the <**AF-ON**> button. You cannot focus by pressing the shutter button.

Notes on Movie Shooting



- Under [**5: Movie shoot. btn**], if [/MFn] is selected, you can press the shutter button completely to start or stop the movie shooting (p.248).
- Monaural sound is recorded by the camera's built-in microphone (p.227).
- By connecting a stereo microphone (commercially available) equipped with a 3.5 mm mini plug to the camera's external microphone IN terminal (p.21), stereo sound recording is possible.
- With a fully-charged Battery Pack LP-E4N, the total movie shooting time will be as follows: approx. 2 hr. 10 min. at room temperature (23°C/73°F), and approx. 2 hr. at low temperatures (0°C/32°F).
- The focus preset function is possible for movie shooting when using a (super) telephoto lens equipped with the focus preset mode marketed since the second half of 2011.

Final Image Simulation

The final image simulation is a function that allows you to see the effects of the Picture Style, white balance, etc., on the image.

During movie shooting, the image displayed will automatically reflect the effects of the settings listed below.

Final image simulation for movies

- Picture Style
 - * All settings such as sharpness, contrast, color saturation, and color tone will be reflected.
- White balance
- White balance correction
- Exposure
- Depth of field
- Auto Lighting Optimizer
- Peripheral illumination correction
- Chromatic aberration correction
- Highlight tone priority

Shooting Still Photos

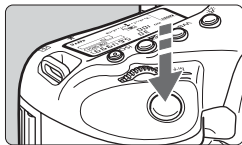

While shooting a movie, you can also take a still photo by pressing the shutter button completely.

Taking still photos during movie shooting

- If you take a still photo during movie shooting, the movie will record a still moment lasting approx. 1 sec.
- The captured still photo will be recorded to the card, and the movie shooting will resume automatically when the Live View image is displayed.
- The movie and still photo will be recorded as separate files on the card.
- If [**Record func.**] (p.120) is set to [**Standard**] or [**Auto switch card**], the movies and still photos will be recorded to the same card. If [**Rec. separately**] or [**Rec. to multiple**] is set, the movies will be recorded to the card set for [**Playback**]. The still photos will be recorded at the image-recording quality set for the respective card.
- Functions particular to still photo shooting are shown below. Other functions will be the same as for movie shooting.

Function	Settings
Image-Recording Quality	As set with [2: Img type/size] and [2: JPEG quality].
ISO Speed*	<ul style="list-style-type: none"> ● <P/Tv/Av/BULB>: ISO 100 - 25600 ● <M>: See "ISO speed during manual-exposure shooting" on page 232.
Exposure Setting	<ul style="list-style-type: none"> ● <P/BULB>: Automatically set shutter speed and aperture. ● <Tv>: Manually set shutter speed and automatically set aperture. ● <Av>: Manually set aperture and automatically set shutter speed. ● <M> : Manually set shutter speed and aperture.

* If highlight tone priority is set, the ISO speed range will start from ISO 200.







- AEB cannot be used.
- Even if an external Speedlite is used, it will not fire.
- Continuous still photo shooting is possible during movie shooting. However, the captured images will not be displayed on the screen. Depending on the still photo's image-recording quality, number of shots during continuous shooting, card performance, etc., the movie shooting may stop automatically.
- If [CAM: Movie shoot. btn] is set to [👁/M-Fn], still photo shooting is not possible.





- If you want to shoot still photos continuously during movie shooting, using a high-speed card is recommended. Setting a smaller image size for still photos and shooting fewer continuous still photos are also recommended.
- You can shoot still photos in all drive modes.
- The self-timer can be used before you start shooting a movie. If used during movie shooting, the self-timer will switch to single shooting.

Shooting Function Settings

MODE / AF / DRIVE / / ISO / / WB Settings

If you press the <MODE>, <AF•DRIVE>, <>, <ISO>, <>, or <WB> button while the image is displayed on the LCD monitor, the setting screen will appear on the LCD monitor and you can turn the <> or <> dial to set the respective function.

When **AFQuick** is set, you can press the <> button to select the AF area selection mode and AF point. The procedure is the same as with viewfinder shooting. During manual-exposure shooting (p.231), you can press the <ISO> button to set the ISO speed.

Note that the <> metering mode and <> flash exposure compensation cannot be set.



Quick Control

If you press the <> button while the image is displayed on the LCD monitor, you can set the following: AF mode, drive mode, white balance, Picture Style, Auto Lighting Optimizer, movie-recording size, and sound-recording level (with [**Sound recording: Manual**] set).

1 Press the <> button.

- ▶ The settable functions will be displayed.

2 Select a function and set it.

- Use <> to select a function.
- ▶ The setting of the selected function is displayed at the bottom.
- Turn the <> or <> dial to set it.

 During movie shooting, you can set the following: Shutter speed, aperture, ISO speed, exposure compensation, and sound-recording level. (Settable functions may differ depending on the shooting mode and [**Sound recording**] setting.)

MENU Setting the Movie-Recording Size



With [**4: Movie rec. size**], you can set the movie's image size, frame rate per second, and compression method. The frame rate switches automatically depending on the [**3: Video system**] setting.

● Image size

- 1920 [1920x1080]** : Full High-Definition (Full HD) recording quality. The aspect ratio will be 16:9.
- 1280 [1280x720]** : High-Definition (HD) recording quality. The aspect ratio will be 16:9.
- 640 [640x480]** : Standard-definition recording quality. The aspect ratio will be 4:3.

● Frame rate (fps: frames per second)

- 30/60** : For areas where the TV format is NTSC (North America, Japan, Korea, Mexico, etc.).
- 25/50** : For areas where the TV format is PAL (Europe, Russia, China, Australia, etc.).
- 24** : Mainly for motion pictures.

● Compression method

- IPB** IPB : Efficiently compresses multiple frames at a time for recording. Since the file size will be smaller than with ALL-I, you can shoot longer.
- ALL-I** ALL-I (I-only) : Compresses one frame at a time for recording. Although the file size will be bigger than with IPB, the movie will be more suited for editing.

Total Movie Recording Time and File Size Per Minute

Movie-Recording Size	Total Recording Time (approx.)			File Size (approx.)	
	4 GB Card	8 GB Card	16 GB Card		
F1920	30 25 24 IPB	16 min.	32 min.	1 hr. 4 min.	235 MB/min.
	30 25 24 ALL-I	5 min.	11 min.	22 min.	685 MB/min.
F1280	60 50 IPB	18 min.	37 min.	1 hr. 14 min.	205 MB/min.
	60 50 ALL-I	6 min.	12 min.	25 min.	610 MB/min.
F640	30 25 IPB	48 min.	1 hr. 37 min.	3 hr. 14 min.	78 MB/min.

● About Movies Exceeding 4 GB

Even if you shoot a movie exceeding 4 GB, you can keep shooting without interruption.

During movie shooting, approx. 30 sec. before the movie reaches the 4 GB file size, the elapsed shooting time or time code displayed in the movie-shooting image will start blinking. If you keep shooting until the movie file size exceeds 4 GB, a new movie file will be created automatically and the elapsed shooting time or time code will stop blinking.

When you play back the movie, you will have to play each movie file individually. Movie files cannot play back consecutively automatically. After the movie playback ends, select the next movie to be played.

● Movie Shooting Time Limit

The maximum recording time of one movie clip is 29 min. 59 sec. If the movie shooting time reaches 29 min. 59 sec., the movie shooting will stop automatically. You can start shooting a movie again by pressing the <M-Fn> button. (A new movie file is recorded.)



- An increase of the camera's internal temperature may cause movie shooting to stop before the maximum recording time shown on the preceding page (p.249).
- Even if **[Record func.]** is set to **[Auto switch card]**, the card cannot be switched automatically during movie shooting.



About Full HD 1080

Full HD 1080 indicates compatibility with High-Definition featuring 1080 vertical pixels (scanning lines).



MENU Setting the Sound Recording

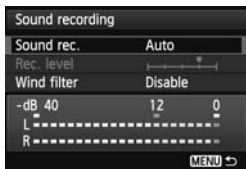

You can shoot movies while recording sound with the built-in monaural microphone or with a commercially-available stereo microphone. You can also freely adjust the sound-recording level.

Set the sound recording with [**4: Sound recording**].

Sound Recording/Sound-Recording Level

- [Auto]** : The sound-recording level is adjusted automatically. Auto level control will operate automatically in response to the sound level.
- [Manual]** : For advanced users. You can adjust the sound recording level to one of 64 levels. Select [**Rec. level**] and look at the level meter while turning the <⦿> dial to adjust the sound-recording level. While looking at the peak hold indicator (approx. 3 sec.), adjust so that the level meter sometimes lights up the “12” (-12 dB) mark on the right for the loudest sounds. If it exceeds “0”, the sound will be distorted.
- [Disable]** : Sound will not be recorded.

Wind Filter

When set to [**Enable**], it reduces wind noise when there is wind outdoors. This feature works only with the built-in microphone. Note that [**Enable**] will also reduce low bass sounds, so set this function to [**Disable**] when there is no wind. It will record a more natural sound than with [**Enable**].

- **Using the microphone**

The built-in microphone records monaural sound. Stereo sound recording is possible by connecting an external stereo microphone (commercially-available) equipped with a miniature stereo plug (3.5 mm) to the camera's external microphone IN terminal (p.21). When an external microphone is connected, sound recording will switch automatically to the external microphone.





- The sound volume balance between L (left) and R (right) cannot be adjusted.
- Both L and R record audio at a 48 kHz/16-bit sampling rate.
- If [CAMERA 5: Silent Control] is set to [Enable] (p.244), you can adjust the sound-recording level with the < [Mute] > touch pad to reduce the operation noise during movie shooting.

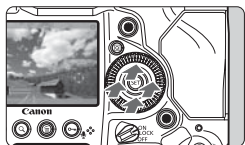

MENU Silent Control

This function is convenient when you want to change the ISO speed, sound-recording level, etc., silently while shooting a movie.







When [**5: Silent Control**] is set to [**Enable** , you can use the touch pad < > on the inner ring of the Quick Control Dial.

You can operate the camera silently just by touching the top, bottom, left, or right of < >.

During movie shooting, you can press < > to display the Quick Control screen and change the settings below with < >.

Settable Functions	Shooting Mode			
	P/B	Tv	Av	M
1. Shutter speed	–	○	–	○
2. Aperture	–	–	○	○
3. ISO speed	–	–	–	○
4. Exposure compensation	○	○	○	○*
5. Sound-recording level	○	○	○	○

* When Auto ISO is set

- If [**5: Silent Control**] is set to [**Enable** , you cannot adjust the sound-recording level with the < > Quick Control dial during movie shooting.
- Even if you change the aperture silently with < >, the movie will still record the lens aperture-driving sound.
- If there is water or dirt on < >, the touch operation may not work. In such a case, use a clean cloth to clean < >. If it still does not work, wait a while and try again.

Before shooting a movie, use < > to adjust the sound-recording level in the Quick Control and [**Rec. level**] screens.

MENU Setting the Time Code

Time code	
Count up	Rec run
Start time setting	
Movie rec count	Rec time
Movie play count	Rec time
Drop frame	Enable
MENU →	

The time code is a time reference recorded automatically to synchronize the video and audio during movie shooting. It is recorded at all times in the following units: hours, minutes, seconds, and frames. It is mainly used during movie editing.

Set the time code with [CAMERA 5: Time code].

Count Up

[Rec run] : The time code counts up only while you are shooting a movie. The time code will be continuous across sequential movie files.

[Free run] : The time code counts up whether you are shooting or not.

Start Time Setting

You can set the time code's start time.

[Manual input setting] : You can freely set the hour, minute, second, and frame.

[Reset] : The time set with [Manual input setting] and [Set to camera time] is reset to 00:00:00:00.

[Set to camera time] : Sets hours, minutes, and seconds to match the camera's internal clock. "Frames" will be set to 00.

Movie Recording Count

You can select what to display on the movie-shooting screen.

[Rec time] : Indicates the elapsed time from the start of the movie shooting.

[Time code] : Indicates the time code during movie shooting.



- Shooting still photos during movie shooting will cause a discrepancy between the actual time and time code.
- If [Free run] is set and you change the time, zone, or daylight saving time (p.40), the time code will be affected.

Regardless of the [Movie rec count] setting, the time code will always be recorded to the movie file.

Movie Playback Count

You can select what to display on the movie playback screen.

[Rec time] : Displays the recording time and playback time during movie playback.

[Time code] : Displays the time code during movie playback.

With [Time code] set:



During movie shooting



During movie playback

- If you change the setting for either [Movie play count] in [CAMERA (movie): Time code] or for [CAMERA 3: Movie play count], the other setting will also change automatically.
- "Frames" are not displayed during movie shooting and movie playback.

Drop Frame

If the frame rate setting is 29.97 (29.97 fps) or 59.94 (59.94 fps), the time code's frame count causes a discrepancy between the actual time and time code. This discrepancy can be corrected automatically. This correction function is called drop frame.

[Enable] : The discrepancy is corrected automatically by skipping time code numbers (DF: Drop frame).

[Disable] : The discrepancy is not corrected (NDF: Non-drop frame).

When the frame rate is set to 23.976 (23.976fps), 25 (25.00fps), or 50 (50.00fps), the drop frame function does not take effect. (If 23.976 is set or [CAMERA 3: Video system] is set to [PAL], drop frame option will not be displayed.)

MENU Menu Function Settings

[CAMERA 4] Menu



When you select **[Movies]** under **[CAMERA 4: LV [CAMERA 4]/[CAMERA 5] set.]**, the **[CAMERA 4]** **[CAMERA 5]** tabs for movie shooting will appear. The menu options are as follows.

- **AF mode**

The AF modes will be the same as described on pages 215-221. You can select **[Live mode]**, **[L Live mode]**, or **[Quick mode]**. Note that continuous focusing of a moving subject is not possible. Even if the AF mode is set to **[Quick mode]**, it will switch to **[Live mode]** during movie shooting.

- **Grid display**

With **[3x3]** or **[6x4]**, you can display grid lines to help you level the camera vertically or horizontally. Also, with **[3x3+diag]**, the grid is displayed together with diagonal lines to help you align the intersections over the subject for better balance in the composition.

- **Movie recording size**

You can set the movie recording size (image size, frame rate, and compression method). For details, see pages 239 to 241.

- **Sound recording**

You can set sound recording settings. For details, see pages 242 and 243.

- **Silent LV shooting**

This function applies to still photo shooting. For details, see page 214.

- **Metering timer**

You can change how long the exposure settings are displayed (AE lock time).

[📷5] Menu

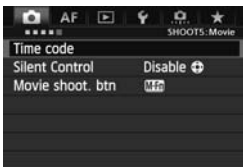

- **Time code**

You can set the time code. For details, see pages 245 and 246.

- **Silent Control**

When [**Enable** 🕒] is set, you can use the touch pad <🕒> and Quick Control screen to change settings silently during movie shooting. For details, see page 244.

- **Movie shooting button**

When [**📷/M-Fn**] is set, besides pressing the <M-Fn> button, you can also press the shutter button completely or use Remote Switch RS-80N3 (sold separately) or Timer Remote Controller TC-80N3 (sold separately) to start/stop the movie shooting (p.185). However, when [**📷/M-Fn**] is set, still photo shooting is not possible (p.236).



Movie Shooting Cautions

White <[Icon]> and Red <[Icon]> Internal Temperature Warning Icons

- If the camera's internal temperature increases due to prolonged movie shooting or a high ambient temperature, a white icon <[Icon]> will appear. Even if you shoot a movie while this icon is displayed, the movie's image quality will hardly be affected. However, if you shoot still photos, the image quality of the still photos may degrade. You should stop shooting still photos for a while and allow the camera to cool down.
- If the camera's internal temperature further increases while the white icon <[Icon]> is displayed, a red icon <[Icon]> may start blinking. This blinking icon is a warning that movie shooting will soon stop automatically. If this happens, you will not be able to shoot again until the camera's internal temperature decreases. Turn off the power and let the camera rest for a while.
- Shooting a movie at a high temperature for a prolonged period will cause the <[Icon]> and <[Icon]> icons to appear earlier. When you are not shooting, turn off the camera.

Recording and Image Quality

- If the attached lens has an Image Stabilizer, the Image Stabilizer will operate at all times even if you do not press the shutter button halfway. The Image Stabilizer consumes battery power and may shorten the total movie shooting time or decrease the number of possible shots. If you use a tripod or if the Image Stabilizer is not necessary, you should set the IS switch to <OFF>.
- The camera's built-in microphone will also pick up camera operation noise. Using a commercially-available external microphone can prevent (or reduce) these noises from being recorded.
- Do not connect anything other than an external microphone to the camera's external microphone IN terminal.
- If there is a very bright light source in the picture, the bright area may appear black on the LCD monitor. In movies, the bright areas will be recorded in almost the same way you see it on the LCD monitor.
- In low light, noise or irregular colors may appear in the image. In movies, the bright areas will be recorded in almost the same way you see it on the LCD monitor.

Movie Shooting Cautions

Recording and Image Quality

- If you use a card with a slow writing speed, a five-level indicator may appear on the right of the screen during movie shooting. It indicates how much data has not yet been written to the card (remaining capacity of the internal buffer memory). The slower the card, the faster the indicator will climb upward. If the indicator becomes full, movie shooting will stop automatically.

If the card has a fast writing speed, the indicator will either not appear or the level (if displayed) will hardly go upward.

First, shoot a few test movies to see if the card can write fast enough.



Indicator

Still Photo Shooting During Movie Shooting

- Regarding the image quality of still photos, see “Image Quality” on page 223.

Playback and TV Connection

- In autoexposure shooting, shutter-priority AE, or aperture-priority AE modes, if the brightness changes during movie shooting, the movie may freeze temporarily. In such cases, shoot movies with manual exposure.
- If you connect the camera to a TV set (p.275, 278) and shoot a movie, the TV will not output any sound during the shooting. However, the sound will be properly recorded.

8

Image Playback

This chapter explains how to play back and erase photos and movies, how to display them on a TV screen, and other playback-related functions.

About images taken with another camera

The camera may not be able to properly display images captured with a different camera or edited with a computer or whose file name was changed.

▶ Image Playback

Single-Image Display

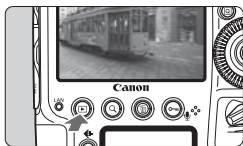

1 Play back the image.

- Press the <▶> button.
- ▶ The last captured image or last image viewed will appear.



2 Select an image.

- To play back images starting with the last image, turn the <◀> dial counterclockwise. To play back images starting with the first captured image, turn the dial clockwise.
- Each time you press the <INFO.> button, the display format will change.



No information



With basic information

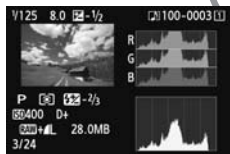

Histogram

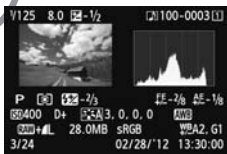

Shooting information display

3 Exit the image playback.

- Press the <▶> button to exit the image playback and return to shooting-ready state.

MENU Grid Display

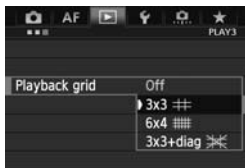

With single-image display, you can overlay the grid on the image during playback.

With [**▶3: Playback grid**], you can select [**3x3** ⇨], [**6x4** ▨], or [**3x3+diag** ✖].

This function is convenient for checking the image's tilt and composition.



The grid is not displayed during movie playback.

INFO.: Shooting Information Display

Sample Information for Still Photos

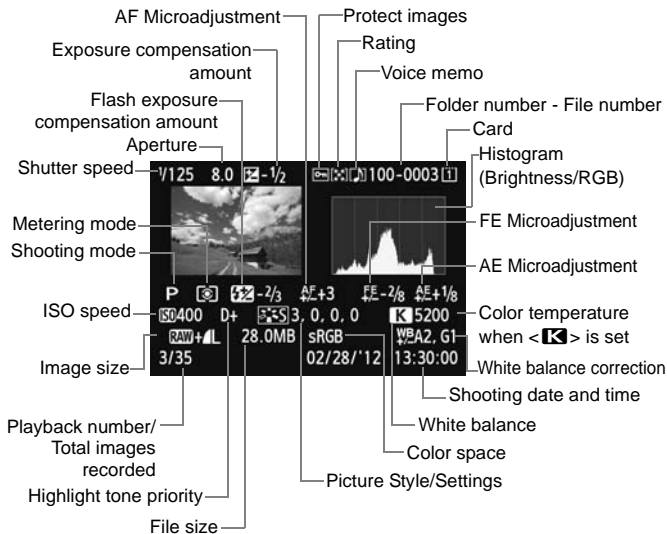

- * When you shoot in RAW+JPEG image quality, the RAW image file size will be displayed.
- * During flash photography without flash exposure compensation, <[Flash icon]> will be displayed.
- * <[Multiple exposure icon]> will be displayed for multiple-exposure photos.
- * For still photos taken during movie shooting, <[Movie icon]> will be displayed.
- * For JPEG images developed with the camera's RAW processing function or resized, and then saved, <[RAW icon]> will be displayed.

Sample Information for Movies

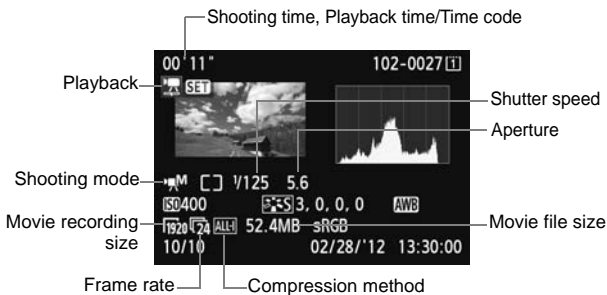

- **About the Highlight Alert**

When [3: Highlight alert] is set to [**Enable**], overexposed highlight areas will blink. To obtain more image detail in the overexposed areas, set the exposure compensation to a negative amount and shoot again.

- **About the AF Point Display**

When [3: AF point disp.] is set to [**Enable**], the AF point that achieved focus will be displayed in red. If automatic AF point selection was used, multiple AF points may be displayed.

● About the Histogram

The brightness histogram shows the exposure level distribution and overall brightness. The RGB histogram is for checking the color saturation and gradation. The display can be switched with [**▶** 3: Histogram].

[Brightness] Display

This histogram is a graph showing the distribution of the image's brightness level. The horizontal axis indicates the brightness level (darker on the left and brighter on the right), while the vertical axis indicates how many pixels exist for each brightness level. The more pixels there are toward the left, the darker the image. And the more pixels there are toward the right, the brighter the image. If there are too many pixels on the left, the shadow detail will be lost. And if there are too many pixels on the right, the highlight detail will be lost. The gradation in-between will be reproduced. By checking the image and its brightness histogram, you can see the exposure level inclination and the overall gradation.

Sample Histograms



Dark image



Normal brightness



Bright image

[RGB] Display

This histogram is a graph showing the distribution of each primary color's brightness level in the image (RGB or red, green, and blue). The horizontal axis indicates the color's brightness level (darker on the left and brighter on the right), while the vertical axis indicates how many pixels exist for each color's brightness level. The more pixels there are toward the left, the darker and less prominent the color. And the more pixels there are toward the right, the brighter and denser the color. If there are too many pixels on the left, the respective color information will be lacking. And if there are too many pixels on the right, the color will be too saturated with no gradation. By checking the image's RGB histogram, you can see the color's saturation and gradation condition and white balance inclination.

▶ Searching for Images Quickly

▣ Display Multiple Images on One Screen (Index Display)

You can search for images quickly with the index display showing four or nine images on one screen.

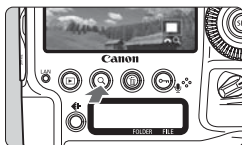



1 Press the <Q> button.

- During image playback, press the <Q> button.
- ▶ [ Q] will be displayed on the lower right of the screen.





2 Switch to the index display.

- Turn the < > dial counterclockwise.
- ▶ The 4-image index display will appear. The currently-selected image will be highlighted in a blue frame.
- If you turn the < > dial further counterclockwise, the 9-image index display will appear. Turning the < > dial clockwise will switch the display from 9 images to 4 images and then to 1 image.



3 Select an image.

- Turn the < > dial to move the blue frame and select the image.
- Press the <Q> button to turn off the [ Q] icon, then turn the < > dial to go to the next or preceding screen.
- Press <SET> in the index display, and the selected image will be displayed as a single image.

Jump through Images (Jump Display)

With the single-image display, you can turn the < > dial to jump through the images forward or backward according to the jump method set.

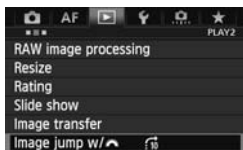

1 Select [Image jump w/].

- Under the [▶2] tab, select [Image jump w/ ], then press <SET>.

2 Select the jump method.

- Turn the < > dial to select the jump method, then press <SET>.

: **Display images one by one**

: **Jump 10 images**

: **Jump 100 images**

: **Display by date**

: **Display by folder**

: **Display movies only**

: **Display stills only**

: **Display protected images only**

: **Display by image rating (p.262)**

Turn the < > dial to select rating.

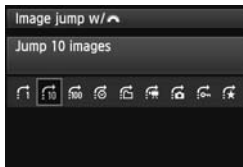

Jump method

Playback position

3 Browse by jumping.

- Press the <▶> button to play back images.
- On the single-image display, turn the < > dial.

- To search images according to the shooting date, select [Date].
- To search images according to folder, select [Folder].
- If the card contains both movies and still photos, select [Movies] or [Stills] to display only either ones.
- If no images match the selected [Protected] or [Rating], you cannot browse through the images with the < > dial.

Q Magnified View

You can magnify a captured image by approx. 1.5x to 10x on the LCD monitor.

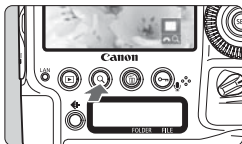

1 Magnify the image.

- The image can be magnified during image playback (single-image display), during image review after image capture, and from shooting-ready state.
- Press the **<Q>** button.
- ▶ The magnified view will appear. The magnified area and [ Q] will be displayed on the lower right of the screen.
- The image magnification increases as you turn the **<ZOOM IN>** dial clockwise. You can magnify the image up to 10x.
- The image magnification decreases as you turn the **<ZOOM IN>** dial counterclockwise. Turning the dial further will display the index display (p.257).



Magnified area position



2 Scroll around the image.

- Use **<ZOOM OUT>** to scroll around the magnified image.
- To exit the magnified view, press the **<Q>** button or **<▶>** button and the single-image display will return.



- In magnified view, you can turn the **<ZOOM IN>** dial to view another image at the same magnification.
- The image can be magnified also during the image review immediately after shooting.
- A movie cannot be magnified.

MENU Magnification Settings

Magnificatn (apx)
1x (no magnification)
2x (magnify from center)
4x (magnify from center)
8x (magnify from center)
10x (magnify from center)
Actual size (from selected pt)
Same as last magnif. (from ctr)

Under the [3] tab, when you select [**Magnificatn (apx)**], you can set the starting magnification and initial position for the magnified view.

- **1x (no magnification)**

The image will not be magnified. The magnified view will start with the single-image display.

- **2x, 4x, 8x, 10x (magnify from center)**

The magnified view will start at the image center at the selected magnification.

- **Actual size (from selected point)**

The recorded image's pixels will be displayed at approx. 100%. The magnified view will start at the AF point that achieved focus. If the photo was taken with manual focus, the magnified view will start at the image center.

- **Same as last magnification (from center)**

The magnification will be the same as the last time you exited the magnified view with the < > or <Q> button. The magnified view starts from the image center.



With images taken with [**Live mode**] (p.215) or [**Live mode**] (p.216), the magnified view starts from the image center.

Rotating the Image

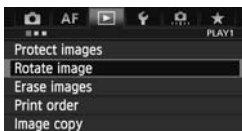
You can rotate the displayed image to the desired orientation.



1 Select [Rotate image].

- Under the [ 1] tab, select [Rotate image], then press < >.



2 Select an image.







- Turn the < > dial to select the image to be rotated.
- You can also select an image on the index display (p.257).



3 Rotate the image.

- Each time you press < >, the image will rotate clockwise as follows: 90° → 270° → 0°.
- To rotate another image, repeat steps 2 and 3.
- Press the <MENU> button to return to the menu.



- If you have set [ 1: Auto rotate] to [On  ] (p.289) before taking vertical shots, you need not rotate the image as described above.
- If the rotated image is not displayed in the rotated orientation during image playback, set [ 1: Auto rotate] to [On  ].
- A movie cannot be rotated.

Setting Ratings

You can rate images and movies with one of five rating marks: [★]/[★] / [★★]/[★★] / [★★★]/[★★★]. This function is called rating.

MENU Set Ratings with the Menu

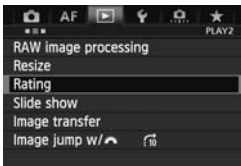

1 Select [Rating].

- Under the [▶]2 tab, select [Rating], then press <SET>.



2 Select an image or movie.

- Turn the <⦿> dial to select the image or movie to be rated.
- If you press the <Q> button and turn the <⦿> dial counterclockwise, you can select an image or movie from a three-image display. To return to the single-image display, turn the <⦿> dial clockwise.



3 Rate the image or movie.

- Pressing <SET> will turn off the [SET] icon.
- Turn the <⦿> dial to select a rating.
- ▶ The total number of images and movies rated will be counted for each rating.
- To rate another image or movie, repeat steps 2 and 3.
- Press the <MENU> button to return to the menu.

Using the <O> Button

Under [**5: O/button function**], if you set [**Rating (O and U disabled)**] (p.338), you can press the <O> button to rate images/movies during playback.

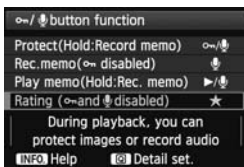

1 Set the <O> button's function.

- Set [**5: O/button function**] to [**Rating (O and U disabled)**].

2 Playback the image.

- Turn the <DIAL> dial to select the image or movie to be rated.



3 Rate the image or movie.

- Each time you press the <O> button, the rating mark will change: [★]/[☆]/[☆]/[☆]/[☆]/None.
- To rate another image or movie, repeat steps 2 and 3.

The total number of images with a given rating can be displayed up to 999. If there are more than 999 images with a given rating, [###] will be displayed for that rating.

Taking advantage of ratings

- With [**2: Image jump w/**], you can display only images and movies with a specific rating.
- With [**2: Slide show**], you can play back only images and movies with a specific rating.
- With Digital Photo Professional (provided software, p.426), you can select only images and movies with a specific rating.
- With Windows 8, Windows 7, and Windows Vista, you can see each file's rating as part of the file information display or in the provided image viewer.

Q Quick Control During Playback

During playback, you can press the **<Q>** button to set the following: **[Q]**: **Protect images**, **[R]**: Rotate image, **[★]**: **Rating**, **[RAW]**: RAW image processing (RAW images only), **[R]**: Resize (JPEG image only), **[ON]**: **Highlight alert**, **[ON]**: **AF point display**, **[↔]**: **Image jump w/ [↔]**.
For movies, only the functions in bold above can be set.



1 Press the **<Q>** button.

- During image playback, press the **<Q>** button.
- ▶ The Quick Control screen will appear.









2 Select a function and set it.

- Tilt **<Q>** up or down to select a function.
- ▶ The setting of the selected function is displayed at the bottom of the screen.
- Turn the **<Q>** dial to set the function.
- For RAW image processing and Resize, press **<SET>** and set the function. For details, see page 292 for RAW image processing and page 297 for Resize. To cancel, press the **<MENU>** button.

3 Exit the setting.

- Press the **<Q>** button to exit the Quick Control screen.

 To rotate an image, set [**1: Auto rotate**] to [**On**  ]. If [**1: Auto rotate**] is set to [**On** ] or [**Off**], the [**Rotate image**] setting will be recorded to the image, but the camera will not rotate the image for display.

- 
- Press the <> button during index display to switch to the single-image display and the Quick Control screen will appear. Pressing the <> button again will return to the index display.
 - For images taken with another camera, the functions you can select may be limited.

Enjoying Movies

You can play back movies in the following three ways:

Playback on a TV set (p.275, 278)

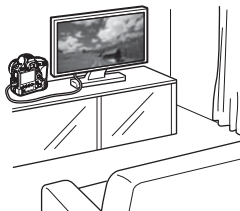

Use the provided AV cable or an HDMI Cable HTC-100 (sold separately) to connect the camera to a TV set. Then you can play back captured movies and still photos on the TV.

If you have a High-Definition TV set and connect your camera with an HDMI cable, you can watch Full High-Definition (Full HD: 1920x1080) and High-Definition (HD: 1280x720) movies with higher image quality.

-  Movies on a card can be played only by devices compatible with MOV files.
- Since hard disk recorders do not have an HDMI IN terminal, the camera cannot be connected to a hard disk recorder with an HDMI cable.
- Even if the camera is connected to a hard disk recorder with a USB cable, movies and still photos cannot be played or saved.

Playback on the Camera's LCD Monitor (p.268-274)

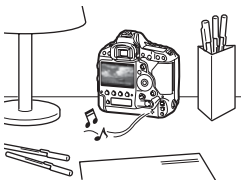

You can play back movies on the camera's LCD monitor. You can also edit out the movie's first and last scenes, and play back the still photos and movies on the card in an automatic slide show.

-  A movie edited with a personal computer cannot be rewritten to the card and played back with the camera.

Playback and Editing with a Personal Computer (p.426)



The movie files recorded on the card can be transferred to a personal computer and played with ImageBrowser EX.

- To have the movie play back smoothly on a personal computer, use a high-performance personal computer. Regarding the computer hardware requirements for ImageBrowser EX, refer to the PDF file ImageBrowser EX User Guide.
- If you want to use commercially-available software to play back or edit the movies, be sure it is compatible with MOV files. For details on commercially-available software, contact the software maker.

▶ Playing Movies

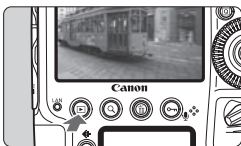

1 Play back the image.

- Press the <▶> button to display images.



2 Select a movie.

- Turn the <☉> dial to select the movie to be played.
- With the single-image display, the <▶ SET> icon displayed on the upper left indicates a movie.
- In the index display, perforations at the left edge of a thumbnail indicate a movie. **As movies cannot be played on the index display, press <SET> to switch to the single-image display.**



3 In the single-image display, press <SET>.

- ▶ The movie playback panel will appear at the bottom of the screen.







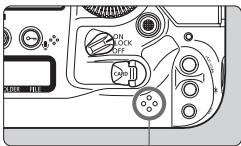





4 Play back the movie.

- Turn the <☉> dial to select [▶] (Play), then press <SET>.
- ▶ The movie will start playing.
- You can pause the movie playback by pressing <SET>.
- During movie playback, you can adjust the sound volume by turning the <☉> dial.
- For more details on the playback procedure, see the next page.



Speaker

Function	Playback Description
 Exit	Returns to the single-image display.
 Play	Pressing <SET> toggles between play and stop.
 Slow motion	Adjust the slow motion speed by turning the <DIAL>. The slow-motion speed is indicated at the upper right of the screen.
 First frame	Displays the movie's first frame.
 Previous frame	Each time you press <SET>, the previous frame is displayed. If you hold down <SET>, it will rewind the movie.
 Next frame	Each time you press <SET>, the movie will play frame-by-frame. If you hold down <SET>, it will fast forward the movie.
 Last frame	Displays the movie's last frame.
 Edit	Displays the editing screen (p.270).
	Playback position
mm' ss"	Playback time (minutes:seconds with [Movie play count: Rec time] set)
hh:mm:ss:ff	Time code (hours:minutes:seconds:frames with [Movie play count: Time code] set)
 Volume	You can adjust the built-in speaker's (p.268) volume by turning the <DIAL> dial.



- With a fully-charged Battery Pack LP-E4N, the continuous playback time at 23°C/73°F will be as follows: approx. 4 hr. 50 min.
- If you connect the camera to a TV set (p.275, 278) to play back a movie, adjust the sound volume with the TV set. (Turning the <DIAL> dial will not adjust the sound volume.)
- If you took a still photo while you shot the movie, the movie image displayed will look still for approx. 1 sec.

✂ Editing the Movie's First and Last Scenes

You can edit out the first and last scenes of a movie in 1-sec. increments.



1 On the movie playback screen, select [✂].

- ▶ The movie editing panel will be displayed at the bottom of the screen.



2 Specify the part to be edited out.

- Select either [✂] (Cut beginning) or [✂] (Cut end), then press <SET>.
- Tilt <⊙> to the left or right to see the previous or next frames. Holding it down will fast forward the frames. Turn the <⊙> dial for frame-by-frame playback.
- After deciding which part to edit out, press <SET>. The portion highlighted in blue on the top of the screen is what will remain.



3 Check the edited movie.

- Select [▶] and press <SET> to play back the portion highlighted in blue.
- To change the editing, go back to step 2.
- To cancel the editing, select [↶] and press <SET>.





4 Save the movie.

- Select [**⏏**], then press <ⓈET>.
- ▶ The save screen will appear.
- To save it as a new movie, select [**New file**]. To save it and overwrite the original movie file, select [**Overwrite**]. Then press <ⓈET>.
- On the confirmation screen, select [**OK**], then press <ⓈET> to save the edited movie and return to the movie playback screen.



- Since the editing is performed in 1-sec. increments (position indicated by [**⏏**]), the exact position where the movie is edited may differ slightly from the position you specified.
- If the card does not have enough free space, [**New file**] will not be available.

MENU Slide Show (Auto Playback)

You can play back the images on the card as an automatic slide show.

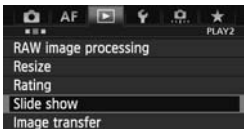

1 Select [Slide show].

- Under the [▶] 2 tab, select [Slide show], then press <SET>.

Number of images to be played



2 Select the images to be played.

- Turn the <◉> dial to select the desired option, then press <SET>.

[All images/Movies/Stills/Protect]

- Turn the <◉> dial to select one of the following: [📁] All images/ [🎞️] Movies/ [🖼️] Stills/ [🔒] Protect]. Then press <SET>.

[Date/Folder/Rating]

- Turn the <◉> dial to select one of the following: [📅] Date/ [📁] Folder/ [★] Rating].
- When <INFO. ✓> is highlighted, press the <INFO.> button.
- Turn the <◉> dial to select the desired setting, then press <SET>.

[Date]



[Folder]



[Rating]



Item	Playback Description
All images	All the still photos and movies on the card will be played back.
Date	Still photos and movies taken on the selected shooting date will be played back.
Folder	Still photos and movies in the selected folder will be played back.
Movies	Only the movies on the card will be played back.
Stills	Only the still photos on the card will be played back.
Protect	Only the protected images and movies on the card will be played back.
Rating	Only the still photos and movies with the selected rating will be played back.



3 Set the play time and repeat option.

- Turn the < > dial to select [**Set up**], then press < >.
- For still photos, set the [**Display time**] and [**Repeat**] options, then press the <MENU> button.

[Display time]

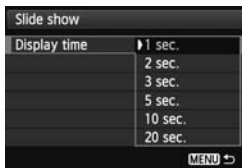

[Repeat]





4 Start the slide show.

- Turn the <☉> dial to select [**Start**], then press <SET>.
- ▶ After [**Loading image...**] is displayed, the slide show will start.

5 Quit the slide show.

- To quit the slide show and return to the setting screen, press the <MENU> button.

- To pause the slide show, press <SET>. During pause, [||] will be displayed on the upper left of the image. Press <SET> again to resume the slide show.
- During auto playback, you can press the <INFO.> button to change the still photo display format (p.252).
- During movie playback, you can adjust the sound volume by turning the <☂> dial.
- During auto playback or pause, you can turn the <☉> dial to view another image.
- During auto playback, auto power off will not work.
- The display time may vary depending on the image.
- To view the slide show on a TV set, see pages 275 and 278.

Viewing the Images on TV

You can view the still photos and movies on a TV set.



- Adjust the movie's sound volume with the TV set. The sound volume cannot be adjusted with the camera.
- Before connecting or disconnecting the cable between the camera and television, turn off the camera and TV set.
- Depending on the TV set, part of the image displayed may be cut off.

Viewing on High-Definition (HD) TV Sets

HDMI Cable HTC-100 (sold separately) is required.

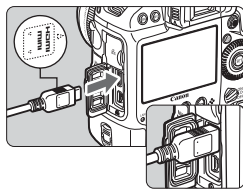

1 Connect the HDMI cable to the camera.

- With the plug's <▲HDMI MINI> logo facing the front of the camera, insert it into the <HDMI> terminal.

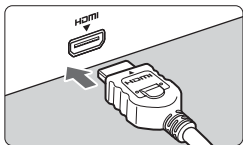

2 Connect the HDMI cable to the TV set.

- Connect the HDMI cable to the TV's HDMI IN port.

3 Turn on the TV and switch the TV's video input to select the connected port.

4 Set the camera's power switch to <ON>.

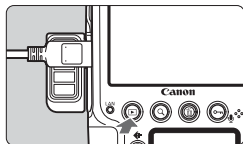

5 Press the <▶> button.

- ▶ The image will appear on the TV screen. (Nothing will be displayed on the camera's LCD monitor.)
- The images will automatically be displayed at the TV's optimum resolution.
- By pressing the <INFO.> button, you can change the display format.
- To play back movies, see page 268.

! A movie cannot be output at the same time from both the <HDMI> and <A/V OUT> terminals.

- Do not connect any other device's output to the camera's <HDMI> terminal. Doing so may cause a malfunction.
- Certain TVs may not be able to play back the captured images. In such a case, use the provided AV cable to connect to the TV.

Using HDMI CEC TV Sets

If the TV set connected to the camera with an HDMI cable is compatible with HDMI CEC*, you can use the TV set's remote control for playback operations.

* An HDMI-standard function enabling HDMI devices to control each other so that you can control them with one remote control unit.

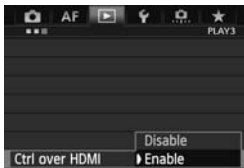

1 Set [Ctrl over HDMI] to [Enable].

- Under the [▶3] tab, select [Ctrl over HDMI], then press <SET>.
- Select [Enable], then press <SET>.

- 2 **Connect the camera to a TV set.**
 - Use an HDMI cable to connect the camera to the TV.
 - ▶ The TV's input will switch automatically to the HDMI port connected to the camera.
- 3 **Press the camera's <▶> button.**
 - ▶ An image will appear on the TV screen and you can use the TV's remote control to play back images.
- 4 **Select an image or movie.**
 - Point the remote control toward the TV set and press the ←/→ button to select an image.

Still photo playback menu



Movie playback menu



- : Return
- : 9-image index
- : Play movie
- : Slide show
- INFO.** : Disp. shooting info
- : Rotate

- 5 **Press the remote control's Enter button.**
 - ▶ The menu appears and you can perform the playback operations shown on the left.
 - Press the ←/→ button to select the desired option, then press the Enter button. For a slide show, press the remote control's ↑/↓ button to select an option, then press the Enter button.
 - If you select [**Return**] and press the Enter button, the menu will disappear and you can use the ←/→ button to select an image.



- Some TV sets require you to first enable the HDMI CEC connection. For details, refer to the TV set's instruction manual.
- Certain TV sets, even those compatible with HDMI CEC, may not operate properly. In such a case, set [**▶3: Ctrl over HDMI**] to [**Disable**], and use the camera to control the playback operation.

Viewing on Non High-Definition (HD) TV Sets

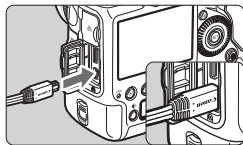

1 Connect the provided AV cable to the camera.

- With the plug's <Canon> logo facing the back of the camera, insert it into the <A/V OUT> terminal.

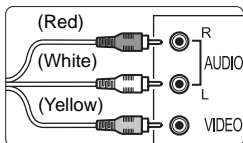

2 Connect the AV cable to the TV set.

- Connect the AV cable to the TV's video IN terminal and audio IN terminal.

3 Turn on the TV and switch the TV's video input to select the connected port.

4 Set the camera's power switch to <ON>.

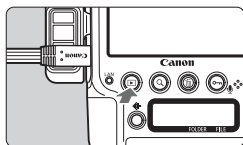

5 Press the <▶> button.

- ▶ The image will appear on the TV screen. (Nothing will be displayed on the camera's LCD monitor.)
- To play back movies, see page 268.

- Do not use any AV cable other than the one provided. Images may not be displayed if you use a different cable.
- If the video system format set on the camera does not match the TV's, the images will not be displayed properly. If this happens, switch to the proper video system format with [**3**: Video system].

Protecting Images

Protecting an image prevents it from being erased accidentally.

Protecting Images Individually with the <Protect> Button

1 Select the image to be protected.

- Press the <Play> button to play back images, then turn the <Dial> dial to select the image.

Image protect icon



2 Protect the image.

- When you press the <Protect> button, the image will be protected and the <Protect> icon will appear at the top of the screen.
- To cancel the image protection, press the <Protect> button again. The <Protect> icon will disappear.
- To protect another image, repeat steps 1 and 2.

MENU Protecting Images Individually with the Menu

1 Select [Protect images].

- Under the [1] tab, select [Protect images], then press <Set>.

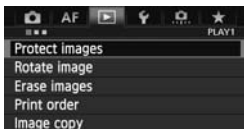







2 Select [Select images].

- Select [Select images], then press <Set>.
- ▶ The images will be displayed.





3 Protect the image.







- Turn the  dial to select the image to be protected, then press .
- ▶ The image will be protected, and the  icon will appear at the top of the screen.
- To cancel the image protection, press  again. The  icon will disappear.
- To protect another image, repeat step 3.
- Press the  button to return to the menu.

Protecting All Images in a Folder or Card

You can protect all the images in a folder or on the card at one time.



When you select **[All images in folder]** or **[All images on card]** under **[ 1: Protect images]**, all the images in the folder or on a card will be protected. To cancel the image protection, select **[Unprotect all images in folder]** or **[Unprotect all images on card]**.

- ❗ ● **If you format the card (p.55), the protected images will also be erased.**
- To protect an image, press and quickly let go of the  button. If you hold down the button for approx. 2 sec., a voice memo will be recorded.
- If [ 5:  /  button function] is not set to **[Protect (Hold: Record memo)]**, you cannot use the  button to protect images. Use [ 1: **Protect images**] to protect images.

-  ● Movies can also be protected.
- Once an image is protected, it cannot be erased by the camera's erase function. To erase a protected image, you must first cancel the protection.
- If you erase all the images (p.287), only the protected images will remain. This is convenient when you want to erase unnecessary images all at once.

Recording and Playing Voice Memos

You can append a voice memo to a captured image. The voice memo will be saved as a WAV sound file with the same file number as the image. It can be played back with the camera or provided software.

Recording a Voice Memo

1 Select the image to which you want to append a voice memo.

- Press the <▶> button to play back images, then turn the <⦿> dial to select the image.

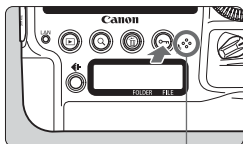

Voice memo microphone

2 Recording a Voice Memo

- Hold down the <🎤> for approx. 2 sec.
- When [Recording memo...] appears, keep pressing the button and speak into the voice memo microphone. The maximum recording time for a voice memo is 30 sec.
- When you have finished speaking, let go of the button.
- ▶ The [🎤] icon will be displayed on the top of the screen.



- You cannot append a voice memo to a protected image.
- You cannot append a voice memo to a movie.
- A voice memo cannot be recorded with an external microphone.

- With [⦿.6: Memo audio quality], you can change the recording quality of the voice memo.
- To record a voice memo longer than 30 sec., repeat step 2.
- You can also record one voice memo right after image capture during the image review by following step 2.

Playing a Voice Memo

When [**5:  button function**] is set to [**Play memo (Hold: Rec. memo)**] (p.338), you can play back a voice memo appended to an image.

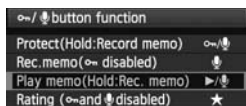



1 Set [**5: button function**] to [**Play memo (Hold: Rec. memo)**].

- Set this function while referring to page 338.



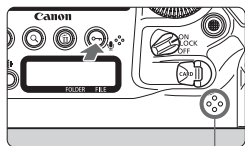

2 Select the image whose voice memo you want to playback.

- Press the <  > button to play back images, then turn the <  > dial to select an image that has the [] icon displayed on the top.



Speaker

3 Playback a voice memo.

- Press the <  > button to play the voice memo.
- Turn the <  > dial to adjust the sound volume.
- To stop playback, press the <  > button.



- If the image has been appended with multiple voice memos, they will be played consecutively.
- Erasing only the voice memo appended to an image is not possible with the camera.
- If the image is erased (p.286), any appended voice memo will also be erased.

Copying Images

The images recorded on one card can be copied to the other card.

MENU Copying Individual Images

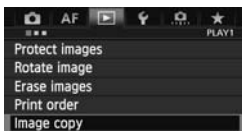

1 Select [Image copy].

- Under the [ 1] tab, select [Image copy], then press <SET>.

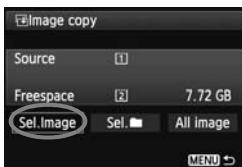

2 Select [Sel. Image].

- Check the copy source and target card's capacity.
- Turn the < > dial to select [Sel. Image], then press <SET>.

3 Select the folder.

- Turn the < > dial to select the folder containing the image to be copied, then press <SET>.
- Refer to the images displayed on the right to select the desired folder.
- ▶ The images in the selected folder will be displayed.



Lowest file number

Number of images in folder

Folder name

Highest file number



The copy source is the card selected in the [ 1: Record func+card/folder sel.] menu's [Record/play] ([Playback]) setting.

Total images selected



4 Select the images to be copied.

- Turn the $\langle \odot \rangle$ dial to select an image to be copied, then press $\langle \text{SET} \rangle$.
- ▶ The $\langle \checkmark \rangle$ icon will appear on the upper left of the screen.
- If you press the $\langle Q \rangle$ button and turn the $\langle \text{Sun} \rangle$ dial counterclockwise, you can select an image from a three-image display. To return to the single-image display, turn the $\langle \text{Sun} \rangle$ dial clockwise.
- To select other images to be copied, repeat step 4.

5 Press the $\langle \text{Fn} \rangle$ button.

- After selecting all the images to be copied, press the $\langle \text{Fn} \rangle$ button.

6 Select [OK].

- Check the target card and press $\langle \text{SET} \rangle$.

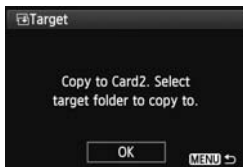

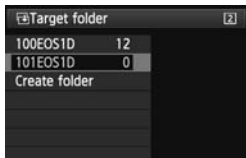

7 Select the target folder.

- Turn the $\langle \odot \rangle$ dial to select the folder to copy the images to, then press $\langle \text{SET} \rangle$.
- To create a new folder, select [**Create folder**].

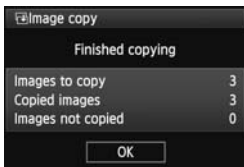
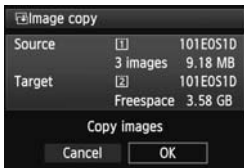





8 Select [OK].

- Check the copy source and target card's information.
- Turn the <  > dial to select [OK], then press <  >.
- ▶ The copying will start and its progress will be displayed.
- When the copying is completed, the result will be displayed.
- Select [OK] to return to the screen in step 2.

MENU Copying All Images in a Folder or Card

You can copy all the images in a folder or on a card at one time. Under [ 1: Image copy], when you select [Sel. ] or [All image], you can copy all the images in the folder or on the card.



- The file name of the copied image will be the same as the source image's file name.
- If [Sel. Image] is set, you cannot copy images in multiple folders at one time. Select images in each folder to copy them folder by folder.
- If an image is being copied to a target folder/card which has an image with the same file number, the following will be displayed: [Skip image and continue] [Replace existing image] [Cancel copy]. Select the copying method, then press <  >.
 - [Skip image and continue]: Any images in the source folder having the same file number as images in the target folder will be skipped and not copied.
 - [Replace existing image]: Any images in the target folder having the same file number as the source images (including protected images) will be overwritten. If an image with a print order (p.315) is overwritten, you will have to set the print order again.
- The image's print order information and image transfer information will not be retained when the image is copied.
- Shooting is not possible during the copying operation. Select [Cancel] before shooting.

Erasing Images

You can either select and erase images one by one or erase them in one batch. Protected images (p.279) will not be erased.

- 1 **Once an image is erased, it cannot be recovered. Make sure you no longer need the image before erasing it. To prevent important images from being erased accidentally, protect them. Erasing a RAW+JPEG image will erase both the RAW and JPEG images.**

Erasing a Single Image

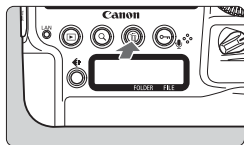



- 1 **Play back the image to be erased.**

- 2 **Press the  button.**

▶ The Erase menu will appear at the bottom of the screen.



- 3 **Erase the image.**

- Turn the  dial to select **[Erase]**, then press . The image displayed will be erased.

-  When you set [**6: Default Erase option**] to **[[Erase] selected]**, you can erase images quicker (p.340).

MENU Checkmarking Images to be Erased in a Batch

By appending checkmarks  to the images to be erased, you can erase multiple images at one time.

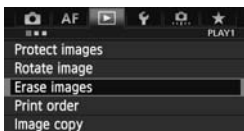

- 1 **Select **[Erase images]**.**

- Under the [**1**] tab, select **[Erase images]**, then press .

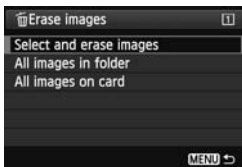

2 Select [Select and erase images].

- Select [Select and erase images], then press <SET>.
- ▶ The images will be displayed.
- If you press the <Q> button and turn the <DISP> dial counterclockwise, you can select an image from a three-image display. To return to the single-image display, turn the <DISP> dial clockwise.



3 Select the images to be erased.

- Turn the <DISP> dial to select the image to be erased, then press <SET>.
- ▶ A <✓> checkmark will be displayed at the upper left of the screen.
- To select other images to be erased, repeat step 3.

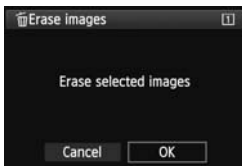

4 Erase the images.

- Press the <TRASH> button.
- Select [OK], then press <SET>.
- ▶ The selected images will be erased.

MENU Erasing All Images in a Folder or Card

You can erase all the images in a folder or on a card at one time. When [▶ 1: Erase images] is set to [All images in folder] or [All images on card], all the images in the folder or card will be erased.



- To also erase protected images, format the card (p.55).
- When [All images on card] is selected, the images will be erased on the card selected under [▶ 1: Record func+card/folder sel.] with [Record/play] ([Playback]).

Changing Image Playback Settings

MENU Adjusting the LCD Monitor Brightness

You can adjust the brightness of the LCD monitor to make it easier to read.

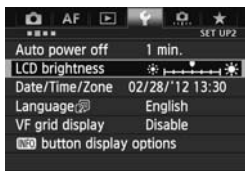

1 Select [LCD brightness].

- Under the [**2**] tab, select [**LCD brightness**], then press <SET>.



2 Adjust the brightness.

- While referring to the gray chart, turn the <DIAL> dial, then press <SET>.

- To check the image's exposure, looking at the histogram is recommended (p.256).
- During image playback, you can press the <DIAL> button to display the screen in step 2 and adjust the brightness.

MENU Auto Rotation of Vertical Images

Vertical images are rotated automatically so they are displayed vertically on the camera's LCD monitor and on the personal computer instead of horizontally. You can change the setting for this feature.

**1** Select **[Auto rotate]**.

- Under the [**1**] tab, select **[Auto rotate]**, then press **<SET>**.

2 Set the auto rotation.

- Select the desired option, then press **<SET>**.

● **On**  

The vertical image is automatically rotated during playback on both the camera's LCD monitor and on the computer.

● **On** 

The vertical image is automatically rotated only on the computer.

● **Off**

The vertical image is not automatically rotated.



Vertical images captured with auto rotation set to **[Off]** will not rotate automatically even if you later switch auto rotation to **[On]** for playback.



- Vertical images will not be automatically rotated immediately after image capture.
- If the vertical image is taken while the camera is pointed up or down, the image may not be rotated automatically for playback.
- If the vertical image is not automatically rotated on the personal computer screen, it means the software you are using is unable to rotate the image. Using the provided software is recommended.

9

Post-Processing Images

You can process RAW images with the camera or resize (shrink) JPEG images.



- The camera may not be able to process images taken with another camera.
- Post-processing images as described in this chapter is not possible if the camera is set for multiple exposures or while it is connected to a personal computer via the <DIGITAL> terminal.

RAW↓ JPEG Processing RAW Images with the Camera ■

You can process **RAW** images with the camera and save them as JPEG images. While the RAW image itself does not change, you can process the RAW image according to different conditions to create any number of JPEG images from it.

Note that **M RAW** and **S RAW** images cannot be processed with the camera. Use Digital Photo Professional (provided software, p.426) to process those images.

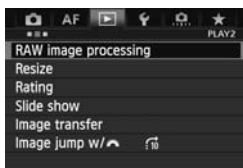

1 Select [RAW image processing].

- Under the [▶]2 tab, select [**RAW image processing**], then press <SET>.
- ▶ **RAW** images will be displayed.



2 Select an image.

- Turn the <◉> dial to select the image you want to process.
- If you press the <Q> button and turn the <☀> dial counterclockwise, you can select an image from the index display.



3 Process the image.

- Press <SET> and the RAW-processing options will appear (p.294-296).
- Use <☼> to select an option, then turn the <◉> dial to set it.
- ▶ The displayed image will reflect “Brightness adjustment”, “White balance”, and the other setting adjustments.
- To return to the image settings at the time of shooting, press the <INFO.> button.

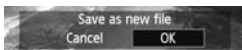

Displaying the setting screen

- Press **<SET>** to display the selected function's setting screen. Turn the **<DISP>** or **<INFO>** dial to change the setting. To return to the screen in step 3, press **<SET>**.

4 Save the image.

















- Select **[L]** (Save), then press **<SET>**.
- Select **[OK]** to save the image.
- Check the destination folder and image file number, then select **[OK]**.
- To process another image, repeat steps 2 to 4.
- Press the **<MENU>** button to return to the menu.

About the Magnified View

You can magnify the image by pressing the **<Q>** button in step 3. The magnification will differ depending on the pixel count for **[Image quality]** set in **[RAW image processing]**. With **<DISP>**, you can scroll around the magnified image.

To cancel the magnified view, press the **<Q>** button again.

RAW Image Processing Options

-  **Brightness adjustment**
You can adjust the image brightness up to ± 1 stop in 1/3-stop increments. The displayed image will reflect the setting's effect.
-  **White balance** (p.143)
You can select the white balance. If you select [**K**], turn the  dial to set the color temperature on the setting screen. The displayed image will reflect the setting's effect.
-  **Picture Style** (p.135)
You can select the Picture Style. To set the parameters such as Sharpness, press  to display the setting screen. Turn the  dial to select the Picture Style. Turn the  dial to select a parameter to be adjusted, then turn the  dial to set it. To return to the screen in step 3, press . The displayed image will reflect the setting's effect.
-  **Auto Lighting Optimizer** (p.152)
You can set the Auto Lighting Optimizer. The displayed image will reflect the setting's effect.
-  **High ISO speed noise reduction** (p.153)
You can set the noise reduction for high ISO speeds. The displayed image will reflect the setting's effect. If the effect is difficult to discern, press the  button to magnify the image. (Press the  button again to return to the normal view.)
- **L Image quality** (p.123)
Set the image-recording quality when converting the image to JPEG. To set the image size and JPEG quality, press  to display the setting screen. Turn the  dial to select a parameter to be adjusted, then turn the  dial to set it. To save the setting and return to the screen in step 3, press .

- sRGB **Color space** (p.168)
You can select either sRGB or Adobe RGB. Since the camera's LCD monitor is not compatible with Adobe RGB, the image will not look very different when either color space is set.
- OFF **Peripheral illumination correction** (p.157)
If [**Enable**] is set, the corrected image will be displayed. If the effect is difficult to discern, press the <Q> button to magnify the image and check the corners. (Press the <Q> button again to return to the normal view.) The peripheral illumination correction applied with the camera will be less pronounced than with Digital Photo Professional (provided software) and may be less apparent. In such a case, use Digital Photo Professional to apply the peripheral illumination correction.
- OFF **Distortion correction**
When [**Enable**] is set, image distortion due to the lens characteristics is corrected. If [**Enable**] is set, the corrected image will be displayed. The image periphery will be cropped in the corrected image due to image processing.
Since the image resolution may decrease slightly, use the Picture Style's Sharpness parameter to make adjustments as necessary.

 When processing images with [**Distortion correction**] set to [**Enable**], AF point display information (p.255) and Dust Delete data (p.301) will not be appended to the image.

● **OFF Chromatic aberration correction**

When **[Enable]** is set, the lens' chromatic aberrations (color fringing along the subject's outline) can be corrected. If **[Enable]** is set, the corrected image will be displayed. If the effect is difficult to discern, press the <Q> button to magnify the image. (Press the <Q> button again to return to the normal view.)

ⓘ **About peripheral illumination correction, distortion correction, and chromatic aberration correction**

To execute peripheral illumination correction, distortion correction, and chromatic aberration correction with the camera, the data of the lens used for the shot must be registered in the camera. If the lens data has not been registered in the camera, use EOS Utility (provided software, p.426) to register the lens data.

ⓘ Processing RAW images in the camera will not produce the same results as processing RAW images with Digital Photo Professional.

Resize

You can resize an image to make the pixel count lower and save it as a new image. Resizing an image is possible only with JPEG **L/M1/M2** images. **JPEG S and RAW images cannot be resized.**

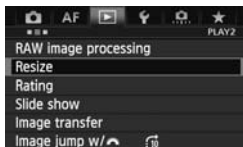

1 **Select [Resize].**

- Under the [**2**] tab, select [**Resize**], then press <SET>.
- ▶ The images will be displayed.



2 **Select an image.**

- Turn the <DISP> dial to select the image you want to resize.
- If you press the <Q> button and turn the <DISP> dial counterclockwise, you can select an image from the index display.



Target sizes

3 **Select the desired image size.**

- Press <SET> to display the image sizes.
- Turn the <DISP> dial to select the desired image size, then press <SET>.



4 **Save the image.**

- Select [**OK**] to save the resized image.
- Check the destination folder and image file number, then select [**OK**].
- To resize another image, repeat steps 2 to 4.
- Press the <MENU> button to return to the menu.

Resize Options According to Original Image Size

Original Image Size	Available Resize Settings		
	M1	M2	S
L	<input type="radio"/>	<input type="radio"/>	<input type="radio"/>
M1		<input type="radio"/>	<input type="radio"/>
M2			<input type="radio"/>

10

Sensor Cleaning

The camera has a Self Cleaning Sensor Unit attached to the image sensor's front layer (low-pass filter) to shake off dust automatically.

The Dust Delete Data can also be appended to the image so that the dust spots remaining can be erased automatically by Digital Photo Professional (provided software, p.426).

About smudges adhering to the front of the sensor

Besides dust entering the camera from outside, in rare cases lubricant from the camera's internal parts may adhere to the front of the sensor. If visible spots still remain after the automatic sensor cleaning, having the sensor cleaned by a Canon Service Center is recommended.



Even while the Self Cleaning Sensor Unit is operating, you can press the shutter button halfway to interrupt the cleaning and start shooting immediately.

Automatic Sensor Cleaning

Whenever you set the power switch to <ON/LOCK> or <OFF>, the Self Cleaning Sensor Unit operates to automatically shake off the dust on the front of the sensor. Normally, you need not pay attention to this operation. However, you can select to perform sensor cleaning at any time, or disable it.

Cleaning the Sensor Now

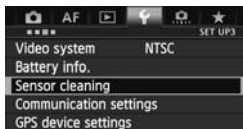

1 Select [Sensor cleaning].

- Under the [3] tab, select [**Sensor cleaning**], then press <SET>.

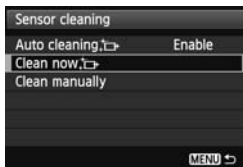

2 Select [Clean now].

- Select [**Clean now **], then press <SET>.
- Select [**OK**] on the dialog screen, then press <SET>.
- ▶ The screen will indicate that the sensor is being cleaned. Although there will be a shutter sound during the cleaning, a picture is not taken.



- For best results, perform the sensor cleaning with the camera placed upright and stable on a table or other flat surface.
- Even if you repeat the sensor cleaning, the result will not improve much. Immediately after the sensor cleaning is finished, the [**Clean now **] option will remain disabled temporarily.

Disabling Automatic Sensor Cleaning

- In step 2, select [**Auto cleaning **] and set it to [**Disable**].
- ▶ The sensor cleaning will no longer be executed when you set the power switch to <ON/LOCK> or <OFF>.

MENU Appending Dust Delete Data

Normally, the Self Cleaning Sensor Unit will eliminate most of the dust that may be visible on captured images. However, in case visible dust still remains, you can append the Dust Delete Data to the image for erasing the dust spots later. The Dust Delete Data is used by Digital Photo Professional (provided software, p.426) to erase the dust spots automatically.

Preparation

- Prepare a solid white object such as a sheet of paper.
- Set the lens focal length to 50 mm or longer.
- Set the lens focus mode switch to **<MF>** and set the focus to infinity (∞). If the lens has no distance scale, look at the front of the lens and turn the focusing ring clockwise all the way.

Obtain the Dust Delete Data

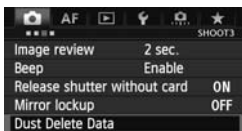

1 Select [Dust Delete Data].

- Under the [**3**] tab, select [**Dust Delete Data**], then press **<SET>**.



2 Select [OK].

- Select [**OK**] and press **<SET>**. After the automatic self-cleaning of the sensor is performed, a message will appear. Although there will be a shutter sound during the cleaning, no picture is taken.

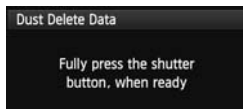
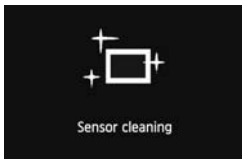



3 Photograph a solid-white object.

- At a distance of 20 cm - 30 cm (0.7 ft. - 1.0 ft.), fill the viewfinder with a patternless, solid-white object and take a picture.
- ▶ The picture will be taken in aperture-priority AE mode at an aperture of f/22.
- Since the image will not be saved, the data can be obtained even if there is no card in the camera.
- ▶ When the picture is taken, the camera will start collecting the Dust Delete Data. When the Dust Delete Data is obtained, a message will appear. Select [OK], and the menu will reappear.
- If the data was not obtained successfully, a message to that effect will appear. Follow the "Preparation" procedure on the preceding page, then select [OK]. Take the picture again.

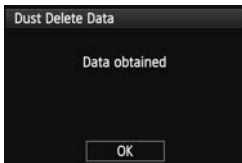

About the Dust Delete Data

After the Dust Delete Data is obtained, it is appended to all the JPEG and RAW images captured thereafter. Before an important shoot, you should update the Dust Delete Data by obtaining it again.

For details about using Digital Photo Professional (provided software, p.426) to erase dust spots, refer to the Software Instruction Manual (p.428) on the Software Instruction Manual CD-ROM.

The Dust Delete Data appended to the image is so small that it hardly affects the image file size.

! Be sure to use a solid-white object such as a new sheet of white paper. If the paper has any pattern or design, it may be recognized as dust data and affect the accuracy of the dust deletion with the software.

MENU Manual Sensor Cleaning

Dust that could not be removed by the automatic sensor cleaning can be removed manually with a blower, etc. Before cleaning the sensor, detach the lens from the camera.

The surface of the image sensor is extremely delicate. If the sensor needs to be cleaned directly, having it done by a Canon Service Center is recommended.

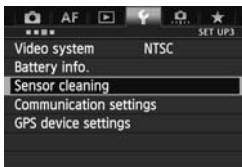

1 Select [Sensor cleaning].

- Under the [**3**] tab, select [**Sensor cleaning**], then press <SET>.

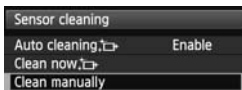

2 Select [Clean manually].

- Select [**Clean manually**], then press <SET>.



3 Select [OK].

- Select [**OK**], then press <SET>.
- ▶ In a moment, the reflex mirror will lockup and the shutter will open.
- “CLn” will blink on the top LCD panel.

4 Clean the sensor.

5 End the cleaning.

- Set the power switch to <OFF>.



If you use a battery, make sure it is fully charged.



As power source, using the AC Adapter Kit ACK-E4 (sold separately) is recommended.

- 
- **While cleaning the sensor, never do any of the following. Doing any of the following will cut off the power and close the shutter. The shutter curtains and image sensor may then get damaged.**
 - **Setting the power switch to <OFF>.**
 - **Removing or inserting the battery.**
 - The surface of the image sensor is extremely delicate. Clean the sensor with care.
 - Use a plain blower without any brush attached. A brush can scratch the sensor.
 - Do not insert the blower tip inside the camera beyond the lens mount. If the power is cut off, the shutter will close and the shutter curtains or reflex mirror may get damaged.
 - Never use canned air or gas to clean the sensor. The blowing force can damage the sensor or the spray gas can freeze on the sensor.
 - If the battery level becomes low while you clean the sensor, the beeper will sound as a warning. Stop cleaning the sensor.
 - If a smudge that cannot be removed with a blower remains, having the sensor cleaned by a Canon Service Center is recommended.

11

Printing Images and Transferring Images to a Computer

- **Printing** (p.308)
You can connect the camera directly to a printer and print out the images on the card. The camera is compatible with “PictBridge” which is the standard for direct printing.
- **Digital Print Order Format (DPOF)** (p.315)
DPOF (Digital Print Order Format) enables you to print images recorded on the card according to your printing instructions such as the image selection, quantity to print, etc. You can print multiple images in one batch or give the print order to a photofinisher.
- **Transferring Images to a Personal Computer** (p.319)
You can connect the camera to a personal computer and operate the camera to transfer images recorded on the card to the personal computer.

Preparing to Print

The direct printing procedure can be performed entirely with the camera while you look at the LCD monitor.

Connecting the Camera to a Printer

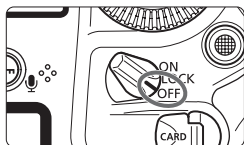

- 1 Set the camera's power switch to <OFF>.

- 2 Set up the printer.

- For details, refer to the printer's instruction manual.

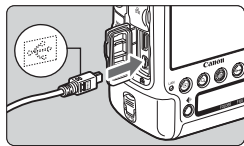

- 3 Connect the camera to the printer.

- Use the interface cable provided with the camera.
- Connect the cable to the camera's <DIGITAL> terminal with the cable plug's <↔> icon facing the front of the camera.
- To connect to the printer, refer to the printer's instruction manual.

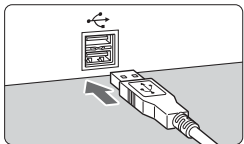

- 4 Turn on the printer.

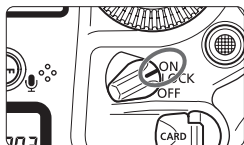

- 5 Set the camera's power switch to <ON>.

- ▶ Some printers may make a beeping sound.

PictBridge



6 Play back the image.

- Press the <▶> button.
- ▶ The image will appear, and the <PictBridge icon> will appear on the upper left to indicate that the camera is connected to a printer.



- Movies cannot be printed.
- The camera cannot be used with printers compatible only with CP Direct or Bubble Jet Direct.
- Do not use any interface cable other than the one provided.
- If there is a long beeping sound in step 5, it indicates a problem with the printer. Resolve the problem displayed in the error message (p.314).



- You can also print RAW images taken with this camera.
- If you use a battery pack to power the camera, make sure it is fully charged. With a fully-charged battery, printing up to approx. 4 hr. 30 min. is possible.
- Before disconnecting the cable, first turn off the camera and printer. Hold the plug (not the cord) to pull out the cable.
- For direct printing, using AC Adapter Kit ACK-E4 (sold separately) to power the camera is recommended.



Printing

The screen display and setting options will differ depending on the printer. Some settings may not be available. For details, refer to the printer's instruction manual.

Printer-connected icon



1 Select the image to be printed.

- Check that the <  > icon is displayed on the upper left of the LCD monitor.
- Turn the <  > dial to select the image to be printed.

2 Press < >.

- ▶ The print setting screen will appear.

Print setting screen

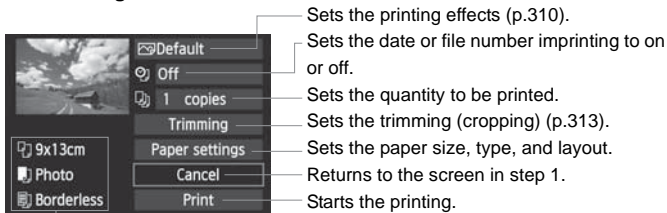

The paper size, type, and layout you have set are displayed.

* Depending on the printer, certain settings such as date and file number imprinting and trimming may not be selectable.

3 Select [Paper settings].

- Select [Paper settings], then press <  >.
- ▶ The paper setting screen will appear.

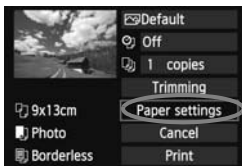

Setting the Paper Size



- Select the size of the paper loaded in the printer, then press **<SET>**.
- ▶ The paper type screen will appear.

Setting the Paper Type

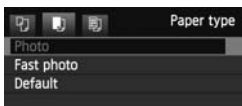

- Select the type of the paper loaded in the printer, then press **<SET>**.
- ▶ The page layout screen will appear.

Setting the Page Layout



- Select the page layout, then press **<SET>**.
- ▶ The print setting screen will reappear.

Bordered	The print will have white borders along the edges.
Borderless	The print will have no borders. If your printer cannot print borderless prints, the print will have borders.
Bordered [i]	The shooting information* ¹ will be imprinted on the border on 9x13 cm and larger prints.
xx-up	Option to print 2, 4, 8, 9, 16, or 20 images on one sheet.
20-up [i] 35-up [i]	Twenty or 35 images will be printed as thumbnails on A4 or Letter size paper* ² . • [20-up [i]] will have the shooting information* ¹ imprinted.
Default	The page layout will vary depending on the printer model or its settings.

*1: From the Exif data, the camera name, lens name, shooting mode, shutter speed, aperture, exposure compensation amount, ISO speed, white balance, etc., will be imprinted.

*2: After ordering the prints with "Digital Print Order Format (DPOF)" (p.315), it is recommended that you print by following "Direct Printing with DPOF" (p.318).



4 Set the printing effects.

- Set if necessary. If you do not need to set any printing effects, go to step 5.
- **What is displayed on the screen differs depending on the printer.**
- Select the option, then press <SET>.
- Select the desired printing effect, then press <SET>.
- If the <INFO> icon is highlighted next to <INFO>, you can also adjust the printing effect (p.312).

Printing Effect	Description
On	The image will be printed using the printer's standard colors. The image's Exif data is used to make automatic corrections.
Off	No automatic correction will be applied.
Vivid	The image will be printed with higher saturation to produce more vivid blues and greens.
NR	Image noise is reduced before printing.
B/W B/W	Prints in black-and-white with true blacks.
B/W Cool tone	Prints in black-and-white with cool, bluish blacks.
B/W Warm tone	Prints in black-and-white with warm, yellowish blacks.
Natural	Prints the image in the actual colors and contrast. No automatic color adjustments are applied.
Natural M	The printing characteristics are the same as the "Natural" setting. However, this setting enables finer printing adjustments than with "Natural."
Default	The printing will differ depending on the printer. For details, refer to the printer's instruction manual.

* When you change the printing effects, changes are reflected in the image displayed on the upper left. Note that the printed image may look slightly different from the displayed image, which is only an approximation. This also applies to [Brightness] and [Adjust levels] on page 312.



5 Set the date and file number imprinting.

- Set if necessary.
- Select <Ⓞ>, then press <SET>.
- Set as desired, then press <SET>.

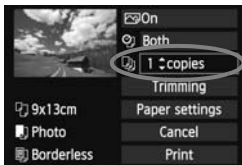

6 Set the number of copies.

- Set if necessary.
- Select <Ⓞ>, then press <SET>.
- Set the number of copies, then press <SET>.

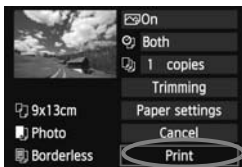

7 Start printing.

- Select [Print], then press <SET>.

When imprinting the shooting information (p.309) of an image shot at ISO 51200, H1, or H2, the correct ISO speed may not be imprinted.

- The [Default] setting for printing effects and other options are the printer's own default settings as set by the printer's manufacturer. Refer to the printer's instruction manual to find out what the [Default] settings are.
- Depending on the image's file size and image-recording quality, it may take some time for the printing to start after you select [Print].
- If image tilt correction (p.313) is applied, it may take longer to print the image.
- To stop the printing, press <SET> while [Stop] is displayed, then select [OK].
- If you execute [4: Clear all camera settings] (p.58), all the settings will revert to their defaults.

Adjustment of Printing Effects



In step 4 on page 310, select the printing effect. When the <☰> icon is highlighted next to <INFO.>, you can press the <INFO.> button. You can then adjust the printing effects. What can be adjusted or what is displayed will depend on the selection made in step 4.



● Brightness

The image brightness can be adjusted.

● Adjust levels

When you select [Manual], you can change the histogram's distribution and adjust the image's brightness and contrast.

With the Adjust levels screen displayed, press the <INFO.> button to change the position of the <▲>. Turn the <⌚> dial to freely adjust the shadow level (0 - 127) or highlight level (128 - 255).

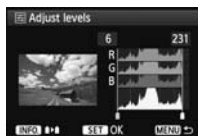

● Brightener

Effective in backlit conditions that can make the subject's face look dark. When [On] is set, the face will be brightened for printing.

● Red-eye corr.

Effective in flash images where the subject has red eye. When [On] is set, the red eye will be corrected for printing.

- The [Brightener] and [Red-eye corr.] effects will not show on the screen.
- When [Detail set.] is selected, you can adjust the [Contrast], [Saturation], [Color tone], and [Color balance]. To adjust the [Color balance], use <⬅➡>. B is for blue, A for amber, M for magenta, and G for green. The image's color balance will be corrected towards the selected color.
- If you select [Clear all], all the printing effect settings will be reverted to their defaults.

Trimming the Image

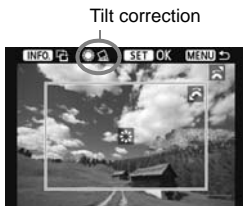

You can crop the image and print only the trimmed portion as if the image was recomposed.

Set the trimming right before printing.

If you set the trimming and then set the print settings, you may have to set the trimming again before printing.

1 On the print setting screen, select [Trimming].

2 Set the trimming frame size, position, and aspect ratio.

- The image area within the trimming frame will be printed. The trimming frame's aspect ratio can be changed with [Paper settings].

Changing the trimming frame size

Turn the  dial to change the trimming frame size. The smaller the trimming frame, the larger the image magnification will be for printing.



Moving the trimming frame

Use  to move the frame over the image vertically or horizontally. Move the trimming frame so that it covers the desired image area.

Rotating the frame

Pressing the <INFO.> button will toggle the trimming frame between the vertical and horizontal orientations. This enables you to create a vertically oriented print from a horizontal image.

Image tilt correction

By turning the  dial, you can adjust the image tilt angle up to ± 10 degrees in 0.5-degree increments. When you adjust the image tilt, the  icon on the screen will turn blue.

3 Press <SET> to exit the trimming.

- ▶ The print setting screen will reappear.
- You can check the trimmed image area on the upper left of the print setting screen.

- Depending on the printer, the trimmed image area may not be printed as you specified.
- The smaller you set the trimming frame, the grainier the picture will look in the print.
- While trimming the image, look at the camera's LCD monitor. If you look at the image on a TV screen, the trimming frame may not be displayed accurately.



Handling Printer Errors

If you resolve a printer error (no ink, no paper, etc.) and select [**Continue**] to resume printing but it does not resume, operate the printer to resume printing. For details on resuming the printing, refer to the printer's instruction manual.

Error Messages

If a problem occurs during printing, an error message will appear on the camera's LCD monitor. Press <  > to stop printing. After fixing the problem, resume printing. For details on how to fix a printing problem, refer to the printer's instruction manual.

Paper Error

Check whether the paper is properly loaded in the printer.

Ink Error

Check the printer's ink level, and check the waste ink tank.

Hardware Error

Check for any printer problems other than paper and ink problems.

File Error

The selected image cannot be printed via PictBridge. Images taken with a different camera or images edited with a computer may not be printable.

Digital Print Order Format (DPOF)

You can set the print type, date imprinting, and file number imprinting. The print settings will be applied to all print-ordered images. (Settings cannot be set individually for each image.)

Setting the Printing Options

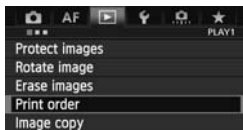

1 Select [Print order].

- Under the [▶1] tab, select [Print order], then press <SET>.

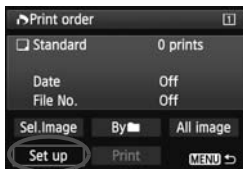

2 Select [Set up].

- Select [Set up], then press <SET>.

3 Set the option as desired.

- Set the [Print type], [Date], and [File No.].
- Select the option to be set, then press <SET>. Select the desired setting, then press <SET>.

[Print type]

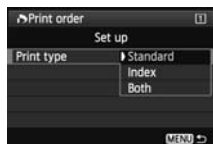

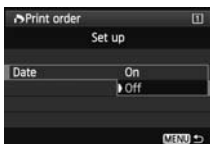

[Date]



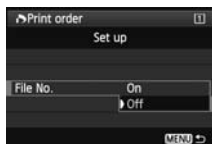

[File No.]



Print type		Standard	Prints one image on one sheet.
		Index	Multiple thumbnail images are printed on one sheet.
		Both	Prints both the standard and index prints.
Date	On	[On] imprints the recorded date on the print.	
	Off		
File number	On	[On] imprints the file number on the print.	
	Off		

4 Exit the setting.

- Press the <MENU> button.
- ▶ The print order screen will reappear.
- Next, select [**Sel.Image**], [**By** ], or [**All image**] to order the images to be printed.

- 
- Even if [**Date**] and [**File No.**] are set to [**On**], the date or file number may not be imprinted depending on the print type setting and printer model.
 - With [**Index**] prints, the [**Date**] and [**File No.**] cannot both be set to [**On**] at the same time.
 - When printing with DPOF, you must use the card whose print order specifications have been set. It will not work if you just extract images from the card and try to print them.
 - Certain DPOF-compatible printers and photofinishers may not be able to print the images as you specified. If this happens with your printer, refer to the printer's instruction manual. Or check with your photofinisher about compatibility when ordering prints.
 - Do not insert into the camera a card whose print order was set by a different camera and then try to specify a print order. The print order may not work or may be overwritten. Also, depending on the image type, the print order may not be possible.

 RAW images and movies cannot be print ordered. You can print RAW images with PictBridge (p.306).

Print Ordering

● Sel.Image

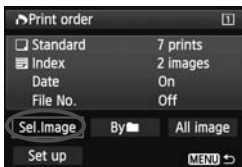

Select and order images one by one. If you press the <Q> button and turn the <DIAL> dial counterclockwise, you can select an image from a three-image display. To return to the single-image display, turn the <DIAL> dial clockwise. Press the <MENU> button to save the print order to the card.



[Standard] [Both]

Press <SET> and a print order for one copy of the displayed image will be placed. By turning the <DIAL> dial, you can set the quantity up to 99.



[Index]

Press <SET> to include images with a checkmark <✓> in the index print.

● By [Folder Icon]

Select **[Mark all in folder]** and select the folder. A print order for one copy of all the images in the folder will be placed. If you select **[Clear all in folder]** and select the folder, the print order for that entire folder will be canceled.

● All image

If you select **[Mark all on card]**, one copy of all the images on the card will be set for printing. If you select **[Clear all on card]**, the print order will be cleared for all the images on the card.



- Note that RAW images and movies will not be included in the print order even if you set "By [Folder Icon]" or "All image."
- When using a PictBridge printer, print no more than 400 images for one print order. If your print order specifies more images, some of the images may not be printed.

Direct Printing with DPOF



With a PictBridge printer, you can easily print images with DPOF.

1 Prepare to print.

- See page 306. Follow the “Connecting the Camera to a Printer” procedure up to step 5.

2 Under the [▶ 1] tab, select [Print order].

3 Select [Print].

- [Print] will be displayed only if the camera is connected to a printer and printing is possible.

4 Set the [Paper settings] (p.308).

- Set the printing effects (p.310) if necessary.

5 Select [OK].

- Before printing, be sure to set the paper size.
- Certain printers cannot imprint the file number.
- If [Bordered] is set, certain printers may imprint the date on the border.
- Depending on the printer, the date may appear faint if it is imprinted on a bright background or on the border.

- Under [Adjust levels], [Manual] cannot be selected.
- If you stopped the printing and want to resume printing the remaining images, select [Resume]. Note that printing will not resume if you stop the printing and any of the following occurs:
 - Before resuming the printing, you changed the print order or deleted print-ordered images.
 - When you set the index, you changed the paper setting before resuming the printing.
 - When you paused the printing, the card's remaining capacity was low.
- If a problem occurs during printing, see page 314.

Transferring Images to a Personal Computer ■

You can connect the camera to a personal computer and operate the camera to transfer images on the card to the personal computer. This is called direct image transfer.

Direct image transfer is performed and controlled from the camera, with the interface displayed on the camera's LCD monitor.

The images transferred to the personal computer will be saved in the [Pictures] or [My Pictures] folder and organized in folders by shooting date.

ⓘ Before connecting the camera to the personal computer, be sure to install the provided software (EOS DIGITAL Solution Disk on CD-ROM) on the personal computer.

For the procedure to install the provided software, see page 427.

Preparation for Image Transfer

1 Set the camera's power switch to <OFF>.

2 Connect the camera to a personal computer.

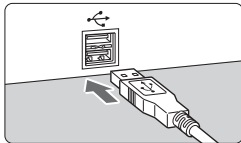
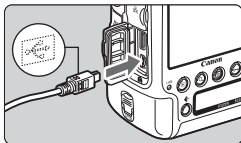

- Use the interface cable provided with the camera.
- Connect the cable to the camera's <DIGITAL> terminal with the cable plug's <↔> icon facing the front of the camera.
- Connect the cord's plug to the personal computer's USB terminal.

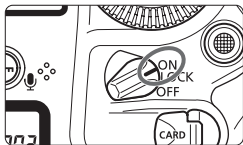

3 Set the camera's power switch to <ON>.

- When the personal computer prompts you to select a program, select [**EOS Utility**].
- ▶ The EOS Utility screen will appear on the personal computer.

⚠ **After the EOS Utility screen appears, do not operate EOS Utility.** If any screen other than EOS Utility's top screen is displayed, [**Direct transfer**] in step 5 on page 322 will not be displayed. (The image transfer function will not be available.)

- If the EOS Utility screen does not appear, refer to the Software Instruction Manual (CD-ROM, p.428).
- Before disconnecting the cable, turn off the camera. Hold the plug (not the cord) to pull out the cable.
- You can also transfer images to an ftp server via a wired LAN connected to the Ethernet RJ-45 terminal (p.21). For details, refer to the separate "Wired LAN Instruction Manual."

MENU Transferring RAW+JPEG Images

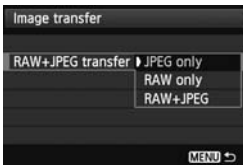

For RAW+JPEG images, you can specify which image to transfer. On the next page in step 2, select [**RAW+JPEG transfer**], and select the images to be transferred: [**JPEG only**], [**RAW only**], or [**RAW+JPEG**].

⚠ The [**RAW+JPEG transfer**] setting will change automatically in relation with the setting for [**Communication settings**] → [**Network settings**] → [**Set up**] → [**Transfer type/size**] → [**RAW+JPEG transfer**].

MENU Select the Images to be Transferred

● Sel.Image

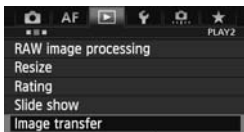

1 Select [Image transfer].

- Under the [▶2] tab, select [Image transfer], then press <SET>.

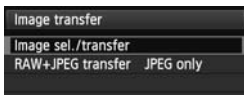

2 Select [Image sel./transfer].

- Select [Image sel./transfer], then press <SET>.

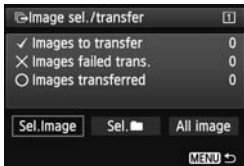

3 Select [Sel.Image].

- Select [Sel.Image], then press <SET>.

4 Select the images to be transferred.

- Turn the <DISP> dial to select the image to be transferred, then press <SET>.
- Turn the <DISP> dial to display <✓> on the screen's upper left, then press <SET>.
- If you press the <Q> button and turn the <DISP> dial counterclockwise, you can select an image from a three-image display. To return to the single-image display, turn the <DISP> dial clockwise.
- To select other images to be transferred, repeat step 4.
- To return to the screen in step 3, press the <MENU> button.



- When [Sel.Image] is selected, you can check the image's transfer status on the upper left of the screen: No mark: Not selected. ✓: Selected for transfer. ✗: Transfer failed. ○: Transferred.
- The procedures for [RAW+JPEG transfer] on page 320 and steps 1 to 4 above can also be performed while the camera is not connected to a personal computer.

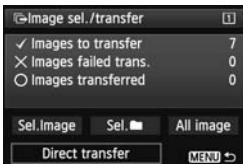

5 Transfer the image.

- On the computer screen, check that EOS Utility's top screen is displayed.
- Select [**Direct transfer**], then press < (SET) >.
- On the confirmation screen, select [**OK**] and the images will be transferred to the personal computer.
- Images selected with [**Sel. [Folder]**] and [**All image**] can also be transferred this way.

● Sel. [Folder]

Select [**Sel. [Folder]**] and select [**Folder images not transfer'd**]. When you select a folder, all the images in that folder not yet transferred to the personal computer will be selected.

Selecting [**Folder images failed transf.**] will select the images in the selected folder that failed to transfer.

Selecting [**Clear folder transf. history**] will clear the transfer history of the images in the selected folder. After clearing the transfer history, you can select [**Folder images not transfer'd**] and again transfer all the images in the folder.

● All image

If [**All image**] is selected and you select [**Card images not transferred**], all the images on the card not yet transferred to a personal computer will be selected.

For a description of [**Card images failed transfer**] and [**Clear card's transf. history**], see "Sel. [Folder]" above.

- If any screen other than EOS Utility's top screen is displayed on the personal computer, [**Direct transfer**] is not displayed.
- During the image transfer, certain menu options cannot be used.

- You can also transfer movies.
- Up to 9,999 images can be transferred in one batch.
- Shooting is possible during the image transfer.



12

Customizing the Camera

You can customize various camera features to suit your picture-taking preferences with Custom Functions. Also, you can register the current camera settings under shooting modes <C1>, <C2>, or <C3>, or save the camera settings to a card.

MENU Custom Functions

☛ 1: Exposure

		 LV Shooting	 Movie Shooting
Exposure level increments	p.326	<input type="radio"/>	<input type="radio"/>
ISO speed setting increments		<input type="radio"/>	In M
Bracketing auto cancel		<input type="radio"/>	(Still photo, with WB bracketing set)
Bracketing sequence	<input type="radio"/>		
Number of bracketed shots	p.327	<input type="radio"/>	
Spot metering linked to AF point	p.328		
Safety shift	p.329	<input type="radio"/>	

☛ 2: Exposure



Restrict shooting modes	p.330	<input type="radio"/>	<input type="radio"/>
Restrict metering modes			
Metering used in manual exposure			
Set shutter speed range	p.331	<input type="radio"/>	<input type="radio"/>
Set aperture range		<input type="radio"/>	<input type="radio"/>
AE Microadjustment	p.332	<input type="radio"/>	<input type="radio"/>
FE Microadjustment		<input type="radio"/>	

☛ 3: Drive

Continuous shooting speed	p.333	<input type="radio"/>	(Still photo)
Limit continuous shot count		<input type="radio"/>	(Still photo)
Restrict drive modes		<input type="radio"/>	(Still photo)

 The shaded Custom Functions do not function during Live View (LV) shooting or movie shooting. (Settings are disabled.)

4: Display/Operation

		 LV Shooting	 Movie Shooting
Focusing Screen	p.334		
Viewfinder info. during exposure			
LCD panel illumination during Bulb	p.335	○	
Recording card, image size setting			

5: Operation





Dial direction during Tv/Av	p.336	○	In M
Av setting without lens		○	In M
Multi function lock	p.337	○	○
Custom Controls		Depends on setting	
 button function	p.338	(During image review after capture)	

6: Others

Add cropping information	p.339	○	(Still photo)
Timer duration		[Timer after release] only	
Shutter release time lag	p.340		
Memo audio quality		(During image review after capture)	
Default Erase option		(Playback)	
Same exposure for new aperture	p.341	○	

7: Clear

Selecting [ 7: Clear all Custom Func. (C.Fn)] will clear all the Custom Function settings.

 Even if all the Custom Functions are cleared, the settings for [ 4: Focusing Screen] and [ 5: Custom Controls] will remain unchanged. Also, although the adjustments made will not be cleared, [ 2: AE Microadjustment] and [ 2: FE Microadjustment] will be set to [Disable].

MENU Custom Function Settings

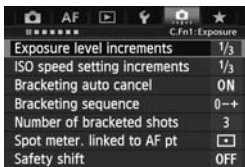

Under the [] tab, you can customize various camera features to suit your picture-taking preferences. Any settings different from the default will be displayed in blue.

C.Fn1: Exposure

Exposure level increments

1/3: 1/3-stop, Exposure compensation 1/3-stop

Sets 1/3-stop increments for the shutter speed, aperture, exposure compensation, and flash exposure compensation.

1/1: 1-stop, Exposure compensation 1/3-stop

Sets whole-stop increments for the shutter speed and aperture, and 1/3-stop increments for exposure compensation and flash exposure compensation.

1/2: 1/2-stop, Exposure compensation 1/2-stop

Sets 1/2-stop increments for the shutter speed, aperture, exposure compensation, and flash exposure compensation.

ISO speed setting increments

1/3: 1/3-stop

1/1: 1-stop

Bracketing auto cancel

ON: Enable

When you set the power switch to <OFF>, the AEB and white balance bracketing settings will be canceled. AEB will also be canceled when the flash is ready to fire or if you switch to movie shooting.

OFF: Disable

The AEB and white balance bracketing settings will not be canceled even if you set the power switch to <OFF>. (If the flash is ready to fire or if you switch to movie shooting, AEB will be canceled temporarily, but the AEB range will be retained.)

Bracketing sequence

The AEB shooting sequence and white balance bracketing sequence can be changed.

0 - +: 0, -, +

- 0+: -, 0, +

+0 -: +, 0, -

AEB	White Balance Bracketing	
	B/A Direction	M/G Direction
0 : Standard exposure	0 : Standard white balance	0 : Standard white balance
- : Decreased exposure	- : Blue bias	- : Magenta bias
+ : Increased exposure	+ : Amber bias	+ : Green bias

Number of bracketed shots

The number of shots taken with AEB and white balance bracketing can be changed from the usual 3 shots to 2, 5, or 7 shots.

When [**Bracketing sequence: 0, -, +**] is set, the bracketed shots will be taken as shown in the table below.

3: 3 shots

2: 2 shots

5: 5 shots

7: 7 shots

(1-stop increments)

	1st Shot	2nd Shot	3rd Shot	4th Shot	5th Shot	6th Shot	7th Shot
3: 3 shots	Standard (0)	-1	+1				
2: 2 shots	Standard (0)	±1					
5: 5 shots	Standard (0)	-2	-1	+1	+2		
7: 7 shots	Standard (0)	-3	-2	-1	+1	+2	+3



If [**2 shots**] is set, you can select the + or - side when setting the AEB range.

Spot metering linked to AF point

You can enable or disable AF point-linked spot metering in the <[•]> metering mode.

Center AF point only

Regardless of the AF point currently selected, spot metering will always be linked to the viewfinder's center AF point.

Linked to active AF point

Spot metering will be linked to the manually-selected AF point. If the AF area selection mode is set to 61-point automatic selection or Zone AF (automatic Zone selection), spot metering is performed at the viewfinder center.

Safety shift

OFF: Disable

Tv/Av: Shutter speed/Aperture

This function takes effect in the shutter-priority AE (**Tv**) and aperture-priority AE (**Av**) modes. If the subject's brightness changes and the standard exposure cannot be obtained within the autoexposure range, the camera will automatically change the manually-selected setting to obtain a standard exposure.

ISO: ISO speed

This function takes effect in the Program AE (**P**), shutter-priority AE (**Tv**), and aperture-priority AE (**Av**) modes. If the subject's brightness changes and the standard exposure cannot be obtained within the autoexposure range, the camera will automatically change the manually set ISO speed to obtain a standard exposure.



If the safety shift automatically sets ISO 32000 or higher (when the camera's internal temperature is low, ISO 20000 or higher), when **[ISO speed]** is set, the maximum continuous shooting speed at H> will be approx. 10 shots/sec.



- Under [**2: ISO speed settings**], even if **[ISO speed range]** or **[Min. shutter spd.]** is changed from the default setting, safety shift will override it if a standard exposure cannot be obtained.
- The minimum and maximum sensitivities of the safety shift using the ISO speed will be determined by the **[Auto ISO range]** setting (p.133). However, if the manually set ISO speed exceeds the **[Auto ISO range]**, the safety shift will extend up to the manually set ISO speed.
- If **[Shutter speed/Aperture]** or **[ISO speed]** is set, safety shift will take effect if necessary even when flash is used.

C.Fn2: Exposure

Restrict shooting modes

You can restrict the shooting modes selectable with the <MODE> button. Select a shooting mode (**M/Tv/Av/P/BULB/C1/C2/C3**) to be made selectable and press <SET> to append a checkmark <✓>.

- ❗ ● The restricted shooting mode settings are not registered to C1, C2, or C3.
- At least one shooting mode must be checkmarked <✓>.

Restrict metering modes

You can restrict the metering modes selectable with the <[METERING]> button. Select a metering mode ([METERING]/[METERING]/[METERING]/[METERING]) to be made selectable, then press <SET> to append a checkmark <✓>.

- ❗ At least one metering mode must be checkmarked <✓>.

Metering used in manual exposure

You can set the metering mode to be used in the <M> shooting mode.

✓ [METERING] Specified metering mode

The currently-set metering mode is used.

- Evaluative metering
- Partial metering
- Spot metering
- Center-weighted average metering

- ❗ If [METERING]/[METERING]/[METERING]/[METERING] is set, pressing the <[METERING]> button during manual exposure shooting will not select the metering mode.

Set shutter speed range

You can set the shutter speed range. In the <**Tv**> and <**M**> modes, you can set the shutter speed manually within the range that you have set. In the <**P**> and <**Av**> modes, the shutter speed will be set automatically within the range that you have set.

Highest speed

You can set it from 1/8000 sec. to 15 sec.

Lowest speed

You can set it from 30 sec. to 1/4000 sec.

Set aperture range

You can set the aperture range. In the <**Av**> and <**M**> modes, you can set the aperture manually within the range that you have set. In the <**P**> and <**Tv**> modes, the aperture will be set automatically within the range that you have set.

Min. aperture (Max. f/)

You can set it from f/91 to f/1.4.

Max. aperture (Min. f/)

You can set it from f/1.0 to f/64.



The settable aperture range will differ depending on the lens' maximum and minimum apertures.

AE Microadjustment

-  **Normally, this adjustment is not required. Perform this adjustment only if necessary. Note that performing this adjustment may prevent the correct exposure from being achieved.**

You can fine-tune the standard for exposure metering. This adjustment can help if automatic exposure always makes the image look too dark or too bright even without any exposure compensation.

OFF: Disable

ON: Enable

Select [**Enable**] and press the <Q> button. The adjustment screen will appear. The adjustment can be made up to ± 1 stop in 1/8-stop increments. If the exposure metering tends to underexpose, set it to the plus (+) side. If it tends to overexpose, set it to the minus (-) side.

FE Microadjustment

-  **Normally, this adjustment is not required. Perform this adjustment only if necessary. Note that performing this adjustment may prevent the correct flash exposure from being obtained.**

You can fine-tune the camera's standard for flash exposure. This adjustment can help if the automatic flash exposure always makes the subject look too dark or too bright even without any flash exposure compensation.

OFF: Disable

ON: Enable

Select [**Enable**] and press the <Q> button. The adjustment screen will appear. The adjustment can be made up to ± 1 stop in 1/8-stop increments. If the flash exposure metering tends to underexpose the main subject, set it to the plus (+) side. If it tends to overexpose the main subject, set it to the minus (-) side.

C.Fn3: Drive

Continuous shooting speed

You can set the continuous shooting speed for <C.Fn3 H> high-speed continuous shooting and <C.Fn3 L> low-speed continuous shooting.

High speed

You can set it from 2 to 12 shots/sec.

Low speed

You can set it from 1 to 11 shots/sec.



If you set 12 or 11 shots/sec. for <C.Fn3 H> or 11 shots/sec. for <C.Fn3 L> and use ISO 32000 or higher (when the camera's internal temperature is low, ISO 20000 or higher), the maximum continuous shooting speed will be approx. 10 shots/sec. If Auto ISO is set and ISO 32000 or higher (when the camera's internal temperature is low, ISO 20000 or higher) is set automatically, the maximum continuous shooting speed will be approx. 10 shots/sec.

Limit continuous shot count

You can limit the maximum burst during continuous shooting so that the camera stops shooting after the set number of continuous shots is taken. You can set it within 2 to 99 shots. Pressing the <C.Fn3> button will return the setting to [Disable].

If [Disable] is set, continuous shooting can continue up to the maximum burst (p.128) displayed in the viewfinder.

Restrict drive modes

You can restrict the drive modes selectable with the <AF•DRIVE> button. Select a drive mode (□/C.Fn3 H/C.Fn3 L/S¹⁰/S²/C.Fn3 H₁₄) to be made selectable, then press <SET> to append a checkmark <✓>.



- You cannot select <C.Fn3 H₁₄> with the <AF•DRIVE> button in the default setting. To make <C.Fn3 H₁₄> selectable for super high-speed continuous shooting, append a checkmark <✓> (p.116).
- At least one drive mode must be checkmarked <✓>.

C.Fn4: Display/Operation

Focusing Screen

You can change the focusing screen to an Ec-series focusing screen more suited for your shooting. **If you change the focusing screen, change this setting to match the focusing screen type to obtain the correct exposure.**

Std.:  **Ec-CV**

Standard focusing screen.

 :  **Ec-A, B, D, H, I, L**

For Laser-matte screens.

-  ● Since the Ec-A/B/I/L focusing screens have a prism at the center, the correct exposure cannot be obtained with evaluative metering or center spot metering. Use either center-weighted average metering or AF point-linked spot metering (except the center AF point).
- Since the Ec-A/B/I/L focusing screens have a prism in the center, AF based on the color and facial information of a subject at the center of the viewfinder may not be achieved, even if [**Auto AF pt sel.: EOS iTR AF**] is set to [**Enable**] (p.97).
- Although an Ec-C/CII/CIII/CIV/N/R/S focusing screen can be installed in the camera, the correct exposure will not be obtained. Use a commercially-available light meter to set a manual exposure or set exposure compensation and shoot.
- The Area AF frame displayed on the Ec-CIII/CIV/N/S focusing screens is different from this camera's AF Area.

 To change the focusing screen, refer to the instructions that come with the focusing screen.

Viewfinder info. during exposure

You can enable or disable the viewfinder information displayed during the exposure.

OFF: Disable

ON: Enable

The viewfinder information will be displayed even during exposure. This is convenient when you want to check the exposure setting, number of possible shots, etc., during continuous shooting.



When the shooting mode is set to “Bulb”, the viewfinder information will not be displayed even if [Enable] is set.

LCD panel illumination during Bulb

You can set the LCD panel illumination behavior during Bulb exposures, such as whether it stays on during the exposure, and whether it turns off or stays on when the button is pressed.

OFF: Off

When the Bulb exposure starts, the LCD panel illumination turns off. Pressing the button during a Bulb exposure illuminates the LCD panel for 6 sec.

ON: On during Bulb

The LCD panel illumination remains on until the Bulb exposure ends. This is convenient when you are taking a Bulb exposure in low light and want to check the exposure time.

Recording card, image size setting

When you press the button to select the card or set the image size, you can select to do it with the rear LCD panel or with the LCD monitor.

Rear LCD panel

You can press the button and turn the or dial while looking at the rear LCD panel.

LCD monitor

When you press the button, the [Record func+card/folder sel.] or [Img type/size] screen will appear. Pressing the button toggles between the two screens.

OFF: Disable button

You cannot select the card or set the image size by pressing the button. It can prevent the image size or recording card from changing when the button is pressed accidentally. Select the card or set the image size from the menu screen.





C.Fn5: Operation

Dial direction during Tv/Av

 **Normal**

 **Reverse direction**

You can reverse the dial's turning direction when setting the shutter speed and aperture.

In the <M> shooting mode, the turning direction of the < > and < > dial will be reversed. In the other shooting modes, the turning direction of only the < > dial will be reversed. The < > dial's turning direction will be the same for the <M> mode and for setting the exposure compensation.

Av setting without lens

You can set whether the aperture can still be set when no lens is attached to the camera.

OFF: Disable

ON: Enable

You can set the aperture with the camera even while no lens is attached. This is convenient for studio photography when the aperture is already determined, as you can set the aperture beforehand.

Multi function lock

When the power switch is set to <LOCK>, it will prevent the <>, <>, and <> from accidentally changing a setting.

Select the camera control(s) you want to lock when the power switch is set to <LOCK>, then press <> to append a checkmark <✓> and select [OK].

Main Dial

The Main Dial and vertical-grip Main Dial will be locked.



Quick Control Dial

The Quick Control Dial will be locked.

Multi-controller

The Multi-controller and vertical-grip Multi-controller will be locked.





- If you try to use one of the locked camera controls when the power switch is set to <LOCK>, <L> will be displayed in the viewfinder and on the top LCD panel, and <LOCK> will appear on the shooting settings display (p.50).
- By default, when the power switch is set to <LOCK>, the <> dial will be locked.
- Even if the <> dial has a checkmark <✓> appended and is locked, you can still use the touch pad <>.





Custom Controls

You can assign often-used functions to camera buttons or dials according to your preferences. For details, see page 343.



/ button function

You can change the function of the </ > button. During image playback, you can protect images, record a voice memo, and rate images.





/ **Protect (Hold: Record memo)**

To protect an image, press the </ > button. To start recording a voice memo, hold down the </ > button for 2 sec. To end the recording, let go of the button.

Record memo (disabled)







Pressing the </ > button starts recording a voice memo immediately, and letting go of the button ends the recording. To protect an image, use [] **1: Protect images**].

/ **Play memo (Hold: Record memo)**

When you playback an image having a voice memo, press the </ > button to playback the voice memo. To start recording a voice memo, hold down the </ > button for 2 sec. To end the recording, let go of the button. To protect an image, use [] **1: Protect images**].

★ **Rating (and disabled)**

To rate an image, press the </ > button. Each time you press the button, the rating will change as follows: **OFF**, [], [], [], [], [].

 If [**Rating ( and  disabled)**] is selected and you press the <> button, you can set the ratings selectable with the </ > button.

C.Fn6: Others

Add cropping information

If you set cropping information, vertical lines for the aspect ratio you have set will appear on the Live View image. You can then compose the shot as if you were shooting with a medium- or large-format camera (6x6 cm, 4x5 inch, etc.).

When you take a picture, the aspect ratio information for cropping the image with the provided software will be appended to the image. (The image is recorded to the card without being cropped.)

After the image is transferred to a personal computer, you can use Digital Photo Professional (provided software, p.426) to easily crop the image to the aspect ratio that was set.

OFF: Off (aspect ratio 3:2)

6:7: Aspect ratio 6:7

6:6: Aspect ratio 6:6

5:6: Aspect ratio 10:12

3:4: Aspect ratio 3:4

5:7: Aspect ratio 5:7

4:5: Aspect ratio 4:5



- The cropping information is recorded during Live View shooting, viewfinder shooting, and still photo shooting during movie shooting. Cropping information cannot be recorded to movies.
- A **RAW** image with cropping information appended cannot be cropped with the camera's RAW image processing.

Timer duration

You can change how long a function setting associated with a button remains in effect after you let go of that button. You can set the timer duration within 0 sec. to 59 sec. or within 1 min. to 60 min.

6-sec. timer

This is how long the metering and AE lock are maintained.

16-sec. timer

This is how long the FE lock and multi-spot metering are maintained.

Timer after release

This is how long the metering is maintained after shutter release. Normally, the timer length is 2 sec. after the shutter release. A longer timer length will make it easier to keep using AE lock for the same exposure.

Shutter release time lag

Normally, the shutter release is controlled for a stable release time lag. By setting [**Shortened**], this stabilization control can be omitted to make the shutter-release time lag shorter.

| **Standard**

| **Shortened**

The normal shutter-release time lag is approx. 0.055 sec. when the aperture is stopped down by no more than four stops (depending on the lens). When set to Shortened, the shutter-release time lag is approx. 0.036 sec. At the maximum aperture, the shutter-release time lag will be approx. 0.036 sec. regardless of the lens.

 The Shortened shutter-release time lag will vary depending on the lens and aperture setting.

Memo audio quality

You can set the audio quality when you record a voice memo.

48kHz: High quality (48 kHz)

You can record the voice memo at the same audio quality as a movie.

8kHz: Low quality (8 kHz)

The voice memo's file size is smaller than with [**High quality (48 kHz)**].

 If you record another voice memo to an image which already has a voice memo, the audio quality will be the same as the first voice memo regardless of this setting.

Default Erase option

During image playback and image review after image capture, when you press the <  > button, the Erase menu appears (p.286). You can set which option, [**Cancel**] or [**Erase**], is to be preselected on this screen.

If [**Erase**] is set, you can just press <  > to quickly erase the image.

 [**Cancel**] selected

 [**Erase**] selected

 If [**Erase**] is set, be careful not to erase an image accidentally.

Same exposure for new aperture

If the <M> mode (manual exposure shooting) is set and the ISO speed is set manually (other than Auto ISO), the maximum aperture's f/number may change to a high number (smaller aperture) or a low number if you perform any of the following: 1. Change the lens, 2. Attach or detach an Extender, or 3. Use a zoom lens whose maximum aperture f/number changes. If you then shoot at the exposure setting as is, the image will be underexposed or overexposed by the amount the maximum aperture f/number changes. However, by changing the ISO speed or shutter speed (Tv) automatically, you can obtain the same exposure that would be obtained before you performed 1, 2, or 3.

OFF: Disable

Automatic changes in settings to maintain the specified exposure will not be applied. The ISO speed, shutter speed, and aperture already set will take effect in shooting. If you perform 1, 2, or 3 and the maximum aperture f/number changes, adjust the ISO speed and shutter speed before you shoot.

ISO: ISO speed

If you perform 1, 2, or 3, the ISO speed will automatically increase or decrease by the amount that the maximum aperture f/number changes. The same exposure that would be obtained before you performed 1, 2, or 3 is obtained.

Tv: Shutter speed

If you perform 1, 2, or 3, the shutter speed will automatically increase or decrease by the amount that the maximum aperture f/number changes. The same exposure that would be obtained before you performed 1, 2, or 3 is obtained.

- This function does not work with macro lenses whose actual aperture f/number changes when the magnification changes.
- This function does not work with movies.
- If [**Shutter speed**] is set and the same exposure cannot be maintained within the shutter speed range set with the [**2: Set shutter speed range**], shutter speed will not be changed automatically.
- If [**ISO speed**] is set and the same exposure cannot be maintained within the ISO speed range set with the [**ISO speed range**], ISO speed will not be changed automatically.

- This function also works with changes for maximum f/number (smallest aperture).
- If you set [**ISO speed**] or [**Shutter speed**], perform 1, 2, or 3, and then cancel 1, 2, or 3 so that the camera is back to its original state, the original exposure setting will be restored without you manually changing the ISO speed, shutter speed, or aperture.
- If [**ISO speed**] is set to "L", "H1", or "H2", shutter speed may be changed to maintain the same exposure.

5: Custom Controls

You can assign frequently-used functions to camera buttons or dials according to your preferences.

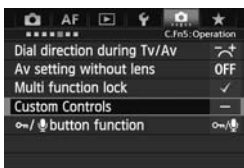

1 Select [5: Custom Controls].

- Under the [5] tab, select [Custom Controls], then press <SET>.
- ▶ The Custom Controls screen will appear.



2 Select a camera button or dial.

- Turn the <DIAL> dial to select a button or dial, then press <SET>.
- ▶ The name of the camera control and the assignable functions will be displayed.



3 Assign a function.

- Turn the <DIAL> dial to select the desired function, then press <SET>.
- If the [INFO] icon appears on the bottom left, you can press the <INFO> button and set other related options (p.348-356). Select the desired option on the screen displayed, then press <SET>.







4 Exit the setting.

- When you press <SET> to exit the setting, the screen in step 2 will reappear.
- Press the <MENU> button to exit.

















With the screen in step 2 displayed, you can press the <CANCEL> button to cancel the Custom Control settings. Note that the [5: Custom Controls] settings will not be canceled even if you select [7: Clear all Custom Func. (C.Fn)].





Assignable Functions to Camera Controls

Function		Page		AF-ON	
AF	AF Metering and AF start	348	<input type="radio"/>	<input type="radio"/> *1	<input type="radio"/> *1
	AF-OFF AF stop	350		<input type="radio"/>	<input type="radio"/>
	AF↔ Switch to registered AF function				
	ONE SHOT ↔ AI SERVO			<input type="radio"/>	<input type="radio"/>
	AF point direct selection	351			
	Select AF point, + ↔ (● during metering)				
Exposure	Metering start	351	<input type="radio"/>		
	AE lock			<input type="radio"/>	<input type="radio"/>
	AE lock (while button pressed)		<input type="radio"/>		
	AE lock (hold)			<input type="radio"/>	<input type="radio"/>
	FEL FE lock	352		<input type="radio"/>	<input type="radio"/>
	ISO Set ISO speed				
	ISO↓ Set ISO speed (hold button, turn)				
	ISO Set ISO speed (● during metering)				
	Set ISO speed ↔ ISO (● during metering)				
	Tv Shutter speed setting in M mode	353			
Av Aperture setting in M mode					
Exposure compensation (hold button, turn)					

	LENS*	M-Fn	M-Fn2	SET			
	<input type="radio"/>						
<input type="radio"/>	<input type="radio"/>		<input type="radio"/>				
<input type="radio"/> *2	<input type="radio"/> *2		<input type="radio"/>				
<input type="radio"/>	<input type="radio"/>		<input type="radio"/>				
<input type="radio"/> *3	<input type="radio"/> *3		<input type="radio"/>				
						<input type="radio"/>	<input type="radio"/> *4
						<input type="radio"/>	
<input type="radio"/>	<input type="radio"/>	<input type="radio"/>	<input type="radio"/>				
<input type="radio"/>	<input type="radio"/>	<input type="radio"/>	<input type="radio"/>				
<input type="radio"/>		<input type="radio"/>	<input type="radio"/>				
				<input type="radio"/>			
				<input type="radio"/>			
						<input type="radio"/>	
						<input type="radio"/>	
					<input type="radio"/>	<input type="radio"/>	
					<input type="radio"/>	<input type="radio"/>	
				<input type="radio"/>			

* The AF stop button (**LENS**) is provided only on super telephoto IS lenses.

Function		Page		AF-ON	
Image	 Image size selection	353			
	 One-touch image quality setting				
	 One-touch image quality (hold)				
	 Record func+card/folder selection	354			
	 14fps super high speed			○	○
	 Picture Style				
	WB White balance selection				
Operation	 Depth-of-field preview	354			
	 IS start				
	 VF electronic level	355			
	MENU Menu display				
	 Register/recall shooting function			○*6	○*6
	 Start movie recording (when  set)	356			
	C Switch to Custom shooting mode				
	 Image replay				
	 Magnify/Reduce (press SET, turn )				
	OFF No function (disabled)			○	○

	LENS *	M-Fn	M-Fn2	SET			
				○			
○ *5		○ *5	○				
○ *5		○ *5	○				
				○			
				○			
				○			
○			○				
○	○		○				
○		○	○				
				○			
○		○	○				
		○					
				○			
				○			
○			○	○			○

* The AF stop button (**LENS**) is provided only on super telephoto IS lenses.

AF: Metering and AF start

When you press the button assigned to this function, metering and AF are executed.

*1: If it is assigned to the <AF-ON> or <★> button and you press the <INFO.> button in step 3 on page 343, you can set the AF in detail. For shooting, pressing the <AF-ON> or <★> button will execute AF as it was set.

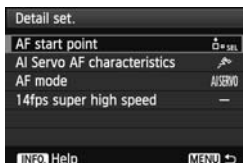

● AF starting point

When [Registered AF point] is set, you can press the <AF-ON> or <★> button to switch to the registered AF point.

AF Point Registration Procedure

1. Set the AF Area selection mode to one of the following: Single-point Spot AF (manual selection), Single-point AF (manual selection), AF point expansion (manual selection \square), AF point expansion (manual selection, surrounding points), or 61-point automatic selection AF. Zone AF (manual selection of zone) cannot be selected.
2. Select an AF point manually.
3. Hold down the <☑> button and press the <ISO> button. A beep will sound and the AF point will be registered. If the AF area selection mode is set to other than 61-point automatic selection AF, the registered AF point will blink.



- When an AF point is registered, the following will be displayed:
 - 61-point automatic selection AF: [] HP (HP: Home Position)
 - Spot AF, 1 pt AF, Expand AF Area: **SEL []** (Center), **SEL HP** (Off-center)
- When registered with **SEL []** or **SEL HP**, the registered AF point will blink.
- If [AF4: Orientation linked AF point] is set to [Separate AF pts: Area+pt] or [Separate AF pts: Pt only], you can register the AF points to be used separately for vertical (grip at the top or bottom) and horizontal shooting.
- To cancel the registered AF point, hold down the <☑> button and press the <☒> button. The registered AF point will also be canceled if you select [4: Clear all camera settings].

- **AI Servo AF characteristics** (p.85)
Press the <AF-ON> or <✳> button to perform AF with [Case1] to [Case6].
- **AF mode** (p.66)
Press the <AF-ON> or <✳> button to perform AF with AF mode set.
- **Super high speed continuous shooting** (p.116)
Press the <AF-ON> or <✳> button to perform <SH> Super high-speed continuous shooting when <H> High-speed continuous shooting is set.

If you want to use the AF point selected when you press the <AF-ON> or <✳> button, set [AF start point] to [Manually selected AF point]. If you want to instead retain the AI Servo AF characteristics, AF mode, and drive mode that have been set, select [-].

AF-OFF: AF stop

The AF will stop while you hold down the button assigned to this function. Convenient when you want to lock the focus during AI Servo AF.

AF⇄: Switch to registered AF function

After setting AF area selection mode (p.69), Tracking sensitivity (p.90), Acceleration/deceleration tracking (p.91), AF point auto switching (p.92), AI Servo 1st image priority (p.94), and AI Servo 2nd image priority (p.94) and assigning this function to a button, you can apply these settings while you hold down the assigned button for AF.

Convenient when you want to change the AF characteristics during AI Servo AF.

*2: In step 3 on page 343, if you press the <INFO.> button, the "Switch to registered AF func." setting screen will appear. Turn the <◂> or <◃> dial to select the parameter to be registered, then press <SET> to append a checkmark <✓>. When you select a parameter and press <SET>, you can set the parameter. By pressing the <⏏> button, you can revert the settings to their defaults.

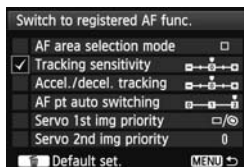

ONESHOT AI SERVO ⇄: ONE SHOT ⇄ AI SERVO





You can switch the AF mode. In One-Shot AF mode, when you hold down the button to which this function is assigned, the camera switches to AI Servo AF mode. In the AI Servo AF mode, the camera switches to One-Shot AF mode only while you hold down the button. Convenient when you need to keep switching between One-Shot AF and AI Servo AF for a subject that keeps moving and stopping.



□ HP : Switch to registered AF point





During metering, when you press the button assigned to this function, the camera will switch to the AF point registered on page 348.







*3: In step 3 on page 343, when you press the <INFO.> button, you can select [Switch only when btn is held] or [Switch each time btn is pressed].

 : AF point direct selection

During metering, you can select an AF point directly with the  dial or  without pressing the  button. With the  dial, you can select a left or right AF point, or cycle through the zones if using Zone AF.

*4: If you use  and press the  button in step 3 on page 343, you can press  straight down to select **[Switch to center AF point]** or **[Switch to registered AF point]**.

 : Select AF point,    ( during metering)

You can select the AF point directly with the  dial without first pressing the  button. While metering is active, turning the  dial will select a horizontal AF point, or cycle through the zones if using Zone AF. The functions of the  and  buttons will be switched between them. By holding down the  button and turning the  dial, you can set the exposure compensation or aperture.

 : Metering start

When you press the shutter button halfway, only exposure metering is performed.

 : AE lock

When you press the button assigned to this function, you can lock the exposure (AE lock) during the metering. This is convenient when you want to focus and meter the shot separately or when you want to take multiple shots at the same exposure setting.

 : AE lock (while button pressed)

The exposure will be locked (AE lock) while you press the shutter button.

 : AE lock (hold)

When you press the button assigned to this function, you can lock the exposure (AE lock). The AE lock will be maintained until you press the button again. This is convenient when you want to focus and meter the shot separately or when you want to take multiple shots at the same exposure setting.

 If you assign **[AE lock (while button pressed)]** to the shutter button, any buttons assigned to **[AE lock]** or **[AE lock (hold)]** will also work as **[AE lock (while button pressed)]**.

FEL: FE lock

During flash photography, pressing the button assigned to this function will fire a preflash and record the required flash output (FE lock).

ISO: Set ISO speed

You can press <SET> to change the ISO speed. Set while looking at the top LCD panel, viewfinder, or LCD monitor.



ISO↓: Set ISO speed (hold button, turn)

You can set the ISO speed by holding down <SET> and turning the < dial. If Auto ISO is set, manual ISO speed setting will take effect. The setting cannot be reverted to Auto ISO. If you use this function in the <M> mode, you can adjust the exposure with the ISO speed while maintaining the current shutter speed and aperture.



ISO☉: Set ISO speed (during metering)

During metering, you can set the ISO speed by turning the < dial. If Auto ISO is set, manual ISO speed setting will take effect. The setting cannot be reverted to Auto ISO. If you use this function in the <M> mode, you can adjust the exposure with the ISO speed while maintaining the current shutter speed and aperture.



ISO ISO: Set ISO speed, ↔ ISO (during metering)

During metering, you can set the ISO speed by turning the < dial. The functions of the < and <ISO> buttons will be switched between them. By pressing the <ISO> button and turning the < dial, you can set the exposure compensation or aperture.



Tv: Shutter speed setting in M mode

In manual exposure <M>, you can set the shutter speed with the < or < dial.



Av: Aperture setting in M mode

In manual exposure <M>, you can set the aperture with the < > or < > dial.

: Exposure compensation (hold button, turn)

You can set exposure compensation by holding down < > and turning the < > dial. Convenient when you want to set exposure compensation while <M> manual exposure and Auto ISO are both set.

: Image size selection

While looking at the rear LCD panel, you can press < > to switch to the other card or to change the image size. To switch to the other card, turn the < > dial. To change the image size, turn the < > dial.

RAW JPEG H : One-touch image quality setting

When you press the button assigned to this function, you can switch to the image size set here. While the camera switches the image size, the image size on the rear LCD panel and **JPEG** or **RAW** in the viewfinder will blink. After the shooting ends, the One-touch image quality setting will be canceled automatically and the camera will switch back to the previous image-recording quality.

*5: In step 3 on page 343, if you press the <INFO.> button, you can set the image size for this function to switch to.

RAW JPEG H : One-touch image quality (hold)

When you press the button assigned to this function, you can switch to the image size set here. While the camera switches the image size, the image size on the rear LCD panel and **JPEG** or **RAW** in the viewfinder will blink. Even after shooting, the One-touch image quality setting will not be canceled automatically. To revert to the previous image size, press the button assigned to this function again.

*5: In step 3 on page 343, if you press the <INFO.> button, you can set the image size for this function to switch to.

: **Record func+card/folder selection**

Press < > to display the [Record func+card/folder sel.] screen (p.120) on the LCD monitor.

: **14fps super high speed**

In the < H > drive mode, while you hold down the <AF-ON> or <* > button and press the shutter button completely, you can switch to super high speed continuous shooting (max. approx. 14 fps).

: **Picture Style**

Press < > to display the Picture Style selection setting screen (p.135) on the LCD monitor.

WB: White balance selection

You can press < > to change the white balance. Set while looking at the top LCD panel or LCD monitor.

: **Depth-of-field preview**

When you press the depth-of-field preview button or the Multi-function 2 button, the aperture will stop down and you can check the depth of field (p.176).

: **IS start**

With the lens' IS switch set to <ON>, the lens' Image Stabilizer operates when you press the button assigned to this function.

 **VF electronic level**

When you press the button assigned to this function, the viewfinder will display a grid and an electronic level using the AF points.

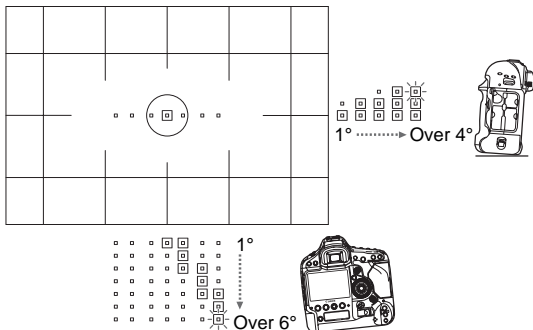

MENU: Menu display

Pressing $\langle \text{SET} \rangle$ will display the menu on the LCD monitor.



 **Register/recall shooting function**

You can manually set the main shooting functions such as the shooting mode, ISO speed, metering mode, and AF Area selection mode and register them to the camera. You can recall and use the registered shooting function settings to shoot, with the settings active only as long as you hold down the $\langle \text{AF-ON} \rangle$ or $\langle * \rangle$ button.

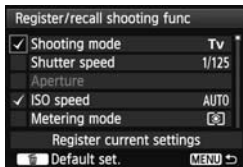
*6: In step 3 on page 343, you can press the $\langle \text{INFO.} \rangle$ button to set the shooting functions to be registered. Turn the $\langle \odot \rangle$ or $\langle \text{☀} \rangle$ dial to select the function to be registered, then press $\langle \text{SET} \rangle$ to append a checkmark $\langle \checkmark \rangle$. When you select a function name and press $\langle \text{SET} \rangle$, you can set the function. After registering all the shooting functions, press the $\langle \text{MENU} \rangle$ button to register. When registering the current settings on the camera, select **[Register current settings]** at the bottom of the screen, turn the $\langle \odot \rangle$ dial to confirm the settings and select **[Apply]**.



: **Start movie recording (when  set)**



With [**LV /  set.**] set to [**Movies**], pressing the button assigned with this function will start the movie shooting immediately. To stop the movie shooting, press the button again.

C: **Switch to Custom shooting mode**

When the shooting mode is not <**C1**>, <**C2**>, or <**C3**>, you can press the <**M-Fn**> button to switch to the registered Custom shooting mode (p.361). If multiple Custom shooting modes have been registered, each time you press the <**M-Fn**> button, it will switch the shooting mode from **C1** → **C2** → **C3** → current shooting mode. However, during movie shooting, pressing the <**M-Fn**> button will not switch to the Custom shooting modes. (Movie shooting will start.)

: **Image replay**

Press < > to play back images.

: **Magnify/Reduce (press SET, turn )**

Press < > to magnify the images recorded on the card. See page 259 for the operation procedure. You can magnify the Live View image during Live View shooting and movie shooting when focusing in Live Mode, Quick Mode, or with manual focus (p.218, 222).

OFF: No function (disabled)

Use this setting when you do not want to assign any function to the button.

MENU Registering My Menu

Under the My Menu tab, you can register up to six menu options and Custom Functions whose settings you change frequently.

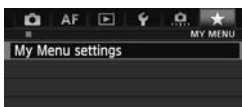

1 Select [My Menu settings].

- Under the [★] tab, select [My Menu settings], then press <SET>.

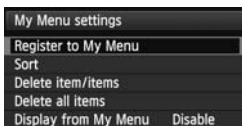

2 Select [Register to My Menu].

- Select [Register to My Menu], then press <SET>.

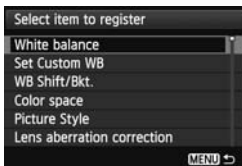

3 Register the desired items.

- Select an item to register, then press <SET>.
- On the confirmation dialog, select [OK] and press <SET> to register the item.
- You can register up to six items.
- To return to the screen in step 2, press the <MENU> button.

About My Menu Settings

● Sort

You can change the order of the registered items in My Menu. Select [Sort] and select the item whose order you want to change. Then press <SET>. With [▲] displayed, turn the <DIAL> to change the order, then press <SET>.

● Delete item/items and Delete all items

You can delete any of the registered items. [Delete item/items] deletes one item at a time, and [Delete all items] deletes all registered items.

● Display from My Menu

When [Enable] is set, the [★] tab will be displayed first when you display the menu screen.

MENU Saving and Loading Camera Settings

The camera's shooting modes, menus, Custom Functions, and other camera settings can be saved to the card as a camera settings file. When this file is loaded by the camera, the saved camera settings will be applied.

Convenient when you want to load the camera settings from a different EOS-1D X body and set the camera in the same way. Or you can save and load different camera settings for different shooting situations.

Saving Camera Settings

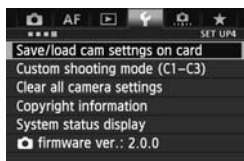

1 Select [Save/load cam settings on card].

- Under the [**4**] tab, select [**Save/load cam settings on card**], then press <SET>.

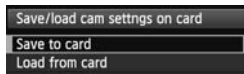

2 Select [Save to card].

- Turn the <DISP> dial to select [**Save to card**], then press <SET>.

Target card



3 Select [Start].

- Turn the <DISP> dial to select [**Start**], then press <SET>.
- ▶ The camera settings will be saved to the card, and the screen in step 2 will reappear.

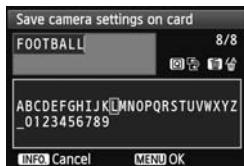

- If you select [**Change file name**], you can change the file name (8 characters) and save the file.

For the procedure, see “Changing the File Name” on page 162. The number of characters that can be entered will be different, but the procedure for entering the file name is the same.

Saved Settings

- **Shooting functions**

Shooting mode, Shutter speed, Aperture, ISO speed, AF mode, AF area selection mode, AF point, Metering mode, Drive mode, Exposure compensation amount, Flash exposure compensation amount

- **Menu functions**

[1] White balance, Set Custom WB, White balance Shift/Bracketing, Color space, Picture Style, Lens aberration correction (Peripheral illumination correction, Chromatic aberration correction), Multiple exposure (settings)

[3] Image review, Beep, Release shutter without card, Mirror lockup, External Speedlite control (Flash firing, E-TTL II metering, Flash sync. speed in Av mode)

[5 (Movie)]

Silent Control, Movie shooting button

[2] Slide show (settings), Image jump with

[3] Highlight alert, AF point display, Playback grid, Histogram, Magnification (approx.)

[1] Recording function+card/folder selection (Recording function), File numbering, File name, Auto rotate

[2] Auto power off, LCD brightness, VF grid display, **INFO** button display options

[3] Sensor cleaning (Auto cleaning), GPS device settings (GPS device, Set time automatically, Digital compass)

[4] Custom shooting mode (C1-C3)

[] My Menu settings

All the menu settings under the following menu tabs will be saved:

[2], [4 (Live View shooting)], [4 (Movie)], [**AF1**], [**AF2**], [**AF3**], [**AF4**], [**AF5**], [.1], [.2], [.3], [.4], [.5], [.6]

Loading Camera Settings

In step 2, select **[Load from card]**. Up to ten camera settings files saved in the card will be displayed. When you select the desired file, it will be loaded and the settings will be applied to the camera.



Compatibility of camera settings file

- A file saved by a camera having firmware version 2.x.x cannot be read by a camera having firmware version 1.x.x. A file saved by a camera having firmware version 1.x.x can be read by a camera having firmware version 2.x.x.



- Up to ten camera settings files can be saved in a card. If the card already has ten camera settings files, you can either overwrite an existing file, replace the card, or save to another card.
- Camera settings files saved with a camera other than the EOS-1D X cannot be loaded to this camera.

C: Registering Custom Shooting Modes

You can register your preferred shooting mode, menu settings, Custom Function settings, and other current camera settings to the <C1>/<C2>/<C3> Custom shooting modes. To use <C2> or <C3>, set them in [..2: Restrict shooting modes] (p.330).

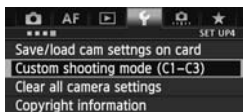

1 Select [Custom shooting mode (C1-C3)].

- Under the [F4] tab, select [Custom shooting mode (C1-C3)], then press <SET>.



2 Select [Register settings].

- Turn the <DIAL> dial to select [Register settings], then press <SET>.

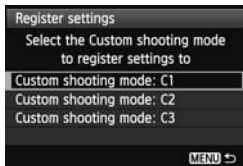

3 Register the Custom shooting mode.

- Turn the <DIAL> dial to select the Custom shooting mode to be registered, then press <SET>.
- On the confirmation dialog, select [OK] and press <SET>.
- ▶ The current camera settings (p.362) will be registered under the C* shooting mode.

Automatic Updating

If you shoot in the <C1>/<C2>/<C3> mode and change a camera setting, the Custom shooting mode can be updated automatically to reflect the changed setting. To enable this automatic update, in step 2, set [Auto update set.] to [Enable]. The settings which can be automatically updated are listed on pages 362 and 363.

Canceling Registered Custom Shooting Modes

In step 2, if you select [Clear settings], the respective Custom shooting mode will revert to the default settings effective before you registered the camera settings. The procedure is the same as step 3.

Settings Registered

● Shooting functions

Shooting mode, Shutter speed, Aperture, ISO speed, AF mode, AF area selection mode, AF point, Metering mode, Drive mode, Exposure compensation amount, Flash exposure compensation amount



● Menu functions

[1] White balance, Set Custom WB, White balance Shift/Bracketing, Color space, Picture Style, Lens aberration correction (Peripheral illumination correction, Chromatic aberration correction), Multiple exposure (settings)

[3] Image review, Beep, Release shutter without card, Mirror lockup, External Speedlite control (Flash firing, E-TTL II metering, Flash sync. speed in Av mode)

[5 (Movie)]

Movie recording count, Movie play count, Silent Control, Movie shooting button

[2] Slide show (settings), Image jump with 

[3] Highlight alert, AF point display, Playback grid, Histogram, Movie play count, Magnification (approx.)

[1] File numbering, Auto rotate







[2] Auto power off, LCD brightness, VF grid display, **INFO** button display options

[3] Sensor cleaning (Auto cleaning)

[2] Restrict shooting modes, Metering used in manual exposure, Set shutter speed range, Set aperture range

[4] Viewfinder information during exposure, LCD panel illumination during Bulb, Recording card, image size setting

All the menu settings under the following menu tabs will be saved:

[2], [4 (Live View shooting)], [4 (Movie)], [**AF**1], [**AF**2], [**AF**3], [**AF**4], [**AF**5], [1], [3], [5] (except <M-Fn> button), [6]



- My Menu settings will not be registered.
- When the shooting mode is <C1>, <C2>, or <C3>, you cannot select [**4: Clear all camera settings**] and [**7: Clear all Custom Func. (C.Fn)**].



- Even in the <C1>, <C2>, or <C3> shooting mode, you can still change the shooting function settings and menu settings.
- <C*> displayed on the top LCD panel together with the shooting mode indicates that a registered Custom shooting mode is in use.

13

Reference

This chapter provides reference information for camera features, system accessories, etc.

Using the Cable Protector

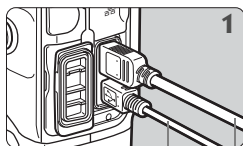

Interface cable
HDMI cable (Sold separately)

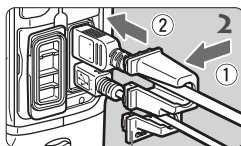

Cable Protector

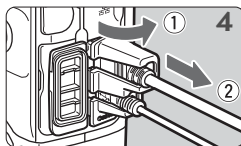
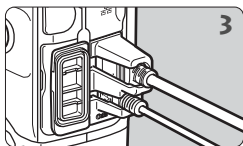

Function Availability Table According to Shooting Mode

●: Set automatically ○: User selectable □: Not selectable/Disabled

Function		Viewfinder Shooting					LV Shooting	Movie Shooting
		P	Tv	Av	M	BULB		
All image quality settings selectable		○	○	○	○	○	○	(Still photo)
ISO speed	Automatically set/Auto ISO	○	○	○	○	○	○	○
	Manual	○	○	○	○	○	○	In M
Picture Style		○	○	○	○	○	○	○
White balance	Auto	○	○	○	○	○	○	○
	Preset	○	○	○	○	○	○	○
	Custom	○	○	○	○	○	○	○
	Color temperature setting	○	○	○	○	○	○	○
	WB correction	○	○	○	○	○	○	○
	WB-BKT	○	○	○	○	○	○	(Still photo)
Auto Lighting Optimizer		○	○	○	○	○	○	○
Lens aberration correction	Peripheral illumination correction	○	○	○	○	○	○	○
	Chromatic aberration correction	○	○	○	○	○	○	○
Long exposure noise reduction		○	○	○	○	○	○	
High ISO speed noise reduction		○	○	○	○	○	○	○
Highlight tone priority		○	○	○	○	○	○	○
Multiple exposures		○	○	○	○	○	○	
Color space	sRGB	○	○	○	○	○	○	Movie ● (Still photo)
	Adobe RGB	○	○	○	○	○	○	(Still photo)
AF	AF mode	One-Shot AF	○	○	○	○	AF-Live / AF-ON / AF-Quick *1+2	
		AI Servo AF	○	○	○	○		
	AF area selection mode	○	○	○	○	○		

*1: If used during movie shooting, it will switch to AF-Live.

*2: Works only before the start of movie shooting.

*3: In the <M> mode with Auto ISO set, you can set a fixed ISO speed.

*4: In the <M> mode with Auto ISO set, exposure compensation is possible.

Function			Viewfinder Shooting					LV Shooting	Movie Shooting
			P	Tv	Av	M	BULB		
AF	AF point selection	Auto	○	○	○	○	○	With AF-ON	
		Manual	○	○	○	○	○		
	AF-assist beam		○	○	○	○	○		
	Manual focusing (MF)		○	○	○	○	○	○	
	AF Configuration Tool		○	○	○	○	○		
AF Microadjustment		○	○	○	○	○	With AF-ON		
Metering mode	Evaluative metering		○	○	○	○	○	● With AF-L	
	Partial metering		○	○	○	○	○		
	Spot metering		○	○	○	○	○		
	Center-weighted average metering		○	○	○	○	○	●	
Exposure	Program shift		○					○	
	AE lock *3		○	○	○			○	Except in M
	Exposure compensation		○	○	○	○ ⁺⁴		○	○ ⁺⁴
	AEB		○	○	○	○		○	
	Depth-of-field preview		○	○	○	○	○	○	
Drive	Single shooting		○	○	○	○	○	(Still photo)	
	High-speed continuous shooting		○	○	○	○	○		
	Low-speed continuous shooting		○	○	○	○	○		
	Ⓢ ¹⁰ (10 sec.)		○	○	○	○	○	○ ⁺²	
	Ⓢ ₂ (2 sec.)		○	○	○	○	○	○ ⁺²	
	Single: silent shooting		○	○	○	○	○	○	(Still photo)
Super high speed continuous shooting		○	○	○	○	○	○	(Still photo)	
External Speedlite	FE lock		○	○	○	○	○		
	Flash exposure compensation		○	○	○	○	○	○	
	Function settings		○	○	○	○	○	○	
Quick Control			○	○	○	○	○	○	

System Map

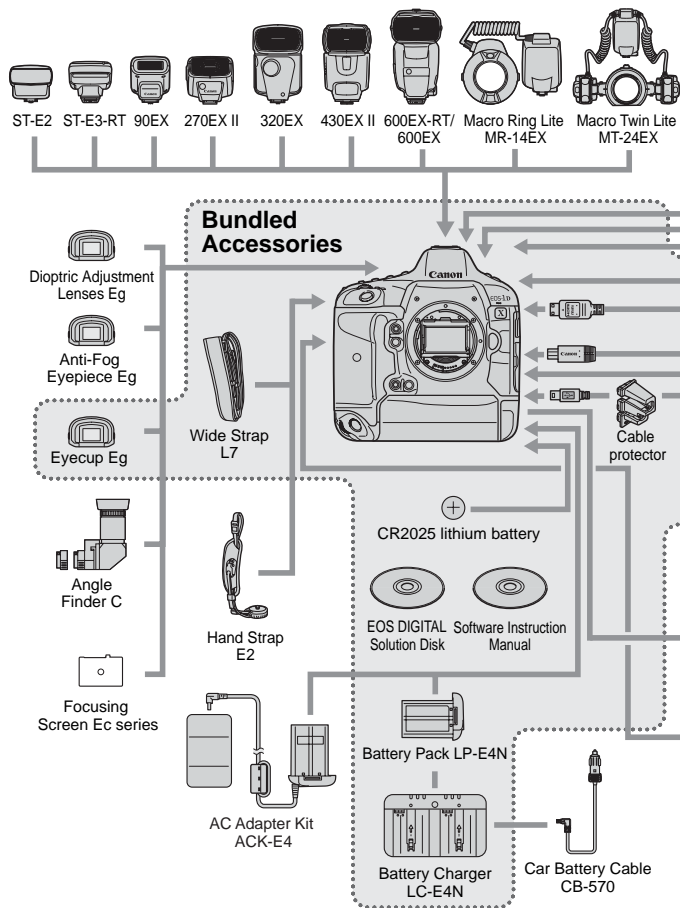

* Battery Pack LP-E4 and Battery Charger LC-E4 are also compatible.

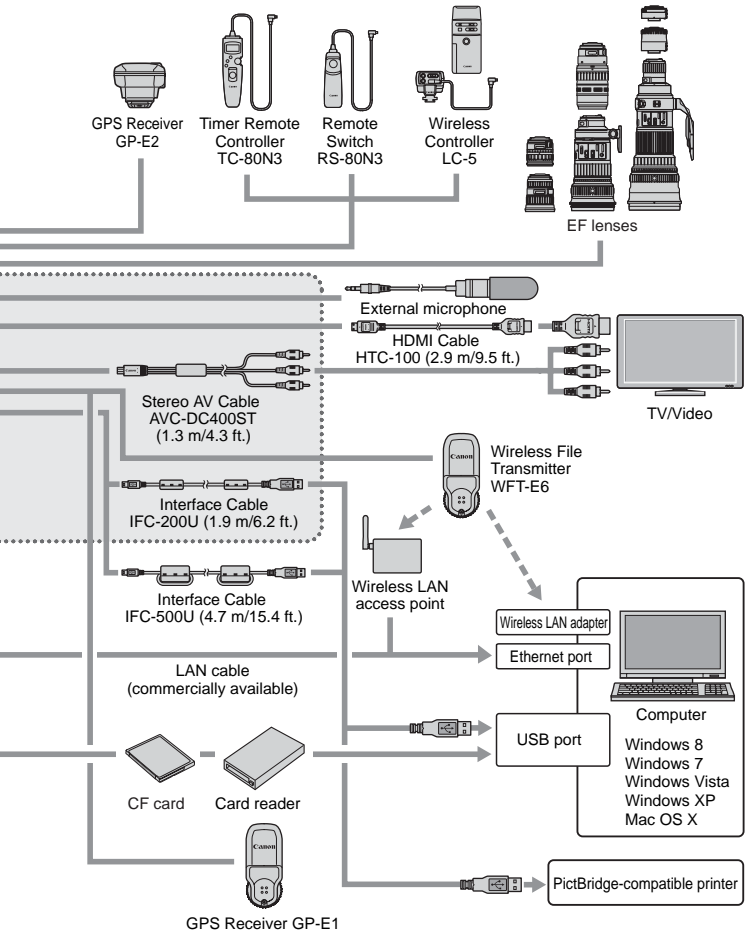

* The length of all cables is approx. **m/**ft.

INFO. Button Functions



When you press the <INFO.> button while the camera is ready to shoot, you can display **[Displays camera settings]**, **[Electronic level]** (p.61), and **[Displays shooting functions]** (p.371).

Under the [**2**] tab, [**INFO**] **button display options** enables you to select the options displayed when the <INFO.> button is pressed.

- Select the desired display option and press <SET> to append a checkmark <✓>.
- After making the selection, select [OK], then press <SET>.

- Note that you cannot remove the <✓> for all three display options.
- The **[Displays camera settings]** sample screen is displayed in English for all languages.
- Even if you uncheck the **[Electronic level]** so it does not appear, it will still appear for Live View shooting and movie shooting when you press the <INFO.> button.

Camera Settings

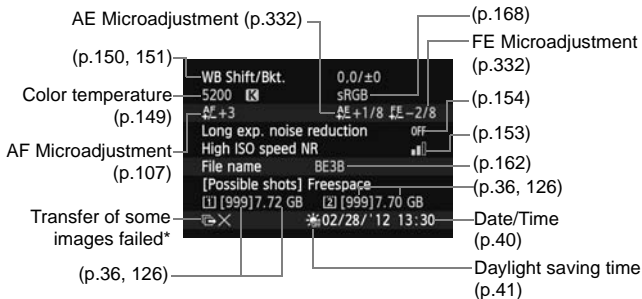

* This icon is displayed when an image transfer fails.

Shooting Settings

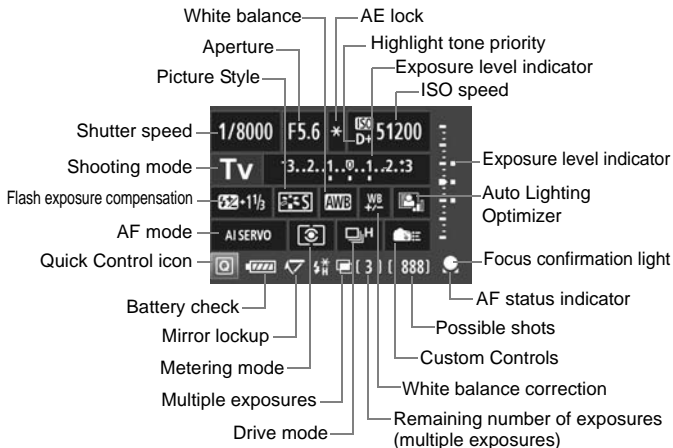

- Pressing the $\langle \text{Q} \rangle$ button enables Quick Control of the shooting settings (p.51).
- If you press the $\langle \text{MODE} \rangle$, $\langle \text{AF} \cdot \text{DRIVE} \rangle$, $\langle \text{ONE SHOT} \rangle$, $\langle \text{METERING} \rangle$, $\langle \text{ISO} \rangle$, $\langle \text{WB} \rangle$, or $\langle \text{WB} \rangle$ button, the respective setting screen will appear on the LCD monitor and you can turn the $\langle \text{INFO} \rangle$ or $\langle \text{INFO} \rangle$ dial to set the function. You can also select the AF point with $\langle \text{INFO} \rangle$.



If you turn off the power while the "Shooting settings display" screen is displayed, the same screen will be displayed when you turn on the power again. To cancel this operation, press the $\langle \text{INFO} \rangle$ button to turn off the screen, then turn off the power switch.

MENU Checking the Battery Information

You can check the battery's condition on the LCD monitor.

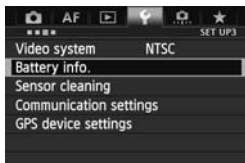

Select [Battery info.].

- Under the [**F3**] tab, select [**Battery info.**], then press <SET>.

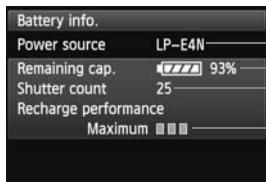

Battery model or household power source being used.

The battery level icon (p.39) is displayed together with the remaining battery capacity shown in 1% increments.

Shots taken with the current battery. The number is reset when the battery is recharged (p.30).

Battery's recharge performance level is displayed in one of three levels.

■■■■ (Green):

Battery's recharge performance is fine.

■■■□ (Green):

Battery's recharge performance is slightly degraded.

■■□□ (Red):

Purchasing a new battery is recommended.

! The use of a genuine Canon Battery Pack LP-E4N or LP-E4 is recommended. If you use any battery other than the Battery Pack LP-E4N or LP-E4, the camera's full performance may not be attained or malfunction may result.

- The shutter count is the number of still photos taken. (Movies are not counted.)
- If [**Calibration is recommended when charging battery next time**] is displayed, see page 32.
- If for some reason, communication with the battery is not successful, [**Use this battery?**] will be displayed. Just select [**OK**] and you can continue shooting. However, the battery information screen might not appear.

Using a Household Power Outlet

With the AC Adapter Kit ACK-E4 (sold separately), you can connect the camera to a household power outlet and not worry about the remaining battery level.

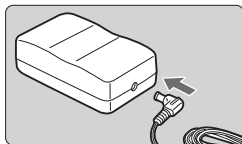

1 Connect the DC Coupler's plug.

- Connect the DC Coupler's plug to the AC adapter's DC terminal.

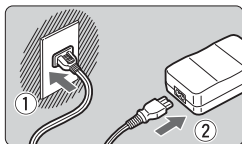

2 Connect the power cord.

- Connect the power cord as shown in the illustration.
- After using the camera, unplug the power plug from the power outlet.

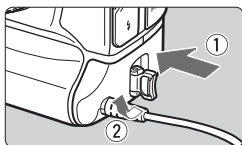

3 Insert the DC Coupler.

- Insert the DC Coupler firmly all the way, and turn the release handle as shown by the arrow.



- Since the DC Coupler is not water-resistant, do not get it wet.
- Do not connect or disconnect the power cord or DC Coupler while the camera's power switch is set to <ON/LOCK>.

Replacing the Date/Time Battery

The date/time (backup) battery maintains the camera's date and time. Its service life is approx. 5 years. If the date/time is reset when camera is turned on, follow the procedure below to replace the backup battery with a new CR2025 lithium battery.

The date/time/zone setting will also be reset, so be sure to set the correct date/time/zone (p.40).

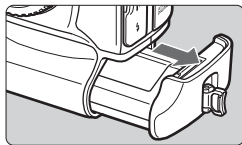

1 Set the power switch to <OFF>.

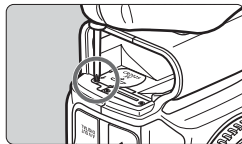

2 Remove the battery.

- The backup battery is on the ceiling of the battery compartment.

3 Remove the back-up battery cover.

- Use a small screwdriver to loosen the screw and remove the cover.
- Be careful not to lose the cover and screw.



4 Remove the battery.

- Stick a piece of tape to the battery and take out the battery.



5 Install a new back-up battery.

- The plus side of the battery must face up.

6 Attach the cover.

 For the date/time battery, be sure to use a CR2025 lithium battery.

Menu Settings

For Viewfinder Shooting and Live View Shooting

📷: Shooting 1 (Red)

Page

White balance	AWB / ☀️ / 🏠 / ☁️ / 🌅 / 🌄 / 🔋 / 📶 (1 - 5) / K (Approx. 2500 - 10000) / PC-1 - 5	143
Set Custom WB	Manual registration of white balance data	144
White balance shift/ bracketing	White balance correction: B/A/M/G bias, 9 levels each White balance bracketing: B/A and M/G bias, single-level increments, ±3 levels	150
Color space	sRGB / Adobe RGB	168
Picture Style	A Auto / S Standard / P Portrait / L Landscape / N Neutral / F Faithful / M Monochrome / 1 User Def. 1-3	135
Lens aberration correction	Peripheral illumination: Enable/Disable Chromatic aberration: Enable/Disable	157
Multiple exposure	Multiple exposure / Multiple exposure control / No. of exposures / Save source images / Continue multiple exposure	186

* For movie shooting, **[Multiple exposure]** cannot be selected (grayed out).

 **Shooting 2 (Red)**

Page

JPEG quality	Compression rate for L , M1 , M2 , S	129
Image type/size	RAW / M RAW / S RAW	123
	L / M1 / M2 / S	
ISO speed settings	ISO speed / ISO speed range / Auto ISO range / Minimum shutter speed	130
Auto Lighting Optimizer	Disable / Low / Standard / High	152
	Disable during manual exposure	
Long exposure noise reduction	Disable / Auto / Enable	154
High ISO speed noise reduction	Standard / Low / High / Disable	153
Highlight tone priority	Disable / Enable	156





 **Shooting 3 (Red)**

Image review	Off / 2 sec. / 4 sec. / 8 sec. / Hold	57
Beep	Enable / Disable	—
Release shutter without card	Enable / Disable	36
Mirror lockup	Disable / Enable / Enable: Mirror down w/ SET	193
Dust Delete Data	Obtain data to be used by provided software to delete dust spots	301
External Speedlite control	Flash firing / E-TTL II metering / Flash sync. speed in Av mode / Flash function settings / Clear flash settings / Flash C.Fn settings / Clear all Speedlite C.Fn's	199

 What is displayed in [**2: Image size**] depends on the [**Record func.**] (p.120) setting under [**1: Record func+card/folder sel.**]. If [**Rec. separately**] is set, set the image size for each card.

📷: Shooting 4* (Red)

Page

LV 📷/📽 setting	Disable / Stills / Movies	206
AF mode	Live mode /  Live mode / Quick mode	215
Grid display	Off / 3x3  / 6x4  / 3x3+diag 	212
Exposure simulation	Enable / During  / Disable	213
Silent LV shooting	Mode 1 / Mode 2 / Disable	214
Metering timer	4 sec. / 16 sec. / 30 sec. / 1 min. / 10 min. / 30 min.	214

AF: AF1 (Purple)

Case 1	Versatile multi purpose setting	86
Case 2	Continue to track subjects, ignoring possible obstacles	86
Case 3	Instantly focus on subjects suddenly entering AF points	87
Case 4	For subjects that accelerate or decelerate quickly	87
Case 5	For erratic subjects moving quickly in any direction (disabled in Single-point AF mode)	88
Case 6	For subjects that change speed and move erratically (disabled in Single-point AF mode)	89

AF: AF2 (Purple)









AI Servo 1st image priority	Release priority / Equal priority / Focus priority	94
AI Servo 2nd image priority	Shooting speed priority: -2/-1 / Equal priority: 0 / Focus priority: +1/+2	94

AF: AF3 (Purple)

Page

USM lens electronic MF	Enable after One-Shot AF / Disable after One-Shot AF / Disable in AF mode	95
AF-assist beam firing	Enable / Disable / IR AF assist beam only	96
One-Shot AF release priority	Release priority / Focus priority	96

AF: AF4 (Purple)

Auto AF point selection: EOS iTR AF	Enable / Disable	97
Lens drive when AF impossible	Continue focus search / Stop focus search	98
Selectable AF point	61 points / Only cross-type AF points / 15 points / 9 points	99
Select AF area selection mode	Manual selection: Spot AF / Manual selection: 1 point AF / Expand AF area:  / Expand AF area: Surround / Manual selection: Zone AF / Auto selection: 61 point AF	100
AF area selection method	 → M-Fn button /  → Main Dial	101
Orientation linked AF point	Same for both vertical/horizontal / Separate AF points: Area+point / Separate AF points: Point only	101
Initial AF point,  AI Servo AF	Initial  AF point selected / Manual     AF point	103

AF: AF5 (Purple)

Page

Manual AF point selection pattern	Stops at AF area edges / Continuous	104
AF point display during focus	Selected (constant) / All (constant) / Selected (pre-AF, focused) / Selected (focused) / Disable display	104
VF display illumination	Auto / Enable / Disable	105
AF status in viewfinder	Show in field of view / Show outside view	106
AF Microadjustment	Disable / All by same amount / Adjust by lens	107

▶: Playback 1 (Blue)

Protect images	Erase-protect images	279
Rotate image	Rotate vertical images	261
Erase images	Erase images	286
Print order	Specify images to be printed (DPOF)	315
Image copy	Copy images between cards	283

▶: Playback 2 (Blue)

RAW image processing	Process RAW images	292
Resize	Downsize the image's pixel count	297
Rating	[OFF] / [.] / [·] / [•] / [◐] / [◑] / [◒]	262
Slide show	Playback description, Display time, and Repeat for auto playback	272
Image transfer	Select images to be transferred to a personal computer or FTP server	319
Image jump with 	1 image / 10 images / 100 images / Date / Folder / Movies / Stills / Protect / Rating	258

▶: Playback 3 (Blue)

Page

Highlight alert	Disable / Enable	255
AF point display	Disable / Enable	255
Playback grid	Off / 3x3 田 / 6x4 田田 / 3x3+diag 田田	253
Histogram	Brightness / RGB	256
Movie play count*	Rec time / Time code	246
Magnification (Approx.)	1x (no magnification) / 2x (magnify from center) / 4x (magnify from center) / 8x (magnify from center) / 10x (magnify from center) / Actual size (from selected point) / Same as last magnification (from center)	260
Control over HDMI	Disable / Enable	276

* The setting is linked to the [Time code]'s [Movie play count] under the [CAMERA 5 (Movie)] tab.

🔑: Set-up 1 (Yellow)

Record function+card/ folder selection	[Record func.]	120
	Standard / Auto switch card / Record separately / Record to multiple	122
	[Record/play] [Playback] [1] / [2] [Folder] Creating and selecting a folder	160
File numbering	Continuous / Auto reset / Manual reset	164
File name	Preset code / User setting 1 / User setting 2	162
Auto rotate	On 📷 📺 / On 📺 / Off	289
Format card	Initialize and erase data on the card	55

🔧: Set-up 2 (Yellow)

Page

Auto power off	1 min. / 2 min. / 4 min. / 8 min. / 15 min. / 30 min. / Disable	57
LCD brightness	Adjustable to one of seven brightness levels	288
Date/Time/Zone	Date (year, month, day) / Time (hour, min., sec.) / Daylight saving time / Time zone	40
Language 	Select the interface language	42
VF grid display	Disable / Enable	61
INFO button display options	Displays camera settings / Electronic level / Displays shooting functions	370

🔧: Set-up 3 (Yellow)

Video system	NTSC / PAL	239 278
Battery info.	Power source / Remaining capacity / Shutter count / Recharge performance	372
Sensor cleaning	Auto cleaning: Enable / Disable	300
	Clean now	
	Clean manually	303
Communication settings	Settings for wired LAN* and wireless LAN via WFT-E6 (sold separately)	* Wired LAN Instruction Manual
GPS device settings*	Settings available when the GPS Receiver GP-E1/GP-E2 (sold separately) is attached	—



When using a GPS device or a Wireless File Transmitter, be sure to use the device in accordance with the laws of regulations of the countries or regions where you are using it.

🔑: Set-up 4 (Yellow)

Page

Save/load camera settings on card	Save/load camera settings to/from the card	358
Custom shooting mode (C1-C3)	Register current camera settings to the C1 , C2 , C3 shooting mode.	361
Clear all camera settings	Resets the camera to the default settings	58
Copyright information	Display copyright information / Enter author's name / Enter copyright details / Delete copyright information	166
System status display	Serial number / Firmware version / Release cycles / Camera status log	398
📷 Firmware ver.	For updating the firmware	—

🔑: Custom Functions (Orange)

C.Fn1: Exposure	Customize camera functions as desired	326
C.Fn2: Exposure		330
C.Fn3: Drive		333
C.Fn4: Display/Operation		334
C.Fn5: Operation		336
C.Fn6: Others		339
C.Fn7: Clear		Clears all Custom Function settings



















★: My Menu (Green)

My Menu settings	Register frequently-used menu options and Custom Functions	357
-------------------------	--	-----





For Movie Shooting

Shooting 4 (Movie) (Red)

Page

LV /  setting	Disable / Stills / Movies	226
AF mode	Live mode /  Live mode / Quick mode	247
Grid display	Off / 3x3  / 6x4  / 3x3+diag 	247
Movie recording size	1920x1080 ( /  / ) ( / ) 1280x720 ( / ) ( / ) 640x480 ( / ) ()	239
Sound recording	Sound recording: Auto / Manual / Disable	242
	Recording level	
	Wind filter: Disable / Enable	
Silent LV shooting	Mode 1 / Mode 2 / Disable	248
Metering timer	4 sec. / 16 sec. / 30 sec. / 1 min. / 10 min. / 30 min.	248

Shooting 5 (Movie) (Red)

Time code	Count up / Start time setting / Movie rec count / Movie play count* / Drop frame	245
Silent control	Enable  / Disable 	244
Movie shooting button	 /  / 	248

* The setting is linked to **[Movie play count]** under the **[▶] 3** tab.

Troubleshooting Guide

If a problem occurs with the camera, first refer to this Troubleshooting Guide. If this Troubleshooting Guide does not resolve the problem, contact your dealer or nearest Canon Service Center.

Power-Related Problems

The battery pack does not recharge.

- Do not recharge any battery pack other than a genuine Canon Battery Pack LP-E4N or LP-E4.

The battery charger's <CAL/CHARGE> lamp blinks in red, no Charge level lamp is lit, or all three Charge level lamps are blinking.

- See pages 32 and 33. If you are recharging Battery Pack LP-E4N with Battery Charger LC-E4 and all three Charge level lamps blink in green, use the charger to check the battery pack's recharge performance (p.31).
- If a Charge level lamp lights up, you can keep using the battery pack. However, if the battery pack's recharge performance is low, replacing the battery pack with a new one is recommended.
- If no Charge level lamps light up, the battery pack is faulty. Remove the battery pack from the charger and consult your dealer or nearest Canon Service Center.

The camera does not operate even when the power switch is set to <ON>.

- Make sure the battery is properly installed in the camera (p.34).
- Make sure the card slot cover is closed (p.35).
- Recharge the battery (p.30).

The access lamp still blinks even when the power switch is set to <OFF>.

- If the power is turned off while an image is being recorded to the card, the access lamp will remain on/continue to blink for a few seconds. When the image recording is completed, the power will turn off automatically.

The battery becomes exhausted quickly.

- Use a fully-charged battery pack (p.30).
- The battery performance may have degraded. See [**☛3: Battery info.**] to check the battery's recharge performance level (p.372). If the battery performance is poor, replace the battery pack with a new one.
- The number of possible shots will decrease with any of the following operations:
 - Pressing the shutter button halfway for a prolonged period.
 - Often activating only the AF without taking a picture.
 - Using the lens' Image Stabilizer.
 - Using the LCD monitor often.
 - Continuing Live View shooting or movie shooting for a prolonged period.

The camera turns off by itself.

- Auto power off is in effect. If you do not want auto power off to take effect, set [**☛2: Auto power off**] to [**Disable**] (p.57).
- Even if [**☛2: Auto power off**] is set to [**Disable**], the LCD monitor will still turn off after the camera is left idle for 30 min. (The camera's power does not turn off.)

Shooting-Related Problems

The lens cannot be attached.

- The camera cannot be used with EF-S or EF-M lenses (p.43).

The viewfinder is dark.

- Install a recharged battery pack in the camera (p.34).

No images can be shot or recorded.

- Make sure the card is properly inserted (p.35).
- If the card is full, replace the card or delete unnecessary images to make room (p.35, 286).
- If you try to focus in the One-Shot AF mode while the focus confirmation light <●> in the viewfinder blinks, a picture cannot be taken. Press the shutter button halfway again to refocus automatically, or focus manually (p.46, 114).

The card cannot be used.

- If a card error message is displayed, see page 37 or 401.

An error message is displayed when the card is inserted in another camera.

- Cards with capacities greater than 128 GB are formatted in exFAT. This means that if you format a card with a capacity over 128 GB with this camera and then insert it into another camera, an error may be displayed and it may not be possible to use the card.

The image is out of focus.

- Set the lens focus mode switch to <AF> (p.43).
- To prevent camera shake, press the shutter button gently (p.45, 46).
- If the lens has an Image Stabilizer, set the IS switch to <ON>.
- In low light, the shutter speed may become slow. Use a faster shutter speed (p.173), set a higher ISO speed (p.130), use flash (p.195), or use a tripod.

There are fewer AF points.

- Depending on the attached lens, the number of usable AF points and patterns will differ. The lenses are categorized into nine groups from A to I. Check which group your lens belongs to. Using a lens in Groups F to H will have fewer usable AF points (p.77).

The AF points are blinking.

- When you press the  button, the blinking AF points are those that are not cross-type AF points and are only horizontal line-sensitive. The AF points that light up are cross-type AF points (p.72).
- The AF point at the registered area is blinking (p.348).

I cannot lock the focus and recompose the shot.

- Set the AF mode to One-Shot AF. Note that focus lock will not work in the AI Servo AF mode (p.67).

The continuous shooting speed slows down.

- At the  setting, the maximum continuous speed will be approx. 10 shots/sec. if the ISO speed is set to any of the following:
 - ISO 32000 or higher is set manually.
 - **[Auto ISO range]**'s **[Maximum]** is set to **[51200]** and Auto ISO automatically sets ISO 32000 or higher.
 - **[1: Safety shift]** is set to **[ISO speed]** and the safety shift automatically sets ISO 32000 or higher.

Note that if the camera's internal temperature is low, and when ISO 20000 or higher is set manually or automatically, the maximum continuous shooting speed for  will be approx. 10 fps.

- Depending on the ISO speed, shutter speed, aperture, subject conditions, brightness, lens type, etc., the continuous shooting speed may become slower.
- If **[Auto AF pt sel.: EOS iTR AF]** is set to **[Enable]** (p.97) and you shoot under low light, the continuous shooting speed will decrease.

The maximum burst during continuous shooting is lower.

- If you shoot something that has fine detail (such as a field of grass), the file size will be larger and the actual maximum burst may be lower than the number mentioned on page 126.

ISO 100 cannot be set/ISO speed expansion cannot be selected.

- If [**2: Highlight tone priority**] is set to [**Enable**], the settable ISO speed range will be ISO 200 - 51200 (ISO 200 - 25600 for movie shooting). Even if you expand the settable ISO speed range in [**ISO speed range**], you cannot set expanded ISO speeds (L, H, H1, or H2). If [**2: Highlight tone priority**] is set to [**Disable**], ISO 100/125/160 can be set (p.156).

The Auto Lighting Optimizer cannot be set.

- If [**2: Highlight tone priority**] is set to [**Enable**], the Auto Lighting Optimizer cannot be set. If [**2: Highlight tone priority**] is set to [**Disable**], then the Auto Lighting Optimizer can be set (p.156).

Even though I set a decreased exposure compensation, the image comes out bright.

- Set [**2: Auto Lighting Optimizer**] to [**Disable**]. When [**Standard/Low/High**] is set, even if you set a decreased exposure compensation or flash exposure compensation, the image may come out bright (p.152).

I cannot set the exposure compensation while both manual exposure and Auto ISO are set.

- See page 178 to set the exposure compensation.
- Even if an exposure compensation is performed, it will not be applied for flash photography.

The Live View image or captured image is not displayed during multiple-exposure shooting.

- If [**On:ContShtng**] is set, Live View display, image review after image capture, and image playback are not possible during shooting (p.186).

The multiple-exposure image is shot in **RAW** quality.

- When the image size is set to **M RAW** or **S RAW**, the multiple-exposure image will be recorded in **RAW** quality (p.192).

When I use the **<Av>** mode with flash, the shutter speed becomes slow.

- If you shoot at night when the background is dark, the shutter speed becomes slow automatically (slow-sync shooting) so that both the subject and background are properly exposed. To prevent a slow shutter speed, under [**3: External Speedlite control**], set [**Flash sync. speed in Av mode**] to [**1/250-1/60 sec. auto**] or [**1/250 sec. (fixed)**] (p.200).

The flash does not fire.

- Make sure the flash (or PC sync cord) is securely attached to the camera.
- If you use a non-Canon flash unit with Live View shooting, set [**4: Silent LV shoot.**] to [**Disable**] (p.214).

The flash always fires at full output.

- If you use a flash unit other than an EX-series Speedlite, the flash will always be fired at full output (p.197).
- When the [**Flash metering mode**] flash Custom Function is set to [**TTL**] (autoflash), the flash will always be fired at full output (p.204).

Flash exposure compensation cannot be set.

- If flash exposure compensation has already been set with the Speedlite, flash exposure compensation cannot be set with the camera. When the Speedlite's flash exposure compensation is canceled (set to 0), flash exposure compensation can be set with the camera.



High-speed sync cannot be set in the <Av> mode.

- Under [ 3: External Speedlite control], set [Flash sync. speed in Av mode] to [Auto] (p.200).

The shutter makes two shooting sounds during Live View shooting.

- If you use flash, the shutter will make two sounds each time you shoot (p.208).

During Live View and movie shooting, a white or red icon is displayed.

- It indicates that the camera's internal temperature is high. If the white < > icon displayed, the still photo's image quality may deteriorate. If the red < > icon is displayed, it indicates that the Live View or movie shooting will soon stop automatically (p.223, 249).

Movie shooting stops by itself.

- If the card's writing speed is slow, movie shooting may stop automatically. With IPB compression, use a card with an actual reading/writing speed of at least 10 MB/sec. With ALL-I (I-only) compression, the card should have an actual reading/writing speed of at least 30 MB/sec. To find out the card's speed, see the card manufacturer's Web site (p.225).
- If the movie shooting time reaches 29 min. 59 sec., the movie shooting will stop automatically.

The ISO speed cannot be set for movie shooting.

- If the shooting mode is <P/Tv/Av/BULB>, the ISO speed will be set automatically. In the <M> mode, you can freely set the ISO speed (p.232).

For movie shooting, ISO 32000/40000/51200 cannot be set.

- Under [**2: ISO speed settings**], if [**ISO speed range**]'s [**Maximum**] is set to [**51200/H**] or higher, the manual setting range's Maximum will be expanded to enable ISO 32000/40000/51200 to be set. However, since movie shooting at ISO 32000/40000/51200 may result in substantial noise, the expanded ISO speed ("**H**" displayed) will be used.

The manually set ISO speed changes when switching to movie shooting.

- If you shoot a movie when [**Maximum: 51200**] is set with [**ISO speed range**] and ISO speed is set to ISO 32000/40000/51200, the ISO speed will switch to ISO 25600 (during movie shooting with manual exposure). Even if you switch back to still photo shooting, the ISO speed will not revert to the original setting.
- If you shoot a movie when L (ISO 50) is set, the ISO speed setting will switch to ISO 100 (during movie shooting with manual exposure). Even if you switch back to still photo shooting, the ISO speed will not revert to the original setting.

The exposure changes during movie shooting.

- If you change the shutter speed or aperture during movie shooting, the changes in the exposure may be recorded.
- Zooming the lens during movie shooting can cause changes in the exposure regardless of whether the lens' maximum aperture changes or not. Changes in the exposure may be recorded as a result.

The subject looks distorted during movie shooting.

- If you move the camera to the left or right quickly (high-speed panning) or shoot a moving subject, the image may look distorted.

The image flickers or horizontal stripes appear during movie shooting.

- Flickering, horizontal stripes (noise), or irregular exposures can be caused by fluorescent light, LED bulbs, or other light sources during movie shooting. Also, changes in the exposure (brightness) or color tone may also be recorded. In the <M> mode, a slow shutter speed may solve the problem.

When I shoot still photos during movie shooting, the movie shooting stops.

- To shoot still photos during movie shooting, using a CF card compatible with UDMA transfer rates is recommended.
- Setting a smaller image size for the still photos and shooting fewer continuous shots may resolve the problem.

The time code is off.

- Shooting still photos during movie shooting will cause a discrepancy between the actual time and time code. When you want to edit a movie using time code, it is recommended not to shoot still photos during movie shooting.

Operation Problems

I cannot change the setting with <>, <>, or <>.

- Set the power switch to <ON> (p.38).
- Check the [**9.5: Multi function lock**] setting (p.337).

Vertical-grip controls such as <> and <> do not work.

- Set the vertical-grip operation switch to <ON> (p.49).

The camera button/dial's function has changed.

- Check the [**9.5: Custom Controls**] setting (p.343).

Display Problems

The file name's first character is an underscore (“_”).

- Set the color space to sRGB. If Adobe RGB is set, the first character will be an underscore (p.168).

The fourth character in the file name changes.

- With [**9.1: File name**], select the camera's unique file name or the file name registered under User setting 1 (p.162).

The file numbering does not start from 0001.

- If the card already contains recorded images, the image number may not start from 0001 (p.164).

The shooting date and time displayed is incorrect.

- Make sure the correct date and time has been set (p.40).
- Check the time zone and daylight savings time (p.41).

The date and time is not in the picture.

- The shooting date and time does not appear in the picture. The date and time is instead recorded in the image data as shooting information. When printing, you can imprint the date and time in the picture by using the date and time recorded in the shooting information (p.40, 311).

[###] is displayed.

- If the card has recorded a number of images greater than the camera can display, [###] will be displayed (p.263).

In the viewfinder, the AF point display speed is slow.

- In low temperatures, the display speed of the AF points may become slower due to the AF point display device's (liquid crystal) characteristics. The display speed will return to normal at room temperature.

The LCD monitor does not display a clear image.

- If the LCD monitor is dirty, use a soft cloth to clean it.
- In low or high temperatures, the LCD monitor display may seem slow or may look black. It will return to normal at room temperature.

Playback Problems

Part of the image blinks in black.

- [▶3: Highlight alert] is set to [Enable] (p.255).

A red box is displayed on the image.

- [▶3: AF point disp.] is set to [Enable] (p.255).

The image cannot be erased.

- If the image is protected, it cannot be erased (p.279).

A voice memo cannot be played back.

- Set [⋮5: ⏪/🎤 button function] to [Play memo (Hold: Record memo)] (p.338).

The movie cannot be played back.

- Movies edited with a personal computer cannot be played with the camera.

When the movie is played back, camera operation noise can be heard.

- If you operate the camera's dials or lens during movie shooting, the operation noise will also be recorded. Using an external microphone (commercially available) is recommended (p.243).

The movie has still moments.

- During autoexposure movie shooting, if there is a drastic change in the exposure level, the recording will stop momentarily until the brightness stabilizes. If this happens, shoot in the <M> mode (p.231).

No image appears on the TV screen.

- Use the stereo AV cable that came with the camera (p.278).
- Make sure the stereo AV cable or HDMI cable's plug is inserted all the way in (p.275, 278).
- Set the video OUT system (NTSC/PAL) to the same video system as the TV set (p.278).

There are multiple movie files for a single movie shoot.

- If the movie file size reaches 4 GB, another movie file will be created automatically (p.240).

My card reader does not recognize the card.

- If you format a card of 128 GB or higher with this camera, it will be formatted in exFAT. This means that some card readers and computer operating systems might not recognize the card properly. In such a case, connect your camera to the computer with the provided interface cable, then transfer the images to your computer using EOS Utility (provided software, p.426).

I cannot process the RAW image.

- **M RAW** and **S RAW** images cannot be processed with the camera. Use the provided software Digital Photo Professional to process the image (p.426).

I cannot resize the image.

- The camera cannot resize the following images: JPEG **S**(Small), **RAW**, **M RAW**, and **S RAW** (p.297).

Sensor Cleaning Problems

The shutter makes a noise during sensor cleaning.

- If you selected [**Clean now** ], the shutter will make a noise, but no picture is taken (p.300).

Automatic sensor cleaning does not work.

- If you repeatedly turn the power switch <ON> and <OFF> at a short interval, the < > icon may not appear (p.38).

Printing-Related Problems

There are fewer printing effects than listed in the instruction manual.

- What is displayed on the screen differs depending on the printer. This instruction manual lists all the printing effects available (p.310).

Image Transfer Problems

I cannot transfer images to a personal computer.

- Install the provided software (EOS DIGITAL Solution Disk CD-ROM) on the personal computer (p.427).
- Check that EOS Utility's top screen appears.

MENU System Status Display

You can check the camera's serial number, firmware version, and shutter release cycles on the screen. You can also check the status log for past Error and Caution messages.

Use this function to check the camera's condition. If necessary, take the camera to your nearest Canon Service Center for maintenance to minimize camera problems in the future.

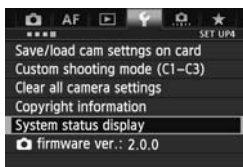

1 Select [System status display].

- Under the [F4] tab, select [System status display], then press <SET>.

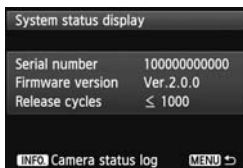

2 Check the system status.

- You can check the serial number, firmware version, and shutter release cycles.

Check the Error and Caution Log

You can check the camera's past errors, caution history, and the lens, flash, and battery used when the error or caution occurred.

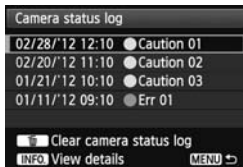

3 Check the log.

- In step 2, press the <INFO.> button.
 - ▶ The camera's status log will be displayed.
- "Err ***" is an error message. For the error messages, see page 401.
- "Caution ***" is a caution message. For the caution messages, see the next page.



4 Check the system status.

- Turn the <ⓘ> dial to select an Error or Caution, then press the <INFO.> button to view the message.
- Turn the <ⓘ> dial to check the message.

● Caution Messages

The camera checks its important components to see if they are operating properly. If it detects an operation that is inaccurate but not serious enough to be an error, it will be recorded as a Caution message in the Camera status log. Although you can continue shooting, you should follow the recommendations in the Caution message and solution since the condition may lead to a malfunction.

Caution No.	Message	Description and Solution
01	Shutter speed repeatedly adjusted automatically. You may continue shooting but contacting a service center is recommended.	If the camera detects an error in the shutter speed, it will make adjustments to maintain shutter speed precision. If this adjustment is made repeatedly, this Caution message will appear. You can continue shooting, but consulting a Canon Service Center is recommended.
02	A sudden drop in battery performance was detected. If this happens again after battery replacement, contact a service center.	While the camera is turned off, if the battery pack's remaining capacity decreases abnormally within a certain period, this Caution message will appear. If the same Caution message appears repeatedly even after changing to a different, fully-charged Battery Pack LP-E4N or LP-E4, there may be a problem with the camera. Consult your nearest Canon Service Center.
03	Retry operation was performed for the shutter charge mechanism. If this happens repeatedly, contacting a service center is recommended.	The shutter- and mirror-cocking operation was not completed normally. If this occurs again, this Caution message will appear. You can continue shooting, but if the same message appears again, you should consult your nearest Canon Service Center.

Erasing the Camera Status Log

When you press the <  > button in step 3, you can delete all the log entries displayed.

-  ● The Camera status log screen displays the latest five entries for Errors and Cautions. If there are more than five entries, the oldest entries will be deleted automatically.
- The shutter release cycles are displayed in units of 1000. If there have been 1,000,000 or more shutter release cycles, 1,000,000 will be displayed.
- If the same Error or Caution occurs often, consult a Canon Service Center.

Error Codes

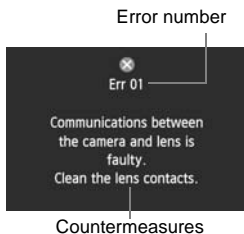

If there is a problem with the camera, an error message will appear. Follow the on-screen instructions.

Number	Error Message and Solution
01	Communications between the camera and lens is faulty. Clean the lens contacts.
	→ Clean the electrical contacts on the camera and lens or use a Canon lens (p.15, 18).
02	Card * cannot be accessed. Reinsert/change card * or format card * with camera.
	→ Remove and insert the card again, replace the card, or format the card (p.35, 55).
04	Cannot save images because card * is full. Replace card *.
	→ Replace the card, erase unnecessary images, or format the card (p.35, 55, 286).
06	Sensor cleaning is not possible. Turn the camera off and on again.
	→ Operate the power switch (p.38).
10, 20, 30, 40, 50, 60, 70, 80, 99	Shooting is not possible due to an error. Turn the camera off and on again or re-install the battery.
	→ Operate the power switch, remove and install the battery pack again, or use a Canon lens (p.34, 38).

* If the error still persists, write down the error number and contact your nearest Canon Service Center.

Specifications

• Type

Type:	Digital, single-lens reflex, AF/AE camera
Recording media:	Type I or II CF card, UDMA mode 7-compatible * Dual CF card slots
Image sensor size:	Approx. 36 x 24 mm
Compatible lenses:	Canon EF lenses (except EF-S and EF-M lenses) (35 mm-equivalent lens focal length will be as indicated on the lens)
Lens mount:	Canon EF mount

• Image Sensor

Type:	CMOS sensor
Effective pixels:	Approx. 18.10 megapixels
Aspect ratio:	3:2
Dust delete feature:	Auto, Manual, Dust Delete Data appending

• Recording System

Recording format:	Design rule for Camera File System (DCF) 2.0
Image type:	JPEG, RAW (14-bit Canon original), RAW+JPEG simultaneous recording enabled
Recorded pixels:	L (Large) : Approx. 17.90 megapixels (5184 x 3456) M1 (Medium 1): Approx. 14.20 megapixels (4608 x 3072) M2 (Medium 2): Approx. 8.00 megapixels (3456 x 2304) S (Small) : Approx. 4.50 megapixels (2592 x 1728) RAW : Approx. 17.90 megapixels (5184 x 3456) M-RAW : Approx. 10.10 megapixels (3888 x 2592) S-RAW : Approx. 4.50 megapixels (2592 x 1728)
JPEG quality:	10 levels
Recording function:	Standard, Auto switch card, Record separately, Record to multiple
Create/select a folder:	Possible
File name:	Preset code, User setting 1, User setting 2
File numbering:	Continuous, Auto reset, Manual reset

• Image Processing During Shooting

Picture Style:	Auto, Standard, Portrait, Landscape, Neutral, Faithful, Monochrome, User Def. 1 - 3
White balance:	Auto, Preset (Daylight, Shade, Cloudy, Tungsten light, White fluorescent light, Flash), Custom, Color temperature setting (Approx. 2500-10000K), Personal white balance (5 settings), White balance correction, and White balance bracketing possible * Flash color temperature information transmission enabled

Noise reduction:	Applicable to long exposures and high ISO speed shots
Automatic image brightness correction:	Auto Lighting Optimizer
Highlight tone priority:	Provided
Lens aberration correction:	Peripheral illumination correction, Chromatic aberration correction

• Viewfinder

Type:	Eye-level pentaprism
Coverage:	Vertical/Horizontal approx. 100% (with Eye point approx. 20 mm)
Magnification:	Approx. 0.76x (-1 m ⁻¹ with 50 mm lens at infinity)
Eye point:	Approx. 20 mm (from eyepiece lens center at -1 m ⁻¹)
Built-in dioptic adjustment:	Approx. -3.0 - +1.0 m ⁻¹ (dpt)
Eyepiece shutter:	Built-in
Focusing screen:	Ec-C V provided, interchangeable
AF status indicator:	Provided
Grid display:	Provided
Electronic level:	Horizontal: 1° increments, ±6° Vertical: 1° increments, ±4° * During horizontal shooting
Mirror:	Quick-return type
Depth-of-field preview:	Provided

• Autofocus

Type:	TTL secondary image-registration, phase detection
AF points:	61 points (Up to 41 cross-type points) * Number of available AF points and cross-type points vary depending on the lens.
Focusing brightness range:	EV -2 - 18 (with center f/2.8 AF point, at 23°C/73°F, One-Shot AF, ISO 100)
Focus modes:	One-Shot AF, AI Servo AF, Manual focusing (MF)
AF area selection modes:	Single-point Spot AF (manual selection), Single-point AF (manual selection), AF point expansion (manual selection: up, down, left, and right), AF point expansion (manual selection: surround), Zone AF (manual selection of zone), Auto selection of 61 AF points
AF point automatic selection conditions:	Depending on EOS iTR AF setting (AF using color and face detection information possible) * iTR: Intelligent Tracking and Recognition
AF Configuration tool:	Case 1 - 6

AI Servo AF characteristics:	Tracking sensitivity, Acceleration/deceleration tracking, AF point auto switching
AF fine adjustment:	AF Microadjustment (All lenses by same amount or Adjust by lens)
AF-assist beam:	Emitted by the EOS-dedicated external Speedlite

• Exposure Control

Metering modes:	Approx. 100,000-pixel RGB metering sensor and 252-zone TTL metering at max. aperture EOS iSA (Intelligent Subject Analysis) system <ul style="list-style-type: none">• Evaluative metering (linked to all AF points)• Partial metering (approx. 6.5% of viewfinder at center)• Spot metering (approx. 2.5% of viewfinder at center)• Center-weighted average metering
-----------------	---

Brightness metering range: EV 0 - 20 (at 23°C/73°F, ISO 100)

* Spot metering: EV 2 - 20

Exposure control:	Program AE, Shutter-priority AE, Aperture-priority AE, Manual exposure, Bulb exposure
ISO speed: (Recommended exposure index)	Auto ISO, manually settable within ISO 100 - 51200 (1/3-stop or whole-stop increments), and expandable to L (Equivalent to ISO 50), H1 (Equivalent to ISO 102400), H2 (Equivalent to ISO 204800)

ISO speed settings: ISO speed range, Auto ISO range, and Auto ISO minimum shutter speed settable

Exposure compensation:	Manual : ± 5 stops in 1/3- or 1/2-stop increments
	AEB : ± 3 stops in 1/3- or 1/2-stop increments (Can be combined with manual exposure compensation)

AE lock:	Auto : Applied in One-Shot AF mode with evaluative metering when focus is achieved
	Manual : By AE lock button

Standard exposure level adjustment: AE Microadjustment possible

• Multiple Exposures

Shooting method:	Function/control priority, Continuous shooting priority
Number of multiple exposures:	2 to 9 exposures
Multiple-exposure control:	Additive, Average, Bright, Dark

• Shutter

Type:	Electronically-controlled, focal-plane shutter
Shutter speeds:	1/8000 sec. to 30 sec., Bulb (Total shutter speed range. Available range varies by shooting mode.), X-sync at 1/250 sec.

• Drive System

Drive modes:	Single, High-speed continuous, Low-speed continuous, 10-sec. self-timer, 2-sec. self-timer, Silent single shooting, Super high-speed continuous
Continuous shooting speed:	Super high-speed continuous shooting: Max. approx. 14 shots/sec. High-speed continuous shooting: Max. approx. 12 shots/sec. Low-speed continuous shooting: Max. approx. 3 shots/sec. * When the ISO speed is set to 32000 or higher (if the camera's internal temperature is low, ISO 20000 or higher), the maximum continuous shooting speed will be approx. 10 fps.
Max. burst:	JPEG Large: Approx. 100 shots (approx. 180 shots) RAW: Approx. 35 shots (approx. 38 shots) RAW+JPEG Large: Approx. 17 shots (approx. 17 shots) * During high-speed continuous shooting * Figures are based on Canon's testing standards (ISO 100 and Standard Picture Style) and an 8 GB card. * Figures in parentheses apply to an UDMA mode 7, 128 GB card based on Canon's testing standards.

• External Speedlite

Compatible Speedlites:	EX-series Speedlites
Flash metering:	E-TTL II autoflash
Flash exposure compensation:	±3 stops in 1/3- or 1/2-stop increments
FE lock:	Provided
PC terminal:	Provided
Standard flash exposure level adjustment:	FE Microadjustment possible
External Speedlite control:	Provided * Compatible with radio wireless flash photography.

• Live View Shooting

Focus modes:	Live mode, Face detection Live mode (contrast detection), Quick mode (phase-difference detection), Manual focusing (approx. 5x / 10x magnification possible)
Focusing brightness range:	EV 1 - 20 (with contrast detection, at 23°C/73°F, ISO 100)
Metering modes:	Evaluative metering with the image sensor
Brightness metering range:	EV 0 - 20 (at 23°C/73°F, ISO 100)
Silent shooting:	Provided (Mode 1 and 2)
Grid display:	Three types

• Movie Shooting

Movie recording compression:	MPEG-4 AVC/H.264 Variable (average) bit rate
Audio recording format:	Linear PCM
Recording format:	MOV
Recording size and frame rate:	1920x1080 (Full HD): 30p/25p/24p 1280x720 (HD) : 60p/50p 640x480 (SD) : 30p/25p * 30p: 29.97 fps, 25p: 25.00 fps, 24p: 23.976 fps, 60p: 59.94 fps, 50p: 50.00 fps
Compression method:	ALL-I (I-only), IPB
File size:	1920x1080 (30p/25p/24p) / IPB : Approx. 235 MB/min. 1920x1080 (30p/25p/24p) / ALL-I : Approx. 685 MB/min. 1280x720 (60p/50p) / IPB : Approx. 205 MB/min. 1280x720 (60p/50p) / ALL-I : Approx. 610 MB/min. 640x480 (30p/25p) / IPB : Approx. 78 MB/min. * Card reading/writing speed necessary for movie shooting: IPB: at least 10 MB per sec./ALL-I: at least 30 MB per sec.
Focus modes:	Same as focusing with Live View shooting
Metering modes:	Center-weighted average and Evaluative metering with the image sensor * Automatically set by the focusing mode.
Brightness metering range:	EV 0 - 20 (at 23°C/73°F, ISO 100)
Exposure control:	1. Autoexposure, 2. Shutter-priority AE, 3. Aperture-priority AE, 4. Manual exposure
Exposure compensation:	1/3- or 1/2- stop increments, ±3 stops (±5 stops for still photos)
ISO speed: (Recommended exposure index)	P, Av, and BULB: ISO 100 - 25600 set automatically, or ISO expansion to H (equivalent to ISO 51200), H1 (equivalent to ISO 102400), H2 (equivalent to ISO 204800) Tv: ISO 100 - 25600 set automatically M : Auto ISO (ISO 100 - 25600 set automatically), ISO 100 - 25600 set manually (in 1/3- or whole-stop increments), or ISO expansion to H (equivalent to ISO 32000/40000/51200), H1 (equivalent to ISO 102400), H2 (equivalent to ISO 204800)
Time code:	Supported
Drop frames:	Compatible with 60p/30p

Sound recording:	Built-in monaural microphone, external stereo microphone terminal provided Sound recording level adjustable, wind filter provided
Grid display:	Three types
Still photo shooting:	Possible

• LCD Monitor

Type:	TFT color, liquid-crystal monitor
Monitor size and dots:	Wide, 8.1 cm (3.2-in.) (3:2) with approx. 1.04 million dots
Brightness adjustment:	Manual (7 levels)
Electronic level:	Provided
Interface languages:	25
Feature guide:	Displayable
Camera system status display:	Provided

• Playback

Image display formats:	Single-image display, Single-image + Info display (Basic info, shooting info, histogram), 4-image index, 9-image index display
Highlight alert:	Overexposed highlights blink
AF point display:	Possible
Grid display:	Three types
Zoom magnification:	Approx. 1.5x - 10x, starting magnification and position settable
Image browsing methods:	Single image, jump by 10 or 100 images, by shooting date, by folder, by movies, by stills, by protect, by rating
Image rotate:	Possible
Ratings:	Provided
Movie playback:	Enabled (LCD monitor, video/audio OUT, HDMI OUT) Built-in speaker
Slide show:	All images, by date, by folder, movies, stills, by protect, or by rating
Image protect:	Possible
Voice memo:	Recording/playback possible
Copying images:	Possible

• Post-Processing of Images

In-camera RAW image processing:	Brightness correction, White balance, Picture Style, Auto Lighting Optimizer, High ISO speed noise reduction, JPEG image-recording quality, Color space, Peripheral illumination correction, Distortion correction, and Chromatic aberration correction
Resize:	Possible

• Direct Printing

Compatible printers:	PictBridge-compatible printers
Printable images:	JPEG and RAW images
Print ordering:	DPOF Version 1.1 compatible

• Wired LAN

Ethernet:	10BASE-T, 100BASE-TX, 1000BASE-T
FTP transfer:	Automatic transfer upon shooting, Image selection/transfer, Transfer with SET button, Transfer with caption
EOS Utility:	EOS Utility's remote control works with wired LAN
WFT server:	Camera control, simple control, basic shooting, image viewing, and downloading
Media server:	DLNA-compatible
Multi camera time sync function:	Master camera can synchronize time with up to 10 slave cameras Time error of approx. ± 0.05 sec. between master and slave cameras

• Image Transfer

Transferrable images:	Still photos (JPEG, RAW, RAW+JPEG images), Movies
-----------------------	---

• Custom Functions

Custom Functions:	32
Save camera settings:	Up to ten sets can be registered in a card
Custom shooting modes:	Register under C1/C2/C3
My Menu registration:	Possible
Copyright information:	Entry and inclusion enabled

• Interface

Audio/video OUT/	Analog video (Compatible with NTSC/PAL)/stereo audio output
Digital terminal:	
HDMI mini OUT terminal:	Personal computer communication, Direct printing (Hi-Speed USB or equivalent), GPS Receiver GP-E2 connection
External microphone	Type C (Auto switching of resolution), CEC-compatible
IN terminal:	3.5 mm stereo mini-jack
Remote control terminal:	Compatible with N3-type remote controller
Ethernet terminal:	RJ-45 terminal, gigabit Ethernet compatible
System extension terminal:	For Wireless File Transmitter WFT-E6 and GPS Receiver GP-E1

• Power

Battery:	Battery Pack LP-E4N/LP-E4 (Quantity 1) * AC power can be supplied via AC Adapter Kit ACK-E4
Battery information:	Remaining capacity, Shutter count, and Recharge performance displayed
Battery life:	With viewfinder shooting: Approx. 1120 shots at 23°C/73°F, approx. 860 shots at 0°C/32°F
(Based on CIPA testing standards)	With Live View shooting: Approx. 290 shots at 23°C/73°F, approx. 250 shots at 0°C/32°F
Movie shooting time:	Approx. 2 hr. 10 min. at 23°C/73°F Approx. 2 hr. at 0°C/32°F * With a fully-charged Battery Pack LP-E4N
Date/Time battery:	CR2025 lithium battery (Quantity 1)

• Dimensions and Weight

Dimensions (W x H x D):	Approx. 158.0 x 163.6 x 82.7 mm / 6.2 x 6.4 x 3.3 in.
Weight:	Approx. 1530 g / 54.0 oz. (CIPA Guidelines), Approx. 1340 g / 47.3 oz. (Body only)

• Operation Environment

Working temperature range:	0°C - 45°C / 32°F - 113°F
Working humidity:	85% or less

• Battery Pack LP-E4N

Type:	Rechargeable lithium-ion battery
Rated voltage:	11.1 V DC
Battery capacity:	2450 mAh
Dimensions (W x H x D):	Approx. 68.4 x 34.2 x 92.8 mm / 2.7 x 1.3 x 3.7 in.
Weight:	Approx. 185 g / 6.5 oz. (excluding protective cover)

• Battery Charger LC-E4N

Compatible battery packs:	Battery Pack LP-E4N, LP-E4
Recharging time:	LP-E4N: Approx. 130 min. (for 1 pack), LP-E4: Approx. 120 min. (for 1 pack)
Rated input:	100 - 240 V AC (50/60 Hz) 12 V / 24 V DC
Rated output:	12.6 V DC, 1.55 A
Power cord length:	Approx. 2 m / 6.6 ft.
Working temperature range:	0°C - 40°C / 32°F - 104°F
Working humidity:	85% or less
Dimensions (W x H x D):	Approx. 155 x 52.8 x 95 mm / 6.2 x 2.1 x 3.7 in.
Weight:	Approx. 350 g / 12.3 oz. (excluding power cord and protective covers)

- All the data above is based on Canon's testing standards and CIPA (Camera & Imaging Products Association) testing standards and guidelines.
- Dimensions, maximum diameter, length and weight listed above are based on CIPA Guidelines (except weight for camera body only).
- Product specifications and the exterior are subject to change without notice.
- If a problem occurs with a non-Canon lens attached to the camera, consult the respective lens maker.

Trademarks

- Adobe is a trademark of Adobe Systems Incorporated.
- Microsoft and Windows are trademarks or registered trademarks of Microsoft Corporation in the United States and/or other countries.
- Macintosh and Mac OS are trademarks of Apple Inc., registered in the U.S. and other countries.
- CompactFlash is a trademark of SanDisk Corporation.
- HDMI, HDMI logo, and High-Definition Multimedia Interface are trademarks or registered trademarks of HDMI Licensing LLC.
- All other trademarks are the property of their respective owners.

About MPEG-4 Licensing

“This product is licensed under AT&T patents for the MPEG-4 standard and may be used for encoding MPEG-4 compliant video and/or decoding MPEG-4 compliant video that was encoded only (1) for a personal and non-commercial purpose or (2) by a video provider licensed under the AT&T patents to provide MPEG-4 compliant video. No license is granted or implied for any other use for MPEG-4 standard.”

* Notice displayed in English as required.

Use of genuine Canon accessories is recommended

This product is designed to achieve excellent performance when used with genuine Canon accessories. Canon shall not be liable for any damage to this product and/or accidents such as fire, etc., caused by the malfunction of non-genuine Canon accessories (e.g., a leakage and/or explosion of a battery pack). Please note that this warranty does not apply to repairs arising out of the malfunction of non-genuine Canon accessories, although you may request such repairs on a chargeable basis.

-  Battery Pack LP-E4N is designed for Canon products only. Using it with an incompatible battery charger or product may result in malfunction or accidents for which Canon cannot be held liable.

Safety Warnings

Follow these safeguards and use the equipment properly to prevent injury, death, and material damage.

Preventing Serious Injury or Death

- To prevent fire, excessive heat, chemical leakage, and explosions, follow the safeguards below:
 - Do not use any batteries, power sources, and accessories not specified in this booklet. Do not use any home-made or modified batteries.
 - Do not short-circuit, disassemble, or modify the battery pack or back-up battery. Do not apply heat or apply solder to the battery pack or back-up battery. Do not expose the battery pack or back-up battery to fire or water. And do not subject the battery pack or back-up battery to strong physical shock.
 - Do not install the battery pack or back-up battery in reversed polarity (+ -). Do not mix new and old or different types of batteries.
 - Do not recharge the battery pack outside the allowable ambient temperature range of 0°C - 40°C (32°F - 104°F). Also, do not exceed the recharging time.
 - Do not insert any foreign metallic objects into the electrical contacts of the camera, accessories, connecting cables, etc.
- Keep the back-up battery away from children. If a child swallows the battery, consult a physician immediately. (Battery chemicals may harm the stomach and intestines.)
- When disposing of a battery pack or back-up battery, insulate the electrical contacts with tape to prevent contact with other metallic objects or batteries. This is to prevent fire or an explosion.
- If excessive heat, smoke, or fumes are emitted during battery pack recharging, immediately unplug the battery charger from the power outlet to stop the recharging and prevent a fire.
- If the battery pack or back-up battery leaks, changes color, deforms, or emits smoke or fumes, remove it immediately. Be careful not to get burned in the process.
- Prevent any battery leakage from contacting your eyes, skin, and clothing. It can cause blindness or skin problems. If the battery leakage contacts your eyes, skin, or clothing, flush the affected area with lots of clean water without rubbing it. See a physician immediately.
- During the recharging, keep the equipment away from the reach of children. The cord can accidentally choke the child or give an electrical shock.
- Do not leave any cords near a heat source. It can deform the cord or melt the insulation and cause a fire or electrical shock.
- Do not fire the flash at someone driving a car. It may cause an accident.
- Do not fire the flash near a person's eyes. It may impair the person's vision. When using flash to photograph an infant, keep at least 1 meter away.
- Before storing the camera or accessory when not in use, remove the battery pack and disconnect the power plug. This is to prevent electrical shock, heat generation, and fire.
- Do not use the equipment where there is flammable gas. This is to prevent an explosion or fire.

-
- If you drop the equipment and the casing breaks open to expose the internal parts, do not touch the internal parts due to the possibility of electrical shock.
 - Do not disassemble or modify the equipment. High-voltage internal parts can cause electrical shock.
 - Do not look at the sun or an extremely bright light source through the camera or lens. Doing so may damage your vision.
 - Keep the camera from the reach of small children. The neck strap can accidentally choke the child.
 - Do not store the equipment in dusty or humid places. This is to prevent fire and electrical shock.
 - Before using the camera inside an airplane or hospital, check if it is allowed. Electromagnetic waves emitted by the camera may interfere with the plane's instruments or the hospital's medical equipment.
 - To prevent fire and electrical shock, follow the safeguards below:
 - Always insert the power plug all the way in.
 - Do not handle a power plug with wet hands.
 - When unplugging a power plug, grasp and pull the plug instead of the cord.
 - Do not scratch, cut, or excessively bend the cord or put a heavy object on the cord. Also do not twist or tie the cords.
 - Do not connect too many power plugs to the same power outlet.
 - Do not use a cord whose insulation has been damaged.
 - Occasionally unplug the power plug and use a dry cloth to clean off the dust around the power outlet. If the surrounding is dusty, humid, or oily, the dust on the power outlet may become moist and short-circuit the outlet to cause a fire.
-

Preventing Injury or Equipment Damage

- Do not leave equipment inside a car under the hot sun or near a heat source. The equipment may become hot and cause skin burns.
 - Do not carry the camera around while it is attached to a tripod. Doing so may cause injury. Also make sure the tripod is sturdy enough to support the camera and lens.
 - Do not leave a lens or lens-attached camera under the sun without the lens cap attached. Otherwise, the lens may concentrate the sun's rays and cause a fire.
 - Do not cover or wrap the battery-recharging apparatus with a cloth. Doing so may trap heat within and cause the casing to deform or catch fire.
 - If you drop the camera in water or if water or metal fragments enter inside the camera, promptly remove the battery pack and back-up battery. This is to prevent fire and electrical shock.
 - Do not use or leave the battery pack or back-up battery in a hot environment. Doing so may cause battery leakage or a shorter battery life. The battery pack or back-up battery can also become hot and cause skin burns.
 - Do not use paint thinner, benzene, or other organic solvents to clean the equipment. Doing so may cause fire or a health hazard.
-

If the product does not work properly or requires repair, contact your dealer or your nearest Canon Service Center.

Digital Camera Model DS126301 Systems

This device complies with Part 15 of the FCC Rules. Operation is subject to the following two conditions: (1) This device may not cause harmful interference, and (2) this device must accept any interference received, including interference that may cause undesired operation.

Note: This equipment has been tested and found to comply with the limits for class B digital devices, pursuant to Part 15 of the FCC Rules. These limits are designed to provide reasonable protection against harmful interference in a residential installation. This equipment generates, uses and can radiate radio frequency energy and, if not installed and used in accordance with the instructions, may cause harmful interference to radio communications. However, there is no guarantee that interference will not occur in a particular installation. If this equipment does cause harmful interference to radio or television reception, which can be determined by turning the equipment off and on, the user is encouraged to try to correct the interference by one or more of the following measures:

- Reorient or relocate the receiving antenna.
- Increase the separation between the equipment and receiver.
- Connect the equipment into an outlet on a circuit different from that to which the receiver is connected.
- Consult the dealer or an experienced radio/TV technician for help.

The cable with the ferrite core provided with the digital camera must be used with this equipment in order to comply with Class B limits in Subpart B of Part 15 of the FCC rules.

Do not make any changes or modifications to the equipment unless otherwise specified in the manual. If such changes or modifications should be made, you could be required to stop operation of the equipment.

Canon U.S.A. Inc.
One Canon Park, Melville, NY 11747, U.S.A.
Tel No. 1-800-OK-CANON (1-800-652-2666)

CAN ICES-3 (B) / NMB-3 (B)



When connecting to and using a household power outlet, use only AC Adapter Kit ACK-E4 (rated input: 100-240 V AC 50/60 Hz, rated output: 12.6 V DC). Using anything else can cause fire, overheating, or electrical shock.

IMPORTANT SAFETY INSTRUCTIONS

1. **SAVE THESE INSTRUCTIONS** — This manual contains important safety and operating instructions for Battery Charger LC-E4N.
2. Before using the charger, read all instructions and cautionary remarks on (1) the charger, (2) the battery pack, and (3) the product using the battery pack.
3. **CAUTION** — To reduce risk of injury, charge only the Battery Pack LP-E4N. Other types of batteries may burst, causing personal injury and other damage.
4. Do not expose the charger to rain or snow.
5. Use of an attachment not recommended or sold by Canon may result in fire, electric shock, or personal injury.
6. To reduce risk of damage to electric plug and cord, pull by plug rather than by cord when disconnecting charger.
7. Make sure cord is located so that it will not be stepped on, tripped over, or otherwise subjected to damage or stress.
8. Do not operate the charger with damaged cord or plug - replace them immediately.
9. Do not operate the charger if it has received a sharp blow, been dropped, or otherwise damaged in any way; take it to a qualified serviceman.
10. Do not disassemble the charger; take it to a qualified serviceman when service or repair is required. Incorrect reassembly may result in a risk of electric shock or fire.
11. To reduce risk of electric shock, unplug charger from outlet before attempting any maintenance or cleaning.

MAINTENANCE INSTRUCTION

Unless otherwise stated in this manual, there are no user serviceable parts inside. Refer servicing to qualified serviceman.



USA and Canada only:

The Lithium ion/polymer battery that powers the product is recyclable. Please call 1-800-8-BATTERY for information on how to recycle this battery.

For CA, USA only

Included lithium battery contains Perchlorate Material – special handling may apply. See www.dtsc.ca.gov/hazardouswaste/perchlorate/ for details.

CAUTION

RISK OF EXPLOSION IF BATTERY IS REPLACED BY AN INCORRECT TYPE.
DISPOSE OF USED BATTERIES ACCORDING TO LOCAL REGULATION.

14

Software Start Guide

This chapter gives an overview of the software in the EOS DIGITAL Solution Disk (CD-ROM) provided with the camera and explains how to install the software on a personal computer. It also explains how to view the PDF files on the Software Instruction Manual CD-ROM.



EOS DIGITAL Solution Disk
(Software)



Software Instruction Manual

Software Start Guide



EOS DIGITAL Solution Disk

This disk contains various software for EOS DIGITAL cameras.

EOS Utility

With the camera connected to a personal computer, EOS Utility enables you to transfer still photos and movies shot with the camera to the computer. You can also use the personal computer to set various camera settings and shoot remotely with the computer connected to the camera.

Digital Photo Professional

This software is recommended for users who mainly shoot RAW images. You can quickly view, edit, process, and print RAW images. You can also edit JPEG images while retaining the original images.

Picture Style Editor

You can edit Picture Styles and create and save original Picture Style files. This software is aimed at advanced users who are experienced in processing images.

ImageBrowser EX

Connect to the Internet to download and install the software.*

This software is recommended for users who mainly shoot JPEG images. You can easily view and play back still photos and MOV movies, and also edit and print JPEG images.

* EOS DIGITAL Solution Disk is necessary for downloading and installing ImageBrowser EX.



Note that the software ZoomBrowser EX/ImageBrowser provided with previous cameras does not support still photos and movie files shot with this camera (it is not compatible). Use ImageBrowser EX.

Installing the Software



- **Do not connect the camera to your computer before you install the software. The software will not be installed correctly.**
- When downloading and installing ImageBrowser EX, follow the steps below as with other EOS software included on the EOS DIGITAL Solution Disk. Note that Internet connection is necessary. Downloading or installing software is not possible in environments with no Internet connection.
- Even if your computer already has ImageBrowser EX installed, follow the steps below to reinstall ImageBrowser EX. It will be updated to the latest version with features optimized for your camera. Also, the latest functions may be added with the auto update feature.
- For software other than ImageBrowser EX, if a previous version is installed, follow the steps below to reinstall the software. (The newer version will overwrite the previous version.)

1 Insert EOS DIGITAL Solution Disk (CD-ROM).

- For Macintosh, double-click to open the CD-ROM icon displayed on the desktop, then double-click on [**Canon EOS Digital Installer**].

2 Click [**Easy Installation**] and follow the on-screen instructions to install.

- For Macintosh, click [**Install**].
- If the “Microsoft Silverlight” installation prompt is displayed during installation, install “Microsoft Silverlight”.

3 Click [**Restart**] and remove the CD-ROM after the computer restarts.

- When the computer has restarted, the installation is complete.



Software Instruction Manual

Contains the Software Instruction Manuals.

Copying and Viewing the Instruction Manual PDFs

- 1** Insert the [Software INSTRUCTION MANUAL] CD-ROM into your computer.
- 2** Double-click the CD-ROM icon.
 - For Windows, the icon is displayed in [(My) Computer].
 - For Macintosh, the icon is displayed on the desktop.
- 3** Copy the [English] folder to your computer.
 - Instruction Manual PDFs with the names below are copied.

	Windows	Macintosh
EOS Utility	EUx.xW_E_xx	EUx.xM_E_xx
Digital Photo Professional	DPPx.xW_E_xx	DPPx.xM_E_xx
Picture Style Editor	PSEx.xW_E_xx	PSEx.xM_E_xx

- Instruction manual for ImageBrowser EX (ImageBrowser EX User Guide) is included in the software.
- 4** Double-click the copied PDF file.
 - Adobe Reader (most recent version recommended) must be installed on your computer.
 - Adobe Reader can be downloaded free from the Internet.

Index

Numerics

10-sec. or 2-sec. delay.....	117
1280x720	239
1920x1080	239
4- or 9-image index display.....	257
61-point automatic selection	
AF	70, 75
640x480	239

A

AC Adapter Kit	373
Access lamp.....	21, 37
Adobe RGB.....	168
AE lock.....	183
AE Microadjustment.....	332
AEB.....	182, 326, 327
AF	
AF area selection mode.....	69, 73
AF group.....	77
AF Microadjustment.....	107, 112
AF mode	66
AF point	69, 71, 73
AF point selection.....	71, 351, 371
AF status indicator.....	68
AF-assist beam.....	96
Beeper	376
Color information	97
Customization.....	94
Difficult-to-focus subjects..	113, 219
f/8.....	83
Facial information	97
Manual focusing	114, 222
Out of focus	45, 46, 113, 219
Recompose	67
AF area selection mode.....	69, 73
AF Configuration Tool	85
AF point expansion	69, 73

AF-ON (AF start) button	46
AI SERVO (AI Servo AF).....	68
Accel./decel. tracking.....	91
AF pt auto switching.....	92
AF starting point.....	103
Illumination	105
Tracking sensitivity.....	90
ALL-I (I-only).....	239
Aperture-priority AE.....	175, 229
Area AF	69
Audio/video OUT (AV OUT) ..	266, 275
Auto Lighting Optimizer	152
Auto playback.....	272
Auto power off	38, 57
Auto reset	165
Auto rotate	289
Auto switch card	121
Autofocus → AF	
Automatic selection (AF)	70, 75
Automatic selection of	
AF point.....	70, 75
Av (Aperture-priority AE)	175, 229

B

BULB	184
B/W.....	136, 140
Battery	30, 34, 39
Beeper.....	376
Black-and-white image.....	136, 140
Bracketing	151, 182
Bulb exposures.....	184

C

C (Custom shooting)	361
Cable	3, 275, 278, 368
Cable protector.....	365

Calibration.....	32
Camera	
Camera shake	193
Clear camera settings	58
Holding the camera	45
Save/load camera settings	358
Settings display	370
System status	398
Camera shake	45, 46
Caption (name)	147
Card	15, 35, 55
Card reminder	36
Format	55
Problem	37, 56
Center-weighted average metering	179
CF card → Card	
Charger	28, 30
Chromatic aberration correction ...	158
Cleaning.....	299
Clear camera settings.....	58
Color space.....	168
Color temperature.....	143, 149
Color tone	139
Compression rate	129
Continuous.....	164
Continuous shooting.....	115
Contrast	139
Copyright information.....	166
Cropping information	339
Cross-type focusing.....	76
Custom Controls	52, 343
Custom Functions.....	324
Custom shooting modes.....	361
Custom WB.....	144

D

Date/Time.....	40
Date/time battery replacement	374
Daylight saving time	41
DC coupler	373
Depth-of-field preview ..	176, 207, 210
Dial	
Main Dial.....	47
Quick Control Dial.....	48
Digital terminal	306, 319
Dioptic adjustment	45
Direct printing.....	305, 306, 318
Direct selection (AF point).....	351
DPOF	315
Drive mode.....	115
Dust Delete Data.....	301

E

Electronic level	61, 62, 355
Erase (image).....	286
Error codes.....	401
Ethernet → Separate booklet	
Evaluative metering.....	179
exFAT	56
Exposure compensation.....	178, 181
Exposure level increments	326
Exposure level indicator	22, 25
Exposure retaining	341
Exposure simulation.....	213
Extension	163
External Speedlite → Flash	
Eyecup	45
Eyepiece shutter	185

F

FE lock.....	196
FE Microadjustment.....	332
Feature guide.....	63
File name.....	162, 164
File size.....	126, 240, 254, 255
Filter effect.....	140
Final image simulation.....	210, 235
Firmware Ver.....	382
First-curtain synchronization.....	202
Flash (Speedlite)	
Custom Functions.....	204
External Speedlite.....	196
FE lock.....	196
Flash control.....	199
Flash exposure compensation..	196
Flash-sync speed.....	197
Manual flash.....	197, 201
Shutter synchronization (1st/2nd curtain).....	202
Wireless.....	202
Flash exposure bracketing.....	203
Flash exposure compensation.....	196
Flash mode.....	201
Flash-sync contacts.....	19
Focus confirmation light.....	67
Focus lock.....	67
Focus mode switch.....	43, 114, 222
Focusing → AF	
Folder Create/Select.....	160
Format (card initialization).....	55
Frame rate.....	239
Full HD.....	239, 241
Full High-Definition (Full HD).....	239, 266, 275

G

Grid display.....	61, 212, 247
-------------------	--------------

H

HD.....	239, 275
HDMI.....	266, 275
HDMI CEC.....	276
High ISO speed NR.....	153
High-Definition (HD).....	239, 266, 275
Highlight alert.....	255
Highlight detail loss.....	255
Highlight tone priority.....	156
Histogram (Brightness/RGB).....	256
Hot shoe.....	19, 198
Household power.....	373

I

ICC profile.....	168
Illumination (LCD panel).....	50
Image	
AF point display.....	255
Auto playback.....	272
Auto rotate.....	289
Copying.....	283
Erase.....	286
Highlight alert.....	255
Histogram.....	256
Image playback.....	251
Index.....	257
Jump display (Image browsing)	258
Magnified view.....	259
Manual rotate.....	261
No.....	164
Playback.....	251
Protect.....	279
Rating.....	262
Shooting information.....	254
Size.....	124

Slide show	272
Transfer	319
View on TV	266, 275
Voice memo.....	281
Image dust prevention	299
Image review	57
Image-recording quality	
Image size	123
JPEG quality.....	129
Index display.....	257
INFO. button	209, 233, 252, 370
IPB	239
ISO speed.....	130, 230, 232
Automatic setting (Auto)	131
Automatic setting range.....	133
ISO expansion.....	132
Minimum shutter speed	134
Setting increments.....	326
Setting range.....	132, 133

J

JPEG	123
JPEG quality (Compression rate)	129
Jump display.....	258

L

LAN → Separate booklet	
Language.....	42
Large (Image-recording quality).....	127
LCD monitor.....	15, 19
Brightness adjustment.....	288
Electronic level	62
Image Playback	251
Menu display	53, 375
Shooting settings display.....	371
LCD panel	
Rear.....	26
Top.....	24

Lens	43
Chromatic aberration	
correction	158
Lock release	44
Peripheral illumination	
correction	157
Live View shooting	205
Exposure simulation	213
Face detection Live mode (AF)..	216
Grid display	212
Information display.....	209
Live mode (AF)	215
Manual focusing.....	222
Metering timer.....	214
Possible shots.....	208
Quick Control	211
Quick mode (AF).....	220
Silent shooting	214
LOCK	50
Long exposure noise reduction	154
Long exposures.....	184

M

M (Manual exposure)	177, 231
Magnification/Start position	260
Magnified view	222, 259
Main Dial	47
Malfunction.....	384
Manual exposure.....	177, 231
Manual focusing	114, 222
Manual reset	165
Manual selection (AF)	69, 71, 73
Maximum aperture	83
Maximum burst.....	126, 128
Medium	
(Image-recording quality)	123, 297
Memory card → Card	

- Menu 53
 - My Menu 357
 - Setting procedure 54
 - Settings 375
 - MENU** icon 4
 - Metered manual flash 198
 - Metering mode 179
 - Metering timer 214, 248
 - MF (Manual focusing) 114, 222
 - M-Fn 70, 227
 - M-Fn 2 18, 345
 - Microadjustment 107, 332
 - Microphone 227, 243, 281
 - Mirror lockup 193
 - Monochrome image 136, 140
 - Movie 225
 - AE lock 230
 - AF mode 238, 247
 - Aperture-priority AE 229
 - Autoexposure shooting 227
 - Compression method 239
 - Drop frame 246
 - Edit 270
 - Editing out first and last scenes 270
 - Enjoying 266
 - External microphone 243
 - File size 240, 255
 - Frame rate 239
 - Grid display 247
 - Information display 233
 - Manual exposure shooting 231
 - Metering timer 248
 - Microphone 227, 243
 - Movie recording size 239
 - Movie shooting button 226, 248
 - Playback 268
 - Quick Control 238
 - Recording time 240
 - Shutter-priority AE 228
 - Silent control 244
 - Silent LV shooting 248
 - Sound recording 242
 - Still photos 236
 - Time code 245
 - View on TV 266, 275
 - Wind filter 242
 - M-RAW (Medium RAW) 123, 127
 - Multi-controller 49
 - Multi-function 18, 19
 - Multi function lock 50
 - Multiple exposures 186
 - Multi-spot metering 180
 - My Menu 357
- N**
- Noise reduction
 - High ISO speed 153
 - Long exposures 154
 - Nomenclature 18
 - Non-Canon flash units 197
 - NTSC 239, 381
 - Number of AF points 77
- O**
- ONE SHOT (One-Shot AF) 67
 - One-touch image quality setting... 128
- P**
- P (Program AE) 170
 - PAL 239, 381
 - Partial metering 179
 - PC terminal 197
 - Peripheral illumination correction 157
 - Personal white balance 143

- PictBridge 305
- Picture Style..... 135, 138, 141
- Pixels 124
- Playback..... 251
- Possible shots..... 39, 126, 208
- Power
- Auto power off 57
 - Battery check..... 39
 - Battery info 372
 - Household power 373
 - Possible shots 39, 126, 208
 - Recharge..... 30
 - Recharge performance..... 372
- Pressing completely..... 46
- Pressing halfway..... 46
- Printing..... 305
- Layout..... 309
 - Paper settings 309
 - Print Order (DPOF) 315
 - Printing effects..... 310
 - Tilt correction 313
 - Trimming..... 313
- Program AE 170
- Program shift 171
- Protect (image erase-protection) .. 279
- Q**
- Q** 51, 211, 238, 264
- Quick Control 51, 211, 238, 264
- Quick Control Dial..... 48
- Quick mode (AF)..... 220
- R**
- Rating 262
- Rating mark 262
- RAW 123, 127
- RAW image processing 292
- RAW+JPEG 123
- Rear LCD panel 26
- Rec. separately 121
- Rec. to multiple 121
- Recharge..... 30
- Record function 120
- Recording level 242
- Reduced display..... 259
- Registering and using an
AF point..... 348
- Release shutter without card..... 36
- Remote control terminal 185
- Remote switch..... 185
- Resize 297
- Rotate (image) 261, 289, 313
- S**
- Safety shift 329
- Safety warnings..... 413
- Saturation..... 139
- Second-curtain synchronization ... 202
- Self-timer 117
- Sensor cleaning 299
- Sepia (Monochrome)..... 140
- Sharpness 139
- Shooting information display 254
- Shooting mode 24
- Av (Aperture-priority AE)..... 175
 - BULB 184
 - C (Custom shooting)..... 361
 - M (Manual exposure)..... 177
 - P (Program AE) 170
 - Tv (Shutter-priority AE) 173
- Shooting mode's settable
functions..... 366
- Shooting orientation registration .. 101

- Shooting settings display50, 371
- Shutter button46
- Shutter synchronization202
- Shutter-priority AE.....173, 228
- Silent shooting
- Silent LV shooting.....214, 248
 - Single silent shooting.....116
- Single-image display.....252
- Single shooting115
- Single-point AF69, 73
- Single-point Spot AF69, 73
- Slide show.....272
- Small (Image size)123
- Software.....425
- Speaker.....268
- Spot AF point69, 73
- Spot metering.....179
- S-RAW (Small RAW)123, 127
- sRGB168
- Stopped-down aperture.....176, 207, 210
- Strap29
- Super high speed continuous shooting116
- System extension terminal.....21
- System map368
- T**
- Temperature warning223, 249
- Time code245
- Tone priority156
- Toning effect (Monochrome)140
- Top LCD panel24
- Touch pad48, 244
- Trimming (printing).....313
- Tripod socket.....18
- Tv (Shutter-priority AE).....173, 228
- U**
- Ultra DMA (UDMA).....36
- USB (Digital) terminal.....306, 319
- V**
- Vertical-grip ON/OFF switch.....49
- Video system.....239, 278, 381
- View on TV266, 275
- Viewfinder.....22
- Dioptic adjustment45
 - Electronic level.....61, 62, 355
 - Grid display61
- Voice memo
- Playback282
 - Recording.....281
- Volume (Movie playback)269
- W**
- Warning icon255
- White balance (WB)143
- Bracketing151
 - Color temperature setting149
 - Correction150
 - Custom.....144
 - Personal.....143
- Wind filter242
- Wired LAN → Separate booklet
- Z**
- Zone40
- Zone AF.....70

Canon

The lenses and accessories mentioned in this Instruction Manual are current as of November 2013. For information on the camera's compatibility with any lenses and accessories introduced after this date, contact any Canon Service Center.