

# PENTAX



SLR Digital Camera

# *K200D*

---

## Operating Manual



For optimum camera performance, please read the Operating Manual before using the camera.

Thank you for purchasing this PENTAX **K200D** Digital Camera. Please read this manual before using the camera in order to get the most out of all the features and functions. Keep this manual safe, as it can be a valuable tool in helping you to understand all the camera capabilities.

### **Lenses you can use**

In general, lenses that can be used with this camera are DA, D FA and FA J lenses and lenses that have an Aperture **A** (Auto) position.

To use any other lens or accessory, see p.45 and p.230.

### **Regarding copyrights**

Images taken using the **K200D** that are for anything other than personal enjoyment cannot be used without permission according to the rights as specified in the Copyright Act. Please take care, as there are cases where limitations are placed on taking pictures even for personal enjoyment during demonstrations, performances or of items on display. Images taken with the purpose of obtaining copyrights also cannot be used outside the scope of use of the copyright as laid out in the Copyright Act, and care should be taken here also.

### **Regarding trademarks**

PENTAX and smc PENTAX are trademarks of PENTAX Corporation.

  SD logo and SDHC logo are trademarks.

This product includes DNG technology under license by Adobe Systems Incorporated.

 The DNG logo is either a registered trademark or trademark of Adobe Systems Incorporated in the United States and/or other countries.

All other brands or product names are trademarks or registered trademarks of their respective companies.

### **To users of this camera**

- There is a possibility that recorded data may be erased or that the camera may not function correctly when used in surroundings such as installations generating strong electromagnetic radiation or magnetic fields.
- The liquid crystal panel used in the monitor is manufactured using extremely high precision technology. Although the level of functioning pixels is 99.99% or better, you should be aware that 0.01% or fewer of the pixels may not illuminate or may illuminate when they should not. However, this has no effect on the recorded image.

This product supports PRINT Image Matching III. PRINT Image Matching enabled digital still cameras, printers and software help photographers to produce images more faithful to their intentions. Some functions are not available on printers that are not PRINT Image Matching III compliant.

Copyright 2001 Seiko Epson Corporation. All Rights Reserved.

PRINT Image Matching is a trademark of Seiko Epson Corporation.

The PRINT Image Matching logo is a trademark of Seiko Epson Corporation.

### **Regarding PictBridge**

PictBridge allows the user to connect the printer and digital camera directly, using the unified standard for the direct printout of images. You can print images directly from the camera through a few simple operations.

- There is a possibility that the illustrations and the display screen of the monitor in this manual are different from the actual product.

## FOR USING YOUR CAMERA SAFELY

We have paid close attention to the safety of this product. When using this product, we request your special attention regarding items marked with the following symbols.



### **Warning**

This symbol indicates that violating this item could cause serious personal injuries.



### **Caution**

This symbol indicates that violating this item could cause minor or medium personal injuries, or material losses.

## ABOUT THE CAMERA



### **Warning**

- Do not disassemble or modify the camera. High voltage areas are present inside the camera, with the risk of electric shock.
- If the camera interior is exposed due to dropping or otherwise damaging the camera, never touch the exposed portion. There is the risk of electric shock.
- To avoid the risk of it being swallowed by mistake, keep the SD Memory Card out of the reach of small children. Seek medical attention immediately if a memory card is accidentally swallowed.
- Wrapping the strap around your neck is dangerous. Take care that small children do not hang the strap over their necks.
- Do not look directly at the sun through the camera with a telephoto lens attached, as viewing the sun may damage your eyes. Viewing the sun directly with a telephoto lens may lead to a loss of eyesight.
- Be sure to store the batteries out of the reach of children. Placing in mouth may cause an electrical shock.
- Always use the AC adapter exclusively developed for this product, with the specified power and voltage. Using an AC adapter not exclusive to this product, or using the exclusive AC adapter with an unspecified power or voltage can cause a fire, electric shock, or camera breakdown.
- If any irregularities occur during use, such as smoke or a strange odor, stop use immediately, remove the batteries or the AC adapter, and contact your nearest PENTAX Service Center. Continued use could cause a fire or electric shock.
- During thunderstorms, unplug and discontinue use of the AC adapter. Continued use could cause equipment failure, a fire, or electric shock.

 **Caution**

- Do not short the batteries or dispose of the batteries in fire. Do not disassemble the batteries. The batteries could explode or catch fire.
- Of the batteries that can be used in this camera (AA Ni-MH batteries, AA lithium batteries and AA alkaline batteries), only the Ni-MH batteries can be recharged. Recharging other batteries can cause a fire or explosion.
- Remove the batteries from the camera immediately if they become hot or begin to smoke. Be careful not to burn yourself during removal.
- Some portions of the camera heat up during use. There is the risk of low temperature burns when holding such portions for long periods.
- Do not place your finger over or cover the flash with clothing when discharging the flash. Fingers or clothing may be burned.
- To reduce the risk of hazards, use only CSA/UL Certified power supply cord set, cord is Type SPT-2 or heavier, minimum NO.18 AWG copper, one end with a molded-on male attachment plug cap (with a specified NEMA configuration), and the other is provided with a molded-on female connector body (with a specified IEC nonindustrial type configuration) or the equivalent.

## PRECAUTIONS FOR BATTERY USAGE

- Only use the specified batteries with this camera. Use of other batteries can cause a fire or explosion.
- Replace all the batteries at the same time. Do not mix battery brands, type or an old battery with a new one. It may cause explosion or a fire.
- The batteries should be inserted correctly with regard to polarity (+ and –) marked on the batteries and the camera. Not inserting batteries correctly may cause explosion or a fire.
- Do not disassemble the batteries. Of the batteries that can be used in this camera, only the Ni-MH batteries can be recharged. Disassembling the batteries or attempting to charge non-rechargeable batteries could result in explosion or leakage.

## Care to be Taken During Handling

- When traveling, take the Worldwide Service Network that is included in the package. This will be useful if you experience problems abroad.

- When the camera has not been used for a long time, confirm that it is still working properly, particularly prior to taking important pictures (such as at a wedding or during traveling). Pictures cannot be guaranteed if recording, playback or transferring your data to a computer, etc. is not possible due to a malfunction of your camera or recording media (SD Memory Card), etc.
- Do not clean the product with organic solvents such as thinner or alcohol benzene.
- Do not subject the camera to high temperatures or high humidity. Do not leave the camera in a vehicle, as the temperature can get very high.
- Do not store the camera with preservatives and chemicals. Storage in high temperatures and high humidity can cause mold to grow on the camera. Remove from the case and store in a dry and well-ventilated location.
- Do not subject the camera to strong vibrations, shocks, or pressure. Use a cushion to protect the camera from vibrations of motorcycles, automobiles, or ships.
- The temperature range for camera use is 0°C to 40°C (32°F to 104°F).
- The LCD display may appear black under high temperatures, but will return to normal as temperatures normalize.
- The LCD display may respond more slowly at low temperatures. This is due to liquid crystal properties, and is not a fault.
- Periodic inspections are recommended every one to two years to maintain high performance.
- Sudden temperature changes will cause condensation on the inside and outside of the camera. Place the camera in your bag or a plastic bag, removing the camera after temperature of the camera and surroundings are equalized.
- Avoid contact with garbage, mud, sand, dust, water, toxic gases, or salts. These could cause a camera breakdown. Wipe dry any rain or water drops on the camera.
- Refer to “Precautions When Using the SD Memory Card” (p.42) regarding the SD Memory Card.
- Use a lens brush to remove dust accumulated on the lens or viewfinder. Never use a spray blower for cleaning as it may damage the lens.
- Please contact PENTAX Service Center for professional cleaning of the CCD. (This will involve a fee.)
- Please do not press forcefully on the monitor. This could cause breakage or malfunction.
- Depending on a user's physical condition, some users may experience itching, break out in a rash or suffer from eczema. If an abnormality occurs, immediately discontinue using the camera and seek medical attention.

**Regarding Product Registration**

In order to better serve you, we request that you complete the product registration, which can be found on the CD-ROM supplied with the camera or on the PENTAX website. Thank you for your cooperation.

Refer to the PENTAX PHOTO Browser 3/PENTAX PHOTO Laboratory 3 Operating Manual (Windows users: p.9, Mac OS users: p.10) for more information.

# Contents

FOR USING YOUR CAMERA SAFELY .....	1
ABOUT THE CAMERA.....	1
PRECAUTIONS FOR BATTERY USAGE .....	2
Care to be Taken During Handling .....	2
Contents .....	5
Composition of the Operating Manual .....	11
<b>Before Using Your Camera</b> .....	<b>13</b>
<b><i>K200D</i> Camera Characteristics .....</b>	<b>14</b>
<b>Checking the Contents of the Package.....</b>	<b>16</b>
<b>Names and Functions of Working Parts .....</b>	<b>17</b>
Camera .....	17
Capture Mode .....	18
Playback Mode .....	20
<b>Display Indicators .....</b>	<b>22</b>
Monitor .....	22
Viewfinder .....	27
LCD Panel .....	29
<b>How to Operate the Menu.....</b>	<b>30</b>
<b>Using the Mode Dial.....</b>	<b>32</b>
<b>Getting Started</b> .....	<b>35</b>
<b>Attaching the Strap .....</b>	<b>36</b>
<b>Inserting the Batteries .....</b>	<b>37</b>
Battery Level Indicator .....	38
Approximate Image Storage Capacity and Playback Time (new batteries) .....	39
Using the AC Adapter (Optional) .....	40
<b>Inserting/Removing the SD Memory Card .....</b>	<b>41</b>
Recorded Pixels and Quality Level.....	43
<b>Attaching the Lens.....</b>	<b>45</b>
<b>Adjusting the Viewfinder Diopter .....</b>	<b>47</b>
<b>Turning the Camera On and Off.....</b>	<b>48</b>
<b>Initial Settings .....</b>	<b>49</b>
Setting the Display Language.....	49
Setting the Date and Time .....	52

## Basic Operations 55

---

<b>Basic Shooting Operation</b> .....	<b>56</b>
Holding the Camera .....	56
Letting the Camera Choose the Optimal Settings .....	57
<b>Using a Zoom Lens</b> .....	<b>61</b>
<b>Using the Built-in Flash</b> .....	<b>62</b>
<b>Taking Pictures Using the Shake Reduction Function</b> .....	<b>67</b>
Turning On the Shake Reduction Function .....	68
Setting the Shake Reduction Function .....	69
<b>Playing Back Still Pictures</b> .....	<b>70</b>
Playing Back Images .....	70
<b>Deleting Images</b> .....	<b>72</b>
Deleting a Single Image .....	72

## Shooting Functions 73

---

<b>How to Operate the Shooting Menus</b> .....	<b>74</b>
[  Rec. Mode] Menu Setting Items .....	74
[ <b>C</b> Custom Setting] Menu Setting Items .....	75
Shooting Fn Menu Setting Items .....	77
<b>Selecting the Appropriate Capture Mode for Scenes</b> .....	<b>78</b>
Selecting the Shooting Scene.....	79
<b>Setting the Exposure</b> .....	<b>81</b>
Effect of Aperture and Shutter Speed .....	81
Setting the Sensitivity .....	83
Changing the Exposure Mode .....	85
Selecting the Metering Method .....	98
Adjusting the Exposure .....	100
<b>Focusing</b> .....	<b>102</b>
Using the Autofocus .....	102
Setting the AF Mode .....	104
Selecting the Focusing Area (AF Point).....	105
Fixing the Focus (Focus Lock).....	107
Adjusting the Focus Manually (Manual Focus).....	109
Shooting in Catch-in Focus Mode.....	111



<b>Checking the Composition, Exposure and Focus Before Shooting</b> .....	<b>112</b>
Selecting the Preview Method .....	112
Displaying the Preview .....	113
<b>Continuous Shooting</b> .....	<b>115</b>
<b>Self-Timer Shooting</b> .....	<b>117</b>
<b>Remote Control Shooting (Remote Control F: Sold Separately)</b> .....	<b>120</b>
<b>Using Mirror Up Function to Prevent Camera Shake</b> .....	<b>123</b>
<b>Changing the Shooting Conditions Automatically when Shooting (Auto Bracket)</b> .....	<b>124</b>
<b>Using the Flash</b> .....	<b>127</b>
<hr/>	
<b>Compensating Flash Output</b> .....	<b>128</b>
<b>Allowing Shooting while Charging the Flash</b> .....	<b>129</b>
<b>Flash Characteristics in Each Exposure Mode</b> .....	<b>130</b>
<b>Distance and Aperture when Using the Built-in Flash</b> .....	<b>132</b>
<b>DA, D FA, FA J, FA and F Lens Compatibility with the Built-in Flash</b> .....	<b>133</b>
<b>Using an External Flash (Optional)</b> .....	<b>134</b>
<b>Shooting Settings</b> .....	<b>143</b>
<hr/>	
<b>Setting the Image Processing Method in Capture Mode (Custom Image)</b> .....	<b>144</b>
<b>Setting the File Format</b> .....	<b>146</b>
Setting the JPEG Recorded Pixels .....	146
Setting the JPEG Quality Level .....	147
Setting the File Format .....	148
Setting the RAW Button Function .....	149
Setting the White Balance .....	150
Setting the Color Space.....	155

## Playback Functions 157

---

<b>How to Operate the Menus During Playback</b> .....	<b>158</b>
[  Playback] Menu Setting Items .....	158
[C Custom Setting] Menu Setting Items .....	158
Playback Fn Menu Setting Items .....	159
<b>Rotating Images</b> .....	<b>160</b>
<b>Enlarging Playback Images</b> .....	<b>161</b>
<b>Displaying Multiple Images</b> .....	<b>163</b>
<b>Displaying a Folder</b> .....	<b>165</b>
<b>Comparing Images</b> .....	<b>166</b>
<b>Slideshow</b> .....	<b>167</b>
Setting the Slideshow Display Interval .....	169
<b>Changing Playback Display Method</b> .....	<b>170</b>
<b>Deleting Multiple Images</b> .....	<b>173</b>
Deleting All Images .....	173
Deleting Selected Images (from Multi-image Display) .....	174
Deleting a Folder .....	176
<b>Protecting Images from Deletion (Protect)</b> .....	<b>177</b>
<b>Connecting the Camera to AV Equipment</b> .....	<b>179</b>

## Processing Images 181

---

<b>Processing Images with Digital Filters</b> .....	<b>182</b>
<b>Editing RAW Images</b> .....	<b>185</b>
Editing a RAW Image .....	185
Specifying the Parameters .....	186

## Printing from the Camera 189

---

<b>Setting the Printing Service (DPOF)</b> .....	<b>190</b>
Printing Single Images .....	190
Settings for All Images .....	191
<b>Printing Using PictBridge</b> .....	<b>193</b>
Setting Transfer Mode .....	194
Connecting the Camera to the Printer .....	195
Printing Single Images .....	196
Printing All Images .....	198
Printing Images Using the DPOF Settings .....	199
Disconnecting the USB Cable .....	199

# Camera Settings 201

---

<b>How to Operate the [↖ Set-up] Menu .....</b>	<b>202</b>
[↖ Set-up] Menu Setting Items.....	202
<b>Formatting the SD Memory Card .....</b>	<b>203</b>
<b>Setting the Beep Setting, Date and Time, and Display Language .....</b>	<b>204</b>
Turning the Beep On and Off.....	204
Changing the Date and Time and the Display Style .....	205
Setting the World Time .....	206
Setting the Display Language.....	209
<b>Adjusting the Monitor and the Menu Display .....</b>	<b>210</b>
Setting the Text Size.....	210
Setting the Guide Display Time .....	210
Adjusting the Brightness of the Monitor .....	211
Setting the Display for Instant Review and Digital Preview .....	211
<b>Setting the Image Folder Naming Convention .....</b>	<b>213</b>
Selecting the Folder Name .....	213
Selecting the File Number Setting .....	213
<b>Selecting the Video Output Format and Power Settings.....</b>	<b>214</b>
Selecting the Video Output Format.....	214
Setting Auto Power Off .....	214
Selecting a Battery.....	215
<b>Using Pixel Mapping .....</b>	<b>216</b>
<b>Selecting Capture Mode Settings to Save in the Camera .....</b>	<b>217</b>
<b>Resetting to Default Settings <span style="float: right;">219</span></b>	
<hr/>	
<b>Resetting Rec. Mode/Playback/ Set-up Menu .....</b>	<b>220</b>
<b>Resetting the Custom Function Menu .....</b>	<b>221</b>

---

<b>Default Settings</b> .....	<b>224</b>
<b>Functions Available with Various Lens Combinations</b> .....	<b>228</b>
<b>Notes on [23. Using Aperture Ring]</b> .....	<b>230</b>
<b>Cleaning the CCD</b> .....	<b>231</b>
Removing Dust by Shaking the CCD.....	231
Detecting Dust on the CCD (Dust Alert) .....	231
Removing Dust with a Blower .....	233
<b>Optional Accessories</b> .....	<b>235</b>
<b>Error Messages</b> .....	<b>240</b>
<b>Troubleshooting</b> .....	<b>243</b>
<b>Main Specifications</b> .....	<b>246</b>
<b>Glossary</b> .....	<b>250</b>
<b>Index</b> .....	<b>255</b>
<b>WARRANTY POLICY</b> .....	<b>260</b>

# Composition of the Operating Manual

This Operating Manual contains the following chapters.

## 1 Before Using Your Camera

Explains camera characteristics, accessories and the names and functions of various parts.

1

## 2 Getting Started

Explains your first steps from purchasing the camera to taking pictures. Be sure to read it and follow the instructions.

2

## 3 Basic Operations

Explains the procedures for taking and playing back still pictures.

3

## 4 Shooting Functions

Explains the shooting-related functions.

4

## 5 Using the Flash

Explains how to use the built-in flash and the external flash.

5

## 6 Shooting Settings

Explains the procedures for configuring image processing and setting the save format.

6

## 7 Playback Functions

Explains the procedures for playing back, deleting, and protecting still pictures.

7

## 8 Processing Images

Explains the procedures for using image filters and processing pictures taken in RAW format.

8

## 9 Printing from the Camera

Explains the procedures for setting the print settings and printing still pictures while directly connected to a printer.

9

10

11

12

## 10 Camera Settings

Explains the procedures for changing the camera settings, such as the monitor settings and the image file naming convention.



## 11 Resetting to Default Settings

Explains the procedure for resetting all settings to their default settings.

## 12 Appendix

Explains troubleshooting, introduces optional accessories and provides various resources.

The symbols used in this Operating Manual are explained below.

	Shows reference page number explaining a related operation.
	Shows useful information.
	Shows precautions to take when operating the camera.

# 1 Before Using Your Camera

---

Check the package contents and names and functions of working parts before use.

<b><i>K200D</i> Camera Characteristics .....</b>	<b>14</b>
<b>Checking the Contents of the Package .....</b>	<b>16</b>
<b>Names and Functions of Working Parts .....</b>	<b>17</b>
<b>Display Indicators .....</b>	<b>22</b>
<b>How to Operate the Menu .....</b>	<b>30</b>
<b>Using the Mode Dial .....</b>	<b>32</b>

When using menus and Fn menu, items which cannot be changed due to camera settings appear gray and cannot be selected.
--

- Features a 23.5×15.7 mm CCD with approximately 10.2 million effective pixels for high precision and a wide dynamic range.
- Features Shake Reduction (SR), an image sensor shifting shake reduction system. This enables you to capture sharp pictures with minimal camera shake regardless of the lens type.
- Features an AF sensor with 11 focusing points. The central 9 are wide cross area sensors.
- Features a viewfinder similar to that of a conventional 35 mm camera, with a magnification of approximately 0.85 and field of view of approximately 96%, for easier manual focusing. Also features a superimpose function in which the AF points on the viewfinder illuminate red.
- Features a large 2.7-inch monitor with approximately 230,000 dots, a wide viewing angle and brightness adjusting function for high-precision viewing performance.
- Uses AA lithium batteries, rechargeable AA Ni-MH batteries or AA alkaline batteries.
- A user-friendly design has been implemented in various parts of the camera. The large text, high-contrast monitor and easy-to-use menus make the camera easier to operate.
- Dials, buttons, body joints, and retractable parts of the camera are splash and dust resistant.
- The CCD features a special SP coating against dust deposit. The Dust Removal function also shakes the CCD for removing collected dust.
- Supports the optional Battery Grip D-BG3 with the vertical shutter release button. If batteries are inserted in both the camera and grip, the battery set with more power is prioritized. This enables you to get the best camera performance for an extended period. A menu item also allows you to prioritize a battery set and use its full power before switching to the other.
- Features Custom Image which allows you to adjust settings while previewing the edited image, enabling a wider range of expression.
- Records in the versatile JPEG format or the high quality and fully editable RAW format. You can also select JPEG+RAW and record in both formats. Pictures taken in RAW format can be easily processed internally by the camera.
- Features Hyper-program and Hyper-manual modes that let you take pictures flexibly with the intended exposure. Also features Sensitivity Priority mode **Sv** that automatically adjusts aperture and shutter speed according to the set sensitivity.



The captured area (view angle) will differ between the **K200D** and 35 mm SLR cameras even if the same lens is used because the format size for 35 mm film and CCD are different.

Sizes for 35 mm film and CCD

35 mm film	: 36×24 mm
<b>K200D</b> CCD	: 23.5×15.7 mm

Angles of view being equal, the focal length of a lens used with a 35 mm camera must be approximately 1.5 times longer than that of **K200D**. To obtain an angle of view framing the same area, divide the focal length of the 35 mm lens by 1.5.

Example) To capture the same image as a 150 mm lens attached to a 35 mm camera

$$150 \div 1.5 = 100$$

Use a 100 mm lens with the **K200D**.

Inversely, multiply the focal length of the lens used with **K200D** by 1.5 to determine the focal length for 35 mm cameras.

Example) If 300 mm lens is used with **K200D**

$$300 \times 1.5 = 450$$

Focal length is equivalent to a 450 mm lens on a 35 mm camera.

## Shake Reduction (SR)

Shake Reduction (SR) on the **K200D** features a PENTAX original system which uses magnetic force to move the image sensor at high speeds, compensating camera shake.

The camera may generate some operating noise when it is shaken, such as when changing the composition of a picture. It is not a malfunction.

# Checking the Contents of the Package

The following accessories are packaged with your camera. Check that all accessories are included.

1

Before Using Your Camera



Hot shoe cover F<sub>k</sub>  
(Installed on camera)

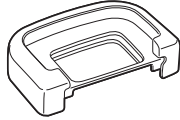

Eyecup F<sub>p</sub>  
(Installed on camera)



ME Viewfinder cap

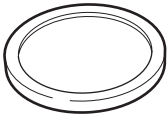

Body mount cover  
(Installed on camera)

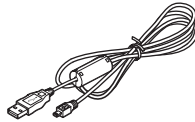

USB cable  
I-USB17

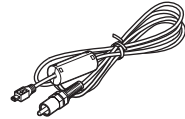

Video cable  
I-VC28

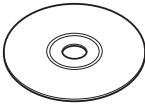

Software (CD-ROM)  
S-SW74

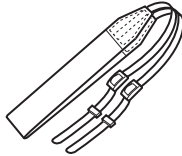

Strap  
O-ST53



Four AA lithium batteries  
(2 packs)



Operating Manual  
(this manual)



Quick Guide

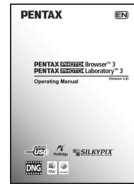

PENTAX PHOTO Browser 3/  
PENTAX PHOTO Laboratory 3  
Operating Manual

## Camera

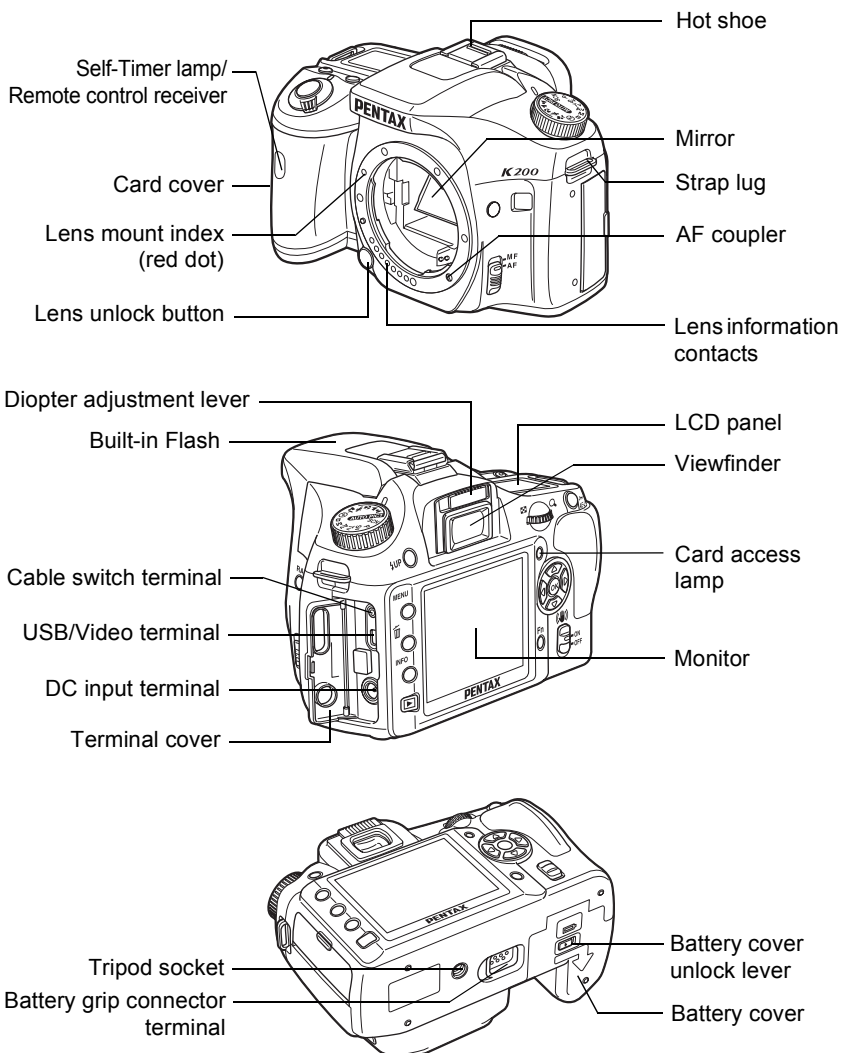

\* In the illustrations above, the back and bottom sides of the camera are shown with the Eyecup F<sub>2</sub> removed.

## Capture Mode

Functions of buttons, dials and levers used during shooting are noted.



The factory default settings are explained here. Depending on the button or dial, these settings can be changed in the [C Custom Settings] menu (p.75).

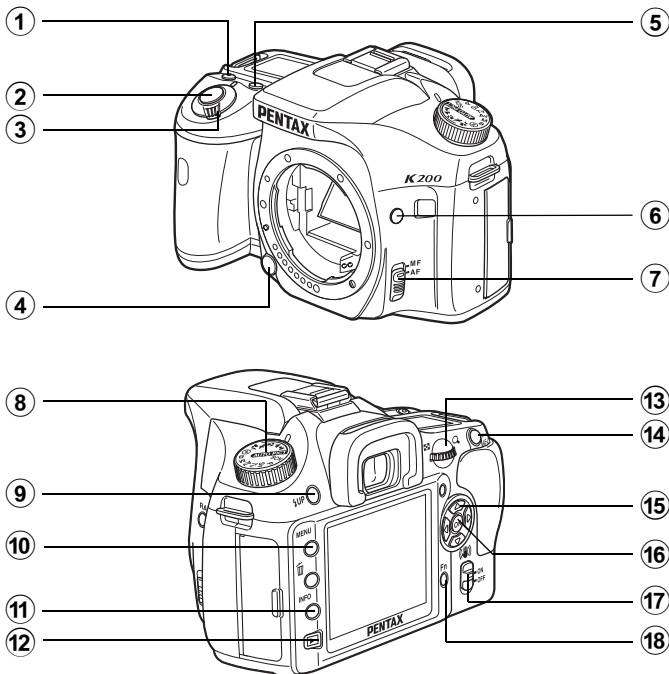

### ① Green button

Sets the Exposure mode to Automatic Exposure (p.88, p.96) and resets the settings (p.100, p.128, p.154).

### ② Shutter release button

Press to capture images. (p.59)

### ③ Main switch

Move to turn the power on/off (p.48) or to preview (p.113).

### ④ Lens unlock button









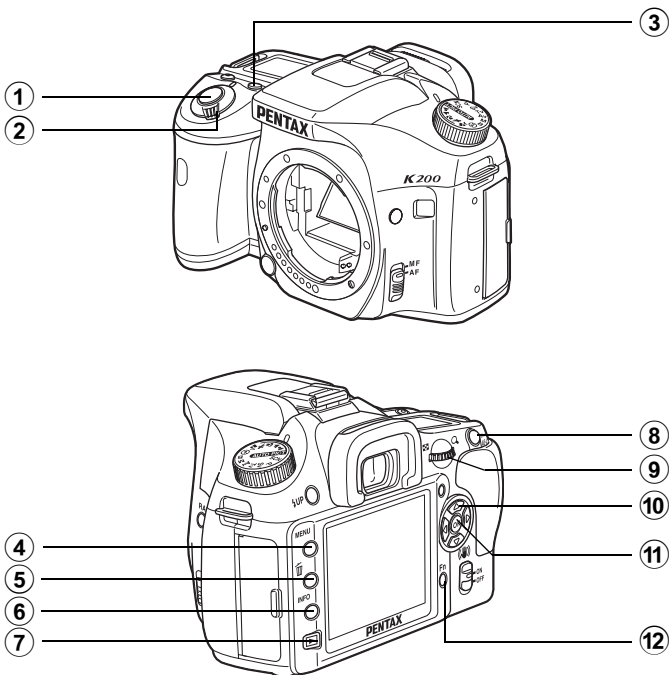

Press to detach lens. (p.46)

- ⑤ **Av button**  
Sets the EV compensation and aperture value. (p.87, p.94, p.100)
- ⑥ **RAW button**  
Changes the file format temporarily. Press to switch to RAW+ (saves both JPEG and RAW files). (p.149)
- ⑦ **Focus mode lever**  
Switches between autofocus mode (p.102) and manual focus mode (p.109).
- ⑧ **Mode dial**  
Changes the Capture mode. (p.32, p.78)
- ⑨ **UP button**  
Press to pop up the built-in flash. (p.62)
- ⑩ **MENU button**  
Displays the [Rec. Mode] menu (p.74). Next, press the four-way controller (▶) to display [Playback] menu (p.158), [Set-up] menu (p.202) and [Custom Setting] menu (p.75, p.158).
- ⑪ **INFO button**  
Press to show shooting information on the monitor. (p.23)
- ⑫ **▶ button**  
Switches to the Playback mode. (p.70, p.158)
- ⑬ **e-dial**  
Sets the shutter speed, aperture, sensitivity and EV compensation values.
- ⑭ **AE-L button**  
Locks the exposure before shooting. (p.96, p.101)
- ⑮ **Four-way controller (▲▼◀▶)**  
Use this to move the cursor or change items in menus and Fn menu.
- ⑯ **OK button**  
Saves the setting you selected in the menu.  
Press when menu is not displayed to display the currently selected sensitivity in the LCD panel and viewfinder.
- ⑰ **Shake Reduction switch**  
Turns the Shake Reduction function on or off. (p.68)
- ⑱ **Fn button**  
Press to display the Fn menu. (p.77, p.159)

## Playback Mode

Functions of buttons, dials and levers used during playback are noted.



- ① **Shutter release button**  
Press halfway to switch to Capture mode.
- ② **Main switch**  
Move to turn the camera on and off. (p.48) Set to the  position to switch to Capture mode and preview.
- ③ ** Av button**  
Press in Enlarged view to increase the magnification. (p.162)
- ④ **MENU button**  
Press to display the [ Playback] menu (p.158). Next, press the four-way controller () to display [ Set-up] menu (p.202), [ Custom Setting] menu (p.75) and [ Rec. Mode] menu (p.74).
- ⑤ ** button**  
Press to delete images. (p.72)
- ⑥ **INFO button**  
Press to show shooting information on the monitor. (p.25)
- ⑦ ** button**  
Press to switch to Capture mode.
- ⑧ ** button**  
Press to protect images from being accidentally erased. (p.177)  
Press in enlarged view to decrease the magnification. (p.162)
- ⑨ **e-dial**  
Use it to enlarge an image (p.162) or display multiple images at the same time (p.163).
- ⑩ **Four-way controller ()**  
Use it to move the cursor or change items in menus, Fn menu and playback screen.
- ⑪ **OK button**  
Saves the setting you selected in the menu or playback screen.
- ⑫ **Fn button**  
Press to display the Fn menu. (p.159)

## Monitor

The following indicators appear on the monitor depending on the status of the camera.

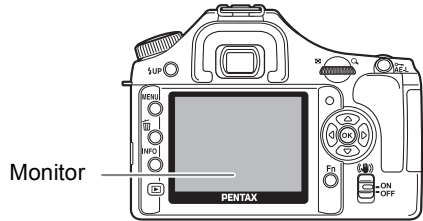

Monitor

### At Start-up or when Operating the Mode Dial

Guides appear on the monitor for 3 seconds (default setting) when the camera is switched on or the mode dial is turned.



Select Off for [Guide display] in [Set-up] menu to not show indicators. (p.202)

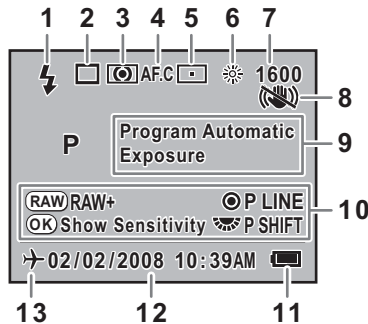

- |  |                                   |
|--|-----------------------------------|
| 1 Flash mode<br>(Active mode appears) (p.63) | 7 Sensitivity (p.83)              |
| 2 Drive mode (p.77)                          | 8 Shake Reduction (p.68)          |
| 3 AE metering (p.98)                         | 9 Capture mode, Scene mode (p.78) |
| 4 Focus mode (p.102)                         | 10 Button/dial guide              |
| 5 AF point position (p.105)                  | 11 Battery level (p.38)           |
| 6 White balance (p.150)                      | 12 Date and time (p.52)           |
|  | 13 World Time (p.206)             |

\* Indicators 3, 5, 6 and 7 only appear when a setting other than the default setting is selected. 8 only appears when Shake Reduction is Off. 13 only appears when World Time is On.



## Capture Mode

Press the **INFO** button in Capture mode to display the capture function settings on the monitor for 30 seconds.

Press the four-way controller (▲▼) while displayed to switch to explanation of set Shooting mode.

### ● Detailed information display

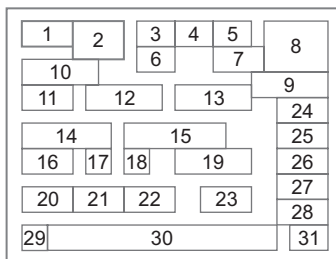
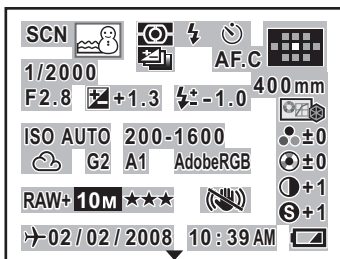

- |    |                                     |    |  |
|----|-------------------------------------|----|--|
| 1  | Capture mode (p.32)                 | 17 | GM compensation (Adjust White Balance) (p.154) |
| 2  | Scene mode (p.79)                   | 18 | BA compensation (Adjust White Balance) (p.154) |
| 3  | AE metering (p.98)                  | 19 | Color Space (p.155)                            |
| 4  | Flash mode (p.63)                   | 20 | File format (p.148)                            |
| 5  | Drive mode (p.77)                   | 21 | JPEG recorded pixels (p.146)                   |
| 6  | Exposure bracket (p.124)            | 22 | JPEG quality (p.147)                           |
| 7  | Focus mode (p.102)                  | 23 | Shake Reduction (p.68)                         |
| 8  | AF point position (p.105)           | 24 | Image Tone (p.144)                             |
| 9  | Lens focal length (p.69)            | 25 | Saturation/Filter Effect (p.144)               |
| 10 | Shutter speed (p.81)                | 26 | Hue/Toning (p.144)                             |
| 11 | Aperture (p.82)                     | 27 | Contrast (p.144)                               |
| 12 | EV compensation (p.100)             | 28 | Sharpness/Fine Sharpness (p.144)               |
| 13 | Flash exposure compensation (p.128) | 29 | World Time (p.206)                             |
| 14 | Sensitivity (p.83)                  | 30 | Date and time (p.52)                           |
| 15 | ISO correction in AUTO (p.83)       | 31 | Battery level (p.38)                           |
| 16 | White balance (p.150)               |    |  |

\* In order to explain the detailed information display, a screenshot with all the information displayed is shown here. Depending on the Capture mode, some of the information may not be displayed.

## ● Explanation of Shooting Mode

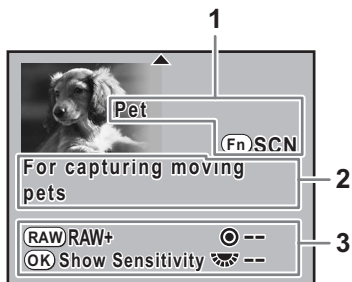

- 1 Capture mode (p.32)
- 2 Capture mode explanation
- 3 Button/dial guide

## Playback Mode

Every time you press the **INFO** button during playback, the camera switches screen displays in the following order: Standard display, Histogram display, Detailed information display and No information display (image only).



You can change the information initially displayed by pressing the button.

### ● Detailed information display

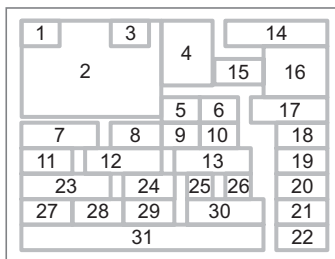
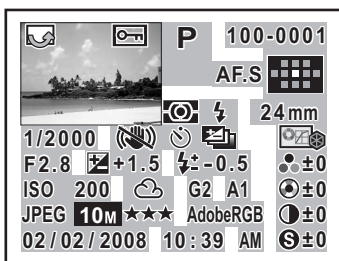

- |    |                             |    |  |
|----|-----------------------------|----|--|
| 1  | Rotation information        | 18 | Image Tone                             |
| 2  | Captured image              | 19 | Saturation/Filter Effect               |
| 3  | Protect                     | 20 | Hue/Toning                             |
| 4  | Capture mode                | 21 | Contrast                               |
| 5  | AE metering                 | 22 | Sharpness/Fine Sharpness               |
| 6  | Flash mode                  | 23 | Sensitivity                            |
| 7  | Shutter speed               | 24 | White balance                          |
| 8  | Shake Reduction             | 25 | GM compensation (Adjust White Balance) |
| 9  | Drive mode                  | 26 | BA compensation (Adjust White Balance) |
| 10 | Exposure bracket            | 27 | File format                            |
| 11 | Aperture                    | 28 | JPEG recorded pixels                   |
| 12 | EV compensation             | 29 | JPEG quality                           |
| 13 | Flash exposure compensation | 30 | Color Space                            |
| 14 | Folder No./File No.         | 31 | Shooting date/time                     |
| 15 | Focus mode                  |    |  |
| 16 | AF point position           |    |  |
| 17 | Lens focal length           |    |  |

\* Indicators 6 and 13 only appear for images in which the flash was discharged.

## ● Histogram Display

The **K200D** features two histogram displays. The “Brightness histogram” shows the distribution of brightness and the “RGB histogram” shows the distribution of color intensity. Press the four-way controller (▲▼) to switch between “Brightness histogram” and “RGB histogram”.

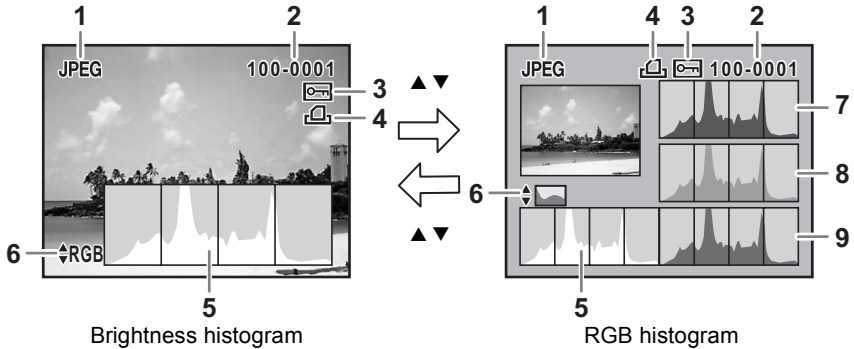

- |   |                                |   |   |
|---|--------------------------------|---|---|
| 1 | File Format                    | 6 | Switch Brightness histogram/<br>RGB histogram |
| 2 | Folder No./File No. (p.213)    | 7 | Histogram (R)                                 |
| 3 | Protect setting (p.177)        | 8 | Histogram (G)                                 |
| 4 | DPOF settings (p.190)          | 9 | Histogram (B)                                 |
| 5 | Histogram (Brightness) (p.170) |   |   |

\* Indicator 3 only appears for images with Protect setting and indicator 4 only appears for images with DPOF settings.



Areas where blooming or dark portions blink if [Bright/Dark area] warning is set to  (On) in [Playback display] in the [ Playback] menu. (p.171)

## Viewfinder

The following information appears in the viewfinder.

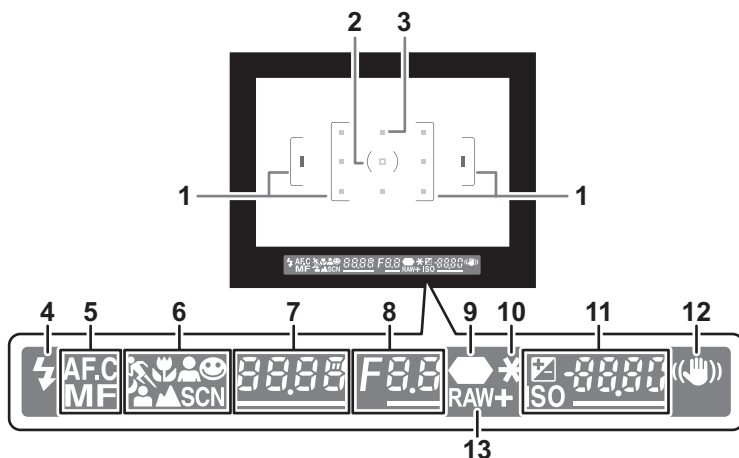

- 1 AF frame (p.47)
- 2 Spot metering frame (p.98)
- 3 AF point (p.105)
- 4 Flash status (p.62)  
Lit: when flash is available.  
Blinks: when flash is recommended but not set.
- 5 Focus mode (p.102)  
Appears when AF Mode is set to **A.F.C.** (Continuous mode) or **M.F.**
- 6 Picture/Scene mode icon (p.78)  
Icon for Picture mode or Scene mode in use appears.  
👤 (Moving Object), 🌿 (Macro), 👤 (Portrait), 😊 (Normal mode in AUTO PICT),  
🌃 (Night Scene Portrait), 🏔️ (Landscape), **SCN** (Scene)
- 7 Shutter speed (p.81)  
Shutter speed when capturing or adjusting.  
Underlined when shutter speed can be adjusted with the e-dial.
- 8 Aperture value (p.82)  
Aperture value when capturing or adjusting.  
Underlined when aperture value can be adjusted with the e-dial.

- 9** Focus indicator (p.58)  
Lit: when image is focused.  
Blinks: when the subject is not in focus.
- 10** AE lock (p.101)  
Appears during AE lock.
- 11** Number of recordable images/EV compensation/Sensitivity  
Displays the number of recordable images with current quality and recorded pixel setting.  
The difference from the appropriate exposure value appears if exposure mode is **M**. (p.95)  
**☒**: EV compensation (p.100)  
Underlined when EV compensation can be adjusted with the e-dial while the **☒ Av** button is pressed.  
**ISO**: Sensitivity  
Underlined when sensitivity can be adjusted with the e-dial
- 12** Shake Reduction (p.68)  
Appears when the Shake Reduction function is activated.
- 13** File format (p.148)  
Displays the image save format in RAW/RAW+ format.  
Not displayed in JPEG format.



- The AF point in use for autofocus is superimposed in red when the shutter release button is pressed halfway. (p.105)
- When [12. OK button when shooting] in the [**C** Custom Setting] menu is set to [Sensitivity/No. of Shots] and Sensitivity Priority Mode is set, the number of recordable images is displayed in 11 while the **OK** button is pressed. When set to another mode, ISO sensitivity is displayed in 11 while the **OK** button is pressed. (p.84).
- [999] is the maximum number of recordable images that can be displayed in the viewfinder. Even if the number of recordable images is 1000 or more, [999] is displayed.

## LCD Panel

The following information appears in the LCD panel on top of the camera.

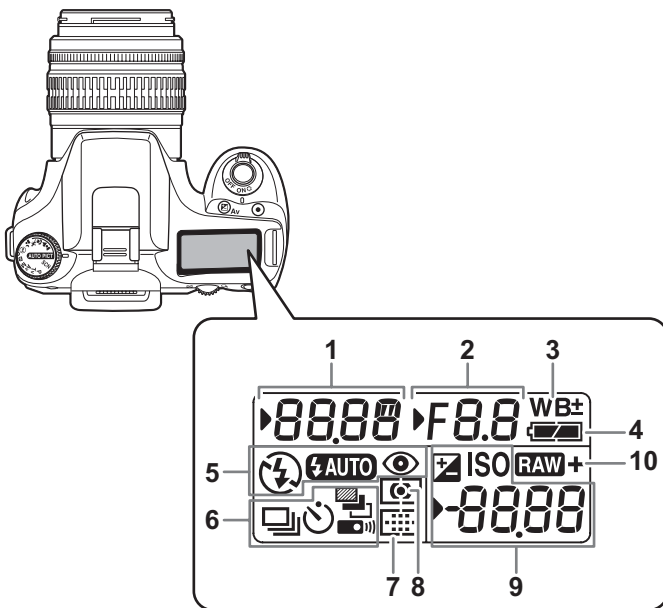

- |   |  |
|---|--|
| <p><b>1</b> Shutter speed (p.81)</p> <p><b>2</b> Aperture (p.82)</p> <p><b>3</b> White balance (p.150)<br/>(Not displayed when set to Auto)<br/>± : White balance correction</p> <p><b>4</b> Battery level</p> <p><b>5</b> Flash mode (p.62)<br/>⚡ : Built-in flash is ready<br/>(when blinking, flash should be used)<br/>⚡ : Flash off<br/>⚡ AUTO : Auto discharge<br/>👁 : Red-eye reduction flash on</p> <p><b>6</b> Drive mode (p.77)<br/>□ : Single frame shooting<br/>📄 : Continuous shooting<br/>⌚ : Self-timer shooting<br/>📷 : Auto bracket shooting<br/>📷 : Remote control shooting</p> | <p><b>7</b> Focusing area (p.105)<br/>No indicator: Auto<br/>📄 : Select<br/>□ : Center</p> <p><b>8</b> AE metering (p.98)<br/>No indicator: Multi-segment metering<br/>👁 : Center-weighted metering<br/>□ : Spot metering</p> <p><b>9</b> Recordable image no. (up to [999]) / EV compensation (p.100) / Sensitivity / PC (mass storage), Pb (PictBridge)</p> <p><b>10</b> File Format (p.148)<br/>RAW : RAW capture<br/>RAW+ : RAW+JPEG capture<br/>No indicator : JPEG</p> |
|---|--|

This section explains operation methods for [📷 Rec. Mode] menu, [▶ Playback] menu, [⚙️ Set-up] menu and [C Custom Setting] menu.

1

## Displaying the Menu screen

### 1 Press the MENU button in Capture mode.

The [📷 Rec. Mode] menu appears on the monitor.

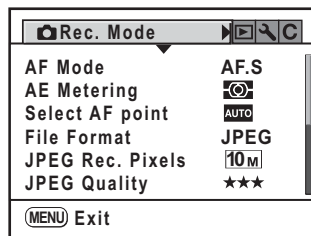
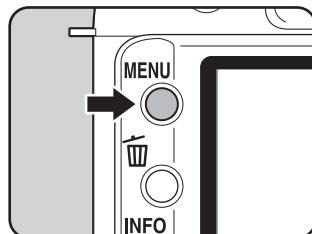

### 2 Press the four-way controller (▶).

The [▶ Playback] menu, [⚙️ Set-up] menu and [C Custom Setting] menu appear in order each time the four-way controller is pressed. (The screen for the [⚙️ Set-up] menu is shown on the right.)

You can use the e-dial to switch the menus.

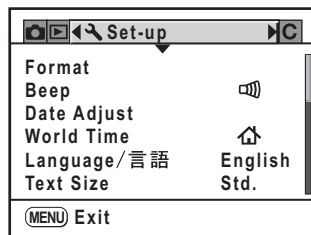



## Selecting and Setting a Menu Item

Procedure to set the [JPEG Quality] on the [📷 Rec. Mode] menu is explained as an example.

- 3 Use the four-way controller (▲▼) to choose an item.**

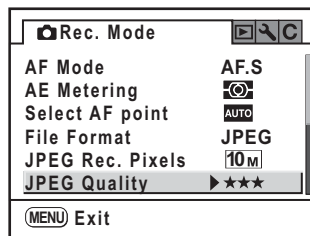

- 4 Press the four-way controller (▶).**

Quality levels available when recording in JPEG format are displayed.

Press the four-way controller (▶) to move to the pop-up menu if there is one.

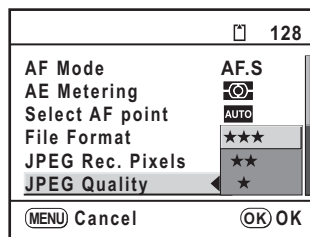

- 5 Use the four-way controller (▲▼) to select a setting.**

When the quality level is changed, the number of recordable images at that quality level appears at the top right of the screen.

- 6 Press the OK button.**

The camera returns to the menu screen. Next, set other items.

Press the **MENU** button to return to Capture or Playback mode.









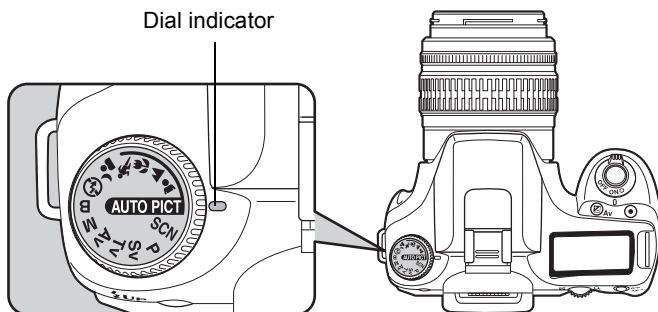

Even after you press the **MENU** button and close the menu screen, your settings will not be saved if the camera is turned off improperly (such as by removing the battery while the camera is on).



If the **MENU** button is pressed in Capture mode, the [📷 Rec. Mode] menu appears. If the **MENU** button is pressed in Playback mode, the [▶ Playback] menu appears.



You can switch the Capture mode by setting the icons on the mode dial to the dial indicator.

Mode	Characteristics	Page
 (Auto Picture)	The optimal capture mode is automatically selected from Portrait, Landscape, Macro and Moving Object modes or standard settings (Normal mode).	p.78
 (Portrait)	Optimal for capturing portraits.	
 (Landscape)	Deepens the focus range, emphasizes contour and saturation of trees and the sky, and produces a bright image.	
 (Macro)	Lets you take vibrant pictures of flowers or other small subjects at short distances.	
 (Moving Object)	Lets you take sharp pictures of a quickly moving subject, such as a sporting event.	
 (Night Scene Portrait)	Lets you capture people against a night view or at dusk.	
 (Flash OFF)	The built-in flash is deactivated. Other settings are the same as the Normal mode in  .	p.79
<b>SCN</b> (Scene)	Selects from 8 situations depending on the shooting conditions.	



For  (Night Scene Portrait), the shutter speed becomes slower in dark places, even if the built-in flash is used. To prevent camera shake, either use the Shake Reduction function or mount the camera on a tripod.

Mode	Characteristics	Page
<b>P</b> (Program)	Automatically sets shutter speed and aperture to the proper exposure according to Program line when taking pictures.	p.85
<b>Sv</b> (Sensitivity Priority)	Automatically sets the shutter speed and aperture to the proper exposure according to the set sensitivity.	
<b>Tv</b> (Shutter Priority)	Lets you set the desired shutter speed to freeze or emphasize subject movement. Take pictures of fast moving subjects that look still or subjects that give a sense of movement.	
<b>Av</b> (Aperture Priority)	Lets you set the desired aperture for controlling the depth of field. Use it to obtain a blurred or sharp background.	
<b>M</b> (Manual)	Lets you set shutter speed and aperture to capture the picture with creative intent.	
<b>B</b> (Bulb)	Lets you capture images that require slow shutter speeds such as fireworks and night scenes.	



In this manual, Capture modes are referred to as follows.

Picture mode	(Auto Picture)/  (Portrait)/  (Landscape)/  (Macro)/  (Moving Object)/  (Night Scene Portrait)/  (Flash OFF)
<b>SCN</b> (Scene) mode	(Night Scene)/  (Surf & Snow)/  (Food)/  (Sunset)/  (Kids)/  (Pet)/  (Candlelight)/  (Museum)
Exposure mode	<b>P</b> (Program)/ <b>Sv</b> (Sensitivity Priority)/ <b>Tv</b> (Shutter Priority)/ <b>Av</b> (Aperture Priority)/ <b>M</b> (Manual)/ <b>B</b> (Bulb)



# 2 Getting Started

---

This chapter explains your first steps from purchasing the camera to taking pictures. Be sure to read it and follow the instructions.

<b>Attaching the Strap .....</b>	<b>36</b>
<b>Inserting the Batteries .....</b>	<b>37</b>
<b>Inserting/Removing the SD Memory Card .....</b>	<b>41</b>
<b>Attaching the Lens .....</b>	<b>45</b>
<b>Adjusting the Viewfinder Diopter .....</b>	<b>47</b>
<b>Turning the Camera On and Off .....</b>	<b>48</b>
<b>Initial Settings .....</b>	<b>49</b>

# Attaching the Strap

- 1** Pass the end of the strap through the strap lug, then secure it on the inside of the clasp.

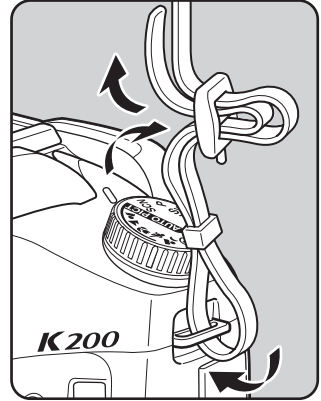

- 2** Pass the other end of the strap through the other strap lug on the camera, then secure it on the inside of the clasp.

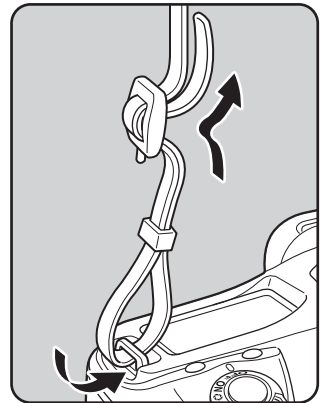

Insert batteries into the camera. Use four AA lithium batteries, AA Ni-MH batteries, or AA alkaline batteries.

This camera is packaged with AA lithium batteries for checking the camera functionality but some other kinds of batteries are also compatible. Use the compatible batteries according to the intended purpose.

AA lithium batteries	Provided with the camera. Recommended in cold climates.
AA Ni-MH rechargeable batteries	These are rechargeable and are economical. A commercially available battery charger that is compatible with the batteries is required.
AA alkaline batteries	These are easily obtainable when your usual batteries run out but they may not support all the camera functions under certain conditions. We do not recommend their use except in emergencies and checking the camera functionality.



- The use of Ni-Mn batteries is not recommended as the batteries' voltage characteristics may cause a malfunction.
- AA lithium batteries and AA alkaline batteries that can be used in this camera are not rechargeable.
- Do not open the battery cover or remove the batteries while the power is on.
- Remove the batteries when you will not use the camera for a long while. The batteries may leak.
- If the date and time settings have been reset when you insert new batteries after a long time, follow the procedure for "Setting the Date and Time" (p.52).
- Insert batteries correctly. Batteries inserted incorrectly may cause a camera breakdown. Wipe the electrodes of the batteries before inserting.
- Replace all the batteries at the same time and do not mix battery types, brands or old batteries with new ones. Otherwise, malfunctions, such as the battery level not being displayed properly, may occur.

**1** Push and hold the battery cover unlock lever as shown in the illustration (①), and slide the battery cover toward the lens (②), and then flip open.

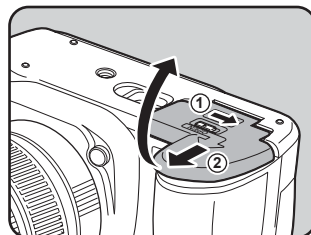

- 2** Insert the batteries according to the +/– indicators in the battery chamber.

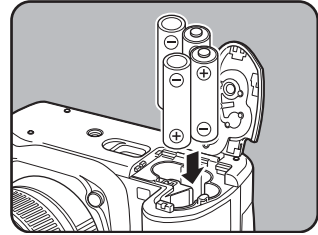

- 3** Press down on the batteries with the battery cover (①) and slide it as shown in the illustration (②) to close.

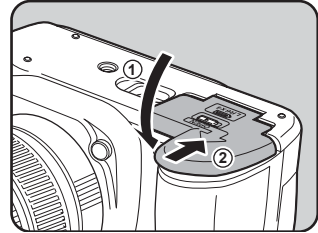





Be sure to fully close the battery cover. The camera will not turn on if the battery cover is open.



- Use the AC adapter D-AC76 (optional) when using the camera for a prolonged period. (p.40)
- Check the battery orientation if the camera does not operate properly after replacing the batteries.

## Battery Level Indicator

You can confirm remaining battery level by checking the  displayed on the LCD panel.

	lit	: Battery is full.
↓		
	lit	: Battery is running low.
↓		
	lit	: Battery is almost empty.
↓		
	blink	: The camera turns off after displaying a message.





- may appear even when the battery level is sufficient if the camera is used at low temperatures or when performing continuous shooting consecutively. Turn the camera off and on again. If appears, you can use the camera.
- does not appear on the LCD panel when using the AC adapter D-AC76 (optional).

## Approximate Image Storage Capacity and Playback Time (new batteries)

Batteries (Temperature)	Normal recording	Flash photography		Playback time
		50% use	100% use	
AA lithium batteries (23°C) ( 0°C)	1100 900	550 440	350 250	700 minutes 600 minutes
AA rechargeable batteries (NiMH 2500mAh) (23°C) ( 0°C)	700 500	400 280	240 190	480 minutes 400 minutes
AA Alkaline batteries (23°C) ( 0°C)	200 Not applicable	80 Not applicable	50 Not applicable	300 minutes 200 minutes

The picture storage capacity (normal recording and flash use 50%) is based on measuring conditions in accordance with CIPA standards and the others are based on PENTAX measuring conditions. Some deviation from the above figures may occur in actual use depending on shooting mode and shooting conditions.



- Battery performance temporarily decreases as the temperature decreases. When using the camera in cold climates, have extra batteries on hand and keep them warm in your pocket. Battery performance will return to normal when returned to room temperature.
- Have extra batteries ready when traveling overseas, taking pictures in cold climates, or when you will be taking a lot of pictures.

## Using the AC Adapter (Optional)

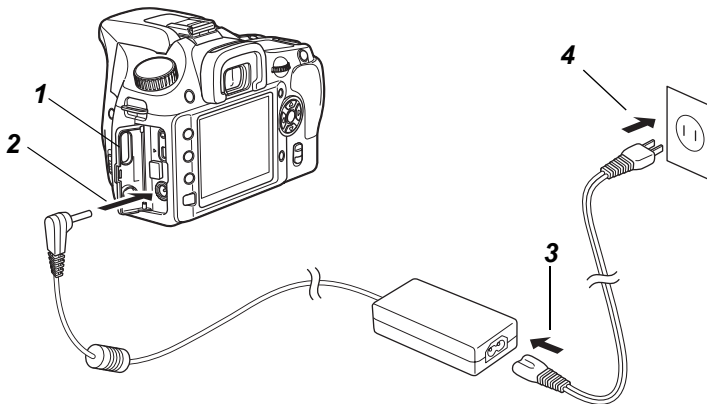

We recommend using the AC adapter D-AC76 (optional) when using the monitor for a long time or when connecting to your PC.

- 1** Make sure the camera is turned off before opening the terminal cover.
- 2** Connect the DC terminal on the AC adapter to the DC input terminal on the camera.
- 3** Connect the AC plug cord to the AC adapter.
- 4** Plug the AC cord into the power outlet.



- Make sure the camera is turned off before connecting or disconnecting the AC adapter.
- Make sure connections are secure between the camera, AC adapter, AC plug cord terminal and the power outlet. SD Memory Card and data will be corrupted if disconnected while camera is recording or reading data.



- Be sure to read the AC adapter D-AC76 Operating Manual when using the AC adapter.
- The rechargeable batteries in your camera will not charge when connected to the AC adapter.

# Inserting/Removing the SD Memory Card

This camera uses either an SD Memory Card or an SDHC Memory Card. (Both cards are referred to as SD Memory Cards hereafter.) Make sure the camera is turned off before inserting or removing the SD Memory Card (market product).



- Do not remove the SD Memory Card while the card access lamp is lit.
- Use this camera to format (initialize) an SD Memory Card that is unused or has been used on other cameras or digital devices. Refer to “Formatting the SD Memory Card” (p.203) for details on formatting.

**1**

Slide the card cover in the direction of the arrow (①) and then lift open (②).

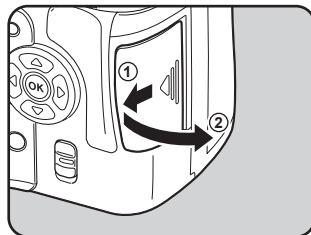
**2**

Insert the card all the way with the SD Memory Card label toward the monitor.

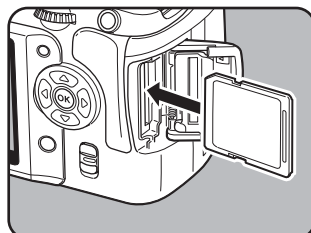

Push the SD Memory Card in once to remove.

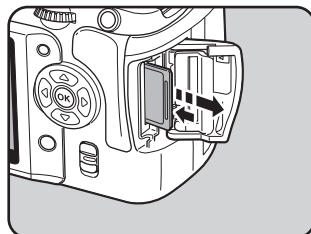
**3**

Close the card cover (①) and then slide it in the direction of the arrow (②).

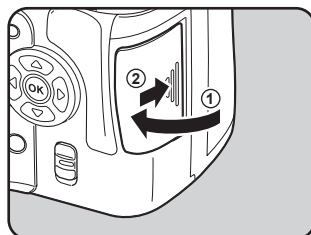

Be sure to fully close the card cover. The camera will not turn on if the card cover is open.

**2**

## Precautions When Using the SD Memory Card

- The SD Memory Card is equipped with a write-protect switch. Setting the switch to LOCK protects the existing data by prohibiting recording of new data, deletion of existing data or formatting of the card.
- Care should be taken when removing the SD Memory Card immediately after using the camera because the card may be hot.
- Do not remove the SD Memory Card or turn the camera off while data is being saved to the card, images are being played back, or the camera is connected to a computer with the USB cable. This may cause the data to be lost or the card to be damaged.
- Do not bend the SD Memory Card or subject it to violent impact. Keep it away from water and store away from high temperatures.
- Do not remove the SD Memory Card during formatting. The card may be damaged beyond use.
- Data on the SD Memory Card may be deleted in the following circumstances. PENTAX does not accept any liability for data that is deleted if
  - (1) the SD Memory Card is mishandled by the user.
  - (2) the SD Memory Card is exposed to static electricity or electrical interference.
  - (3) the card has not been used for a long time.
  - (4) the card is ejected or the battery is removed while the data on the card is being recorded or accessed.
- If the SD Memory Card is not used for a long time, the data on the card may become unreadable. Be sure to regularly make a backup of important data on a computer.
- Avoid using or storing the card where it may be exposed to static electricity or electrical interference.
- Avoid using or storing the card in direct sunlight or where it may be exposed to rapid changes in temperature or to condensation.
- For information on compatible SD Memory Cards, visit the PENTAX website.
- Format new SD Memory Cards. Also format SD Memory Cards used with other cameras.
  - ☛ Formatting the SD Memory Card (p.203)
- Please note that formatting the SD Memory Card will not necessarily delete the data so that it cannot be recovered using off the shelf data recovery software. If you are going to discard, give away or sell your SD Memory Card you should ensure that the data on the card is completely deleted or the card itself is destroyed if it contains any personal or sensitive information. There are off the shelf secure data deletion software programs available that will completely delete the data. In any case the data on your SD Memory Card should be managed at your own risk.

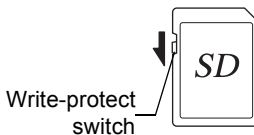

## Recorded Pixels and Quality Level

### When the File Format is JPEG

Choose the number of pixels (size) and quality level (JPEG data compression rate) of pictures according to how you intend to use the pictures you have taken.

Pictures with larger recorded pixels or more ★s are clearer when printed. The number of pictures that can be taken (the number of pictures that can be recorded on an SD Memory Card) decreases with larger file sizes. The quality of the captured photo or printed picture depends on the quality level, exposure control, resolution of the printer and a variety of other factors so you do not need to select more than the required number of pixels. For example, to print in postcard size, **2M** (1824×1216) is adequate. Set the appropriate recorded size and quality level depending on purpose.

Choose the appropriate number of recorded pixels and quality level for JPEG images on the [ Rec. Mode] menu.

- ☞ Setting the JPEG Recorded Pixels (p.146)
- ☞ Setting the JPEG Quality Level (p.147)

### ● JPEG Recorded Pixels, JPEG Quality and Approximate Image Storage Capacity

JPEG Quality \ JPEG Rec. Pixels	★★★ Best	★★ Better	★ Good
<b>10M</b> (3872×2592)	202	343	586
<b>6M</b> (3008×2000)	335	570	974
<b>2M</b> (1824×1216)	902	1549	2627

- The above table shows the approximate image storage capacity when using a 1 GB SD Memory Card.
- The above figures may vary depending on the subject, shooting conditions, shooting mode and SD Memory Card, etc.



When the number of storable images exceeds 500, captured images are divided into folders of 500 images each. However, in Auto Bracket shooting, images will be stored in the same folder until shooting is completed, even if the number of images exceeds 500.

## When the File Format is RAW

With **K200D**, you can record in the versatile JPEG format or the high quality and editable RAW format. For RAW file format, you can select the PENTAX original PEF format or general-purpose DNG (Digital Negative) format designed by Adobe Systems. On a 1 GB SD Memory Card, you can record up to 58 images in PEF format or DNG format.

☞ Setting the File Format (p.148)

All camera exposure modes are available when using DA, D FA, FA J or other lenses with an Aperture **A** (Auto) position. Some functions are restricted when lenses are not set to the Aperture **A** position. Also see “Notes on [23. Using Aperture Ring]” (p.230). Other lenses and accessories will not be available with factory default settings. To allow shutter release with lenses or accessories not listed above, set [23. Using aperture ring] in the [**C** Custom Settings] menu. (p.76)



Turn the camera off before attaching or removing the lens to prevent unexpected lens movement.

**1** Check that the camera is turned off.

**2** Remove the body mount cover (①) and lens mount cover (②).

Be sure to put the lens down with the lens mount side facing upward to protect the lens mount from damage after removal.

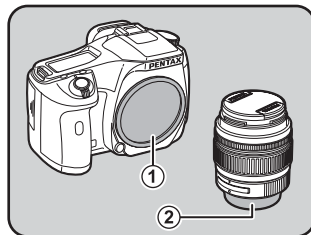

**3** Align the Lens mount index (red dots) on the camera and the lens, and secure by turning the lens clockwise until it clicks.

After attaching, turn the lens counterclockwise to check that the lens is locked in place.

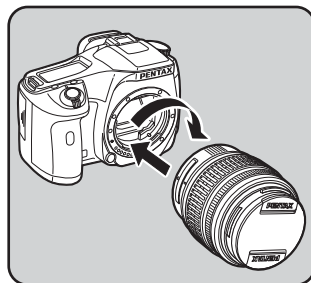

- 4** Remove the front lens cap by pushing the indicated portions inward.

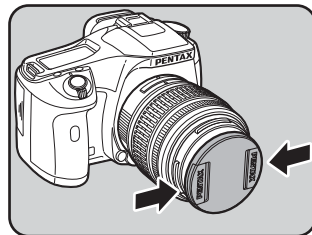

To detach the lens, hold down the lens unlock button (③) and turn the lens counterclockwise.

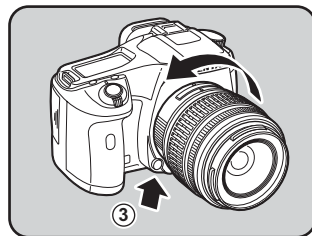

- The body mount cover (①) is a cover to prevent scratches and block dust when shipped. Body Mount Cap K is sold separately and has a lock function.
- We assume no responsibility nor liability for accidents, damages and malfunctions resulting from the use of lenses made by other manufacturers.
- The camera body and lens mount incorporate lens information contacts and an AF coupler. Dirt, dust, or corrosion may damage the electrical system. When necessary, clean the contacts with a soft dry cloth.



Adjust the viewfinder to suit your eyesight. If it is difficult to see the viewfinder image clearly, slide the diopter adjustment lever sideways.

You can adjust the diopter from approximately  $-2.5$  to  $+1.5$   $m^{-1}$ .

- 1 Look through the viewfinder and point the camera at a white wall or other bright and consistent surface. Slide the diopter adjustment lever left or right.**

Adjust the lever until the AF frame in the viewfinder is focused.

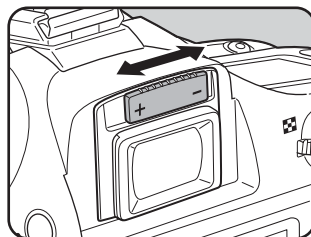

AF frame



- The F<sub>P</sub> Eyecup is attached to the viewfinder portion when the camera leaves the factory. Diopter adjustment is available with the F<sub>P</sub> Eyecup attached. However, adjustment is easier with the eyecup removed.
- To remove the F<sub>P</sub> Eyecup, pull it out in the direction of the arrow.  
To attach the F<sub>P</sub> Eyecup, align it with the groove on the viewfinder eyepiece and push it into position.
- If it is difficult to see the viewfinder image clearly even if you set the diopter adjustment lever, use the optional diopter correction lens adapter M. However, the Eyecup F<sub>P</sub> must be removed to use this adapter. (p.238)

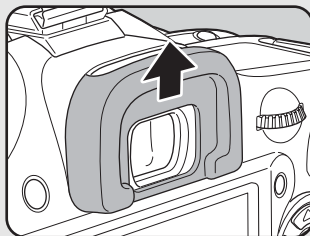



## 1 Move the main switch to [ON] position.

The camera will turn on.

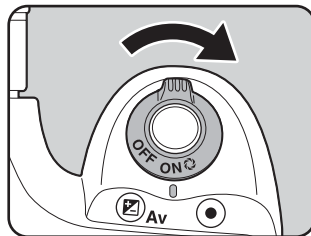
Move the main switch to [OFF] position to turn off the camera.



- Always turn the camera off when not in use.
- The power will automatically turn off when you do not perform any operations within a set period of time. To reactivate the camera after the camera turns off automatically, turn it on again or perform any of the following.
  - Press the shutter release button halfway.
  - Press the  button.
  - Press the **INFO** button.
- By default, the camera is set to power off automatically after 1 minute of inactivity. You can change the setting with [Auto Power Off] on the [ Set-up] menu. (p.214)

The first time the camera is turned on after purchasing, the [Language/言語] screen appears on the monitor. Follow the procedure below to set the language displayed on the monitor and the current date and time. Once setting is done, these will not need to be set again when turning your camera on.

If the Date Adjust screen appears, set the date and time by following the procedure in “Setting the Date and Time” (p.52).

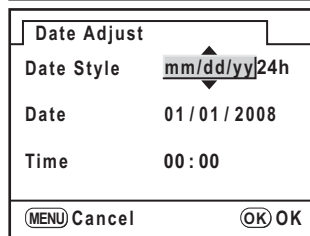

## Setting the Display Language

You can choose the language in which the menus, error messages, etc. are displayed from the following: English, French, German, Spanish, Portuguese, Italian, Dutch, Danish, Swedish, Finnish, Polish, Czech, Hungarian, Turkish, Russian, Korean, Chinese (traditional/simplified) and Japanese.

### 1 Use the four-way controller (▲▼◀▶) to select the desired language.

The default setting is English.



### 2 Press the OK button.

The [Initial Setting] screen for the selected language appears.

Press the four-way controller (▼) twice and proceed to Step 10 if [Hometown] does not have to be adjusted.

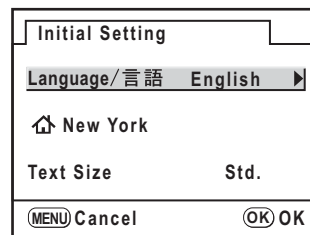

### 3 Press the four-way controller (▼).

The cursor moves to .

### 4 Press the four-way controller (▶).

The [ Hometown] screen appears.

### 5 Use the four-way controller (◀▶) to select the city.

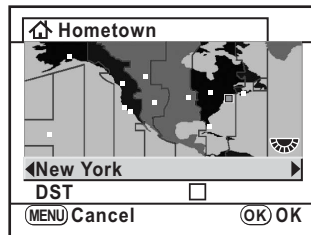

### 6 Press the four-way controller (▼).

The cursor moves to [DST] (daylight saving time).

### 7 Use the four-way controller (◀▶) to select (On) or (Off).

### 8 Press the OK button.

The camera returns to the [Initial Setting] screen.

### 9 Press the four-way controller (▼).

The cursor moves to [Text Size].

### 10 Press the four-way controller (▶) and use the four-way controller (▲▼) to select [Std.] or [Large].

Selecting [Large] magnifies the selected menu item.

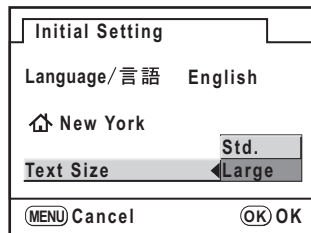

### 11 Press the OK button twice.

The [Date Adjust] screen appears.



In this manual, the menu screens hereafter are described with [Text Size] set to [Std.].

## When an Incorrect Language is Set

When you mistakenly select a language in the [Language/言語] screen and proceed to the [Date Adjust] screen, you can perform the following operations to set the correct language.

If you have proceeded to switch the camera to Capture mode (and the camera is ready to take a picture), perform the following operations from Step 2 to set the correct language.

### 1 Press the MENU button once to display the guides (p.49) on the monitor.

The screen shown on the right is an example of the guides displayed. The displayed screen will vary depending on the selected language.

The guides appear on the monitor for 3 seconds.



### 2 Press the MENU button once.

is displayed in the upper tab. ([ Rec. Mode] menu)

### 3 Press the four-way controller (▶) twice.

is displayed in the upper tab. ([ Set-up] menu)

### 4 Use the four-way controller (▼) to select [Language/言語].

### 5 Press the four-way controller (▶).

The [Language/言語] screen appears.

### 6 Use the four-way controller (▲▼◀▶) to select the desired language and press the OK button.

The [ Set-up] menu for the selected language appears.

Refer to the following pages and set the desired city for [Hometown] and the current date and time as necessary.

- To change Hometown: “Setting the World Time” (p.206)
- To change date and time: “Changing the Date and Time and the Display Style” (p.205)



When [Hometown] and the date and time are not set, the [Initial Setting] screen or [Date Adjust] screen will be displayed when the camera is turned on again.



If you have not proceeded to the [Date Adjust] screen, you can reselect the language using the four-way controller (▶) in the [Language/言語] screen.

## Setting the Date and Time

Set the current date and time and the display style.

- 1 Press the four-way controller (▶).

The frame moves to [mm/dd/yy].

Date Adjust	
Date Style	mm/dd/yy 24h
Date	01 / 01 / 2008
Time	00 : 00
<input type="button" value="MENU"/> Cancel <span style="float: right;"><input type="button" value="OK"/> OK</span>	

- 2 Use the four-way controller (▲ ▼) to choose the date style.

- 3 Press the four-way controller (▶).

The frame moves to [24h].

Date Adjust	
Date Style	mm/dd/yy 24h
Date	01 / 01 / 2008
Time	00 : 00
<input type="button" value="MENU"/> Cancel <span style="float: right;"><input type="button" value="OK"/> OK</span>	

- 4 Use the four-way controller (▲ ▼) to select 24h (24-hour display) or 12h (12-hour display).

- 5 Press the four-way controller (▶).

The frame returns to [Date Style].

- 6 Press the four-way controller (▼).

The frame moves to [Date].

## 7 Press the four-way controller (▶).

The frame moves to the month.

Date Adjust	
Date Style	mm/dd/yy 24h
Date	01 / 01 / 2008
Time	00 : 00
<span>MENU</span> Cancel <span>OK</span> OK	

## 8 Use the four-way controller (▲ ▼) to set the month.

Set the day and year in the same manner.

Next, set the time.

If you select [12h] in Step 4, the setting switches between am and pm depending on the time.

## 9 Press the OK button.

The camera is ready to take a picture.

If you set the date and time with the menu operations, the screen will return to the [Set-up] menu. Press the **OK** button again.



Pressing the **MENU** button while adjusting the date cancels the settings made so far and switches the camera to Capture mode. If the power is turned on without the date and time set, the [Date Adjust] screen is displayed if Initial Setting has been performed. You can also set the date later by menu operations. (p.205)



- When you finish the settings and press the **OK** button, the camera clock is reset to 00 seconds. To set the exact time, press the **OK** button when the time signal (on the TV, radio, etc.) reaches 00 seconds.
- You can change the language and date and time settings with the menu operations. (p.205, p.209)





# 3 Basic Operations

---

This chapter explains basic operations for shooting by setting mode dial to **AUTO PICT** (Auto Picture) to ensure successful capturing.

For information about advanced functions and settings for taking pictures, refer to chapter 4 and onward.

<b>Basic Shooting Operation .....</b>	<b>56</b>
<b>Using a Zoom Lens .....</b>	<b>61</b>
<b>Using the Built-in Flash .....</b>	<b>62</b>
<b>Taking Pictures Using the Shake Reduction Function .....</b>	<b>67</b>
<b>Playing Back Still Pictures .....</b>	<b>70</b>
<b>Deleting Images .....</b>	<b>72</b>

## Holding the Camera

How you hold the camera is important when taking pictures.

- Hold the camera firmly with both hands.
- Press the shutter release button gently when taking a picture.

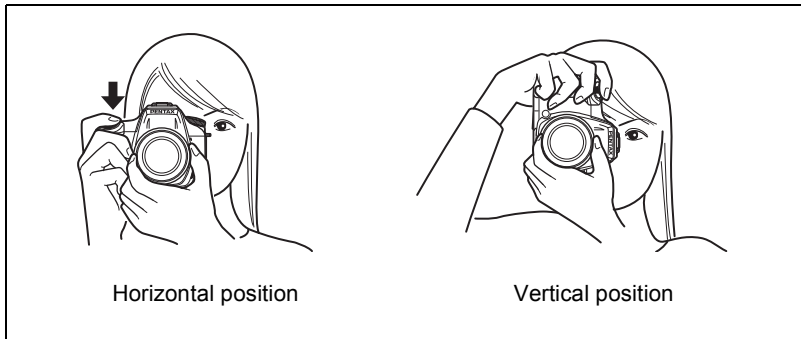

3

Basic Operations



- To reduce camera shake, support your body or the camera on a solid object such as a table, tree, or wall.
- Although there are individual differences among photographers, the shutter speed for a handheld camera is generally  $1/(\text{focal length} \times 1.5)$ . For example, it is  $1/75$  of a second for a focal length of 50 mm and  $1/150$  of a second for 100 mm. Use a tripod or the Shake Reduction function (p.67) when using a lower shutter speed.
- When using a telephoto lens, a tripod that is heavier than the total weight of the camera and lens is recommended to avoid camera shake.
- Do not use the Shake Reduction function when using the camera on a tripod.

## Letting the Camera Choose the Optimal Settings

The **K200D** features various Capture modes, Focus modes, and Drive modes suited for your intentions. This section explains how to take pictures by simply pressing the shutter release button.

### 1 Set the mode dial to **AUTO PICT**.

The camera will select the optimal capture mode for the subject.

☛ Selecting the Appropriate Capture Mode for Scenes (p.78)

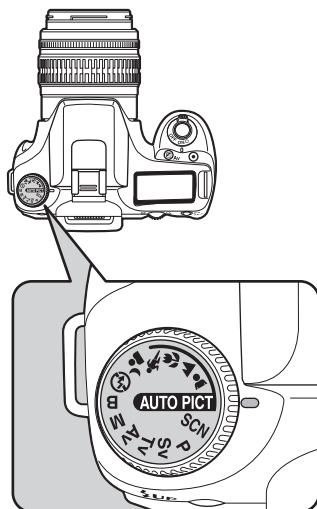

### 2 Set the focus mode lever to **AF**.

The focus mode changes to **AF.S** (Autofocus/Single) mode.

In **AF.S**, the lens automatically focuses when the shutter release button is pressed halfway. When the image is focused, the shutter can be released. (p.102)

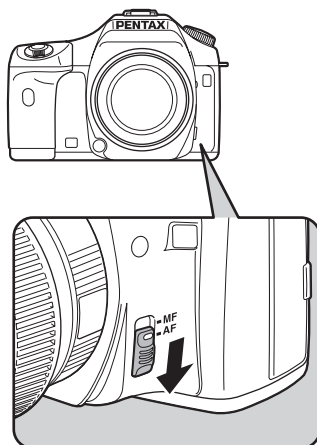

### 3 Look through the viewfinder to view the subject.

A zoom lens can be used to change the size of the subject in the viewfinder.

☞ Using a Zoom Lens (p.61)

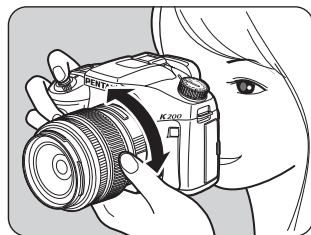

### 4 Position the subject inside the AF frame and press the shutter release button halfway.

The autofocus system operates. The focus indicator  appears in the viewfinder when the subject comes into focus.

When set to **AUTO PICT** (Auto Picture) mode, the optimal capture mode is automatically selected from Portrait, Landscape, Macro, and Moving Object modes or standard settings (Normal mode).

The flash pops up automatically when necessary. (Push the **UP** button and manually lift the flash when Flash mode is not set to [Auto discharge] or [Auto flash+Redeye reduct]).

☞ Operating the shutter release button (p.59)

☞ Subjects that are Difficult to Focus on (p.60)

☞ Using the Built-in Flash (p.62)

☞ Selecting the Focusing Area (AF Point) (p.105)



Flash status

Focus indicator



You can preview the image in the monitor and check the composition, exposure, and focus before taking the picture. (p.112)

### 5 Press the shutter release button fully.

The picture is taken.



## 6 Review the captured image on the monitor.

Image appears for 1 second on the monitor after capturing (Instant Review).

- ☞ Setting the Instant Review (p.211)
- ☞ Histogram Display (p.211)
- ☞ Bright/Dark Area Display (p.211)

You can magnify the image during Instant Review with the e-dial. (p.162)

You can delete the image during Instant Review by pressing the  button.

- ☞ Deleting Images (p.72)

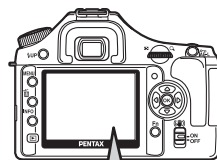

## Operating the shutter release button

The shutter release button has two working positions.

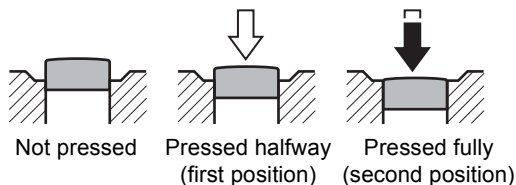

Pressing it down halfway (first position) turns on the viewfinder and LCD panel indicators and the autofocus system operates. Pressing it fully (second position) takes the picture.



- Press the shutter release button gently when taking a picture to prevent camera shake.
- Practice pressing the shutter release button halfway to learn where the first position is.
- The viewfinder indicators stay on while shutter release button is pressed halfway. The indications stay on for about 10 seconds (default setting) while the exposure metering timer is on after the button is released. (p.27, p.99)

## Subjects that are Difficult to Focus on

The autofocus mechanism is not perfect. Focusing may be difficult when taking pictures under the following conditions ((a) to (f) below). These also apply to manual focusing using the focus indicator ● in the viewfinder. If the subject cannot be focused automatically, set the focus mode lever to **MF** and use the manual focus mode to focus on the subject with the aid of the matte field in the viewfinder. (p.110)

- (a) Extremely low-contrast subjects such as a white wall in the focusing area.
- (b) Subjects which do not reflect much light within the focusing area.
- (c) Fast moving objects.
- (d) Strongly reflected light or strong backlighting (bright background).
- (e) If repeating vertical or horizontal line patterns appear within the focusing area.
- (f) Multiple subjects in the foreground and background within the focusing area.



Subject may not be focused even when ● (focus indicator) is displayed when (e) and (f) above apply.

Enlarge the subject (telephoto) or capture a wider area (wide angle) with a zoom lens. Adjust the subject to the desired size and take the picture.

## 1 Turn the zoom ring to the right or left.

Turn the zoom ring clockwise for telephoto and counterclockwise for wide angle.

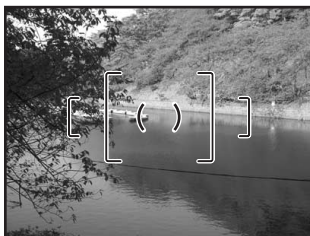
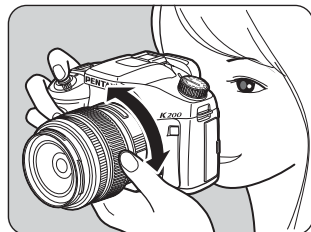

Wide Angle

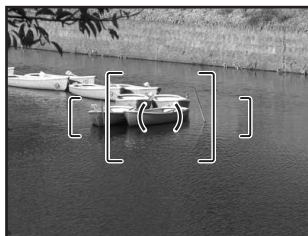

Telephoto



- The smaller the number of the displayed focal length, the wider the angle. The larger the number, the more magnified the image appears.
- Power Zoom functions (Image Size Tracking, Zoom Clip, and Auto Zoom Effect) are not compatible with this camera.

Use the following procedures to take a picture in low light or backlit conditions or when you want to manually use the built-in flash. The built-in flash is optimum at about 0.7 m to 5 m from the subject. Exposure will not be properly controlled and vignetting may occur when used at a distance closer than 0.7 m (this distance varies slightly depending on the lens being used and set sensitivity (p.132)).





### Compatibility of built-in flash and lens

Vignetting (darkening of the corners of the image due to a lack of light) may occur depending on the lens being used and the capture conditions. We recommend taking a test shot to confirm this.

DA, D FA, FA J, FA and F Lens Compatibility with the Built-in Flash (p.133)



- When using the built-in flash, remove the lens hood before shooting.
- The built-in flash fully discharges for lenses without a function to set aperture lens ring to **A** (Auto).

Flash Mode	Function
 Auto discharge	Camera automatically determines ambient light and built-in flash pops up. The flash pops up and discharges automatically when necessary, such as when using a shutter speed likely to cause camera shake or in backlit conditions. The flash may pop up but may not discharge if the camera determines that the flash is not necessary.
 Flash On	Discharges flash manually. Discharges when the flash is popped up, does not discharge when retracted.
 Auto flash+Redeye reduct	Lights a red-eye reduction light before automatic flash.
 Flash On+Red-eye	Discharges flash manually. Lights a red-eye reduction light before discharging the flash.
 Wireless Mode	You can synchronize a dedicated external flash (AF540FGZ or AF360FGZ) without using a sync cord.



## Selecting Flash Mode

- 1 Press the Fn button.

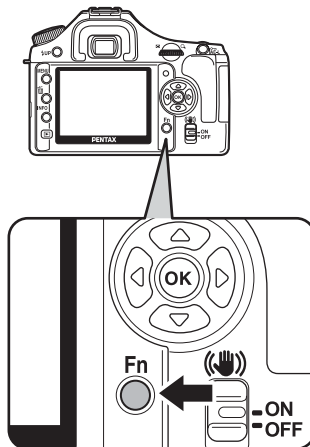

The Fn menu appears.

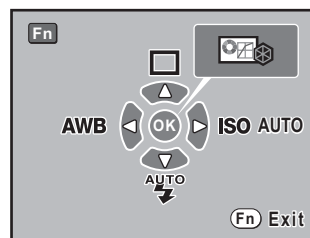

- 2 Press the four-way controller (▼).

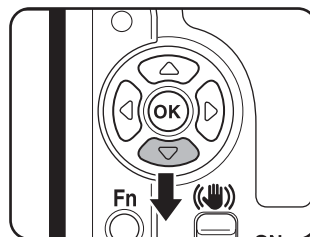

The [Flash Mode] screen appears.

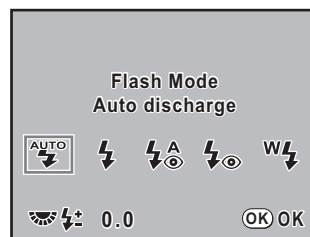

### 3 Use the four-way controller (◀▶) to choose a flash mode.

Turn the e-dial to perform Flash exposure compensation. (p.128)



When the mode dial is set to **P**, **Sv**, **Tv**, **Av**, **M** or **B**, <sup>AUTO</sup>⚡ and ⚡<sup>A</sup> appear gray and cannot be selected.

### 4 Press the OK button.



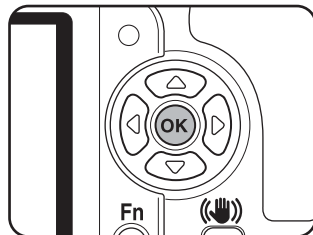

The camera is ready to take a picture.



## Using Auto Discharge <sup>AUTO</sup>⚡, ⚡<sup>A</sup> (Automatic Flash Popup)

### 1 Set the mode dial to SCN, AUTO PICT, , , or .



The flash is deactivated when  (Night Scene),  (Sunset),  (Candlelight) or  (Museum) is selected in **SCN** (Scene) mode.

### 2 Press the shutter release button halfway.

The built-in flash pops up if necessary and begins charging. When the flash is fully charged, ⚡ appears in the LCD panel and viewfinder. (p.27, p.29)

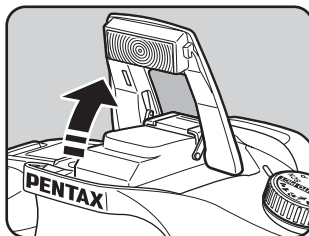

Switch between Auto discharge mode and Flash On mode by pressing the <sup>UP</sup>⚡ button while the built-in flash is popped up. If Auto discharge is set, AUTO appears on the LCD panel.

### 3 Press the shutter release button fully.

The picture is taken.

### 4 Push down on the portion indicated in the illustration to retract the flash.

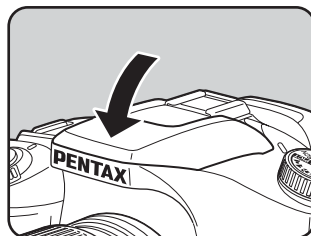

## Using Flash On Mode ⚡, ⚡👁

### 1 Press the ⚡UP button.

The built-in flash pops up and begins charging. Flash On mode is used regardless of the flash mode settings. When the flash is fully charged, ⚡ appears in the LCD panel and viewfinder. (p.27, p.29)

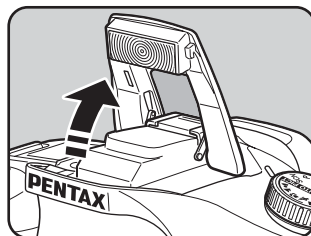
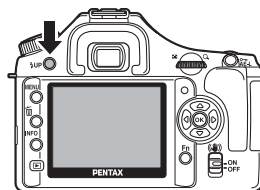

When Flash mode is set to <sup>AUTO</sup>⚡ or ⚡👁 and you pop up the built-in flash, you can switch between Auto discharge mode and Flash On mode by pressing the ⚡UP button under the following conditions.

- Shooting mode is set to **AUTO PICT**, , , , , or .
- SCN mode is set to , , , or .

### 2 Press the shutter release button fully.

The flash discharges and the picture is taken.



### 3 Push the flash down to retract.

## Using Red-eye Reduction Flash

“Red-eye” is the phenomenon where eyes look reddish in photographs taken in dark environments with a flash. This is caused by the reflection of the electronic flash in the retina of the eye. Red-eye occurs because pupils are dilated in dark environments.

This phenomenon cannot be averted but the following measures can be used to combat it.

- Brighten the surroundings when shooting.
- Set to wide angle and move closer to the subject if a zoom lens is in use.
- Use a flash that supports red-eye reduction.
- Position the flash as far away from the camera as possible when using an external flash.

The red-eye reduction function on this camera reduces red-eye by discharging the flash twice. With the red-eye reduction function, the pre-flash is discharged just before the shutter is released. This reduces pupil dilation. The main flash is then discharged while the pupils are smaller, reducing the red-eye effect. To use the red-eye reduction function in Picture mode or **SCN** mode, select  (Auto flash+Redeye reduct) or  (Flash On+Red-eye). Set to  (Flash On+Red-eye) in other modes.

## Daylight-Sync Shooting

In daylight conditions, the flash will eliminate shadows when a portrait picture is taken with a person’s face cast in shadow. Use of the flash in this way is called Daylight-Sync Shooting. Flash On is used when shooting with Daylight-Sync Shooting.

### ● Taking pictures (Auto Picture mode)

- 1 Pop up the flash manually and confirm that the flash mode is set to  (Flash On). (p.65)
- 2 Confirm that the flash is fully charged.
- 3 Take the picture.



The picture may be overexposed if the background is too bright.



Without Daylight-Sync



With Daylight-Sync

# Taking Pictures Using the Shake Reduction Function

You can easily take sharp pictures using the Shake Reduction function by simply turning on the Shake Reduction switch.

## Shake Reduction

The Shake Reduction function reduces camera shake that occurs when the shutter release button is pressed. This is useful for taking pictures in situations where camera shake is likely to occur. The Shake Reduction function allows you to take pictures at approximately 4 steps slower shutter speed without the risk of camera shake.

The Shake Reduction function is ideal when taking pictures in the following situations.

- When taking pictures in dimly lit locations, such as indoors, at night, on cloudy days and in the shade
- When taking telephoto pictures

Blurred picture



Picture taken with the Shake Reduction function



- The Shake Reduction function does not compensate for blurring caused by subject movement. To take pictures of a moving subject, increase the shutter speed.
- The Shake Reduction function may not fully reduce camera shake when taking close-up shots. In this case, it is recommended that the Shake Reduction function be turned off and the camera be used with a tripod.
- The Shake Reduction function will not fully work when shooting with a slower shutter speed, for example when shooting a moving subject or night scenes. In this case, it is recommended that the Shake Reduction function be turned off and the camera be used with a tripod.

## Shake Reduction Function and Lens Focal Length

The Shake Reduction function operates by acquiring the lens information such as focal length.

If the camera uses a DA, D FA, FA J, FA or F lens, the lens information is automatically acquired when the Shake Reduction function is activated.

[Focal Length] cannot be set on the [Input Focal Length] menu in the [📷 Rec. Mode] (The menu items cannot be selected).

If another type of lens is used, the lens information cannot be automatically acquired even when the Shake Reduction function is activated.

In this case, the [Input Focal Length] setting menu appears. Set [Focal Length] manually on the [Input Focal Length] setting menu.

📷 Setting the Shake Reduction Function (p.69)

## Turning On the Shake Reduction Function

### 1 Turn on the Shake Reduction switch.

When the shutter release button is pressed halfway, (⏏) appears in the viewfinder and the Shake Reduction function turns on.

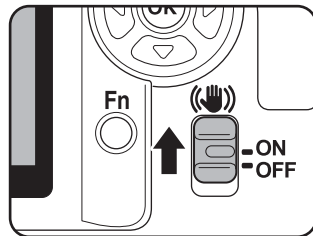

- Be sure to turn off the Shake Reduction switch when using the camera with a tripod.
- The Shake Reduction function automatically turns off in the following situations.  
When using self-timer, 2 sec. self-timer, remote control shooting, remote control (3 sec. delay) shooting, bulb shooting, or wireless mode with an external flash



- If a type of lens that does not support automatic acquisition of lens information such as focal length is used (p.67), the [Input Focal Length] menu appears. Set [Focal Length] manually on the [Input Focal Length] setting menu. Setting the Shake Reduction Function (p.69)
- Turn the Shake Reduction switch off if you will not use the Shake Reduction function.
- The Shake Reduction function will not fully work (for about 2 seconds) right after turning on the camera or restoring from Auto Power Off. Wait for the Shake Reduction function to become stable before gently pressing the shutter release button to take a picture. Press the shutter release button halfway. The camera is ready to take pictures when (⏏) appears in the viewfinder.
- Shake Reduction is available with any **K200D** compatible PENTAX lens. However, when the aperture ring is set at other than the **A** (Auto) position or a lens without an **A** position is used, the camera does not operate unless [23. Using aperture ring] (see p.76; see p.30 - p.31 for operation method) is set to [Permitted] in the [**C** Custom Setting] menu. Set this beforehand. Note that some functions are restricted when [23. Using aperture ring] is set to [Permitted] in the [**C** Custom Setting] menu. Refer to “Notes on [23. Using Aperture Ring]” (p.230) for details.

## Setting the Shake Reduction Function

The [Input Focal Length] setting menu appears when the camera is turned on with the Shake Reduction switch on and a type of lens that does not support automatic acquisition of lens information such as focal length (p.67) is mounted.

Set [Focal Length] manually on the [Input Focal Length] setting menu.



- The [Input Focal Length] setting menu does not appear when using a lens that supports automatic acquisition of lens information such as focal length because [Focal Length] is set automatically.
- When using a lens without the **A** position on the aperture or with the aperture set to a position other than the **A** position, set [23. Using aperture ring] on the [**C** Custom Setting] (p.76) menu to [Permitted].

1

### Use the four-way controller (◀▶) or the e-dial to set [Focal Length].

Select from the following 34 focal length values. (The default setting is 35.)

8	10	12	15	18	20	24	28	30	35
40	45	50	55	65	70	75	85	100	120
135	150	180	200	250	300	350	400	450	500
550	600	700	800						

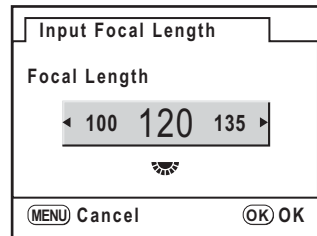

- If the focal length for your lens is not listed above, select the value closest to the actual focal length (example: [18] for 17 mm and [100] for 105 mm).
- When using a zoom lens, select the actual focal length at the zoom setting in the same manner.
- Effect of Shake Reduction is influenced by the shooting distance as well as focal length information. The Shake Reduction function may not perform as expected when shooting at close ranges.

2

### Press the OK button.

The camera is ready to take a picture.



To change the Focal Length setting, use [Input Focal Length] on the [**📷** Rec. Mode] menu (p.74).

## Playing Back Images

You can play back captured still pictures with the camera.



Use the included “PENTAX PHOTO Browser 3” software to play back using a PC. Refer to the “PENTAX PHOTO Browser 3/PENTAX PHOTO Laboratory 3 Operating Manual” for details.

3

Basic Operations

### 1 Press the button after taking a picture.

The most recently captured image (image with the largest file number) is displayed on the monitor.

Press the **INFO** button during playback to switch the information display such as the image data for the displayed image.

Refer to p.25 - p.26 for display information details.

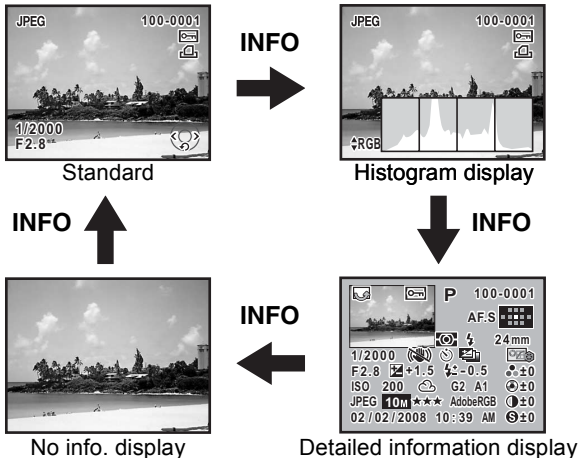
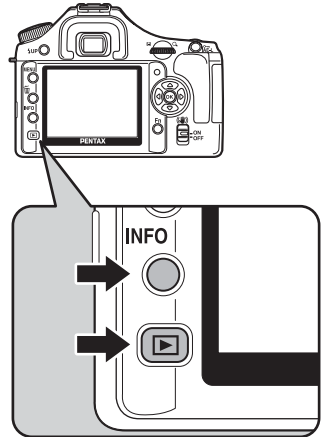



## 2 Press the four-way controller (◀▶).

- ◀ : The previous image appears.
- ▶ : The next image appears.

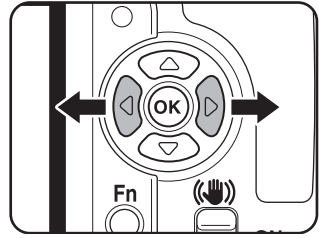

Refer to “Playback Functions” (p.157) for playback mode details.

## Deleting a Single Image

You can delete one image at a time.



- Deleted images cannot be restored.
- Protected images cannot be deleted.

3

Basic Operations

**1** Press the button and use the four-way controller (◀▶) to select an image to delete.

**2** Press the button.

The Delete screen appears.

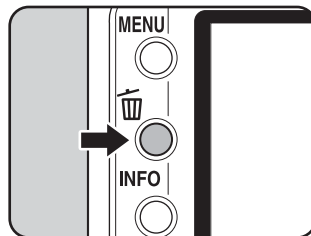

**3** Use the four-way controller (▲▼) to select [Delete].

Select the file format to delete for images saved in RAW+ format.

Delete JPEG	Deletes only the JPEG image.
Delete RAW	Deletes only the RAW image.
Delete RAW+JPEG	Deletes both file formats.



**4** Press the **OK** button.

The image is deleted.



When deleting multiple images, refer to “Deleting Multiple Images” (p.173).

# 4 Shooting Functions

---

This chapter describes the various basic and advanced shooting functions available with the *K200D*.

<b>How to Operate the Shooting Menus .....</b>	<b>74</b>
<b>Selecting the Appropriate Capture Mode for Scenes .....</b>	<b>78</b>
<b>Setting the Exposure .....</b>	<b>81</b>
<b>Focusing .....</b>	<b>102</b>
<b>Checking the Composition, Exposure and Focus Before Shooting .....</b>	<b>112</b>
<b>Continuous Shooting .....</b>	<b>115</b>
<b>Self-Timer Shooting .....</b>	<b>117</b>
<b>Remote Control Shooting (Remote Control F: Sold Separately) .....</b>	<b>120</b>
<b>Using Mirror Up Function to Prevent Camera Shake .....</b>	<b>123</b>
<b>Changing the Shooting Conditions Automatically when Shooting (Auto Bracket) .....</b>	<b>124</b>

Press the **MENU** button in Capture mode. The [📷 Rec. Mode] menu appears.

## [📷 Rec. Mode] Menu Setting Items

Perform settings related to capturing in the [📷 Rec. Mode] menu.

Item	Function	Page
AF Mode	Selects the autofocus mode.	p.104
AE Metering	Selects the part of the screen to use for measuring brightness and determining exposure.	p.98
Select AF point	Selects the part of the screen to focus on.	p.105
File Format	Sets the file format.	p.148
JPEG Recorded Pixels	Sets the recording size of images for JPEG shooting.	p.146
JPEG Quality	Sets the image quality for JPEG shooting.	p.147
RAW file format	Sets the file format for RAW shooting.	p.148
Color Space	Sets the color space to use.	p.155
<b>RAW</b> button	Sets the <b>RAW</b> button function.	p.149
Memory	Sets the settings to save when the power is turned off.	p.217
Input Focal Length	Sets the focal length when using a lens for which focal length information cannot be acquired.	p.69

## [C Custom Setting] Menu Setting Items

Set custom functions to fully use the functions of a SLR camera with the Custom Setting Menu. The default setting does not change custom function.

The [C Custom Setting] menu settings are activated when [Setting], the first item, is  (On).

Item	Function	Page
Setting	Sets to change custom function.	-
1. EV Steps	Sets the adjustment steps for exposure.	p.101
2. Sensitivity Steps	Sets the adjustment steps for ISO sensitivity.	p.83
3. Meter Operating Time	Sets the exposure metering time.	p.99
4. <b>AE-L</b> with AF locked	Sets whether to lock the exposure value when the focus is locked.	p.108
5. Link AF Point and AE	Sets whether to link the exposure and AF point in the focusing area during multi-segment metering.	p.99
6. Auto Bracketing order	Sets the order for Auto bracket shooting.	p.124
7. Adjust White Balance	Enables fine tuning the white balance.	p.154
8. Superimpose AF Area	Sets whether to display the selected AF point (focus position) in the viewfinder.	p.105
9. AF in remote control	Sets whether to use Autofocus when shooting with remote control. Shutter releases after AF activates if shutter is released from remote control when set to [On]. Shutter cannot be released until in focus. AF does not activate at shutter release from remote control when set to [Off].	p.121
10. Slow Shutter Speed NR	Sets whether to use Noise Reduction in slow speed shooting.	p.85
11. High-ISO Noise Reduction	Sets whether to use Noise Reduction when shooting with a high ISO. Select from three levels.	p.85
12. <b>OK</b> button when shooting	Sets the action for the <b>OK</b> button when pressed during shooting.	p.103
13. e-dial in Program	Sets the e-dial in <b>P</b> (Program) mode.	p.88

Item	Function	Page
14. Green button in Manual	Selects the exposure adjustment method when the Green button is pressed in <b>M</b> (Manual) mode.	p.96
15. Release when Charging	Sets to release shutter while the built-in flash is charging.	p.129
16. Flash in Wireless Mode	Sets the built-in flash discharge method in wireless mode.	p.138
17. WB when using flash	Sets whether to change the White Balance setting when using flash to [Flash].	p.151
18. Preview Method	Sets Preview Method when the main switch is turned to the preview position (⌚).	p.112
19. Display Sensitivity	Sets whether to switch the number of recordable images in the LCD panel and viewfinder to the sensitivity display.	-
20. Saving rotation info	Sets whether to save rotation information when shooting.	-
21. Auto Image Rotation	Sets to automatically rotate images when playing back.	-
22. Catch-in focus	When set to [On], if the focus mode is set to <b>AF.S</b> and a manual focus lens is attached, catch-in focus shooting is possible and the shutter is released automatically when the subject comes into focus.	p.111
23. Using aperture ring	Sets to enable shutter release when lens aperture ring is set at other than the <b>A</b> position.	p.230
Reset Custom Function	Resets all the settings in the [ <b>C</b> Custom Setting] menu to the defaults.	p.221

## Shooting Fn Menu Setting Items



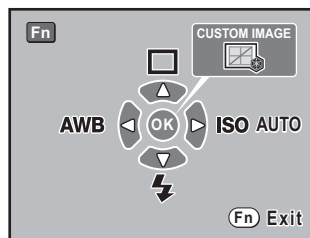



Press the **Fn** button in Capture mode. The Fn menu appears.



Press the four-way controller (**▲▼◀▶**) or the **OK** button to set the operation.





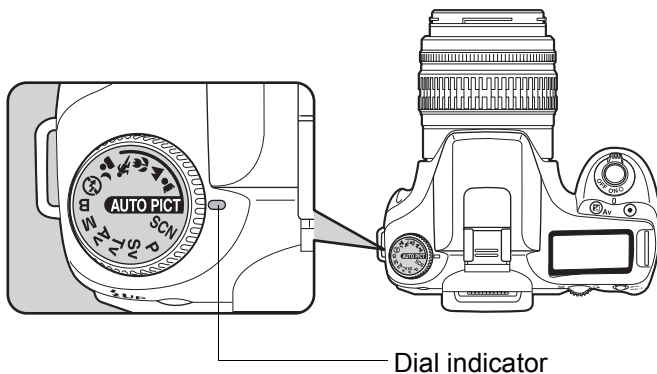

Key or Button	Item	Function	Page
<b>▲</b>	Drive Mode	Selects Continuous shooting, Self-timer, Remote control or Auto Bracket shooting.	p.115 p.117 p.120 p.124
<b>▼</b>	Flash Mode	Adjusts the method of flash discharge.	p.63
<b>◀</b>	White Balance	Adjusts the color balance to match the type of the light source illuminating the subject.	p.150
<b>▶</b>	Sensitivity	Sets the sensitivity.	p.83
<b>OK</b>	Custom Image	Sets image processing.	p.144

# Selecting the Appropriate Capture Mode for Scenes

Select  (Portrait),  (Landscape),  (Macro),  (Moving Object),  (Night Scene Portrait),  (Flash OFF), **SCN** (Scene) with the mode dial if desired image is not captured in **AUTO PICT** (Auto Picture) mode.

The characteristics of the modes are as follows.



Mode	Characteristics
<b>AUTO PICT</b> (Auto Picture)	The optimal capture mode is automatically selected from Portrait, Landscape, Macro and Moving Object modes or standard settings (Normal mode).
 (Portrait)	Optimal for capturing portraits.
 (Landscape)	Deepens the focus range, emphasizes contour and saturation of trees and the sky, and produces a bright image.
 (Macro)	Lets you take vibrant pictures of flowers and other small subjects at short distances.
 (Moving Object)	Lets you take sharp pictures of a quickly moving subject, such as at a sporting event.
 (Night Scene Portrait)	Lets you capture people against a night view or at dusk.
 (Flash OFF)	The flash is deactivated. Other settings are the same as the Normal mode in <b>AUTO PICT</b> .
<b>SCN</b> (Scene)	Lets you select from 8 shooting scenes depending on the shooting conditions.











For  (Night Scene Portrait), the shutter speed becomes slower in dark places, even if the built-in flash is used. To prevent camera shake, either use the Shake Reduction function or mount the camera on a tripod.







## Selecting the Shooting Scene

By setting the mode dial to **SCN** (Scene), you can choose from the following 8 shooting scenes.

Mode	Characteristics
 (Night Scene)	Used for night scenes. Use a tripod, etc. to prevent shaking.
 (Surf & Snow)	For capturing images of dazzling backgrounds, such as snowy mountains.
 (Food)	For capturing images of food. Saturation will be rather high to make it look appetizing.
 (Sunset)	For capturing the sunrise or sunset in beautiful colors.
 (Kids)	For capturing moving kids. Reproduces healthy and bright skin tone.
 (Pet)	For capturing moving pets.
 (Candlelight)	For capturing scenes in candlelight.
 (Museum)	For capturing images in places where a flash is prohibited.



The flash is deactivated in  (Night Scene),  (Sunset),  (Candlelight) and  (Museum) modes. To prevent camera shake, either use the Shake Reduction function or mount the camera on a tripod.

### How to Select a Shooting Scene

- 1 Set the mode dial to **SCN** (Scene).
- 2 Press the **Fn** button.

The Fn menu appears. The icon for the currently selected shooting scene appears in the Fn menu screen in **SCN** (Scene) mode.

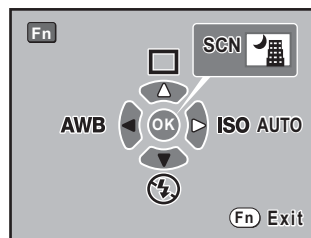

### 3 Press the OK button.

The mode palette appears.

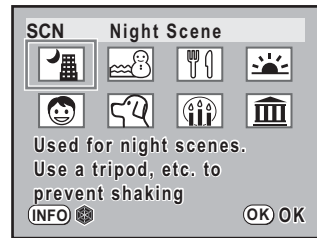

### 4 Use the four-way controller (▲▼◀▶) to choose a Scene mode.

Press the **INFO** button to display the custom image and use the four-way controller (◀▶) to change the scene. Settings, such as those for Image Tone, cannot be changed.

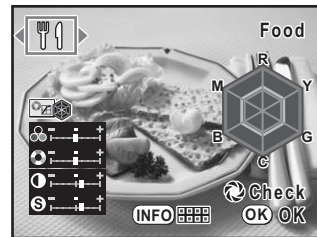

### 5 Press the OK button.

The camera is ready to take a picture.



Set [Scene Display] in [Memory] to  (On) to display the picture in Step 3 in the format last used (mode palette or custom image). Refer to "Selecting Capture Mode Settings to Save in the Camera" (p.217) for details.

## Effect of Aperture and Shutter Speed

Correct exposure of the subject is determined by the combination of shutter speed and aperture setting. There are many correct combinations of shutter speed and aperture for a particular subject. Different combinations produce different effects.

### Effect of Shutter Speed

The shutter speed determines the length of time that light is allowed to strike the CCD.

- **Using slower shutter speed**

If the subject is moving, the image will be blurred because the shutter is open longer.

It is possible to enhance the effect of motion (rivers, waterfalls, waves, etc.) by intentionally using a slower shutter speed.

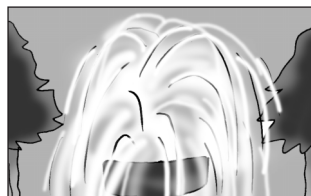

- **Using faster shutter speed**

Choosing a faster shutter speed will allow freezing the action of a moving subject.

A faster shutter speed also helps preventing camera shake.

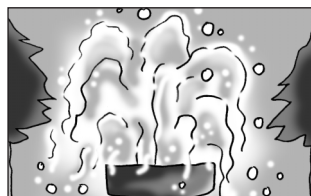

## Effect of Aperture

Adjust the amount of light hitting the CCD by changing the aperture.

### ● Opening the aperture (reduce the aperture value)

Objects closer and farther than the focused subject will be more out of focus. For instance, if you take a picture of a flower against a landscape with the aperture open, the landscape in front and behind the flower will be blurred, emphasizing only the flower.

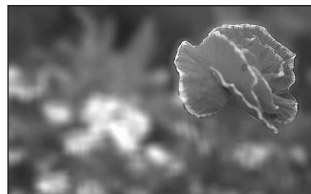

### ● Closing the aperture (increase the aperture value)

The range in focus expands forward and backward. For instance, if you take a picture of a flower against a landscape with the aperture narrowed, the landscape in front and behind the flower will be in focus.



## Depth of Field

When you focus on a portion of the subject, there is a range in which both objects closer and farther will also be in focus. This focused range is called the depth of field.

- The depth of field for the **K200D** differs depending on the lens but compared to a 35 mm camera, the value is roughly one aperture setting lower (the focused range becomes narrower).
- The wider the wide-angle lens, and the farther away the subject, the deeper the depth of field is (some zoom lenses do not have a scale for depth of field because of their designs).

Depth of field	Shallow	←————→	Deep
Area of focus	Narrow	←————→	Wide
Aperture	Open (Smaller value)	←————→	Close (Larger value)
Lens focal length	Longer (Telephoto)	←————→	Shorter (Wide-angle)
Distance to the subject	Near	←————→	Far

## Setting the Sensitivity

You can set the sensitivity to suit the brightness of the surroundings. The sensitivity can be set to [AUTO] or within a sensitivity range equivalent to ISO 100 to 1600. The default setting is [AUTO].

Set [Sensitivity] in the Fn menu. (p.77)

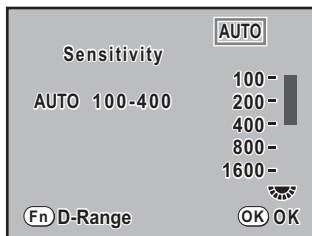

- [Sensitivity] in the Fn menu cannot be used to set the sensitivity when the exposure mode is set to **Sv** (Sensitivity Priority). Turn the e-dial in Capture mode to make the setting. (p.88)
- Captured images can show more noise if a higher sensitivity is set. You can reduce image noise by setting [11. High-ISO Noise Reduction] in the [C Custom Setting] menu. (p.85)
- You can set whether to lock the ISO sensitivity adjustment to increments of 1 EV or to coordinate it with the EV Steps (p.101) in [2. Sensitivity Steps] in the [C Custom Setting] menu (p.75).

## Setting the Range of Automatic Correction in AUTO

Set range to automatically correct sensitivity when Sensitivity is set to [AUTO]. The sensitivity is automatically corrected in the range of [ISO 100-400] by default.

Turn the e-dial to set the upper sensitivity limit in [Sensitivity] in the Fn menu.



When the exposure mode is set to **M** (Manual) or **B** (Bulb), the sensitivity cannot be set to [AUTO].

## Checking the Sensitivity in Capture Mode

Press the **OK** button in Capture mode. The set sensitivity is displayed on the LCD panel and in the viewfinder.



You can display the number of recordable images by pressing the **OK** button when the exposure mode is set to **Sv** (Sensitivity Priority).

## Expanding the Dynamic Range

Dynamic range is the ratio that indicates the light level expressed by the CCD pixels from bright areas to dark areas.

By using the Expand Dynamic Range function, you can expand the light level expressed by the CCD pixels, making it more difficult for bright areas to occur in the image.

Press the **Fn** button for the [Sensitivity] setting in the Fn menu to turn this function on or off.

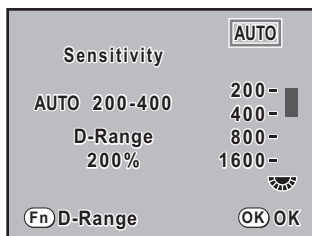

When the dynamic range is expanded, the sensitivity range is reduced to ISO 200 to 1600.

## Noise Reduction

When you use a digital camera to shoot with a long exposure or high sensitivity setting, image noise (image roughness or unevenness) becomes noticeable.

You can reduce image noise by using Noise Reduction. Images shot with Noise Reduction take longer to save.

### ● Slow Shutter Speed NR

Reduces noise during long exposures.

Select from [On] or [Off] for [10. Slow Shutter Speed NR] in the [C Custom Setting] menu (p.75).

### ● High-ISO Noise Reduction

Reduces noise at high sensitivity (ISO) settings.

Select from [Off], [Weakest], [Weak], or [Strong] for [11. High-ISO Noise Reduction] in the [C Custom Setting] menu (p.75).

## Changing the Exposure Mode

This camera features the following six exposure modes.

Use the mode dial (p.32) to change the exposure mode. The settings available for each exposure mode are as follows.

Exposure Mode	Description	EV Compensation	Change Shutter Speed	Change Aperture	Change Sensitivity	Page
<b>P</b> (Program)	Automatically sets shutter speed and aperture to the proper exposure according to Program line when taking pictures.	Yes	#*	#*	Yes	p.86
<b>Sv</b> (Sensitivity Priority)	Automatically sets the shutter speed and aperture to the proper exposure according to the set sensitivity.	Yes	No	No	Other than Auto	p.88
<b>Tv</b> (Shutter Priority)	Lets you set the desired shutter speed for expressing moving subjects.	Yes	Yes	No	Yes	p.90

Exposure Mode	Description	EV Compensation	Change Shutter Speed	Change Aperture	Change Sensitivity	Page
<b>Av</b> (Aperture Priority)	Lets you set aperture for controlling the depth of field.	Yes	No	Yes	Yes	p.92
<b>M</b> (Manual)	Lets you set shutter speed and aperture to capture the picture with creative intent.	No	Yes	Yes	Other than Auto	p.94
<b>B</b> (Bulb)	Lets you capture images that require slow shutter speeds such as fireworks and night scenes.	No	By user's action	Yes	Other than Auto	p.97

\* In [13. e-dial in Program] in the [**C** Custom Setting] menu, you can set to change either the shutter speed or aperture when the e-dial is turned.

## Using the P (Program) Mode

Automatically sets shutter speed and aperture to the proper exposure according to Program line when taking pictures.

Use the e-dial to change the shutter speed or aperture while maintaining the proper exposure (Hyper-program) (p.88).

### 1 Set the mode dial to P.

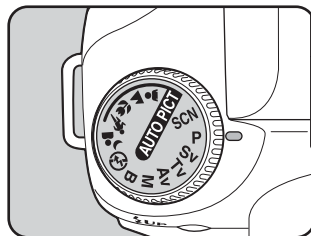



- 2** Turn the e-dial while pressing the  Av button and adjust the exposure.

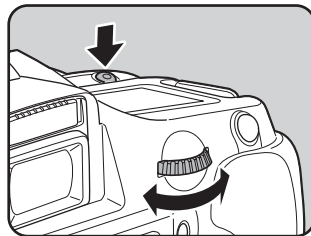

EV Compensation

The EV Compensation is displayed in the viewfinder and on the LCD panel.

The shutter speed and aperture value are also displayed while adjusting the exposure.



- Set EV Compensation in increments of 1/2 EV or 1/3 EV. Set in [1. EV Steps] in the [C Custom Setting] menu. (p.101)
- You can automatically correct the sensitivity if appropriate exposure cannot be set with the set criteria. Set [Sensitivity] to [AUTO] in the Fn menu. (p.83)
- When using a lens with an aperture ring, set the aperture to the **A** position while holding down the auto-lock button on the lens.

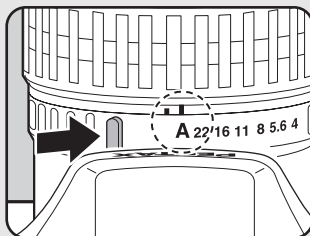

## P (Program) mode and e-dial

You can set the action for the e-dial when turned in **P** (Program) mode. Set in [13. e-dial in Program] in the [**C** Custom Setting] menu.

1	Program shift	Automatically adjusts the aperture value and shutter speed in order to obtain the appropriate exposure. <ul style="list-style-type: none"> <li>• Press the Green button to return to Program Automatic Exposure.</li> </ul>
2	<b>Tv</b>	Switches to Shutter Priority Automatic Exposure when the e-dial is turned. <ul style="list-style-type: none"> <li>• You can set a shutter speed to a value that will give a correct exposure with the aperture range of the lens being used.</li> <li>• If the brightness changes and the aperture value is outside the relative range, the aperture value will blink in the viewfinder and on the LCD panel.</li> <li>• When a picture is taken with <b>Tv</b> shift, <b>Tv</b> is displayed for the exposure mode in the image information.</li> <li>• Press the Green button to return to Program Automatic Exposure.</li> </ul>
3	<b>Av</b>	Switches to Aperture Priority Automatic Exposure when the e-dial is turned. <ul style="list-style-type: none"> <li>• You can set the aperture to a value that will give a correct exposure within the range of available shutter speeds.</li> <li>• If the brightness changes and the shutter speed is outside the relative range, the shutter speed will blink in the viewfinder and on the LCD panel.</li> <li>• When a picture is taken with <b>Av</b> shift, <b>Av</b> is displayed for the exposure mode in the image information.</li> <li>• Press the Green button to return to Program Automatic Exposure.</li> </ul>
4	Off	Disables e-dial operation while Program Automatic Exposure is set.

## Using the Sv (Sensitivity Priority) Mode

You can set the sensitivity to suit the brightness of the subject. The shutter speed and aperture are automatically set according to the selected sensitivity to obtain the appropriate exposure.

# 1 Set the mode dial to Sv.

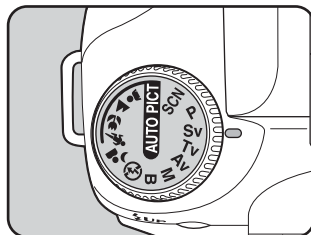

# 2 Turn the e-dial and adjust the sensitivity.

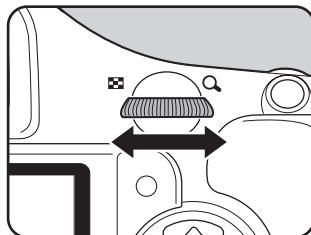

The shutter speed, aperture value and sensitivity are displayed in the viewfinder and on the LCD panel.



- You can set the sensitivity to values equivalent to ISO 100 to 1600. [AUTO] is not available.
- Turn the e-dial while pressing the  **Av** button to change the EV compensation value. (p.100)
- Set the sensitivity in increments of 1/2 EV or 1/3 EV. Set in [1. EV Steps] in the [C Custom Setting] menu. (p.101)
- You cannot set the sensitivity in [Sensitivity] in the Fn menu.
- When using a lens with an aperture ring, set the aperture to the **A** position while holding down the auto-lock button on the lens.

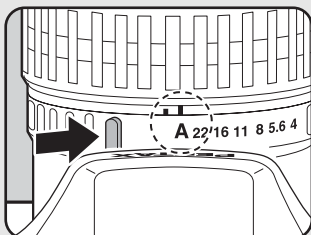

## Using the Tv (Shutter Priority) Mode

Lets you set the desired shutter speed for expressing moving subjects. When taking pictures of a fast moving subject, you can increase the shutter speed to make the subject look still or decrease the shutter speed to have the subject show movement.

Aperture value is automatically set to give the appropriate exposure depending on the shutter speed.

☞ Effect of Aperture and Shutter Speed (p.81)

### 1 Set the mode dial to Tv.

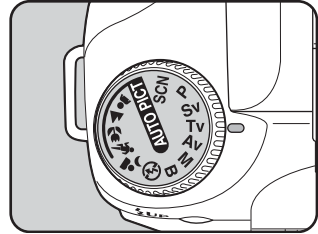

### 2 Turn the e-dial and adjust the shutter speed.

The shutter speed can be set within the range of 1/4000 to 30 seconds.

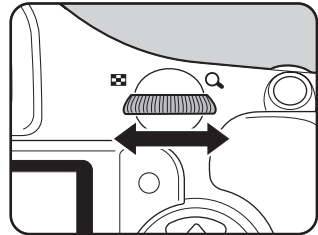

The shutter speed and aperture value are displayed in the viewfinder and on the LCD panel.





- Turn the e-dial while pressing the **Av** button to change the EV compensation value. (p.100)
- Set the shutter speed in increments of 1/2 EV or 1/3 EV. Set in [1. EV Steps] in the [**C** Custom Setting] menu. (p.101)
- You can automatically correct the sensitivity if appropriate exposure cannot be set with the set criteria. Set [Sensitivity] to [AUTO] in the Fn menu. (p.83)
- When using a lens with an aperture ring, set the aperture to the **A** position while holding down the auto-lock button on the lens.

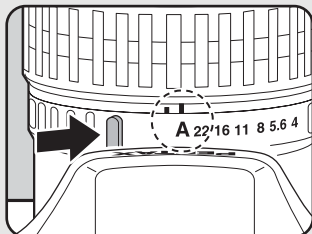

## Exposure Warning

If the subject is too bright or too dark, the aperture value will blink in the viewfinder and on the LCD panel. If the subject is too bright, choose a faster shutter speed. If it is too dark, choose a slower shutter speed. When the aperture value indication stops blinking, you can take the picture with proper exposure.

Use an ND (Neutral Density) filter if the subject is too bright. Use a flash if it is too dark.







- Turn the e-dial while pressing the **Av** button to change the EV compensation value. (p.100)
- Set the aperture value in increments of 1/2 EV or 1/3 EV. Set in [1. EV Steps] in the [**C** Custom Setting] menu. (p.101)
- You can automatically correct the sensitivity if appropriate exposure cannot be set with the set criteria. Set [Sensitivity] to [AUTO] in the Fn menu. (p.83)
- When using a lens with an aperture ring, set the aperture to the **A** position while holding down the auto-lock button on the lens.

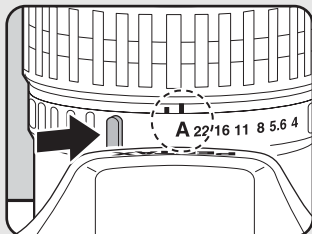

## Exposure Warning

If the subject is too bright or too dark, the shutter speed will blink in the viewfinder and on the LCD panel. If the subject is too bright, set the aperture smaller (larger number), and

when too dark, open the aperture further (smaller number). Once blinking stops, you can take the picture with the proper exposure.

Use an ND (Neutral Density) filter if the subject is too bright. Use a flash if it is too dark.



## Using M (Manual) Mode

You can set the shutter speed and aperture value. This mode is suitable to take pictures of your choice by combining them. This mode is convenient for taking pictures using the same combination of the shutter speed and aperture settings or taking intentionally underexposed (darker) or over-exposed (brighter) photographs.

☞ Effect of Aperture and Shutter Speed (p.81)

### 1 Set the mode dial to M.

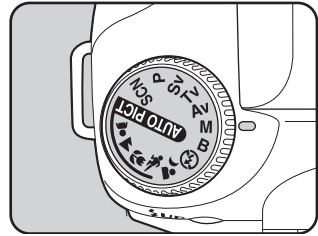

### 2 Turn the e-dial and adjust the shutter speed.

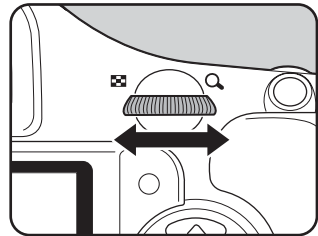

### 3 Turn the e-dial while pressing the $\square$ Av button and adjust the aperture.

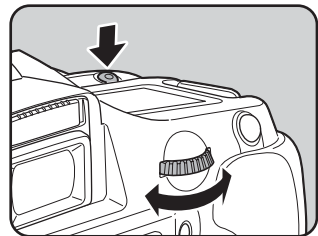



The shutter speed and aperture value are displayed in the viewfinder and on the LCD panel. Of the shutter speed and aperture value, the value being adjusted is underlined in the viewfinder. While adjusting the shutter speed or aperture value, the difference from the appropriate exposure (EV value) appears in the viewfinder. The appropriate exposure is set when [0.0] is displayed.



Difference from the appropriate exposure

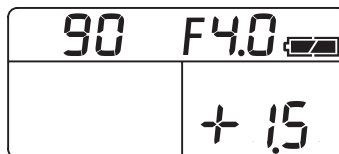

- When the sensitivity is set to [AUTO] and exposure mode is set to **M** (Manual) mode, the sensitivity is set to a value equivalent to ISO 100 if the Dynamic Range is set to [Off] and ISO 200 if set to [On].
- Set the shutter speed and aperture values in increments of 1/2 EV or 1/3 EV. Set in [1. EV Steps] in the [**C** Custom Setting] menu. (p.101)
- When using a lens with an aperture ring, set the aperture to the **A** position while holding down the auto-lock button on the lens.

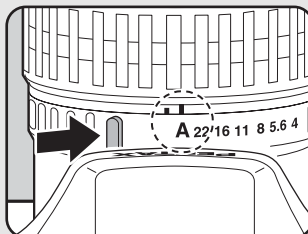

## Exposure Warning

While adjusting the shutter speed or aperture value, the difference from the appropriate exposure blinks when it becomes larger than  $\pm 3.0$ .



## Combining with AE-L

Press the **AE-L** button (p.101) to record the exposure value in **M** (Manual) mode. If the shutter speed or aperture is then changed, the combination of shutter speed and aperture changes while exposure is retained.

Example: If the shutter speed is 1/125 sec and aperture is F5.6 and is recorded with the **AE-L** button, and the shutter speed is changed to 1/30 sec with the e-dial, the aperture automatically changes to F11.

## About the Green Button

The aperture and shutter speed are automatically adjusted to the appropriate exposure at that moment if the Green button is pressed in **M** (Manual) mode. You can set the adjustment methods in [14. Green button in Manual] in the [**C** Custom Setting] menu.

1	Program Line	The aperture and shutter speed are adjusted automatically.
2	Tv Shift	The aperture is locked and the shutter speed is adjusted automatically.
3	Av Shift	The shutter speed is locked and the aperture is adjusted automatically.
4	Off	Disables Green button operation while Manual Exposure is set.

Shutter speed is adjusted to appropriate exposure according to lens aperture when lens aperture is not set to **A** position.

 Notes on [23. Using Aperture Ring] (p.230)

## Using the **B** (Bulb) Mode

This mode is useful for the long exposures required for shooting night scenes and fireworks.

The shutter remains open as long as the shutter release button is kept pressed.

### 1 Set the mode dial to **B**.









EV compensation, Continuous shooting and Exposure Bracket are not available in **B** (Bulb) mode.



- Turn the e-dial to adjust the aperture value.
- Set the aperture value in increments of 1/2 EV or 1/3 EV. Set in [1. EV Steps] in the [**C** Custom Setting] menu. (p.101)
- The Shake Reduction function is automatically turned off when exposure mode is set to **B** (Bulb) mode.
- Use a sturdy tripod and the cable switch CS-205 (optional) to prevent camera shake when using **B** (Bulb) mode. Connect the cable switch to the cable switch terminal (p.17).
- Bulb shooting is available when using the remote control shooting mode (p.120). The shutter remains open as long as the shutter release button of the optional remote control is held down.
- Noise reduction is a process to reduce noise (image roughness or unevenness) caused by slow shutter speed. Set in [10. Slow Shutter Speed NR] in the [**C** Custom Setting] menu. (p.85)
- When the sensitivity is set to [AUTO] and exposure mode is set to **B** (Bulb) mode, the sensitivity is set to a value equivalent to ISO 100 if the Dynamic Range is set to [Off] and ISO 200 if set to [On].

## Selecting the Metering Method

Choose the part of the screen to use for measuring brightness and determining exposure.  (Multi-segment metering),  (Center-weighted metering) or  (Spot metering) mode can be selected. The default setting is  (Multi-segment metering).

	Multi-segment	Segments the viewfinder in 16 parts, meters each portion and determines the appropriate exposure.
	Center-weighted	Measures the entire viewfinder with an emphasis on the center and determines the exposure.
	Spot Metering	Measures only the center of the viewfinder and determines exposure.

Set in [AE Metering] in the [ Rec. Mode] menu (p.74).

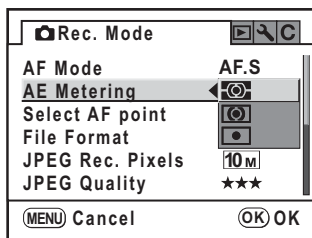

## Using the Multi-Segment Metering

The scene in the viewfinder is metered in 16 different zones as shown in the illustration when using the multi-segment metering. Even in backlit locations, this mode automatically determines what level of brightness is in which portion and automatically adjusts exposure.

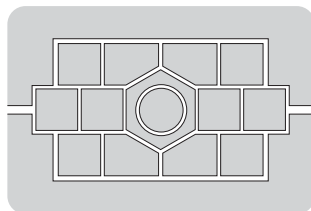

Multi-segment metering mode is not available when using a lens other than a DA, D FA, FA J, FA, F or A lens, or when lens aperture ring is set at other than **A**.

## Linking AF Point and AE During Multi-Segment Metering

In [5. Link AF Point and AE] of the [C Custom Setting] menu (p.75), you can link the exposure and AF point in the focusing area during multi-segment metering. The default setting is [Off].

1	Off	Exposure is set separately from AF point.
2	On	Exposure is set in accordance with AF point.

## Using the Center-Weighted Metering

Metering is weighted at the center of the screen. Use this metering when you want to compensate the exposure by experience, instead of leaving it to the camera. The illustration shows that sensitivity increases as the pattern height increases (center). This mode does not automatically compensate for backlit scenes.

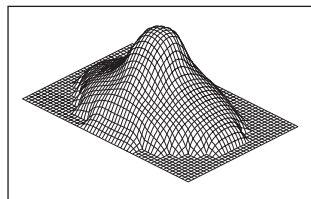

## Using the Spot Metering

With spot metering, brightness is measured only within a limited area at the center of the screen as shown in the illustration. You can use this in combination with the AE lock (p.101) when the subject is extremely small and proper exposure is difficult to obtain.

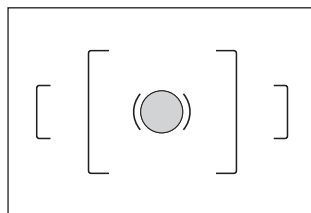

## Setting the Meter Operating Time

Sets the exposure metering time in [3. Meter Operating Time] in the [C Custom Setting] menu (p.75). The default setting is [10 sec].

1	10 sec	Sets exposure metering timer to 10 seconds.
2	3 sec	Sets exposure metering timer to 3 seconds.
3	30 sec	Sets exposure metering timer to 30 seconds.

## Adjusting the Exposure

This allows you to deliberately overexpose (brighten) or under-expose (darken) your picture.

Select 1/2 EV or 1/3 EV in [1. EV Steps] in the [**C** Custom Setting] menu. You can adjust the EV compensation from -2 to +2 (EV).

- 1 **Set the compensation by turning the e-dial while the  Av button is pressed.**

 Av button

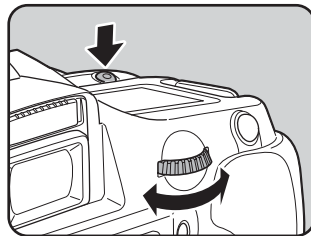

 is displayed in the viewfinder and on the LCD panel during compensation.

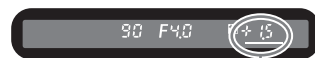

Compensation value

Press the  **Av** button to confirm the compensation value on the LCD panel.

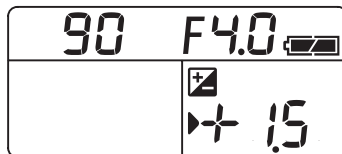

Exposure compensation is not available when the exposure mode is set to **M** (Manual) or **B** (Bulb) mode.



- The EV compensation cannot be canceled by turning the camera off or by setting any other exposure mode.
- The EV compensation value is reset to [0] when the Green button is pressed while the  **Av** button is pressed.

## Changing the Exposure Steps

Set Exposure Steps in [1. EV Steps] in the [**C** Custom Setting] menu to increments of 1/2 EV or 1/3 EV.

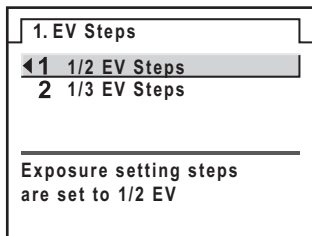

## Recording the Exposure Before Shooting (AE Lock)

AE Lock is a function that memorizes the exposure prior to taking the picture. Use this when the subject is too small or backlit and a proper exposure setting cannot be obtained.

### 1 Press the **AE-L** button.

The camera memorizes the exposure (brightness) at that instant. Press it again to unlock.

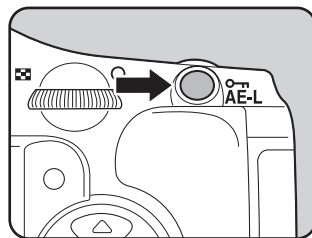

- **\*** is displayed in the viewfinder while the AE lock is engaged. (p.27)
- The exposure remains locked as long as the **AE-L** button is kept pressed or the shutter release button is kept pressed halfway. The exposure remains in memory for a period between 0.5× to 2× the metering timer after releasing the **AE-L** button.
- You will hear a beep when the **AE-L** button is pressed. The beep can be turned off. (p.204)
- AE lock is not available when the exposure mode is **B** (Bulb) mode.
- The combination of shutter speed and aperture value changes depending on the zooming position even while the AE lock is engaged when using a zoom lens for which the maximum aperture varies depending on the focal length. However, the exposure value does not change and the picture is taken at the brightness level set by the AE lock.
- Exposure can be locked when focus is locked. Set in [4. **AE-L** with AF locked] in the [**C** Custom Setting] menu. (p.108)

You can focus with the following methods.

<b>AF</b>	Autofocus	The camera is focused when the shutter release button is pressed halfway.
<b>MF</b>	Manual focus	Manually adjust the focus.

## Using the Autofocus

You can also choose the autofocus mode from **A.F.S** (Single mode) where the shutter release button is pressed halfway to focus on the subject and the focus is locked at that position, and **A.F.C** (Continuous mode) where the subject is kept in focus by continuous adjustment while the shutter release button is pressed halfway.

- 1 Set the focus mode lever to **AF**.

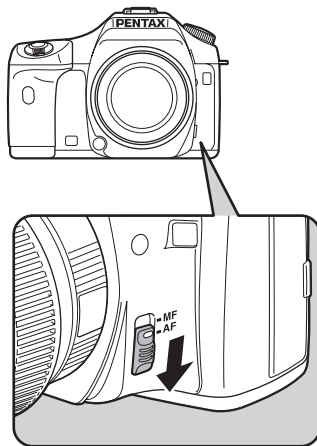



## 2 Look through the viewfinder and press the shutter release button halfway.

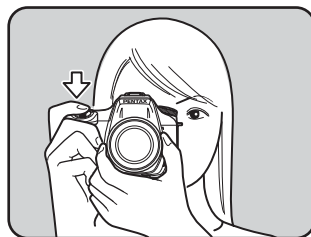

The focus indicator  appears and you will hear a beep when the subject comes into focus. (When blinking, the subject is not in focus.)

 Subjects that are Difficult to Focus on (p.60)



Focus Indicator

### Using the OK Button to Focus on the Subject

You can set the camera so that the focusing is not performed when the shutter release button is pressed halfway and is performed when the **OK** button is pressed. Use this setting when the autofocus by pressing the shutter release button halfway is not desired.

Set [Enable AF] in [12. **OK** button when shooting] in the [C Custom Setting] menu (p.75).

#### 12. OK button when shooting

- 1 Sensitivity/No. of Shots
- 2 Center of AF Point
- 3 Enable AF**
- 4 Cancel AF

AF with shutter release button disabled so AF performed with OK button



- When [Sensitivity/No. of Shots] is selected, press the **OK** button to display the currently selected sensitivity in the viewfinder. When [Sensitivity] is set to [AUTO] in the Fn menu, the automatically selected value is displayed.
- When [Select AF point] is set to  (Select) and [Center of AF Point] is selected, the AF point can be set to the center by pressing the **OK** button.
- Select [Cancel AF]. **MF** appears in the viewfinder while the **OK** button is pressed. Autofocus does not activate when the shutter release button is pressed (take your finger off the **OK** button to immediately return to AF mode).

## Setting the AF Mode

4

Shooting Functions

You can choose from the following two autofocus modes. The default setting is **A.F.S** (Single mode).

<b>A.F.S</b>	Single mode	When the shutter release button is pressed halfway to focus on the subject, the focus is locked at that position.
<b>A.F.C</b>	Continuous mode	The subject is kept in focus by continuous adjustment while the shutter release button is pressed halfway. Even if the subject is not in focus, the shutter can be released when the shutter release button is pressed fully.

Set “AF Mode” in the [ Rec. Mode] menu (p.74).

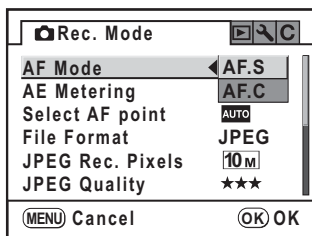



- Setting cannot be changed in Picture mode and **SCN** mode (p.79).
- **AFC** (Continuous mode) can be set when the mode dial is set to **P**, **Sv**, **Tv**, **Av**, **M** or **B**. The autofocus mode is set to **AFC** in (Moving Object) of Picture mode or (Kids) or (Pet) of **SCN** mode.
- In **AFS** (Single mode), the focus is locked (focus lock) while the focus indicator is displayed in the viewfinder. To focus on another subject, take your finger off the shutter release button first.
- During (Moving Object) mode, when the **SCN** mode is set to (Kids) or (Pet) or when **AFC** (Continuous mode) is set, focus is adjusted continuously, tracking the moving object as long as the shutter release button is kept pressed halfway.
- The shutter cannot be released until the subject is in focus in **AFS** (Single mode). If the subject is too close to the camera, move back and take the picture. Adjust the focus manually if the subject is difficult to focus (p.60). (p.109)
- In **AFS** (Single mode), press the shutter release button halfway. The built-in flash will discharge automatically several times, enabling the autofocus to focus on the subject more easily if the subject is in a dark area and the built-in flash is available.
- Regardless if the camera is set to **AFS** (Single mode) or **AFC** (Continuous mode), the camera automatically tracks the subject if it is determined to be a moving object.

## Selecting the Focusing Area (AF Point)

Choose the part of the viewfinder to set focus to. The default setting is **AUTO** (Auto).

The selected AF point lights red in the viewfinder. (Superimpose AF Area)

	Auto	The camera selects the optimum AF point even if the subject is not centered.
	Select	Sets the focusing area to one of the eleven points in the AF area.
	Center	Sets the focusing area to the center of the viewfinder.

Set in [Select AF point] in the [📷 Rec. Mode] menu (p.74).

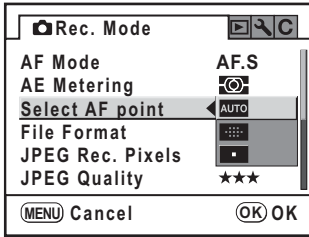

- AF point is not displayed in the viewfinder when [Off] is selected for [8. Superimpose AF Area] in the [C Custom Setting] menu (p.75).
- The AF point is fixed to the center position regardless of this setting with lenses other than DA, D FA, FA J, FA or F lenses.

## Setting the Focus Position in the Viewfinder

**1** Select  (Select) in [Select AF point] in the [📷 Rec. Mode] menu.

**2** Look through the viewfinder and check the position of the subject.

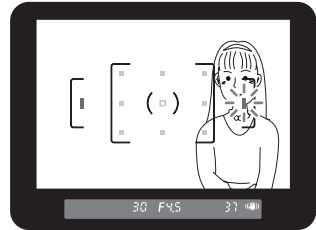

**3** Use the four-way controller (▲ ▼ ◀ ▶) to select the desired AF point.

The AF point lights red in the viewfinder (Superimpose AF Area) and you can check where you set the AF point.

## Fixing the Focus (Focus Lock)

If the subject is outside the range of the focusing area, the camera cannot automatically focus on the subject. In this situation, set [AF Mode] to **AFS** (Single mode). You can aim the focusing area toward the subject, use focus lock and recompose the picture.

### 1 Frame the desired composition for your picture in the viewfinder.

Use focus lock function when the subject you wish to focus on is not inside the focusing area.

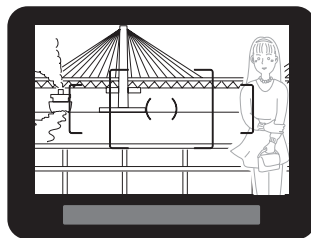

(Example) The person is out of focus and the background is focused instead.

### 2 Center the subject to focus in the viewfinder and press the shutter release button halfway.

The focus indicator  appears and you will hear a beep when the subject comes into focus. (When blinking, the subject is not in focus.)

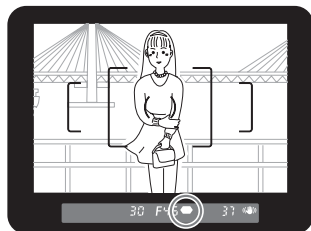





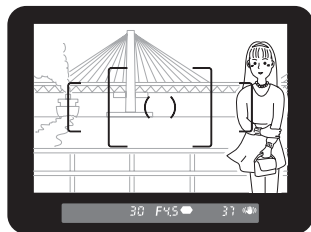

### 3 Lock the focus.

Keep the shutter release button pressed halfway. The focus will remain locked.

## 4 Re-compose the picture while keeping the shutter release button pressed halfway.



- The focus is locked while the focus indicator  is lit.
- Turning the zoom ring in focus lock mode may cause the subject to be out of focus.
- The beep that sounds when the image is focused can be turned off. (p.204)
- You cannot set focus lock when the [AF Mode] in the [📷 Rec. Mode] is set to **AFC** (Continuous mode), the Picture mode is set to  (Moving Object) or **SCN** mode is set to  (Kids) or  (Pet). In **AFC** (Continuous mode),  (Moving Object) mode or  (Kids) or  (Pet) of **SCN** mode, the autofocus continues to focus on the subject until the shutter is released (Continuous Autofocus).

## Locking Exposure when Focus is Locked

Set [4. **AE-L with AF locked**] in the [**C** Custom Setting] menu (p.75) to lock the exposure value while focus is locked. Exposure is not locked by default during focus lock.

1	Off	Exposure is not locked when focus is locked.
2	On	Exposure is locked when focus is locked.

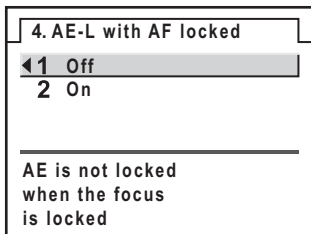

## Adjusting the Focus Manually (Manual Focus)

When you adjust the focus manually, you can either check with the focus indicator in the viewfinder or use the viewfinder matte field to adjust focus.

### Using the Focus Indicator

The focus indicator  appears in the viewfinder when the subject is in focus even during manual focus.

You can manually adjust the focus using the focus indicator .

- 1 **Set the focus mode lever to MF.**

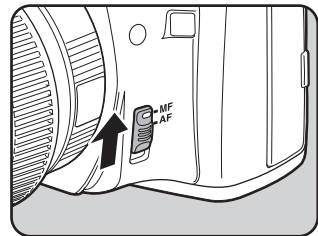

- 2 **Look through the viewfinder, press the shutter release button halfway and turn the focusing ring.**

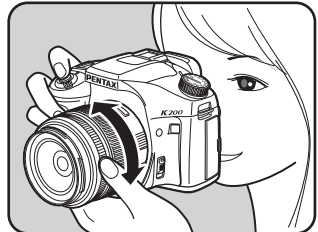

The focus indicator  appears and you will hear a beep when the subject comes into focus.



Focus Indicator



- Focus manually using the matte field in the viewfinder when the subject is difficult to focus (p.60) and the focus indicator will not stay lit.
- The beep that sounds when the image is focused can be turned off. (p.204)

## Using the Viewfinder Matte Field

You can manually adjust the focus using the viewfinder matte field.

- 1** Set the focus mode lever to **MF**.

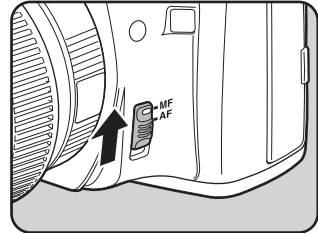

- 2** Look through the viewfinder and turn the focusing ring until the subject looks sharp on the focusing screen.

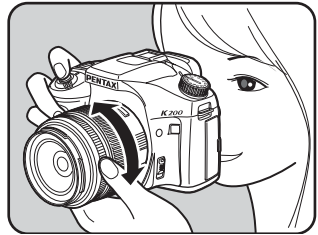



## Shooting in Catch-in Focus Mode

When [22. Catch-in focus] is set to On in the [**C** Custom Setting] menu (p.76), if the focus mode is set to **AFS** and one of the following types of lenses is attached, catch-in focus shooting is possible and the shutter is released automatically when the subject comes into focus.

- Manual focus lens
- DA or FA lens that has a **AF** and **MF** setting on the lens (the setting on the lens must be set to **MF** before shooting)

### ● How to Take Pictures

- 1 Attach a proper lens to the camera.
- 2 Set the focus mode lever to **AF**.
- 3 Set [AF mode] in the [**☒** Rec. Mode] menu to **AF.S**.
- 4 Set focus on a position the subject will pass.
- 5 Press the shutter release button fully.  
The shutter is released automatically when the subject comes into focus in the set position.



It is useful to use the optional cable switch CS-205 when shooting in Catch-in focus mode.

# Checking the Composition, Exposure and Focus Before Shooting

You can use the preview function to check the depth of field, composition, exposure and focus before taking a picture. There are two preview methods.

Digital Preview	For checking the composition, exposure and focus in the monitor.
Optical Preview	For checking the depth of field with the viewfinder.

## Selecting the Preview Method

Choose whether to use Digital Preview or Optical Preview when the main switch is turned to the preview position (⌚).

The default setting is Digital Preview.

Set in [18. Preview Method] in the [**C** Custom Setting] menu (p.76).

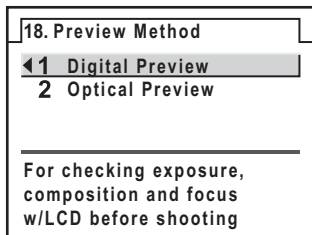

## Displaying the Preview

### Displaying the Digital Preview

- 1 **Focus on the subject, then compose the picture in the viewfinder and move the main switch to .**

The icon () appears in the monitor during preview and you can check the composition, exposure and focus.

Press the shutter release button halfway to end Digital Preview and start focusing.

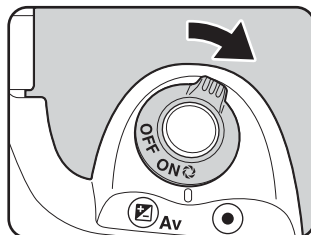

- You can display the histogram or Bright/Dark area warning in Digital Preview. Set in [Digital Preview] (p.212) in the [▶ Playback] menu.
- The maximum display time for Digital Preview is 60 seconds.
- You can magnify the image during Digital Preview with the e-dial. (p.162)
- Press the **Fn** button during Digital Preview to save the preview image as a JPEG image. The image save confirmation screen appears. Select [Save as] and press the **OK** button.

### Displaying the Optical Preview

- 1 **Position the subject inside the AF frame and press the shutter release button halfway to focus on the subject.**

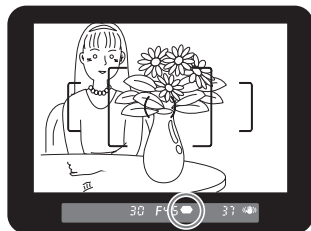



## 2 Turn the main switch to while looking through the viewfinder.

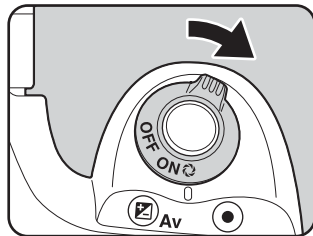



You can check the depth of field in the viewfinder while the main switch is on .



- No shooting information is displayed in the viewfinder, and the shutter cannot be released while the main switch is in the preview position (.
- You can check the depth of field in all Capture modes.

Pictures can be taken continuously while the shutter release button is held down.

Two types of Continuous shooting are available. With  (Continuous shooting (Hi)), pictures are taken continuously at the fastest frame rate until the camera buffer memory becomes full. With  (Continuous shooting (Lo)), pictures are taken continuously at the same interval.

 Continuous shooting (Hi)	When JPEG quality is set to  (Quality Level ★★★), up to 4 frames are taken continuously at approximately 2.8 fps. The shooting interval will increase as the camera buffer memory fills up.
 Continuous shooting (Lo)	When JPEG quality is set to  (Quality Level ★★★), pictures are taken continuously at approximately 1.1 fps until the SD Memory Card is full.



When saving in RAW format, a maximum of 4 frames can be taken continuously in either Continuous shooting mode.

## 1 Press the Fn button.

The Fn menu appears.

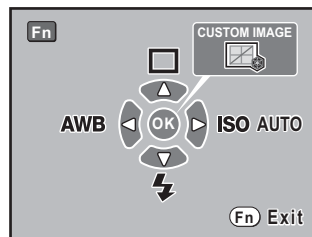

## 2 Press the four-way controller (▲).

The [Drive Mode] screen appears.



### 3 Use the four-way controller (◀▶) to select .



### 4 Press the four-way controller (▼) and use the four-way controller (◀▶) to select or .

### 5 Press the OK button.

The camera is ready to take pictures continuously.







### 6 Press the shutter release button halfway.

The autofocus system operates. The focus indicator  appears in the viewfinder when focused.



### 7 Press the shutter release button fully.

Pictures are taken continuously while the shutter release button is fully pressed. Take your finger off the shutter release button to stop.



- If the AF mode is set to **A.F.S** (Single mode), the focus position is locked on the first frame and pictures are taken continuously at the same interval.
- Focusing is continuously active when the AF Mode is set to **A.F.C** (Continuous mode), when Picture mode is set to  (Moving Object) or **SCN** mode is set to  (Kids) or  (Pet). Note that the shutter will be released even if the focusing is not complete.
- The shutter cannot be released until charging is complete when using the built-in flash. You can set the camera to enable shutter release before the built-in flash is ready in [15. Release when Charging] in the [**C** Custom Setting] menu. (p.129)
- Select a setting other than  or  in the [Drive Mode] screen to cancel continuous shooting. The setting is canceled when the camera is turned off if [Drive Mode] in [Memory] (p.217) of the [ Rec. Mode] menu is set to  (Off).

This camera has two types of self-timers:  and .

	Shutter will be released after about 12 seconds. Use this mode to include the photographer in the picture.
	A mirror pops up immediately after shutter release button is pressed. Shutter is released after about 2 seconds. Use this mode to avoid camera shake when the shutter release button is pressed.

## 1 Mount the camera onto a tripod.

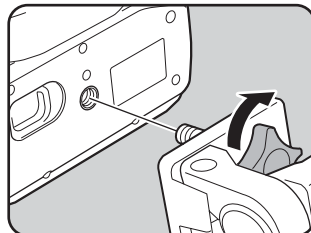

## 2 Press the Fn button.

The Fn menu appears.

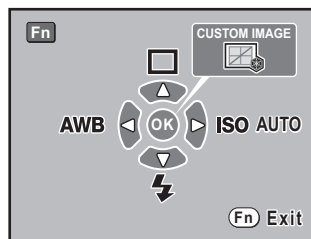

## 3 Press the four-way controller (▲).

The [Drive Mode] screen appears.



## 4 Use the four-way controller (◀▶) to select .

- 5** Press the four-way controller (▼) and use the four-way controller (◀▶) to select ☺ or ☹.



- 6** Press the OK button.

The camera is ready to take a picture.

- 7** Confirm in the viewfinder that the subject you wish to shoot is properly framed and press the shutter release button halfway.

The focus indicator ● appears in the viewfinder when the subject is in focus.



- 8** Press the shutter release button fully.

For ☺, the front self-timer lamp starts blinking slowly and blink rapidly 2 seconds before the shutter is released.

The beep is heard and the rate increases.

The shutter will be released about 12 seconds after the shutter release button is pressed fully.

For ☹, the shutter will be released about 2 seconds after the shutter release button is pressed fully.

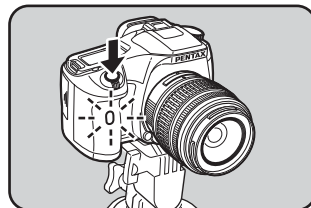





- You can set the camera so that the beep does not sound. (p.204)
- Exposure may be affected if light enters the viewfinder. Attach the provided ME viewfinder cap or use the AE lock function (p.101). (The light entering the viewfinder has no effect on the exposure when the exposure mode is set to **M** (Manual) (p.94).)

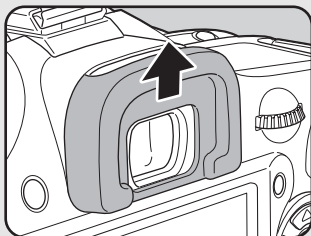

Removing the Eyecup Fp

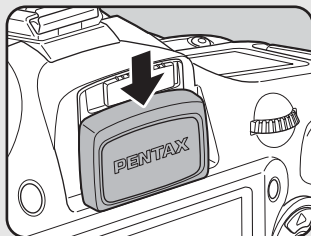

Attaching the ME Viewfinder cap

- Select a setting other than ☺ or ☹ in the [Drive Mode] screen to cancel self-timer shooting. The setting is canceled when the camera is turned off if [Drive Mode] in [Memory] of [📷 Rec. Mode] menu (p.217) is set to □ (Off).
- The Shake Reduction function is automatically turned off when ☺ or ☹ is set.

# Remote Control Shooting (Remote Control F: Sold Separately)

The shutter can be released from a distance by using the optional remote control unit. You can select  $\bar{\text{I}}$  (immediate shutter release) or  $\bar{\text{I}}_{3\text{s}}$  (3 sec. delayed release) for remote control shooting.

$\bar{\text{I}}$	The shutter will be released immediately after the shutter release button on the remote control unit is pressed.
$\bar{\text{I}}_{3\text{s}}$	When the shutter release button on the remote control unit is pressed, the shutter is released after about 3 seconds.

## 1 Mount the camera onto a tripod.

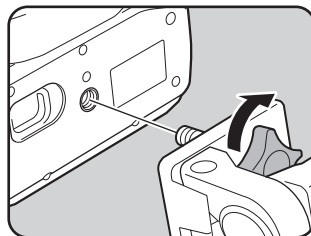

## 2 Press the Fn button.

The Fn menu appears.

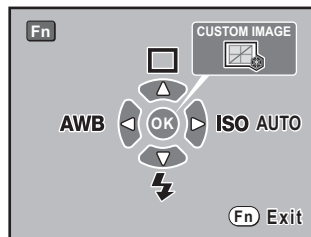

## 3 Press the four-way controller (▲).

The [Drive Mode] screen appears.

## 4 Use the four-way controller (◀▶) to select $\bar{\text{I}}$ .

## 5 Press the four-way controller (▼) and use the four-way controller (◀▶) to select or .

The self-timer lamp will blink to let you know that the camera is in remote control wait status.



## 6 Press the OK button.

The camera is ready to take a picture.

## 7 Press the shutter release button halfway.

The autofocus system operates. The focus indicator  appears in the viewfinder when focused.



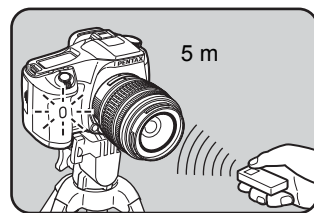

- You cannot focus with the remote control unit in default settings. Focus on the subject first with the camera before operating with the remote control. You can set [9. AF in remote control] to [On] in the [C Custom Setting] menu (p.75).
- When using the remote control unit, flash does not pop up automatically even when set to  (Auto discharge). Pop up the flash manually beforehand. (p.65)

## 8 Point the remote control unit towards the remote control receiver on the front of the camera and press the shutter release button on the remote control.



The operating distance of the remote control unit is about 5 m from the front of the camera.

For , the shutter will be released immediately after the shutter release button is pressed.

For , the shutter will be released in three seconds after the shutter release button is pressed.

After the picture is taken, the self-timer lamp lights for 2 seconds and then returns to blinking.



- Exposure may be affected if light enters the viewfinder. Attach the provided ME viewfinder cap or use the AE lock function (p.101). (The light entering the viewfinder has no effect on the exposure when the exposure mode is set to **M** (Manual) (p.94).)

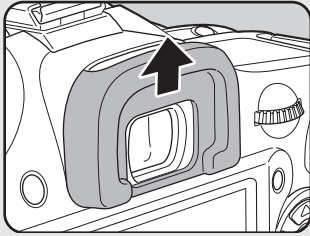

Removing the Eyecup F<sub>P</sub>

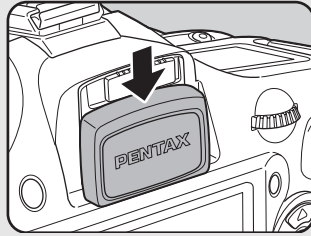

Attaching the ME Viewfinder cap

## 4

## Shooting Functions

- Select a setting other than  $\bar{\bar{I}}$  or  $\bar{\bar{I}}_{SS}$  in the [Drive Mode] screen to stop the remote control operation after it has been activated. The setting is canceled when the camera is turned off if [Drive Mode] in [Memory] (p.217) of [Rec. Mode] menu is set to  $\square$  (Off).
- The Shake Reduction function is automatically turned off when  $\bar{\bar{I}}$  or  $\bar{\bar{I}}_{SS}$  is set.
- The remote control may not operate in backlit conditions.
- The remote control does not work while the flash is being charged.
- The remote control unit battery can send a remote control signal about 30,000 times. Contact PENTAX Service Center to replace the battery (this will involve a fee).

# Using Mirror Up Function to Prevent Camera Shake

Use the Mirror Up function if camera shake is evident even when cable switch (optional) or remote control unit (optional) is used with a tripod. When shooting with the 2 sec. Self-Timer, the mirror pops up and the shutter is released 2 seconds after you press it, thereby avoiding the vibration of the mirror.

Follow the procedure below to take a picture with the Mirror Up function.

---

**1 Mount the camera onto a tripod.**

---

**2 In the Drive Mode, select  (2 sec. Self-Timer).**

 Self-Timer Shooting (p.117)

---

**3 Press the shutter release button halfway.**

The autofocus system operates. The focus indicator  appears in the viewfinder when focused.

---

**4 Press the shutter release button fully.**

The mirror pops up and the picture is taken 2 seconds later. AE lock is enabled with the exposure value set immediately before the mirror goes up.



The Shake Reduction function is automatically turned off when shooting with the 2 sec. Self-Timer.

# Changing the Shooting Conditions Automatically when Shooting (Auto Bracket)

## Shooting in Exposure Bracket Mode

You can take continuous pictures with different exposure when the shutter release button is pressed. The first frame is exposed with no compensation, the second frame is underexposed (negative compensation) and the third is overexposed (positive compensation).



Normal exposure



Underexposure

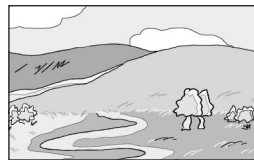

Overexposure

You can set [6. Auto Bracketing order] in the [C Custom Setting] menu (p.75).

Auto Bracketing order

0 → - → +, - → 0 → +, + → 0 → -, 0 → + → -

### 1 Press the Fn button in Capture mode.

The Fn menu appears.

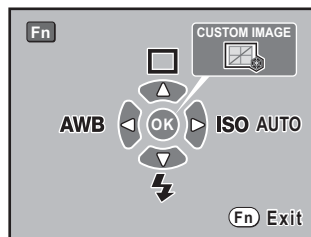

### 2 Press the four-way controller (▲).

The [Drive Mode] screen appears.

- 3 Use the four-way controller (►) to select  (Auto Bracket).**



- 4 Turn the e-dial to set the EV compensation value.**

The following EV compensation values can be set according to the step interval set in [1. EV Steps] (p.101) in the [C Custom Setting] menu.

Step interval	EV compensation value
1/2 EV	±0.5, ±1.0, ±1.5, ±2.0
1/3 EV	±0.3, ±0.7, ±1.0, ±1.3, ±1.7, ±2.0

- 5 Press the OK button.**

The camera is ready to take a picture and  is displayed on the LCD panel.

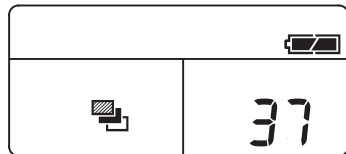

- 6 Press the shutter release button halfway.**

The focus indicator  and EV compensation value appear in the viewfinder when focused.

- 7 Press the shutter release button fully.**

Three continuous pictures will be taken, the first with no compensation, the second with negative compensation, and the third with positive compensation.



- When the AF mode is set to **AFS** (Single mode), the focus is locked in the first frame position and used for subsequent continuous frames.
- When you release your finger from the shutter release button during Auto Bracket, the Auto Bracket exposure setting will remain effective for twice as much time as the exposure metering timer (default setting is 20 seconds) (p.99) and you can take a picture at the next compensation value. In this case, auto focusing works for each frame. After about twice as much time as the exposure metering timer, the camera returns to settings for taking the first picture.
- You can combine Auto Bracket with the built-in flash or external flash (P-TTL auto only) to change only the flash output continuously. However, when using an external flash, holding the shutter release button down to take three continuous frames may cause the second and third frame to be taken before the flash is fully recharged. Always take one frame at a time after confirming that charging is complete.
- Exposure Bracket is not available when the exposure mode is set to **B** (Bulb) mode.

### Taking Only Overexposed or Underexposed Pictures

You can use Auto Bracket mode for only underexposure or overexposure shots by combining the operation with EV compensation (p.100). Auto Bracket is performed in both cases on the basis of the specified EV compensation value.



# 5 Using the Flash

---

This chapter provides details on the built-in flash of *K200D* and describes how to take pictures with the external flash.

<b>Compensating Flash Output .....</b>	<b>128</b>
<b>Allowing Shooting while Charging the Flash ..</b>	<b>129</b>
<b>Flash Characteristics in Each Exposure Mode .....</b>	<b>130</b>
<b>Distance and Aperture when Using the Built-in Flash .....</b>	<b>132</b>
<b>DA, D FA, FA J, FA and F Lens Compatibility with the Built-in Flash .....</b>	<b>133</b>
<b>Using an External Flash (Optional) .....</b>	<b>134</b>

# Compensating Flash Output

You can change the flash output in a range of  $-2.0$  to  $+1.0$ . The flash compensation values are as follows for 1/2 EV and 1/3 EV.

Step interval	Flash compensation
1/2 EV	$-2.0, -1.5, -1.0, -0.5, 0.0, +0.5, +1.0$
1/3 EV	$-2.0, -1.7, -1.3, -1.0, -0.7, -0.3, 0.0, +0.3, +0.7, +1.0$

\* Set interval of steps in [1. EV Steps] (p.101) in the [C Custom Setting] menu.

Set the flash compensation value by turning the e-dial in the [Flash Mode] screen in the Fn menu (p.77).

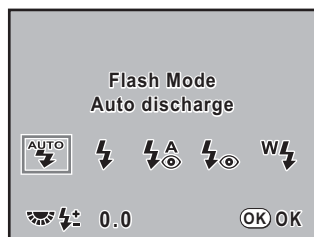

- If the maximum flash output is exceeded when corrected to the plus (+) side, no compensation will be effective.
- Compensating to the minus (–) side may not effect the image if the subject is too close, aperture is low or sensitivity is high.
- This flash compensation is also effective for external flash units which support P-TTL auto flash mode.
- Pressing the Green button on the [Flash Mode] screen resets the flash exposure compensation to the default setting [0.0].

# Allowing Shooting while Charging the Flash

You can set to enable shooting while the flash is being charged. Set [On] for [15. Release when Charging] in the [C Custom Setting] menu (p.76). Pictures cannot be taken while the flash is charging by default.

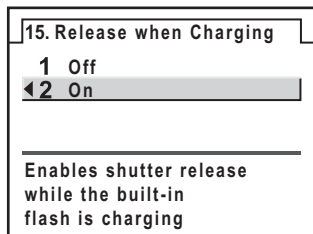

# Flash Characteristics in Each Exposure Mode

## Using the Flash in Tv (Shutter Priority) Mode

- When taking a moving subject, you can use the flash to change the blur effect.
- Any desired shutter speed 1/180 sec. or slower can be set for taking a flash photograph.
- The aperture value automatically changes according to the ambient brightness.
- The shutter speed is locked at 1/180 sec. when lens other than DA, D FA, FA J, FA, F or A is used.

## Using the Flash in Av (Aperture Priority) Mode

- You can set the desired aperture to take a flash photograph when you want to change the depth of field or shoot a subject farther away.
- The shutter speed automatically changes with the ambient brightness.
- The shutter speed shifts automatically anywhere from 1/180 sec. to a slow shutter speed (p.56) that reduces camera shake. The slowest shutter speed depends on the focal length of the lens in use.
- The shutter speed is locked at 1/180 sec. when lens other than DA, D FA, FA J, FA or F is used.

5

## Using Slow-Speed-Sync

You can use slow-speed-sync when shooting portraits with the sunset in the background. Both the portrait and the background are captured beautifully.



- Slow-speed-sync slows the shutter speed. Use the Shake Reduction function or turn off the Shake Reduction function and use a tripod to avoid camera shake. The picture will also blur if the subject moves.
- Slow-speed-sync shooting can also be performed with an external flash.

### ● Using Tv (Shutter Priority) Mode

- 1 Set the mode dial to **Tv**.  
**Tv** (Shutter Priority) mode is set.
- 2 Use the e-dial to set the desired shutter speed.  
The background is not properly exposed if aperture value is blinking when shutter speed is set. Set the shutter speed so that aperture value does not blink.
- 3 Press the **⚡UP** button.  
The flash pops up.
- 4 Take the picture.

### ● Using M (Manual) Mode

- 1 Set the mode dial to **M**.  
**M** (Manual) mode is set.
- 2 Set the shutter speed (under 1/180 sec.) and aperture value to obtain correct exposure.
- 3 Press the **⚡UP** button.  
The flash pops up.  
In **M** (Manual) mode, you can raise the flash at any time prior to shooting.
- 4 Take the picture.

# Distance and Aperture when Using the Built-in Flash

A set criteria is necessary between the guide number, aperture and distance when shooting with the flash to obtain the correct exposure. Calculate and adjust the shooting conditions if flash output is not sufficient.

Built-in flash guide number

ISO Sensitivity	Built-in flash guide number
ISO 100	Approx. 13
ISO 200	Approx. 18.4
ISO 400	Approx. 26
ISO 800	Approx. 36.8
ISO 1600	Approx. 52

## Calculating Shooting Distance from Aperture Value

The following equation calculates the distance of the flash for aperture values.  
 Maximum flash distance  $L1 = \text{Guide number} \div \text{Selected aperture}$   
 Minimum flash distance  $L2 = \text{Maximum flash distance} \div 5^*$

\* The value 5 used in the formula above is a fixed value which applies only when using the built-in flash alone.

Example

When sensitivity is [ISO 100] and aperture value is F2.8

$L1 = 13 \div 2.8 = \text{approx. } 4.6 \text{ (m)}$

$L2 = 4.6 \div 5 = \text{approx. } 0.9 \text{ (m)}$

Therefore, the flash can be used in a range of about 0.9 m to 4.6 m.

The flash cannot be used when the distance is 0.7 m or less. When the flash is used at closer than 0.7 m, it causes vignetting in the picture corners, light is distributed unevenly and the picture may be over-exposed.

## Calculating Aperture Value from Shooting Distance

The following equation calculates the aperture value for shooting distances.

Aperture value used  $F = \text{Guide number} \div \text{Shooting distance}$

Example

When sensitivity is [ISO 100] and shooting distance is 3 m, aperture value is:

$F = 13 \div 3 = 4.3$

If the resulting number (4.3, in the above example) is not available as a lens aperture, the smaller number that is closest (4.0, in the above example) is generally used.

# DA, D FA, FA J, FA and F Lens Compatibility with the Built-in Flash

Depending on the lens used with the **K200D**, even if a lens without a hood is attached, the use of the built-in flash may not be possible or may be limited due to vignetting.

DA, D FA, FA J, and FA lenses not listed below can be used without problems.

\* Following are evaluated without a hood.

## Unavailable due to vignetting

Lens Name
DA Fish-eye 10-17mm F3.5-4.5ED (IF)
DA12-24mm F4ED AL
DA14mm F2.8ED (IF)
FA★300mm F2.8ED (IF)
FA★600mm F4ED (IF)
FA★250-600mm F5.6ED (IF)

## Available depending on other factors

Lens Name	Compatibility
F Fish-eye 17-28mm F3.5-4.5	Vignetting may occur if focal length is less than 20 mm.
DA16-45mm F4ED AL	When the focal length is less than 28 mm or when the focal length is 28 mm and the shooting distance is 1 m or less, vignetting may occur.
DA★16-50mm F2.8ED AL (IF) SDM	When the focal length is 20 mm or less or when the focal length is 35 mm and the shooting distance is less than 1.5 m, vignetting may occur.
DA18-250mm F3.5-6.3ED AL (IF)	Vignetting may occur if the focal length is less than 35 mm.
FA★28-70mm F2.8AL	Vignetting may occur if focal length is 28 mm and the shooting distance is less than 1 m.
FA Soft 28mm F2.8	Built-in flash always discharges fully.
FA Soft 85mm F2.8	Built-in flash always discharges fully.

# Using an External Flash (Optional)

Using the optional external flash AF540FGZ, AF360FGZ or AF200FG enables a variety of flash modes, such as P-TTL auto flash mode, depending on the external flash being used. See the chart below for details.

(Yes: Available #: Restricted No: Not available)

Flash	Built-in Flash	AF540FGZ AF360FGZ	AF200FG
Camera Function			
Red-eye reduction flash	Yes	Yes	Yes
Automatic flash discharge	Yes	Yes	Yes
After the flash is charged, the camera automatically switches to the flash sync speed.	Yes	Yes	Yes
Aperture is automatically set in <b>P</b> (Program) mode and <b>Tv</b> (Shutter Priority) mode.	Yes	Yes	Yes
Auto check in the viewfinder	No	No	No
P-TTL auto flash (appropriate sensitivity: ISO 100 to 1600)	Yes <sup>*1</sup>	Yes <sup>*1</sup>	Yes <sup>*1</sup>
Slow-speed sync	Yes	Yes	Yes
Flash exposure compensation	Yes	Yes	Yes
AF illuminator	Yes	Yes	No
Trailing curtain sync <sup>*2</sup>	Yes	Yes	No
Contrast-control-sync flash mode	# <sup>*3</sup>	Yes	# <sup>*5</sup>
Slave flash	No	Yes	No
Multiple flash	No	No	No
High-speed flash sync	No	Yes	No
Wireless flash	# <sup>*5</sup>	Yes <sup>*4</sup>	No

\*1 When using DA, D FA, FA J, FA, F or A lens.

\*2 Shutter speed of 1/90 sec. or slower.

\*3 When combined with the AF540FGZ or AF360FGZ, 1/3 of the flash discharge can be output by the built-in flash and 2/3 can be output by the external flash.

\*4 Multiple AF540FGZ or AF360FGZ units or a combination of an AF540FGZ/AF360FGZ unit and the built-in flash is required.

\*5 Only available when combined with the AF540FGZ or AF360FGZ.



## About the LCD Panel Display for AF360FGZ

The AF360FGZ does not have the function to set the FORMAT size to [DIGITAL], but the difference in angle of view between standard 35 mm format and the **K200D** is automatically calculated based on the focal length of the lens used (when using DA, D FA, FA J, FA or F lenses). The conversion indicator appears and the format size indicator disappears when the exposure metering timer of the **K200D** is on (it returns to 35 mm format display when the exposure metering timer is turned off).

Lens focal length		85mm	77mm	50mm	35mm	28mm	24mm	20mm	18mm
AF360FGZ LCD panel	Exposure metering timer Off	85mm	70mm	50mm	35mm	28mm	24mm	20mm	18mm
	Exposure metering timer On	58mm	48mm	34mm	24mm	19mm	16mm*	14mm	12mm

\* Using wide-angle panel

## Using P-TTL Auto Mode

Use this flash mode with the AF540FGZ, AF360FGZ or AF200FG flash unit. When the flash mode is set to [P-TTL auto], the flash pre-flashes before the actual flash and confirms the subject (the distance, brightness, contrast, whether it is backlit, etc.) using the camera 16-segment metering sensor. The flash output for the actual flash is adjusted based on the information obtained from the pre-flash, enabling flash photography with more appropriate exposure for the subject than with normal TTL auto. P-TTL auto is available in wireless flash mode when two or more AF540FGZ or AF360FGZ units are used.

- 1 Remove the cover of the hot shoe and attach the external flash (AF540FGZ or AF360FGZ).
- 2 Turn on the camera and the external flash.
- 3 Set the external flash mode to [P-TTL auto].
- 4 Confirm that the external flash is fully charged and then take the picture.



- P-TTL auto is only available with the AF540FGZ, AF360FGZ or AF200FG flash unit.
- The will light in the viewfinder when the flash is ready (fully charged).
- For details such as operation method and effective distance, please read the external flash manual.
- The flash does not discharge when the subject is bright enough when Flash Mode is or . Therefore, it may not be suitable for daylight-sync shooting.
- Never press the button when any external flash unit is attached to the camera. The built-in flash will hit the external flash. If you want to use both at once, see p.140 for the connection method.

## Using High-Speed Flash Sync Mode

With the AF540FGZ or AF360FGZ, you can discharge the flash to take a picture at a shutter speed faster than 1/180 second. High-speed flash sync can be used with the flash attached to the camera, or wireless.

5

### Attaching and Using the AF540FGZ or AF360FGZ

- 1 Remove the cover of the hot shoe and attach the external flash (AF540FGZ or AF360FGZ) to the camera.
- 2 Turn the mode dial and set the exposure mode to **Tv** or **M**.
- 3 Turn on the camera and the external flash.
- 4 Set the external flash sync mode to HS (high-speed flash sync).
- 5 Confirm that the external flash is fully charged and then take the picture.



- The will light in the viewfinder when the flash is ready (fully charged).
- High-speed flash sync is only available when the shutter speed is faster than 1/180 sec.
- High-speed flash sync is not available when the exposure mode is set to **B** (Bulb).

## Using in Wireless Mode

By using two external flashes (AF540FGZ or AF360FGZ) or using the built-in flash with an external flash, you can shoot in P-TTL flash mode without connecting the flash units with a cord. High-speed sync mode is also available for wireless shooting.



- Set the power switch of the external flash to WIRELESS.
- Set the wireless mode of the external flash not directly connected to the camera to SLAVE.

## Setting the Channel for the External Flash

First set the channel for the external flash unit.

- 1 Set the channel for the external flash unit.
- 2 Attach the external flash to the camera hot shoe.
- 3 Turn on the camera and the external flash, and press the shutter release button halfway.

The built-in flash is set to the same channel as the external flash unit.



- When set to **w** mode, the channel currently set for the built-in flash is displayed on the LCD panel for 10 seconds.
- Be sure to set all the flashes to the same channel. Refer to the AF540FGZ or AF360FGZ operating manual for details on how to set the channel on the external flash.

## Using the Built-in Flash in Wireless Mode

Set the camera to wireless flash mode when using an external flash in combination with the built-in flash.

- 1 Press the **Fn** button and press the four-way controller (▼).

The [Flash Mode] screen appears.

- 2 Use the four-way controller (◀▶) to select **w** mode.

Press the **OK** button to return to Capture mode.

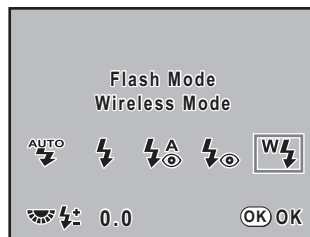

- When Drive Mode is set to **ss** or the lens aperture is not set to the **A** position, **w** appears gray and cannot be selected.

## ● Changing the Built-in Flash Discharge Method

You can change the built-in flash discharge method in wireless mode.

1	On	Discharges the built-in flash.
2	Off	Discharges the built-in flash as a control flash.

Set in [16. Flash in Wireless Mode] in the [C Custom Setting] menu (p.76).



HS (High-speed sync) is not available when the camera is set to discharge the built-in flash.

## Wireless Shooting

### ● Using a Combination of the Built-in Flash and an External Flash Unit

- 1 Remove the external flash unit after the channel was set on the camera, and place at the desired location.
- 2 Set the camera flash to mode, and pop up the built-in flash.
- 3 Confirm that both flashes are fully charged and then take the picture.

### ● Using a Combination of External Flash Units

- 1 Set the wireless mode of the external flash directly connected to the camera to [MASTER] or [CONTROL].

MASTER	Discharges both the flash directly connected to the camera and the wireless flash unit.
CONTROL	The flash directly connected to the camera is discharged as a control flash only and does not discharge as main flash.

- 2 On the wireless remote flash unit, set the wireless flash mode to [SLAVE] and set the channel to the same channel as the flash directly connected to the camera. Then, place at the desired location.
- 3 Confirm that both flashes are fully charged and then take the picture.



Shake Reduction is not available in Wireless mode.

## Wireless Flash Control (P-TTL Flash Mode)

When using external flash units (AF540FGZ or AF360FGZ) for wireless shooting, the following information is exchanged between the flash units before the flash is discharged.

Press the shutter release button fully.

- 1 The flash unit directly connected to the camera emits a control flash (relays the flash mode of the camera).
- 2 The wireless remote flash unit emits a test flash (relays confirmation of subject).
- 3 The flash unit directly connected to the camera emits a control flash (relays flash output to the wireless remote flash unit).
  - \* The flash unit directly connected to the camera will emit a control flash one more time after this to relay the flash duration time when HS  $\downarrow$  (High-speed sync) is set.
- 4 The wireless remote flash unit discharge as main flash.



When the wireless mode of the external flash directly connected to the camera is set to [MASTER] or [16. Flash in Wireless Mode] (p.138) is set to [On] for the built-in flash, all the flash units will discharge simultaneously.

## Red-Eye Reduction

As with the built-in flash, red-eye reduction is available with an external flash. This may not be available on some flashes or may have restrictions for usage conditions. See the chart on p.134.



- The red-eye reduction feature works even when only an external flash is used. (p.66)
- If red-eye reduction of the built-in flash is used when the external flash is set as the slave unit or with the wireless function, the preflash for red-eye reduction will trigger the external flash. Do not use red-eye reduction when using a slave unit.

## Trailing Curtain Sync

When using the built-in flash with an external flash (AF540FGZ or AF360FGZ) that is set to the Trailing curtain sync function, the built-in flash will also use this mode. Confirm that both flash units are fully charged before shooting.

## Using the Built-in Flash with the External Flash

As shown in the illustration below, attach the Hot Shoe Adapter F<sub>G</sub> (optional) to the camera hot shoe and an Off-Camera Shoe Adapter F (optional) to the bottom of the external flash, and connect these with the Extension Cord F5P (optional). The Off-Camera Shoe Adapter F can be mounted using the tripod screw to your tripod.

Only the P-TTL auto flash can be used in combination with the built-in flash.

5

When combining with the built-in flash

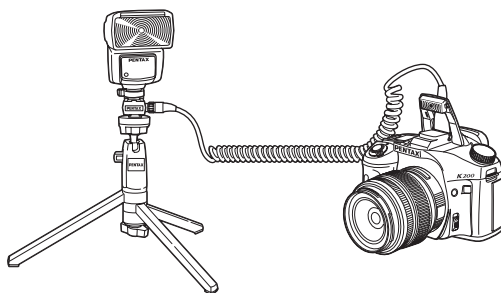

## Discharging Multiple Flashes

You can combine two or more external flashes (AF540FGZ, AF360FGZ or AF200FG) or you can use two or more external flashes in combination with the built-in flash. You can use the extension cord connection terminal on the flash to connect the AF540FGZ. You can connect AF360FGZ or AF200FG units as shown in the illustration below. Connect an external flash and the Hot Shoe Adapter F (optional) to the Off-Camera Shoe Adapter F (optional) and then connect another Off-Camera Shoe Adapter F with external flash using the Extension Cord F5P (optional). Refer to the flash manual for details.



- Do not combine with accessories that have a different number of contacts such as a Hot Shoe Grip as a malfunction may occur.
- Combining with flashes from other manufacturers may cause equipment breakdown. We recommend using the AF540FGZ, AF360FGZ or AF200FG.

When combining two or more external flashes

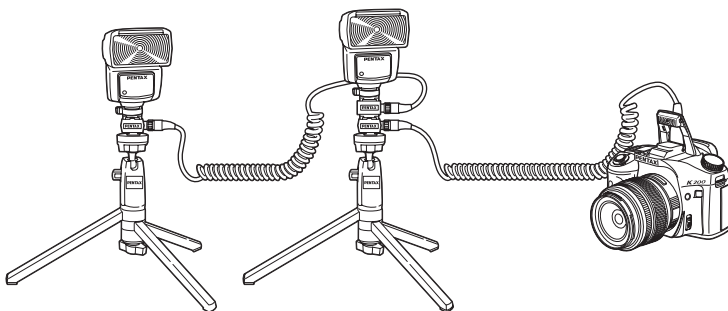

When using multiple external flashes or an external flash with the built-in flash, P-TTL is used for flash control.

## Contrast-Control-Sync Flash

Combining two or more external flashes (AF540FGZ, AF360FGZ or AF200FG) or using an external flash in combination with the built-in flash allows multiple flash photography (contrast-control-sync flash photography). This is based on the difference between the amounts of light discharged from multiple units.



- The AF200FG must be combined with the AF540FGZ or AF360FGZ.
- Do not combine with accessories that have a different number of contacts such as a Hot Shoe Grip as a malfunction may occur.
- Combining with flashes from other manufacturers may cause equipment breakdown. We recommend using PENTAX automatic flashes.

- 1 Connect the external flash to the camera indirectly. (p.140)
- 2 Set the sync mode for the external flash to the contrast-control-sync mode.
- 3 Turn the mode dial and set the exposure mode to **P**, **Tv**, **Av** or **M**.
- 4 Confirm that both the external flash and built-in flash are fully charged and then take the picture.



- When using two or more external flashes and the contrast-control-sync mode is set on the external master flash unit, the flash output ratio is 2 (master unit) : 1 (slave units). When external flash is used in combination with the built-in flash, the flash output ratio is 2 (external flash) : 1 (built-in flash).
- When using multiple external flashes or an external flash with the built-in flash, P-TTL is used for flash control.



# 6 Shooting Settings

---

This chapter describes how to set the save format for pictures taken and other settings.

<b>Setting the Image Processing Method in Capture Mode (Custom Image) .....</b>	<b>144</b>
<b>Setting the File Format .....</b>	<b>146</b>

# Setting the Image Processing Method in Capture Mode (Custom Image)

You can set Custom Image when the exposure mode is set to **P** (Program), **Sv** (Sensitivity Priority), **Tv** (Shutter Priority), **Av** (Aperture Priority), **M** (Manual) or **B** (Bulb). By using Custom Image to change the [Image Tone], you can adjust settings such as the color and contrast before shooting an image.

Select from the following six modes for Image Tone: Bright, Natural, Portrait, Landscape, Vibrant and Monochrome. The default setting is [Bright].

You can adjust the following items for Image Tone.

Saturation <sup>*1</sup>	Sets the color saturation. (Available settings: -4 to +4)
Hue <sup>*1</sup>	Sets the color. (Available settings: -4 to +4)
Contrast	Sets the image contrast. (Available settings: -4 to +4)
Sharpness	Sets the sharpness of the image outlines. (Available settings: -4 to +4)
Filter Effect <sup>*2</sup>	Changes the contrast to appear as if a B&W color filter was used. Sets the filter color. (Available settings: [None], [Green], [Yellow], [Orange], [Red], [Magenta], [Blue], [Cyan], [Infrared Color])
Toning <sup>*2</sup>	Sets the level for cold tone adjustment (- direction) and warm tone adjustment (+ direction). (Available settings: -4 to +4)

\*1 This can be set when any mode other than [Monochrome] is selected.

\*2 This can be set when [Monochrome] is selected.

## 1 Press the Fn button in Capture mode.

The Fn menu appears.

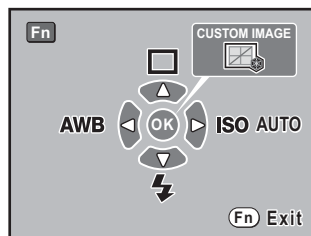

## 2 Press the OK button.

The Custom Image screen appears. After the power is turned on, the last image taken is displayed in the background. Set the main switch to  to change the background image to the Digital Preview image.

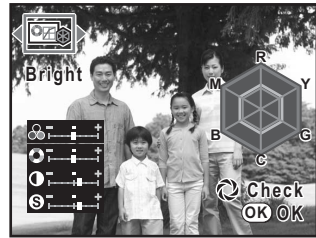

## 3 Use the four-way controller (◀▶) to choose the Image Tone.

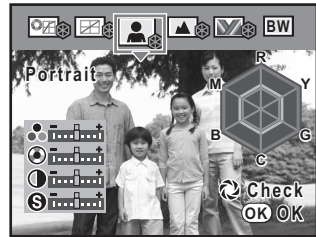

## 4 Use the four-way controller (▲▼) to choose the item you want to change ([Saturation], [Hue], [Contrast], [Sharpness]).

When Image Tone is set to [Monochrome], you can change the settings for [Filter Effect], [Toning], [Contrast], and [Sharpness].

## 5 Use the four-way controller (◀▶) to change the setting.

The background image changes according to the setting.

You can visually check the saturation and hue with the radar chart.

For [Sharpness], turn the e-dial to switch between [Fine Sharpness] and [Sharpness]. The image outlines are even thinner and sharper with [Fine Sharpness], making it suited for capturing fine subjects such as hair.

Press the Green button to reset the setting.

## 6 Press the OK button.

The camera returns to the Capture mode.



- In Picture mode or **SCN** (Scene) mode, you can confirm the custom image, however, the settings cannot be changed.
- When Image Tone is set to [Monochrome], the radar chart is not displayed.

## Setting the JPEG Recorded Pixels

You can select the number of recorded pixels from **10M**, **6M** and **2M**. The more pixels there are, the larger the picture and the bigger the file size. The file size will also differ according to the [JPEG Quality] setting. The default setting is **10M** 3872×2592.

Recorded Pixels	Pixels	Paper Size
<b>10M</b>	3872×2592	10"×12" / A3 paper
<b>6M</b>	3008×2000	8"×10" / A4 paper
<b>2M</b>	1824×1216	5"×7" / A5 paper

The paper sizes above are references for optimal printing by recorded pixels. The quality of the captured photo or printed picture depends on the quality level, exposure control, resolution of the printer and a variety of other factors.

You can set the JPEG recorded pixels in [JPEG Recorded Pixels] in the [Rec. Mode] menu (p.74).

When the number of recorded pixels is changed, the number of recordable images appears at the top right of the screen.

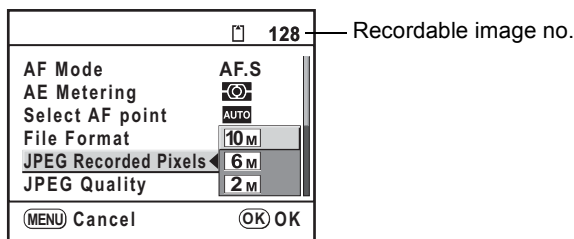

## Setting the JPEG Quality Level

You can set the image quality level. The file size will also differ according to the [JPEG Rec. Pixels] setting. The default setting is ★★★ (Best).

★★★	Best	↑ Images will be clearer but file size will be larger. ↓ Images will be grainier but file size will be smaller.
★★	Better	
★	Good	

You can set the JPEG quality level in [JPEG Quality] in the [📷 Rec. Mode] menu (p.74).

When the quality level is changed, the number of recordable images at that quality level appears at the top right of the screen.

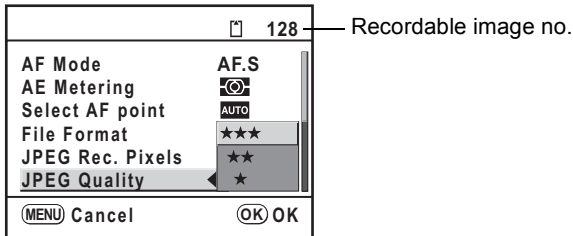

## Setting the File Format

You can set the format of image files. The default setting is JPEG.

JPEG	Captures images in JPEG format. You can change the number of recorded pixels from [JPEG Rec. Pixels] in the [📷 Rec. Mode] menu, and the image quality level from [JPEG Quality] in the [📷 Rec. Mode] menu. The file size varies according to the settings.
RAW	RAW data is CCD output data saved without processing. Effects such as White Balance, Custom Image and Color Space are not applied to the image but such information is saved. Use RAW Display (p.185) or transfer to a PC, apply effects with the enclosed PENTAX PHOTO Laboratory 3 and create JPEG image.
RAW+	Image is saved in both RAW and JPEG formats. When the <b>RAW</b> button is pressed, images are temporarily captured in both formats. (p.19)

Set [File Format] in the [📷 Rec. Mode] menu (p.74).

When the file format is changed, the number of recordable images appears at the top right of the screen.

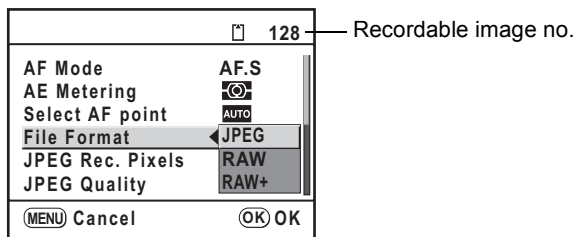

## Setting the RAW File Format

You can select PEF or DNG format in [RAW file format] in the [📷 Rec. Mode] menu (p.74) when images are captured in RAW format. The default setting is PEF format.

PEF	PENTAX original RAW file format
DNG	General-purpose, publicly available RAW file format designed by Adobe Systems

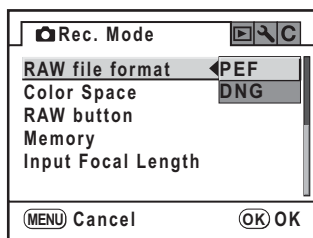

## Setting the RAW Button Function

You can set the function when the **RAW** button (p.19) is pressed in Capture mode.

The following settings are available.

Cancel each time	<input checked="" type="checkbox"/> (On)/ <input type="checkbox"/> (Off)
File Format	File format selected when the <b>RAW</b> button is pressed in Capture mode.

**1** Select [RAW button] in the [**Rec. Mode**] menu.

**2** Press the four-way controller (▶).

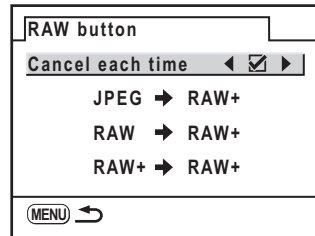

**3** Use the four-way controller (◀▶) to select  (On) or  (Off) for [Cancel each time].

When set to  (On), the recording format each time a picture is taken returns to the [File Format] setting in the [**Rec. Mode**] menu. The default setting is  (On).

When [Cancel each time] is set to  (Off), the **RAW** button settings are canceled under the following conditions.

- the **RAW** button is pressed again
- the camera is turned off
- the mode dial is turned.
- a menu is displayed
- the camera is in Playback mode

**4** Use the four-way controller (▲▼) to choose a file format.

The left side is the [File Format] setting in the [**Rec. Mode**] menu and the right side is the file format when the **RAW** button is pressed.

**5** Press the four-way controller (▶), and use the four-way controller (▲▼) to select the file format when the RAW button is pressed.







**6** Press the OK button.

**7** Press the MENU button twice.

The camera returns to the Capture mode or Playback mode.

## Setting the White Balance

White balance is a function for adjusting the color of an image so that white objects appear white. Set the white balance if you are not satisfied with the color balance of pictures taken with white balance set to **AWB** (Auto), or to intentionally apply a creative effect to your images. The default setting is **AWB** (Auto).

<b>AWB</b>	Auto	Automatically adjusts the white balance. (About 4000 to 8000K)
	Daylight	For use when taking pictures in sunlight. (About 5200K)
	Shade	For use when taking pictures in the shade. It reduces the bluish color tones in a picture. (About 8000K)
	Cloudy	For use when taking pictures on cloudy days. (About 6000K)
	Fluorescent Light	For use when taking pictures under fluorescent lighting. Select the type of fluorescent light, from W (white) (about 4200K), N (neutral white) (about 5000K), and D (daylight) (about 6500K).
	Tungsten Light	For use when taking pictures under light bulb or other tungsten light. It reduces the reddish color tones in a picture. (About 2850K)
	Flash	For use when taking pictures using the built-in flash. (About 5400K)
	Manual	Use this to manually adjust the white balance according to the lighting so that white objects appear as a natural white.

\* The color temperature (K) is an estimate. This does not indicate precise colors.



## 1 Press the Fn button in Capture mode.

The Fn menu appears.

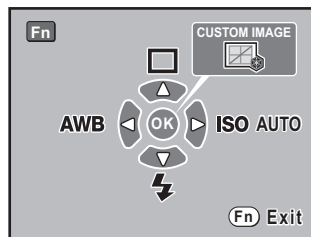

## 2 Press the four-way controller (◀).

The [White Balance] screen appears.

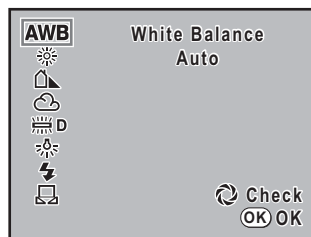

## 3 Press the four-way controller (▲▼) and set.

Set the main switch to  to display Digital Preview with the set White Balance.

Fine-tuning White Balance is easier with Digital Preview.

## 4 Press the OK button.

The camera is ready to take a picture with the set White Balance.



- White balance cannot be adjusted in Picture mode and SCN mode (p.79).
- Refer to p.152 for manual adjustment method.
- Preview is Digital Preview, regardless of the [18. Preview Method] setting in the [C Custom Setting] menu.
- Because the light source changes when the flash discharges, you can set the white balance for when the flash discharges. Select [Flash] or [Unchanged] in [17. WB when using flash] in the [C Custom Setting] menu (p.76).

## Color Temperature

The color of light shifts towards blue as the color temperature rises, and towards red as the color temperature falls. Color temperature describes this change in light color in terms of absolute temperature (K: Kelvin). This camera is capable of setting the white balance to enable taking pictures with natural coloring under a variety of lighting conditions.

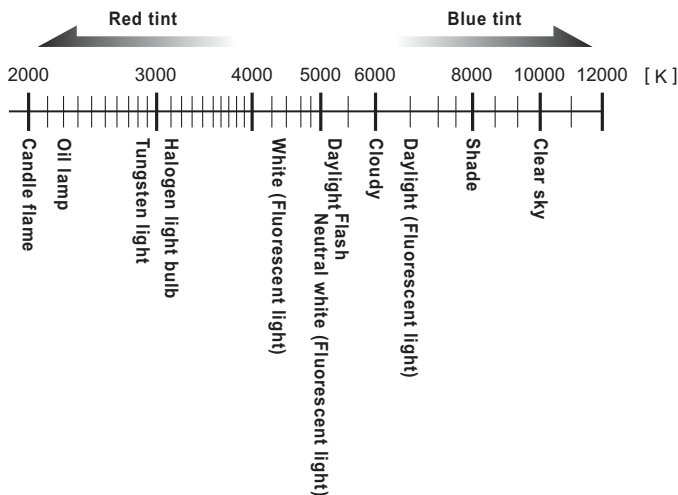

### 6

## Shooting Settings

### Adjusting the White Balance Manually

You can adjust the white balance depending on the light source when taking pictures. With Manual White Balance, the camera can store delicate shades that cannot be precisely adjusted with the white balance preset values provided in the camera. This provides the optimum white balance for your surroundings.

**1** Set the mode dial to **P**, **Sv**, **Tv**, **Av**, or **M**.

**2** Press the **Fn** button.

The Fn menu appears.

**3** Press the four-way controller (◀).

The [White Balance] screen appears.

- 4** Use the four-way controller (▼) to select  (Manual).

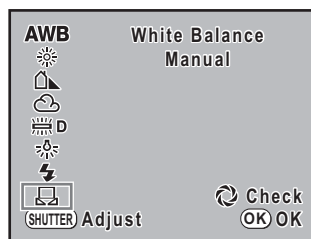

- 5** Under the light to measure the white balance, fully display a white sheet of paper in the viewfinder or select a white area as the subject.

- 6** Press the shutter release button fully.

Slide the focus mode lever to **MF** when the shutter cannot be released.

The screen to select the measuring range is displayed.



- 7** Use the e-dial to select the entire screen or spot area for the measuring range.

- 8** When a spot area is selected, use the four-way controller (▲▼◀▶) to move the frame to the area you want to measure.

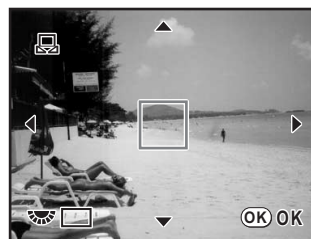

- 9** Press the OK button.

The camera returns to the [White Balance] screen.

Tune using steps in "Fine-Tuning the White Balance" if fine-tuning is necessary. (p.154)



## 10 Press the OK button.

The camera is ready to take a picture with the set White Balance.



- No image is recorded when the shutter release button is pressed to adjust the white balance.
- [NG] appears when measuring is unsuccessful. Press the **OK** button while displayed to return to the [Adjust White Balance] screen for remeasuring.
- If the picture is extremely overexposed or underexposed, white balance may not be adjusted. In this case, adjust appropriate exposure and adjust the white balance.

## Fine-Tuning the White Balance

You can fine tune the White Balance setting.

**1** Set [7. Adjust White Balance] in the [C Custom Setting] menu to [On].

**2** Perform desired settings in Steps 1 to 3 of “Setting the White Balance”.

**3** Press the four-way controller (▶).

The [Adjust White Balance] screen appears.

**4** Use the four-way controller (▲▼◀▶) to fine tune White Balance.

Seven levels and 225 patterns are available on the G-M and B-A axes.

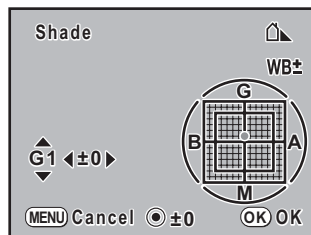

GM compensation	Adjusts the tone of the colors between green and magenta.	▲▼
BA compensation	Adjusts the tone of the colors between blue and amber.	◀▶

Press the Green button to reset the GM compensation and BA compensation to [0].

## 5 Press the OK button.

The camera returns to the [White Balance] screen.

## 6 Press the OK button.

The camera is ready to take a picture with the set White Balance.



- If [7. Adjust White Balance] in the [C Custom Setting] menu is set to [Off] after White Balance is adjusted, the adjusted values become invalid. Set [7. Adjust White Balance] to [On] again to enable the values used previously.
- White Balance can also be manually measured in the [Adjust White Balance] screen.

## Setting the Color Space

You can set the color space to use. The default setting is [sRGB].

1	sRGB	Sets to sRGB color space.
2	AdobeRGB	Sets to AdobeRGB color space.

Set [Color Space] in the [Rec. Mode] menu (p.74).

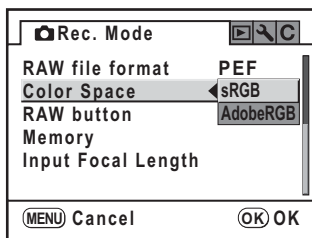

File names differ depending on the color space setting as shown below.

For sRGB : IMGpxxxx.JPG

For AdobeRGB : \_IGPxxxx.JPG

[xxxx] indicates the file number. This is displayed as a four-digit sequential number. (p.213)

## Color Space

Color ranges for various input/output devices, such as digital cameras, monitors, and printers, differ.

This color range is called the Color Space.

To recreate different color spaces in different devices, standard color spaces have been proposed. This camera supports sRGB and AdobeRGB.

sRGB is mainly used for devices such as a PC.

AdobeRGB covers a wider area than sRGB and is used for occupational uses such as industrial printing.

An image created in AdobeRGB may appear lighter than an image created in sRGB when output from an sRGB compatible device.

# 7 Playback Functions

---

This chapter describes how to use the various playback functions in Playback mode.

<b>How to Operate the Menus During Playback ...</b>	<b>158</b>
<b>Rotating Images .....</b>	<b>160</b>
<b>Enlarging Playback Images .....</b>	<b>161</b>
<b>Displaying Multiple Images .....</b>	<b>163</b>
<b>Displaying a Folder .....</b>	<b>165</b>
<b>Comparing Images .....</b>	<b>166</b>
<b>Slideshow .....</b>	<b>167</b>
<b>Changing Playback Display Method .....</b>	<b>170</b>
<b>Deleting Multiple Images .....</b>	<b>173</b>
<b>Protecting Images from Deletion (Protect) .....</b>	<b>177</b>
<b>Connecting the Camera to AV Equipment .....</b>	<b>179</b>

# How to Operate the Menus During Playback

Press the **MENU** button in Playback mode. The [▶ Playback] menu appears.

## [▶ Playback] Menu Setting Items

Perform settings related to playing back images in the [▶ Playback] menu.

Item	Function	Page
Playback display	Sets whether to display the Bright/Dark area warning in Playback mode and also sets the initial magnification when enlarging images.	p.172
Instant Review	Sets how long to display Instant Review and whether to display histogram and Bright/Dark area warning.	p.211
Digital Preview	Sets whether to display Bright/Dark area warning and histogram during Digital Preview.	p.113 p.212
Slideshow	Plays back recorded images one after another.	p.169

7

Playback Functions

## [C Custom Setting] Menu Setting Items

Set custom functions to fully use the functions of a SLR camera with the Custom Function Menu. The default setting does not change Custom Function.

The [C Custom Setting] menu settings are activated when [Setting], the first item, is  (On).

Item	Function	Page
Setting	Sets to change Custom Function.	–
20. Saving rotation info	Sets whether to save rotation information when shooting.	–
21. Auto Image Rotation	Sets to automatically rotate images when playing back.	–
Reset Custom Function	Resets all the settings in the [C Custom Setting] menu to the defaults.	p.221



## Playback Fn Menu Setting Items

Press the **Fn** button during playback. The Fn menu appears.



Press the four-way controller (▲▼◀▶) or the **OK** button to set the operation.

Key or Button	Item	Function	Page
▲	DPOF Settings	Sets the DPOF settings.	p.190
▼	RAW Display	Converts RAW images to JPEG format.	p.185
◀	Digital Filter	Changes the color tone of captured images, adds softening and slimming effects, or adjusts the brightness.	p.182
▶	Slideshow	Plays back recorded images one after another.	p.167
<b>OK</b>	Image Comparison	You can display two images side-by-side.	p.166



- RAW Display (▼) cannot be selected when displaying a JPEG image.
- DPOF Settings (▲) and Digital Filter (◀) cannot be selected when displaying a RAW image.

The **K200D** features a function that uses a sensor to rotate and correct the direction of the image when an image is captured.

You can also rotate the captured image 90° counterclockwise at a time with the steps below.

## 1 Press the button.

Use the four-way controller (◀▶) to display the image you want to rotate.

## 2 Press the four-way controller (▼).

The image is rotated 90° counterclockwise each time the button is pressed.

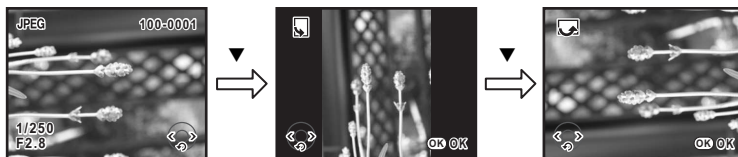

## 3 Press the OK button.

Image rotation information is saved.



You cannot save image rotation information for a protected image or an image taken with [21. Auto Image Rotation] in the [C Custom Setting] menu (p.158) set to Off.

Images can be magnified up to 16 times in playback mode.

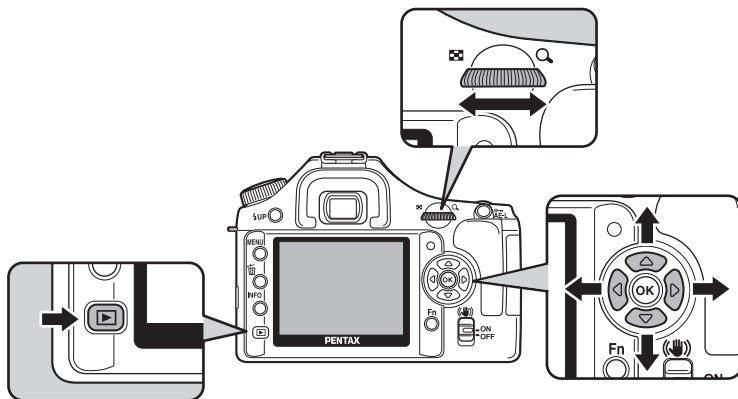

- 1** Press the  button and use the four-way controller ( ) to select an image.

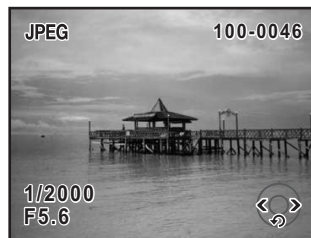







## 2 Turn the e-dial to the right (toward ).

Image enlarges at each calibration (1.2 times\* to 16 times).



### Operations available during Enlarged view

Four-way controller (     )	Moves area to enlarge
e-dial (toward right)/  <b>Av</b> button	Enlarges image (up to 16 times)
e-dial (toward left)/ <b>AE-L</b> (  ) button	Reduces image (up to 1.2 times* <sup>1</sup> )
<b>OK</b> button	Returns to the original size
<b>INFO</b> button	Switches information display On/Off
<b>Fn</b> button* <sup>2</sup>	Retains magnification and magnification area and shows image comparison (p.166)

\*1 The default setting for the first click (minimum magnification) on the e-dial (toward right) is 1.2 times. You can change this in [Playback display] in [ Playback] menu. (p.172)

\*2 During Instant Review, Enlarged view is ended and the camera returns to the Shooting Fn menu. During Digital Preview, the preview image can be saved as a JPEG image.



- You can enlarge the image by following the same procedure during Instant Review (p.59) or Digital Preview (p.113).
- The initial full display of vertical images is displayed with a magnification of 0.75 times that of horizontal images, therefore, magnification at the first click starts at 1.0 times.

You can display 4, 9 or 16 images on the monitor at the same time.

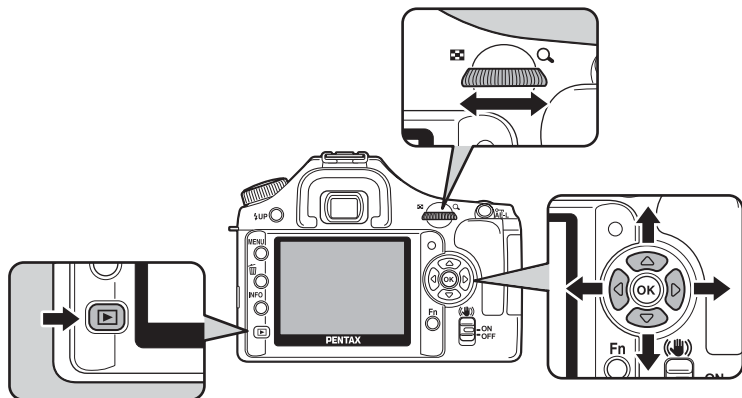



The default setting is 9-image display. The number of images can be changed but 9-image display is explained here.

## 1 Press the button.



## 2 Turn the e-dial to the left (toward ).

The multi-image display screen appears. Up to nine thumbnail images will be displayed at once. Use the four-way controller () to select an image. A scroll bar appears at the right of the screen. With an image selected in the bottom row, pressing the four-way controller () displays the next nine images.

[?] appears for an image that cannot be displayed.

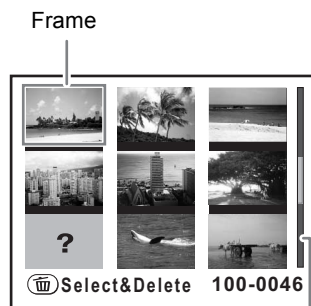

Scroll bar

- 3** Turn the e-dial to the right (towards ) or press the OK button.

A full screen display of the selected image appears.

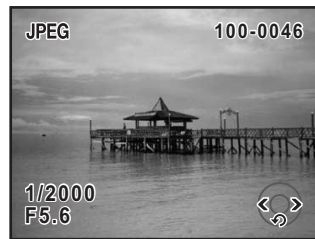





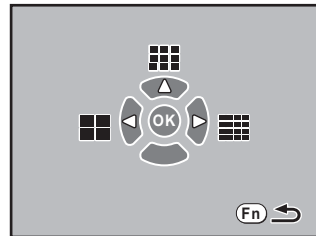

## Selecting the Number of Images to Display

- 1** In the multi-image display screen, press the Fn button.

The multi-image options screen appears.



- 2** Use the four-way controller (  ) to select the number of images to display at once.





	4 images
	9 images
	16 images

The camera returns to the multi-image display screen.

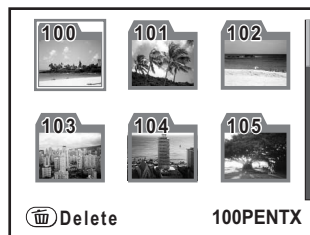
You can display the contents of folders in the multi-image display screen.

- 1 Turn the e-dial to the left (toward ) in the multi-image display screen.**



- 2 Use the four-way controller (, , , ) to select the folder you want to display and press the OK button.**

The images in the folder are displayed according to the number selected in the multi-image options screen.



Press the  button to delete all images in the selected folder. (p.176)

You can display two images side-by-side.

## 1 Press the **Fn** button in Playback mode, and then press the **OK** button.

Two images are displayed side-by-side. The same image is displayed on the left and right. Turn the e-dial to select the images to compare.



You can also press the **Fn** button in Enlarged view to display image comparison.

### Operations available during image comparison

<b>OK</b> button	The selection frame changes to both images, left image, and right image each time the button is pressed.
Four-way controller (▲▼◀▶)	Moves area to enlarge. When the selection frame is selecting both images, you can operate both images at the same time.
Green button	Returns the enlarged display position to the center.
e-dial	When the selection frame is selecting the left or right image, the previous/next image is displayed. When the selection frame is selecting both images, you can enlarge or reduce both images simultaneously in the same magnification.
<b>INFO</b> button	Switches information display On/Off.
🗑️ button	When the selection frame is selecting the left or right image, the selected image is deleted.

## 2 Press the **Fn** button.

The camera returns to the normal Playback mode.



You can play back all images recorded on your SD Memory Card successively. To start continuous playback, use the menu screen displayed on the monitor.

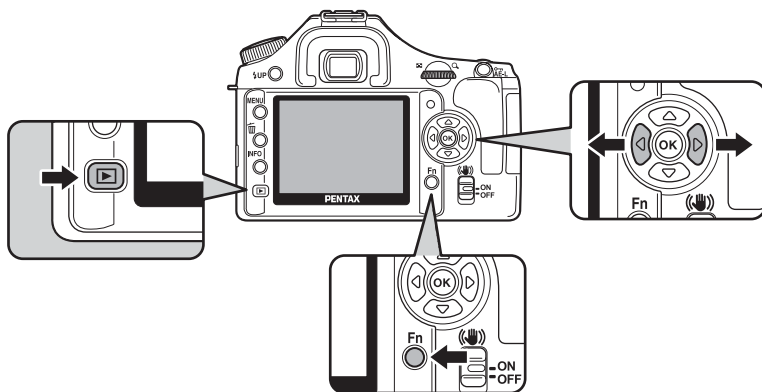

**1** Press the  button and use the four-way controller (◀▶) to select an image to be displayed first.

**2** Press the **Fn** button.

The Fn menu appears.

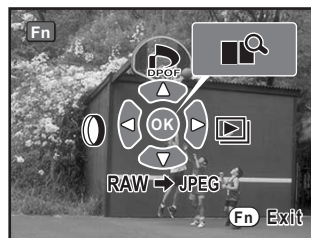

### 3 Press the four-way controller (▶).

Start screen is displayed and slideshow begins.

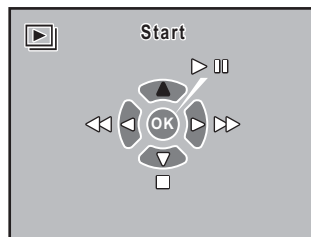

#### Operations available during a slideshow

<b>OK</b> button	Pause
Four-way controller (◀)	Shows previous image
Four-way controller (▶)	Shows next image
Four-way controller (▼)	Stop

#### Operations available when paused

<b>OK</b> button	Resumes playback (Restart)
Four-way controller (◀)	Shows previous image
Four-way controller (▶)	Shows next image
Four-way controller (▼)	Stop

7

### 4 Stop the slideshow.

Slideshow ends when one of the following is performed during playback or when paused.

- Four-way controller (▼) is pressed \*1
- [▶] button is pressed \*1
- **MENU** button is pressed \*1
- Shutter release button is pressed halfway or fully \*2
- Main switch is turned to the ⌂ position \*2
- Mode dial is turned \*2

\*1 After slideshow ends, the camera switches to normal Playback mode.

\*2 After slideshow ends, the camera switches to Capture mode.



Set the display time for slideshow in the [▶ Playback] menu. Alternatively, start the slideshow from the [▶ Playback] menu. (p.169)

## Setting the Slideshow Display Interval

Set image display interval for slideshow to [3 sec], [5 sec], [10 sec] or [30 sec]. The default setting is [3 sec].

Set whether or not to play back repeatedly. The default setting is [Off].

- 1** Select [Slideshow] in the [▶ Playback] menu.

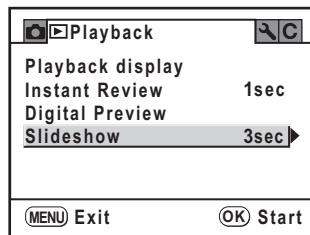

- 2** Press the four-way controller (▶).

- 3** Press the four-way controller (▶), use the four-way controller (▲▼) to select the image display interval, and then press the OK button.

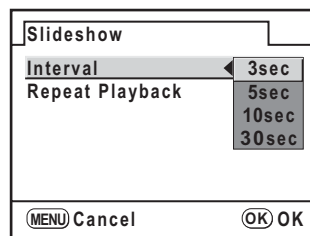

- 4** Use the four-way controller (▼) to select [Repeat Playback].

- 5** Use the four-way controller (◀▶) to select  (On) or  (Off).

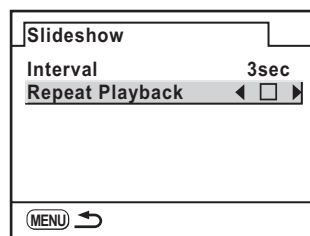

- 6** Press the MENU button.

The camera returns to the [▶ Playback] menu.

Press the **OK** button to start slideshow.

The camera switches display information when you press the **INFO** button in the Playback screen.

Standard	Captured image and indicators are displayed.
Histogram display	Images and histogram (Brightness/RGB) are displayed.
Detailed information display	Shooting information appears with a small image in the upper left.
No info. display	Only captured images are displayed.



- Refer to p.25 for various display information details.
- The information that is shown first during playback is the same as that of the last playback in the previous session. The [Standard] screen can always be displayed first by setting [Memory] (p.217) in the [Rec. Mode] menu.

## Using the Histogram

A histogram shows the brightness distribution of an image. The horizontal axis represents brightness (dark at the left and bright at the right) and the vertical axis represents the number of pixels.

The **K200D** features two histogram displays. The “Brightness histogram” shows the distribution of brightness and the “RGB histogram” shows the distribution of color intensity.

☞ Histogram Display (p.26)

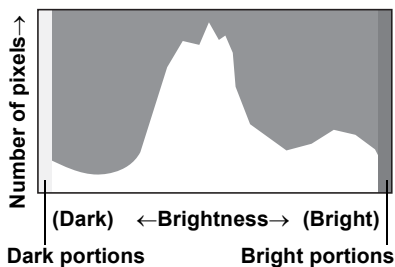

The shape of the histogram before and after shooting tells you whether the brightness and contrast are correct or not, and lets you decide if you need to use EV compensation and take the picture again.

☞ Adjusting the Exposure (p.100)

## Understanding Brightness

If the brightness is correct, the graph peaks in the middle. If the image is too dark, the peak is on the left side, and if it is too bright, the peak is on the right side.

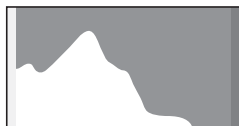

Dark image

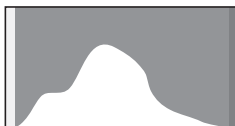

Correct image

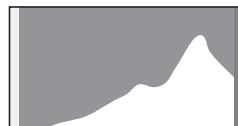

Bright image

When the image is too dark, the part to the left is cut off (dark portions with no detail) and when the image is too bright, the part to the right is cut off (bright portions with no detail).

Bright portions blink red on the monitor and dark portions blink yellow when [Bright/Dark area] is On.

☞ Playing Back Images (p.70)

☞ Setting the Display for Instant Review and Digital Preview (p.211)

## Understanding Contrast

The graph peaks gradually in the middle for images in which contrast is balanced. The graph peaks on both sides but sinks in the middle for images with a large difference in contrast and low amounts of mid-level brightness.

## Understanding Color Balance

Distribution of color intensity is displayed for each color in the RGB histogram. The right side of the graphs look similar for images that have White Balance adjusted well. If only one color is lopsided to the left, that color is too intense.

☞ Setting the White Balance (p.150)

## Setting the Playback Display

You can set whether or not to display the Bright/Dark area warning in Playback mode and set the initial magnification when enlarging images.

**1** Select [Playback display] in the [▶] Playback] menu.

**2** Press the four-way controller (▶).

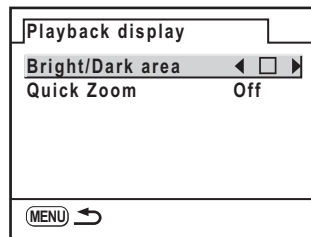

**3** Use the four-way controller (◀▶) to select  (On) or  (Off).

**4** Use the four-way controller (▼) to select [Quick Zoom].

**5** Press the four-way controller (▶) and use the four-way controller (▲▼) to select the magnification.

Select from [Off], [×2], [×4], [×8] or [×16].

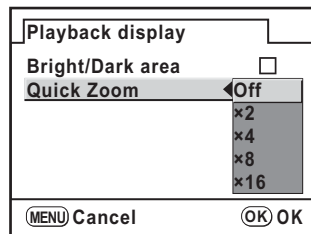

**6** Press the OK button.

**7** Press the MENU button twice.

The camera is ready to take or play back images.

## Deleting All Images

You can delete all saved images at once.



Deleted images cannot be restored.



A confirmation screen appears when there are protected images.

### 1 Press the button.

The single-image playback screen appears.

### 2 Press the button twice.

The Delete All screen appears.

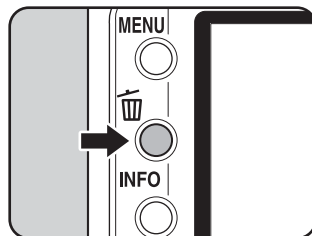

### 3 Use the four-way controller (▲▼) to select [Delete All].



## 4 Press the **OK** button.

All images are deleted.

A confirmation screen appears when there are protected images. Press the four-way controller (▲▼) to select [Delete All] or [Leave All] and press the **OK** button.



## Deleting Selected Images (from Multi-image Display)

You can delete multiple images from the multi-image display at once.



Deleted images cannot be restored.



- Protected images cannot be deleted.
- You can select up to 100 images at a time.

7

## 1 Press the **▶** button.

The single-image playback screen appears.

## 2 Turn the e-dial to the left (toward **⊞**).

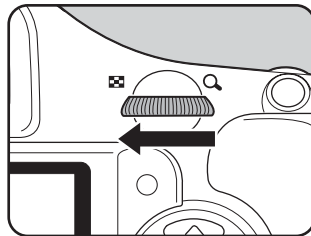



The multi-image display screen appears.



### 3 Press the button.

 appears on the images.

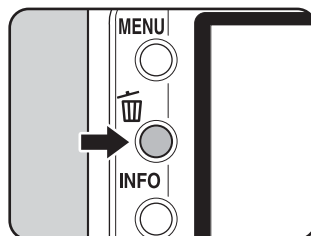

### 4 Use the four-way controller (▲▼◀▶) to move to the images to delete and press the OK button.

Image is selected and  appears.  
Protected images cannot be selected.



### 5 Press the button.

The Delete confirmation screen appears.

### 6 Use the four-way controller (▲▼) to select [Select&Delete].

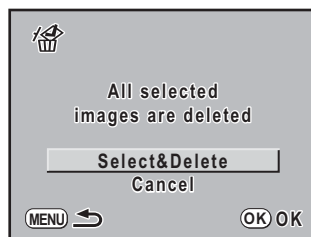

### 7 Press the OK button.





The selected images are deleted.

## Deleting a Folder

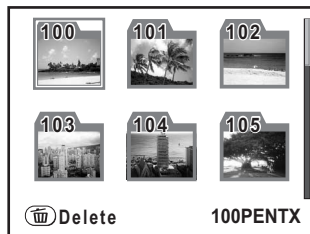
You can delete all images in a selected folder.

- 1 Turn the e-dial to the left (toward ) in Playback mode to display the folders.





- 2 Press the four-way controller (, , , ) to select the folder to delete and press the  button.

The Delete Folder confirmation screen appears.



- 3 Use the four-way controller (, ) to select [Delete].

The folder and all images in the folder are deleted.

A confirmation screen appears when there are protected images. Press the four-way controller (, ) to select [Delete All] or [Leave All] and press the **OK** button.

# Protecting Images from Deletion (Protect)

You can protect images from being accidentally deleted.



Even protected images are deleted if the inserted SD Memory Card is formatted.

## 1 Press the button and use the four-way controller (◀▶) to select an image to protect.

Select an image in the single-image playback screen.

## 2 Press the button.

The Protect screen appears.

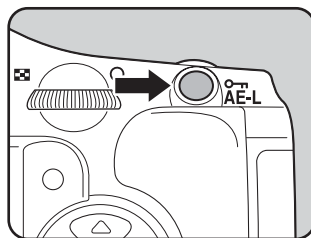

## 3 Use the four-way controller (▲▼) to select [Protect].



## 4 Press the OK button.

The selected image is protected.



- Select [Unprotect] in Step 3 to cancel the Protect setting.
- The icon is displayed when playing back protected images. (p.25)

## Protecting All Images

### 1 Press the button.

The single-image playback screen appears.

### 2 Press the button twice.

The Protect all images screen appears.

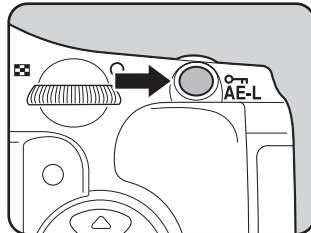

### 3 Press the four-way controller ( ) to select [Protect] and press the OK button.

All images saved in the SD Memory Card are protected.



Select [Unprotect] in Step 3 to cancel the Protect setting on all of the images.

# Connecting the Camera to AV Equipment

By using the provided video cable (I-VC28), you can play back images using a TV or other device with a video IN jack as your monitor. Make sure that both the TV and the camera are turned off before connecting the cable.

☞ Selecting the Video Output Format (p.214)

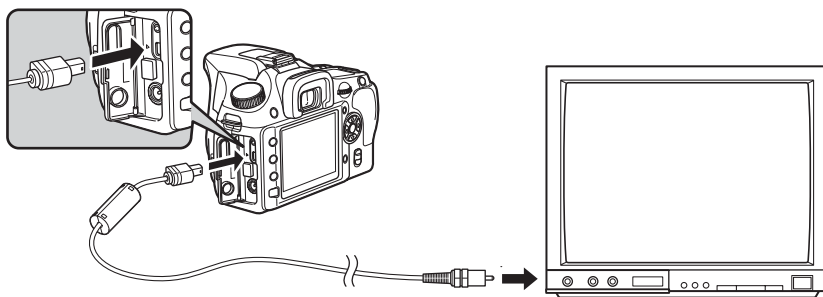

- 1** Open the terminal cover, face the arrow on the provided video cable toward the ▲ mark on the camera, and connect the video cable to the USB/Video terminal.
- 2** Connect the other end of the video cable to the video IN jack on the AV device.
- 3** Turn the AV device and camera on.



- If you intend to use the camera continuously for a long period, use of the AC adapter D-AC76 (optional) is recommended. (p.40)
- For AV equipment with multiple video IN jacks (such as TVs), check the operating manual of the AV device, and select the video IN jack to which the camera is connected.
- Depending on the country or region, images may fail to be played back if the video output format is set different from the one in use there. If this happens, change the video output format setting. (p.214)
- The camera monitor turns off while the camera is connected to the AV device.



# 8 Processing Images

---

This chapter describes how to process pictures taken and edit RAW images.

<b>Processing Images with Digital Filters .....</b>	<b>182</b>
<b>Editing RAW Images .....</b>	<b>185</b>

# Processing Images with Digital Filters

You can edit shot images using digital filters. Processed images are saved under a different name.



RAW images cannot be processed using the digital filter.

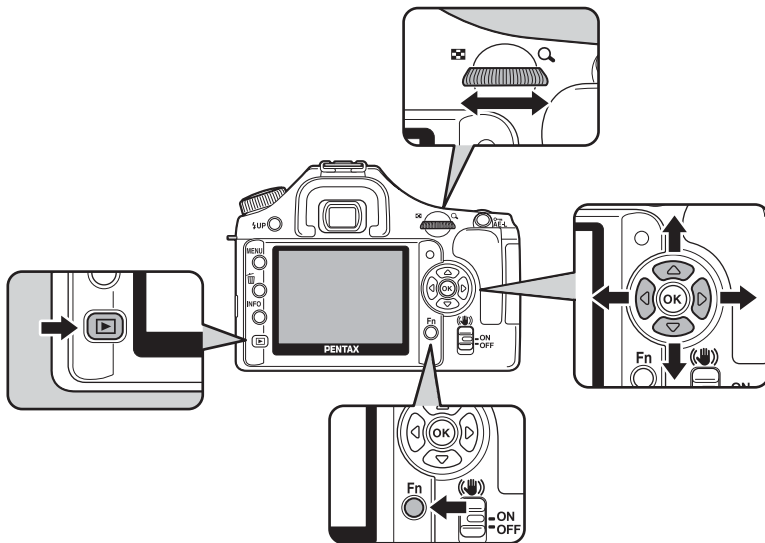

8

**1** Select an image in Playback mode.

**2** Press the Fn button.

The Fn menu appears.

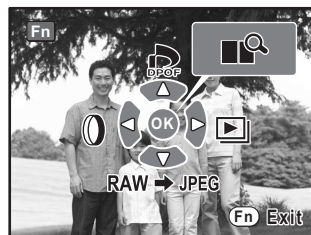



### 3 Press the four-way controller (◀).

The screen for selecting the filter appears.

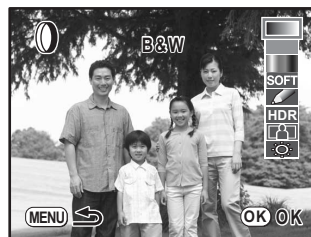

### 4 Use the four-way controller (▲▼) to select a filter.

Select a filter and preview the effects on the screen.

### 5 Adjust with e-dial and the four-way controller (◀▶).

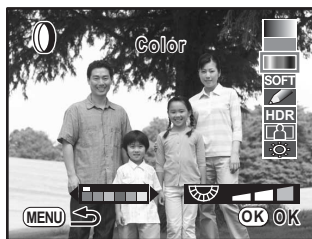

Color Filter

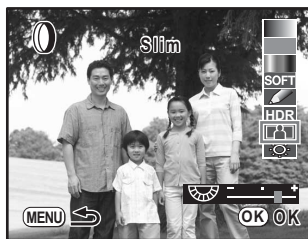

Slim Filter

Filter name	Function	e-dial	Four-way controller ◀▶
B&W	Converts to a black and white image.	—	—
Sepia	Adds a vintage touch to photos by converting them to sepia color.	—	—
Color	Adds a color filter to the image. Select from 18 filters (6 colors × 3 tones).	Density of each color (3 levels)	Red/ Magenta/ Cyan/Blue/ Green/ Yellow/
Soft	Creates a soft image by lightly fading the entire image. Select from three levels.	Soft level (3 levels)	—
Illustration	Creates an image that looks as though it was drawn with a pencil.	—	—

Filter name	Function	e-dial	Four-way controller ◀▶
HDR	Creates an image that looks as though it is a high dynamic range image. Select from three levels.	HDR level (3 levels)	—
Slim	Changes the horizontal and vertical ratio of images. Adjust height or width up to two times the original size.	Left: Wide Right: Slim	—
Brightness	Changes the brightness of images. Adjust in a range of $\pm 8$ levels.	Left: Dark Right: Light	—

## 6 Press the OK button.

The save confirmation screen appears.

## 7 Use the four-way controller (▲▼) to select [Save as].

Press the **MENU** button to return to the previous screen. Select [Cancel] and press the **OK** button to return to the single-image playback screen.



## 8 Press the OK button.

The filtered image is saved under a different name.

You can convert captured RAW files into JPEG files.



Only RAW files captured with this camera can be edited. RAW files and JPEG files captured with other cameras cannot be edited on this camera.

## Editing a RAW Image

**1** In Playback mode, select an image to edit.

**2** Press the Fn button.

The Fn menu appears.



**3** Press the four-way controller (▼).

Use the four-way controller (◀▶) to display another RAW image.

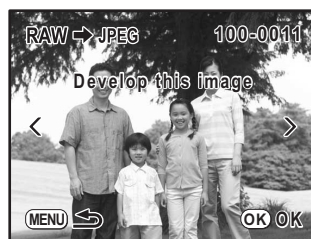

**4** Press the OK button.

The parameters recorded in the image file appear.

To specify the parameters, see “Specifying the Parameters” (p.186).

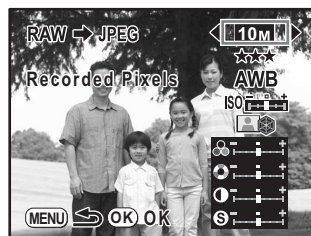

## 5 Press the OK button.

The save confirmation screen appears.

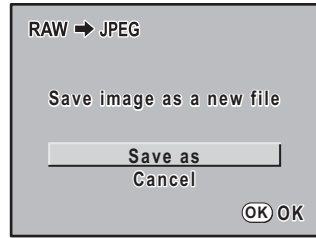

## 6 Use the four-way controller (▲▼) to select [Save as].

Press the **MENU** button to return to the previous screen. Select [Cancel] and press the **OK** button to return to the single-image playback screen.

## 7 Press the OK button.

The edited image is saved under a different name.

# Specifying the Parameters

Specifies the parameters for editing RAW images.

## 1 Press the four-way controller (▲▼) in Step 4 of p.185 to choose the parameter you want to change.

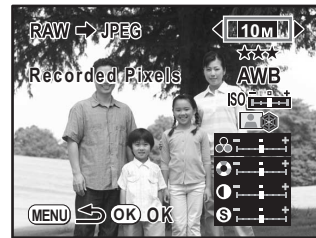

The following parameters can be changed.

Recorded Pixels	<b>10M</b> (3872×2592)/ <b>6M</b> (3008×2000)/ <b>2M</b> (1824×1216)
Quality Level	★★★ (Best)/★★ (Better)/★ (Good)
White Balance	<b>AWB</b> (Auto), ☀ (Daylight), ☷ (Shade), ☁ (Cloudy), ☼ <b>N</b> (Daylight white fluorescent lights), ☼ <b>W</b> (White light fluorescent lights), ☼ <b>D</b> (Daylight colors fluorescent lights), ⚡ (Tungsten Light), ⚡ (Flash), 📷 (Manual)
Sensitivity	-2.0~+2.0
Image Tone	Bright/Natural/Portrait/Landscape/Vibrant/ Monochrome
Saturation* <sup>1</sup>	Available settings: -4 to +4
Hue* <sup>1</sup>	Available settings: -4 to +4
Contrast	Available settings: -4 to +4
Sharpness	Available settings: -4 to +4
Filter Effect* <sup>2</sup>	None/Green/Yellow/Orange/Red/Magenta/Blue/ Cyan/Infrared Color
Toning* <sup>2</sup>	Available settings: -4 to +4

\*1 This can be set when any mode other than [Monochrome] is selected.

\*2 This can be set when [Monochrome] is selected.

## 2 Use the four-way controller (◀▶) to change the parameter.

To make settings for White Balance and Custom Image, see “Adjusting the White Balance” (p.150) and “Setting the Image Processing Method in Capture Mode (Custom Image)” (p.144).



- Measured white balance values stored in the camera are applied with Manual White Balance. To re-measure the white balance, be sure to measure the white balance using the Shooting Fn menu beforehand. Refer to “Adjusting the White Balance Manually” (p.152).
- For [Sharpness], turn the e-dial to switch between [Fine Sharpness] and [Sharpness]. The image outlines are even thinner and sharper with [Fine Sharpness], making it suited for capturing fine subjects such as hair.

---

**3 Press the OK button.**

The save confirmation screen appears.

---

**4 Use the four-way controller (▲▼) to select [Save as] and press the OK button.**

The RAW image is edited and saved as a new image.

# 9 Printing from the Camera

---

This chapter describes how to make the printing settings.

<b>Setting the Printing Service (DPOF) .....</b>	<b>190</b>
<b>Printing Using PictBridge .....</b>	<b>193</b>

# Setting the Printing Service (DPOF)

You can order conventional photograph prints by taking the SD Memory Card with recorded images to a store for printing.

DPOF (Digital Print Order Format) settings allow you to specify the number of copies and to imprint the date.



- DPOF settings cannot be applied to RAW images.
- You can make DPOF settings for up to 999 images.

## Printing Single Images

Set the following items for each image.

Copies	Selects the number of copies. You can print up to 99 copies.
Date	Specifies whether you want the date inserted on the print or not.

### 1 Press the button and use the four-way controller (◀▶) to select an image.

Select the image to set DPOF settings for in the single-image playback screen.

### 2 Press the Fn button.

The Fn menu appears.



### 3 Press the four-way controller (▲).

The DPOF screen appears.

If DPOF settings have already been made for an image, the previous number of prints and date setting ( (On) or  (Off)) will be displayed.





## 4 Use the four-way controller (◀▶) to choose the number of copies and press the four-way controller (▼).

The frame moves to [Date].

## 5 Use the four-way controller (◀▶) to choose whether to insert the date (☑) or not (☐).

☑ : The date will be printed.

☐ : The date will not be printed.

You can select the next or previous image by turning the e-dial. Repeat Steps 4 and 5 to set multiple images (up to 999).



## 6 Press the OK button.

The edited DPOF settings for all images are saved and the camera returns to the single-image playback screen.



Depending on the printer or printing equipment at the photo processing lab, the date may not be imprinted on the pictures even if the DPOF setting was made.



- To cancel DPOF settings, set the number of copies to [00] in Step 4 and press the **OK** button.
- Press the **MENU** button while setting to cancel editing of all images.

## Settings for All Images

### 1 Press the Fn button in Playback mode.

The Fn menu appears.



## 2 Press the four-way controller (▲).

The DPOF screen appears.



## 3 Press the Fn button.

The screen for making DPOF settings for all images appears.

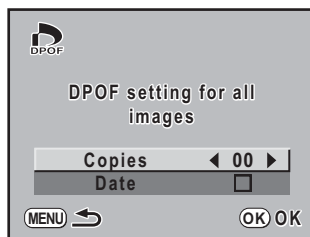

## 4 Use the four-way controller (◀▶) to choose the number of copies and whether to insert the date (☑) or not (☐).

Refer to Steps 4 and 5 of “Printing Single Images” (p.191) for details of how to make the settings.

## 5 Press the OK button.

The DPOF settings for all images are saved and the camera returns to the single-image playback screen.

9



The number of copies specified in settings for all images applies to all the images. Before printing, check that the number is correct.



Settings for single images are canceled when settings are made for all images.

This function lets you print images directly from the camera without using a PC (direct printing).

Connect the camera and PictBridge compatible printer with the included USB cable (I-USB17) to print directly.

Select the images you want to print, the number of copies and whether to insert the date or not on the camera after connecting to the printer.

Direct printing is performed in the following steps.

Set Transfer mode on camera to [PictBridge] (p.194)



Connect the camera to the printer (p.195)



Set the printing options

Print single images (p.196)

Print all images (p.198)

Print with DPOF settings (p.199)



- Use of the AC adapter D-AC76 (optional) is recommended when connecting the camera to a printer. The printer may not work properly or the image data may be lost if the battery set runs out of power while the camera is connected to the printer.
- Do not disconnect the USB cable during data transfer.
- Depending on the type of printer, not all the settings made on the camera (such as print settings and DPOF settings) may be valid.
- A printing error may occur if the selected number of copies exceeds 500.
- Printing an index of images, where multiple images appear on a single sheet, may not be possible unless the printer supports index printing. For index prints, you may need to use a PC.
- RAW images cannot be printed directly from the camera. Use [RAW display] (p.185) to convert to a JPEG image or transfer to a PC and use PENTAX PHOTO Browser 3 to print RAW images.
- See the “PENTAX PHOTO Browser 3/PENTAX PHOTO Laboratory 3 Operating Manual” when connecting to a PC.

## Setting Transfer Mode

### 1 Press the **MENU** button.

The [📷 Rec. Mode] menu or [▶ Playback] menu appears.

### 2 Use the four-way controller (◀▶) to select the [🔧 Set-up] menu.

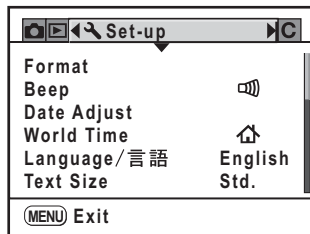

### 3 Use the four-way controller (▲▼) to select [USB Connection].

### 4 Press the four-way controller (▶).

A pop-up menu appears.

### 5 Use the four-way controller (▲▼) to select [PictBridge].

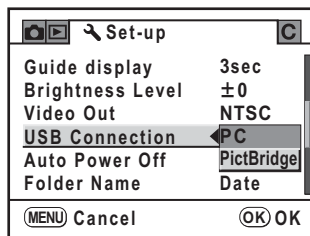

### 6 Press the **OK** button.

The setting is changed.

### 7 Press the **MENU** button.

## Connecting the Camera to the Printer

- 1 Turn off the camera.
- 2 Face the arrow on the provided USB cable toward the ▲ mark on the camera, and connect the camera and PictBridge compatible printer.

The PictBridge logo is displayed on PictBridge compatible printers.

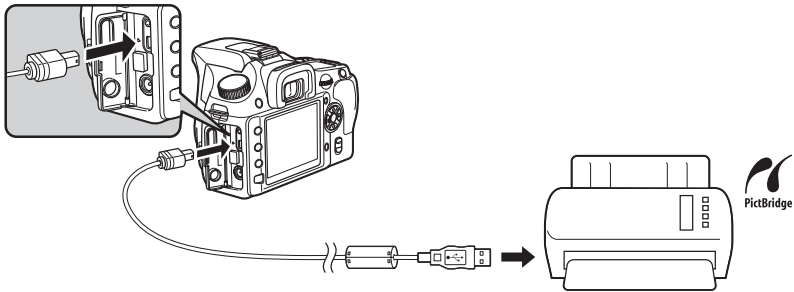

- 3 Turn the printer on.
- 4 After the printer start-up, turn the camera on.

The PictBridge menu appears.

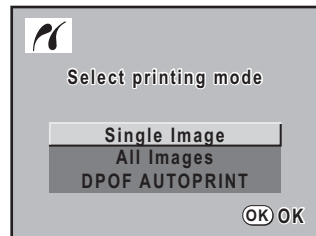

PictBridge menu is not displayed if [USB Connection] is set to [PC].

## Printing Single Images

- 1 Use the four-way controller (▲▼) to select [Single Image] on the PictBridge menu.

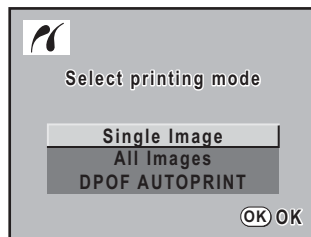

- 2 Press the OK button.

The Print single image screen appears.

- 3 Use the four-way controller (◀▶) to choose an image to print.

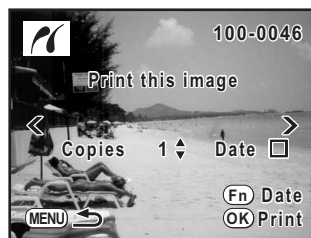

- 4 Use the four-way controller (▲▼) to choose the number of copies.

You can print up to 99 copies.

- 5 Use the Fn button to choose whether to insert the date () or not ()

: The date will be printed.

: The date will not be printed.

- 6 Press the OK button.

The print settings confirmation screen appears.

Proceed to Step 12 to print the images using the default setting.

To change the print settings, go to Step 7.

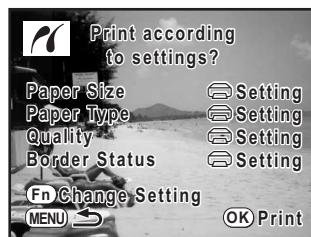

## 7 Press the Fn button.

The screen for changing print settings appears.

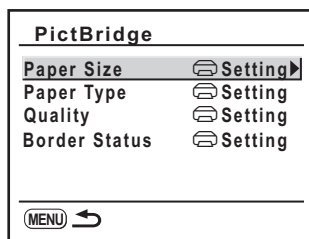

## 8 Select [Paper Size] and press the four-way controller (▶).

The [Paper Size] screen appears.

## 9 Use the four-way controller (▲▼◀▶) to choose the paper size.

You can only choose a size that is supported by your printer.

When [Setting] is selected, images are printed according to the printer settings.

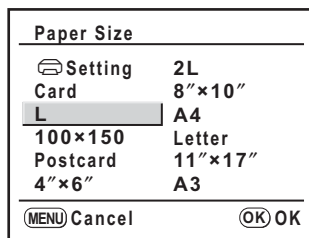

## 10 Press the OK button.

## 11 Repeat Steps 8 to 10 to set [Paper Type], [Quality] and [Border Status].

The print settings change screen appears after each item has been set. When [Setting] is selected for these print settings, images are printed according to the printer settings.

[Paper Type] with more ★s supports higher quality paper.

[Quality] with more ★s indicates higher print quality.

## 12 Press the MENU button.

The camera returns to the print settings confirmation screen in Step 6.

## 13 Press the OK button.

The image is printed according to the settings.

Press the **MENU** button to cancel printing.

## Printing All Images

- 1 Use the four-way controller (▲▼) to select [All Images] on the PictBridge menu.

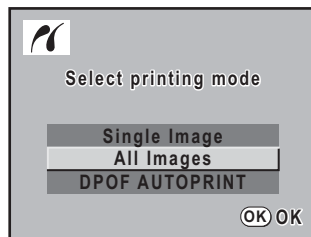

- 2 Press the **OK** button.

The Print all images screen appears.

- 3 Choose the number of copies and whether to imprint the date or not.

The number of copies and the date setting that you choose apply to all of the images. Refer to Steps 4 and 5 of "Printing Single Images" (p.196) for details on how to make the settings.

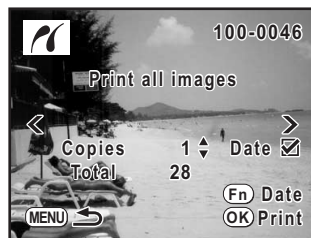

Use the four-way controller (◀▶) to check the images set to be printed.

9

- 4 Press the **OK** button.

The print settings confirmation screen appears.

Refer to Steps 7 to 11 of "Printing Single Images" (p.197) for details on how to change the settings.

- 5 Press the **OK** button on the print settings confirmation screen.

All the images are printed according to the settings.

Press the **MENU** button to cancel printing.



## Printing Images Using the DPOF Settings

**1** Use the four-way controller (▲▼) to select [DPOF AUTOPRINT] on the PictBridge menu.

**2** Press the **OK** button.

The Print w/DPOF settings screen appears.

Use the four-way controller (◀▶) to check the number of copies for each image, whether the date is imprinted or not, and total number of copies.

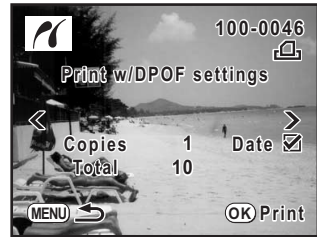

**3** Press the **OK** button.

The print settings confirmation screen appears.

Refer to Steps 7 to 11 of “Printing Single Images” (p.197) for details on how to change the settings.

**4** Press the **OK** button on the print settings confirmation screen.

The images are printed according to the settings.

Press the **MENU** button to cancel printing.

## Disconnecting the USB Cable

Disconnect the USB cable from the camera and printer when you have finished printing.

**1** Turn off the camera.

**2** Disconnect the USB cable from the camera and printer.

**Memo**



# 10 Camera Settings

---

This chapter describes how to change the camera settings.

<b>How to Operate the [ Set-up] Menu .....</b>	<b>202</b>
<b>Formatting the SD Memory Card .....</b>	<b>203</b>
<b>Setting the Beep Setting, Date and Time, and Display Language .....</b>	<b>204</b>
<b>Adjusting the Monitor and the Menu Display .....</b>	<b>210</b>
<b>Setting the Image Folder Naming Convention .....</b>	<b>213</b>
<b>Selecting the Video Output Format and Power Settings .....</b>	<b>214</b>
<b>Using Pixel Mapping .....</b>	<b>216</b>
<b>Selecting Capture Mode Settings to Save in the Camera .....</b>	<b>217</b>

# How to Operate the [ Set-up ] Menu

Press the **MENU** button and use the four-way controller (   ) to display the [  Set-up ] menu.

## [ Set-up ] Menu Setting Items

Perform various settings related to the camera in the [  Set-up ] menu.

Item	Function	Page
Format	Formats the SD Memory Card.	p.203
Beep	Switches the beep tone on/off.	p.204
Date Adjust	Sets the date format and time.	p.205
World Time	Sets display of local date and time of a specified city in addition to the present location on the monitor when traveling overseas.	p.206
Language/言語	Changes the language in which menus and messages appear.	p.209
Text Size	Sets the size of the text selected in the menus.	p.210
Guide display	Sets to display indicators in the monitor.	p.210
Brightness Level	Changes the brightness of the monitor.	p.211
Video Out	Sets the output format to the TV monitor.	p.214
USB Connection*	Sets the USB cable connection (PC or printer).	p.194
Auto Power Off	Sets the time to turn off automatically.	p.214
Folder Name	Sets the method used to assign folder names for storing images.	p.213
Select battery	Sets battery priority for when the optional Battery Grip D-BG3 is attached.	p.215
Pixel Mapping	Maps out and corrects for any defective pixels in the CCD.	p.216
Dust Alert	Detects dust adhering to the CCD.	p.231
Dust Removal	Cleans the CCD by shaking it.	p.231
Sensor Cleaning	Locks the mirror in the up position for cleaning the CCD.	p.233
Reset	Resets all settings.	p.220

\* Refer to p.11 of the "PENTAX PHOTO Browser 3/PENTAX PHOTO Laboratory 3 Operating Manual" for details on connecting the camera to a PC.

Use this camera to format (initialize) an SD Memory Card that is unused or has been used on other cameras or digital devices.

Formatting will delete all the data on the SD Memory Card.



- Do not open the card cover while formatting SD Memory Card. The card may be damaged beyond use.
- Formatting will delete all data, either protected or unprotected. Be aware.

---

**1** Select **[Format]** in the **[↶ Set-up]** menu.

---

**2** Press the four-way controller (▶).

The **[Format]** screen appears.

---

**3** Use the four-way controller (▲▼) to select **[Format]**.

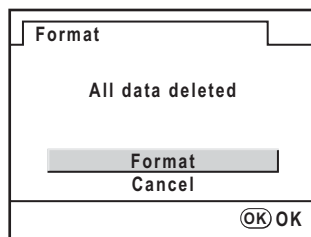

---

**4** Press the **OK** button.

Formatting starts.

When formatting is completed, the monitor turns off and the camera is ready to take pictures.

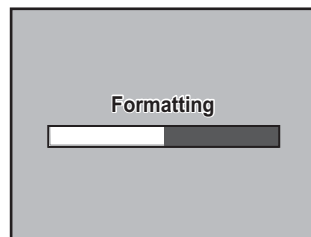

# Setting the Beep Setting, Date and Time, and Display Language

## Turning the Beep On and Off

You can turn the camera operation beep on or off. The default setting is all  (On).

There are five items that you can set: In-focus, AE Lock, **RAW** button, Self-timer and Remote Control.

- 1 Select **[Beep]** in the [**Set-up**] menu.

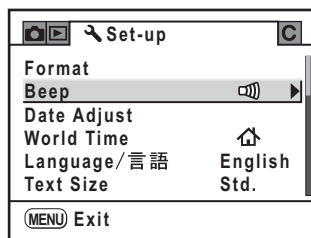

- 2 Press the four-way controller (**▶**).

The **[Beep]** screen appears.

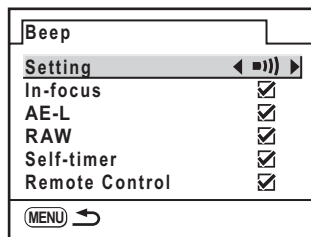

- 3 Select an item and use the four-way controller (**◀▶**) to select **On** () or **Off** ()

You can turn all the beeps off by selecting [**Setting**] and using the four-way controller (**◀▶**) to select **Off** ()

- 4 Press the **MENU** button twice.

The camera is ready to take a picture.

## Changing the Date and Time and the Display Style

You can change the initial date and time settings. You can also set the display style. Choose [mm/dd/yy], [dd/mm/yy] or [yy/mm/dd]. Choose [12h] (12 hour) or [24h] (24 hour) for time display method.

Set in [Date Adjust] in the [ Set-up] menu (p.202).

 Setting the Date and Time (p.52)

Date Adjust	
Date Style	mm/dd/yy 24h
Date	01 / 01 / 2008
Time	00 : 00
[MENU] Cancel      [OK] OK	

## Setting the World Time

The date and time selected in “Initial Settings” (p.49) serve as the date and time of your present location.

Setting [World Time] enables you to display the local date and time on the monitor when traveling overseas.

**1** Select [World Time] in the [ Set-up] menu.

**2** Press the four-way controller ().

The [World Time] screen appears.



**3** Use the four-way controller ( ) to select  (Destination) or  (Hometown).

This setting changes the date and time on the guide display screen.

**4** Press the four-way controller ().

The selection frame moves to  (Destination setting).

**5** Press the four-way controller ().

The screen for magnifying the Destination region appears.

**6** Use the four-way controller ( ) to select the Destination city.

Turn the e-dial to change the region to magnify.

The current time, location and time difference of the selected city appears.

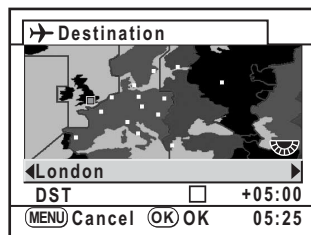



**7** Use the four-way controller (▼) to select [DST].

**8** Use the four-way controller (◀▶) to select  (On) or  (Off).

Select  (On) if the Destination city uses daylight saving time (DST).

**9** Press the OK button.

The World Time setting is saved.

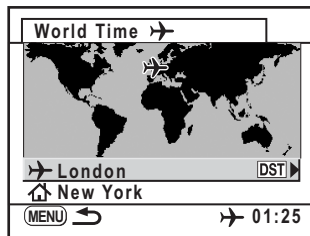

**10** Press the MENU button twice.

The camera is ready to take a picture.



- See "List of World Time Cities" (p.208) for cities that can be specified as a destination.
- Select 🏠 (Hometown setting) in Step 4 to set the city and DST setting.
- ✈️ appears on the guide display screen if World Time is set to ✈️ (Destination). (p.22)
- When you change World Time, the Video Out (p.214) setting changes to the default setting for that city.

## List of World Time Cities

Region	City	Region	City
North America	Honolulu	Africa/ West Asia	Dakar
	Anchorage		Algiers
	Vancouver		Johannesburg
	San Francisco		Istanbul
	Los Angeles		Cairo
	Calgary		Jerusalem
	Denver		Nairobi
	Chicago		Jeddah
	Miami		Tehran
	Toronto		Dubai
	New York		Karachi
	Halifax		Kabul
Central and South America	Mexico City	Male	
	Lima	Delhi	
	Santiago	Colombo	
	Caracas	Kathmandu	
	Buenos Aires	Dacca	
	Sao Paulo	East Asia	Yangon
	Rio de Janeiro		Bangkok
Europe	Lisbon		Kuala Lumpur
	Madrid		Vientiane
	London		Singapore
	Paris		Phnom Penh
	Amsterdam		Ho chi Minh
	Milan		Jakarta
	Rome		Hong Kong
	Copenhagen		Beijing
	Berlin	Shanghai	
	Prague	Manila	
	Stockholm	Taipei	
	Budapest	Seoul	
	Warsaw	Tokyo	
	Athens	Guam	
	Helsinki		
Moscow			

Region	City
Oceania	Perth
	Adelaide
	Sydney
	Noumea
	Wellington
	Auckland
	Pago Pago

## Setting the Display Language

You can change the language in which the menus, error messages, etc. are displayed.

Set in [Language/言語] in the [ Set-up] menu (p.202).

You can choose from 18 languages: English, French, German, Spanish, Portuguese, Italian, Dutch, Danish, Swedish, Finnish, Polish, Czech, Hungarian, Turkish, Russian, Korean, Chinese (Traditional/Simplified) and Japanese.

 Setting the Display Language (p.49)

Language/言語		
English	Dansk	Русский
Français	Svenska	한국어
Deutsch	Suomi	中文繁體
Español	Polski	中文简体
Portugués	Čeština	日本語
Italiano	Magyar	
Nederlands	Türkçe	
[MENU] Cancel		[OK] OK

# Adjusting the Monitor and the Menu Display

## Setting the Text Size

You can set the size of the text selected in the menus to [Std.] (normal display) or [Large] (magnified display).

Set in [Text Size] in the [ Set-up] menu (p.202).

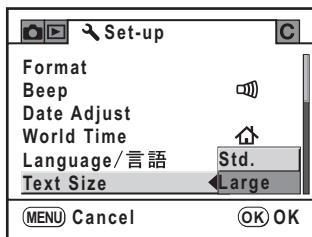

## Setting the Guide Display Time

Set the length of time that the guides are displayed on the monitor when the camera is turned on or the exposure mode is changed. (p.22)

Select from [Off], [3 sec], [10 sec] and [30 sec]. The default setting is [3 sec].

Set in [Guide display] in the [ Set-up] menu (p.202).

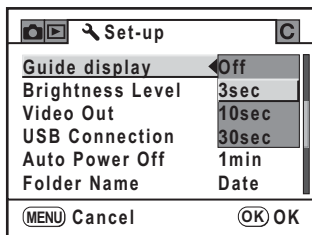

## Adjusting the Brightness of the Monitor

You can adjust the brightness of the monitor. Adjust settings when the monitor is hard to see.

Set in [Brightness Level] in the [ Set-up] menu (p.202).

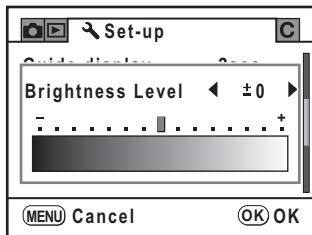

## Setting the Display for Instant Review and Digital Preview

You can adjust the settings related to Instant Review and Digital Preview.

### Setting the Instant Review

You can set the Instant Review display time and whether or not to display the histogram and Bright/Dark area warning. The default settings are [1 sec] for the display time and [Off] for the histogram and Bright/Dark area warning.

**1** Select [Instant Review] in the [ Playback] menu.

**2** Press the four-way controller ().

The [Instant Review] screen appears.

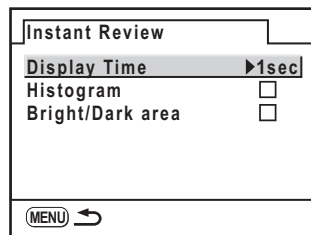

- 3** Press the four-way controller (▶) and use the four-way controller (▲▼) to select from [1 sec], [3 sec], [5 sec] or [Off], and then press the OK button.

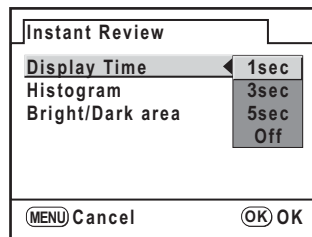

- 4** Use the four-way controller (▼) to select [Histogram].

- 5** Use the four-way controller (◀▶) to select  (On) or  (Off) for [Histogram].

- 6** Use the four-way controller (▼) to select [Bright/Dark area].

- 7** Use the four-way controller (◀▶) to select  (On) or  (Off).

- 8** Press the MENU button twice.

The camera is ready to take a picture.

## Setting the Digital Preview

You can set whether or not to display the histogram and Bright/Dark area warning during Digital Preview. The default setting is [Off] for the histogram and Bright/Dark area warning.

- 1** Select [Digital Preview] in the [▶] Playback] menu.

- 2** Press the four-way controller (▶).

The [Digital Preview] screen appears. Proceed as from Step 4 in Instant Review.

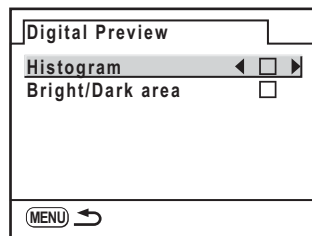

## Selecting the Folder Name

You can select the method for assigning the folder names for storing images. The default setting is [Date].

Date	The two digits of the [month] and [day] on which the picture was taken are assigned as the folder name in the form of [xxx_MMDD]. [xxx] is a sequential number from 100 to 999. [MMDD] (month and day) appears according to the display style set in [Date Adjust] (p.205). (Example) 101_0125: for folders with pictures taken on January 25th
PENTX	The folder name is assigned in the form of [xxxPENTX]. (Example) 101PENTX

Set in [Folder Name] in the [ Set-up] menu (p.202).

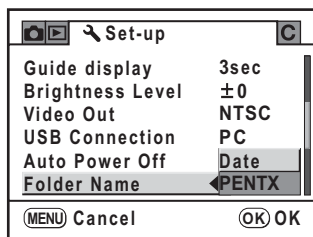

## Selecting the File Number Setting

You can select the method for assigning the file number of an image when saved to a new folder. Select  (On) or  (Off) for [File No.] in [Memory] in the [ Rec. Mode] menu. (p.217)

<input checked="" type="checkbox"/> (On)	The file number of the last image saved to the previous folder is saved and subsequent images are assigned sequential file numbers even if a new folder is created.
<input type="checkbox"/> (Off)	The file number of the first image saved to a folder returns to 0001 each time a new folder is created for saving images.



When the number of storable images exceeds 500, captured images are divided into folders of 500 images each. However, in Auto Bracket, images will be stored in the same folder until shooting is completed, even if the number of images exceeds 500.

# Selecting the Video Output Format and Power Settings

## Selecting the Video Output Format

When you connect the camera to AV equipment such as a TV, choose the appropriate video output format (NTSC or PAL) for playing back images. Set in [Video Out] in the [ Set-up] menu (p.202).

Connecting the Camera to AV Equipment (p.179)

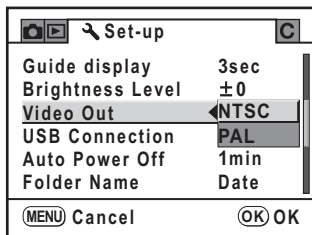

The default video output format differs depending on the region. When you change the region set in World Time, the Video Out setting changes to the default setting for that city.

## Setting Auto Power Off

You can set the camera to turn off automatically if unused after a certain length of time. Select from [1 min], [3 min], [5 min], [10 min], [30 min] or [Off]. The default setting is [1 min].

Set in [Auto Power Off] in the [ Set-up] menu (p.202).

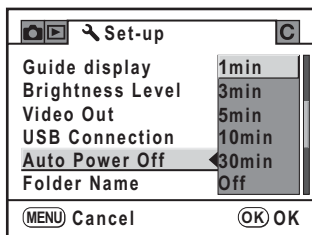

Auto Power Off will not work during slideshow playback or USB connection.



## Selecting a Battery

You can set the battery priority to the camera or the battery grip when the optional Battery Grip D-BG3 (p.235) is attached. The default setting is [Auto Select].

**1** Select [Select battery] in the [ Set-up] menu.

**2** Press the four-way controller (▶).

The [Select battery] screen appears.

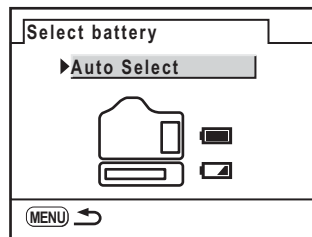

**3** Press the four-way controller (▶).

**4** Use the four-way controller (▲ ▼) to select from [Auto Select], [Body First] and [Grip First].

Auto Select: Priority is given to the battery set with more power.

Body First/Grip First: Priority is given to the selected battery set.

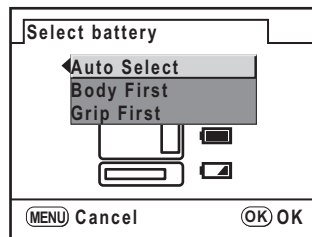

**5** Press the OK button.

**6** Press the MENU button twice.

The camera is ready to take a picture.



- If batteries are inserted into both the body and grip, the battery levels of both are checked when the power is turned on. Regardless of the [Select Battery] settings, both batteries are slightly used.
- When the currently selected battery set runs out as a result of the check, [Battery depleted] appears on the monitor. Turn the camera off and on again, and the camera will switch to the battery set with power remaining.

# Using Pixel Mapping

Pixel mapping is a function for mapping out and correcting for defective pixels in the CCD.

**1** Select **[Pixel Mapping]** in the **[↶ Set-up]** menu.

**2** Press the four-way controller **(▶)**.

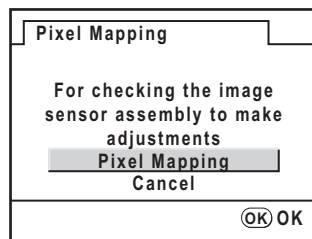

**3** Press the four-way controller **(▲▼)** to select **[Pixel Mapping]** and press the **OK** button.

Defective pixels are mapped and corrected.



When the battery level is low, [Not enough battery remaining to activate Pixel Mapping] is displayed on the monitor. Use the AC adapter D-AC76 (optional) or use batteries with ample power remaining.

# Selecting Capture Mode Settings to Save in the Camera

You can select which settings to save when the camera is turned off. The following settings can be saved: Flash mode, Drive mode, White Balance, Sensitivity, EV Compensation, Flash Exp. Comp., Playback Display, Scene Display and File No. The default setting is [Off] for [Scene Display], and [On] for the other settings.

**1** Select [Memory] in the [📷 Rec. Mode] menu.

**2** Press the four-way controller (▶).

The [Memory] screen appears.

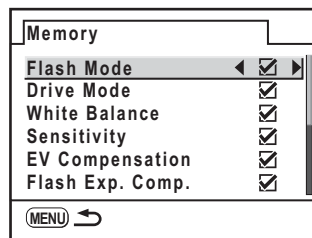

**3** Use the four-way controller (▲ ▼) to choose an item.

**4** Use the four-way controller (◀ ▶) to select  (On) or  (Off).

**5** Press the MENU button twice.

The camera is ready to take a picture.



[File No.] sets whether to save a sequential number for the file name. See "Selecting the File Number Setting" (p.213).



# 11 Resetting to Default Settings

---

Resets the camera settings.

**Resetting Rec. Mode/Playback/ Set-up Menu ..220**

**Resetting the Custom Function Menu .....221**

# Resetting Rec. Mode/Playback/ Set-up Menu

Settings in [📷 Rec. Mode] menu, [▶ Playback] menu and [⚙️ Set-up] menu can be reset to default settings.

However, Date Adjust, Language/言語, Video Out, Text Size, and the World Time city settings are not reset.

**1** Select [Reset] in the [⚙️ Set-up] menu.

**2** Press the four-way controller (▶).

The [Reset] screen appears.

**3** Use the four-way controller (▲▼) to select [Reset].

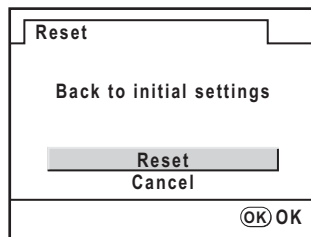

**4** Press the OK button.

The settings are reset and the camera is ready to take or play back images.

Reset settings in [C Custom Setting] menu to default settings.

**1** Select [Reset Custom Function] in the [C Custom Setting] menu.

**2** Press the four-way controller (▶).

The [C Reset Custom Function] screen appears.

**3** Use the four-way controller (▲▼) to select [Reset].

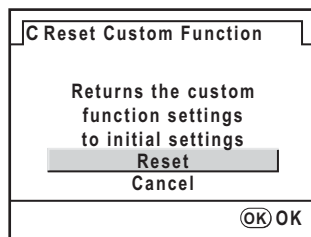

**4** Press the OK button.

The settings are reset and the camera is ready to take or play back images.





# 12 Appendix

---

<b>Default Settings .....</b>	<b>224</b>
<b>Functions Available with Various Lens Combinations .....</b>	<b>228</b>
<b>Notes on [23. Using Aperture Ring] .....</b>	<b>230</b>
<b>Cleaning the CCD .....</b>	<b>231</b>
<b>Optional Accessories .....</b>	<b>235</b>
<b>Error Messages .....</b>	<b>240</b>
<b>Troubleshooting .....</b>	<b>243</b>
<b>Main Specifications .....</b>	<b>246</b>
<b>Glossary .....</b>	<b>250</b>
<b>Index .....</b>	<b>255</b>
<b>WARRANTY POLICY .....</b>	<b>260</b>

# Default Settings

The table below lists the factory default settings.



The current setting (last memory) is saved when the camera is turned off.

## Reset Setting

Yes : The setting returns to the default setting with the reset function (p.219).

No : The setting is saved even after reset.

## [📷 Rec. Mode] Menu

Item		Default Setting	Reset Setting	Page
AF Mode		<b>A.F.S</b>	Yes	p.104
AE Metering		 (Multi-segment)	Yes	p.98
Select AF point		 (Auto)	Yes	p.105
File Format		JPEG	Yes	p.148
JPEG Recorded Pixels		 (3872×2592)	Yes	p.146
JPEG Quality		★★★ (Best)	Yes	p.147
RAW file format		PEF	Yes	p.148
Color Space		sRGB	Yes	p.155
RAW button	Cancel each time	<input checked="" type="checkbox"/> (On)	Yes	p.149
	JPEG/RAW/RAW+ File Format	All RAW+	Yes	
Memory		<input checked="" type="checkbox"/> (On) other than [Scene Display]	Yes	p.217
Input Focal Length		35 (Focal Length)	Yes	p.69

## [▶ Playback] Menu

Item		Default Setting	Reset Setting	Page
Playback display	Bright/Dark area	<input type="checkbox"/> (Off)	Yes	p.172
	Quick Zoom	<input type="checkbox"/> (Off)	Yes	
Instant Review	Display Time	1 sec	Yes	p.211
	Histogram	<input type="checkbox"/> (Off)	Yes	
	Bright/Dark area	<input type="checkbox"/> (Off)	Yes	

Item		Default Setting	Reset Setting	Page
Digital Preview	Histogram	<input type="checkbox"/> (Off)	Yes	p.212
	Bright/Dark area	<input type="checkbox"/> (Off)	Yes	
Slideshow	Interval	3 sec	Yes	p.169
	Repeat Playback	<input type="checkbox"/> (Off)	Yes	

## [↶ Set-up] Menu

Item		Default Setting	Reset Setting	Page
Format		—	—	p.203
Beep		All <input checked="" type="checkbox"/> (On)	Yes	p.204
Date Adjust		According to default setting	No	p.205
World Time	World Time setting	(Hometown)	Yes	p.206
	Hometown (City)	According to default setting	No	
	Hometown (DST)	According to default setting	No	
	Destination (City)	Same as Hometown	No	
	Destination (DST)	Same as Hometown	No	
Language/言語		According to default setting	No	p.209
Text Size		According to default setting	No	p.210
Guide display		3 sec	Yes	p.210
Brightness Level		±0	Yes	p.211
Video Out		According to default setting	No	p.214
USB Connection		PC	Yes	p.194
Auto Power Off		1 min	Yes	p.214
Folder Name		Date	Yes	p.213
Select battery		Auto Select	Yes	p.215
Pixel Mapping		—	—	p.216
Dust Alert		—	—	p.231
Dust Removal	Dust Removal	—	—	p.231
	Start-up action	<input type="checkbox"/> (Off)	Yes	

Item	Default Setting	Reset Setting	Page
Sensor Cleaning	—	—	p.233
Reset	—	—	p.220

### [C Custom Setting] Menu

Item	Default Setting	Reset Setting	Page
Settings	<input type="checkbox"/> (Off)	Yes	p.75
1. EV Steps	1/2 EV Steps	Yes	p.101
2. Sensitivity Steps	1 EV Steps	Yes	p.83
3. Meter Operating Time	10 sec	Yes	p.99
4. <b>AE-L</b> with AF locked	Off	Yes	p.108
5. Link AF Point and AE	Off	Yes	p.99
6. Auto Bracketing order	0 - +	Yes	p.124
7. Adjust White Balance	Off	Yes	p.154
8. Superimpose AF Area	On	Yes	p.105
9. AF in remote control	Off	Yes	p.121
10. Slow Shutter Speed NR	On	Yes	p.85
11. High-ISO Noise Reduction	Off	Yes	p.85
12. <b>OK</b> button when shooting	Sensitivity/ No. of Shots	Yes	p.103
13. e-dial in Program	Program shift	Yes	p.88
14. Green button in Manual	Program Line	Yes	p.96
15. Release when Charging	Off	Yes	p.129
16. Flash in Wireless Mode	On	Yes	p.138
17. WB when using flash	Flash	Yes	p.151
18. Preview Method	Digital Preview	Yes	p.112
19. Display Sensitivity	Off	Yes	—
20. Saving rotation info	On	Yes	—
21. Auto Image Rotation	On	Yes	—
22. Catch-in focus	Off	Yes	p.111
23. Using aperture ring	Prohibited	Yes	p.230
Reset Custom Function*	—	—	p.221

\* The [C Custom Setting] menu settings are reset.

## Fn Menu

Item	Default Setting	Reset Setting	Page
Drive Mode	<input type="checkbox"/> (Single frame shooting)	Yes	p.115 p.117 p.120 p.124
Flash Mode	Depends on Capture mode	Yes	p.62
White Balance	<b>AWB</b> (Auto)	Yes	p.150
ISO Sensitivity	AUTO (ISO 100 - 400)	Yes	p.83
<b>SCN</b> (Scene) mode	Night Scene	Yes	p.79
Custom Image	Bright	Yes	p.144
DPOF Settings	—	No	p.190
Digital Filter*	B&W	Yes	p.182
Slideshow	3 sec	Yes	p.167
RAW Display	Recorded Pixels: <b>10M</b> Quality Level: ★★★ Sensitivity: ±0	Yes	p.185
Image Comparison	—	—	p.166

\* The filter color and frequency settings can be saved or reset.

# Functions Available with Various Lens Combinations

## Lenses that can be used with this camera

Only DA and FA J lenses and D FA/FA/F/A lenses having an **A** (Auto) position on the aperture ring can be used with factory default settings. Refer to Notes on [23. Using Aperture Ring] (p.230) in the [**C** Custom Setting] menu for other lenses and D FA/FA/F/A lenses with aperture ring set to a position other than **A**.

Function \ Lens [Mount type]	DA/D FA/FA J/FA lens [KAF, KAF2] <sup>*3</sup>	F lens [KAF] <sup>*3</sup>	A lens [KA]
Autofocus (Lens only) (With AF adapter 1.7×) <sup>*1</sup>	Yes —	Yes —	— Yes <sup>*5</sup>
Manual focus (With the focus indicator) <sup>*2</sup> (With Matte field)	Yes Yes	Yes Yes	Yes Yes
Eleven AF points	Yes	Yes	No <sup>*5</sup>
Power zoom	No	—	—
Aperture Priority Automatic Exposure	Yes	Yes	Yes
Shutter Priority Automatic Exposure	Yes	Yes	Yes
Manual Exposure	Yes	Yes	Yes
P-TTL Auto Flash <sup>*4</sup>	Yes	Yes	Yes
Multi (16-segment) metering	Yes	Yes	Yes
Automatic lens focal length acquirement when using the Shake Reduction function	Yes	Yes	No

Yes : Functions are available when the aperture ring is set to the **A** position.

No : Functions are unavailable.

\*1 Lenses with a maximum aperture of f/2.8 or brighter. Only available at **A** position.

\*2 Lenses with a maximum aperture of f/5.6 or brighter.

\*3 To use an F/FA soft 85 mm f/2.8 lens or FA soft 28 mm f/2.8 lens, set [23. Using aperture ring] (p.76) to [Permitted] in the [**C** Custom Setting] menu. Pictures can be taken with the aperture you set, but only within manual aperture range.

\*4 When using the built-in flash and AF540FGZ, AF360FGZ or AF200FG.

\*5 The AF point becomes  (Center).

### **Lens names and mount names**

DA lenses with an ultrasonic motor and FA zoom lenses with power zoom use the  $K_{AF2}$  mount.

FA prime lenses (non-zoom lenses), DA lenses without ultrasonic motors and D FA, FA J and F lenses use the  $K_{AF}$  mount.

See the lens manual for details. Note that this camera is not equipped with a power zoom function.

### **Lenses and accessories that cannot be used with this camera**

When aperture ring is set at other than the **A** (Auto) position or a lens without an **A** position or accessories such as an auto extension tube or auto bellows are used, camera does not operate unless [23. Using aperture ring] (p.76) is set to [Permitted] in the [**C** Custom Setting] menu. Refer to “Notes on [23. Using Aperture Ring]” (p.230) for restriction that apply when [23. Using aperture ring] is set to [Permitted] in the [**C** Custom Setting] menu.

All camera exposure modes are available when using DA/FA J or lenses with an Aperture **A** position set to the **A** position.

### **Lens and Built-in Flash**

The built-in flash cannot be regulated and fully fires when pre A lenses or soft focus lenses are used.

Note that the built-in flash cannot be used as an Auto Flash.

### Aperture Ring Use

When [23. Using aperture ring] is set to [Permitted] in [**C** Custom Setting] menu (p.76), the shutter can be released even if the aperture ring of the D FA, FA, F or A lens is not set to the **A** (Auto) position or a lens without an **A** position is attached. However, the features will be restricted as shown in the table below.



The camera operates in **Av** (Aperture Priority) mode even if the mode dial is at Picture mode, **SCN** (Scene) mode, **P**, **Sv** or **Tv** when the aperture is set to a value other than the **A** position.

Lens Used	Exposure Mode	Restriction
D FA, FA, F, A, M (lens only or with auto diaphragm accessories such as auto extension tube K)	<b>Av</b> (Aperture Priority) mode	The aperture remains open regardless of the aperture ring position. The shutter speed changes in relation to the open aperture but an exposure error may occur. In the viewfinder, [F--] appears for the aperture indicator.
D FA, FA, F, A, M, S (with diaphragm accessories such as extension tube K)	<b>Av</b> (Aperture Priority) mode	Pictures can be taken with the specified aperture value but an exposure error may occur. In the viewfinder, [F--] appears for the aperture indicator.
Manual diaphragm lens such as reflex lens (lens only)	<b>Av</b> (Aperture Priority) mode	
FA, F soft 85mm FA soft 28mm (lens only)	<b>Av</b> (Aperture Priority) mode	Pictures can be taken with the specified aperture value in the manual aperture range. In the viewfinder, [F--] appears for the aperture indicator. When depth of field is checked (Optical Preview), AE Metering is switched on. Exposure check is possible.
All lenses	<b>M</b> (Manual) mode	Pictures can be taken with the set aperture value and shutter speed. In the viewfinder, [F--] appears for the aperture indicator. When depth of field is checked (Optical Preview), AE Metering is switched on. Exposure check is possible.



Shadows may appear in the image for white backgrounds and other shooting conditions if the CCD becomes dirty or dusty. This indicates that the CCD must be cleaned.

## Removing Dust by Shaking the CCD

The Dust Removal function shakes the CCD to remove dust that has collected.

- 1 Select **[Dust Removal]** in the **[ $\curvearrowright$  Set-up]** menu and press the four-way controller (**▶**).

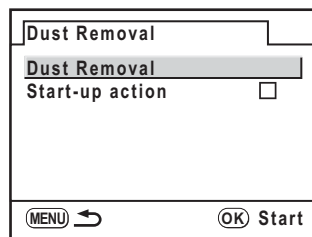

- 2 Press the **OK** button.

The Dust Removal function is activated by shaking the CCD.

Select **[Start-up action]** and use the four-way controller (**◀▶**) to select  (On) to turn Dust Removal on every time the camera is turned on.

## Detecting Dust on the CCD (Dust Alert)

Dust Alert is a function that detects dust adhering to the CCD and visually displays the location of the dust.

You can save the detected image and display it when performing sensor cleaning (p.233).

The following conditions must be met before using the Dust Alert function:

- A DA, FA J lens or a D FA, FA and F lens that has an Aperture **A** (Auto) position is attached.
- The aperture is set to the **A** position when using a lens with an aperture ring.
- The focus mode lever is set to **AF**.

- 1** Select [Dust Alert] in the [**Set-up**] menu.

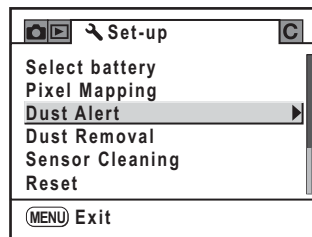

- 2** Press the four-way controller (▶).

The [Dust Alert] screen appears.

- 3** Fully display a white wall or uniformly bright subject in the viewfinder and press the shutter release button fully.

After image processing is performed, the Dust Alert screen appears.

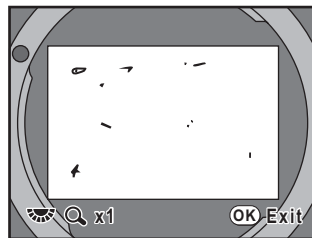

- 4** Press the **OK** button.

The image is saved and Dust Alert is exited.



- The exposure time may be extremely long when using the Dust Alert function. Note that if the direction of the lens is changed before processing is complete, dust will not be detected properly.
- Depending on the subject conditions or temperature, dust may not be detected properly.
- The Dust Alert image can only be displayed during sensor cleaning within 30 minutes from the time the image is saved. If 30 minutes elapse, save a new Dust Alert image and then perform sensor cleaning.
- The saved Dust Alert image cannot be displayed in Playback mode.
- Dust Alert image cannot be saved when an SD Memory Card is not inserted.



- If [NG] is displayed in Step 3 and the camera is unable to detect dust, press the **OK** button and take another picture.
- Regardless of the camera settings, a picture will be taken with specific shooting conditions in Step 3.
- Press the **INFO** button or turn the e-dial when displaying the Dust Alert image to view it at full screen display.

## Removing Dust with a Blower

Raise the mirror up and open the shutter to clean with a blower. Please contact PENTAX Service Center for professional cleaning because the CCD is a precision part. Cleaning services involve a fee. You can use the Imagesensor Cleaning Kit O-ICK1 (optional) when cleaning the CCD.



- Do not use a spray type blower.
- Do not clean the sensor when the exposure mode is set to **B** (Bulb) mode.
- Always cap the lens mount area to prevent dirt and dust from accumulating on the CCD when no lens is on the camera.
- When the battery level is low, [Not enough battery remaining to clean sensor] is displayed on the monitor.
- If you are not using the AC adapter D-AC76 (optional), please use batteries with ample capacity remaining. If the battery capacity becomes low during cleaning, a message will be displayed on the monitor and a warning beep will sound. Please stop cleaning immediately.
- Do not put the tip of the blower inside the lens mount area. If the power is turned off, this could cause damage to the shutter, CCD or the mirror.



- It is recommended to use the AC adapter D-AC76 (optional) when cleaning the sensor.
- The self-timer lamp blinks and [Cln] appears on the LCD panel while cleaning the sensor.
- This camera features a CCD shifting shake reduction system, and it may generate a vibration sound while cleaning the CCD. It is not a malfunction.

- 1 Turn the camera off and remove the lens.**
- 2 Turn the camera on.**
- 3 Select [Sensor Cleaning] in the [⌂ Set-up] menu.**

#### 4 Press the four-way controller (▶).

The [Sensor Cleaning] screen appears.

#### 5 Use the four-way controller (▲▼) to select [Mirror Up].

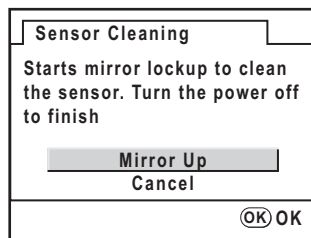

#### 6 Press the OK button.

The mirror is locked in the up position.

If you used Dust Alert to detect dust on the sensor within the last 30 minutes, the Dust Alert image appears on the monitor. Clean the sensor while checking the location of the dust.

#### 7 Clean the CCD.

Use a brush-less blower to remove dirt and dust from the CCD. Using a blower with a brush may scratch the CCD. Do not wipe the CCD with a cloth.

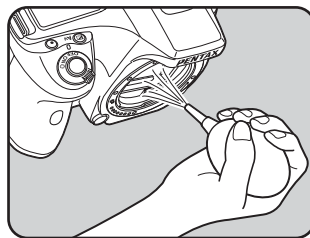

#### 8 Turn off the camera.

#### 9 Attach the lens after the mirror returns to its original position.

A number of dedicated accessories are available for this camera. Please contact a PENTAX Service Center for details regarding accessories. Products marked with an asterisk (\*) are the same as those supplied with the camera.

## Battery Grip D-BG3

The Battery Grip has features such as a shutter release button and **AE-L** button to accommodate shooting vertically.



## Power Supply Accessories

### AC Adapter D-AC76

Lets you power your camera with the outlet when combined with the AC plug cord.

### AC plug cord (\*)

## Flash Accessories

### Auto Flash AF540FGZ

### Auto Flash AF360FGZ

The AF540FGZ and AF360FGZ are P-TTL auto flash units with a maximum guide number of 54 and 36 (ISO 100/m), respectively. Their features include slave-sync flash, contrast-control-sync flash, auto flash, high-speed sync flash, wireless flash, slow-speed sync and trailing curtain sync flash.



AF540FGZ



AF360FGZ

### Auto Flash AF200FG

The AF200FG is a P-TTL auto flash unit with a maximum guide number of 20 (ISO 100/m). It features contrast-control-sync flash and slow-speed sync flash when combined with the AF540FGZ or AF360FGZ unit.



AF200FG

### Hot Shoe Adapter Fg

### Extension Cord F5P



Hot Shoe Adapter Fg

### Off-Camera Shoe Adapter F

Use the adapters and cords to use the external flash away from the camera.



Off-camera Shoe Adapter F

### Off-camera Shoe Clip CL-10

When using the AF540FGZ or AF360FGZ as a wireless flash, this large clip is used for setting the external flash on a desk or table.



## For Viewfinder

### Magnifier Eyecup O-ME53

This viewfinder accessory is for magnifying up to 1.18 times. When the eyecup is attached to the **K200D** with a viewfinder magnification of approximately 0.85 times, the combined magnification becomes 1.0 times, making manual focusing much easier.



### Magnifier Fb

This viewfinder accessory is for magnifying the central area of the viewfinder 2×.

You can see the entire view by simply flipping up the accessory from the eye-piece, as it is a hinge-type magnifier.



### Ref-converter A

This is an accessory that changes the viewfinder viewing angle at 90° intervals. The viewfinder magnification can be switched between 1× and 2×.



**Diopter correction lens adapter M**

This accessory adjusts the diopter.  
Install it on the viewfinder.

If it is difficult to see the viewfinder image clearly, choose one of the eight correction lens adapter M of approximately  $-5$  to  $+3 \text{ m}^{-1}$  (per meter).

**ME Viewfinder Cap (\*)****Eyecup F<sub>P</sub> (\*)****Cable Switch CS-205**

Connect to the cable switch terminal and operate the camera shutter release button. The cord length is 0.5 m.

**Remote Control F**

Lets you shoot pictures from within 5 m of the front of the camera.

**Camera Case/Strap****Camera Case O-CC74****Camera Strap O-ST53 (\*)**



## Imagesensor Cleaning Kit O-ICK1

Clean the optical parts such as the CCD and lens of this camera.



## Others

**Body Mount Cap K**

**Hot Shoe Cover Fκ (\*)**

**USB Cable I-USB17 (\*)**

**Video Cable I-VC28 (\*)**



















Error Message	Description
Memory card full	The SD Memory Card is full and no more images can be saved. Insert a new SD Memory Card or delete unwanted images. (p.41, p.72) You may be able to save new images by converting to JPEG format or changing the JPEG record pixels or JPEG quality setting. (p.146, p.147)
No image	There are no images for playback on the SD Memory Card.
Camera cannot display this image	You are trying to play back an image in a format not supported by this camera. You may be able to play it back on another brand of camera or your computer.
No card in the camera	The SD Memory Card is not inserted in the camera. (p.41)
Memory card error	The SD Memory Card has a problem, and image capture and playback are impossible. It may be viewable on a PC but not with this camera.
Card not formatted	The SD Memory Card you have inserted is unformatted or has been formatted on a computer or other device and is not compatible with this camera. Use the card after formatting it with this camera. (p.203)
Card locked	A locked SD Memory Card is inserted in the camera. Unlock the SD Memory Card. (p.42)
The card is electronically locked	Data is protected by the SD Memory Card security feature.
This image cannot be enlarged	You are trying to enlarge an image that cannot be enlarged.
This image is protected	You are trying to delete an image that is protected. Remove protection from the image. (p.177)
Battery depleted	The batteries are exhausted. Install new batteries in the camera. (p.37)
Not enough battery remaining to clean sensor	Appears during sensor cleaning if the battery level is insufficient. Replace the batteries with new ones or use an AC adaptor D-AC76 (optional). (p.40)

Error Message	Description
Not enough battery remaining to activate Pixel Mapping	Appears during pixel mapping if the battery level is insufficient. Replace the batteries with new ones or use an AC adaptor D-AC76 (optional). (p.40)
Image folder cannot be created	The maximum folder number (999) and file number (9999) are being used, and no more images can be saved. Insert a new SD Memory Card or format the card. (p.203)
The image is not stored	The image could not be saved because of an SD Memory Card error.
Settings not stored	The DPOF settings or rotated image could not be saved because SD Memory Card is full. Delete unwanted images and perform DPOF settings or rotation again. (p.72)
NG	The camera was unable to measure the manual white balance or detect dust on the sensor. Try the operation again. (p.152, p.231)
Rotation information cannot be saved to this image	New rotation information cannot be saved to an image without rotation information.
No more images can be selected	You cannot select 100 or more images to delete at a time. (p.174)
This RAW file cannot be developed	RAW files captured with other cameras cannot be edited on this camera.
This image cannot be filtered	Appears when digital filter is started from Fn menu for images captured with other cameras.
No DPOF files	No files are set with DPOF. Set DPOF and then print. (p.190)
Printer error	There is an error with the printer and the file cannot be printed. Fix all the errors and try printing again.
No paper in the printer	Printer has run out of paper. Put paper in the printer and print.
Printer settings are changed	The camera received notification that the printer status has changed. Press the <b>OK</b> button to reconnect to the printer.
Low paper level in the printer	Printer is running out of paper. This appears when this signal is received from the printer. After two seconds, the printer resumes printing.

Error Message	Description
Low ink level in the printer	Printer is running out of ink. This appears when this signal is received from the printer. After two seconds, the printer resumes printing.
No ink in the printer	Printer has run out of ink. Replace ink and print.
Paper stuck in the printer	Paper is jammed in the printer. Remove paper and print.
Data error	A data error has occurred during printing.
Turn the power off	This appears when exiting the PictBridge mode. Turn the main switch off.

We recommend checking the following items before contacting a service center.

Problem	Cause	Remedy
The camera does not turn on	Batteries are not installed	Check if batteries are installed. If not, install charged batteries.
	Batteries are not installed properly	Check orientation of batteries. Re-insert batteries according to the ⊕ ⊖ symbols. (p.37)
	The battery power is low	Replace with charged batteries or use the AC adapter D-AC76 (optional). (p.40)
The shutter does not release	The lens aperture ring setting is other than the <b>A</b> position	Set the lens aperture ring to the <b>A</b> position (p.87) or select [Permitted] in [23. Using aperture ring] in the [ <b>C</b> Custom Setting] menu. (p.230)
	The flash is charging	Wait until charging is finished.
	There is no available space on the SD Memory Card	Insert an SD Memory Card with available space or delete unwanted images. (p.41, p.72)
	Recording	Wait until recording is finished.
The Autofocus does not work	The subject is difficult to focus on	Autofocus cannot focus well on subjects that have low contrast (the sky, white walls), dark colors, intricate designs, rapidly-moving objects or scenery shot through a window or a net-like pattern. Lock focus on another object located at the same distance as your subject (press the shutter release button halfway), then aim at target and press the shutter release button fully. Alternatively, use manual focus. (p.109)
	The subject is not in the focusing area	Position the subject in the focus frame in the middle of the viewfinder. If the subject is outside the focusing area, aim the camera at the subject and lock the focus (press the shutter release button halfway), then compose a picture and press the shutter release button fully.
	The subject is too close	Move away from the subject and take a picture.
	The focus mode is set to <b>MF</b>	Set the focus mode lever to <b>AF</b> . (p.102)

Problem	Cause	Remedy
The subject is not in focus	The AF mode is set to <b>AF.C</b> (Continuous mode)	Autofocus is not locked (focus lock) when the AF mode is set to <b>AF.C</b> . The camera will continue focusing on the subject while the shutter release button is pressed halfway. If there is a subject that you wish to focus on, set the AF mode to <b>AF.S</b> (Single mode) and use the focus lock.
	The Capture mode is set to  (Moving Object),  (Kids) or  (Pet) in <b>SCN</b> mode	Set the Capture mode to setting other than  (Moving Object),  (Kids) or  (Pet) in <b>SCN</b> mode. (p.78)
The AE lock function does not operate	The exposure mode is set to <b>M</b> (Manual) mode or <b>B</b> (Bulb) mode	Use AE lock with any setting other than <b>M</b> (Manual) mode or <b>B</b> (Bulb) mode.
The flash does not discharge	When the flash mode is set to [Auto discharge] or [Auto flash+Redeye reduct], the flash will not discharge if the subject is bright	Set the flash mode to [Flash On] or [Flash On+Red-eye]. (p.62)
	Mode dial is set to  (Flash OFF)	Set mode dial to any setting other than  (Flash OFF). (p.78)
	<b>SCN</b> (Scene) mode is set to  (Night Scene),  (Sunset),  (Candlelight) or  (Museum)	Set <b>SCN</b> (Scene) mode to any setting other than  (Night Scene),  (Sunset),  (Candlelight) or  (Museum). (p.79)
The power zoom system does not function	The camera does not have the power zoom function	Use manual zoom. (p.61)
The USB connection with a computer does not work properly	The Transfer Mode is set to [PictBridge]	Set [USB Connection] in the [  Set-up] menu to [PC]. Refer to p.11 of the "PENTAX PHOTO Browser 3/PENTAX PHOTO Laboratory 3 Operating Manual" for details on connecting the camera to a PC.
The USB connection with a printer does not work properly	The Transfer Mode is set to [PC]	Set [USB Connection] in the [  Set-up] menu to [PictBridge]. (p.194)

Problem	Cause	Remedy
Shake Reduction does not work	The Shake Reduction function is off	Turn on the Shake Reduction switch. (p.68)
	The Shake Reduction function is not set properly	If a lens for which focal length information cannot be acquired is used, set the [Focal Length] on the [Input Focal Length] menu. (p.69)
	Shutter speed is too low for the Shake Reduction function to be effective when panning or shooting night scenes, etc.	Turn off the Shake Reduction function and use a tripod.
	The subject is too close	Move away from the subject, or turn off the Shake Reduction function and use a tripod.



In rare cases, the camera may not operate correctly due to static electricity. This can be remedied by taking the batteries out and putting them back in again. When the mirror remains in the up position, take the batteries out and put them back in again. Then, turn the power on. The mirror will retract. After the procedure is done, if the camera operates correctly, it does not require any repairs.

# Main Specifications

Type	TTL autofocus, auto-exposure SLR digital-still camera with built-in retractable P-TTL flash
Effective Pixels	Approx. 10.2 megapixels
Sensor	Total pixels approx. 10.75 megapixels, Primary color filter, interline/interlace scan CCD
Recorded Pixels	<b>10M</b> (RAW: 3872×2592 pixels), <b>10M</b> (JPEG: 3872×2592 pixels), <b>6M</b> (3008×2000 pixels), <b>2M</b> (1824×1216 pixels)
Sensitivity (Standard output sensitivity)	Auto, Manual (ISO 100 to 1600 (EV steps can be set to 1 EV, 1/2 EV or 1/3 EV))
File Format	RAW (PEF/DNG), JPEG (Exif 2.21), DCF 2.0 compliant, DPOF compatible, Print Image Matching III compatible, RAW+JPEG simultaneous capturing compatible
JPEG Quality	★★★ (Best), ★★ (Better), and ★ (Good)
Storage Medium	SD Memory Card, SDHC Memory Card
Number of Shots	

Recorded Pixels	File Format/ JPEG Quality	Capacity					
		4GB	2GB	1GB	512MB	256MB	128MB
<b>10M</b> 3872×2592	<b>RAW</b> (PEF)	Approx. 235	Approx. 119	Approx. 58	Approx. 29	Approx. 14	Approx. 7
	<b>RAW</b> (DNG)	Approx. 235	Approx. 119	Approx. 58	Approx. 29	Approx. 14	Approx. 7
<b>10M</b> 3872×2592	★★★	Approx. 804	Approx. 409	Approx. 202	Approx. 101	Approx. 50	Approx. 26
	★★	Approx. 1371	Approx. 698	Approx. 343	Approx. 171	Approx. 86	Approx. 44
	★	Approx. 2320	Approx. 1181	Approx. 586	Approx. 293	Approx. 147	Approx. 75
<b>6M</b> 3008×2000	★★★	Approx. 1340	Approx. 682	Approx. 335	Approx. 167	Approx. 84	Approx. 43
	★★	Approx. 2277	Approx. 1159	Approx. 570	Approx. 284	Approx. 143	Approx. 73
	★	Approx. 3893	Approx. 1982	Approx. 974	Approx. 487	Approx. 245	Approx. 125
<b>2M</b> 1824×1216	★★★	Approx. 3549	Approx. 1807	Approx. 902	Approx. 450	Approx. 227	Approx. 116
	★★	Approx. 6034	Approx. 3073	Approx. 1549	Approx. 774	Approx. 390	Approx. 200
	★	Approx. 10057	Approx. 5121	Approx. 2627	Approx. 1313	Approx. 662	Approx. 339



JPEG Quality (Compression): ★★★ (Best) = 1/4.5, ★★ (Better) = 1/8, ★ (Good) = 1/16

White Balance	Auto, Daylight, Shade, Cloudy, Fluorescent Light (D: Daylight, N: Neutral White, W: White), Tungsten Light, Flash, Manual, fine tuning available
Monitor	2.7 inch wide viewing field TFT color LCD with approx. 230,000 dots, brightness adjustment function



Playback Function	Single frame, 4-image display, 9-image display, 16-image display, zoom display (up to 16 times, scrolling possible), image comparison, rotating, folder display, slideshow, histogram, bright/dark area
Digital Filter	B&W, Sepia, Color, Soft, Illustration, HDR, Slim, Brightness (only for processing after shooting)
Exposure Mode	<b>P</b> Program, <b>Sv</b> Sensitivity priority, <b>Tv</b> Shutter priority, <b>Av</b> Aperture priority, <b>M</b> Manual, <b>B</b> Bulb Picture mode  Auto Picture,  Portrait,  Landscape,  Macro,  Moving Object,  Night Scene Portrait,  Flash OFF Scene mode  Night Scene,  Surf & Snow,  Food,  Sunset,  Kids,  Pet,  Candlelight,  Museum
Shutter	Electronically controlled vertical-run focal-plane shutter, Speed range (1) Auto 1/4000 to 30 sec. (stepless), (2) Manual 1/4000 to 30 sec. (1/2 EV step or 1/3 EV step), Bulb, Electromagnetic release, Shutter lock by setting Main switch in OFF position
Lens Mount	PENTAX KAF2 bayonet mount (AF coupler, lens information contacts, K-mount with power contacts)
Lens Used	PENTAX KAF2 mount lenses (power zoom not available), KAF mount lenses, KA mount lenses
Autofocus System	TTL phase-matching autofocus system (SAFOX VIII), AF operational brightness range: EV -1 to 18 (at ISO 100 with f/1.4 lens), Focus lock available, Focus Mode: <b>A.F.S</b> (Single)/ <b>A.F.C</b> (Continuous)/ <b>M.F</b> , Adjustable AF point
Viewfinder	Penta-mirror viewfinder, Natural-Bright-Matte II focusing screen, Field of view: approx. 96%, Magnification: approx. 0.85× (with 50 mm f/1.4 lens at ∞), Diopter: approx. -2.5 to +1.5m <sup>-1</sup> (per meter)
Viewfinder Indication	Focus information:  is lit when in-focus and blinking when unable to focus,  is lit = Built-in flash ready,  is blinking = Flash should be used, Shutter speed, Confirm Sensitivity, Aperture value, e-dial enabled indicator,  = AE lock, Capacity remaining,  = EV compensation, <b>A.F.C</b> =Continuous mode, <b>M.F</b> = Manual focus, Picture mode icon, Scene mode icon, Shake Reduction display, RAW/RAW+
LCD Panel Display	is lit = Built-in flash ready,  is blinking = Flash should be used,  = Auto discharge,  = Redeye reduction,  = Single frame shooting,  = Continuous shooting,  = Self-timer,  = Remote control shooting,  = Battery exhaustion warning,  = Auto bracket exposure (EV steps can be set to 1/2 EV or 1/3 EV),  = Center-weighted metering,  = Spot metering,  = AF Point Select,  = Center of AF Point, Confirm sensitivity, Shutter speed, Aperture value, White Balance, Remaining capacity,  = EV compensation, <b>PC</b> (mass storage)/ <b>Pb</b> (PictBridge) appears when the USB cable is connected, <b>RAW</b> , <b>RAW+</b>

Preview Function	Digital Preview: Composition, exposure, focus and white balance confirmation Optical Preview: Depth of field confirmation (electronically controlled and usable in all exposure modes)
Continuous shooting (Hi/Lo)	Approx. 2.8 fps (JPEG (10M, ★★★, Hi): up to 4 frames, RAW: up to 4 frames) Approx. 1.1 fps (JPEG (10M, ★★★, Lo): until SD Memory Card is full, RAW: up to 4 frames)
Self-timer	Electronically controlled with delay time of 12 sec./2 sec. (with mirror up function). Start by pressing the shutter release button. Operation confirmation: Possible to set beep. Can be cancelled after activation
Remote Control	PENTAX Remote Control F (optional) Release shutter immediately or three seconds after pressing the remote control shutter button
Mirror	Quick-return mirror, mirror up function (2 sec. self-timer)
Custom Image	Image Tone (6 types), Saturation/Filter Effect, Hue/Toning, Contrast, Sharpness/Fine Sharpness
Exposure Bracket	Three frames (underexposed, proper exposure and overexposed) are shot continuously with exposure bracketing. (Selectable between 1/2 EV and 1/3 EV for EV steps)
Exposure Meter/ Exposure Range	TTL multi (16-segment metering), Exposure range from EV 0 to EV 21 at ISO 100, with 50 mm f/1.4 lens, Center-weighted and Spot metering mode can be set
EV Compensation	±3 EV (1/2 EV Steps), ±2 EV (1/3 EV Steps), EV Steps can be selected
AE Lock	Button type (timer type: two times the meter operating time set in Custom Setting) Continuous as long as the shutter button is halfway pressed.
Built-in Flash	P-TTL built-in flash with serial control, GN approx. 13 (ISO 100), Angles of coverage: 28 mm lens angle of view (35 mm equivalent), Flash synchronization speed range at 1/180 sec. and slower, Daylight-sync flash, Slow-speed-sync flash, ISO range = P-TTL: 100 to 1600, Auto-popup function
External Flash Sync	Hot shoe with <b>X</b> -contact, which couples with PENTAX dedicated auto flashes, ISO range = P-TTL: 100 to 1600, Automatic flash, Red-eye reduction flash function, High-speed-sync and wireless-sync with PENTAX dedicated flash
Custom Function	23 functions can be set
Time Function	World Time settings for 75 cities (28 time zones)
Shake Reduction Function	CCD Image Sensor Shift, effective compensation range = up to 4 EV (dependent on the used lens type and shooting conditions)
Dust Removal	SP coating and CCD operations for dust removal. Can be set to operate when the camera is turned on.
Power	Four AA lithium, AA Ni-MH rechargeable, or AA alkaline batteries

Battery Exhaustion	Battery exhaustion symbol  is lit. (The shutter is locked and no indication appears in the viewfinder when  starts blinking.)
In/Out Port	USB/video terminal (USB 2.0 (high speed compatible)), DC input terminal, Remote release terminal
Video Output Format	NTSC/PAL
PictBridge	Compatible printer: PictBridge-compatible printer Print mode: Single Image, All Images, DPOF AUTOPRINT
Dimensions and Weight	Approx. 133.5 mm (W) × 95 mm (H) × 74 mm (D) (excluding protrusions) approx. 630 g (body only), approx. 690 g (including four AA lithium batteries and an SD Memory Card), approx. 725 g (including four AA alkaline batteries and an SD Memory Card)
Accessories	Hot shoe cover Fk, Eyecup Fp, ME viewfinder cap, Body mount cover, USB Cable I-USB17, Video cable I-VC28, Software (CD-ROM) S-SW74 (PENTAX PHOTO Browser 3/PENTAX PHOTO Laboratory 3), Strap O-ST53, AA lithium batteries (four), Operating Manual (this book), Quick Guide, PENTAX PHOTO Browser 3/PENTAX PHOTO Laboratory 3 Operating Manual
Languages	English, French, German, Spanish, Portuguese, Italian, Dutch, Danish, Swedish, Finnish, Polish, Czech, Hungarian, Turkish, Russian, Korean, Chinese (Traditional/Simplified) and Japanese

**AdobeRGB**

Color space recommended by Adobe Systems, Inc. for commercial printing. Wider range of color reproduction than sRGB. Covers most of the color range so colors only available when printed are not lost when editing images on a computer. When image is opened by non-compatible software, the colors look lighter.

**AE Metering**

Brightness of subject is measured to determine exposure. In this camera, select from [Multi-segment Metering], [Center-weighted Metering] and [Spot Metering].

**Aperture**

The aperture increases or reduces the light beam (thickness) passing through the lens to the CCD.

**Auto Bracket**

For automatically changing exposure. When the shutter button is pressed, three images are shot. The first one has no compensation, the second is underexposed and the third is over-exposed.

**Bright Portion**

Overexposed area in the image loses contrast and appears white.

**Camera Shake (Blur)**

When the camera moves while the shutter is open, the entire image appears blurred. This occurs more often when shutter speed is low. Prevent camera shake by raising the sensitivity, using the flash, and raising the shutter speed. Alternatively, use a tripod to stabilize the camera. As camera shake is mostly likely to occur when pressing the shutter release button, use the Shake Reduction function, the self-timer, the remote control unit, or the cable switch to prevent camera movement.

**CCD (Charge Coupled Devices)**

Photography element which converts the light entering through the lens into electric signals that create the image.

## **Color Space**

A defined range of colors from the spectrum which are used. In digital cameras, [sRGB] is defined as the standard by Exif. In this camera, [AdobeRGB] is also used because of the richer color expression over sRGB.

## **Color Temperature**

This numerically expresses the color of the light source illuminating the subject. This is indicated in absolute temperature, using Kelvin (K) units. The color of light shifts to a bluish color as the color temperature rises, and to a reddish color as the color temperature falls.

## **Dark Portion**

Underexposed area in the image loses contrast and appears black.

## **DCF (Design Rule for Camera File System)**

A digital camera file system standard established by the Japan Electronics and Information Technology Industries Association (JEITA).

## **Depth of field**

Area of focus. This depends on the aperture, lens focal length, and distance to the subject. For example, select a smaller aperture (higher number) to increase the depth of field or use a larger aperture (smaller number) to decrease the depth of field.

## **DNG RAW file**

DNG (Digital Negative) is a general-purpose RAW file format designed by Adobe Systems. When images captured in proprietary RAW formats are converted to DNG format, support and compatibility for the images increases significantly.

## **DPOF (Digital Print Order Format)**

Rules for writing information onto a card with recorded images regarding the specific images and number of copies to be printed. Prints can easily be made by taking images to a DPOF photo printing store.

### **Dynamic Range (D-Range)**

Indicated with a value expressing the light level reproducible in an image. This is the same as the term “Exposure latitude” used with silver halide film.

Generally, when the dynamic range is wide, it is difficult for bright and dark areas to be recorded in the image, and when the dynamic range is narrow, a sharp image can be obtained.

### **EV (Exposure Value)**

Exposure value is determined by the combination of the aperture value and the shutter speed.

### **EV Compensation**

Process of adjusting the image brightness by changing the shutter speed and/or aperture value.

### **Exif (Exchangeable image file format for digital still camera)**

A standard digital camera file format established by the Japan Electronics and Information Technology Industries Association (JEITA).

### **Focus point**

Position in the viewfinder that determines focus. In this camera, select from [Auto], [Select] and [Center].

### **Histogram**

A graph that shows the darkest and brightest points in an image. The horizontal axis represents the brightness and the vertical axis represents the number of pixels. This is useful when you wish to refer to the exposure status of an image.

### **ISO Sensitivity**

The level of sensitivity to light. With a high sensitivity, images can be shot with a high shutter speed even in dark places, reducing camera shake. However, images with high sensitivity are more susceptible to noise.

### **JPEG**

An image compression method. In this camera, select from ★★★ (Best), ★★ (Better), or ★ (Good). Images recorded in JPEG format are suited for viewing on your PC or for attaching to e-mail.

**ND (Neutral Density) Filter**

A filter available in different saturation levels that adjusts the brightness without affecting the color tone of pictures.

**Noise Reduction**

Process to reduce noise (image roughness or unevenness) caused by slow shutter speed or high sensitivity shooting.

**NTSC/PAL**

These are video output formats. NTSC is mainly used in Japan, North America, and South Korea. PAL is mainly used in Europe and in China.

**Quality Level**

This refers to the image compression ratio. The lower the compression, the more detailed the image. The image becomes rougher as the compression rate rises.

**RAW data**

Unedited image data output from the CCD. RAW data is data before being internally processed by the camera. Camera settings at the time of capture, such as White Balance, Contrast, Saturation, and Sharpness can be set for each frame after shooting. In addition, RAW data is 12 bit data that contains 16 times the information of 8 bit JPEG data. Rich gradations are possible. Transfer RAW data to your computer and use the provided software to create image data with different settings, such as JPEG.

**Recorded Pixels**

Indicates the size of the image by the number of pixels. The more pixels that compose a picture, the larger the image size.

**Shutter Speed**

The length of time that the shutter is open and light strikes the CCD. The amount of light that strikes the CCD can be changed by altering the shutter speed.

**sRGB (standard RGB)**

International standard of color space established by the IEC (International Electrotechnical Commission). This is defined from color space for PC monitors and is also used as the standard color space for Exif.

**Vignetting**

The picture edges are blackened when part of the light coming from the subject is blocked by the hood or filter ring, or when the flash is partially blocked by the lens.

**White Balance**

While shooting, color temperature is adjusted to match the light source so that the subject appears to have correct color.



## Symbols

[C Custom Setting]	
Menu .....	75, 158, 226
(Delete) button .....	21, 72
<b>Av</b> (EV Compensation)	
button .....	19, 21, 100
<b>UP</b> (Flash pop-up)	
button .....	19, 62
(Playback)	
button .....	19, 21, 70
[ Playback] Menu ....	158, 224
Preview .....	113
(Protect) button .....	21, 177
[ Rec. Mode] Menu ....	74, 224
[ Set-up] Menu .....	202, 225
Auto Picture .....	78
Portrait .....	78
Landscape .....	78
Macro .....	78
Moving Object .....	78
Night Scene Portrait .....	78
Flash OFF .....	78
Night Scene .....	79
Surf & Snow .....	79
Food .....	79
Sunset .....	79
Kids .....	79
Pet .....	79
Candlelight .....	79
Museum .....	79
<b>A</b>	
AC Adapter .....	40
Adding the Date .....	190
AdobeRGB .....	155
AE Lock .....	101
AE Metering .....	98

<b>AE-L</b> button .....	19, 96
<b>AF</b> (Autofocus) .....	102
AF Mode .....	104
AF200FG .....	134
AF360FGZ .....	134
AF540FGZ .....	134
<b>A.F.C</b> (Continuous mode)	
.....	102, 104
<b>A.F.S</b> (Single mode) ....	102, 104
Alkaline batteries .....	37
Aperture .....	82
Aperture Priority Mode <b>Av</b> ....	92
Auto Bracket .....	124
Auto Picture  .....	78
Auto Power Off .....	214
Autofocus <b>AF</b> .....	102
Automatic Sensitivity	
Correction .....	83
<b>Av</b> (Aperture Priority) mode ...	92
AV Equipment .....	179
<b>B</b>	
<b>B</b> (Bulb) Mode .....	97
B&W (Digital Filter) .....	183
Batteries .....	37, 215
Beep .....	204
Bright/Dark area .....	170
Brightness (Digital Filter) .....	184
Brightness Level .....	211
Brightness of the Monitor ....	211
Built-in Flash .....	62
Bulb Mode <b>B</b> .....	97

<b>C</b>	
Cable Switch .....	97
Candlelight  .....	79
Capture Information .....	23, 25
Capture Mode .....	32, 78

Card access lamp .....	17
CCD cleaning .....	231
Center-weighted .....	99
Cloudy (White Balance) .....	150
Color (Digital Filter) .....	183
Color Space .....	155
Color Temperature .....	152
Continuous Autofocus .....	108
Continuous mode	
<b>A.F.C.</b> .....	102, 104
Continuous Shooting .....	115
Contrast .....	144
Contrast-Control-Sync (Flash) .....	142
Correct exposure .....	81
Custom Image .....	144
Custom Setting .....	75, 158
<b>[C Custom Setting]</b>	
Menu .....	75, 158, 226

## D



Date Adjust .....	52
Date change .....	205
Daylight (White Balance) .....	150
Daylight-Sync Shooting .....	66
Delete .....	72, 173
Delete All Images .....	173
 (Delete) button .....	21, 72
Delete Folder .....	176
Deleting a Single Image .....	72
Depth of field .....	82
Digital Filter .....	182
Digital Preview .....	113, 212
Diopter Adjust .....	47
Direct Printing .....	193
Display Language .....	209
Display Style .....	170
DPOF AUTOPRINT .....	199
DPOF Settings .....	190
Drive Mode .....	77
Dust Alert .....	231









Dust Removal .....	231
--------------------	-----









## E

e-dial .....	19, 21
e-dial in Program .....	88
Error Message .....	240
EV Compensation .....	100
 <b>Av</b> (EV Compensation)	
button .....	19, 21, 100
Expand Dynamic Range .....	84
Exposure .....	81
Exposure Bracket .....	124
Exposure metering timer .....	126
Exposure Mode .....	85
Exposure Warning .....	91, 93, 95
External flash .....	134
Eyecup .....	47

## F

File Format .....	148
Filter .....	182
Filter Effect .....	144
Fireworks .....	97
Fix Focus .....	107
Flash .....	62, 127
Flash (White Balance) .....	150
Flash Exposure	
Compensation .....	128
Flash Off .....	78
Flash OFF  .....	78
 <b>UP</b> (Flash pop-up)	
button .....	19, 62
Fluorescent Light (White Balance) .....	150
<b>Fn</b> button .....	19, 21, 77, 159
<b>Fn</b> Menu .....	77, 159, 227
Focal Length .....	69
Focus Indicator .....	109
Focus Lock .....	107
Focus Mode .....	102
Focus mode lever .....	19

- Focus point ..... 105  
 Focusing ..... 102  
 Folder Name ..... 213  
 Food  ..... 79  
 Format ..... 203  
 Four-way controller  
 (▲▼◀▶) ..... 19, 21
- G**  
 Green button ..... 18  
 Green button in Manual ..... 96  
 Guide display ..... 22, 210
- H**  
 HDR (Digital Filter) ..... 184  
 High-ISO Noise Reduction ..... 85  
 High-Speed Flash Sync  
 Mode ..... 136  
 Histogram ..... 26, 170  
 Hue ..... 144  
 Hyper-program ..... 88
- I**  
 Illustration (Digital Filter) ..... 183  
 Image Comparison ..... 166  
 Image Tone ..... 144  
**INFO** button ..... 19, 21, 23, 70  
 Initial Settings ..... 49, 224  
 Input Focal Length ..... 69  
 Instant Review ..... 211  
 ISO sensitivity ..... 83
- J**  
 JPEG Quality ..... 43, 147  
 JPEG Recorded  
 Pixels ..... 43, 146
- K**  
 Kids  ..... 79
- L**  
 Landscape  ..... 78
- Language Setting ..... 49  
 LCD panel ..... 29  
 Lens ..... 45, 228  
 Lens unlock button ..... 18, 46  
 Lithium batteries ..... 37  
 Lock Exposure ..... 108
- M**  
**M** (Manual) Mode ..... 94  
 Macro  ..... 78  
 Main switch ..... 18, 21, 48  
 Manual focus **MF** ..... 109  
 Manual Mode **M** ..... 94  
 Manual White Balance ..... 152  
 Matte Field ..... 110  
 Memory ..... 217  
**MENU** button ..... 19, 21, 30  
 Menu Operation ..... 30  
 Meter Operating Time ..... 99  
 Metering mode ..... 98  
**MF** (Manual focus) ..... 109  
 Mirror Up ..... 123, 234  
 Mode dial ..... 19, 32, 78  
 Mode Palette ..... 80  
 Monitor ..... 22  
 Moving Object  ..... 78  
 Multiple Flashes ..... 141  
 Multi-segment ..... 98  
 Museum  ..... 79
- N**  
 Night Scene (Bulb Mode) ..... 97  
 Night Scene  ..... 79  
 Night Scene Portrait  ..... 78  
 Ni-MH ..... 37  
 Ni-MH rechargeable  
 batteries ..... 37  
 Nine-Image Display ..... 163  
 Noise Reduction ..... 85  
 NTSC ..... 214

- O**
- OK** button ..... 19, 21
  - OK** button when shooting .... 103
  - Optical Preview ..... 113
  - Optional Accessories ..... 235
- P**
- P** (Program) Mode ..... 86
  - PAL ..... 214
  - Pet  ..... 79
  - PictBridge ..... 193
  - Pixel Mapping ..... 216
  - Pixels ..... 146
  - Playback ..... 25, 70
  -  (Playback)
    - button ..... 19, 21, 70
    - Playback display ..... 172
    - [ Playback] Menu .... 158, 224
    - Playback Time ..... 39
    - Portrait  ..... 78
    - Power ..... 48
    - Press fully ..... 59
    - Press halfway ..... 59
    - Preview  ..... 113
    - Preview Method ..... 112
    - Print All Images ..... 198
    - Print Service ..... 190
    - Print Single Image ..... 196
    - Printer connection ..... 195
    - Program Mode **P** ..... 86
    - Protect ..... 177
    -  (Protect) button ..... 21, 177
    - P-TTL (Flash) ..... 139
    - P-TTL Auto (Flash) ..... 135
- Q**
- Quality Level ..... 43, 147
- R**
- RAW ..... 148
  - RAW** button ..... 19, 148, 149
  - RAW Display ..... 185
  - RAW file format ..... 148
  - RAW+ ..... 148
  - [ Rec. Mode] Menu .... 74, 224
  - Recorded Pixels ..... 43, 146
  - Red-eye reduction ..... 66, 139
  - Remaining image storage
    - capacity ..... 39
  - Remote Control ..... 120
  - Reset ..... 219
  - Rotate ..... 160
- S**
- Saturation ..... 144
  - Scene**SCN** ..... 79
  - SCN** (Scene) ..... 79
  - SD Memory Card ..... 41
  - Select battery ..... 215
  - Select&Delete ..... 174
  - Self-timer ..... 117
  - Sensitivity ..... 83
  - Sensitivity Priority Mode
    - SV** ..... 88
  - Sensor Cleaning ..... 233
  - Sepia (Digital Filter) ..... 183
  - [ Set-up] Menu ..... 202, 225
  - Shade (White Balance) ..... 150
  - Shake Reduction ..... 67
  - Shake Reduction switch ... 19, 68
  - Sharpness ..... 144
  - Show Sensitivity ..... 104
  - Shutter Priority Mode **Tv** ..... 90
  - Shutter release button
    - ..... 18, 21, 59
  - Shutter Speed ..... 81
  - Single mode **A/FS** ..... 102, 104
  - Slideshow ..... 167, 169
  - Slim (Digital Filter) ..... 184
  - Slow Shutter Speed NR ..... 85
  - Slow-Speed-Sync ..... 131
  - Soft (Digital Filter) ..... 183

Spot Metering .....	99
sRGB .....	155
Strap .....	36
Sunset 🌇 .....	79
Superimpose AF Area ....	28, 105
Surf & Snow 🏄 .....	79
<b>Sv</b> (Sensitivity Priority)	
Mode .....	88
<b>T</b>	
Text Size .....	210
Toning .....	144
Trailing curtain sync .....	140
Tungsten Light (White Balance) .....	150
TV .....	179
<b>Tv</b> (Shutter Priority) mode .....	90
<b>U</b>	
USB cable .....	195
USB Connection .....	194
Using aperture ring .....	230
<b>V</b>	
Video cable .....	179
Video Output Format .....	214
Viewfinder .....	27, 47
Vignetting .....	254
<b>W</b>	
White Balance .....	150
Wireless Mode (Flash) .....	136
World Time .....	206
<b>Z</b>	
Zoom Display .....	161
Zoom Lens .....	61

All PENTAX cameras purchased through authorized bona fide photographic distribution channels are guaranteed against defects of material or workmanship for a period of twelve months from date of purchase. Service will be rendered, and defective parts will be replaced without cost to you within that period, provided the equipment does not show evidence of impact, sand or liquid damage, mishandling, tampering, battery or chemical corrosion, operation contrary to operating instructions, or modification by an unauthorized repair shop. The manufacturer or its authorized representatives shall not be liable for any repair or alterations except those made with its written consent and shall not be liable for damages from delay or loss of use or from other indirect or consequential damages of any kind, whether caused by defective material or workmanship or otherwise; and it is expressly agreed that the liability of the manufacturer or its representatives under all guarantees or warranties, whether expressed or implied, is strictly limited to the replacement of parts as hereinbefore provided. No refunds will be made on repairs by non-authorized PENTAX service facilities.

#### Procedure During 12-month Warranty Period

Any PENTAX which proves defective during the 12-month warranty period should be returned to the dealer from whom you purchased the equipment or to the manufacturer. If there are no representatives of the manufacturer in your country, send the equipment to the manufacturer, with postage prepaid. In this case, it will take a considerable length of time before the equipment can be returned to you owing to the complicated customs procedures required. If the equipment is covered by warranty, repairs will be made and parts replaced free of charge, and the equipment will be returned to you upon completion of servicing. If the equipment is not covered by warranty, regular charges of the manufacturer or of its representatives will apply. Shipping charges are to be borne by the owner. If your PENTAX was purchased outside of the country where you wish to have it serviced during the warranty period, regular handling and servicing fees may be charged by the manufacturer's representatives in that country. Notwithstanding this, your PENTAX returned to the manufacturer will be serviced free of charge according to this procedure and warranty policy. In any case, however, shipping charges and customs clearance fees to be borne by the sender. To prove the date of your purchase when

required, please keep the receipt or bills covering the purchase of your equipment for at least a year. Before sending your equipment for servicing, please make sure that you are sending it to the manufacturer's authorized representatives or their approved repair shops, unless you are sending it directly to the manufacturer. Always obtain a quotation for the service charge, and only after you accept the quoted service charge, instruct the service station to proceed with the servicing.

- **This warranty policy does not affect the customer's statutory rights.**
- **The local warranty policies available from PENTAX distributors in some countries can supersede this warranty policy. Therefore, we recommend that you review the warranty card supplied with your product at the time of purchase, or contact the PENTAX distributor in your country for more information and to receive a copy of the warranty policy.**



The CE Mark is a Directive conformity mark of the European Union.

## For customers in USA

### STATEMENT OF FCC COMPLIANCE

This device complies with Part 15 of the FCC Rules. Operation is subject to the following two conditions: (1) This device may not cause harmful interference, and (2) this device must accept any interference received, including interference that may cause undesired operation.

Changes or modifications not approved by the party responsible for compliance could void the user's authority to operate the equipment.

This equipment has been tested and found to comply with the limits for a Class B digital device, pursuant to part 15 of the FCC Rules.

These limits are designed to provide reasonable protection against harmful interference in a residential installation. This equipment generates, uses and can radiate frequency energy and, if not installed and used in accordance with the instructions, may cause harmful interference to radio communications. However, there is no guarantee that interference will not occur in a particular installation.

If this equipment does cause harmful interference to radio or television reception, which can be determined by turning the equipment off and on, the user is encouraged to try to correct the interference by one or more of the following measures:

- Reorient or relocate the receiving antenna.
- Increase the separation between the equipment and receiver.
- Connect the equipment into an outlet on a circuit different from that to which the receiver is connected.
- \* Consult the dealer or an experienced radio/TV technician for help.

## For customers in Canada

This Class B digital apparatus complies with Canadian ICES-003.

### Pour les utilisateurs au Canada

Cet appareil numérique de la classe B est conforme à la norme NMB-003 du Canada.

### FOR CALIFORNIA, U.S.A. ONLY

Perchlorate Material-special handling may apply.

The lithium battery used in this camera contains perchlorate material, which may require special handling.

See [www.dtsc.ca.gov/hazardouswaste/perchlorate](http://www.dtsc.ca.gov/hazardouswaste/perchlorate)



**Declaration of Conformity**  
According to 47CFR, Parts 2 and 15 for  
**Class B Personal Computers and Peripherals**

We: PENTAX Imaging Company  
A Division of PENTAX of America, Inc.

Located at: 600 12<sup>th</sup> Street, Suite 300  
Golden, Colorado 80401 U.S.A.  
Phone: 303-799-8000 FAX: 303-790-1131

Declare under sole responsibility that the product identified herein complies with 47CFR Parts 2 and 15 of the FCC rules as a Class B digital device. Each product marketed is identical to the representative unit tested and found to be compliant with the standards. Records maintained continue to reflect the equipment being produced can be expected to be within the variation accepted, due to quantity production and testing on the statistical basis as required by 47CFR §2.909. Operation is subject to the following two conditions: (1) This device may not cause harmful interference, and (2) This device must accept any interference received, including interference that may cause undesired operation. The above named party is responsible for ensuring that the equipment complies with the standards of 47CFR §15.101 to §15.109.

Product Name: PENTAX Digital Still Camera

Model Number: ***K200D***

Contact person: Customer Service Manager

Date and Place: February, 2008, Colorado

## Information on disposal for users



### 1. In the European Union

If your product is marked with this symbol, it means that used electrical/electronic products should not be mixed with general household waste. There exists a separate collection system for these products.

Used electric/electronic equipment must be treated separately and in accordance with legislation that requires proper treatment, recovery and recycling of these products. Following the implementation by member states, private households within the EU states may return their used electrical/electronic equipment to designated collection facilities free of charge\*. In some countries your local retailer may also take back your old product free of charge if you purchase a similar new one.

\*Please contact your local authority for further details.

By disposing of this product correctly you will help ensure that the waste undergoes the necessary treatment, recovery and recycling and thus prevent potential negative effects on the environment and human health which could otherwise arise due to inappropriate waste handling.

### 2. In other countries outside the EU

If you wish to discard this product, please contact your local authorities and ask for the correct method of disposal.

For Switzerland: Used electrical/electronic equipment can be returned free of charge to the dealer, even when you don't purchase a new product. Further collection facilities are listed on the home page of [www.swico.ch](http://www.swico.ch) or [www.sens.ch](http://www.sens.ch).

# Memo

- PENTAX Corporation** 2-36-9, Maeno-cho, Itabashi-ku, Tokyo 174-8639, JAPAN  
(<http://www.pentax.co.jp/>)
- PENTAX Europe GmbH  
(European Headquarters)** Julius-Vosseler-Strasse 104, 22527 Hamburg,  
GERMANY  
(HQ - <http://www.pentaxeuropa.com>)  
(Germany - <http://www.pentax.de>)
- PENTAX U.K. Limited** PENTAX House, Heron Drive, Langley, Slough, Berks  
SL3 8PN, U.K.  
(<http://www.pentax.co.uk>)
- PENTAX France S.A.S.** 112 Quai de Bezons, B.P. 204  
95106 Argenteuil Cedex, FRANCE  
(<http://www.pentax.fr>)
- PENTAX Italia S.r.l.** Via Dione Cassio 15, 20138 Milano, ITALY  
(<http://www.pentaxitalia.it>)
- PENTAX (Schweiz) AG** Widenholzstrasse 1, 8304 Wallisellen, Postfach 367,  
8305 Dietlikon, SWITZERLAND  
(<http://www.pentax.ch>)
- PENTAX Scandinavia AB** P.O. Box 650, 75127 Uppsala, SWEDEN  
(<http://www.pentax.se>)
- PENTAX Imaging Company**  
**A Division of PENTAX of America, Inc.**  
(Headquarters)  
600 12th Street, Suite 300 Golden, Colorado 80401, U.S.A.  
(PENTAX Service Department)  
12000 Zuni Street, Suite 100B Westminster, Colorado  
80234, U.S.A.  
(<http://www.pentaximaging.com>)
- PENTAX Canada Inc.** 1770 Argentia Road Mississauga, Ontario L5N 3S7,  
CANADA  
(<http://www.pentax.ca>)
- PENTAX Trading  
(SHANGHAI) Limited** 23D, Jun Yao International Plaza, 789 Zhaojiabang Road,  
Xu Hui District, Shanghai, 200032 CHINA  
(<http://www.pentax.com.cn>)



<http://www.pentax.co.jp/english>

- Specifications and external dimensions are subject to change without notice.