

PENTAX®

smc PENTAX-DA INTERCHANGEABLE LENS OPERATING MANUAL

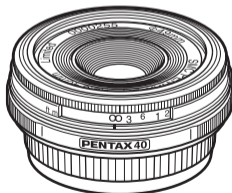
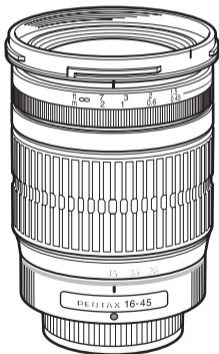

FOREWORD

Thank you for purchasing the smc PENTAX-DA lens.

This smc PENTAX-DA lens features a “Quick-Shift Focus System” that lets you finely adjust the focus manually after the focus has been adjusted in addition to allowing you to enjoy taking pictures using autofocus or manual focus by mounting on the PENTAX **istD* -series digital SLR camera. For further information on the use of this function, refer to p11.

smc PENTAX-DA lens can be used only with PENTAX **istD* -series SLR cameras. It is not compatible with film SLR cameras.

Please read this operating manual carefully before using the lens to ensure that it is used properly. In addition, also refer to your camera's operating manual.

- ※ In this operating manual, “smc PENTAX-DA lens” is shortened to “DA lens.”
- ※ Illustrations shown herein may differ from the actual appearance.

Although we have carefully designed these lenses for safe operation, please pay special attention to items marked with the following symbols when using this product.



WARNING

This symbol indicates precautions that if not followed, could result in serious injury to the user.



CAUTION

This symbol indicates precautions that if not followed, could result in minor or medium injury to the user or damage to the equipment.



WARNING

- **Never look at the sun through the lens or camera. Serious damage to the retina or total loss of eyesight may occur.**



CAUTION

- **Do not leave the lens in direct sunlight without lens caps. Direct sunlight passing through the lens will be intensified, and should it focus on flammable materials, fire may occur.**

1. Storage and mildew prevention
 - Take the lens out of the protective case or camera bag, and store it in a dry, well-ventilated place.
 - Avoid storing the lens in a poorly ventilated location such as a closet, wardrobe, drawer, vehicle, or where insect repellent or medicine is kept.
 - Avoid storing the lens in areas of high temperature and humidity, where there is a risk of mildew growth. Store the lens with a desiccant in a dry cabinet, airtight container, or plastic bag. (Leaving a saturated desiccant in the storage container can cause damage to the lens. Be sure to read the instructions that come with the desiccant before use.)
2. The lens is not waterproof. When using the lens in a rain or mist, be careful not to allow it to get wet.
3. Never use any organic solvent such as thinner, alcohol, or benzine, etc. to remove dust on the lens.
4. The lens is a precise optical instrument. Be careful not to let it fall, or subject it to strong shocks or pressure. Use a cushion or similar pad to protect the lens from the vibrations of motorcycles or other vehicles, boats, etc.
5. Avoid subjecting the lens to rapid changes in temperature, otherwise condensation can occur on both the inside and the outside of the lens. Put the lens in a plastic bag or camera bag, and take it out after the lens has reached ambient temperature.
6. When the lens is not attached to the camera body, attach both the supplied lens cap and lens mount cap to protect it from dust.
7. Do not leave the camera with the lens cap off attached to a tripod or other rigid camera support. The inner parts of the camera can be damaged by direct sunlight.
8. Have the lens inspected by a dealer every one or two years to maintain its high performance.

◦ FOREWORD	
◦ FOR SAFE USE OF YOUR LENS	1
◦ PRECAUTIONS AND LENS MAINTENANCE	2
◦ smc PENTAX-DA LENS	4
• About the DA Lens Mount	5
◦ MOUNTING AND REMOVING THE LENS	6
◦ LENS CAP	7
◦ FOCUSING	8
• Changing the Focus Mode	8
• Using Autofocus	8
• Focusing with the OK Button	9
• Using Manual Focus	10
• Using the Quick-Shift Focus System (<i>*istD</i> -series cameras only)	11
• How to use the Quick-Shift Focus System	11
• Precautions on close-distance scale	13
◦ ZOOM LENS	14
• About the zoom ring	15
◦ ATTACHING THE LENS HOOD	16
• Screw-on Type	16
• Bayonet Type	16
• About the PL filter window	17
◦ FILTERS	19
◦ PRECAUTIONS WHEN USING THE LENS WITH A FLASH	21
• Built-in Flash	21
• External Flash	21
• Compatibility of DA Lenses with the Built-in Flash	23
◦ MAIN SPECIFICATIONS	24

smc PENTAX-DA LENS

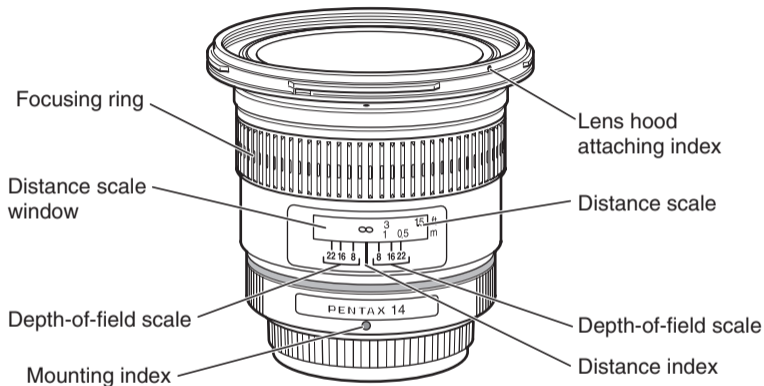
**Note:**

The DA lens does not have an aperture ring. Aperture settings are controlled automatically as if set to the auto "A" position, so accessories without an auto "A" setting cannot be used with this lens.

About the DA lens mount

The DA lens is an interchangeable lens specifically designed for the PENTAX **istD* - series digital SLR camera.

The K_{AF} -mount of the DA lens is similar to conventional SLR lenses, but the DA lens cannot be used on 35 mm SLR cameras.

K_{AF}-mount

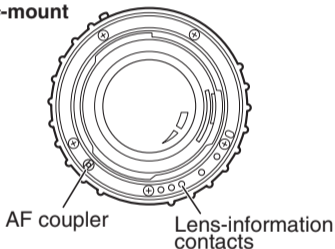

CAUTION

Be careful not to damage or dirty the lens-information contacts and AF coupler on the mount surfaces of the camera and lens. Otherwise, failure or malfunction may result.

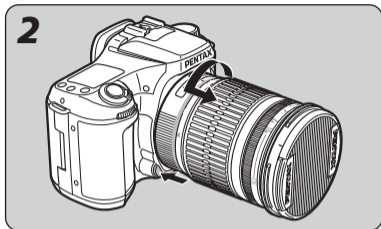
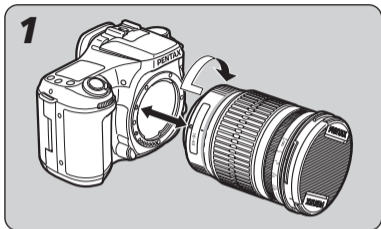

1. To mount the lens on the camera body

Attach the lens while aligning the red dots on the lens and body, then turn the lens clockwise until it clicks in place.

Memo:

- Do not hold down the lens unlock button while mounting the lens, otherwise the lens will not be properly mounted.
- After mounting the lens, gently turn the lens counterclockwise to make sure it is locked in place.

2. To remove the lens

Hold down the lens unlock button on the camera body and turn the lens counterclockwise.

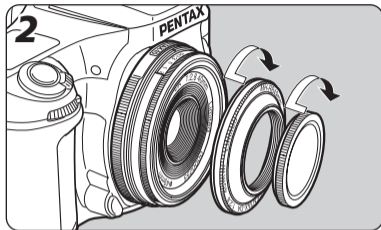
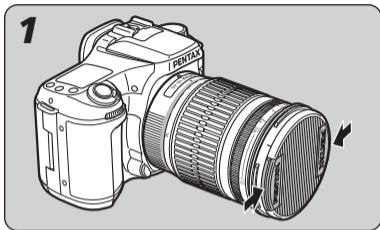

1. Take off the lens cap by pressing the two tabs inward as shown above.

2. Attaching the dedicated lens cap to DA 40mm f/2.8 Limited

First screw the dedicated hood onto the front of the lens, then screw on the lens cap.

 **Memo:**

- When not using the lens, be sure to attach the lens cap.
- The lens cap for the DA FISH-EYE 10-17 mm f/3.5-4.5ED (IF) is mounted by fitting it over the lens hood.

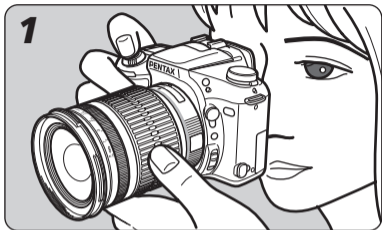

Changing the Focus Mode

Use the camera's focus mode switch to change between the autofocus mode and manual-focus mode. For details, refer to your camera's manual.

1. Using Autofocus

Set the camera's focus mode to autofocus. Press the shutter button halfway to autofocus.

With the **istD* camera, you can also press the AF button to autofocus.

Focusing with the OK Button

With the **istDS2*, **istDL* or **istDS* camera set as explained below, autofocus by pressing the shutter button halfway will be disabled and the OK button can be used instead to autofocus.

istDS2* / **istDL* / **istDS* : On the **C Custom menu, select “Enable AF” for “OK btn when shooting”.

Memo:

- For details on the setting procedure, refer to the camera's instruction manual.

CAUTION

During autofocus, the focusing ring of following lenses will rotate.

- **To prevent malfunction, do not touch the focusing ring during autofocus.**
 - DA FISH-EYE 10-17mm f/3.5-4.5ED (IF)
 - DA 12-24mm f/4ED AL (IF)
 - DA 16-45mm f/4ED AL
 - DA 18-55mm f/3.5-5.6 AL
 - DA 50-200mm f/4-5.6ED
 - DA 40mm f/2.8 Limited

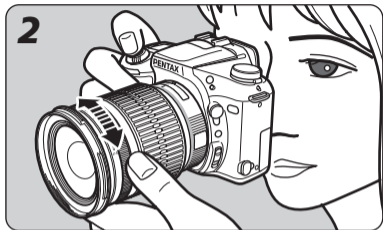

2. Using Manual Focus

Set to MF with the camera's focus mode, and turn the focusing ring to focus manually.

Using the Quick-Shift Focus System (**istD* -series cameras only)

If you use the lens with an **istD* -series camera and the focus mode is set to autofocus, you can focus manually after autofocus is achieved. Just turn the focusing ring to manually touch-up the focus. You can do this without changing the focus mode to MF.

How to use the Quick-Shift Focus System

1. Using Autofocus

Set the camera's focus mode switch to autofocus, then press the shutter button halfway to autofocus.

With the **istD* camera, you can also press the AF button to focus.

With the **istDS2*, **istDL* or **istDS* camera set as explained by "Focusing with the OK Button" on page 9, you can focus by pressing the OK button.

2. **Hold down the shutter button halfway (or hold down the AF button or OK button), then turn the focusing ring to focus.**
3. **Finally, press the shutter release button fully to take a picture.**

CAUTION

During autofocus, the focusing ring of following lenses will rotate.

- **To prevent malfunction, do not touch the focusing ring during autofocus.**
 - DA FISH-EYE 10-17mm f/3.5-4.5ED (IF)
 - DA 12-24mm f/4ED AL (IF)
 - DA 16-45mm f/4ED AL
 - DA 18-55mm f/3.5-5.6 AL
 - DA 50-200mm f/4-5.6ED
 - DA 40mm f/2.8 Limited
- When using the Quick-Shift Focus System, keep pressing the shutter button (or AF button) after you achieve focus and before taking a picture. If you let go of the shutter button before taking the picture, you will have to focus all over again when you press the shutter button again.

In the following cases, you can take the picture without autofocus after letting go of the shutter button.

- With the **istD*, set the “AF with Press Halfway” Custom Function to off. To autofocus, press the AF button.
- With the **istDS2*, **istDL* and the **istDS* camera, use the **C** Custom menu to set “Cancel AF” for “OK btn when shooting”. This will enable you to focus manually while you hold down the OK button.

The setting procedure and more details are explained in the camera’s instruction manual.

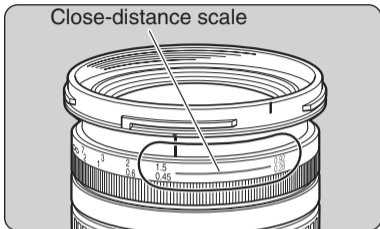

Precautions on close-distance scale

(For DA 16-45mm f/4ED AL, DA18-55mm f/3.5-5.6 AL)

In the close-distance scale range (the distance scale in the orange area), when shooting at the maximum aperture, image quality deterioration in the picture corners may result because of the optical characteristics of the lens.

When taking a picture in this range, we recommend that you use a smaller aperture, stopping down from wide open.

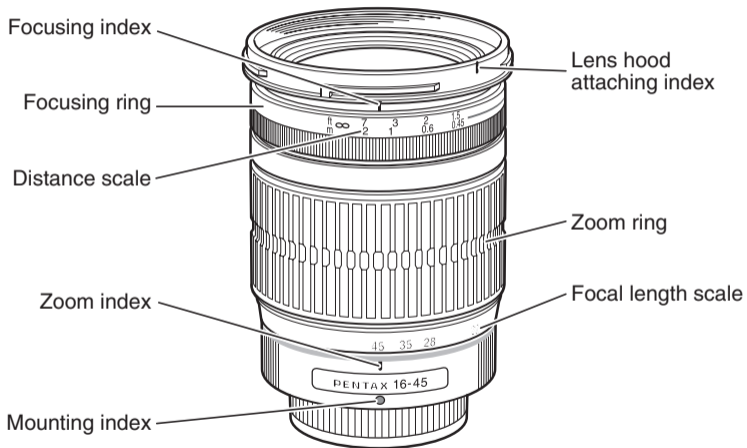

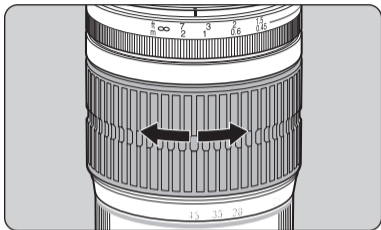

The zoom lens has a focusing ring at the front and a zoom ring behind it. Turn the zoom ring to set the desired angle of view (lens focal length).

 **Memo:**

- The focusing point may shift slightly by changing the focal length. First adjust the zoom and then adjust focus.

About the zoom ring

Turn the zoom ring clockwise for telephoto and counterclockwise for wide-angle.

In order to avoid the deterioration in image quality from internal reflection, use of the lens hood is recommended.

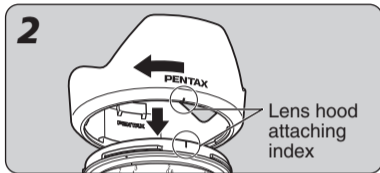
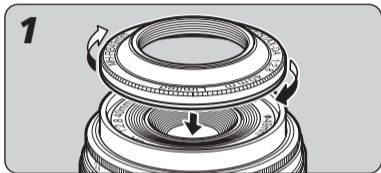

1. Screw-on Type

If the lens hood is dedicated to the DA 40mm f/2.8 Limited, screw it onto the front of the lens.

2. Bayonet Type

When attaching the lens hood, align the index on the lens hood with the attaching index on the lens, and push both parts straight toward each other. Attach the lens hood on the lens by turning the hood in the clockwise direction to lock it as viewed from the front of the lens until it clicks into position.

Memo:

- When attaching the lens hood, hold the focus ring and zoom ring securely to prevent them from turning.
- When the lens hood is not in use, it can also be turned around and attached in the reversed position.

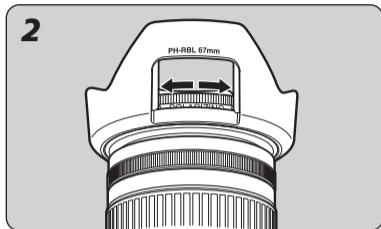
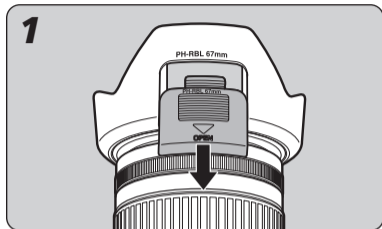

About the PL filter window

If a circular polarizing filter is attached to the DA lens, you can easily turn the filter via the PL filter window on the bayonet-type hood.

Lens hood with [PL filter window]

- DA 14mm f/2.8ED (IF)
- DA 16-45mm f/4ED AL
- DA 18-55mm f/3.5-5.6 AL
- DA 50-200mm f/4-5.6ED

How to use the lens hood with polarizing filter window

- 1.** Remove the PL filter window cap by sliding it in the direction as shown above.
- 2.** Turn the outer rim of the circular polarizing filter from the PL filter window as shown above.

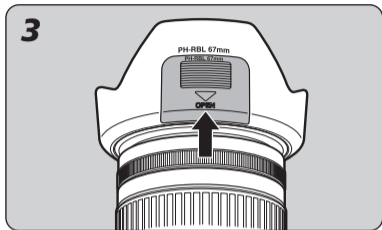

3. Attach the PL filter window cap.

Memo:

- When shooting, be sure the PL filter window cap is in place to make that the lens hood is being used to maximum effect.

Make sure the filter size matches the lens, then screw the filter onto the front of the lens.

 **Memo:**

- The compatible filter size for all the lenses are listed on pages 24-26.
- Filters cannot be mounted on the DA FISH-EYE 10-17 mm f/3.5-4.5ED (IF).

Precaution on filters

- Since the filter becomes a part of the optics when attached on the lens, handle it in the same way you handle the lens with care to dust, dirt and scratches. Normally, attaching two or more filters on a lens is not recommended. However, attaching a circular polarizing filter and another filter would not be a problem.
- Use a circular polarizing filter with Autofocus camera for proper exposure and autofocusing.

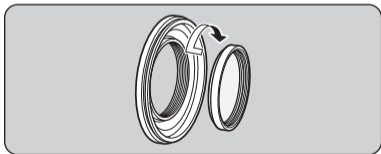

Attaching the 30.5mm filter to the DA 40mm f/2.8 Limited lens

Normally, you attach the 49mm filter to the front of the lens. But as shown in the diagram, you can also screw on a 30.5mm filter to the back of the dedicated hood.

Compatibility table for PENTAX filters

Lens	Circular polarizing filter (new type)		Circular polarizing filter (old type)	
	Compatibility	Notes	Compatibility	Notes
DA FISH-EYE 10-17mm f/3.5-4.5ED (IF) *3	NO		NO	
DA14mm f/2.8ED (IF)	YES		NO	Vignetting occurs.
DA40mm f/2.8 Limited*1	YES	Use a filter with a diameter of 49 mm.	YES	Use a filter with a diameter of 49 mm.
DA12-24mm f/4ED AL (IF)*2	*YES	*Vignetting occurs at focal lengths below 15 mm.	*YES	*Vignetting occurs at focal lengths below 15 mm.
DA16-45mm f/4ED AL*1	YES		*YES	*Can be mounted and used. However, when the old type of circular polarizing filter is mounted, the mount of the dedicated bayonet hood interferes with the filter's mount so it cannot be mounted on top of that.
DA18-55mm f/3.5-5.6 AL*1				
DA50-200mm f/4-5.6ED*1				

*1 The lens hood cannot be mounted on some circular polarizing filters that are not produced by PENTAX, depending on the type.

*2 Vignetting occurs at focal lengths below 15 mm with other PENTAX filters (such as the Skylight) besides circular polarizing filters.

*3 Filters cannot be mounted.

Built-in Flash

The built-in flash can not be used when the distance is less than 0.7m. When the flash is used within 0.7m, it causes incorrect exposure control and vignetting in the picture corners.

- Refer to the “Compatibility of DA Lenses with the Built-in Flash” chart on page 23 for information on the compatibility of the built-in flash with the lens being used. Furthermore, please note that when using the **istD* -series camera, a warning indication does not appear even when taking a picture with a built-in flash that is incompatible with the lens being used.
- If the built-in flash is used with the lens hood attached to the lens, the flash light will be blocked by the lens hood. Always make sure to remove the lens hood before using the built-in flash.

External Flash

The external flash can be used while the lens hood is attached. However, the following conditions apply for some types of lens.

● DA 14mm f/2.8ED (IF)

The AF540FGZ and AF360FGZ external flash units can only be used when the wide-angle panel is used (it is also possible to use the lens hood). Other external flash units are not recommended because their coverage angle is not compatible with the angle of view of the lens.

● DA FISH-EYE 10-17 mm f/3.5-4.5ED (IF)

External flash units cannot be used because their coverage angle is not compatible.

● DA 12-24 mm f/4ED AL (IF)

Pentax external flash units which support TTL auto flash and that cover a 24mm lens on a 35mm SLR or 16mm lens on a digital SLR can be used from 16mm to 24mm.

AF540FGZ and AF360FGZ can be used from 13mm to 24mm with the wide angle panel (In both cases, it is possible to use the lens hood).

Please note that at focal lengths less than 13mm the corners of the picture will not be fully illuminated.

Other external flash units are not recommended because their coverage angle is not wide enough to cover the angle of view of the lens.

● DA 16-45 mm f/4ED AL

PENTAX external flash units which support TTL auto flash and that cover a 24mm lens on a 35mm SLR or 16mm lens on a digital SLR can be used (it is also possible to use the lens hood).

*For more information, refer to the manual for the external flash unit. Please check your camera instruction manual for information on which flashes can be used with your PENTAX Digital SLR.

Compatibility of DA Lenses with the Built-in Flash

Lens	Compatibility	Notes
DA 14mm f/2.8ED (IF)	No	
DA 40mm f/2.8 Limited	YES	
DA FISH-EYE 10-17mm f/3.5-4.5ED (IF)	No	
DA 12-24mm f/4ED AL (IF)	No	
DA 16-45mm f/4ED AL	*YES	*Vignetting may occur at a focal length less than 28mm, and also may occur at a focal length 28mm when object distance is less than 1m.
DA 18-55mm f/3.5-5.6 AL	YES	
DA 50-200mm f/4-5.6ED	YES	

Except for the DA 40mm f/2.8 Limited, do not use the lens hood when using the built-in flash. This is to prevent obstruction of the flash coverage by the lens hood.

MAIN SPECIFICATIONS

Lens	DA 14mm f/2.8ED (IF)	DA 40mm f/2.8 Limited	DA FISH-EYE 10-17mm f/3.5-4.5ED (IF)
Focal length	14 mm (equivalent to 21.5mm in 35mm format)	40 mm (equivalent to 61mm in 35mm format)	10-17 mm (35mm conversion not possible)
Usable camera	<i>*istD</i> -series	<i>*istD</i> -series	<i>*istD</i> -series
Elements in groups	12-11	5-4	10-8
Angle of view	90°	39°	180°-100°
Aperture	f/2.8	f/2.8	f/3.5-f/4.5
Minimum aperture	f/22	f/22	f/22-f/32
Mount type	K _{AF} -mount	K _{AF} -mount	K _{AF} -mount
Minimum focus distance	0.17m (0.56ft)	0.4m (1.31ft)	0.14m (0.46ft) (Approximately 2.5 cm from front of lens)
Maximum magnification	Approx. 0.19×	Approx. 0.13×	Approx. 0.39×
Filter size	77mm	49mm or 30.5mm	Cannot be mounted
Lens hood	PH-RBH 77mm	MH-RC 49mm	Built-in
Max. Diameter × Length	83.5mm × 69mm (3.3in × 2.7in)	63mm × 15mm (2.5in × 0.6in)	68mm × 71.5mm (2.7in × 2.8in)
Weight	420g/14.8oz (with hood 455g/16oz)	90 g/3.15oz (with hood 100 g/3.5oz)	320 g/11.3oz
Soft case	S100-120	Dedicated case	S80-80

Lens	DA 12-24mm f/4ED AL (IF)	DA 16-45mm f/4ED AL	DA18-55mm f/3.5-5.6 AL
Focal length	12-24 mm (equivalent to 18.5-37mm in 35mm format)	16-45 mm (equivalent to 24.5-69mm in 35mm format)	18-55 mm (equivalent to 27.5-84mm in 35mm format)
Usable camera	<i>*istD</i> -series	<i>*istD</i> -series	<i>*istD</i> -series
Elements in groups	13-11	13-10	12-9
Angle of view	99°-61°	83°-35°	76°-29°
Aperture	f/4	f/4	f/3.5-f/5.6
Minimum aperture	f/22	f/22	f/22-f/38
Mount type	K _{AF} -mount	K _{AF} -mount	K _{AF} -mount
Minimum focus distance	0.3m (0.98ft)	0.28m (0.92ft)	0.25m (0.82ft)
Maximum magnification	Approx. 0.12×	Approx. 0.26×	Approx. 0.34×
Filter size	77mm	67mm	52mm
Lens hood	PH-RBI 77mm	PH-RBL 67mm	PH-RBA 52mm
Max. Diameter × Length	84mm × 87.5mm (3.3in × 3.4in)	72mm × 92mm (2.8in × 3.6in)	68mm × 67.5mm (2.7in × 2.6in)
Weight	430 g/15.2oz (with hood 457 g/16.1oz)	365g/12.9oz (with hood 390g/13.8oz)	225 g/7.9oz (with hood 250 g/8.8oz)
Soft case	S100-120	S90-140	S80-120

Lens	DA 50-200mm f/4-5.6ED
Focal length	50-200 mm (equivalent to 76.5-306mm in 35mm format)
Usable camera	<i>*istD</i> -series
Elements in groups	11-10
Angle of view	31.5°-8.1°
Aperture	f/4-f/5.6
Minimum aperture	f/22-f/32
Mount type	K _{AF} -mount
Minimum focus distance	1.1m (3.6ft)
Maximum magnification	Approx. 0.24×
Filter size	52mm
Lens hood	PH-RBB 52mm
Max. Diameter × Length	66.5mm × 78.5mm (2.6in × 3.1in)
Weight	255 g /9oz (with hood 285 g /10oz)
Soft case	S80-120

For customers in USA

STATEMENT OF FCC COMPLIANCE

This device complies with Part 15 of the FCC Rules. Operation is subject to the following two conditions : (1) This device may not cause harmful interference, and (2) this device must accept any interference received, including interference that may cause undesired operation.

Changes or modifications not approved by the party responsible for compliance could void the user's authority to operate the equipment.

This equipment has been tested and found to comply with the limits for a Class B digital device, pursuant to part 15 of the FCC Rules. These limits are designed to provide reasonable protection against harmful interference in a residential installation. This equipment generates, uses and can radiate radio frequency energy and, if not installed and used in accordance with the instructions, may cause harmful interference to radio communications. However, there is no guarantee that interference will not occur in a particular installation. If this equipment does cause harmful interference to radio or television reception, which can be determined by turning the equipment off and on, the user is encouraged to try to correct the interference by one or more of the following measures :

- Reorient or relocate the receiving antenna.

Increase the separation between the equipment and receiver.

Connect the equipment into an outlet on a circuit different from that to which the receiver is connected.

*Consult the dealer or an experienced radio/TV technician for help.

For customers in Canada

This Class B digital apparatus meets all requirements of the Canadian Interference-Causing Equipment Regulations.

Cet appareil numérique de la classe B respecte toutes les exigences du Règlement sur le matériel brouilleur du Canada.

memo

memo

- PENTAX Corporation** 2-36-9, Maeno-cho, Itabashi-ku, Tokyo 174-8639, JAPAN (<https://www.pentax.co.jp/>)
- PENTAX Europe GmbH** Julius-Vosseler-Strasse, 104, 22527 Hamburg, GERMANY
(European Headquarters) (HQ - <http://www.pentaxeuropa.com>) (Germany - <http://www.pentax.de>)
- PENTAX U.K. Limited** PENTAX House, Heron Drive, Langley, Slough, Berks SL3 8PN, U.K. (<http://www.pentax.co.uk>)
- PENTAX France S.A.S.** 12/14, rue Jean Poulmarch, 95106 Argenteuil Cedex, FRANCE (<http://www.pentax.fr>)
PENTAX Benelux B.V. (for Netherlands) Spinveld 25, 4815 HR Breda, NETHERLANDS (<http://www.pentax.nl>)
(for Belgium & Luxembourg) Weiveldlaan 3-5, 1930 Zaventem, BELGIUM (<http://www.pentax.be>)
- PENTAX (Schweiz) AG** Widenholzstrasse 1 Postfach 367 8305 Dietlikon, SWITZERLAND (<http://www.pentax.ch>)
- PENTAX Scandinavia AB** P.O. Box 650, 75127 Uppsala, SWEDEN (<http://www.pentax.se>)
- PENTAX Imaging Company**
A Division of PENTAX of America, Inc.
(Headquarters)
600 12th Street, Suite 300 Golden, Colorado 80401, U.S.A.
(PENTAX Service Department)
12000 Zuni Street, Suite 100B Westminster, Colorado 80234, U.S.A.
(<http://www.pentaximaging.com>)
- PENTAX Canada Inc.** 1770 Argentia Road Mississauga, Ontario L5N 3S7, CANADA (<http://www.pentax.ca>)



for your
precious moments



The CE Mark is a Directive conformity mark of the European Union.

Specifications and external dimensions are subject to change without notice.

Copyright © PENTAX Corporation 2005